



This is a digital copy of a book that was preserved for generations on library shelves before it was carefully scanned by Google as part of a project to make the world's books discoverable online.

It has survived long enough for the copyright to expire and the book to enter the public domain. A public domain book is one that was never subject to copyright or whose legal copyright term has expired. Whether a book is in the public domain may vary country to country. Public domain books are our gateways to the past, representing a wealth of history, culture and knowledge that's often difficult to discover.

Marks, notations and other marginalia present in the original volume will appear in this file - a reminder of this book's long journey from the publisher to a library and finally to you.

Usage guidelines

Google is proud to partner with libraries to digitize public domain materials and make them widely accessible. Public domain books belong to the public and we are merely their custodians. Nevertheless, this work is expensive, so in order to keep providing this resource, we have taken steps to prevent abuse by commercial parties, including placing technical restrictions on automated querying.

We also ask that you:

- + *Make non-commercial use of the files* We designed Google Book Search for use by individuals, and we request that you use these files for personal, non-commercial purposes.
- + *Refrain from automated querying* Do not send automated queries of any sort to Google's system: If you are conducting research on machine translation, optical character recognition or other areas where access to a large amount of text is helpful, please contact us. We encourage the use of public domain materials for these purposes and may be able to help.
- + *Maintain attribution* The Google "watermark" you see on each file is essential for informing people about this project and helping them find additional materials through Google Book Search. Please do not remove it.
- + *Keep it legal* Whatever your use, remember that you are responsible for ensuring that what you are doing is legal. Do not assume that just because we believe a book is in the public domain for users in the United States, that the work is also in the public domain for users in other countries. Whether a book is still in copyright varies from country to country, and we can't offer guidance on whether any specific use of any specific book is allowed. Please do not assume that a book's appearance in Google Book Search means it can be used in any manner anywhere in the world. Copyright infringement liability can be quite severe.

About Google Book Search

Google's mission is to organize the world's information and to make it universally accessible and useful. Google Book Search helps readers discover the world's books while helping authors and publishers reach new audiences. You can search through the full text of this book on the web at <http://books.google.com/>

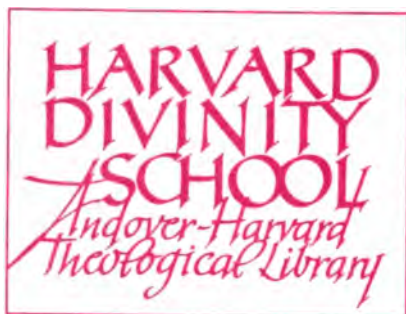



THE ENCYCLOPÆDIA BRITANNICA

ELEVENTH EDITION

FIRST	edition, published in three	volumes,	1768—1771.
SECOND	“ “ ten	“	1777—1784.
THIRD	“ “ eighteen	“	1788—1797.
FOURTH	“ “ twenty	“	1801—1810.
FIFTH	“ “ twenty	“	1815—1817.
SIXTH	“ “ twenty	“	1823—1824.
SEVENTH	“ “ twenty-one	“	1830—1842.
EIGHTH	“ “ twenty-two	“	1853—1860.
NINTH	“ “ twenty-five	“	1875—1889.
TENTH	“ ninth edition and eleven supplementary volumes,		1902—1903.
ELEVENTH	“ published in twenty-nine volumes,		1910—1911.



**THE
ENCYCLOPÆDIA BRITANNICA**

**A
DICTIONARY
OF
ARTS, SCIENCES, LITERATURE AND GENERAL
INFORMATION**

ELEVENTH EDITION

**VOLUME VIII
DEMIJOHN to EDWARD**

**NEW YORK
THE ENCYCLOPÆDIA BRITANNICA COMPANY
1910**

Ref
AE
5
.E36
1910a
v. 8

Copyright, in the United States of America, 1910,
by
The Encyclopedia Britannica Company.

**INITIALS USED IN VOLUME VIII. TO IDENTIFY INDIVIDUAL
CONTRIBUTORS,¹ WITH THE HEADINGS OF THE
ARTICLES IN THIS VOLUME SO SIGNED.**

A. C.	ARTHUR CAYLEY, LL.D., F.R.S. See the biographical article: CAYLEY, ARTHUR.	{ Determinant.
A. E. G.*	REV. ALFRED ERNEST GARVIE, M.A., D.D. Principal of New College, Hampstead. Member of the Board of Theology and Board of Philosophy, London University. Formerly Professor of Philosophy, Theism, Comparative Religion, and Christian Ethics in Hackney and New Colleges, London. Author of <i>Studies in the Inner Life of Jesus</i> ; <i>The Christian Certainty</i> ; &c.	{ Devil.
A. E. S.	ARTHUR EVERETT SHIPLEY, M.A., D.Sc., F.R.S., F.Z.S., F.L.S. Fellow, Tutor and Lecturer of Christ's College, Cambridge. University Reader in Zoology. President of the Association of Economic Biologists. Formerly University Lecturer on the Advanced Morphology of the Invertebrata. Author of <i>Zoology of the Invertebrata</i> . Editor of the Pitt Press <i>Natural Science Manuals</i> ; &c.	{ Desmoscolecida; Echituroidea.
A. FL.	PIERRE MARIE AUGUSTE FILON. See the biographical article: FILON, P. M. A.	{ Drama: French (in part).
A. F. P.	ALBERT FREDERICK POLLARD, M.A., F.R.HIST.SOC. Fellow of All Souls' College, Oxford. Professor of English History in the University of London. Assistant Editor of the <i>Dictionary of National Biography</i> , 1893-1901. Author of <i>England under the Protector Somerset</i> ; <i>Life of Thomas Cranmer</i> ; &c.	{ Edward VI.
A. G.	MAJOR ARTHUR GEORGE FREDERICK GRIFFITHS (d. 1908). H.M. Inspector of Prisons, 1878-1896. Author of <i>The Chronicles of Newgate</i> ; <i>Secrets of the Prison House</i> ; &c.	{ Deportation.
A. G. D.	ARTHUR GEORGE DOUGHTY, C.M.G., M.A., LITT.D., F.R.HIST.S. Dominion Archivist of Canada. Member of the Geographical Board of Canada. Author of <i>The Cradle of New France</i> ; &c.—Joint Editor of <i>Documents relating to the Constitutional History of Canada</i> .	{ Dorton.
A. H. J. G.	ABEL HENRY JONES GREENIDGE, M.A., D.LITT. (d. 1905). Formerly Fellow and Lecturer of Hertford College, Oxford, and of St John's College, Oxford. Author of <i>Infamia in Roman Law</i> ; <i>Handbook of Greek Constitutional History</i> ; <i>Roman Public Life</i> ; <i>History of Rome</i> . Joint Editor of <i>Sources of Roman History, 133-70 B.C.</i>	{ Dictator.
A. H. S.	REV. ARCHIBALD HENRY SAYCE, D.LITT., LL.D., D.D. See the biographical article: SAYCE, A. H.	{ Ebatana.
A. J. L.	ANDREW JACKSON LAMOURÉUX. Librarian, College of Agriculture, Cornell University. Formerly Editor of the <i>Rio News</i> , Rio de Janeiro.	{ Ecuador (in part).
A. J. P.	ALEXANDER J. PHILIP. Borough Librarian of Gravesend.	{ Dene-holes.
A. L. G.	ANDREW LOCKHART GILLESPIE, M.D., F.R.S. (Edin.) (d. 1904). Formerly Lecturer on Modern Gastric Methods, Edinburgh Post-Graduate School. Author of <i>Manual of Modern Gastric Methods</i> ; &c.	{ Digestive Organs: Pathology (in part).
A. M. W.	ALLEN MAWER, M.A. Professor of English Language and Literature, Armstrong College, Newcastle-on-Tyne. Fellow of Gonville and Caius College, Cambridge. Formerly Lecturer in English at the University of Sheffield.	{ Denmark: Ancient History; Edgar, King; Edmund, King of East Angles; Edmund I.; Eired; Edward (the Elder); Edward (the Martyr).
A. M. C.	AGNES MARY CLERKE. See the biographical article: CLERKE, A. M.	{ Dick, Thomas; Donati.
A. N.	ALFRED NEWTON, F.R.S. See the biographical article: NEWTON, ALFRED.	{ Diver; Dodo (in part); Dove; Duck; Eagle.

¹A complete list, showing all individual contributors, appears in the final volume.

A. R. G.	ALEXANDER ROSS CLARKE, C.B., F.R.S. Colonel, R.E. Royal Medal of Royal Society, 1887. In charge of Trigonometrical Operations of the Ordnance Survey, 1854-1881.	Earth, Figure of the (<i>in part</i>)
A. S. Wo.	ARTHUR SMITH WOODWARD, LL.D., F.R.S. Keeper of Geology, Natural History Museum, South Kensington. Secretary of the Geological Society, London.	Diplodocus.
A. Wa.	ARTHUR WAUGH, M.A. New College, Oxford. Newdigate Prize, 1888. Managing Director of Chapman & Hall, Ltd. Author of <i>Gordon in Africa</i> ; <i>Alfred, Lord Tennyson</i> . Editor of <i>Johnson's Lives of the Poets</i> ; editions of <i>Dickens</i> , <i>Tennyson</i> , <i>Arnold</i> , <i>Lamb</i> ; &c.	De Tabley.
A. W. H.*	ARTHUR WILLIAM HOLLAND. Formerly Scholar of St John's College, Oxford. Bacon Scholar of Gray's Inn, 1900.	Dorby, Earls of (<i>in part</i>).
A. W. E.	ALEXANDER WOOD RENTON, M.A., LL.B. Puisne Judge of the Supreme Court of Ceylon. Editor of <i>Encyclopædia of the Laws of England</i> .	Easement.
A. W. W.	ADOLPHUS WILLIAM WARD, LL.D., D.LITT. See the biographical article: WARD, A. W.	Drama.
C. A. G.	CHRISTIAN CARL AUGUST GOSCH, M.Sc. Commander of the Danebrog. Knight of St Anna. Formerly Attaché to the Danish Legation, London. Author of <i>Denmark and Germany since 1815</i> .	Denmark: Geography and Statistics (<i>in part</i>)
C. Ch.	CHARLES CHREE, M.A., LL.D., D.Sc., F.R.S. Superintendent, Kew Observatory. Formerly Fellow of King's College, Cambridge. President of Physical Society of London. Watt Medallist, Institute of Civil Engineers, 1905.	Earth Currents.
C. C. H.	CHARLES CAESAR HAWKINS, M.A., M.I.E.E. Author of <i>The Dynamo</i> .	Dynamo.
C. E.*	CHARLES EVERITT, M.A., F.C.S., F.G.S., F.R.A.S. Sometime Scholar of Magdalen College, Oxford.	Density; Distillation.
C. F. A.	CHARLES FRANCIS ATKINSON. Formerly Scholar of Queen's College, Oxford. Captain, 1st City of London (Royal Fusiliers). Author of <i>The Wilderness and Cold Harbour</i> .	Dutch Wars: Military.
C. H. Ed.	CHARLES HERCULES READ, LL.D. Keeper of British and Medieval Antiquities, British Museum. President of the Society of Antiquaries of London. Author of <i>Antiquities from Benin</i> ; &c.	Drinking Vessels.
C. H. T.*	CRAWFORD HOWELL TOY, A.M., LL.D. See the biographical article: TOY, CRAWFORD HOWELL.	Ecclesiastes.
C. L. K.	CHARLES LETHBRIDGE KINGSFORD, M.A., F.R.HIST.S., F.S.A. Assistant Secretary, Board of Education. Author of <i>Life of Henry V</i> . Editor of <i>Chronicles of London and Stow's Survey of London</i> .	Derby, 1st Earl of; Edward IV.
C. Pl.	CHRISTIAN PFISTER, D. ès L. Professor at the Sorbonne, Paris. Chevalier of the Legion of Honour. Author of <i>Étude sur le règne de Robert le Pieux; Le duché mérovingien d'Alsace et la légende de Sainte-Odile</i> .	Ebrota.
C. R. B.	CHARLES RAYMOND BEAZLEY, M.A., D.LITT., F.R.G.S., F.R.HIST.S. Professor of Modern History in the University of Birmingham. Formerly Fellow of Merton College, Oxford, and University Lecturer in the History of Geography, Lothian Prizeman, Oxford, 1889. Lowell Lecturer, Boston, 1908. Author of <i>Henry the Navigator; The Dawn of Modern Geography</i> ; &c.	Dias de Novas; Diouil.
C. S. P.*	REV. CHARLES STANLEY PHILLIPS. King's College, Cambridge. Gladstone Memorial Prize, 1904.	Edmund Ironside; Edward the Confessor.
C. W. W.	SIR CHARLES WILLIAM WILSON, K.C.B., K.C.M.G., F.R.S. (1836-1907). Major-General, Royal Engineers. Secretary to the North American Boundary Commission, 1858-1862. British Commissioner on the Servian Boundary Commission. Director-General of the Ordnance Survey, 1836-1894. Director-General of Military Education, 1895-1898. Author of <i>From Kortis to Khartoum; Life of Lord Clive</i> ; &c.	Diarbekr (<i>in part</i>).
D. B. Ma.	DUNCAN BLACK MACDONALD, M.A., D.D. Professor of Semitic Languages, Hartford Theological Seminary, U.S.A. Author of <i>Development of Muslim Theology, Jurisprudence and Constitutional Theory; Selection from Ibn Khaldun; Religious Attitude and Life in Islam</i> ; &c.	Darvish; Divan.
D. C. T.	DAVID CROAL THOMSON. Formerly Editor of the <i>Art Journal</i> . Author of <i>The Brothers Maris; The Barbizon School of Painters; Life of "Phis"; Life of Bewick</i> ; &c.	Dias, H. V.
D. G. E.	DAVID GEORGE HOGARTH, M.A. Keeper of the Ashmolean Museum, Oxford. Fellow of Magdalen College, Oxford. Fellow of the British Academy. Excavated at Paphos, 1888; Naukratis, 1899 and 1903; Ephesus, 1904-1905; Assiut, 1906-1907. Director, British School at Athens, 1897-1900. Director, Cretan Exploration Fund, 1899.	Derna; Didymi; Druses (<i>in part</i>).
D. H.	DAVID HANNAY. Formerly British Vice-Consul at Barcelona. Author of <i>Short History of Royal Navy, 1217-1688; Life of Emilio Castelar</i> ; &c.	Dudley, Sir Robert; Dutch Wars: Naval.
D. Ma.	REV. DUGALD MACFADYEN, M.A. Minister of South Grove Congregational Church, Highgate. Director of the London Missionary Society.	Duff, Alexander.

E. A. T.	MRS (ETHEL) ALEC TWEEDIE. Author of <i>Porfirio Dias; Mexico as I saw it; &c.</i>	{ Diaz, Porfirio.
E. B.	ERNEST BARKER, M.A. Fellow of, and Lecturer in Modern History at, St John's College, Oxford. Formerly Fellow and Tutor of Merton College. Craven Scholar, 1895.	{ Diet.
E. C. B.	RIGHT REV. EDWARD CUTHBERT BUTLER, O.S.B., D.LITT. (Dublin). Abbot of Downside Abbey, Bath.	{ Dominic, Saint; Dominicans.
E. C. B.*	EDWARD CRESSWELL BABER, M.A. (d. 1910). Formerly Senior Surgeon, Brighton and Sussex Throat and Ear Hospital. Prisoner and William Brown Scholar, St George's Hospital, London. Author of numerous papers on Diseases of the Ear, Nose and Throat.	{ Ear: Diseases.
E. C. E.	EDWARD CAMERON KIRK, D.Sc. Dean of the Dental Faculty and Professor of Dental Pathology, Therapeutics and Materia Medica, University of Pennsylvania. Editor of <i>The American Text-Book of Operative Dentistry</i> .	{ Dentistry.
E. C. Q.	EDMUND CROSBY QUIGGIN, M.A. Fellow of Gonville and Caius College, Cambridge; Lecturer in Modern Languages and Moore Lecturer in Celtic.	{ Druidism.
E. E.	EDMOND ESMONIN.	{ Desmarets.
E. E. A.	ERNEST E. AUSTEN. Assistant in Department of Zoology, Natural History Museum, South Kensington.	{ Diptera.
E. G.	EDMUND GOSSE, LL.D. See the biographical article: GOSSE, EDMUND.	{ Denmark: Literature; Descriptive Poetry; Dialogue; Diary; Didactic Poetry; Dithyramble Poetry; Donne; Drachmann; Drayton, Michael; Dutch Literature; Edda.
E. G.	ERNEST A. GARDNER, M.A. See the biographical article: GARDNER, PERCY.	{ Dodona.
E. I. C.	EDWARD IRVING CARLYLE, M.A., F.R.HIST.S. Fellow, Lecturer in Modern History, and Tutor of Lincoln College, Oxford. Formerly Fellow of Merton College. Assistant Editor of the <i>Dictionary of National Biography</i> , 1895-1901.	{ Dost Mahommed Khan.
E. J. D.	EDWARD JOSEPH DENT, M.A., MUS.BAC. Formerly Fellow of King's College, Cambridge. Author of <i>A. Scarlatti: his Life and Works</i> .	{ Durante, Francesco.
E. K.	EDMUND KNECHT, PH.D., M.Sc.TECH. (Manchester), F.I.C. Professor of Technological Chemistry, Manchester University. Head of Chemical Department, Municipal School of Technology, Manchester. Examiner in Dyeing, City and Guilds of London Institute. Author of <i>A Manual of Dyeing; &c.</i> Editor of <i>Journal of the Society of Dyers and Colourists</i> .	{ Dyeing.
E. M.	EDUARD MEYER, D.LITT. (Oxon.), LL.D., PH.D. Professor of Ancient History in the University of Berlin. Author of <i>Geschichte der Alterthums; Forschungen zur alten Geschichte; Geschichte des alten Aegyptens; Die Israeliten und ihre Nachbarstämme; &c.</i>	{ Diodotus.
E. M.	EDWARD MANSON. Barrister-at-Law. Joint Editor of <i>Journal of Comparative Legislation; Author of Law of Trading Companies; Practical Guide to Company Law; &c.</i>	{ Directors.
E. M. T.	SIR EDWARD MAUNDE THOMPSON, G.C.B., I.S.O., D.C.L., LITT.D., LL.D. Director and Principal Librarian, British Museum, 1898-1909. Sanders Reader in Bibliography, Cambridge, 1895-1896. Hon. Fellow of University College, Oxford. Correspondent of the Institute of France and of the Royal Prussian Academy of Sciences. Author of <i>Handbook of Greek and Latin Palaeography</i> . Editor of <i>Chronicon Anglorum</i> . Joint Editor of publications of the Palaeographical Society, the New Palaeographical Society, and of the Facsimile of the Laurentian Sophocles.	{ Diplomatic.
E. O'H.	REV. EUGENE HENRY O'MEARA, M.A. Vicar of Tallaght, County Dublin.	{ Diatomaceae (in part).
E. P.	EDGAR PRESTAGE. Special Lecturer in Portuguese Literature in the University of Manchester. Commandador, Portuguese Order of S. Thiago. Corresponding Member of Lisbon Royal Academy of Sciences, Lisbon Geographical Society, &c.	{ Eça de Queiroz.
F. A. B.	FRANCIS ARTHUR BATHER, M.A., D.Sc., F.R.S., F.R.G.S. Assistant Keeper of Geology, British Museum. Rolleston Prizeman, Oxford, 1892. Author of "Echinoderma" in <i>A Treatise on Zoology; Triassic Echinoderms of Bakhony; &c.</i>	{ Echinoderma.
F. E. B.	FRANK EVERS BEDDARD, M.A., F.R.S. Professor of the Zoological Society, London. Formerly Lecturer in Biology at Guy's Hospital. Naturalist to "Challenger" Expedition Commission, 1882-1884. Author of <i>Text-Book of Zoogeography; Animal Colouration; &c.</i>	{ Earth-worm.
F. G. M. B.	FREDERICK GEORGE MEESON BECK, M.A. Fellow and Lecturer in Classics, Clare College, Cambridge.	{ East Anglia.

- F. G. P.** **FREDERICK GYMER PARSONS, F.R.C.S., F.Z.S., F.R.ANTHROP.INST.**
Vice-President, Anatomical Society of Great Britain and Ireland. Lecturer on Anatomy at St Thomas's Hospital and the London School of Medicine for Women. Formerly Examiner in the Universities of Cambridge, Aberdeen, London and Birmingham; and Hunterian Professor at the Royal College of Surgeons. { Diaphragm;
Ductless Glands
Ear.
- F. G. P.*** **FRANK GEORGE POPE.**
Lecturer on Chemistry, East London College (University of London). { Diazo Compounds.
- F. J. H.** **FRANCIS JOHN HAVERFIELD, M.A., LL.D., F.S.A.**
Camden Professor of Ancient History in the University of Oxford. Fellow of Brasenose College. Fellow of the British Academy. Author of Monographs on Roman History, especially Roman Britain, &c. { Eburroum.
- F. LL. G.** **FRANCIS LLEWELYN GRIFFITH, M.A., PH.D., F.S.A.**
Reader in Egyptology, Oxford University. Formerly Scholar of Queen's College, Oxford. Editor of the *Archaeological Survey* and *Archaeological Reports* of the Egypt Exploration Fund. Fellow of Imperial German Archaeological Institute. { Denders;
Edfu.
- F. R. H.** **FREDERICK ROBERT HELMERT, PH.D., D.ING.**
Professor of Geodesy, University of Berlin. { Earth, Figure of the (*in part*)
- F. R. H.** **FRANCIS RICHARD MAUNSELL, C.M.G.**
Lieutenant-Colonel. Military Vice-Consul, Sivas, Trebizond, Van (Kurdistan), 1897-1898. Military Attaché, British Embassy, Constantinople, 1901-1905. Author of *Central Kurdistan*; &c. { Diarbekr (*in part*).
- F. S.** **FRANCIS STORR, M.A.**
Editor of the *Journal of Education*, London. Officier d'Académie, Paris. { Duel.
- F. T. H.** **SIR FRANK THOMAS MARZIALS, K.C.B.**
Formerly Accountant General of the Army. Editor of the "Great Writers" Series. { Dumas; *fits*.
- F. V. T.** **FREDERICK VINCENT THEOBALD, M.A.**
Vice-Principal and Zoologist, S.E. Agricultural College, Wye, Kent (University of London). Grand Medallist of the Société Nationale d'Acclimatation de France. Author of *The Insect and other Allied Pests of Orchard, Bush and Hot-house Fruits*; &c. { Economic Entomology.
- F. W. R.*** **FREDERICK WILLIAM RUDLER, I.S.O., F.G.S.**
Curator and Librarian of the Museum of Practical Geology, London, 1879-1902. President of the Geologists' Association, 1887-1889. { Earthquake (*in part*).
- F. W. W.** **FREDERIC W. WYTHE.**
Author of *Actors of the Century*; &c. Translator of Filon's *English Stage*; Schilling's *With Flashlight and Rifle*; &c. { Du Maurier, G.
- G. A. B.** **GEORGE A. BOULENGER, F.R.S., D.Sc., PH.D.**
In charge of the collections of Reptiles and Fishes, Department of Zoology, British Museum. Vice-President of the Zoological Society of London. { Dory.
- G. Be.** **GERTRUDE MARGARET LOTHIAN BELL.**
Author of *The Desert and the Sows*; &c. { Druses (*in part*).
- G. B. M. C.** **GEORGE BARNARD MILBANK COORE.**
Assistant Secretary, Board of Education, London. { Education: National Systems.
- G. C. W.** **GEORGE CHARLES WILLIAMSON, LITT.D.**
Chevalier of the Legion of Honour. Author of *Portrait Miniatures; Life of Richard Cosway, R.A.; George Englehart; Portrait Drawings*; &c. Editor of new edition of Bryan's *Dictionary of Painters and Engravers*. { Downman;
Dumont, François.
- G. F. B.** **G. F. BARWICK.**
Assistant Keeper of Printed Books and Superintendent of Reading Room, British Museum. { Dhuleep Singh.
- G. G. S.** **GEORGE GREGORY SMITH, M.A.**
Professor of English Literature, Queen's University of Belfast. Author of *The Days of James IV.; The Transition Period; Specimens of Middle Scots*; &c. { Douglas, Gavin;
Dunbar, William.
- G. H. Br.** **GEORGE HARTLEY BRYAN, M.A., D.Sc., F.R.S.**
Professor of Pure and Applied Mathematics, University College of North Wales. Formerly Fellow of Peterhouse, Cambridge. President of Mathematical Association, 1907. { Diffusion.
- G. H. C.** **GEORGE HERBERT CARPENTER, B.Sc.**
Professor of Zoology in the Royal College of Science, Dublin. Author of *Insects: their Structure and Life*. { Dragon-fly (*in part*).
- G. S. W.*** **GEORGE STEPHEN WEST, M.A., D.Sc., F.L.S.**
Professor of Botany, University of Birmingham. Associate of Royal College of Science, London. Author of *Treatise on British Fresh-water Algae*; &c. { Diatomaceæ (*in part*).
- H. A. Ml.** **HENRY ALEXANDER MIERS, M.A., D.Sc., F.R.S.**
Principal of the University of London. Fellow of Magdalen College, Oxford. Formerly Waynflete Professor of Mineralogy, Oxford. President of Mineralogical Society since 1904. Editor of the *Mineralogical Magazine*, 1891-1900. Author of *Mineralogy*; &c. { Diamond.
- H. B. Wo.** **HORACE BOLINGBROKE WOODWARD, F.R.S., F.G.S.**
Formerly Assistant Director of the Geological Survey of England and Wales. President, Geologists' Association, 1893-1894. Wollaston Medallist, 1908. { Desmarset, H.
- H. Ch.** **HUGH CRISHOLM, M.A.**
Formerly Scholar of Corpus Christi College, Oxford. Editor of the 11th edition of the *Encyclopædia Britannica*; Co-editor of the 10th edition. { Devonshire, Earls and Dukes
of;
Dufferin and Ava, 1st
Marquess; Edward VII.

H. Da.	REV. HIPPOLYTE DELEHAYE, S.J. Bollandist. Joint Author of the <i>Acta Sanctorum</i> .	{ Denis, Saint.
H. F. Ba.	HENRY FREDERICK BAKER, M.A., D.Sc., F.R.S. Fellow and Lecturer of St John's College, Cambridge. Cayley Lecturer in Mathematics in the University. Author of <i>Abel's Theory and the Allied Theory</i> ; &c.	{ Differential Equation.
H. F. G.	HANS FRIEDRICH GADOW, M.A., F.R.S., Ph.D. Strickland Curator and Lecturer on Zoology in the University of Cambridge. Author of <i>Amphibia and Reptiles</i> (Cambridge Natural History).	{ Dodo (<i>in part</i>).
H. G.	HUGH GODFRAY, M.A. Sometime Fellow of St John's College, Cambridge. Author of an <i>Elementary Treatise on the Lunar Theory</i> ; <i>A Treatise on Astronomy</i> .	{ Dial and Dialling.
H. H. T.	HERBERT HALL TURNER, M.A., D.Sc., F.R.S. Savilian Professor of Astronomy, Oxford University. Fellow of New College. Formerly Fellow of Trinity College, Cambridge, and Chief Assistant at the Royal Observatory, Greenwich. Correspondent, Institut de France. President, Royal Astronomical Society, 1903-1904. Author of <i>Modern Astronomy</i> ; <i>Astronomical Discovery</i> .	{ Eclipse (<i>in part</i>).
H. La.	HORACE LAMB, M.A., LL.D., D.Sc., F.R.S. Professor of Mathematics, University of Manchester. Formerly Fellow and Assistant Tutor of Trinity College, Cambridge. Member of Council of Royal Society, 1894-1896. Royal Medallist, 1902. President of London Mathematical Society, 1902-1904. Author of <i>Hydrodynamics</i> ; &c.	{ Dynamics.
H. N. D.	HENRY NEWTON DICKSON, M.A., D.Sc., F.R.S. (Edin.), F.R.G.S. Professor of Geography at University College, Reading. Formerly Vice-President, Royal Meteorological Society. Lecturer in Physical Geography, Oxford. Author of <i>Meteorology</i> ; <i>Elements of Weather and Climate</i> ; &c.	{ Desert.
H. O. T.	HENRY OSBORN TAYLOR, LL.B. (Columbia). Author of <i>The Classical Heritage of the Middle Ages</i> ; <i>Ancient Ideals</i> ; &c.	{ Dionysius Areopagiticus.
H. St.	HENRY STURT, M.A. Author of <i>Idolo Theatri</i> ; <i>The Idea of a Free Church</i> ; and <i>Personal Idealism</i> .	{ Düring.
H. S. S.	HAROLD SPENCER SCOTT, M.A. New College, Oxford. Barrister-at-Law, Lincoln's Inn.	{ Dewey.
H. Tl.	HENRY TIEDEMANN. London Editor of the <i>Nieuwe Rotterdamse Courant</i> . Ex-President of the Foreign Press Association.	{ Doxy.
H. W. C. D.	HENRY WILLIAM CARLESS DAVIS, M.A. Fellow and Tutor of Balliol College, Oxford. Fellow of All Souls' College, Oxford, 1895-1902. Author of <i>England under the Normans and Angevins</i> ; <i>Charlemagne</i> .	{ Dermot MacMurrough; Edmund, Saint.
H. W. H.	HOPE W. HOGG, M.A. Professor of Semitic Languages and Literatures in the University of Manchester.	{ Edessa.
I. A.	ISRAEL ABRAHAMS, M.A. Reader in Talmudic and Rabbinic Literature, University of Cambridge. President, Jewish Historical Society of England. Author of <i>A Short History of Jewish Literature</i> ; <i>Jewish Life in the Middle Ages</i> .	{ Dukes, Leopold; Dunash; Duran.
J. A. °	JOHN AITKEN, LL.D., F.R.S. Investigator of Atmospheric Dust. Inventor of instruments for counting the dust particles in the atmosphere. Author of papers on Dust Fogs and Clouds; Hazing Effects of Atmospheric Dust; Cyclones and Anticyclones; &c., in publications of Royal Society.	{ Dust.
J. A. H.	JOHN ALLEN HOWE, B.Sc. Curator and Librarian of the Museum of Practical Geology, London.	{ Devonian System; Dritt.
J. A. P. °	REV. JAMES ALEXANDER PATERSON, M.A., D.D. Professor of Hebrew and Old Testament Exegesis, New College, Edinburgh. Author of <i>The Period of the Judges</i> ; <i>Book of Leviticus</i> , in "Temple" Bible; <i>Book of Numbers</i> , in "Polychrome" Bible; &c. Translator of Schultz's <i>Old Testament Theology</i> .	{ Deuteronomy.
J. C. H.	JAMES CLERK MAXWELL, D.C.L., F.R.S. See the biographical article: MAXWELL, JAMES CLERK.	{ Diagram.
J. F.-H.	JAMES FITZMAURICE-KELLY, Litt.D., F.R.Hist.S. Gilmour Professor of Spanish Language and Literature, Liverpool University. Norman McColl Lecturer, Cambridge University. Fellow of the British Academy. Member of the Royal Spanish Academy. Knight Commander of the Order of Alphonso XII. Author of <i>A History of Spanish Literature</i> ; &c.	{ Dons, Joñe de; Don Juan; Echegaray y Eizaguirre.
J. G. H.	JOSEPH G. HORNER, A.M.I.MECH.E. Author of <i>Plating and Boiler Making</i> ; <i>Practical Metal Turning</i> ; &c.	{ Drawing: Drawing-Office Work.
J. M. G.	JOHANN HENDRIK GALLÉE, Ph.D. Professor of Comparative Philology and Teutonic Languages, University of Utrecht. President of the Philological Society, Utrecht. Author of <i>Allsächsische Sprachdenkmäler</i> .	{ Dutch Language.
J. H. E.	JOHN HORACE ROUND, M.A., LL.D. (Edin.). Author of <i>Feudal England</i> ; <i>Studies in Peerage and Family History</i> ; <i>Peerage and Pedigree</i> ; &c.	{ Domesday Book; Earl; Earl Marshal.
J. I.	JULES ISAAC. Professor of History at the Lycée de Lyons.	{ Du Bellay, Guillaume and Joan.

- J. J. H.** J. J. HUMMEL, F.I.C. (d. 1902).
Formerly Professor of Dyeing, University of Leeds. Author of *The Dyeing of Textile Fabrics*. { Dyeing (*in part*).
- J. J. L.*** REV. JOHN JAMES LIAS, M.A.
Chancellor of Llandaff Cathedral. Formerly Hulsean Lecturer in Divinity and Lady Margaret Preacher, University of Cambridge. { Döllinger.
- J. L. M.** JOHN LINTON MYRES, M.A., F.S.A., F.R.G.S.
Wykeham Professor of Ancient History in the University of Oxford. Formerly Gladstone Professor of Greek and Lecturer in Ancient Geography, University of Liverpool. Lecturer in Classical Archaeology in University of Oxford. { Doriana.
- J. MI.** JOHN MILNE, F.G.S., F.R.S., D.Sc.
Formerly Professor of Mining and Geology, Imperial University of Tokio. Founder of the Seismic Survey of Japan. Designer of seismographs and instruments to record vibrations on railways, &c. Author of *Earthquakes; Seismology; Crystallography*; &c. { Earthquake (*in part*).
- J. Mo.** VISCOUNT MORLEY OF BLACKBURN.
See the biographical article: MORLEY, VISCOUNT, OF BLACKBURN. { Diderot.
- J. M. M.** JOHN MALCOLM MITCHELL.
Sometime Scholar of Queen's College, Oxford. Lecturer in Classics, East London College (University of London). Joint Editor of Grote's *History of Greece*. { Draco;
Ecclesia.
- J. M. M. D.** J. M. M. DALLAS.
Formerly Secretary of the Edinburgh Draughts Club. { Draughts (*in part*).
- J. O. B.** JOHN OLIVER BORLEY, M.A.
Gonville and Caius College, Cambridge. { Dredge and Dredging: *Marine*.
- J. P. B.** JAMES GEORGE JOSEPH PENDEREL-BRODHURST.
Editor of the *Guardian*, London. { Desk.
- J. R. C.** JOSEPH ROGERSON COTTER, M.A.
Assistant to the Professor of Physics, Trinity College, Dublin. Editor of 2nd edition of Preston's *Theory of Heat*. { Dispersion.
- J. R. F.** JOHN RITCHIE FINDLAY.
See the biographical article: FINDLAY, J. R. { De Quincey.
- J. R. Fo.** JOHN R. FOTHERGILL.
Editor of *The Slade*. { Drawing.
- J. S. F.** JOHN SMITH FLETT, D.Sc., F.G.S.
Petrographer to the Geological Survey. Formerly Lecturer on Petrology in Edinburgh University. Neil Medalist of the Royal Society of Edinburgh. Bigsby Medalist of the Geological Society of London. { Diabase; Diorite;
Dolerite; Dolomite;
Ecoligte.
- J. T. Be.** JOHN T. BEALBY.
Joint-author of Stanford's *Europe*. Formerly Editor of the *Scottish Geographical Magazine*. Translator of Sven Hedin's *Through Asia, Central Asia and Tibet*; &c. { Dnieper (*in part*);
Dniester (*in part*);
Don (*in part*);
Don Cossacks, Territory of the
(*in part*);
Dvina (*in part*);
Echmiadzin (*in part*).
- Jno. W.** JOHN WESTLAKE, K.C., LL.D., D.C.L.
Professor of International Law, Cambridge, 1888-1908. One of the Members for United Kingdom of International Court of Arbitration under the Hague Convention, 1900-1906. Author of *A Treatise on Private International Law; International Law: I. Peace; II. War*; &c. { Domicile.
- J. Wn.** JAMES WELTON, M.A.
Professor of Education in the University of Leeds. Author of *Logical Bases of Education; Principles and Methods of Moral Training*; &c. { Education: *Theory*.
- J. W. Ho.** JAMES WYCLIFFE HEADLAM, M.A.
Staff Inspector of Secondary Schools under the Board of Education. Formerly Fellow of King's College, Cambridge. Professor of Greek and Ancient History at Queen's College, London. Author of *Bismarck and the Foundation of the German Empire*; &c. { Droysen, J. G.
- K. S.** KATHLEEN SCHLESINGER.
Author of *The Instruments of the Orchestra*; &c. { Double-Bass; Drone;
Drum; Dulcimer.
- L. F. V.-H.** LEVESON FRANCIS VERNON-HARCOURT, M.A., M.INST.C.E. (1839-1907).
Formerly Professor of Civil Engineering at University College, London. Author of *Rivers and Canals; Harbours and Docks; Civil Engineering as applied in Construction*; &c. { Dock.
- L. J. S.** LEONARD JAMES SPENCER, M.A., F.G.S.
Assistant, Department of Mineralogy, British Museum. Formerly Scholar of Sidney Sussex College, Cambridge, and Harkness Scholar. Editor of the *Mineralogical Magazine*. { Diallage; Diaspore;
Diopside; Dioptase.
- L. V.*** LUIGI VILLARI.
Italian Foreign Office (Emigration Department). Formerly Newspaper Correspondent in East of Europe. Italian Vice-Consul in New Orleans, 1906; Philadelphia, 1907; and Boston, U.S.A., 1907-1910. Author of *Italian Life in Town and Country; Fire and Sword in the Caucasus*; &c. { Diavolo, Fra;
Doria.
- M. A. G.** MAURICE ARTHUR CANNEY, M.A.
Assistant Lecturer in Semitic Languages in the University of Manchester. { Dörner.

- M. B.** MISS MARGARET BRYANT.
- M. F.** SIR MICHAEL FOSTER, K.C.B., D.C.L., D.Sc., LL.D., F.R.S.
See the biographical article: FOSTER, SIR M.
- M. G. D.** RT. HON. SIR MOUNTSTUART ELPHINSTONE GRANT-DUFF, G.C.S.I., F.R.S.
(1829-1906).
M.P. for the Elgin Burghs, 1857-1881. Under-Secretary of State for India, 1868-1874. Under-Secretary of State for the Colonies, 1880-1881. Governor of Madras, 1881-1886. President of the Royal Geographical Society, 1889-1893. President of the Royal Historical Society, 1892-1899. Author of *Studies in European Politics; Notes from a Diary*; &c.
- M. H.** MARCUS HARTOG, M.A., D.Sc., F.L.S.
Professor of Zoology, University College, Cork. Author of *Protozoa* (in Cambridge Natural History); and papers for various scientific journals.
- M. J.** MORRIS JASTROW, JR., PH.D.
Professor of Semitic Languages, University of Pennsylvania, U.S.A. Author of *Religion of the Babylonians and Assyrians*; &c.
- M. O. B. G.** MAXIMILIAN OTTO BISMARCK CASPARI, M.A.
Reader in Ancient History at London University. Lecturer in Greek at Birmingham University, 1905-1908.
- M. N.** NORMAN MCLEAN, M.A.
Fellow, Lecturer and Librarian of Christ's College, Cambridge. University Lecturer in Aramaic. Examiner for the Oriental Languages Tripos, and the Theological Tripos, at Cambridge.
- M. N. B.** NICHOLAS MURRAY BUTLER.
See the biographical article: BUTLER, N. M.
- M. W. T.** NORTHCOTE WHITEBRIDGE THOMAS, M.A.
Government Anthropologist to Southern Nigeria. Corresponding Member of the Société d'Anthropologie de Paris. Author of *Thought Transference; Kinship and Marriage in Australia*; &c.
- O. J. R. H.** OSBERT JOHN RADCLIFFE HOWARTH, M.A.
Christ Church, Oxford. Geographical Scholar, 1901 Assistant Secretary of the British Association.
- P. A. K.** PRINCE PETER ALEXEIVITCH KROPOTKIN.
See the biographical article: KROPOTKIN, PRINCE P. A.
- P. C. M.** PETER CHALMERS MITCHELL, F.R.S., M.A., D.Sc., LL.D.
Secretary to the Zoological Society of London. University Demonstrator in Comparative Anatomy and Assistant to Linacre Professor at Oxford, 1888-1891. Lecturer on Biology at Charing Cross Hospital, 1892-1894; at London Hospital, 1894. Examiner in Biology to the Royal College of Physicians, 1892-1896, 1901-1903. Examiner in Zoology to the University of London, 1903.
- P. C. Y.** PHILIP CHESNEY YORKE, M.A.
Magdalen College, Oxford.
- P. GL.** PETER GILES, M.A., LL.D., LITT. D.
Fellow and Classical Lecturer of Emmanuel College, Cambridge, and University Reader in Comparative Philology. Late Secretary of the Cambridge Philological Society. Author of *Manual of Comparative Philology*; &c.
- P. G. K.** PAUL GEORGE KONODY.
Art Critic of the *Observer* and the *Daily Mail*. Formerly Editor of *The Artist*. Author of *The Art of Walter Crane; Velasquez, Life and Work*; &c.
- R.** LORD RAYLEIGH.
See the biographical article: RAYLEIGH, 3RD BARON.
- R. A. S. M.** ROBERT ALEXANDER STEWART MACALISTER, M.A., F.S.A.
St John's College, Cambridge. Director of Excavations for the Palestine Exploration Fund.
- R. C. J.** SIR RICHARD CLAVERHOUSE JEBB, LITT.D., D.C.L.
See the biographical article: JEBB, SIR RICHARD C.
- R. D. M.** R. D. MILNER.
Formerly Assistant, U.S. Department of Agriculture.
- R. H. D.*** ROBERT HENRY DAVIS.
Managing Director, Siebe, Gorman & Co., Ltd., Submarine Engineers, London. Author of *A Diving Manual*; &c.
- R. I. P.** REGINALD INNES POCOCK, F.Z.S.
Superintendent of the Zoological Gardens, London.
- R. J.** RICHARD JORDAN.
Draughts Champion of Scotland, 1896, and of the world, 1896 seq.
- R. J. H.** RONALD JOHN MCNEILL, M.A.
Christ Church, Oxford. Barrister-at-Law. Formerly Editor of the *St James's Gazette*, London.
- Dryden (*in part*); Dumas.
Du Bois-Reymond.
Derby, 14th Earl of.
Dinoflagellata.
Ea;
Ebabai.
Doris.
Dionysius Talmaharensis.
Education: United States.
Demonology;
Divination;
Doll; Dreams.
Denmark: Geography and Statistics (*in part*).
Dnieper (*in part*); Dniester (*in part*); Don (*in part*); Don Cossacks, Territory of the (*in part*); Dvina (*in part*); Echmiadzin (*in part*).
Dog (*in part*).
Derby, 7th Earl of;
Digby, Sir Everard;
Digby, Sir Kenelm.
E.
Donatello.
Diffraction of Light.
Diptych.
Demosthenes.
Dietetics (*in part*).
Divers and Diving Apparatus.
Earwig.
Draughts (*in part*).
Driving;
Durham, 1st Earl of.

- R. L.°** RICHARD LYDEKKER, F.R.S., F.G.S., F.Z.S.
Member of the Staff of the Geological Survey of India, 1875-1882. Author of *Catalogues of Fossil Mammals, Reptiles and Birds in British Museum; The Deer of all Lands; &c.* { Dingo; Dolphin; Dormouse; Dugong; Duiker; Edentata.
- R. Ma.** REV. ROBERT MACINTOSH, D.D.
Professor of Christian Ethics and Apologetics, Lancashire Independent College. Lecturer on the Philosophy of Religion, University of Manchester. Author of *Christ and the Jewish Law; &c.* { Dogma.
- R. M'L.** ROBERT M'LACHLAN, F.R.S.
Editor of the *Entomologists' Monthly Magazine.* { Dragon-fly (in part).
- R. H. B.** ROBERT NISBET BAIN (d. 1900).
Assistant Librarian, British Museum 1883-1909. Author of *Scandinavia: the Political History of Denmark, Norway and Sweden, 1513-1900; The First Romanesque, 1613 to 1725; Slavonic Europe: the Political History of Poland and Russia from 1469 to 1766; &c.* { Denmark: Medieval and Modern History; Dessewilly; Diagoosa; Dolgoruki; Dozza.
- R. P. S.** R. PHENÉ SPIELES, F.S.A., F.R.I.B.A.
Formerly Master of the Architectural School, Royal Academy, London. Past-President of Architectural Association. Associate and Fellow of King's College, London. Corresponding Member of the Institute of France. Editor of Ferguson's *History of Architecture.* Author of *Architecture: East and West; &c.* { Dome; Door; Doorway; Early English Period.
- S. A. C.** STANLEY ARTHUR COOK.
Editor for Palestine Exploration Fund. Lecturer in Hebrew and Syriac, and formerly Fellow, Gonville and Caius College, Cambridge. Examiner in Hebrew and Aramaic, London University, 1904-1908. Council of Royal Asiatic Society, 1904-1905. Author of *Glossary of Aramaic Inscriptions; The Laws of Moses and Code of Hammurabi; Critical Notes on Old Testament History; Religion of Ancient Palestine; &c.* { Edom.
- St C.** VISCOUNT ST CYRES.
See the biographical article: IDDESLEIGH, 1ST EARL OF. { Du Vergier de Hauranne.
- St H.** LORD ST HELLIER (SIR FRANCIS HENRY JEUNE), P.C., K.C.B., G.C.B. (1843-1905).
President of the Probate, Divorce and Admiralty Division of the High Court of Justice, 1893-1905. Honorary Fellow of Hertford College, Oxford. { Divorce.
- S. C.** SIDNEY COLVIN, LL.D.
See the biographical article: COLVIN, S. { Dürer.
- S. D. H.** S. D. HOPKINSON. { Dividend.
- S. K.** SYEN KONOW, PH.D.
Professor of Indian Philology in the University of Christiania. Officier de l'Académie Française. Author of *Samaritana brâhmana; The Karpuramâhârî; volumes on Tibeto-Burman languages; Manda and Dravidian; "Mârâthi Bhûl" in The Linguistic Survey of India.* { Dravidian.
- S. H.** SIMON NEWCOMB, LL.D.
See the biographical article: NEWCOMB, SIMON. { Eclipse (in part); Ecliptic.
- T. As.** THOMAS ASHEY, M.A., D.LITT., F.S.A.
Director of the British School of Archaeology at Rome. Corresponding Member of the Imperial German Archaeological Institute. Formerly Scholar of Christ Church, Oxford. Craven Fellow, Oxford, 1897. Author of *The Classical Topography of the Roman Campagna; &c.* { Eboll.
- T. A. I.** THOMAS ALLAN INGRAM, M.A., LL.D.
Trinity College, Dublin. { Desertion.
- T. F. T.** THOMAS FREDERICK TOUT, M.A.
Professor of Medieval and Modern History in the University of Manchester. Formerly Fellow of Pembroke College, Oxford. Author of *Edward I.; The Empire and Papacy; &c.* { Edward I., II., III.; Edward, The Black Prince.
- T. K. C.** REV. THOMAS KELLY CHEYNE, M.A., D.D.
See the biographical article: CHEYNE, T. K. { Eden.
- T. L. H.** SIR THOMAS LITTLE HEATH, K.C.B., D.Sc.
Assistant Secretary to the Treasury. Formerly Fellow of Trinity College, Cambridge. Author of *Diophantos of Alexandria; Editor of The Thirteen Books of Euclid's Elements; &c.* { Diophantos.
- T. M. F.** THOMAS MCCALL FALLOW, M.A., F.S.A.
Formerly Editor of the *Antiquary.* Author of *Memorials of Old Yorkshire; Cathedral Churches of Ireland; &c.* { Easter.
- T. Se.** THOMAS SECCOMBE, M.A.
Balliol College, Oxford. Lecturer in History, East London and Birkbeck Colleges (University of London). Stanhope Prizeman, Oxford, 1887. Assistant Editor of *Dictionary of National Biography, 1891-1901.* Author of *The Age of Johnson; Joint Author of The Bookman History of English Literature; &c.* { Dickens; Dostolevsky.
- T. W. R. D.** T. W. RHYNS DAVIDS, LL.D., PH.D.
Professor of Comparative Religion, Manchester. Professor of Pali and Buddhist Literature, University College, London, 1882-1904. President of the Pali Text Society. Fellow of the British Academy. Secretary and Librarian of Royal Asiatic Society, 1885-1902. Author of *Buddhism; Sacred Books of the Buddhists; Early Buddhism; Buddhist India; Dialogues of the Buddha; &c.* { Devadatta; Dhammapala.

- V. T.** VLADIMIR TCHERTKOFF.
Editor of *The Free Age Press*. Literary Representative of Leo Tolstoy. Author of *Christian Martyrdom in Russia*; &c.
- W. A.** WILLIAM ARCHER.
See the biographical article Archer, William.
- W. A. B. C.** REV. WILLIAM AUGUSTUS BREVOORT COOLIDGE, M.A., F.R.G.S., Ph.D. (Bern).
Fellow of Magdalen College, Oxford. Professor of English History, St David's College, Lampeter, 1880-1881. Author of *Guida du Haut Dauphiné*; *The Range of the Alps*; *Guide to Grindelwald*; *Guide to Switzerland*; *The Alps in Nature and in History*; &c. Editor of the *Alpine Journal*, 1880-1889; &c.
- W. A. P.** WALTER ALISON PHILLIPS, M.A.
Formerly Exhibitioner of Merton College and Senior Scholar of St John's College, Oxford. Author of *Modern Europe*; &c.
- W. A. S. H.** WILLIAM ALBERT SAMUEL HEWINS, M.A.
Secretary of the Tariff Commission. Formerly Director of the London School of Economics. Teacher of Modern Economic History in the University of London, 1902-1903. Took Professor of Economic Science and Statistics at King's College, London, 1897-1903. Author of *Imperialism and its Probable Effect on the Commercial Policy of the United Kingdom*; &c.
- W. B.** WALTER BAKENDALE.
Kennel Editor of the *Field*.
- W. E. B.** REV. WILLIAM EMERY BARNES, M.A., D.D.
Hulsean Professor of Divinity, Cambridge. Fellow and Hon. Chaplain of Peterhouse, Cambridge. Examining Chaplain to the Bishop of London. Joint Editor of *Journal of Theological Studies*, 1899-1901. Formerly Lecturer in Hebrew, Clare College, and Lecturer in Hebrew and Divinity, Peterhouse. Author of *The Canonical and Uncanonical Gospels*; *The Peshitta Text of Chronicles*; *The Psalms in the Peshitta Version*; *Genuineness of Isaiah*; &c.
- W. E. D.** WILLIAM ERNEST DALBY, M.A., M.INST.C.E., M.I.M.E., A.M.INST.N.A.
Professor of Civil and Mechanical Engineering at the City and Guilds of London Institute Central Technical College, South Kensington. Formerly University Demonstrator in the Engineering Department, Cambridge. Author of *The Balancing of Engines*; *Valves and Valve Gear Mechanism*; &c.
- W. F. Sh.** WILLIAM FLEETWOOD SHEPPARD, M.A.
Senior Examiner to the Board of Education. Formerly Fellow of Trinity College, Cambridge. Senior Wrangler, 1884.
- W. F. W.** WALTER FRANCIS WILLCOX, LL.B., Ph.D.
Chief Statistician, United States Census Bureau. Professor of Social Science and Statistics, Cornell University. Member of the American Social Science Association and Secretary of the American Economical Association. Author of *The Divorce Problem: A Study in Statistics*; *Social Statistics of the United States*; &c.
- W. G. F. P.** SIR WALTER GEORGE FRANK PHILLIMORE, BART., D.C.L., LL.D.
Judge of the King's Bench Division. President of International Law Association, 1905. Author of *Book of Church Law*. Editor of 2nd edition of *Phillimore's Ecclesiastical Law*; 3rd edition of vol. iv. of *Phillimore's International Law*; &c.
- W. Hy.** WILLIAM HENRY.
Founder and Chief Secretary to the Royal Life Saving Society. Associate of the Order of St John of Jerusalem. Joint Author of *Swimming*, (Badminton Library); &c.
- W. H.°** WALTER HUNTER, M.I.C.E., M.I.M.E., F.G.S.
Consulting Engineer for Waterworks to Crown Agents for the Colonies. Member of Council of Institute of Civil Engineers. Silver Metallist, Royal Society of Arts. Originator of Staines Scheme of Storage Reservoirs. Has reported on Waterworks at Accra, Secunder and Lagos; also on Rand Water Supply.
- W. H. Ma.** WILLIAM HENRY MAXWELL, A.M.I.C.E.
Borough and Waterworks Engineer, Tunbridge Wells. Formerly President of Institute of Sanitary Engineers, London. Author of *Refuse Destroyers*; &c. Joint Editor of *Encyclopaedia of Municipal and Sanitary Engineering*.
- W. L. G.** WILLIAM LAWSON GRANT, M.A.
Professor at Queen's University, Kingston, Canada. Formerly Beit Lecturer in Colonial History at Oxford University. Editor of *Acts of the Privy Council*, Colonial series; *Canadian Constitutional Development* (in collaboration).
- W. M.** WILLIAM MINTO, M.A.
See the biographical article: MINTO, WILLIAM.
- W. H. R.** WILLIAM MICHAEL ROSSETTI.
See the biographical article: ROSSETTI, DANTE GABRIEL.
- W. H. S.** WILLIAM NAPIER SHAW, M.A., LL.D., D.Sc., F.R.S.
Director of the Meteorological Office. Reader in Meteorology in the University of London. President of Permanent International Meteorological Committee. Member of Meteorological Council, 1897-1905. Hon. Fellow of Emmanuel College, Cambridge. Senior Tutor, 1890-1899. Joint Author of *Text Book of Practical Physics*; &c.
- Doukhobors.**
- Drama (Recent English).**
- Digne; Dolomites, The; Dornbirn; Durance; Ebel, J. G.**
- Diplomacy; Dispensation; Donation of Constantine; Dragon; Duke; Eastern Question, The.**
- Economics.**
- Dog (in part).**
- Ecclesiastical.**
- Dynamometer.**
- Differences, Calculus of.**
- Divorce: United States.**
- Ecclesiastical Jurisdiction.**
- Drowning and Life Saving.**
- Dredge and Dredging; Hydraulic Engineering.**
- Destroyers.**
- Dorchester, 1st Baron.**
- Dryden (in part).**
- Dolci; Domenichino; Dyce, William; Eastlake.**
- Dew.**

INITIALS AND HEADINGS OF ARTICLES

W. O. A.	WILBUR OLIN ATWATER, PH.D. (1844-1907). Formerly Professor of Chemistry, Wesleyan University, U.S.A. Special Agent of the United States Department of Agriculture in charge of Nutrition Investigations.	{ Diatetics (<i>in part</i>).
W. R. E. H.	WILLIAM RICHARD EATON HODGKINSON, PH.D., F.R.S. Professor of Chemistry and Physics, Ordnance College, Woolwich. Formerly Professor of Chemistry and Physics, R.M.A., Woolwich. Part author of Valentin-Hodgkinson's <i>Practical Chemistry</i> ; &c.	{ Dynamite.
W. R. L.	W. R. LETHABY, F.S.A. Principal of the Central School of Arts and Crafts under the London County Council. Author of <i>Architecture, Mysticism and Myth</i> ; &c.	{ Design.
W. S. J.	WILLIAM STANLEY JEVONS, LL.D. See the biographical article: JEVONS, WILLIAM STANLEY.	{ De Morgan.
W. W.	WILLIAM WALLACE. See the biographical article: WALLACE, WILLIAM (1844-1897).	{ Descartes.
W. W. R.*	WILLIAM WALKER ROCKWELL, LIC.THEOL. Assistant Professor of Church History, Union Theological Seminary, New York.	{ Dort, Synod of.

PRINCIPAL UNSIGNED ARTICLES

Democratic Party.
Democritus.
Derbyshire.
Desmoullins.
Detroit.
Devonshire.
De Witt, John.
Diabetes.
Diamond Necklace.
Dice.
Dictionary.
Didachē.
Dietary.
Dietrich of Bern.
Digitalls.
Dijon.

Dionysius.
Diphtheria.
Distress.
Dittersdorf, Karl D. von.
Divining-rod.
Dockyards.
Doge.
Dominoes.
Donatists.
Donegal.
Dorset, Earls, Marquesses
and Dukes of.
Dorsetshire.
Douglas: *Family*.
Dover.
Down.

Dragoman.
Drainage of Land.
Drake, Sir Francis.
Dresden.
Dropsy.
Drummond of Hawthornden.
Drunkenness.
Dualism.
Dublin.
Dunbar.
Dundee, Viscount.
Dundee: *City*.
Dundonald.
Duns Scotus.
Durban.
Durham.

Dutch East India Company.
Dutch West India Company.
Dwarf.
Dyaks.
Dysentery.
Dyspepsia.
Earth.
Eastern Bengal and Assam.
East India Company.
Eblonites.
Ecarté.
Ecclesiastical Law.
Eclecticism.
Edgeworth.
Edinburgh.
Edinburghshire.

ENCYCLOPÆDIA BRITANNICA

ELEVENTH EDITION

VOLUME VIII

DEMIJOHN, a glass bottle or jar with a large round body and narrow neck, encased in wicker-work and provided with handles. The word is also used of an earthenware jar, similarly covered with wicker. The capacity of a demijohn varies from two to twelve gallons, but the common size contains five gallons. According to the *New English Dictionary* the word is an adaptation of a French *Dame Jeanne*, or Dame Jane, an application of a personal name to an object which is not uncommon; cf. the use of "Toby" for a particular form of jug and the many uses of the name "Jack."

DEMISE, an Anglo-French legal term (from the Fr. *démètre*, Lat. *dimittere*, to send away) for a transfer of an estate, especially by lease. The word has an operative effect in a lease implying a covenant for "quiet enjoyment" (see LANDLORD AND TENANT). The phrase "demise of the crown" is used in English law to signify the immediate transfer of the sovereignty, with all its attributes and prerogatives, to the successor without any interregnum in accordance with the maxim "the king never dies." At common law the death of the sovereign *eo facto* dissolved parliament, but this was abolished by the Representation of the People Act 1867, §51. Similarly the common law doctrine that all offices held under the crown determined at its demise has been negated by the Demise of the Crown Act 1901. "Demise" is thus often used loosely for death or decease.

DEMIURGE (Gr. *δημιουργός*, from *δημιος*, of or for the people, and *εργον*, work), a handicraftsman or artisan. In Homer the word has a wide application, including not only hand-workers but even heralds and physicians. In Attica the demiurgi formed one of the three classes (with the Eupatridae and the geomori, georgi or agroeci) into which the early population was divided (cf. Arist. *Ath. Pol.* xiii. 2). They represented either a class of the whole population, or, according to Busolt, a commercial nobility (see EUPATRIDAE). In the sense of "worker for the people" the word was used throughout the Peloponnese, with the exception of Sparta, and in many parts of Greece, for a higher magistrate. The demiurgi among other officials represent Elis and Mantinea at the treaty of peace between Athens, Argos, Elis and Mantinea in 420 B.C. (Thuc. v. 47). In the Achaean League (7.s.) the name is given to ten elective officers who presided over the assembly, and Corinth sent "Epidemiurgi" every year to Potidaea, officials who apparently answered to the Spartan harmosts. In Plato *δημιουργός* is the name given to the "creator of the world" (*Timaeus*, 40) and the word was so adopted by the Gnostics (see GNOSTICISM).

DEMMIN, a town of Germany, kingdom of Prussia, on the navigable river Peene (which in the immediate neighbourhood receives the Trebel and the Tollense), 72 m. W.N.W. of Stettin, on the Berlin-Stralsund railway. Pop. (1905) 12,541. It has manufactures of textiles, besides breweries, distilleries and tanneries, and an active trade in corn and timber.

The town is of Slavonian origin and of considerable antiquity, and was a place of importance in the time of Charlemagne. It was besieged by a German army in 1148, and captured by Henry the Lion in 1164. In the Thirty Years' War Demmin was the object of frequent conflicts, and even after the peace of Westphalia was taken and retaken in the contest between the electoral prince and the Swedes. It passed to Prussia in 1720, and its fortifications were dismantled in 1759. In 1807 several engagements took place in the vicinity between the French and Russians.

DEMOCHARES (c. 355-275 B.C.), nephew of Demosthenes, Athenian orator and statesman, was one of the few distinguished Athenians in the period of decline. He is first heard of in 322, when he spoke in vain against the surrender of Demosthenes and the other anti-Macedonian orators demanded by Antipater. During the next fifteen years he probably lived in exile. On the restoration of the democracy by Demetrius Poliorketes in 307 he occupied a prominent position, but was banished in 303 for having ridiculed the decree of Stratocles, which contained a fulsome eulogy of Demetrius. He was recalled in 298, and during the next four years fortified and equipped the city with provisions and ammunition. In 296 (or 295) he was again banished for having concluded an alliance with the Boeotians, and did not return until 287 (or 286). In 280 he induced the Athenians to erect a public monument in honour of his uncle with a suitable inscription. After his death (some five years later) the son of Demochares proposed and obtained a decree (Plutarch, *Vitae decem oratorum*, p. 851) that a statue should be erected in his honour, containing a record of his public services, which seem to have consisted in a reduction of public expenses, a more prudent management of the state finances (after his return in 287) and successful begging missions to the rulers of Egypt and Macedonia. Although a friend of the Stoic Zeno, Demochares regarded all other philosophers as the enemies of freedom, and in 306 supported the proposal of one Sophocles, advocating their expulsion from Attica. According to Cicero (*Brutus*, 83) Demochares was the author of a history of his own times, written in an oratorical rather than a historical style. As a speaker he was noted for his freedom of language (*Parrhesiastes*, Seneca, *De ira*, iii. 23). He was violently attacked by Timaeus, but found a strenuous defender in Polybius (xii. 13).

See also Plutarch, *Demosthenes*, 30, *Demetrius*, 24; *Vitae decem oratorum*, p. 847; J. G. Droysen's essay on Demochares in *Zeitschrift für die Altertumswissenschaft* (1836), Nos. 20, 21.

DEMOCRACY (Gr. *δημοκρατία*, from *δημος*, the people, *i.e.* the commons, and *κράτος*, rule), in political science, that form of government in which the people rules itself, either directly, as in the small city-states of Greece, or through representatives. According to Aristotle, democracy is the perverted form of the

¹ For the "four years' war" and the chronological questions involved, see C. W. Müller, *Frag. Hist. Graec.* ii. 445.

third form of government, which he called *πολιτεία*, "polity" or "constitutional government," the rule of the majority of the free and equal citizens, as opposed to monarchy and aristocracy, the rule respectively of an individual and of a minority consisting of the best citizens (see GOVERNMENT and ARISTOCRACY). Aristotle's restriction of "democracy" to *bad* popular government, i.e. mob-rule, or, as it has sometimes been called, "ochlocracy" (*ὄχλος*, mob), was due to the fact that the Athenian democracy had in his day degenerated far below the ideals of the 5th century, when it reached its zenith under Pericles. Since Aristotle's day the word has resumed its natural meaning, but democracy in modern times is a very different thing from what it was in its best days in Greece and Rome. The Greek states were what are known as "city-states," the characteristic of which was that all the citizens could assemble together in the city at regular intervals for legislative and other purposes. This sovereign assembly of the people was known at Athens as the *Ecclesia* (*ἐκκλ.*), at Sparta as the *Apella* (*ἀπ.*), at Rome variously as the *Comitia Centuriata* or the *Concilium Plebis* (see COMITIA). Of representative government in the modern sense there is practically no trace in Athenian history, though certain of the magistrates (see STRATEGUS) had a quasi-representative character. Direct democracy is impossible except in small states. In the second place the qualification for citizenship was rigorous; thus Pericles restricted citizenship to those who were the sons of an Athenian father, himself a citizen, and an Athenian mother (*ἔξ ἀφοῖν ἄσσοι*). This system excluded not only all the slaves, who were more numerous than the free population, but also resident aliens, subject allies, and those Athenians whose descent did not satisfy this criterion (*τῶ γένει μὴ καθαροί*). The Athenian democracy, which was typical in ancient Greece, was a highly exclusive form of government.

With the growth of empire and nation states this narrow parochial type of democracy became impossible. The population became too large and the distance too great for regular assemblies of qualified citizens. The rigid distinction of citizens and non-citizens was progressively more difficult to maintain, and new criteria of citizenship came into force. The first difficulty has been met by various forms of representative government. The second problem has been solved in various ways in different countries; moderate democracies have adopted a low property qualification, while extreme democracy is based on the extension of citizenship to all adult persons with or without distinction of sex. The essence of modern representative government is that the people does not govern itself, but periodically elects those who shall govern on its behalf (see GOVERNMENT; REPRESENTATION).

DEMOCRATIC PARTY, originally DEMOCRATIC-REPUBLICAN PARTY, the oldest of existing political parties in the United States. Its origin lay in the principles of local self-government and repugnance to social and political aristocracy established as cardinal tenets of American colonial democracy, which by the War of Independence, which was essentially a democratic movement, became the basis of the political institutions of the nation. The evils of lax government, both central and state, under the Confederation caused, however, a marked anti-democratic reaction, and this united with the temperamental conservatism of the framers of the constitution of 1787 in the shaping of that conservative instrument. The influences and interests for and against its adoption took form in the groupings of Federalists and Anti-Federalists, and these, after the creation of the new government, became respectively, in underlying principles, and, to a large extent, in personnel, the Federalist party (*q.v.*) and the Democratic-Republican party.¹ The latter, organized by Thomas Jefferson in opposition to the Federalists dominated by Alexander Hamilton, was a real party by 1792. The great service of attaching to the constitution a democratic bill of rights belongs to the Anti-Federalists or Democratic-Republican party, although this was then amorphous. The Democratic-Republican party gained full control of the government, save the judiciary,

¹ The prefix "Democratic" was not used by Jefferson; it became established, however, and official.

in 1801, and controlled it continuously thereafter until 1825. No political "platforms" were then known, but the writings of Jefferson, who dominated his party throughout this period, take the place of such. His inaugural address of 1801 is a famous statement of democratic principles, which to-day are taken for granted only because, through the party organized by him to secure their success, they became universally accepted as the ideal of American institutions. In all the colonies, says John Adams, "a court and a country party had always contended"; Jefferson's followers believed sincerely that the Federalists were a new court party, and monarchist. Hence they called themselves "Republicans" as against monarchists,—standing also, incidentally, for states' rights against the centralization that monarchy (or any approach to it) implied; and "Democrats" as against aristocrats,—standing for the "common rights of Englishmen," the "rights of man," the levelling of social ranks and the widening of political privileges. In the early years of its history—and during the period of the French Revolution and afterwards—the Republicans sympathized with the French as against the British, the Federalists with the British as against the French.

Devotion to abstract principles of democracy and liberty, and in practical politics a strict construction of the constitution, in order to prevent an aggrandizement of national power at the expense of the states (which were nearer popular control) or the citizens, have been permanent characteristics of the Democratic party as contrasted with its principal opponents; but neither these nor any other distinctions have been continuously or consistently true throughout its long course.² After 1801 the commercial and manufacturing nationalistic³ elements of the Federalist party, being now dependent on Jefferson for protection, gradually went over to the Republicans, especially after the War of 1812; moreover, administration of government naturally developed in Republican ranks a group of broad-constructionists. These groups fused, and became an independent party.⁴ They called themselves *National Republicans*, while the Jacksonian Republicans soon came to be known simply as Democrats.⁵ Immediately afterward followed the tremendous victory of the Jacksonians in 1828,—a great advance in radical democracy over the victory of 1800. In the interval the Federalist party had disappeared, and practically the entire country, embracing Jeffersonian democracy, had passed through the school of the Republican party. It had established the power of the "people" in the sense of that word in present-day American politics. Bills of rights in every state constitution protected the citizen; some state judges were already elective; very soon the people came to nominate their presidential candidates in national conventions, and draft their party platforms through their convention representatives.⁶ After the National Republican scission the Democratic party, weakened thereby in its nationalistic tendencies, and deprived of the leadership of Jackson, fell quickly under the control of its Southern adherents and became virtually sectional in its objects. Its states' rights doctrine was turned to the defence of slavery. In thus opposing anti-slavery sentiment—inconsistently, alike as regarded the "rights of man" and constitutional construction, with its original and permanent

² Under the rubric of "strict construction" fall the greatest struggles in the party's history: those over the United States Bank, over tariffs—for protection or for "revenue" only—over "internal improvements," over issues of administrative economy in providing for the "general welfare," &c. The course of the party has frequently been inconsistent, and its doctrines have shown, absolutely considered, progressive latitudinarianism.

³ "Nationalistic" is used here and below, not in the sense of a general nationalistic spirit, such as that of Jackson, but to indicate the centralizing tendency of a broad construction of constitutional powers in behalf of commerce and manufactures.

⁴ Standing for protective tariffs, internal improvements, &c. It should be borne in mind, however, that the Democratic party of Jackson was not strictly identical with the Democratic-Republican party of Jefferson,—and some writers date back the origin of the present Democratic party only to 1828–1829.

⁵ The Democratic national convention of 1832 was preceded by an Anti-Masonic convention of 1830 and by the National-Republican convention of 1831; but the Democratic platform of 1840 was the first of its kind.

principles—it lost morale and power. As a result of the contest over Kansas it became fatally divided, and in 1860 put forward two presidential tickets: one representing the doctrine of Jefferson Davis that the constitution recognized slave-property, and therefore the national government must protect slavery in the territories; the other representing Douglas's doctrine that the inhabitants of a territory might virtually exclude slavery by "unfriendly legislation." The combined popular votes for the two tickets exceeded that cast by the new, anti-slavery Republican party (the second of the name) for Lincoln; but the election was lost. During the ensuing Civil War such members of the party as did not become War Democrats antagonized the Lincoln administration, and in 1864 made the great blunder of pronouncing the war "a failure." Owing to Republican errors in reconstruction and the scandals of President Grant's administration, the party gradually regained its strength and morale, until, having largely subordinated Southern questions to economic issues, it cast for Tilden for president in 1876 a popular vote greater than that obtained by the Republican candidate, Hayes, and gained control of the House of Representatives. The Electoral Commission, however, made Hayes president, and the quiet acceptance of this decision by the Democratic party did it considerable credit.

Since 1877 the Southern states have been almost solidly Democratic; but, except on the negro question, such unanimity among Southern whites has been, naturally, factitious; and by no means an unmixed good for the party. Apart from the "Solid South," the period after 1875 is characterized by two other party difficulties. The first was the attempt from 1878 to 1896 to "straddle" the silver issue; the second, an attempt after 1896 to harmonize general elements of conservatism and radicalism within the party. In 1896 the South and West gained control of the organization, and the national campaigns of 1896 and 1900 were fought and lost mainly on the issue of "free silver," which, however, was abandoned before 1904. After 1898 "imperialism," to which the Democrats were hostile, became another issue. Finally, after 1896, there became very apparent in the party a tendency to attract the radical elements of society in the general re-alignment of parties taking place on industrial-social issues; the Democratic party apparently attracting, in this readjustment, the "radicals" and the "masses" as in the time of Jefferson and Jackson. In this process, in the years 1896-1900, it took over many of the principles and absorbed, in large part, the members of the radical third-party of the "Populists," only to be confronted thereupon by the growing strength of Socialism, challenging it to a farther radical widening of its programme. From 1860 to 1908 it elected but a single president (Grover Cleveland, 1885-1889 and 1893-1897).¹ All American parties accepted long ago in theory "Jeffersonian democracy"; but the Democratic party has been "the political champion of those elements of the [American] democracy which are most democratic. It stands nearest the people."² It may be noted that the Jeffersonian Republicans did not attempt to democratize the constitution itself. The choice of a president was soon popularized, however, in effect; and the popular election of United States senators is to-day a definite Democratic tenet.³

BIBLIOGRAPHY.—For an exposition of the party's principles see Thomas Jefferson, *Writings*, ed. by P. L. Ford (10 vols., New York, 1892-1899); J. P. Foley (ed.), *The Jeffersonian Cyclopaedia* (New York, 1900); and especially the *Campaign Text-Books* of more recent

¹ The attitude of the Republican party was no less inconsistent and evasive.

² It controlled the House of Representatives from 1874 to 1894 except in 1880-1882 and 1888-1890; but except for a time in Cleveland's second term, there were never simultaneously a Democratic president and a Democratic majority in Congress.

³ Professor A. D. Morse in *International Monthly*, October 1900. He adds: "It has done more to Americanize the foreigner than all other parties." (It is predominant in the great cities of the country.)

⁴ In connexion with the prevalent popular tendency to regard the president as a people's tribune, it may be noted that a strong presidential veto is, historically, peculiarly a Democratic contribution, owing to the history of Jackson's (compare Cleveland's) administration.

times, usually issued by the national Democratic committee in alternate years, and M. Carey, *The Democratic Speaker's Handbook* (Cincinnati, 1868). For a hostile criticism of the party, see W. D. Jones, *Mirror of Modern Democracy; History of the Democratic Party from 1825 to 1861* (New York, 1864); Jonathan Norcross, *History of Democracy Considered as a Party-Name and a Political Organization* (New York, 1883); J. H. Patton, *The Democratic Party: Its Political History and Influence* (New York, 1884). Favourable treatises are R. H. Gillet, *Democracy in the United States* (New York, 1868); and George Fitch, *Political Facts: an Historical Text-Book of the Democratic and Other Parties* (Baltimore, 1884). See also, for general political history, Thomas H. Benton, *Thirty Years' View* (2 vols., New York, 1854-1856, and later editions); James G. Blaine, *Twenty Years of Congress* (2 vols., Norwich, Conn., 1884-1893); S. S. Cox, *Three Decades of Federal Legislation* (Providence, 1885); S. P. Orth, *Five American Politicians: a Study in the Evolution of American Politics* (Cleveland, 1906), containing sketches of four Democratic leaders—Burr, De Witt Clinton, Van Buren and Douglas; J. Marcy, *Party Organization and Machinery* (New York, 1904); J. H. Hopkins, *History of Political Parties in the United States* (New York, 1900); E. S. Stanwood, *History of the Presidency* (last ed., Boston, 1904); J. P. Gurdy, *History of Political Parties*, I. (New York, 1900); H. J. Ford, *Rise and Growth of American Politics* (New York, 1908); Alexander Johnston, *History of American Politics* (New York, 1900, and later editions); C. E. Merriam, *A History of American Political Theories* (New York, 1903), containing chapters on the Jeffersonian and the Jacksonian Democracy; and James A. Woodburn, *Political Parties and Party Problems in the United States* (New York, 1903).

DEMOCRITUS, probably the greatest of the Greek physical philosophers, was a native of Abdera in Thrace, or as some say—probably wrongly—of Miletus (Diog. Laërt. ix. 34). Our knowledge of his life is based almost entirely on tradition of an untrustworthy kind. He seems to have been born about 470 or 460 B.C., and was, therefore, an older contemporary of Socrates. He inherited a considerable property, which enabled him to travel widely in the East in search of information. In Egypt he settled for seven years, during which he studied the mathematical and physical systems of the ancient schools. The extent to which he was influenced by the Magi and the Eastern astrologists is a matter of pure conjecture. He returned from his travels impoverished; one tradition says that he received 500 talents from his fellow-citizens, and that a public funeral was decreed him. Another tradition states that he was regarded as insane by the Abderitans, and that Hippocrates was summoned to cure him. Diodorus Siculus tells us that he died at the age of ninety; others make him as much as twenty years older. His works, according to Diogenes Laërtius, numbered seventy-two, and were characterized by a purity of style which compares favourably with that of Plato. The absurd epithet, the "laughing philosopher," applied to him by some unknown and very superficial thinker, may possibly have contributed in some measure to the fact that his importance was for centuries overlooked. It is interesting, however, to notice that Bacon (*De Principiis*) assigns to him his true place in the history of thought, and points out that both in his own day and later "in the times of Roman learning" he was spoken of in terms of the highest praise. In the variety of his knowledge, and in the importance of his influence on both Greek and modern speculation he was the Aristotle of the 5th century, while the sanity of his metaphysical theory has led many to regard him as the equal, if not the superior, of Plato.

His views may be treated under the following heads:—

1. *The Atoms and Cosmology* (adopted in part at least from the doctrines of Leucippus, though the relations between the two are hopelessly obscure). While agreeing with the Eleatics as to the eternal sameness of Being (nothing can arise out of nothing; nothing can be reduced to nothing), Democritus followed the physicists in denying its oneness and immobility. Movement and plurality being necessary to explain the phenomena of the universe and impossible without space (not-Being), he asserted that the latter had an equal right with Being to be considered existent. Being is the Full ($\pi\lambda\eta\rho\epsilon\varsigma$, *plenum*); not-Being is the Void ($\kappa\epsilon\nu\omicron$, *vacuum*), the infinite space in which moved the infinite number of atoms into which the single Being of the Eleatics was broken up. These atoms are eternal and invisible; absolutely small, so small that their size cannot be

diminished (hence the name *ἀτομος*, "indivisible"); absolutely full and incompressible, they are without pores and entirely fill the space they occupy; homogeneous, differing only in figure (as A from N), arrangement (as AN from NA), position (as N is Z on its side), magnitude (and consequently in weight, although some authorities dispute this). But while the atoms thus differ in quantity, their differences of quality are only apparent, due to the impressions caused on our senses by different configurations and combinations of atoms. A thing is only hot or cold, sweet or bitter, hard or soft by convention (*νόμος*); the only things that exist in reality (*ἄεξις*) are the atoms and the void. Locke's distinction between primary and secondary qualities is here anticipated. Thus, the atoms of water and iron are the same, but those of the former, being smooth and round, and therefore unable to hook on to one another, roll over and over like small globes, whereas the atoms of iron, being rough, jagged and uneven, cling together and form a solid body. Since all phenomena are composed of the same eternal atoms (just as a tragedy and a comedy contain the same letters) it may be said that nothing comes into being or perishes in the absolute sense of the words (cf. the modern "indestructibility of matter" and "conservation of energy"), although the compounds of the atoms are liable to increase and decrease, appearance and disappearance—in other words, to birth and death. As the atoms are eternal and uncaused, so is motion; it has its origin in a preceding motion, and so on *ad infinitum*. For the Love and Hate of Empedocles and the *Nous* (Intelligence) of Anaxagoras, Democritus substituted fixed and necessary laws (not chance; that is a misrepresentation due chiefly to Cicero). Everything can be explained by a purely mechanical (but not fortuitous) system, in which there is no room for the idea of a providence or an intelligent cause working with a view to an end. The origin of the universe was explained as follows. An infinite number of atoms was carried downwards through infinite space. The larger (and heavier), falling with greater velocity, overtook and collided with the smaller (and lighter), which were thereby forced upwards. This caused various lateral and contrary movements, resulting in a whirling movement (*δίνη*) resembling the rotation of Anaxagoras, whereby similar atoms were brought together (as in the winnowing of grain) and united to form larger bodies and worlds. Atoms and void being infinite in number and extent, and motion having always existed, there must always have been an infinite number of worlds, all consisting of similar atoms, in various stages of growth and decay.

2. *The Soul*.—Democritus devoted considerable attention to the structure of the human body, the noblest portion of which he considered to be the soul, which everywhere pervades it, a psychic atom being intercalated between two corporeal atoms. Although, in accordance with his principles, Democritus was bound to regard the soul as material (composed of round, smooth, specially mobile atoms, identified with the fire-atoms floating in the air), he admitted a distinction between it and the body, and is even said to have looked upon it as something divine. These all-pervading soul atoms exercise different functions in different organs; the head is the seat of reason, the heart of anger, the liver of desire. Life is maintained by the inhalation of fresh atoms to replace those lost by exhalation, and when respiration, and consequently the supply of atoms, ceases, the result is death. It follows that the soul perishes with, and in the same sense as, the body.

3. *Perception*.—Sensations are the changes produced in the soul by external impressions, and are the result of contact, since every action of one body (and all representations are corporeal phenomena) upon another is of the nature of a shock. Certain emanations (*ἀπορροαί, ἀπὸρροαί*) or images (*εἰδῶνα*), consisting of subtle atoms, thrown off from the surface of an object, penetrate the body through the pores. On the principle that like acts upon like, the particular senses are only affected by that which resembles them. We see by means of the eye alone, and hear by means of the ear alone, these organs being best adapted to receive the images or sound currents. The organs are thus merely conduits or passages through which the atoms pour into the soul.

The eye, for example, is damp and porous, and the act of seeing consists in the reflection of the image (*εἰκόνων*) mirrored on the smooth moist surface of the pupil. To the interposition of air is due the fact that all visual images are to some extent blurred. At the same time Democritus distinguished between obscure (*σκότιον*) cognition, resting on sensation alone, and genuine (*γνήσιον*), which is the result of inquiry by reason, and is concerned with atoms and void, the only real existences. This knowledge, however, he confessed was exceedingly difficult to attain.

It is in Democritus first that we find a real attempt to explain colour. He regards black, red, white and green as primary. White is characteristically smooth, *i.e.* casting no shadow, even, flat; black is uneven, rough, shadowy and so on. The other colours result from various mixtures of these four, and are infinite in number. Colour itself is not objective; it is found not in the ultimate *πλεονν* and *ωκισμν*, but only in derived objects according to their physical qualities and relations.

4. *Theology*.—The system of Democritus was altogether atheistic. But, although he rejected the notion of a deity taking part in the creation or government of the universe, he yielded to popular prejudice so far as to admit the existence of a class of beings, of the same form as men, grander, composed of very subtle atoms, less liable to dissolution, but still mortal, dwelling in the upper regions of air. These beings also manifested themselves to man by means of images in dreams, communicated with him, and sometimes gave him an insight into the future. Some of them were benevolent, others malignant. According to Plutarch, Democritus recognized one god under the form of a fiery sphere, the soul of the world, but this idea is probably of later origin. The popular belief in gods was attributed by Democritus to the desire to explain extraordinary phenomena (thunder, lightning, earthquakes) by reference to superhuman agency.

5. *Ethics*.—Democritus's moral system—the first collection of ethical precepts which deserves the name—strongly resembles the negative side of the system of Epicurus. The *συννμν bonn* is the maximum of pleasure with the minimum of pain. But true pleasure is not sensual enjoyment; it has its principle in the soul. It consists not in the possession of wealth or flocks and herds, but in good humour, in the just disposition and constant tranquillity of the soul. Hence the necessity of avoiding extremes; too much and too little are alike evils. True happiness consists in taking advantage of what one has and being content with it (see *ETHICS*).

BIBLIOGRAPHY.—Fragments edited by F. Mullach (1843) with commentary and in his *Fragmenta philosophorum Graecorum*, i. (1860). See also H. Ritter and L. Preller, *Historia philosophiae* (chap. i. *ad fin.*); P. Lafait (Lafaye), *Dissertation sur la philosophie atomistique* (1833); L. Liard, *De Democritio philosopho* (Paris, 1873); H. C. Liepmann, *Die Leucipp-Democritischen Atome* (Leipzig, 1886); F. A. Lange, *Geschichte des Materialismus* (Eng. trans. by E. C. Thomas, 1877); G. Hart, *Zur Seelen- und Erkenntnistheorie des Democritus* (Leipzig, 1886); P. Natorp, *Die Ethik des Demokritos* (Marburg, 1893); A. Dyroff, *Demokriststudien* (Leipzig, 1899); among general works C. A. Brandis, *Gesch. d. Entwickelungen d. griech. Philosophie* (Bonn, 1862-1864); Ed. Zeller, *Pre-Socratic Philosophy* (Eng. trans., London, 1881); for his theory of sense-perception see especially J. I. Beare, *Greek Theories of Elementary Cognition* (Oxford, 1906).

DEMOGEOT, JACQUES CLAUDE (1808-1894), French man of letters, was born in Paris on the 5th of July 1808. He was professor of rhetoric at the lycée Saint Louis, and subsequently assistant professor at the Sorbonne. He wrote many detached papers on various literary subjects, and two reports on secondary education in England and Scotland in collaboration with H. Montucci. His reputation rests on his excellent *Histoire de la littérature française depuis ses origines jusqu'à nos jours* (1851), which has passed through many subsequent editions. He was also the author of a *Tableau de la littérature française au XVII^e siècle* (1859), and of a work (3 vols., 1830-1883) on the influence of foreign literatures on the development of French literature. He died in Paris in 1894.

DEMOGRAPHY (from Gr. *δημος*, people, and *γραφειν*, to write), the science which deals with the statistics of health and

disease, of the physical, intellectual, physiological and economical aspects of births, marriages and mortality. The first to employ the word was Achille Guillard in his *Éléments de statistique humaine ou démographie comparée* (1855), but the meaning which he attached to it was merely that of the science which treats of the condition, general movement and progress of population in civilized countries, i.e. little more than what is comprised in the ordinary vital statistics, gleaned from census and registration reports. The word has come to have a much wider meaning and may now be defined as that branch of statistics which deals with the life-conditions of peoples.

DEMOIVRE, ABRAHAM (1667-1754), English mathematician of French extraction, was born at Vitry, in Champagne, on the 26th of May 1667. He belonged to a French Protestant family, and was compelled to take refuge in England at the revocation of the edict of Nantes, in 1685. Having laid the foundation of his mathematical studies in France, he prosecuted them further in London, where he read public lectures on natural philosophy for his support. The *Principia mathematica* of Sir Isaac Newton, which chance threw in his way, caused him to prosecute his studies with vigour, and he soon became distinguished among first-rate mathematicians. He was among the intimate personal friends of Newton, and his eminence and abilities secured his admission into the Royal Society of London in 1697, and afterwards into the Academies of Berlin and Paris. His merit was so well known and acknowledged by the Royal Society that they judged him a fit person to decide the famous contest between Newton and G. W. Leibnitz (see INFINITESIMAL CALCULUS). The life of Demoivre was quiet and uneventful. His old age was spent in obscure poverty, his friends and associates having nearly all passed away before him. He died at London, on the 27th of November 1754.

The *Philosophical Transactions* contain several of his papers. He also published some excellent works, such as *Miscellaneous analytical & trigonometrical* (1730), in 4to. This contained some elegant and valuable improvements on then existing methods, which have themselves, however, long been superseded. But he has been more generally known by his *Doctrine of Chances, or Method of Calculating the Probabilities of Events at Play*. This work was first printed in 1683, in 4to, and dedicated to Sir Isaac Newton. It was reprinted in 1731, with great alterations and improvements; and a third edition was afterwards published with additions in 1756. He also published a *Treatise on Asinities* (1725), which has passed through several revised and corrected editions.

See C. Hutton, *Mathematical and Philosophical Dictionary* (1815). For Demoivre's Theorem see TRIGONOMETRY: Analytical.

DEMONETIZATION, a term employed in monetary science in two different senses. (a) The depriving or divesting of a metal of its standard monetary value. From 1663 to 1717 silver was the standard of value in England and gold coins passed at their market value. The debasement and underrating of the silver coinage insensibly brought about the demonetization of silver in England as a standard of value and the substitution of gold. During the latter half of the 19th century, the tremendous depreciation of silver, owing to its continually increasing production, and consequently the impossibility of preserving any ratio of stability between it and gold, led to the abandonment or demonetization of the metal as a standard and to its use merely as token money. (b) The withdrawal of coin from circulation, as, for example, in England that of all pre-Victorian gold coins under the provisions of the Coinage Act 1889, and the royal proclamation of the 22nd of November 1890.

DEMONOLOGY (*Δαιμονία*, demon, genius, spirit), the branch of the science of religions which relates to superhuman beings which are not gods. It deals both with benevolent beings which have no circle of worshippers or so limited a circle as to be below the rank of gods, and with malevolent beings of all kinds. It may be noted that the original sense of "demon" was a benevolent being; but in English the name now connotes malevolence; in German it has a neutral sense, e.g. *Korndämonen*. Demons, when they are regarded as spirits, may belong to either of the classes of spirits recognized by primitive animism (*q.v.*); that is to say, they may be human, or non-human, separable souls, or incarnate spirits which have never inhabited a body; a sharp

distinction is often drawn between these two classes, notably by the Melanesians, the West Africans and others; the Arab *jinn*, for example, are not reducible to modified human souls; at the same time these classes are frequently conceived as producing identical results, e.g. diseases.

Under the head of demons are classified only such spirits as are believed to enter into relations with the human race; the term therefore includes (1) human souls regarded as genii or familiars, (2) such as receive a cult (for which see ANCESTOR WORSHIP), and (3) ghosts or other malevolent revenants; excluded are souls conceived as inhabiting another world. But just as gods are not necessarily spiritual, demons may also be regarded as corporeal; vampires for example are sometimes described as human heads with appended entrails, which issue from the tomb to attack the living during the night watches. The so-called Spectre Huntsman of the Malay Peninsula is said to be a man who scours the firmament with his dogs, vainly seeking for what he could not find on earth—a buck mouse-deer pregnant with male offspring; but he seems to be a living man; there is no statement that he ever died, nor yet that he is a spirit. The incubus and succubus of the middle ages are sometimes regarded as spiritual beings; but they were held to give very real proof of their bodily existence. It should, however, be remembered that primitive peoples do not distinguish clearly between material and immaterial beings.

Prevalence of Demons.—According to a conception of the world frequently found among peoples of the lower cultures, all the affairs of life are supposed to be under the control of spirits, each ruling a certain element or even object, and themselves in subjection to a greater spirit. Thus, the Eskimo are said to believe in spirits of the sea, earth and sky, the winds, the clouds and everything in nature. Every cove of the seashore, every point, every island and prominent rock has its guardian spirit. All are of the malignant type, to be propitiated only by acceptable offerings from persons who desire to visit the locality where it is supposed to reside. A rise in culture often results in an increase in the number of spiritual beings with whom man surrounds himself. Thus, the Koreans go far beyond the Eskimo and number their demons by thousands of billions; they fill the chimney, the shed, the living-room, the kitchen, they are on every shelf and jar; in thousands they waylay the traveller as he leaves his home, beside him, behind him, dancing in front of him, whirling over his head, crying out upon him from air, earth and water.

Especially complicated was the ancient Babylonian demonology; all the petty annoyances of life—a sudden fall, a headache, a quarrel—were set down to the agency of fiends; all the stronger emotions—love, hate, jealousy and so on—were regarded as the work of demons; in fact so numerous were they, that there were special fiends for various parts of the human body—one for the head, another for the neck, and so on. Similarly in Egypt at the present day the *jinn* are believed to swarm so thickly that it is necessary to ask their permission before pouring water on the ground, lest one should accidentally be soused and vent his anger on the offending human being. But these beliefs are far from being confined to the uncivilized; Greek philosophers like Porphyry, no less than the fathers of the Church, held that the world was pervaded with spirits; side by side with the belief in witchcraft, we can trace through the middle ages the survival of primitive animistic views; and in our own day even these beliefs subsist in unsuspected vigour among the peasantry of the more uneducated European countries. In fact the ready acceptance of spiritualism testifies to the force with which the primitive animistic way of looking at things appealed to the white races in the middle of the last century.

Character of Spiritual World.—The ascription of malevolence to the world of spirits is by no means universal. In West Africa the Mpongwe believe in local spirits, just as do the Eskimo; but they are regarded as inoffensive in the main; true, the passer-by must make some trifling offering as he nears their place of abode; but it is only occasionally that mischievous acts, such as the throwing down of a tree on a passer-by, are, in the view of the

natives, perpetuated by the Ombuiri. So too, many of the spirits especially concerned with the operations of nature are conceived as neutral or even benevolent; the European peasant fears the corn-spirit only when he irritates him by trenching on his domain and taking his property by cutting the corn; similarly, there is no reason why the more insignificant personages of the pantheon should be conceived as malevolent, and we find that the *Petara* of the Dyaks are far from indiscriminating and malignant, though disease and death are laid at their door.

Classification.—Besides the distinctions of human and non-human, hostile and friendly, the demons in which the lower races believe are classified by them according to function, each class with a distinctive name, with extraordinary minuteness, the list in the case of the Malays running to several scores. They have, for example, a demon of the waterfall, a demon of wild-beast tracks, a demon which interferes with snares for wild-fowl, a baboon demon, which takes possession of dancers and causes them to perform wonderful feats of climbing, &c. But it is impossible to do more than deal with a few types, which will illustrate the main features of the demonology of savage, barbarous and semi-civilized peoples.

(a) Natural causes, either of death or of disease, are hardly, if at all, recognized by the uncivilized; everything is attributed to spirits or magical influence of some sort. The spirits which cause disease may be human or non-human and their influence is shown in more than one way; they may enter the body of the victim (see POSSESSION), and either dominate his mind as well as his body, inflict specific diseases, or cause pains of various sorts. Thus the *Mintra* of the Malay Peninsula have a demon corresponding to every kind of disease known to them; the Tasmanian ascribed a gnawing pain to the presence within him of the soul of a dead man, whom he had unwittingly summoned by mentioning his name and who was devouring his liver; the Samoan held that the violation of a food tabu would result in the animal being formed within the body of the offender and cause his death. The demon theory of disease is still attested by some of our medical terms; epilepsy (Gr. *ἐπιληψία*, seizure) points to the belief that the patient is possessed. As a logical consequence of this view of disease the mode of treatment among peoples in the lower stages of culture is mainly magical; they endeavour to propitiate the evil spirits by sacrifice, to expel them by spells, &c. (see EXORCISM), to drive them away by blowing, &c.; conversely we find the Khonds attempt to keep away smallpox by placing thorns and brushwood in the paths leading to places decimated by that disease, in the hope of making the disease demon retrace his steps. This theory of disease disappeared sooner than did the belief in possession; the *energumens* (*ἑνεργούμενοι*) of the early Christian church, who were under the care of a special clerical order of exorcists, testify to a belief in possession; but the demon theory of disease receives no recognition; the *energumens* find their analogues in the converts of missionaries in China, Africa and elsewhere. Another way in which a demon is held to cause disease is by introducing itself into the patient's body and sucking his blood; the Malays believe that a woman who dies in childbirth becomes a *langswir* and sucks the blood of children; victims of the lycanthrope are sometimes said to be done to death in the same way; and it is commonly believed in Africa that the wizard has the power of killing people in this way, probably with the aid of a familiar.

(b) One of the primary meanings of *δαίμων* is that of genius or familiar, tutelary spirit; according to Hesiod the men of the golden race became after death guardians or watchers over mortals. The idea is found among the Romans also; they attributed to every man a genius who accompanied him through life. A Norse belief found in Iceland is that the *fyrlgia*, a genius in animal form, attends human beings; and these animal guardians may sometimes be seen fighting; in the same way the Siberian shamans send their animal familiars to do battle instead of deciding their quarrels in person. The animal guardian reappears in the *magual* of Central America (see article TOTEMISM), the *yumbesi* of some Australian tribes, the *manitou* of the Red Indian and the bush soul of some West African tribes;

among the latter the link between animal and human being is said to be established by the ceremony of the blood bond. Corresponding to the animal guardian of the ordinary man, we have the familiar of the witch or wizard. All the world over it is held that such people can assume the form of animals; sometimes the power of the shaman is held to depend on his being able to summon his familiar; among the Ostiaks the shaman's coat was covered with representations of birds and beasts; two bear's claws were on his hands; his wand was covered with mouse-skin; when he wished to divine he beat his drum till a black bird appeared and perched on his hut; then the shaman swooned, the bird vanished, and the divination could begin. Similarly the Greenland *angekok* is said to summon his *lorngak* (which may be an ancestral ghost or an animal) by drumming; he is heard by the bystanders to carry on a conversation and obtain advice as to how to treat diseases, the prospects of good weather and other matters of importance. The familiar, who is sometimes replaced by the devil, commonly figured in witchcraft trials; and a statute of James I. enacted that all persons invoking an evil spirit or consulting, covenanting with, entertaining, employing, feeding or rewarding any evil spirit should be guilty of felony and suffer death. In modern spiritualism the familiar is represented by the "guide," corresponding to which we have the theosophical "guru."

(c) The familiar is sometimes an ancestral spirit, and here we touch the fringe of the cult of the dead (see also ANCESTOR WORSHIP). Especially among the lower races the dead are regarded as hostile; the Australian avoids the grave even of a kinsman and elaborate ceremonies of mourning are found amongst most primitive peoples, whose object seems to be to rid the living of the danger they run by association with the ghost of the dead. Among the Zulu the spirits of the dead are held to be friendly or hostile, just as they were in life; on the Congo a man after death joins the good or bad spirits according as his life has been good or bad. Especially feared among many peoples are the souls of those who have committed suicide or died a violent death; the woman who dies in childbirth is held to become a demon of the most dangerous kind; even the unburied, as restless, dissatisfied spirits, are more feared than ordinary ghosts. Naturally spirits of these latter kinds are more valuable as familiars than ordinary dead men's souls. We find many recipes for securing their aid. In the Malay Peninsula the blood of a murdered man must be put in a bottle and prayers said over; after seven days of this worship a sound is heard and the operator puts his finger into the bottle for the polong, as the demon is called, to suck; it will fly through the air in the shape of an exceedingly diminutive female figure, and is always preceded by its pet, the pelesit, in the shape of a grasshopper. In Europe a similar demon is said to be obtainable from a cock's egg. In South Africa and India, on the other hand, the magician digs up a dead body, especially of a child, to secure a familiar. The evocation of spirits, especially in the form of necromancy, is an important branch of the demonology of many peoples; and the peculiarities of trance mediumship, which seem sufficiently established by modern research, go far to explain the vogue of this art. It seems to have been common among the Jews, and the case of the witch of Endor is narrated in a way to suggest something beyond fraud; in the book of magic which bears the name of Dr Faustus may be found many of the formulæ for raising demons; in England may be mentioned especially Dr Dee as one of the most famous of those who claimed before the days of modern spiritualism (*q.v.*) to have intercourse with the unseen world and to summon demons at his will. Sometimes the spirits were summoned to appear as did the phantoms of the Greek heroes to Odysseus; sometimes they were called to enter a crystal (see CRYSTAL-GAZING); sometimes they are merely asked to declare the future or communicate by moving external objects without taking a visible form; thus among the Karens at the close of the burial ceremonies the ghost of the dead man, which is said to hover round till the rites are completed, is believed to make a ring swing round and snap the string from which it hangs.

(d) The vampire is a particular form of demon which calls for

some notice. In the Malay Peninsula, parts of Polynesia, &c., it is conceived as a head with attached entrails, which issues, it may be from the grave, to suck the blood of living human beings. According to the Malays a *penanggalan* (vampire) is a living witch, and can be killed if she can be caught; she is especially feared in houses where a birth has taken place and it is the custom to hang up a bunch of thistle in order to catch her; she is said to keep vinegar at home to aid her in re-entering her own body. In Europe the Slavonic area is the principal seat of vampire beliefs, and here too we find, as a natural development, that means of preventing the dead from injuring the living have been evolved by the popular mind. The corpse of the vampire, which may often be recognized by its unnaturally ruddy and fresh appearance, should be staked down in the grave or its head should be cut off; it is interesting to note that the cutting off of heads of the dead was a neolithic burial rite.

(e) The vampire is frequently blended in popular idea with the *Pottergeist* (q.v.) or knocking spirit, and also with the werwolf (see LYCANTRÖPHY).

(f) As might be expected, dream demons are very common; in fact the word "nightmare" (A.S. *mar*, spirit, elf) preserves for us a record of this form of belief, which is found right down to the lowest planes of culture. The Australian, when he suffers from an oppression in his sleep, says that Koin is trying to throttle him; the Caribs say that Maboya beats them in their sleep; and the belief persists to this day in some parts of Europe; horses too are said to be subject to the persecutions of demons, which ride them at night. Another class of nocturnal demons are the incubi and succubi, who are said to consort with human beings in their sleep; in the Antilles these were the ghosts of the dead; in New Zealand likewise ancestral deities formed liaisons with females; in the Samoan Islands the inferior gods were regarded as the fathers of children otherwise unaccounted for; the Hindus have rites prescribed by which a companion nymph may be secured. The question of the real existence of incubi and succubi, whom the Romans identified with the fauns, was gravely discussed by the fathers of the church; and in 1418 Innocent VIII. set forth the doctrine of lecherous demons as an indisputable fact; and in the history of the Inquisition and of trials for witchcraft may be found the confessions of many who bore witness to their reality. In the *Anatomy of Melancholy* Burton assures us that they were never more numerous than in A.D. 1600.

(g) Corresponding to the personal tutelary spirit (*supra*, b) we have the genii of buildings and places. The Romans celebrated the birthday of a town and of its genius, just as they celebrated that of a man; and a snake was a frequent form for this kind of demon; when we compare with this the South African belief that the snakes which are in the neighbourhood of the kraal are the incarnations of the ancestors of the residents, it seems probable that some similar idea lay at the bottom of the Roman belief; to this day in European folklore the house snake or toad, which lives in the cellar, is regarded as the "life index" or other self of the father of the house; the death of one involves the death of the other, according to popular belief. The assignment of genii to buildings and gates is connected with an important class of sacrifices; in order to provide a tutelary spirit, or to appease chthonic deities, it was often the custom to sacrifice a human being or an animal at the foundation of a building; sometimes we find a similar guardian provided for the frontier of a country or of a tribe. The house spirit is, however, not necessarily connected with this idea. In Russia the *domovoi* (house spirit) is an important personage in folk-belief; he may object to certain kinds of animals, or to certain colours in cattle; and must, generally speaking, be propitiated and cared for. Corresponding to him we have the drudging goblin of English folklore.

(h) It has been shown above how the animistic creed postulates the existence of all kinds of local spirits, which are sometimes tied to their habitats, sometimes free to wander. Especially prominent in Europe, classical, medieval and modern, and in East Asia, is the spirit of the lake, river, spring, or well, often conceived as human, but also in the form of a bull or horse; the term Old Nick may refer to the water-horse Nök. Less specialized

in their functions are many of the figures of modern folklore, some of whom have perhaps replaced some ancient goddesses, e.g. Frau Holda, others, like the Welsh Pwck, the Lancashire boggarts or the more widely found Jack-o'-Lantern (Will o' the Wisp), are sprites who do no more harm than leading the wanderer astray. The banshee is perhaps connected with ancestral or house spirits; the Wild Huntman, the Gabriel hounds, the Seven Whistlers, &c., are traceable to some actual phenomenon; but the great mass of British goblinhood cannot now be traced back to savage or barbarous analogues. Among other local sprites may be mentioned the kobolds or spirits of the mines. The fairies (see FAIRY), located in the fairy knolls by the inhabitants of the Shetlands, may also be put under this head.

(i) The subject of plant souls is referred to in connexion with animism (q.v.); but certain aspects of this phase of belief demand more detailed treatment. Outside the European area vegetation spirits of all kinds seem to be conceived, as a rule, as anthropomorphic; in classical Europe, and parts of the Slavonic area at the present day, the tree spirit was believed to have the form of a goat, or to have goats' feet.

Of special importance in Europe is the conception of the so-called "corn spirit"; W. Mannhardt collected a mass of information proving that the life of the corn is supposed to exist apart from the corn itself and to take the form, sometimes of an animal, sometimes of a man or woman, sometimes of a child. There is, however, no proof that the belief is animistic in the proper sense. The animal which popular belief identified with the corn demon is sometimes killed in the spring in order to mingle its blood or bones with the seed; at harvest-time it is supposed to sit in the last corn and the animals driven out from it are sometimes killed; at others the reaper who cuts the last ear is said to have killed the "wolf" or the "dog," and sometimes receives the name of "wolf" or "dog" and retains it till the next harvest. The corn spirit is also said to be hiding in the barn till the corn is threshed, or it may be said to reappear at midwinter, when the farmer begins to think of his new year of labour and harvest. Side by side with the conception of the corn spirit as an animal is the anthropomorphic view of it; and this element must have predominated in the evolution of the cereal deities like Demeter; at the same time traces of the association of gods and goddesses of corn with animal embodiments of the corn spirit are found.

(j) In many parts of the world, and especially in Africa, is found the conception termed the "otiose creator"; that is to say, the belief in a great deity, who is the author of all that exists but is too remote from the world and too high above terrestrial things to concern himself with the details of the universe. As a natural result of this belief we find the view that the operations of nature are conducted by a multitude of more or less obedient subordinate deities; thus, in Portuguese West Africa the Kimbunda believe in Suku-Vakange, but hold that he has committed the government of the universe to innumerable *killets* good and bad; the latter kind are held to be far more numerous, but Suku-Vakange is said to keep them in order by occasionally smiting them with his thunderbolts; were it not for this, man's lot would be insupportable.

Sometimes the gods of an older religion degenerate into the demons of the belief which supersedes it. A conspicuous example of this is found in the attitude of the Hebrew prophets to the gods of the nations, whose power they recognize without admitting their claim to reverence and sacrifice. The same tendency is seen in many early missionary works and is far from being without influence even at the present day. In the folklore of European countries goblinhood is peopled by gods and nature-spirits of an earlier heathendom. We may also compare the Persian *devs* with the Indian *devas*.

Expulsion of Demons.—In connexion with demonology mention must be made of the custom of expelling ghosts, spirits or evils generally. Primitive peoples from the Australians upwards celebrate, usually at fixed intervals, a driving out of hurtful influences. Sometimes, as among the Australians, it is merely the ghosts of those who have died in the year which are thus

driven out; from this custom must be distinguished another, which consists in dismissing the souls of the dead at the close of the year and sending them on their journey to the other world; this latter custom seems to have an entirely different origin and to be due to love and not fear of the dead. In other cases it is believed that evil spirits generally or even non-personal evils such as sins are believed to be expelled. In these customs originated perhaps the scapegoat, some forms of sacrifice (*q.v.*) and other cathartic ceremonies.

BIBLIOGRAPHY.—Tylor, *Primitive Culture*. Frazer, *Golden Bough*; Skeat, *Malay Magic*; Bastian, *Der Mensch in der Geschichte*; Callaway, *Religion of the Amasulu*; Hild, *Étude sur les démons*; Welcker, *Religionsgeschichte*, i. 731. *Trans. Am. Phil. Soc.* xxvi. 79; Calmet, *Dissertation sur les esprits*; Maury, *La Magie*; L. W. King, *Babylonian Magic*; Lenormant, *La Magie chez les Chaldéens*; R. C. Thompson, *Demis and Evil Spirits of Babylonia*; Grimm, *Deutsche Mythologie*; Roskoff, *Geschichte des Teufels*; Sibly, *Illustration of the Occult Sciences*; Scott, *Demonology*; Pitcairn, *Scottish Criminal Trials*; Jewish Quarterly Rev. viii. 576, &c.; Horst, *Zauberbibliothek*; Jewish Encyclopedia, s.v. "Demonology." See also bibliography to POSSESSION, ANIMISM and other articles. (N. W. T.)

DE MORGAN, AUGUSTUS (1806-1871), English mathematician and logician, was born in June 1806, at Madura, in the Madras presidency. His father, Colonel John De Morgan, was employed in the East India Company's service, and his grandfather and great-grandfather had served under Warren Hastings. On the mother's side he was descended from James Dodson, F.R.S., author of the *Anti-logarithmic Canon* and other mathematical works of merit, and a friend of Abraham Demoivre. Seven months after the birth of Augustus, Colonel De Morgan brought his wife, daughter and infant son to England, where he left them during a subsequent period of service in India, dying in 1816 on his way home.

Augustus De Morgan received his early education in several private schools, and before the age of fourteen years had learned Latin, Greek and some Hebrew, in addition to acquiring much general knowledge. At the age of sixteen years and a half he entered Trinity College, Cambridge, and studied mathematics, partly under the tuition of Sir G. B. Airy. In 1825 he gained a Trinity scholarship. De Morgan's love of wide reading somewhat interfered with his success in the mathematical tripos, in which he took the fourth place in 1827. He was prevented from taking his M.A. degree, or from obtaining a fellowship, by his conscientious objection to signing the theological tests then required from masters of arts and fellows at Cambridge.

A career in his own university being closed against him, he entered Lincoln's Inn; but had hardly done so when the establishment, in 1828, of the university of London, in Gower Street, afterwards known as University College, gave him an opportunity of continuing his mathematical pursuits. At the early age of twenty-two he gave his first lecture as professor of mathematics in the college which he served with the utmost zeal and success for a third of a century. His connexion with the college, indeed, was interrupted in 1831, when a disagreement with the governing body caused De Morgan and some other professors to resign their chairs simultaneously. When, in 1836, his successor was accidentally drowned, De Morgan was requested to resume the professorship.

In 1837 he married Sophia Elizabeth, daughter of William Friend, a Unitarian in faith, a mathematician and actuary in occupation, a notice of whose life, written by his son-in-law, will be found in the *Monthly Notices of the Royal Astronomical Society* (vol. v.). They settled in Chelsea (30 Cheyne Row), where in later years Mrs De Morgan had a large circle of intellectual and artistic friends.

As a teacher of mathematics De Morgan was unrivalled. He gave instruction in the form of continuous lectures delivered extempore from brief notes. The most prolonged mathematical reasoning, and the most intricate formulæ, were given with almost infallible accuracy from the resources of his extraordinary memory. De Morgan's writings, however excellent, give little idea of the perspicuity and elegance of his viva voce expositions, which never failed to fix the attention of all who were worthy

of hearing him. Many of his pupils have distinguished themselves, and, through Isaac Todhunter and E. J. Routh, he had an important influence on the later Cambridge school. For thirty years he took an active part in the business of the Royal Astronomical Society, editing its publications, supplying obituary notices of members, and for eighteen years acting as one of the honorary secretaries. He was also frequently employed as consulting actuary, a business in which his mathematical powers, combined with sound judgment and business-like habits, fitted him to take the highest place.

De Morgan's mathematical writings contributed powerfully towards the progress of the science. His memoirs on the "Foundation of Algebra," in the 7th and 8th volumes of the *Cambridge Philosophical Transactions*, contain some of the most important contributions which have been made to the philosophy of mathematical method; and Sir W. Rowan Hamilton, in the preface to his *Lectures on Quaternions*, refers more than once to those papers as having led and encouraged him in the working out of the new system of quaternions. The work on *Trigonometry and Double Algebra* (1849) contains in the latter part a most luminous and philosophical view of existing and possible systems of symbolic calculus. But De Morgan's influence on mathematical science in England can only be estimated by a review of his long series of publications, which commence, in 1828, with a translation of part of Bourdon's *Elements of Algebra*, prepared for his students. In 1830 appeared the first edition of his well-known *Elements of Arithmetic*, which did much to raise the character of elementary training. It is distinguished by a simple yet thoroughly philosophical treatment of the ideas of number and magnitude, as well as by the introduction of new abbreviated processes of computation, to which De Morgan always attributed much practical importance. Second and third editions were called for in 1832 and 1835; a sixth edition was issued in 1876. De Morgan's other principal mathematical works were *The Elements of Algebra* (1835), a valuable but somewhat dry elementary treatise; *the Essay on Probabilities* (1838), forming the 107th volume of *Lardner's Cyclopaedia*, which forms a valuable introduction to the subject; and *The Elements of Trigonometry and Trigonometrical Analysis, preliminary to the Differential Calculus* (1837). Several of his mathematical works were published by the Society for the Diffusion of Useful Knowledge, of which De Morgan was at one time an active member. Among these may be mentioned the *Treatise on the Differential and Integral Calculus* (1842); the *Elementary Illustrations of the Differential and Integral Calculus*, first published in 1832, but often bound up with the larger treatise; the essay, *On the Study and Difficulties of Mathematics* (1831); and a brief treatise on *Spherical Trigonometry* (1834). By some accident the work on probability in the same series, written by Sir J. W. Lubbock and J. Drinkwater-Bethune, was attributed to De Morgan, an error which seriously annoyed his nice sense of bibliographical accuracy. For fifteen years he did all in his power to correct the mistake, and finally wrote to *The Times* to disclaim the authorship. (See *Monthly Notices of the Royal Astronomical Society*, vol. xvii. p. 118.) Two of his most elaborate treatises are to be found in the *Encyclopaedia metropolitana*, namely the articles on the Calculus of Functions, and the Theory of Probabilities. De Morgan's minor mathematical writings were scattered over various periodicals. A list of these and other papers will be found in the *Royal Society's Catalogue*, which contains forty-two entries under the name of De Morgan.

In spite, however, of the excellence and extent of his mathematical writings, it is probably as a logical reformer that De Morgan will be best remembered. In this respect he stands alongside of his great contemporaries Sir W. R. Hamilton and George Boole, as one of several independent discoverers of the all-important principle of the quantification of the predicate. Unlike most mathematicians, De Morgan always laid much stress upon the importance of logical training. In his admirable papers upon the modes of teaching arithmetic and geometry, originally published in the *Quarterly Journal of Education* (reprinted in *The Schoolmaster*, vol. ii.), he remonstrated against the neglect of

logical doctrine. In 1839 he produced a small work called *First Notions of Logic*, giving what he had found by experience to be much wanted by students commencing with *Euclid*. In October 1846 he completed the first of his investigations, in the form of a paper printed in the *Transactions of the Cambridge Philosophical Society* (vol. viii. No. 29). In this paper the principle of the quantified predicate was referred to, and there immediately ensued a memorable controversy with Sir W. R. Hamilton regarding the independence of De Morgan's discovery, some communications having passed between them in the autumn of 1846. The details of this dispute will be found in the original pamphlets, in the *Athenaeum* and in the appendix to De Morgan's *Formal Logic*. Suffice it to say that the independence of De Morgan's discovery was subsequently recognized by Hamilton. The eight forms of proposition adopted by De Morgan as the basis of his system partially differ from those which Hamilton derived from the quantified predicate. The general character of De Morgan's development of logical forms was wholly peculiar and original on his part.

Late in 1847 De Morgan published his principal logical treatise, called *Formal Logic, or the Calculus of Inference, Necessary and Probable*. This contains a reprint of the *First Notions*, an elaborate development of his doctrine of the syllogism, and of the numerical definite syllogism, together with chapters of great interest on probability, induction, old logical terms and fallacies. The severity of the treatise is relieved by characteristic touches of humour, and by quaint anecdotes and allusions furnished from his wide reading and perfect memory. There followed at intervals, in the years 1850, 1858, 1860 and 1863, a series of four elaborate memoirs on the "Syllogism," printed in volumes ix. and x. of the *Cambridge Philosophical Transactions*. These papers taken together constitute a great treatise on logic, in which he substituted improved systems of notation, and developed a new logic of relations, and a new onymatic system of logical expression. In 1860 De Morgan endeavoured to render their contents better known by publishing a *Syllabus of a Proposed System of Logic*, from which may be obtained a good idea of his symbolic system, but the more readable and interesting discussions contained in the memoirs are of necessity omitted. The article "Logic" in the *English Cyclopaedia* (1860) completes the list of his logical publications.

Throughout his logical writings De Morgan was led by the idea that the followers of the two great branches of exact science, logic and mathematics, had made blunders,—the logicians in neglecting mathematics, and the mathematicians in neglecting logic. He endeavoured to reconcile them, and in the attempt showed how many errors an acute mathematician could detect in logical writings, and how large a field there was for discovery. But it may be doubted whether De Morgan's own system, "horrent with mysterious spiculae," as Hamilton aptly described it, is fitted to exhibit the real analogy between quantitative and qualitative reasoning, which is rather to be sought in the logical works of Boole.

Perhaps the largest part, in volume, of De Morgan's writings remains still to be briefly mentioned; it consists of detached articles contributed to various periodical or composite works. During the years 1833-1843 he contributed very largely to the first edition of the *Penny Cyclopaedia*, writing chiefly on mathematics, astronomy, physics and biography. His articles of various length cannot be less in number than 850, and they have been estimated to constitute a sixth part of the whole *Cyclopaedia*, of which they formed perhaps the most valuable portion. He also wrote biographies of Sir Isaac Newton and Edmund Halley for Knight's *British Worthies*, various notices of scientific men for the *Gallery of Portraits*, and for the uncompleted *Biographical Dictionary of the Useful Knowledge Society*, and at least seven articles in Smith's *Dictionary of Greek and Roman Biography*. Some of De Morgan's most interesting and useful minor writings are to be found in the *Companions to the British Almanac*, to which he contributed without fail one article each year from 1831 up to 1857 inclusive. In these carefully written papers he treats a great variety of topics relating to astronomy, chronology, decimal coinage, life assurance, bibliography and the history of science. Most of them are as valuable now as when written.

Among De Morgan's miscellaneous writings may be mentioned his *Explanation of the Gaemonic Projection of the Sphere*, 1836, including a description of the maps of the stars, published by the Useful Know-

ledge Society; his *Treatise on the Globes, Celestial and Terrestrial*, 1845, and his remarkable *Book of Almanacs* (2nd edition, 1871), which contains a series of thirty-five almanacs, so arranged with indices of reference, that the almanac for any year, whether in old style or new, from any epoch, ancient or modern, up to A. D. 2000, may be found without difficulty, means being added for verifying the almanac and also for discovering the days of new and full moon from 2000 B. C. up to A. D. 2000. De Morgan expressly draws attention to the fact that the plan of this book was that of L. B. Francoeur and J. Ferguson, but the plan was developed by one who was an unrivalled master of all the intricacies of chronology. The two best tables of logarithms, the small five-figure tables of the *Useful Knowledge Society* (1839 and 1857), and Shroton's *Seven Figure Table* (5th ed., 1865), were printed under De Morgan's superintendence. Several works, edited by him will be found mentioned in the *British Museum Catalogue*. He made numerous anonymous contributions through a long series of years to the *Athenaeum*, and to *Notes and Queries*, and occasionally to *The North British Review*, *Macmillan's Magazine*, &c.

Considerable labour was spent by De Morgan upon the subject of decimal coinage. He was a great advocate of the pound and mil scheme. His evidence on this subject was sought by the Royal Commission, and, besides constantly supporting the Decimal Association in periodical publications, he published several separate pamphlets on the subject.

One marked characteristic of De Morgan was his intense and yet reasonable love of books. He was a true bibliophile and loved to surround himself, as far as his means allowed, with curious and rare books. He revelled in all the mysteries of watermarks, title-pages, colophons, catch-words and the like; yet he treated bibliography as an important science. As he himself wrote, "the most worthless book of a bygone day is a record worthy of preservation; like a telescopic star, its obscurity may render it unavailable for most purposes; but it serves, in hands which know how to use it, to determine the places of more important bodies." His evidence before the Royal Commission on the British Museum in 1850 (Questions 5704^a-5815^a, 6481-6513, and 8966-8967), should be studied by all who would comprehend the principles of bibliography or the art of constructing a catalogue, his views on the latter subject corresponding with those carried out by Panizzi in the *British Museum Catalogue*. A sample of De Morgan's bibliographical learning is to be found in his account of *Aritmetical Books, from the Invention of Printing* (1847), and finally in his *Budget of Paradoxes*. This latter work consists of articles most of which were originally published in the *Athenaeum*, describing the various attempts which have been made to invent a perpetual motion, to square the circle, or to trisect the angle; but De Morgan took the opportunity to include many curious bits gathered from his extensive reading, so that the *Budget*, as reprinted by his widow (1872), with much additional matter prepared by himself, forms a remarkable collection of scientific *ana*. De Morgan's correspondence with contemporary scientific men was very extensive and full of interest. It remains unpublished, as does also a large mass of mathematical tracts which he prepared for the use of his students, treating all parts of mathematical science, and embodying some of the matter of his lectures. De Morgan's library was purchased by Lord Overstone, and presented to the university of London.

In 1866 his life became clouded by the circumstances which led him to abandon the institution so long the scene of his labours. The refusal of the council to accept the recommendation of the senate, that they should appoint an eminent Unitarian minister to the professorship of logic and mental philosophy, revived all De Morgan's sensitiveness on the subject of sectarian freedom; and, though his feelings were doubtless excessive, there is no doubt that gloom was thrown over his life, intensified in 1867 by the loss of his son George Campbell De Morgan, a young man of the highest scientific promise, whose name, as De Morgan expressly wished, will long be connected with the London Mathematical Society, of which he was one of the founders. From this time De Morgan rapidly fell into ill-health, previously almost unknown to him, dying on the 18th of March 1871. An interesting and truthful sketch of his life will be found in the *Monthly Notices of the Royal Astronomical Society* for the 9th of February 1872, vol. xxii. p. 112, written by A. C. Ranyard, who says, "He was the kindest, as well as the most learned of men—benignant to every one who approached him, never forgetting the claims which weakness has on strength."

De Morgan left no published indications of his opinions on religious questions, in regard to which he was extremely reticent. He seldom or never entered a place of worship, and declared that he could not listen to a sermon, a circumstance perhaps due to the extremely strict religious discipline under which he was brought up. Nevertheless there is reason to believe that he

was of a deeply religious disposition. Like M. Faraday and Sir I. Newton he entertained a confident belief in Providence, founded not on any tenuous inference, but on personal feeling. His hope of a future life also was vivid to the last.

It is impossible to omit a reference to his witty sayings, some specimens of which are preserved in Dr Sadler's most interesting *Diary of Henry Crabb Robinson* (1869), which also contains a humorous account of H. C. R. by De Morgan. It may be added that De Morgan was a great reader and admirer of Dickens; he was also fond of music, and a fair performer on the flute. (W. S. J.)

His son, WILLIAM FRENCH DE MORGAN (b. 1839), first became known in artistic circles as a potter, the "De Morgan" tiles being remarkable for his rediscovery of the secret of some beautiful colours and glazes. But later in life he became even better known to the literary world by his novels, *Joseph Vance* (1906), *Alice for Short* (1907), *Somehow Good* (1908) and *It Never Can Happen Again* (1909), in which the influence of Dickens and of his own earlier family life were conspicuous.

DEMOSTHENES, the great Attic orator and statesman, was born in 384 (or 383) B.C. His father, who bore the same name, was an Athenian citizen belonging to the deme of Paeania. His mother, Cleobule, was the daughter of Gylon, a citizen who had been active in procuring the protection of the kings of Bosphorus for the Athenian colony of Nymphaeum in the Crimea, and whose wife was a native of that region. On these grounds the adversaries of Demosthenes, in after-days, used absurdly to taunt him with a traitorous or barbarian ancestry. The boy had a bitter foretaste of life. He was seven years old when his father died, leaving property (in a manufactory of swords, and another of upholstery) worth about £3000, which, invested as it seems to have been (20% was not thought exorbitant), would have yielded rather more than £600 a year. £300 a year was a very comfortable income at Athens, and it was possible to live decently on a tenth of it. Nicias, a very rich man, had property equivalent, probably, to not more than £4000 a year. Demosthenes was born then, to a handsome, though not a great fortune. But his guardians—two nephews of his father, Aphobus and Demophon, and one Therippides—abused their trust, and handed over to Demosthenes, when he came of age, rather less than one-seventh of his patrimony, perhaps between £50 and £60 a year. Demosthenes, after studying with Isaeus (*q.v.*)—then the great master of forensic eloquence and of Attic law, especially in will cases—brought an action against Aphobus, and gained a verdict for about £2400. But it does not appear that he got the money; and, after some more fruitless proceedings against Oneter, the brother-in-law of Aphobus, the matter was dropped,—not, however, before his relatives had managed to throw a public burden (the equipment of a ship of war) on their late ward, whereby his resources were yet further straitened. He now became a professional writer of speeches or pleas (*λογογράφος*) for the law courts, sometimes speaking himself. Biographers have delighted to relate how painfully Demosthenes made himself a tolerable speaker,—how, with pebbles in his mouth, he tried his lungs against the waves, how he declaimed as he ran up hill, how he shut himself up in a cell, having first guarded himself against a longing for the haunts of men by shaving one side of his head, how he wrote out Thucydides eight times, how he was derided by the Assembly and encouraged by a judicious actor who met him moping about the Peiræus. He certainly seems to have been the reverse of athletic (the stalwart Aeschines upbraids him with never having been a sportsman), and he probably had some sort of defect or impediment in his speech as a boy. Perhaps the most interesting fact about his work for the law courts is that he seems to have continued it, in some measure, through the most exciting parts of his great political career. The speech for Phormio belongs to the same year as the plea for Megalopolis. The speech against Boeotus "Concerning the Name" comes between the First Philippic and the First Olynthiac. The speech against Pantaenetus comes between the speech "On the Peace" and the Second Philippic.

¹ See Jebb's *Attic Orators from Antiphon to Isaeus*, vol. ii. p. 267 f.

The political career of Demosthenes, from his first direct contact with public affairs in 355 B.C. to his death in 322, has an essential unity. It is the assertion, in successive forms adapted to successive moments, of unchanging Political career and creed. principles. Externally, it is divided into the chapter which precedes and the chapter which follows Chaeronea. But its inner meaning, the secret of its indomitable vigour, the law which harmonizes its apparent contrasts, cannot be understood unless it is regarded as a whole. Still less can it be appreciated in all its large wisdom and sustained self-mastery if it is viewed merely as a duel between the ablest champion and the craftiest enemy of Greek freedom. The time indeed came when Demosthenes and Philip stood face to face as representative antagonists in a mortal conflict. But, for Demosthenes, the special peril represented by Philip, the peril of subjugation to Macedonia, was merely a disastrous accident. Philip happened to become the most prominent and most formidable type of a danger which was already threatening Greece before his baleful star arose. As Demosthenes said to the Athenians, if the Macedonian had not existed, they would have made another Philip for themselves. Until Athens recovered something of its old spirit, there must ever be a great standing danger, not for Athens only, but for Greece,—the danger that sooner or later, in some shape, from some quarter—no man could foretell the hour, the manner or the source—barbarian violence would break up the gracious and undefiled tradition of separate Hellenic life.

What was the true relation of Athens to Greece? The answer which he gave to this question is the key to the life of Demosthenes. Athens, so Demosthenes held, was the natural head of Greece. Not, however, as an empress holding subject or subordinate cities in a dependence more or less compulsory. Rather as that city which most nobly expressed the noblest attributes of Greek political existence, and which, by her pre-eminent gifts both of intellect and of moral insight, was primarily responsible, everywhere and always, for the maintenance of those attributes in their integrity. Wherever the cry of the oppressed goes up from Greek against Greek, it was the voice of Athens which should first remind the oppressor that Hellene differed from barbarian in postponing the use of force to the persuasions of equal law. Wherever a barbarian hand offered wrong to any city of the Hellenic sisterhood, it was the arm of Athens which should first be stretched forth in the holy strength of Apollo the Averter. Wherever among her own children the ancient loyalty was yielding to love of pleasure or of base gain, there, above all, it was the duty of Athens to see that the central hearth of Hellas was kept pure. Athens must never again seek "empire" in the sense which became odious under the influence of Cleon and Hyperbolus,—when, to use the image of Aristophanes, the allies were as Babylonian slaves grinding in the Athenian mill. Athens must never permit, if she could help it, the re-establishment of such a domination as Sparta exercised in Greece from the battle of Aegospotami to the battle of Leuctra. Athens must aim at leading a free confederacy, of which the members should be bound to her by their own truest interests. Athens must seek to deserve the confidence of all Greeks alike.

Such, in the belief of Demosthenes, was the part which Athens must perform if Greece was to be safe. But reforms must be effected before Athens could be capable of such a part. The evils to be cured were different phases of one malady. Athens had long been suffering from the profound decay of public spirit. Since the early years of the Peloponnesian War, the separation of Athenian society from the state had been growing more and more marked. The old type of the eminent citizen, who was at once statesman and general, had become almost extinct. Politics were now managed by a small circle of politicians. Wars were conducted by professional soldiers whose troops were chiefly mercenaries, and who were usually regarded by the politicians either as instruments or as enemies. The mass of the citizens took no active interest in public affairs. But, Theoretic hand. though indifferent to principles, they had quickly sensitive partialities for men, and it was necessary to keep them in good humour. Pericles had introduced the practice of giving a

small bounty from the treasury to the poorer citizens, for the purpose of enabling them to attend the theatre at the great festivals, —in other words, for the purpose of bringing them under the concentrated influence of the best Attic culture. A provision eminently wise for the age of Pericles easily became a mischief when the once honourable name of "demagogue" began to mean a flatterer of the mob. Before the end of the Peloponnesian War the festival-money (*theoricon*) was abolished. A few years after the restoration of the democracy it was again introduced. But until 354 B.C. it had never been more than a gratuity, of which the payment depended on the treasury having a surplus. In 354 B.C. Eubulus became steward of the treasury. He was an able man, with a special talent for finance, free from all taint of personal corruption, and sincerely solicitous for the honour of Athens, but enslaved to popularity, and without principles of policy. His first measure was to make the festival-money a permanent item in the budget. Thenceforth this bounty was in reality very much what Demades afterwards called it,—the cement (*κόλλα*) of the democracy.

Years before the danger from Macedon was urgent, Demosthenes had begun the work of his life,—the effort to lift the spirit of Athens, to revive the old civic loyalty, to rouse the city into taking that place and performing that part which her own welfare as well as the safety of Greece prescribed. His formally political speeches must never be considered apart from his forensic speeches in public causes. The Athenian procedure against the proposer of an unconstitutional law—*i.e.* of a law incompatible with existing laws—had a direct tendency to make the law court, in such cases, a political arena. The same tendency was indirectly exerted by the tolerance of Athenian juries (in the absence of a presiding expert like a judge) for irrelevant matter, since it was usually easy for a speaker to make capital out of the adversary's political antecedents. But the forensic speeches of Demosthenes for public causes are not only political in this general sense. They are documents, as indispensable as the Olynthiacs or Philippics, for his own political career. Only by taking them along with the formally political speeches, and regarding the whole as one unbroken series, can we see clearly the full scope of the task which he set before him,—a task in which his long resistance to Philip was only the most dramatic incident, and in which his real achievement is not to be measured by the event of Chæronæa.

A forensic speech, composed for a public cause, opens the political career of Demosthenes with a protest against a signal abuse. In 355 B.C., at the age of twenty-nine, he wrote the speech "Against Androtion." This combats on legal grounds a proposal that the out-going senate should receive the honour of a golden crown. In its larger aspect, it is a denunciation of the corrupt system which that senate represented, and especially of the manner in which the treasury had been administered by Anstophon. In 354 B.C. Demosthenes composed and spoke the oration "Against Leptines," who had effected a slender saving for the state by the expedient of revoking those hereditary exemptions from taxation which had at various times been conferred in recognition of distinguished merit. The descendants of Harmodius and Aristogeiton alone had been excepted from the operation of the law. This was the first time that the voice of Demosthenes himself had been heard on the public concerns of Athens, and the utterance was a worthy prelude to the career of a statesman. He answers the advocates of the retrenchment by pointing out that the public interest will not ultimately be served by a wholesale violation of the public faith. In the same year he delivered his first strictly political speech, "On the Navy Boards" (*Symmories*). The Athenians, irritated by the support which Artaxerxes had lately given to the revolt of their allies, and excited by rumours of his hostile preparations, were feverishly eager for a war with Persia. Demosthenes urges that such an enterprise would at present be useless; that it would fail to unite Greece; that the energies of the city should be reserved for a real emergency; but that, before the city can successfully cope with any war, there must be a better organization of resources, and,

first of all, a reform of the navy, which he outlines with characteristic lucidity and precision.

Two years later (352 B.C.) he is found dealing with a more definite question of foreign policy. Sparta, favoured by the depression of Thebes in the Phocian War, was threatening Megalopolis. Both Sparta and Megalopolis sent embassies to Athens. Demosthenes supported Megalopolis. The ruin of Megalopolis would mean, he argued, the return of Spartan domination in the Peloponnesus. Athenians must not favour the tyranny of any one city. They must respect the rights of all the cities, and thus promote unity based on mutual confidence. In the same year Demosthenes wrote the speech "Against Timocrates," to be spoken by the same Diodorus who had before prosecuted Androtion, and who now combated an attempt to screen Androtion and others from the penalties of embezzlement. The speech "Against Aristocrates," also of 352 B.C., reproves that foreign policy of feeble makeshifts which was now popular at Athens. The Athenian tenure of the Thracian Chersonese partly depended for its security on the good-will of the Thracian prince Cersobleptes. Charidemus, a soldier of fortune who had already played Athens false, was now the brother-in-law and the favourite of Cersobleptes. Aristocrates proposed that the person of Charidemus should be invested with a special sanctity, by the enactment that whoever attempted his life should be an outlaw from all dominions of Athens. Demosthenes points out that such adulation is as futile as it is fulsome. Athens can secure the permanence of her foreign possessions only in one way—by being strong enough to hold them.

Thus, between 355 and 352, Demosthenes had laid down the main lines of his policy. Domestic administration must be purified. Statesmen must be made to feel that they are responsible to the state. They must not be allowed to anticipate judgment on their deserts by voting each other golden crowns. They must not think to screen misappropriation of public money by getting partisans to pass new laws about state-debtors. Foreign policy must be guided by a larger and more provident conception of Athenian interests. When public excitement demands a foreign war, Athens must not rush into it without asking whether it is necessary, whether it will have Greek support, and whether she herself is ready for it. When a strong Greek city threatens a weak one, and seeks to purchase Athenian connivance with the bribe of a border-town, Athens must remember that duty and prudence alike command her to respect the independence of all Greeks. When it is proposed, by way of insurance on Athenian possessions abroad, to flatter the favourite of a doubtful ally, Athens must remember that such devices will not avail a power which has no army except on paper, and no ships fit to leave their moorings.

But the time had gone by when Athenians could have tranquil leisure for domestic reform. A danger, calling for prompt action, had at last come very near. For six years Athens had been at war with Philip on account of his seizure of Amphipolis. Meanwhile he had destroyed Potidaea and founded Philippi. On the Thracian coasts he had become master of Abdera and Maronea. On the Thessalian coast he had acquired Methone. In a second invasion of Thessaly, he had overthrown the Phocians under Onomarchus, and had advanced to Thermopylae, to find the gates of Greece closed against him by an Athenian force. He had then marched to Heraeon on the Propontis, and had dictated a peace to Cersobleptes. He had formed an alliance with Cardia, Perinthus and Byzantium. Lastly, he had begun to show designs on the great Confederacy of Olynthus, the more warlike Miletus of the North. The First Philippic of Demosthenes was spoken in 351 B.C. The Third Philippic—the latest of the extant political speeches—was spoken in 341 B.C. Between these he delivered eight political orations, of which seven are directly concerned with Philip. The whole series falls into two great divisions. The first division comprises those speeches which were spoken against Philip while he was still a foreign power threatening Greece from without. Such are the First Philippic and the three orations for Olynthus. The second division comprises the speeches

Forensic speeches in Public Causes.

Principles of Policy.

Athens and Philip.

spoken against Philip when, by admission to the Amphictyonic Council, he had now won his way within the circle of the Greek states, and when the issue was no longer between Greece and Macedonia, but between the Greek and Macedonian parties in Greece. Such are the speech "On the Peace," the speech "On the Embassy," the speech "On the Chersonese," the Second and Third Philippics.

The First Philippic, spoken early in 351 B.C., was no sudden note of alarm drawing attention to an unnoticed peril. On the contrary, the Assembly was weary of the subject. For six years the war with Philip had been a theme of barren talk. Demosthenes urges that it is time to do something, and to do it with a plan. Athens fighting Philip has fared, he says, like an amateur boxer opposed to a skilled pugilist. The helpless hands have only followed blows which a trained eye should have taught them to parry. An Athenian force must be stationed in the north, at Lemnos or Thasos. Of 2000 infantry and 200 cavalry at least one quarter must be Athenian citizens capable of directing the mercenaries.

Later in the same year Demosthenes did another service to the cause of national freedom. Rhodes, severed by its own act from the Athenian Confederacy, had since 355 been virtually subject to Mausolus, prince (*ἡγεμὼν*) of Caria, himself a tributary of Persia. Mausolus died in 351, and was succeeded by his widow Artemisia. The democratic party in Rhodes now appealed to Athens for help in throwing off the Carian yoke. Demosthenes supported their application in his speech "For the Rhodians." No act of his life was a truer proof of statesmanship. He failed. But at least he had once more warned Athens that the cause of political freedom was everywhere her own, and that, wherever that cause was forsaken, there a new danger was created both for Athens and for Greece.

Next year (350) an Athenian force under Phocion was sent to Euboea, in support of Plutarchus, tyrant of Eretria, against the faction of Cleitarchus. Demosthenes protested against spending strength, needed for greater objects, on the local quarrels of a despot. Phocion won a victory at Tamynae. But the "inglorious and costly war" entailed an outlay of more than £12,000 on the ransom of captives alone, and ended in the total destruction of Athenian influence throughout Euboea. That island was now left an open field for the intrigues of Philip. Worst of all, the party of Eubulus not only defeated a proposal, arising from this campaign, for applying the festival-money to the war-fund, but actually carried a law making it high treason to renew the proposal. The degree to which political enmity was exasperated by the Euboean War may be judged from the incident of Midias, an adherent of Eubulus, and a type of opulent rowdiness. Demosthenes was choragus of his tribe, and was wearing the robe of that sacred office at the great festival in the theatre of Dionysus, when Midias struck him on the face. The affair was eventually compromised. The speech "Against Midias" written by Demosthenes for the trial (in 349) was neither spoken nor completed, and remains, as few will regret, a sketch.

It was now three years since, in 352, the Olynthians had sent an embassy to Athens, and had made peace with their only sure ally. In 350 a second Olynthian embassy had sought and obtained Athenian help. The hour of Olynthus had indeed come. In 349 Philip opened war against the Chalcidic towns of the Olynthian League. The First and Second Olynthics of Demosthenes were spoken in that year in support of sending one force to defend Olynthus and another to attack Philip. "Better now than later," is the thought of the First Olynthiac. The Second argues that Philip's strength is overrated. The Third—spoken in 348—carries us into the midst of action.¹ It deals with practical details. The festival-fund must be used for the war. The citizens must serve in person.

¹ It is generally agreed that the Third Olynthiac is the latest; but the question of the order of the First and Second has much been discussed. See Grote (*History of Greece*, chap. 88, appendix), who prefers the arrangement ii. i. iii., and Blass, *Die attische Beredsamkeit*, iii. p. 319.

A few months later, Olynthus and the thirty-two towns of the confederacy were swept from the earth. Men could walk over their sites, Demosthenes said seven years afterwards, without knowing that such cities had existed. It was now certain that Philip could not be stopped outside of Greece. The question was, What point within Greece shall he be allowed to reach?

Eubulus and his party, with that versatility which is the privilege of political vagueness, now began to call for a congress of the allies to consider the common danger. They found a brilliant interpreter in Aeschines, who, after having been a tragic actor and a clerk to the assembly, had entered political life with the advantages of a splendid gift for eloquence, a fine presence, a happy address, a ready wit and a facile conscience. While his opponents had thus suddenly become warlike, Demosthenes had become pacific. He saw that Athens must have time to collect strength. Nothing could be gained, meanwhile, by going on with the war. Macedonian sympathizers at Athens, of whom Philocrates was the chief, also favoured peace. Eleven envoys, including Philocrates, Aeschines, and Demosthenes, were sent to Philip in February 346 B.C. After a debate at Athens, peace was concluded with Philip in April. Philip on the one hand, Athens and her allies on the other, were to keep what they respectively held at the time when the peace was ratified. But here the Athenians made a fatal error. Philip was bent on keeping the door of Greece open. Demosthenes was bent on shutting it against him. Philip was now at war with the people of Halus in Thessaly. Thebes had for ten years been at war with Phocis. Here were two distinct chances for Philip's armed intervention in Greece. But if the Haliens and the Phocians were included in the peace, Philip could not bear arms against them without violating the peace. Accordingly Philip insisted that they should not be included. Demosthenes insisted they should be included. They were not included. The result followed speedily. The same envoys were sent a second time to Philip at the end of April 346 for the purpose of receiving his oaths in ratification of the peace. It was late in June before he returned from Thrace to Pella—thus gaining, under the terms, all the towns that he had taken meanwhile. He next took the envoys with him through Thessaly to Thermopylae. There—at the invitation of Thessalians and Thebans—he intervened in the Phocian War. Phalaecus surrendered. Phocis was crushed. Philip took its place in the Amphictyonic Council, and was thus established as a Greek power in the very centre, at the sacred hearth, of Greece. The right of precedence in consultation of the oracle (*ἰσοπρωτεία*) was transferred from Athens to Philip. While indignant Athenians were clamouring for the revocation of the peace, Demosthenes upheld it in his speech "On the Peace" in September. It ought never to have been made on such terms, he said. But, having been made, it had better be kept. "If we went to war now, where should we find allies? And after losing Oropus, Amphipolis, Cardia, Chios, Cos, Rhodes, Byzantium, shall we fight about the shadow of Delphi?"

During the eight years between the peace of Philocrates and the battle of Chaeronea, the authority of Demosthenes steadily grew, until it became first predominant and then paramount. He had, indeed, a melancholy advantage. Each year his argument was more and more cogently enforced by the logic of facts. In 344 he visited the Peloponnesus for the purpose of counteracting Macedonian intrigue. Mistrust, he told the Peloponnesian cities, is the safeguard of free communities against tyrants. Philip lodged a formal complaint at Athens. Here, as elsewhere, the future master of Greece reminds us of Napoleon on the eve of the first empire. He has the same imperturbable and persuasive effrontery in protesting that he is doing one thing at the moment when his energies are concentrated on doing the opposite. Demosthenes replied in the Second Philippic. "If," he said, "Philip is the friend of Greece, we are doing wrong. If he is the enemy of Greece, we are doing right. Which is he? I hold him to be our enemy, because everything that he has hitherto done has benefited himself and hurt us." The prosecution of Aeschines for malversation on the

Peace
between
Philip and
Athens.

End of
Phocian
War.

Second
Philippic.

embassy (commonly known as *De falsa legatione*), which was brought to an issue in the following year, marks the moral strength of the position now held by Demosthenes. When the gravity of the charge and the complexity of the evidence are considered, the acquittal of Aeschines by a narrow majority must be deemed his condemnation. The speech "On the Affairs of the Chersonese" and the Third Philippic were the crowning efforts of Demosthenes. Spoken in the same year, 341 B.C., and within a short space of each other, they must be taken together. The speech "On the Affairs of the Chersonese" regards the situation chiefly from an Athenian point of view. "If the peace means," argues Demosthenes, "that Philip can seize with impunity one Athenian possession after another, but that Athenians shall not on their peril touch aught that belongs to Philip, where is the line to be drawn? We shall go to war, I am told, when it is necessary. If the necessity has not come yet, when will it come?" The Third Philippic surveys a wider horizon. It ascends from the Athenian to the Hellenic view. Philip has annihilated Olynthus and the Chalcidic towns. He has ruined Phocis. He has frightened Thesals. He has divided Thessaly. Euboea and the Peloponnesus are his. His power stretches from the Adriatic to the Hellespont. Where shall be the end? Athens is the last hope of Greece. And, in this final crisis, Demosthenes was the embodied energy of Athens. It was Demosthenes who went to Byzantium, brought the estranged city back to the Athenian alliance, and snatched it from the hands of Philip. It was Demosthenes who, when Philip had already seized Elateæ, hurried to Thebes, who by his passionate appeal gained one last chance, the only possible chance, for Greek freedom, who broke down the barrier of an inveterate jealousy, who brought Thebans to fight beside Athenians, and who thus won at the eleventh hour a victory for the spirit of loyal union which took away at least one bitterness from the unspeakable calamity of Chaeronea.

But the work of Demosthenes was not closed by the ruin of his case. During the last sixteen years of his life (338-322) he rendered services to Athens not less important, and perhaps more difficult, than those which he had rendered before. He was now, as a matter of course, foremost in the public affairs of Athens. In January 337, at the annual winter Festival of the Dead in the Outer Ceramicus, he spoke the funeral oration over those who had fallen at Chaeronea. He was member of a commission for strengthening the fortifications of the city (*ραγιστοδῆ*). He administered the festival-fund. During a dearth which visited Athens between 330 and 326 he was charged with the organization of public relief. In 324 he was chief (*ἀρχιστράτηγος*) of the sacred embassy to Olympia. Already, in 336, Ctesiphon had proposed that Demosthenes should receive a golden crown from the state, and that his extraordinary merits should be proclaimed in the theatre at the Great Dionysia. The proposal was adopted by the senate as a bill (*προβούλευμα*); but it must be passed by the Assembly before it could become an act (*ψήφισμα*). To prevent this, Aeschines gave notice, in 336, that he intended to proceed against Ctesiphon for having proposed an unconstitutional measure. For six years Aeschines avoided action on this notice. At last, in 330, the patriotic party felt strong enough to force him to an issue. Aeschines spoke the speech "Against Ctesiphon," an attack on the whole public life of Demosthenes. Demosthenes gained an overwhelming victory for himself and for the honour of Athens in the most finished, the most splendid and the most pathetic work of ancient eloquence—the immortal oration "On the Crown."

In the winter of 325-324 Harpalus, the receiver-general of Alexander in Asia, fled to Greece, taking with him 8000 mercenaries, and treasure equivalent to about a million and a quarter sterling. On the motion of Demosthenes he was warned from the harbours of Attica. Having left his troops and part of his treasure at Tænarum, he again presented himself at the Peiræus, and was now admitted. He spoke fervently of the opportunity which offered itself to those who loved the freedom of Greece. All Asia would rise with Athens

to throw off the hated yoke. Fiery patriots like Hyperæides were in raptures. For zeal which could be bought Harpalus had other persuasions. But Demosthenes stood firm. War with Alexander would, he saw, be madness. It could have but one result,—some indefinitely worse doom for Athens. Antipater and Olympias presently demanded the surrender of Harpalus. Demosthenes opposed this. But he reconciled the dignity with the loyalty of Athens by carrying a decree that Harpalus should be arrested, and that his treasure should be deposited in the Parthenon, to be held in trust for Alexander. Harpalus escaped from prison. The amount of the treasure, which Harpalus had stated as 700 talents, proved to be no more than 350. Demosthenes proposed that the Areopagus should inquire what had become of the other 350. Six months, spent in party intrigues, passed before the Areopagus gave in their report (*ἀπόφασις*). The report inculcated nine persons. Demosthenes headed the list of the accused. Hyperæides was among the ten public prosecutors. Demosthenes was condemned, fined fifty talents, and, in default of payment, imprisoned. After a few days he escaped from prison to Aegina, and thence to Troezen. Two things in this obscure affair are beyond reasonable doubt. First, that Demosthenes was not bribed by Harpalus. The hatred of the Macedonian party towards Demosthenes, and the fury of those vehement patriots who cried out that he had betrayed their best opportunity, combined to procure his condemnation, with the help, probably, of some appearances which were against him. Secondly, it can hardly be questioned that, by withstanding the hot-headed patriots at this juncture, Demosthenes did heroic service to Athens.

Next year (323 B.C.) Alexander died. Then the voice of Demosthenes, calling Greece to arms, rang out like a trumpet. Early in August 322 the battle of Crannon decided the Lamian War against Greece. Antipater demanded, as the condition on which he would refrain from besieging Athens, the surrender of the leading patriots. Demosthenes moved the decree of the Assembly by which Demosthenes, Hyperæides, and some others were condemned to death as traitors. On the 20th of Boedromion (September 16) 322, a Macedonian garrison occupied Munychia. It was a day of solemn and happy memories, a day devoted, in the celebration of the Great Mysteries, to sacred joy,—the day on which the glad procession of the Initiated returned from Eleusis to Athens. It happened, however, to have another association, more significant than any ironical contrast for the present purpose of Antipater. It was the day on which, thirteen years before, Alexander had punished the rebellion of Thebes with annihilation.

The condemned men had fled to Aegina. Parting there from Hyperæides and the rest, Demosthenes went on to Calauria, a small island off the coast of Argolis. In Calauria there was an ancient temple of Poseidon, once a centre of Minyan and Ionian worship, and surrounded with a peculiar sanctity as having been, from time immemorial, an inviolable refuge for the pursued. Here Demosthenes sought asylum. Archias of Thurii, a man who, like Aeschines, had begun life as a tragic actor, and who was now in the pay of Antipater, soon traced the fugitive, landed in Calauria, and appeared before the temple of Poseidon with a body of Thracian spearmen. Plutarch's picturesque narrative bears the marks of artistic elaboration. Demosthenes had dreamed the night before that he and Archias were competing for a prize as tragic actors; the house applauded Demosthenes; but his chorus was shabbily equipped, and Archias gained the prize. Archias was not the man to stick at sacrilege. In Aegina, Hyperæides and the others had been taken from the shrine of Aæcus. But he hesitated to violate an asylum so peculiarly sacred as the Calaurian temple. Standing before its open door, with his Thracian soldiers around him, he endeavoured to prevail on Demosthenes to quit the holy precinct. Antipater would be certain to pardon him. Demosthenes sat silent, with his eyes fixed on the ground. At last, as the emissary persisted in his bland persuasions, he looked up and said,—"Archias, you never moved me by your acting, and you

Third Philippic.

Municipal act.

End of Lamian War.

Demosthenes condemned.

Flight to Calauria.

Flight of Harpalus.

will not move me now by your promises." Archias lost his temper, and began to threaten. "Now," rejoined Demosthenes, "you speak like a real Macedonian oracle; before you were acting. Wait a moment, then, till I write to my friends." With these words, Demosthenes withdrew into the inner part of the temple,—still visible, however, from the entrance. He took out a roll of paper, as if he were going to write, put the pen to his mouth, and bit it, as was his habit in composing. Then he threw his head back, and drew his cloak over it. The Thracian spearmen, who were watching him from the door, began to gibe at his cowardice.

Archias went in to him, encouraged him to rise, **Death.** repeated his old arguments, talked to him of reconciliation with Antipater. By this time Demosthenes felt that the poison which he had sucked from the pen was beginning to work. He drew the cloak from his face, and looked steadily at Archias. "Now you can play the part of Creon in the tragedy as soon as you like," he said, "and cast forth my body unburied. But I, O gracious Poseidon, quit thy temple while I yet live; Antipater and his Macedonians have done what they could to pollute it." He moved towards the door, calling to them to support his tottering steps. He had just passed the altar of the god, when he fell, and with a groan gave up the ghost (October 322 B.C.).

As a statesman, Demosthenes needs no epitaph but his own words in the speech "On the Crown,"—*I say that, if the event had been manifest to the whole world beforehand, not even then ought Athens to have forsaken this course, if Athens had any regard for her glory, or for her past, or for the ages to come.* The Persian soldier in Herodotus, following Xerxes to foreseen ruin, confides to his fellow-guest at the banquet that the bitterest pain which man can know is *πολλὰ φρονέοντα μηδένος κρείεον*,—complete, but helpless, prescience. In the grasp of a more inexorable necessity, the champion of Greek freedom was borne onward to a more tremendous catastrophe than that which strewed the waters of Salamis with Persian wrecks and the field of Plataea with Persian dead; but to him, at least, it was given to proclaim aloud the clear and sure foreboding that filled his soul, to do all that true heart and free hand could do for his cause, and, though not to save, yet to encourage, to console and to ennoble. As the inspiration of his life was larger and higher than the mere courage of resistance, so his merit must be regarded as standing altogether outside and above the struggle with Macedon. The great purpose which he set before him was to revive the public spirit, to restore the political vigour, and to re-establish the Panhellenic influence of Athens,—never for her own advantage merely, but always in the interest of Greece. His glory is, that while he lived he helped Athens to live a higher life. Wherever the noblest expressions of her mind are honoured, wherever the large conceptions of Pericles command the admiration of statesmen, wherever the architect and the sculptor love to dwell on the masterpieces of Ictinus and Pheidias, wherever the spell of ideal beauty or of lofty contemplation is exercised by the creations of Sophocles or of Plato, there it will be remembered that the spirit which wrought in all these would have passed sooner from among men, if it had not been recalled from a trance, which others were content to mistake for the last sleep, by the passionate breath of Demosthenes.

The orator in whom artistic genius was united, more perfectly than in any other man, with moral enthusiasm and with intellectual grasp, has held in the modern world the same rank which was accorded to him in the old; but he cannot enjoy the same appreciation. Macaulay's ridicule has rescued from oblivion the criticism which pronounced the eloquence of Chatham to be more ornate than that of Demosthenes, and less diffuse than that of Cicero. Did the critic, asks Macaulay, ever hear any speaking that was less ornamented than that of Demosthenes, or more diffuse than that of Cicero? Yet the critic's remark was not so pointless as Macaulay thought it. Sincerity and intensity are, indeed, to the modern reader, the most obvious characteristics of Demosthenes. His style is, on the whole, singularly free from what we are accustomed to regard as rhetorical embellishment. Where the modern orator would employ a wealth of imagery, or elaborate a picture in

exquisite detail, Demosthenes is content with a phrase or a word. Burke uses, in reference to Hyder Ali, the same image which Demosthenes uses in reference to Philip. "Compounding all the materials of fury, havoc, desolation, into one black cloud, he hung for a while on the declivity of the mountains. Whilst the authors of all these evils were idly and stupidly gazing on this menacing meteor, which darkened all their horizon, it suddenly burst, and poured down the whole of its contents upon the plains of the Carnatic." Demosthenes forbears to amplify "The people gave their voice, and the danger which hung upon our borders went by like a cloud." To our modern feeling, the eloquence of Demosthenes exhibits everywhere a general stamp of earnest and simple strength. But it is well to remember the charge made against the style of Demosthenes by a contemporary Greek orator, and the defence offered by the best Greek critic of oratory. Aeschines reproached the diction of Demosthenes with excess of elaboration and adornment (*περπερηλα*). Dionysius, in reply, admits that Demosthenes does at times depart from simplicity,—that his style is sometimes elaborately ornate and remote from the ordinary usage. But, he adds, Demosthenes adopts this manner where it is justified by the elevation of his theme. The remark may serve to remind us of our modern disadvantage for a full appreciation of Demosthenes. The old world felt, as we do, his moral and mental greatness, his fire, his self-devotion, his insight. But it felt also, as we can never feel, the versatile perfection of his skill. This it was that made Demosthenes unique to the ancients. The ardent patriot, the far-seeing statesman, were united in his person with the consummate and unapproachable artist. Dionysius devoted two special treatises to Demosthenes,—one on his language and style (*λατικὸς τόπος*), the other on his treatment of subject-matter (*πραγματικὸς τόπος*). The latter is lost. The former is one of the best essays in literary criticism which antiquity has bequeathed to us. The idea which it works out is that Demosthenes has perfected Greek prose by fusing in a glorious harmony the elements which had hitherto belonged to separate types. The austere dignity of Antiphon, the plain elegance of Lysias, the smooth and balanced finish of that middle or normal character which is represented by Isocrates, have come together in Demosthenes. Nor is this all. In each species he excels the specialists. He surpasses the school of Antiphon in perspicuity, the school of Lysias in verve, the school of Isocrates in variety, in felicity, in symmetry, in pathos, in power. Demosthenes has at command all the discursive brilliancy which fascinates a festal audience. He has that power of concise and lucid narration, of terse reasoning, of persuasive appeal, which is required by the forensic speaker. His political eloquence can worthily image the majesty of the state, and enforce weighty counsels with lofty and impassioned fervour. A true artist, he grudged no labour which could make the least part of his work more perfect. Isocrates spent ten years on the *Panegyricus*. After Plato's death, a manuscript was found among his papers with the first eight words of the *Republic* arranged in several different orders. What wonder, then, asks the Greek critic, if the diligence of Demosthenes was no less incessant and minute? "To me," he says, "it seems far more natural that a man engaged in composing political discourses, imperishable memorials of his power, should neglect not even the smallest details, than that the veneration of painters and sculptors, who are darkly showing forth their manual tact and toil in a corruptible material, should exhaust the refinements of their art on the veins, on the feathers, on the down of the lip, and the like niceties."

More than half of the sixty-one speeches extant under the name of Demosthenes are certainly or probably spurious. The results to which the preponderance of opinion leans are given in the following table. Those marked *a* were already rejected or doubted in antiquity; those marked *m*, first in modern times:¹

¹ The dates agree in the main with those given by A. D. Schäfer in *Demosthenes und seine Zeit* (2nd ed., 1885-1887), and by F. Blasi in *Die attische Beredsamkeit* (1887-1898), who regards thirty-three (or possibly thirty-five) of the speeches as genuine.

I. DELIBERATIVE SPEECHES.

GENUINE.

Or. 14. On the Navy Boards	354	B.C.
Or. 16. For the People of Megalopolis	352	"
Or. 4. First Philippic	351	"
Or. 15. For the Rhodians	351	"
Or. 1. First Olynthiac	349	"
Or. 2. Second Olynthiac	349	"
Or. 3. Third Olynthiac	348	"
Or. 5. On the Peace	346	"
Or. 6. Second Philippic	344	"
Or. 8. On the Affairs of the Chersonese	341	"
Or. 9. Third Philippic	341	"

SPURIOUS.

(a) Or. 7. On Halonnesus (by Hegesippus)	342	B.C.
<i>Rhetorical Forgeries.</i>		
(a) Or. 17. On the Treaty with Alexander		
(a) Or. 10. Fourth Philippic		
(=) Or. 11. Answer to Philip's Letter. ¹		
(=) Or. 12. Philip's Letter		
(=) Or. 13. On the Assessment (<i>στέρξις</i>)		

II. FORENSIC SPEECHES.

A. IN PUBLIC CAUSES.

GENUINE.

Or. 22. In (<i>εὐρά</i>) Androctonem	355	B.C.
Or. 20. Contra (<i>ῥῶβίς</i>) Leptinem	354	"
Or. 24. In Timocratem	352	"
Or. 23. In Aristocratem	352	"
Or. 21. In Midiam	349	"
Or. 19. On the Embassy	343	"
Or. 18. On the Crown	330	"

SPURIOUS.

(a) Or. 58. In Theocritum	339	B.C.
(a) Or. 25, 26. In Aristogitona I. and II. (Rhetorical forgeries).		

B. IN PRIVATE CAUSES.

GENUINE.

Or. 27, 28. In Aphobum I et II.	364	B.C.
(=) Or. 30, 31. Contra Onetora I. et II.	362	"
Or. 41. Contra Spudiam	?	"
(=) Or. 55. Contra Calliclem	?	"
Or. 54. In Cononem	356	"
Or. 35. Pro Phormione	352	"
(=) Or. 39. Contra Boeotum de Nomine	350	"
Or. 37. Contra Pantaenetum	346-5	"
(=) Or. 38. Contra Nausimachum et Diopitheim	?	"

SPURIOUS.

(The first eight of the following are given by Schäfer to Apollodorus.)

(=) Or. 52. Contra Callippum	369-8	B.C.
(=) Or. 53. Contra Nicostatrum	after 368	"
(=) Or. 49. Contra Timotheum	362	"
(=) Or. 50. Contra Polycletem	357	"
(=) Or. 47. In Evergum et Mnesibulum	356	"
(=) Or. 45. In Stephanum I et II.	351	"
(=) Or. 59. In Neseuram	349[343-0, Blass]	"
(=) Or. 51. On the Trierarchic Crown (by Cephiso-dotus?)	360-359	"
(=) Or. 43. Contra Macaratum	?	"
(=) Or. 48. In Olympiodorum	after 343	"
(=) Or. 44. Contra Leocharem	?	"
(=) Or. 35. Contra Lacritum	?	"
(=) Or. 42. Contra Phaeppium	341	"
(=) Or. 32. Contra Zenothemin	?	"
(=) Or. 34. Contra Phormionem	?	"
(=) Or. 29. Contra Aphobum pro Phano	?	"
(=) Or. 40. Contra Boeotum de Dote	347	"
(=) Or. 57. Contra Ebulidem	346-5	"
(=) Or. 33. Contra Apaturium	?	"
(=) Or. 56. In Dionysodorum	not before 322-1	"

Or. 60 (*ἑρμῶν*) and Or. 61 (*ἑρμῶν*) are works of rhetoricians. The six epistles are also forgeries; they were used by the composer of the twelve epistles which bear the name of Aeschines. The 56 *ῥητορικά*, exordia or sketches for political speeches, are by various hands and of various dates.¹ They are valuable as being compiled from Demosthenes himself, or from other classical models.

The ancient fame of Demosthenes as an orator can be compared only with the fame of Homer as a poet. Cicero, with generous appreciation, recognizes Demosthenes as the standard of perfection. Dionysius, the closest and most penetrating of his ancient critics, exhausts the language of admiration in showing how

Demosthenes united and elevated whatever had been best in earlier masters of the Greek idiom. Hermogenes, in his works on rhetoric, refers to Demosthenes as *ὁ ἄριστος*, the *Literary History of Demosthenes* orator. The writer of the treatise On Sublimity knows no heights loftier than those to which Demosthenes has risen. From his own younger contemporaries, Aristotle and Theophrastus, who founded their theory of rhetoric in large part on his practice, down to the latest Byzantines, the consent of theorists, orators, antiquarians, anthologists, lexicographers, offered the same unvarying homage to Demosthenes. His work busied commentators such as Xenon, Minucian, Basilicus, Aelius, Theon, Zosimus of Gaza. Arguments to his speeches were drawn up by rhetoricians so distinguished as Numenius and Libanius. Accomplished men of letters, such as Julius Vestinus and Aelius Dionysius, selected from his writings choice passages for declamation or perusal, of which fragments are incorporated in the miscellany of Photius and the lexicons of Harpocration, Pollux and Suidas. It might have been anticipated that the purity of a text so widely read and so renowned would, from the earliest times, have been guarded with jealous care. The works of the three great dramatists had been thus protected, about 340 B.C., by a standard Attic recension. But no such good fortune befell the works of Demosthenes. Alexandrian criticism was chiefly occupied with poetry. The titular works of Demosthenes were, indeed, registered, with those of the other orators, in the catalogues (*βιβλιοθήκαι*) of Alexandria and Pergamum. But no thorough attempt was made to separate the authentic works from those spurious works which had even then become mingled with them. Philosophical schools which, like the Stoic, felt the ethical interest of Demosthenes, cared little for his language. The rhetoricians who imitated or analysed his style cared little for the criticism of his text. Their treatment of it had, indeed, a direct tendency to falsify it. It was customary to indicate by marks those passages which were especially useful for study or imitation. It then became a rhetorical exercise to recast, adapt or interweave such passages. Sopater, the commentator on Hermogenes, wrote on *μεταβολαὶ καὶ μεταρρυθμίσεις τῶν Δημοσθένους χωρίων*, "adaptations or transcripts of passages in Demosthenes." Such manipulation could not but lead to interpolations or confusions in the original text. Great, too, as was the attention bestowed on the thought, sentiment and style of Demosthenes, comparatively little care was bestowed on his subject-matter. He was studied more on the moral and the formal side than on the real side. An incorrect substitution of one name for another, a reading which gave an impossible date, insertions of spurious laws or decrees, were points which few readers would stop to notice. Hence it resulted that, while Plato, Thucydides and Demosthenes were the most universally popular of the classical prose-writers, the text of Demosthenes, the most widely used perhaps of all, was also the least pure. His more careful students at length made an effort to arrest the process of corruption. Editions of Demosthenes based on a critical recension, and called 'Ἀρτυραῖά (*ἀρτυράφαι*), came to be distinguished from the vulgates, or *δημόδεις ἐκδόσεις*.

Among the extant manuscripts of Demosthenes—upwards of 170 in number—one is far superior, as a whole, to the rest. This is *Parisinus* 2 2034, of the 10th century. A comparison of this MS. with the extracts of Aelius, Aristeides and Harpocration from the Third Philippic favours the view that it is derived from an 'Ἀρτυραῖον, whereas the *δημόδεις ἐκδόσεις*, used by Hermogenes and by the rhetoricians generally, have been the chief sources of our other manuscripts. The collation of this manuscript by Immanuel Bekker first placed the textual criticism of Demosthenes on a sound footing. Not only is this manuscript nearly free from interpolations, but it is the sole voucher for many excellent readings. Among the other MSS., some of the most important are—*Marcianus* 416 F, of the 10th (or 11th) century, the basis of the Aldine edition; *Augustanus* I. (N 85), derived from the last, and containing scholia to the speeches on the Crown and the Embassy, by Ulpian, with some by a younger writer, who was

Manuscript.

¹ Or. 11 and 12 are probably both by Anaximenes of Lampascus. ² According to Blass, the second and third epistles and the *exordia* are genuine.

perhaps Moschopolus; *Parisinus* T; *Antwerpensis* Ω—the last two comparatively free from additions. The fullest authority on the MSS. is J. T. Vömel, *Notitia codicum Demosth.*, and *Prolegomena Critica* to his edition published at Halle (1856–1857), pp. 175–178.¹

The extant scholia on Demosthenes are for the most part poor. Their staple consists of Byzantine erudition; and their value depends chiefly on what they have preserved of older criticism. They are better than usual for the Περὶ σφεδάνου, Κατὰ Τυμπακόνται; best for the Περὶ παραπροβείας. The Greek commentators ascribed to Ulpian are especially defective on the historical side, and give little essential aid. Editions.—C. W. Müller, in *Orat. Att.* ii. (1847–1858); *Scholía Græca in Demosth. ex cod. auct. emendata* (Oxon., 1851; in W. Dindorf's ed.).

BIBLIOGRAPHY.—*Éditio princeps* (Alinda, Venice, 1504); J. J. Reiske (with notes of J. Wolf, J. Taylor, J. Markland, &c., 1770–1775); revised edition of Reiske by G. H. Schæfer (1823–1826); I. Bekker, in *Oratores Attici* (1823–1824), the first edition based on codex Z (see above); W. S. Dobson (1828); J. G. Baier and H. Sauppe (1850); W. Dindorf (in Teubner series, 1867, 4th ed. by F. Blass, 1885–1889); H. Omont, facsimile edition of codex Z (1892–1893); S. H. Butcher in *Oxford Scriptorum Classicorum Bibliotheca* (1903 foll.); W. Dindorf (9 vols., Oxford, 1846–1851), with notes of previous commentators and Greek scholia; R. Whiston (political speeches) with introductions and notes (1850–1868). For a select list of the numerous English and foreign editions and translations of separate speeches see J. B. Mayor, *Guide to the Choice of Classical Books* (1885, suppd. 1896). Mention may here be made of *De corona* by W. W. Goodwin (1901, ed. min., 1904); W. H. Simcox (1873, with *Aschines in Cleisthenem*; and P. E. Matheson (1899); *Leptines* by J. E. Sandys (1890); *De falsa legatione* by R. Shilleto (4th ed., 1874); *Select Private Orations* by J. E. Sandys and F. A. Paley (3rd ed., 1898, 1896); *Midias* by W. W. Goodwin (1906). C. R. Kennedy's complete translation is a model of scholarly finish, and the appendices on Attic law, &c., are of great value. There are indices to Demosthenes by J. Reiske (ed. G. H. Schæfer, 1823); S. Preuss (1892). Among recent papyrus finds are fragments of a special lexicon to the *Aristoteles* and a commentary by Didymus (ed. H. Diels and W. Schubart, 1904). Illustrative literature: A. D. Schæfer, *Demosthenes und seine Zeit* (2nd ed., 1885–1887), a masterly and exhaustive historical work; F. Blass, *Die attische Beredsamkeit* (1887–1898); W. J. Brodribb, "Demosthenes" in *Ancient Classics for English Readers* (1877); S. H. Butcher, *Introduction to the Study of Demosthenes* (1881); C. G. Böhnecke, *Demosthenes, Lykurgos, Hyperides, und ihr Zeitalter* (1864); A. Bouillé, *Histoire de Démosthène* (2nd ed., 1868); J. Girard, *Études sur l'éloquence attique* (1874); M. Croiset, *Des idées morales dans l'éloquence politique de Démosthène* (1874); A. Hug, *Demosthenes als politischer Denker* (1881); L. Brédit, *L'éloquence politique en Grèce* (2nd ed., 1886); A. Bougot, *Rivalité d'Eschine et Démosthène* (1891). For fuller bibliographical information consult R. Nicolai, *Griechische Literaturgeschichte* (1881); W. Engelmann, *Scriptores Græci* (1881); G. Hüttner in C. Bursian's *Jahresbericht*, li. (1889). (R. C. J.)

DEMOTIC (Gr. δημοτικός, of or belonging to the people), a term, meaning popular, specially applied to that cursive script of the ancient Egyptian language used for business and literary purposes,—for the people. It is opposed to "hieratic" (Gr. ἱερατικός, of or belonging to the priests), the script, an abridged form of the hieroglyphic, used in transcribing the religious texts. (See WRITING, and EGYPT: II., *Ancient, D. Language and Writing.*)

DEMOTICA, or ΔΗΜΟΤΙΚΑ, a town of European Turkey, in the vilayet of Adrianople; on the Maritza valley branch of the Constantinople-Salonica railway, about 35 m. S. of Adrianople. Pop. (1905) about 10,000. Demotica is built at the foot of a conical hill on the left bank of the river Kizildeli, near its junction with the Maritza. It was formerly the seat of a Greek archbishop, and besides the ancient citadel and palace on the summit of the hill contains several Greek churches, mosques and public baths. In the middle ages, when it was named Didymotichos, it was one of the principal marts of Thrace; in modern times it has regained something of its commercial importance, and exports pottery, linen, silk and grain. These goods are sent to Dédeagatch for shipment. Demotica was the birthplace of the

¹ See also H. Ueener in *Nachrichten von der Königl. Gesellschaft der Wissenschaften zu Göttingen*, p. 188 (1892); J. H. Lipsius, "Zur Text-critik des Demosthenes," in *Berichte der Königl. Sächsischen Gesellschaft der Wissenschaften* (1893) with special reference to the papyrus finds at the end of the 19th century; E. Bethé, *Demosthenis scriptorum corpus* (1893)

Turkish sultan Bayezid I. (1347); after the battle of Poltava, Charles XII. of Sweden resided here from February 1713 to October 1714.

DEMPSTER, THOMAS (1579–1625), Scottish scholar and historian, was born at Cliftbog, Aberdeenshire, the son of Thomas Dempster of Muresk, Auchterless and Killesmont, sheriff of Banff and Buchan. According to his own account, he was the twenty-fourth of twenty-nine children, and was early remarkable for precocious talent. He obtained his early education in Aberdeenshire, and at ten entered Pembroke Hall, Cambridge; after a short while he went to Paris, and, driven thence by the plague, to Louvain, whence by order of the pope he was transferred with several other Scottish students to the papal seminary at Rome. Being soon forced by ill health to leave, he went to the English college at Douai, where he remained three years and took his M.A. degree. While at Douai he wrote a scurrilous attack on Queen Elizabeth, which caused a riot among the English students. But, if his truculent character was thus early displayed, his abilities were no less conspicuous; and, though still in his teens, he became lecturer on the Humanities at Tournai, whence, after but a short stay, he returned to Paris, to take his degree of doctor of canon law, and become regent of the college of Navarre. He soon left Paris for Toulouse, which in turn he was forced to leave owing to the hostility of the city authorities, aroused by his violent assertion of university rights. He was now elected professor of eloquence at the university or academy of Nîmes, but not without a murderous attack upon him by one of the defeated candidates and his supporters, followed by a suit for libel, which, though he ultimately won his case, forced him to leave the town. A short engagement in Spain, as tutor to the son of Marshal de Saint Luc, was terminated by another quarrel; and Dempster now returned to Scotland with the intention of asserting a claim to his father's estates. Finding his relatives unsympathetic, and falling into heated controversy with the Presbyterian clergy, he made no long stay, but returned to Paris, where he remained for seven years, becoming professor in several colleges successively. At last, however, his temporary connexion with the collège de Beauvais was ended by a feat of arms which proved him as stout a fighter with his sword as with his pen; and, since his victory was won over officers of the king's guard, it again became expedient for him to change his place of residence. The dedication of his edition of Rosinus' *Antiquitatum Romanorum corpus absolutissimum* to King James I. had won him an invitation to the English court; and in 1615 he went to London. His reception by the king was flattering enough; but his hopes of preferment were dashed by the opposition of the Anglican clergy to the promotion of a papist. He left for Rome, where, after a short imprisonment on suspicion of being a spy, he gained the favour of Pope Paul V., through whose influence with Cosimo II., grand duke of Tuscany, he was appointed to the professorship of the Pandects at Pisa. He had married while in London, but ere long had reason to suspect his wife's relations with a certain Englishman. Violent accusations followed, indignantly repudiated; a diplomatic correspondence ensued, and a demand was made, and supported by the grand duke, for an apology, which the professor refused to make, preferring rather to lose his chair. He now set out once more for Scotland, but was intercepted by the Florentine cardinal Luigi Capponi, who induced him to remain at Bologna as professor of Humanity. This was the most distinguished post in the most famous of continental universities, and Dempster was now at the height of his fame. Though his *Roman Antiquities* and *Scotia Illustrata* had been placed on the Index pending correction, Pope Urban VIII. made him a knight and gave him a pension. He was not, however, to enjoy his honours long. His wife eloped with a student, and Dempster, pursuing the fugitives in the heat of summer, caught a fever, and died at Bologna on the 6th of September 1625.

Dempster owed his great position in the history of scholarship to his extraordinary memory, and to the versatility which made him equally at home in philology, criticism, law, biography and history. His style is, however, often barbarous; and the obvious

defects of his works are due to his restlessness and impetuosity, and to a patriotic and personal vanity which led him in Scottish questions into absurd exaggerations, and in matters affecting his own life into an incurable habit of romancing. The best known of his works is the *Historia ecclesiastica gentis Scotorum* (Bologna, 1627). In this book he tries to prove that Bernard (Sapiens), Alcuin, Boniface and Joannes Scotus Erigena were all Scots, and even Boadicea becomes a Scottish author. This criticism is not applicable to his works on antiquarian subjects, and his edition of Benedetto Accolti's *De bello a Christianis contra barbaros* (1623) has great merits.

A portion of his Latin verse is printed in the first volume (pp. 306-354) of *Delstus postarum Scotorum* (Amsterdam, 1637).

DEMURRAGE (from "demur," Fr. *demeurer*, to delay, derived from Lat. *mora*), in the law of merchant shipping, the sum payable by the freighter to the shipowner for detention of the vessel in port beyond the number of days allowed for the purpose of loading or unloading (see **AFREIGHTMENT**: under *Charter-parties*). The word is also used in railway law for the charge on detention of trucks; and in banking for the charge per ounce made by the Bank of England in exchanging coin or notes for bullion.

DEMURRER (from Fr. *demeurer*, to delay, Lat. *morari*), in English law, an objection taken to the sufficiency, in point of law, of the pleading or written statement of the other side. In equity pleading a demurrer lay only against the bill, and not against the answer; at common law any part of the pleading could be demurred to. On the passing of the Judicature Act of 1875 the procedure with respect to demurrers in civil cases was amended, and, subsequently, by the Rules of the Supreme Court, Order XXV demurrers were abolished and a more summary process for getting rid of pleadings which showed no reasonable cause for action or defence was adopted, called proceedings in lieu of demurrer. Demurrer in criminal cases still exists, but is now seldom resorted to. Demurrers are still in constant use in the United States. See **ANSWER**, **PLEADING**.

DENAIN, a town of northern France in the department of Nord, 8 m. S.W. of Valenciennes by steam tramway. A mere village in the beginning of the 19th century, it rapidly increased from 1850 onwards, and, according to the census of 1906, possessed 22,845 inhabitants, mainly engaged in the coal mines and iron-smelting works, to which it owes its development. There are also breweries, manufactories of machinery, sugar and glass. A school of commerce and industry is among the institutions. Denain has a port on the left bank of the Scheldt canal. Its vicinity was the scene of the decisive victory gained in 1712 by Marshal Villars over the allies commanded by Prince Eugène; and the battlefield is marked by a monolithic monument inscribed with the verses of Voltaire—

"Regardez dans Denain l'audacieux Villars
Disputant le tonnerre à l'aigle des Césars."

DENBIGH, WILLIAM FEILDING, 1ST EARL OF (d. 1643), son of Basil Feilding of Newnham Paddox in Warwickshire, and of Elizabeth, daughter of Sir Walter Aston, was educated at Emmanuel College, Cambridge, and knighted in 1603. He married Susan, daughter of Sir George Villiers, sister of the future duke of Buckingham, and on the rise of the favourite received various offices and dignities. He was appointed *custos rotularum* of Warwickshire, and master of the great wardrobe in 1622, and created baron and viscount Feilding in 1620, and earl of Denbigh on the 14th of September 1622. He attended Prince Charles on the Spanish adventure, served as admiral in the unsuccessful expedition to Cadiz in 1625, and commanded the disastrous attempt upon Rochelle in 1628, becoming the same year a member of the council of war, and in 1633 a member of the council of Wales. In 1631 Lord Denbigh visited the East on the outbreak of the Civil War he served under Prince Rupert

¹ The descent of the Feildings from the house of Habsburg, through the counts of Laufenburg and Rheinfelden, long considered authentic, and immortalized by Gibbon, has been proved to have been based on forged documents. See J. H. Round, *Peerage and Family History* (1901).

and was present at Edgehill. On the 3rd of April 1643 during Rupert's attack on Birmingham he was wounded and died from the effects on the 8th, being buried at Monks Kirby in Warwickshire. His courage, unselfishness and devotion to duty are much praised by Clarendon.

See E. Lodge, *Portraits* (1850), iv. 113; J. Nichols, *Hist. of Leicestershire* (1807), iv. pt. 1, 273; *Hist. MSS. Comm. Ser. 4th Rep.* app. 254, *Col. of State Papers, Dom.*; *Studies in Peerage and Family History*, by J. H. Round (1901), 216.

His eldest son, **BASIL FEILDING**, 2nd earl of Denbigh (c. 1608-1675), was educated at Emmanuel College, Cambridge. He was summoned to the House of Lords as Baron Feilding in March 1629. After seeing military service in the Netherlands he was sent in 1634 by Charles I. as ambassador to Venice, where he remained for five years. When the Civil War broke out Feilding, unlike the other members of his family, ranged himself among the Parliamentarians, led a regiment of horse at Edgehill, and, having become earl of Denbigh in April 1643, was made commander-in-chief of the Parliamentary army in Warwickshire and the neighbouring counties, and lord-lieutenant of Warwickshire. During the year 1644 he was fairly active in the field, but in some quarters he was distrusted and he resigned his command after the passing of the self-denying ordinance in April 1645. At Uxbridge in 1645 Denbigh was one of the commissioners appointed to treat with the king, and he undertook a similar duty at Carisbrooke in 1647. Clarendon relates how at Uxbridge Denbigh declared privately that he regretted the position in which he found himself, and expressed his willingness to serve Charles I. He supported the army in its dispute with the parliament, but he would take no part in the trial of Charles I. Under the government of the commonwealth Denbigh was a member of the council of state, but his loyalty to his former associates grew lukewarm, and gradually he came to be regarded as a royalist. In 1664 the earl was created Baron St Liz. Although four times married he left no issue when he died on the 28th of November 1675.

His titles devolved on his nephew **WILLIAM FEILDING** (1640-1685), son and heir of his brother George (created Baron Feilding of Lecage, Viscount Callan and earl of Desmond), and the earldom of Desmond has been held by his descendants to the present day in conjunction with the earldom of Denbigh.

DENBIGH (*Dinbych*), a municipal and (with Holt, Ruthin and Wrexham) contributory parliamentary borough, market town and county town of Denbighshire, N. Wales, on branches of the London & North Western and the Great Western railways. Pop. (1901) 6438. Denbigh Castle, surrounding the hill with a double wall, was built, in Edward I.'s reign, by Henry de Lacy, earl of Lincoln, from whom the town received its first charter. The outer wall is nearly a mile round; over its main gateway is a niche with a figure representing, possibly, Edward I., but more probably, de Lacy. Here, in 1645, after the defeat of Rowton Moor, Charles I. found shelter, the castle long resisting the Parliamentarians, and being reduced to ruins by his successor. The chief buildings are the Carmelite Priory (ruins dating perhaps from the 13th century); a Bluecoat school (1514); a free grammar school (1527); an orphan girl school (funds left by Thomas Howel to the Drapers' Co., in Henry VII.'s reign); the town hall (built in 1572 by Robert Dudley, earl of Leicester, enlarged and restored in 1780); an unfinished church (begun by Leicester), a market hall (with arcades or "rows," such as those of Chester or Yarmouth); and the old parish church of St Marcella. The streams near Denbigh are the Clwyd and Elwy. The inhabitants of Denbigh are chiefly occupied in the timber trade, butter-making, poultry-farming, bootmaking, tanning and quarrying (lime, slate and paving-stones). The borough of Denbigh has a separate commission of the peace, but no separate court of quarter sessions. The town has long been known as a Welsh publishing centre, the vernacular newspaper, *Baner*, being edited and printed here. Near Denbigh, at Bodelwyddan, &c., coal is worked.

The old British tower and castle were called *Castell caled frys yn Rhôs*, the "castle of the hard hill in Rhôs." *Din* in

Dinbych means a fort. There is a goblin well at the castle. Historically, David (*Dafydd*), brother of the last Llewelyn, was here (*act.* Edward I.) perhaps on a foray; also Henry Lacy, who built the castle (*act.* Edward I.), given to the Mortimers and to Leicester (under Edward III. and Elizabeth, respectively).

DENBIGHSHIRE (*Dinbych*), a county of N. Wales, bounded N. by the Irish Sea, N.E. by Flint and Cheshire, S.E. by Flint and Shropshire, S. by Montgomery and Merioneth, and W. by Carnarvon. Area, 662 sq. m. On the N. coast, within the Denbighshire borders and between Old Colwyn and Llandulas, is a wedge of land included in Carnarvonshire, owing to a change in the course of the Conwy stream. (Thus, also, Llandudno is partly in the Bangor, and partly in the St Asaph, diocese.) The surface of Denbighshire is irregular, and physically diversified. In the N.W. are the bleak Hiraethog ("longing") hills, sloping W. to the Conwy and E. to the Clwyd. In the N. are Colwyn and Abergele bays, on the S. the Ysppytt (Lat. *Hospitium*) and Llangwm range, between Denbigh and Merioneth. From this watershed flow the Elwy, Aled, Clywedog, Merddwr and Alwen, tributaries of the Clwyd, Conwy and Dee (*Dyfrdwy*). Some of the valleys contrast agreeably with the bleak hills, e.g. those of the Clwyd and Elwy. The portion lying between Ruabon (*Rhiwabon*) hills and the Dee is agricultural and rich in minerals; the Berwyn to Offa's Dyke (*Wâl Offa*) is wild and barren, except the Tanat valley, Llansilin and Ceiriog. One feeder of the Tanat forms the Pistyll Rhaiadr (waterspout fall), another rises in Llyncaws (cheese pool) under Moel Spud (dry bare-hill), the highest point in the county. Aled and Alwen are both lakes and streams.

Geology.—The geology of the county is full of interest, as it develops all the principal strata that intervenes between the Ordovician and the Triassic series. In the Ordovician district, which extends from the southern boundary to the Ceiriog, the Llandeilo formation of the eastern slopes of the Berwyn and the Bala beds of shelly sandstone are traversed east and west by bands of intrusive felspathic porphyry and ashes. The same formation occurs just within the county border at Cerrig-y-Drudion, Langum, Bettys-coed and in the Fairy Glen. Northwards from the Ceiriog to the limestone fringe at Llandrillo the Wenlock shale of the Silurian covers the entire mass of the Hiraethog and Clwydian hills, but verging on its western slopes into the Denbighshire grit, which may be traced southward in a continuous line from the mouth of the Conwy as far as Llanddewi Ystrad Enni in Radnorshire, near Pentre-Voelas and Conwy they are abundantly fossiliferous. On its eastern slope a narrow broken band of the Old Red, or what may be a conglomeratic basement bed of the Carboniferous Limestone series, crops up along the Vale of Clwyd and in Eglwysgec. Resting upon this the Carboniferous Limestone extends from Llanyrnach, its extreme southern point, to the Cynrybrain fault, and there forks into two divisions that terminate respectively in the Great Orme's Head and in Talargoch, and are separated from each other by the denuded shales of the Moel Famra range. In the Vale of Clwyd the limestone underlies the New Red Sandstone, and in the eastern division it is itself overlaid by the Millstone Grit of Ruabon and Minera, and by a long reach of the Coal Measures which near Wrexham are 41 m. in breadth. Eastward of these a broad strip of the red marly beds succeeds, formerly considered to be Permian but now regarded as belonging to the Coal Measures, and yet again between this and the Dee the ground is occupied—as in the Vale of Clwyd—by the New Red rocks. As in the other northern counties of Wales, the whole of the lower ground is covered more or less thickly with glacial drift. On the western side of the Vale of Clwyd, at Cefn and Pils Heaton, the caves, which are a common feature in such limestone districts, have yielded the remains of the rhinoceros, mammoth, hippopotamus and other extinct mammals.

Coal is mined from the Coal Measures, and from the limestone below, lead with silver and zinc ores have been obtained. Valuable fireclays and terra-cotta marls are also taken from the Coal Measures about Wrexham.

The uplands being uncongenial for corn, ponies, sheep and black cattle are reared, for fattening in the Midlands of England and sale in London. Oats and turnips, rather than wheat, barley and potatoes, occupy the tilled land. The county is fairly wooded. There are several important farmers' clubs (the Denbighshire and Flintshire, the vale of Conwy, the Cerrig y druidion, &c.). The London & North-Western railway (Holyhead line), with the Conwy and Clwyd valleys branches, together with the lines connecting Denbigh with Ruabon (*Rhiwabon*), via Ruthin and Corwen, Wrexham with Connah's Quay (Great

Central) and Rhoslanerchrhugog with Glyn Ceiriog (for the Great Western and Great Central railways) have opened up the county. Down the valley of Llangollen also runs the Holyhead road from London, well built and passing through finescenery. At Nantglyn paving flags are raised, at Rhiwelen (near Llangollen) slabs and slates, and good slates are also obtained at Glyn Ceiriog. There is plenty of limestone, with china stone at Brymbo. Cefn Rhiwabon yields sandstone (for bones) and millstone grit. Chirk, Ruabon and Brymbo have coal mines. The great Minera is the principal lead mine. There is much brick and pottery clay. The Ceiriog valley has a dynamite factory. Llangollen and Llansantffraid (St Bridgit's) have woollen manufactures.

The area of the ancient county is 423,499 acres, with a population in 1901 of 129,942. The area of the administrative county is 426,084 acres. The chief towns are: Wrexham, a mining centre and N. Wales military centre, with a fine church; Denbigh; Ruthin, where assizes are held (here are a grammar school, a warden and a 13th-century castle rebuilt); Llangollen and Llanrwst; and Holt, with an old ruined castle. The Denbigh district of parliamentary boroughs is formed of: Denbigh (pop. 6483), Holt (1059), Ruthin (2643), and Wrexham (14,966). The county has two parliamentary divisions. The urban districts are: Abergele and Pensarn (2083), Colwyn Bay and Colwyn (8689), Llangollen (3303), and Llanrwst (2645). Denbighshire is in the N. Wales circuit, assizes being held at Ruthin. Denbigh and Wrexham boroughs have separate commissions of the peace, but no separate quarter-session courts. The ancient county, which is in the diocese of St Asaph, contains seventy-five ecclesiastical parishes and districts and part of a parish.

The county was formed, by an act of Henry VIII., out of the lordships of Denbigh, Ruthin (*Rhuthyn*), Rhos and Rhyfoniog, which are roughly the Perfeddwlad (midland) between Conwy and Clwyd, and the lordships of Bromfield, Yale (*Idl*, open land) and Chirkland, the old possessions of Gruffydd ap Madoc, *arglwydd* (lord) of Dinas Brân. Cefn (Elwy Valley) limestone caves hold the prehistoric hippopotamus, elephant, rhinoceros, lion, hyena, bear, reindeer, &c.; Pils Heaton cave, the glutton; Pont Newydd, felseone tools and a polished stone axe (like that of Rhosdyg); Carnedd Tyddyn Bleiddian, "platycnemid (skeleton) men of Denbighshire" (like those of Perthi Chwareu). Clawdd Coch has traces of the Romans; so also Penyaeger and Penbarras. Roman roads ran from Deva (Chester) to Segontium (Carnarvon) and from Deva to Mons Heriri (*Tomen y mwr*). To their period belong the inscribed Gwytherin and Pentrefoelas (near Bettys-y-coed) stones. The Valle Crucis "Eliseig's pillar" tells of Brochmael and the Cairlegion (Chester) struggle against Æthelfrith's invading Northumbrians, A.D. 613, while Offa's dike goes back to the Mercian advance. Near and parallel to Offa's is the shorter and mysterious Watt's dike. Chirk is the only Denbighshire castle comparatively untouched by time and still occupied. Ruthin has cloisters; Wrexham, the Brynffynnon "nunnery"; and at both are collegiate churches. Llanrwst, Gresford and Derwen boast roof lofts and screens; Whitchurch and Llanrwst, portrait brasses and monuments; Derwen, a churchyard cross; Gresford and Llanrhaiadr (*Dyffryn Clwyd*), stained glass. Near Abergele, known for its sea baths, is the *ogof* (or cave), traditionally the refuge of Richard II. and the scene of his capture by Bolingbroke in 1399.

See J. Williams, *Denbigh* (1856), and T. F. Tout, *Welsh Shires*.

DENDERA, a village in Upper Egypt, situated in the angle of the great westward bend of the Nile opposite Kena. Here was the ancient city of Tentyra, capital of the Tentyrite nome, the sixth of Upper Egypt, and the principal seat of the worship of Hathor [Aphrodite] the cow-goddess of love and joy. The old Egyptian name of Tentyra was written 'In-t (Ant), but the pronunciation of it is unknown: in later days it was 'In-t-t-ntr-t, "ant of the goddess," pronounced Ni-tentōri, whence *Tētrupa*, *Tētrups*. The temple of Hathor was built in the 1st century B.C., being begun under the later Ptolemies (Ptol. XIII.) and finished by Augustus, but much of the decoration is later. A great

rectangular enclosure of crude bricks, measuring about 900 X 850 ft., contains the sacred buildings. It was entered by two stone gateways, in the north and the east sides, built by Domitian. Another smaller enclosure lies to the east with a gateway also of the Roman period.

The plan of the temple may be supposed to have included a colonnaded court in front of the present façade, and pylon towers at the entrance, but these were never built, probably for lack of funds. The building, which is of sandstone, measures about 300 ft. from front to back, and consists of two oblong rectangles; the foremost, placed transversely to the other, is the great hypostyle hall or pronaos, the broadest and loftiest part of the temple, measuring 135 ft. in width, and comprising about one-third of the whole structure; the façade has six columns with heads of Hathor, and the ceiling is supported by eighteen great columns. The second rectangle contains a small hypostyle hall with six columns, and the sanctuary, with their subsidiary chambers. The sanctuary is surrounded by a corridor into which the chambers open: on the west side is an apartment forming a court and kiosq for the celebration of the feast of the New Year, the principal festival of Dendera. On the roof of the temple, reached by two staircases, are a pavilion and several chambers dedicated to the worship of Osiris. Inside and out, the whole of the temple is covered with scenes and inscriptions in crowded characters, of ceremonial and religious import; the decoration is even carried into a remarkable series of hidden passages and chambers or crypts made in the solid walls for the reception of its most valuable treasures. The architectural style is dignified and pleasing in design and proportions. The interior of the building has been completely cleared; from the outside, however, its imposing effect is quite lost, owing to the mounds of rubbish amongst which it is sunk. North-east of the entrance is a "Birth House" for the cult of the child Harsenteu, and behind the temple a small temple of Isis, dating from the reign of Augustus. The original foundation of the temple must date back to a remote time: the work of some of the early builders is in fact referred to in the inscriptions on the present structure. Petrie's excavation of the cemetery behind the temple enclosures revealed burials dating from the fourth dynasty onwards, the most important being mastabas of the period from the sixth to the eleventh dynasties; many of these exhibited a peculiar degradation of the contemporary style of sculpture.

The zodiacs of the temple of Dendera gave rise to a considerable literature before their late origin was established by Champollion in 1822: one of them, from a chamber on the roof, was removed in 1820 to the Bibliothèque Nationale in Paris. Figures of the celebrated Cleopatra VI. occur amongst the sculptures on the exterior of the temple, but they are purely conventional, without a trace of portraiture. Horus of Edfu, the enemy of the crocodiles and hippopotami of Set, appears sometimes as the consort of Hathor of Dendera. The skill displayed by the Tentyrites in capturing the crocodile is referred to by Strabon and other Greek writers. Juvenal, in his seventeenth satire, takes as his text a religious riot between the Tentyrites and the neighbouring Ombites, in the course of which an unlucky Ombite was torn to pieces and devoured by the opposite party. The Ombos in question is not the distant Ombos south of Edfu, where the crocodile was worshipped; Petrie has shown that opposite Coptos, only about 15 m. from Tentyra, there was another Ombos, venerating the hippopotamus sacred to Set.

See A. Mariette, *Dendrah* (5 vols. atlas and text, 1869-1880). W. M. F. Petrie, *Denderah* (1900); *Nagada and Ballas* (1896) (F. Ll. G.)

DENDROCOMETES (so named by F. Stein), a genus of sectorian Infusoria, characterized by the repeatedly branched attached body; each of the lobes of the body gives off a few retractile tentacles. It is parasitic on the gills of the so-called freshwater shrimp *Gammarus pulex*.

For its conjugation see Sydney H. Hickson, in *Quarterly Journ. of Microsc. Science*, vol. xiv. (1902), p. 325.

DENE-HOLES, the name given to certain caves or excavations in England, which have been popularly supposed to be due to the

Danes or some other of the early northern invaders of the country. The common spelling "Dane hole" is adduced as evidence of this, and individual names, such as Vortigern's Caves at Margate, and Canute's Gold Mine near Bexley, naturally follow the same theory. The word, however, is probably derived from the Anglo-Saxon *den*, a hole or valley. There are many underground excavations in the south of the country, also found to some extent in the midlands and the north, but true dene-holes are found chiefly in those parts of Kent and Essex along the lower banks of the Thames. With one exception there are no recorded specimens farther east than those of the Grays Thurrock district, situated in Hangman's Wood, on the north, and one near Rochester on the south side of the river.

The general outline of the formation of these caves is invariably the same. The entrance is a vertical shaft some 3 ft in diameter falling, on an average, to a depth of 60 ft. The depth is regulated, obviously, by the depth of the chalk from the surface, but, although chalk could have been obtained close at hand within a few feet, or even inches, from the surface, a depth of from 45 to 80 ft., or more, is a characteristic feature. It is believed that dene-holes were also excavated in sand, but as these would be of a perishable nature there are no available data of any value. The shaft, when the chalk is reached, widens out into a domed chamber with a roof of chalk some 3 ft. thick. The walls frequently contract somewhat as they near the floor. As a rule there is only one chamber, from 16 to 18 ft. in height, beneath each shaft. From this excessive height it has been inferred that the caves were not primarily intended for habitations or even hiding-places. In some cases the chamber is extended, the roof being supported by pillars of chalk left standing. A rare specimen of a twin-chamber was discovered at Gravesend. In this case the one entrance served for both caves, although a separate aperture connected them on the floor level. Where galleries are found connecting the chambers, forming a bewildering labyrinth, a careful scrutiny of the walls usually reveals evidence that they are the work of a people of a much later period than that of the chambers, or, as they become in these cases, the halls of the galleries.

Isolated specimens have been discovered in various parts of Kent and Essex, but the most important groups have been found at Grays Thurrock, in the districts of Woolwich, Abbey Wood and Bexley, and at Gravesend. Those at Bexley and Grays Thurrock are the most valuable still existing.

It is generally found that the tool work on the roof or ceiling is rougher than that on the walls, where an upright position could be maintained. Casts taken of some of the pick-holes near the roof show that, in all probability, they were made by bone or horn picks. And numerous bone picks have been discovered in Essex and Kent. These pick-holes are amongst the most valuable data for the study of dene-holes, and have assisted in fixing the date of their formation to pre-Roman times. Very few relics of antiquarian value have been discovered in any of the known dene-holes which have assisted in fixing the date or determining the uses of these prehistoric excavations. Pliny mentions pits sunk to a depth of a hundred feet, "where they branched out like the veins of mines." This has been used in support of the theory that dene-holes were wells sunk for the extraction of chalk; but no known dene-hole branches out in this way. Chrétien de Troyes has a passage on underground caves in Britain which may have reference to dene-holes, and tradition of the 14th century treated the dene-holes of Grays as the fabled gold mines of Cunobeline (or Cymbeline) of the 1st century.

Vortigern's Caves at Margate are possibly dene-holes which have been adapted by later peoples to other purposes, and excellent examples of various pick-holes may be seen on different parts of the walls.

Local tradition in some cases traces the use of these caves to the smugglers, and, when it is remembered that illicit traffic was common not only on the coast but in the Thames as far up the river as Barking Creek, the theory is at least tenable that these ready-made hiding-places, difficult of approach and dangerous to descend, were so utilized.

There are three purposes for which dene-holes may have been originally excavated: (a) as hiding-places or dwellings, (b) draw-wells for the extraction of chalk for agricultural uses, and (c) store-houses for grain. For several reasons it is unlikely that they were used as habitations, although they may have been used occasionally as hiding-places. Other evidence has shown that it is equally improbable that they were used for the extraction of chalk. The chief reasons against this theory are that chalk could have been obtained outcropping close by, and that every trace of loose chalk has been removed from the vicinity of the holes, while known examples of chalk draw-wells do not descend to so great a depth. The discovery of a shallow dene-hole, about 1.4 ft. below the surface, at Stone negatives this theory still further. The last of the three possible uses for which these prehistoric excavations were designed is usually accepted as the most probable. Silos, or underground storehouses, are well known in the south of Europe and Morocco. It is supposed that the grain was stored in the ear and carefully protected from damp by straw. A curious smoothness of the roof of one of the chambers of the Gravesend twin-chamber dene-hole has been put forward as additional evidence in support of this theory. One other theory has been advanced, viz. that the excavations were made in order to get flints for implements, but this is quite impossible, as a careful examination of a few examples will show.

Further reference may be made to *Essex Dene-holes* by T. V. Holmes and W. Cole, to *The Archaeological Journal* (1882), the *Transactions of the Essex Field Club, Archaeologia Cantiana, &c.; Dene-holes* by F. W. Reader, in *Old Essex*, ed. A. C. Kelway (1908).

(A. J. P.)

DENGUE (pronounced deng-ga), an infectious fever occurring in warm climates. The symptoms are a sudden attack of fever, accompanied by rheumatic pains in the joints and muscles with severe headache and erythema. After a few days a crisis is reached and an interval of two or three days is followed by a slighter return of fever and pain and an eruption resembling measles, the most marked characteristic of the disease. The disease is rarely fatal, death occurring only in cases of extreme weakness caused by old age, infancy or other illness. Little is known of the aetiology of "dengue." The virus is probably similar to that of other exanthematous fevers and communicated by an intermediary culx. The disease is nearly always epidemic, though at intervals it appears to be pandemic and in certain districts almost endemic. The area over which the disease ranges may be stated generally to be between 32° 47' N. and 23° 23' S. Throughout this area "dengue" is constantly epidemic. The earliest epidemic of which anything is known occurred in 1779-1780 in Egypt and the East Indies. The chief epidemics have been those of 1824-1826 in India, and in the West Indies and the southern states of North America, of 1870-1875, extending practically over the whole of the tropical portions of the East and reaching as far as China. In 1888 and 1889 a great outbreak spread along the shores of the Aegean and over nearly the whole of Asia Minor. Perhaps "dengue" is most nearly endemic in equatorial East Africa and in the West Indies. The word has usually been identified with the Spanish *dengue*, meaning stiff or prim behaviour, and adopted in the West Indies as a name suitable to the curious cramped movements of a sufferer from the disease, similar to the name "dandy-fever" which was given to it by the negroes. According to the *New English Dictionary* (quoting Dr Christie in *The Glasgow Medical Journal*, September 1881), both "dengue" and "dandy" are corruptions of the Swahili word *dinga* or *denga*, meaning a sudden attack of cramp, the Swahili name for the disease being *ka-dinga pepo*.

See Sir Patrick Manson, *Tropical Diseases; a Manual of Diseases of Warm Climates* (1903).

DENHAM, DIXON (1786-1828), English traveller in West Central Africa, was born in London on the 1st of January 1786. He was educated at Merchant Taylors' School, and was articled to a solicitor, but joined the army in 1811. First in the 23rd Royal Welsh Fusiliers, and afterwards in the 54th foot, he served in the campaigns in Portugal, Spain, France and Belgium, and received the Waterloo medal. In 1821 he volunteered to join Oudney and Hugh Clapperton (q.v.), who had been sent by the

British government via Tripoli to the central Sudan. He joined the expedition at Murzuk in Fezzan. Finding the promised escort not forthcoming, Denham, whose energy was boundless, started for England to complain of the "duplicity" of the pasha of Tripoli. The pasha, alarmed, sent messengers after him with promises to meet his demands. Denham, who had reached Marseilles, consented to return, the escort was forthcoming, and Murzuk was regained in November 1822. Thence the expedition made its way across the Sahara to Bornu, reached in February 1823. Here Denham, against the wish of Oudney and Clapperton, accompanied a slave-raiding expedition into the Mandara highlands south of Bornu. The raiders were defeated, and Denham barely escaped with his life. When Oudney and Clapperton set out, December 1823, for the Hausa states, Denham remained behind. He explored the western, south and south-eastern shores of Lake Chad, and the lower courses of the rivers Waube, Logone and Shari. In August 1824, Clapperton having returned and Oudney being dead, Bornu was left on the return journey to Tripoli and England. In December 1826 Denham, promoted lieutenant-colonel, sailed for Sierra Leone as superintendent of liberated Africans. In 1828 he was appointed governor of Sierra Leone, but after administering the colony for five weeks died of fever at Freetown on the 8th of May 1828.

See *Narrative of Travels and Discoveries in Northern and Central Africa in the years 1822-1824* (London, 1826), the greater part of which is written by Denham; *The Story of Africa*, vol. i. chap. xiii. (London, 1892), by Dr Robert Brown.

DENHAM, SIR JOHN (1615-1669), English poet, only son of Sir John Denham (1559-1639), lord chief baron of the exchequer in Ireland, was born in Dublin in 1615. In 1617 his father became baron of the exchequer in England, and removed to London with his family. In Michaelmas term 1631 the future poet was entered as a gentleman commoner at Trinity College, Oxford. He removed in 1634 to Lincoln's Inn, where he was, says John Aubrey, a good student, but not suspected of being a wit. The reputation he had gained at Oxford of being the "dreamingest young fellow" gave way to a scandalous reputation for gambling. In 1634 he married Ann Cotton, and seems to have lived with his father at Egham, Surrey. In 1636 he wrote his paraphrase of the second book of the Aeneid (published in 1656 as *The Destruction of Troy*, with an excellent verse essay on the art of translation). About the same time he wrote a prose tract against gambling, *The Anatomy of Play* (printed 1651), designed to assure his father of his repentance, but as soon as he came into his fortune he squandered it at play. It was a surprise to everyone when in 1642 he suddenly, as Edmund Waller said, "broke out like the Irish rebellion, three score thousand strong, when no one was aware, nor in the least expected it" by publishing *The Sophy*, a tragedy in five acts, the subject of which was drawn from Sir Thomas Herbert's travels. At the beginning of the Civil War Denham was high sheriff for Surrey, and was appointed governor of Farnham Castle. He showed no military ability, and speedily surrendered the castle to the parliament. He was sent as a prisoner to London, but was soon permitted to join the king at Oxford.

In 1642 appeared *Cooper's Hill*, a poem describing the Thames scenery round his home at Egham. The first edition was anonymous; subsequent editions show numerous alterations, and the poem did not assume its final form until 1655. This famous piece, which was Pope's model for his *Windsor Forest*, was not new in theme or manner, but the praise which it received was well merited by its ease and grace. Moreover Denham expressed his commonplaces with great dignity and skill. He followed the taste of the time in his frequent use of antithesis and metaphor, but these devices seem to arise out of the matter, and are not of the nature of mere external ornament. At Oxford he wrote many squibs against the roundheads. One of the few serious pieces belonging to this period is the short poem "On the Earl of Strafford's Trial and Death."

From this time Denham was much in Charles I.'s confidence. He was entrusted with the charge of forwarding letters to and from the king when he was in the custody of the parliament, a

duty which he discharged successfully with Abraham Cowley, but in 1648 he was suspected by the Parliamentary authorities, and thought it wiser to cross the Channel. He helped in the removal of the young duke of York to Holland, and for some time he served Queen Henrietta Maria in Paris, being entrusted by her with despatches for Holland. In 1650 he was sent to Poland in company with Lord Crofts to obtain money for Charles II. They succeeded in raising £10,000. After two years spent at the exiled court in Holland, Denham returned to London and being quite without resources, he was for some time the guest of the earl of Pembroke at Wilton. In 1655 an order was given that Denham should restrict himself to some place of residence to be selected by himself at a distance of not less than 20 m. from London; subsequently he obtained from the Protector a licence to live at Bury St Edmunds, and in 1658 a passport to travel abroad with the earl of Pembroke. At the Restoration Denham's services were rewarded by the office of surveyor-general of works. His qualifications as an architect were probably slight, but it is safe to regard as grossly exaggerated the accusations of incompetence and peculation made by Samuel Butler in his brutal "Panegyric upon Sir John Denham's Recovery from his Madness." He eventually secured the services of Christopher Wren as deputy-surveyor. In 1660 he was also made a knight of the Bath.

In 1665 he married for the second time. His wife, Margaret, daughter of Sir William Brooke, was, according to the comte de Gramont, a beautiful girl of eighteen. She soon became known as the mistress of the duke of York, and the scandal, according to common report, shattered the poet's reason. While Denham was recovering, his wife died, poisoned, it was said, by a cup of chocolate. Some suspected the duchess of York of the crime, but the Comte de Gramont says that the general opinion was that Denham himself was guilty. No sign of poison, however, was found in the examination after Lady Denham's death. Denham survived her for two years, dying at his house near Whitehall in March 1669. He was buried on the 23rd in Westminster Abbey. In the last years of his life he wrote the bitter political satires on the shameful conduct of the Dutch War entitled "Directions to a Painter," and "Fresh Directions," continuing Edmund Waller's "Instructions to a Painter." The printer of these poems, with which were printed one by Andrew Marvell, was sentenced to stand in the pillory. In 1667 Denham wrote his beautiful elegy on Abraham Cowley.

Denham's poems include, beside those already given, a verse paraphrase of Cicero's *Cato major*, and a metrical version of the Psalms. As a writer of didactic verse, he was perhaps too highly praised by his immediate successors. Dryden called *Cooper's Hill* "the exact standard of good writing," and Pope in his *Windsor Forest* called him "majestic Denham." His collected poems with a dedicatory epistle to Charles II. appeared in 1668. Other editions followed, and they are reprinted in Chalmers' (1810) and other collections of the English poets. His political satires were printed with verse of Rochester's and Marvell's in *Bibliotheca curiosa*, vol. i. (Edinburgh, 1885).

DÉNIA, a seaport of eastern Spain, in the province of Alicante; on the Mediterranean Sea, at the head of a railway from Cartagena. Pop. (1900) 12,431. Dénia occupies the seaward slopes of a hill surmounted by a ruined castle, and divided by a narrow valley on the south from the limestone ridge of Mongó (2500 ft.), which commands a magnificent view of the Balearic Islands and the Valencian coast. The older houses of Dénia are characterized by their flat Moorish roofs (*azoteas*) and view-turrets (*miradores*), while fragments of the Moorish ramparts are also visible near the harbour; owing, however, to the rapid extension of local commerce, many of the older quarters were modernized at the beginning of the 20th century. Nails, and woollen, linen and esparto grass fabrics are manufactured here; and there is a brisk export trade in grapes, raisins and onions, mostly consigned to Great Britain or the United States. Baltic timber and British coal are largely imported. The harbour bay, which is well lighted and sheltered by a breakwater, contains only a small space of deep water, shut in by deposits of sand on three sides. In 1904 it accommodated 402 vessels of 175,000 tons; about half of which were small fishing craft, and coasters carrying agricultural produce to Spanish and African ports.

Dénia was colonized by Greek merchants from Emporiae (Ampurias in Catalonia), or Massilia (Marscilles), at a very early date; but its Greek name of *Hemerokopeion* was soon superseded by the Roman *Dianium*. In the 1st century B.C., Sertorius made it the naval headquarters of his resistance to Rome; and, as its name implies, it was already famous for its temple of Diana, built in imitation of that at Ephesus. The site of this temple can be traced at the foot of the castle hill. Dénia was captured by the Moors in 713, and from 1031 to 1253 belonged successively to the Moorish kingdoms of Murcia and Valencia. According to an ancient but questionable tradition, its population rose at this period to 50,000, and its commerce proportionately increased. After the city was retaken by the Christians in 1253, its prosperity dwindled away, and only began to revive in the 19th century. During the War of the Spanish Succession (1701-14), Dénia was thrice besieged; and in 1813 the citadel was held for five months by the French against the allied British and Spanish forces, until the garrison was reduced to 100 men, and compelled to surrender, on honourable terms.

DENIKER, JOSEPH (1852-) French naturalist and anthropologist, was born of French parents at Astrakhan, Russia, on the 6th of March 1852. After receiving his education at the university and technical institute of St Petersburg, he adopted engineering as a profession, and in this capacity travelled extensively in the petroleum districts of the Caucasus, in Central Europe, Italy and Dalmatia. Settling at Paris in 1876, he studied at the Sorbonne, where he took his degree in natural science. In 1888 he was appointed chief librarian of the Natural History Museum, Paris. Among his many valuable ethnological works mention may be made of *Recherches anatomiques et embryologiques sur les singes anthropoïdes* (1886); *Étude sur les Kalmonks* (1883); *Les Ghiliaks* (1883); and *Races et peuples de la terre* (1900). He became one of the chief editors of the *Dictionnaire de géographie universelle*, and published many papers in the anthropological and zoological journals of France.

DENILQUIN, a municipal town of Townsend county, New South Wales, Australia, 534 m. direct S.W. of Sydney, and 195 m. by rail N. of Melbourne. Pop. (1901) 2644. The business of the town is chiefly connected with the interests of the sheep and cattle farmers of the Riverina district, a plain country, in the main pastoral, but suited in some parts for cultivation. Denilquin has a well-known public school.

DENIM (an abbreviation of *serge de Nîmes*), the name originally given to a kind of serge. It is now applied to a stout twilled cloth made in various colours, usually of cotton, and used for overalls, &c.

DENINA, CARLO GIOVANNI MARIA (1731-1813), Italian historian, was born at Revello, Piedmont, in 1731, and was educated at Saluzzo and Turin. In 1753 he was appointed to the chair of humanity at Pignerol, but he was soon compelled by the influence of the Jesuits to retire from it. In 1756 he graduated as doctor in theology, and began authorship with a theological treatise. Promoted to the professorship of humanity and rhetoric in the college of Turin, he published (1760-1772) his *Delle rivoluzioni d'Italia*, the work on which his reputation is mainly founded. Collegiate honours accompanied the issue of its successive volumes, which, however, at the same time multiplied his foes and stimulated their hatred. In 1782, at Frederick the Great's invitation, he went to Berlin, where he remained for many years, in the course of which he published his *Vie et règne de Frédéric II* (Berlin, 1788) and *La Prusse littéraire sous Frédéric II* (3 vols., Berlin, 1790-1791). His *Delle rivoluzioni della Germania* was published at Florence in 1804, in which year he went to Paris as the imperial librarian, on the invitation of Napoleon. At Paris he published in 1805 his *Tableau de la Haute Italie, et des Alpes qui l'enlourcent*. He died there on the 5th of December 1813.

DENIS (DIONYSIUS), SAINT, first bishop of Paris, patron saint of France. According to Gregory of Tours (*Hist. Franc. i. 30*), he was sent into Gaul at the time of the emperor Decius. He suffered martyrdom at the village of Catulliacus, the modern St Denis. His tomb was situated by the side of the Roman r—

where rose the priory of St-Denis-de-l'Éstrée, which existed until the 18th century. In the 5th century the clergy of the diocese of Paris built a basilica over the tomb. About 625 Dagobert, son of Lothair II., founded in honour of St Denis, at some distance from the basilica, the monastery where the greater number of the kings of France have been buried. The festival of St Denis is celebrated on the 9th of October. With his name are already associated in the *Martyrologium Hieronymianum* the priest Rusticus and the deacon Eleutherius. Other traditions—of no value—are connected with the name of St Denis. A false interpretation of Gregory of Tours, apparently dating from 724, represented St Denis as having received his mission from Pope Clement, and as having suffered martyrdom under Domitian (81–96). Hilduin, abbot of St-Denis in the first half of the 9th century, identified Denis of Paris with Denis (Dionysius) the Areopagite (mentioned in Acts xviii. 34), bishop of Athens (Eusebius, *Hist. Eccl.* iii. 4. 10, iv. 23. 3), and naturally attributed to him the celebrated writings of the pseudo-Areopagite. St Denis is generally represented carrying his head in his hands.

See *Acta Sanctorum*, Octobris, iv. 696–987; *Bibliotheca hagiographica graeca*, p. 37 (Brussels, 1895); *Bibliotheca hagiographica latina*, No. 2171–2203 (Brussels, 1895); J. Havet, *Les Origines de Saint-Denis*, in his collected works, i. 191–246 (Paris, 1896); *Cahier, Caractéristiques des saints*, p. 761 (Paris, 1867).

DENIS, JOHANN NEPOMUK COSMAS MICHAEL (1720–1800), Austrian poet, was born at Schöding on the Inn, on the 27th of September 1720. He was brought up by the Jesuits, entered their order, and in 1759 was appointed professor in the Theresianum in Vienna, a Jesuit college. In 1784, after the suppression of the college, he was made second custodian of the court library, and seven years later became chief librarian. He died on the 29th of September 1800. A warm admirer of Klopstock, he was one of the leading members of the group of so-called "bards", and his original poetry, published under the title *Die Lieder Sineds des Barden* (1772), shows all the extravagances of the "bardic" movement. He is best remembered as the translator of *Ossian* (1768–1769; also published together with his own poems in 5 vols. as *Ossians und Sineds Lieder*, 1784). More important than either his original poetry or his translations were his efforts to familiarize the Austrians with the literature of North Germany; his *Sammlung kürzerer Gedichte aus den neuern Dichtern Deutschlands*, 3 vols. (1762–1766), was in this respect invaluable. He has also left a number of bibliographical compilations, *Grundriss der Bibliographie und Bücherkunde* (1774), *Grundriss der Literaturgeschichte* (1776), *Einsleitung in die Bücherkunde* (1777) and *Wiens Buchdruckergeschichte bis 1500* (1782).

Ossians und Sineds Lieder have not been reprinted since 1791; but a selection of his poetry edited by R. Hamel was found in vol. 48 (1884) of Kürschner's *Deutsche Nationalliteratur*. His *Literarischer Nachlass* was published by J. F. von Retzer in 1802 (2 vols.). See P. von Hofmann-Wellenhof, *Michael Denis* (1881).

DENISON, GEORGE ANTHONY (1805–1866), English churchman, brother of John Evelyn Denison (1800–1873; speaker of the House of Commons 1857–1872; Viscount Ossington), was born at Ossington, Notts, on the 11th of December 1805, and educated at Eton and Christ Church, Oxford. In 1828 he was elected fellow of Oriel; and after a few years there as a tutor, during which he was ordained and acted as curate at Cuddesdon, he became rector of Broadwindsor, Dorset (1838). He became a prebendary of Sarum in 1841 and of Wells in 1849. In 1851 he was preferred to the valuable living of East Brent, Somerset, and in the same year was made archdeacon of Taunton. For many years Archdeacon Denison represented the extreme High Tory party not only in politics but in the Church, regarding all "progressive" movements in education or theology as abomination, and vehemently repudiating the "higher criticism" from the days of *Essays and Reviews* (1860) to those of *Luz Mundi* (1890). In 1853 he resigned his position as examining chaplain to the bishop of Bath and Wells owing to his pronounced eucharistic views. A suit on the complaint of a neighbouring clergyman ensued and after various complications Denison was condemned by the archbishops' court at Bath (1856); but on

appeal the court of Arches and the privy council quashed this judgment on a technical plea. The result was to make Denison a keen champion of the ritualistic school. He edited *The Church and State Review* (1867–1865). Secular state education and the "conscience clause" were anathema to him. Until the end of his life he remained a protagonist in theological controversy and a keen fighter against latitudinarianism and liberalism; but the sharpest religious or political differences never broke his personal friendships and his Christian charity. Among other things for which he will be remembered was his origination of harvest festivals. He died on the 21st of March 1896.

DENISON, GEORGE TAYLOR (1839–), Canadian soldier and publicist, was born in Toronto on the 31st of August 1839. In 1861 he was called to the bar, and was from 1865–1867 a member of the city council. From the first he took a prominent part in the organization of the military forces of Canada, becoming a lieutenant-colonel in the active militia in 1866. He saw active service during the Fenian raid of 1866, and during the rebellion of 1885. Owing to his dissatisfaction with the conduct of the Conservative ministry during the Red River Rebellion in 1869–70, he abandoned that party, and in 1872 unsuccessfully contested Algoma in the Liberal interest. Thereafter he remained free from party ties. In 1877 he was appointed police magistrate of Toronto. Colonel Denison was one of the founders of the "Canada First" party, which did much to shape the national aspirations from 1870 to 1878, and was a consistent supporter of imperial federation and of preferential trade between Great Britain and her colonies. He became a member of the Royal Society of Canada, and was president of the section dealing with English history and literature. The best known of his military works is his *History of Modern Cavalry* (London, 1877), which was awarded first prize by the Russian government in an open competition and has been translated into German, Russian and Japanese. In 1900 he published his reminiscences under the title of *Soldiering in Canada*.

DENISON, a city of Grayson county, Texas, U.S.A., about 2½ m. from the S. bank of the Red river, about 70 m. N. of Dallas. Pop. (1890) 10,958; (1900) 11,807, of whom 2251 were negroes; (1910 census) 13,632. It is served by the Houston & Texas Central, the Missouri, Kansas & Texas, the Texas & Pacific, and the St Louis & San Francisco ("Frisco System") railways, and is connected with Sherman, Texas, by an electric line. Denison is the seat of the Gate City business college (generally known as Harshaw Academy), and of St Xavier's academy (Roman Catholic). It is chiefly important as a railway centre, as a collecting and distributing point for the fruit, vegetables, hogs and poultry, and general farming products of the surrounding region, and as a wholesale and jobbing market for the upper Red river valley. It has railway repair shops, and among its manufactures are cotton-seed oil, cotton, machinery and foundry products, flour, wooden-ware, and dairy products. In 1905 its factory products were valued at \$1,234,056, 47·0 % more than in 1900. Denison was settled by Northerners at the time of the construction of the Missouri, Kansas & Texas railway to this point in 1872, and was named in honour of George Denison (1822–1876), a director of the railway; it became a city in 1891, and in 1907 adopted the commission form of government.

DENIZEN (derived through the Fr. from Lat. *de intus*, "from within," i.e. as opposed to "foreign"), an alien who obtains by letters patent (*ex donatione regis*) certain of the privileges of a British subject. He cannot be a member of the privy council or of parliament, or hold any civil or military office of trust, or take a grant of land from the crown. The Naturalization Act 1870 provides that nothing therein contained shall affect the grant of any letters of denization by the sovereign.

DENIZLI (anc. *Laodicea* (q.v.) *ad Lycum*), chief town of a sanjak of the Aidin vilayet of Asia Minor, altitude 1167 ft. Pop. about 17,000. It is beautifully situated at the foot of Baba Dagh (Mt. Salbacus), on a tributary of the Churuk Su (Lycus), and is connected by a branch line with the station of Gonjeli on the Smyrna-Dineir railway. It took the place of Laodicea when that town was deserted during the wars between the

Byzantines and Seljuk Turks, probably between 1158 and 1174. It had become a fine Moslem city in the 14th century, and was then called Ladiq, being famous for the woven and embroidered products of its Greek inhabitants. The delightful gardens of Denizli have obtained for it the name of the "Damascus of Anatolia."

DENMAN, THOMAS, 1ST BARON (1779-1854), English judge, was born in London, the son of a well-known physician, on the 23rd of July 1779. He was educated at Eton and St John's College, Cambridge, where he graduated in 1800. Soon after leaving Cambridge he married; and in 1806 he was called to the bar at Lincoln's Inn, and at once entered upon practice. His success was rapid, and in a few years he attained a position at the bar second only to that of Brougham and Scarlett (Lord Abinger). He distinguished himself by his eloquent defence of the Luddites; but his most brilliant appearance was as one of the counsel for Queen Caroline. His speech before the Lords was very powerful, and some competent judges even considered it not inferior to Brougham's. It contained one or two daring passages, which made the king his bitter enemy, and retarded his legal promotion. At the general election of 1818 he was returned M.P. for Wareham, and at once took his seat with the Whig opposition. In the following year he was returned for Nottingham, for which place he continued to sit till his elevation to the bench in 1832. His liberal principles had caused his exclusion from office till in 1822 he was appointed common serjeant by the corporation of London. In 1830 he was made attorney-general under Lord Grey's administration. Two years later he was made lord chief justice of the King's Bench, and in 1834 he was raised to the peerage. As a judge he is most celebrated for his decision in the important privilege case of *Stockdale v. Hansard* (9 Ad. & El. 1.; 11 Ad. & El. 253), but he was never ranked as a profound lawyer. In 1850 he resigned his chief justiceship and retired into private life. He died on the 26th of September 1854, his title continuing in the direct line.

The Hon. **GEORGE DENMAN** (1819-1896), his fourth son, was also a distinguished lawyer, and a judge of the Queen's Bench from 1872 till his death in 1896.

See *Memoirs of Thomas, first Lord Denman*, by Sir Joseph Arnould (2 vols., 1873); E. Manson, *Builders of our Law* (1904).

DENMARK (*Denmark*), a small kingdom of Europe, occupying part of a peninsula and a group of islands dividing the Baltic and North Seas, in the middle latitudes of the eastern coast. The kingdom lies between 54° 33' and 57° 45' N. and between 8° 4' 54" and 12° 47' 25" E., exclusive of the island of Bornholm, which, as will be seen, is not to be included in the Danish archipelago. The peninsula is divided between Denmark and Germany (Schleswig-Holstein). The Danish portion is the northern and the greater, and is called Jutland (Dan. *Jylland*). Its northern part is actually insular, divided from the mainland by the Limfjord or Liimfjord, which communicates with the North Sea to the west and the Kattegat to the east, but this strait, though broad and possessing lacustrine characteristics to the west, has only very narrow entrances. The connexion with the North Sea dates from 1825. The Skagerrack bounds Jutland to the north and north-west. The Kattegat is divided from the Baltic by the Danish islands, between the east coast of the Cimbric peninsula in the neighbourhood of the German frontier and south-western Sweden.

There is little variety in the surface of Denmark. It is uniformly low, the highest elevation in the whole country, the Himmelbjerg near Aarhus in eastern Jutland, being little more than 500 ft. above the sea. Denmark, however, is nowhere low in the sense in which Holland is; the country is pleasantly diversified, and rises a little at the coast even though it remains flat inland. The landscape of the islands and the south-eastern part of Jutland is rich in beech-woods, corn fields and meadows, and even the minute islets are green and fertile. In the western and northern districts of Jutland this condition gives place to a wide expanse of moorland, covered with heather, and ending towards the sea in low whitish-grey cliffs. There is a certain charm even about these monotonous tracts, and it cannot be

said that Denmark is wanting in natural beauty of a quiet order. Lakes, though small, are numerous; the largest are the Arresø and the Esromsø in Zealand, and the chain of lakes in the Himmelbjerg region, which are drained by the largest river in Denmark, the Gudenaa, which, however, has a course not exceeding 80 m. Many of the meres, overhung with thick beech-woods, are extremely beautiful. The coasts are generally low and sandy; the whole western shore of Jutland is a succession of sand ridges and shallow lagoons, very dangerous to shipping. In many places the sea has encroached; even in the 19th century entire villages were destroyed, but during the last twenty years of the century systematic efforts were made to secure the coast by groynes and embankments. A belt of sand dunes, from 500 yds. to 7 m. wide, stretches along the whole of this coast for about 200 m. Skagen, or the Skaw, a long, low, sandy point, stretches far into the northern sea, dividing the Skagerrack from the Kattegat. On the western side the coast is bolder and less inhospitable; there are several excellent havens, especially on the islands. The coast is nowhere, however, very high, except at one or two points in Jutland, and at the eastern extremity of Møen, where limestone cliffs occur.

Continental Denmark is confined wholly to Jutland, the geographical description of which is given under that heading. Out of the total area of the kingdom, 14,829 sq. m., Jutland, including the small islands adjacent to it, covers 9753 sq. m., and the insular part of the kingdom (including Bornholm), 5076 sq. m. The islands may be divided into two groups, consisting of the two principal islands Fünen and Zealand, and the lesser islands attendant on each. Fünen (Dan. *Fyen*), in form roughly an oval with an axis from S.E. to N.W. of 53 m., is separated from Jutland by a channel not half a mile wide in the north, but averaging 10 m. between the island and the Schleswig coast, and known as the Little Belt. Fünen, geologically a part of southern Jutland, has similar characteristics, a smiling landscape of fertile meadows, the typical beech-forests clothing the low hills and the presence of numerous erratic blocks, are the superficial signs of likeness. Several islands, none of great extent, lie off the west coast of Fünen in the Little Belt; off the south, however, an archipelago is enclosed by the long narrow islands of Aerø (16 m. in length) and Langeland (32 m.), including in a triangular area of shallow sea the islands of Taasinge, Avernakø, Dreiø, Turø and others. These are generally fertile and well cultivated. Aerøskjøbing and Rudkjøbing, on Aerø and Langeland respectively, are considerable ports. On Langeland is the great castle of Tranekjaer, whose record dates from the 13th century. The chief towns of Fünen itself are all coastal. Odense is the principal town, lying close to a great inlet behind the peninsula of Hindsholm on the north-east, known as Odense Fjord. Nyborg on the east is the port for the steam-ferry to Korsør in Zealand; Svendborg picturesquely overlooks the southern archipelago; Faaborg on the south-west lies on a fjord of the same name; Assens, on the west, a port for the crossing of the Little Belt into Schleswig, still shows traces of the fortifications which were stormed by John of Ranzau in 1535; Middelfart is a seaside resort near the narrowest reach of the Little Belt; Bogense is a small port on the north coast. All these towns are served by railways radiating from Odense. The strait crossed by the Nyborg-Korsør ferry is the Great Belt which divides the Fünen from the Zealand group, and is continued south by the Langelands Belt, which washes the straight eastern shore of that island, and north by the Samsø Belt, named from an island 15 m. in length, with several large villages, which lies somewhat apart from the main archipelago.

Zealand, or Sealand (Dan. *Sjælland*), measuring 82 m. N. to S. by 63 E. to W. (extremes), with its fantastic coast-line indented by fjords and projecting into long spits or promontories, may be considered as the nucleus of the kingdom, inasmuch as it contains the capital, Copenhagen, and such important towns as Roskilde, Slagelse, Korsør, Naestved and Elsinore (Helsingør). Its topography is described in detail under ZEALAND. Its attendant islands lie mainly to the south and are parts of itself, only separated by geologically recent troughs. The c

coast of Møen is rocky and bold. It is recorded that this island formed three separate isles in 1100, and the village of Borre, now 2 m. inland, was the object of an attack by a fleet from Lübeck in 1510. On Falster is the port of Nykjøbing, and from Gjedser, the extreme southern point of Denmark, communication is maintained with Warnemünde in Germany (29 m.). From Nykjøbing a bridge nearly one-third of a mile long crosses to Laaland, at the west of which is the port of Nakskov; the other towns are the county town of Maribo with its fine church of the 14th century, Saxkjøbing and Rødbý. The island of Bornholm lies 86 m. E. of the nearest point of the archipelago, and as it belongs geologically to Sweden (from which it is distant only 22 m.) must be considered to be physically an appendage rather than an internal part of the kingdom of Denmark.

Geology.—The surface in Denmark is almost everywhere formed by the so-called Boulder Clay and what the Danish geologists call the Boulder Sand. The former, as is well known, owes its origin to the action of ice on the mountains of Norway in the Glacial period. It is unstratified; but by the action of water on it, stratified deposits have been formed, some of clay, containing remains of arctic animals, some, and very extensive ones, of sand and gravel. This boulder sand forms almost everywhere the highest hills, and besides, in the central part of Jutland, a wide expanse of heath and moorland apparently level, but really sloping gently towards the west. The deposits of the boulder formation rest generally on limestone of the Cretaceous period, which in many places comes near the surface and forms cliffs on the sea-coast. Much of the Danish chalk, including the well-known limestone of Faxø, belongs to the highest or "Danian" subdivision of the Cretaceous period. In the south-western parts a succession of strata, described as the Brown Coal or Lignite formations, intervenes between the chalk and the boulder clay; its name is derived from the deposits of lignite which occur in it. It is only on the island of Bornholm that older formations come to light. This island agrees in geological structure with the southern part of Sweden, and forms, in fact, the southernmost portion of the Scandinavian system. There the boulder clay lies immediately on the primitive rock, except in the south-western corner of the island, where a series of strata appear belonging to the Cambrian, Silurian, Jurassic and Cretaceous formations, the true Coal formation, &c., being absent. Some parts of Denmark are supposed to have been finally raised out of the sea towards the close of the Cretaceous period; but as a whole the country did not appear above the water till about the close of the Glacial period. The upheaval of the country, a movement common to a large part of the Scandinavian peninsula, still continues, though slowly, north-east of a line drawn in a south-easterly direction from Nissumfjord on the west coast of Jutland, across the island of Fyen, a little south of the town of Nyborg. Ancient sea-beaches, marked by accumulations of seaweed, rolled stones, &c., have been noticed as much as 20 ft. above the present level. But the upheaval does not seem to affect all parts equally. Even in historic times it has vastly changed the aspect and configuration of the country.

Climate, Flora, Fauna.—The climate of Denmark does not differ materially from that of Great Britain in the same latitude; but whilst the summer is a little warmer, the winter is colder, so that most of the evergreens which adorn an English garden in the winter cannot be grown in the open in Denmark. During thirty years the annual mean temperature varied from 43-88° F. to 46-22° in different years and different localities, the mean average for the whole country being 45-14°. The islands have, upon the whole, a somewhat warmer climate than Jutland. The mean temperatures of the four coldest months, December to March, are 33-26°, 31-64°, 31-82°, and 33-98° respectively, or for the whole winter 32-7°; that of the summer, June to August, 59-2°, but considerable irregularities occur. Frost occurs on an average on twenty days in each of the four winter months, but only on two days in either October or May. A fringe of ice generally lines the greater part of the Danish coasts on the eastern side for some time during the winter, and both the Sound and the Belt are at times impassable on account of ice. In some

winters the latter is sufficiently firm and level to admit of sledges passing between Copenhagen and Malmø. The annual rainfall varies between 21-58 in. and 27-87 in. in different years and different localities. It is highest on the west coast of Jutland; while the small island of Anholt in the Cattegat has an annual rainfall of only 15-78 in. More than half the rainfall occurs from July to November, the wettest month being September, with an average of 2-95 in.; the driest month is April, with an average of 1-14 in. Thunderstorms are frequent in the summer. South-westerly winds prevail from January to March, and from September to the end of the year. In April the east wind, which is particularly searching, is predominant, while westerly winds prevail from May to August. In the district of Aalborg, in the north of Jutland, a cold and dry N.W. wind called *skai* prevails in May and June, and is exceedingly destructive to vegetation; while along the west coast of the peninsula similar effects are produced by a salt mist, which carries its influence from 15 to 30 m. inland.

The flora of Denmark presents greater variety than might be anticipated in a country of such simple physical structure. The ordinary forms of the north of Europe grow freely in the mild air and protected soil of the islands and the eastern coast; while on the heaths and along the sandhills on the Atlantic side there flourish a number of distinctive species. The Danish forest is almost exclusively made up of beech, a tree which thrives better in Denmark than in any other country of Europe. The oak and ash are now rare, though in ancient times both were abundant in the Danish islands. The elm is also scarce. The almost universal predominance of the beech is by no means of ancient origin, for in the first half of the 17th century the oak was still the characteristic Danish tree. No conifer grows in Denmark except under careful cultivation, which, however, is largely practised in Jutland (*q.v.*). But again, abundant traces of ancient extensive forests of fir and pine are found in the numerous peat bogs which supply a large proportion of the fuel locally used. In Bornholm, it should be mentioned, the flora is more like that of Sweden; not the beech, but the pine, birch and ash are the most abundant trees.

The wild animals and birds of Denmark are those of the rest of central Europe. The larger quadrupeds are all extinct; even the red deer, formerly so abundant that in a single hunt in Jutland in 1593 no less than 1600 head of deer were killed, is now only to be met with in preserves. In the prehistoric "kitchen-middens" (*højekkenmødding*) and elsewhere, however, vestiges are found which prove that the urochs, the wild boar, the beaver, the bear and the wolf all existed subsequently to the arrival of man. The usual domestic animals are abundantly found in Denmark, with the exception of the goat, which is uncommon. The sea fisheries are of importance. Oysters are found in some places, but have disappeared from many localities, where their abundance in ancient times is proved by their shell moulds on the coast. The Gudenaå is the only salmon river in Denmark.

Population.—The population of Denmark in 1901 was 2,449,540. It was 929,001 in 1801, showing an increase during the century in the proportion of 1 to 2-63. In 1901 the average density of the population of Denmark was 165-2 to the square mile, but varied much in the different parts. Jutland showed an average of only 109 inhabitants per square mile, whilst on the islands, which had a total population of 1,385,537, the average stood at 272-95, owing, on the one hand, to the fact that large tracts in the interior of Jutland are almost uninhabited, and on the other to the fact that the capital of the country, with its proportionately large population, is situated on the island of Zealand. The percentages of urban and rural population are respectively about 38 and 62. A notable movement of the population to the towns began about the middle of the 19th century, and increased until very near its end. It was stronger on the islands, where the rural population increased by 5-3% only in eleven years, whereas in Jutland the increase of the rural population between 1890 and 1901 amounted to 12-0%. Here, however, peculiar circumstances contributed to the increase, as successful efforts have been made to render the land fruitful by artificial means. The

DENMARK

SKAGERRACK

English Miles
0 10 20 30 40

Counties of Denmark
County Boundaries
Railways
Canals
Marshes

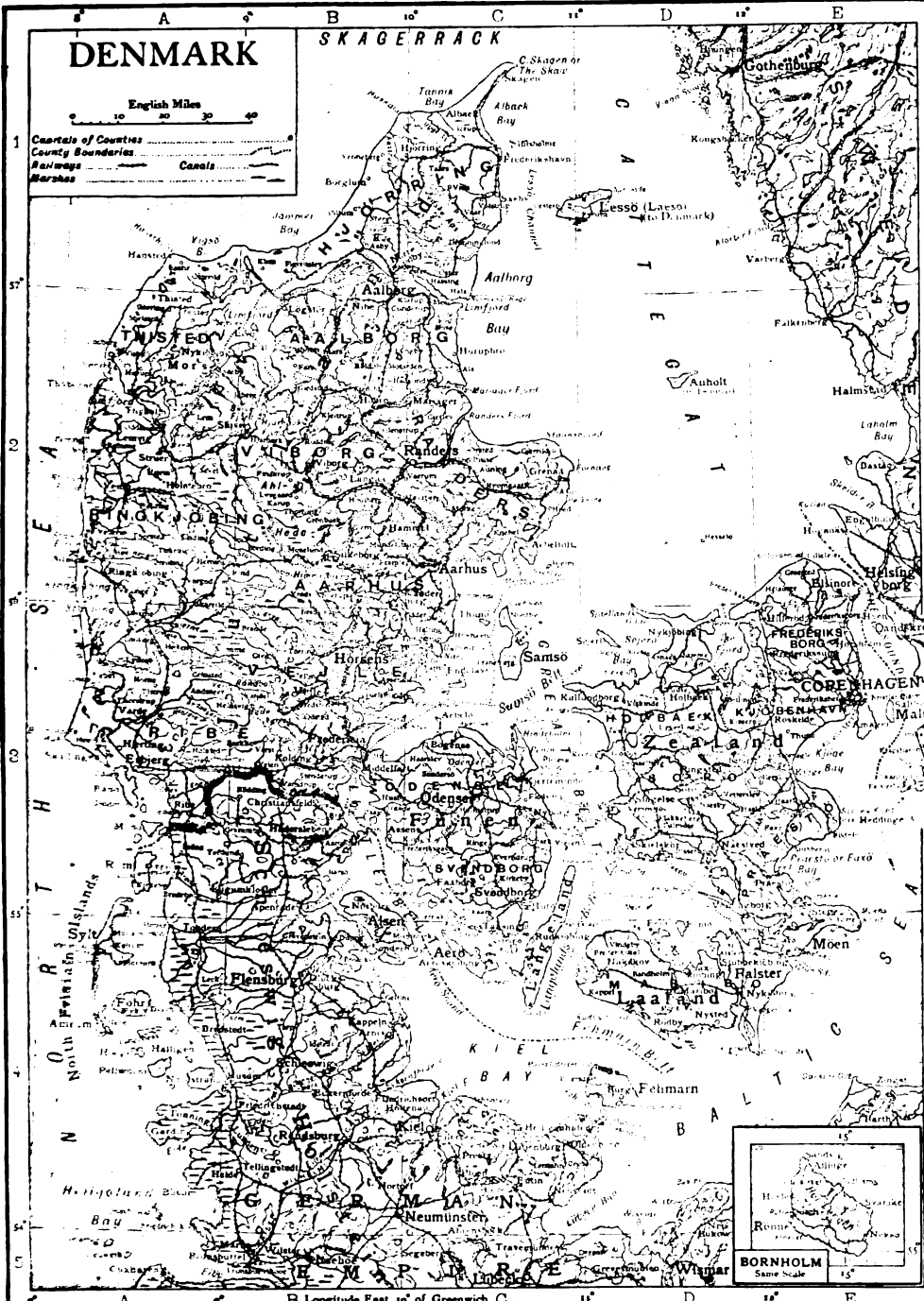

BORNHOLM
Same Scale

B Longitude East 10° of Greenwich C. 11° D. 12° E.

Danes are a yellow-haired and blue-eyed Teutonic race of middle stature, bearing traces of their kinship with the northern Scandinavian peoples. Their habits of life resemble those of the North Germans even more than those of the Swedes. The independent tenure of the land by a vast number of small farmers, who are their own masters, gives an air of carelessness, almost of truce, to the well-to-do Danish peasants. They are generally slow of speech and manner, and somewhat irresolute, but take an eager interest in current politics, and are generally fairly educated men of extreme democratic principles. The result of a fairly equal distribution of wealth is a marked tendency towards equality in social intercourse. The townspeople show a bias in favour of French habits and fashions. The separation from the duchies of Schleswig and Holstein, which were more than half German, intensified the national character; the Danes are intensely patriotic; and there is no portion of the Danish dominions except perhaps in the West Indian islands, where a Scandinavian language is not spoken. The preponderance of the female population over the male is approximately as 1052 to 1000. The male sex remains in excess until about the twentieth year, from which age the female sex preponderates in increasing ratio with advancing age. The percentage of illegitimacy is high as a whole, although in some of the rural districts it is very low. But in Copenhagen 20 % of the births are illegitimate. Between the middle and the end of the 19th century the rate of mortality decreased most markedly for all ages. During the last decade of the century it ranged between 19.5 per thousand in 1891 and 15.1 in 1898 (17.4 in 1900). Emigration for some time in the 19th century at different periods, both in its early part and towards its close, seriously affected the population of Denmark. But in the last decade it greatly diminished. Thus in 1892 the number of emigrants to Transatlantic places rose to 10,422 but in 1900 it was only 3570. The great bulk of them go to the United States; next in favour is Canada.

Communications.—The roads of Denmark form an extensive and well-maintained system. The railway system is also fairly complete, the state owning about three-fifths of the total mileage, which amounts to some 2000. Two lines enter Denmark from Schleswig across the frontier. The main Danish lines are as follows. From the frontier a line runs east by Fredericia, across the island of Fünen by Odense and Nyborg, to Korsør on Zealand, and thence by Roskilde to Copenhagen. The straits between Fredericia and Middelfart and between Nyborg and Korsør are crossed by powerful steam-ferris which are generally capable of conveying a limited number of railway wagons. This system is also in use on the line which runs south from Roskilde to the island of Falster, from the southernmost point of which, Gjedser, ferry-steamers taking railway cars serve Warnemünde in Germany. The main lines in Jutland run (a) along the eastern side north from Fredericia by Horsens, Aarhus, Randers, Aalborg and Hjørring, to Frederikshavn, and (b) along the western side from Esbjerg by Skjerve and Vemb, and thence across the peninsula by Viborg to Langaa on the eastern line. The lines are generally of standard gauge (4 ft. 8½ in.), but there is also a considerable mileage of light narrow-gauge railways. Besides the numerous steam-ferris which connect island and island, and Jutland with the islands, and the Gjedser-Warnemünde route, a favourite passenger line from Germany is that between Kiel and Korsør, while most of the German Baltic ports have direct connexion with Copenhagen. With Sweden communications are established by ferris across the Sound between Copenhagen and Malmö and Landskrona, and between Elsinore (Helsingör) and Helsingborg. The postal department maintains a telegraph and telephone service.

Industries.—The main source of wealth in Denmark is agriculture, which employs about two-fifths of the entire population. Most of the land is freehold and cultivated by the owner himself, and comparatively little land is let on lease except very large holdings and glebe farms. The independent small farmer (*bonde*) maintains a hereditary attachment to his ancestral holding. There is also a class of cottar freeholders (*junster*). Fully 74 % of the total area of the country is agricultural land.

Of this only about one-twelfth is meadow land. The land under grain crops is not far short of one-half the remainder, the principal crops being oats, followed by barley and rye in about equal quantities, with wheat about one-sixth that of barley and hardly one-tenth that of oats. Beet is extensively grown. During the last forty years of the 19th century dairy-farming was greatly developed in Denmark, and brought to a high degree of perfection by the application of scientific methods and the best machinery, as well as by the establishment of joint dairies. The Danish government has assisted this development by granting money for experiments and by a rigorous system of inspection for the prevention of adulteration. The co-operative system plays an important part in the industries of butter-making, poultry-farming and the rearing of swine.

Rabbits, which are not found wild in Denmark, are bred for export. Woods cover fully 7 % of the area, and their preservation is considered of so much importance that private owners are under strict control as regards cutting of timber. The woods consist mostly of beech, which is principally used for fuel, but pines were extensively planted during the 19th century. Allusion has been made already to the efforts to plant the extensive heaths in Jutland (*q.v.*) with pine-trees.

Agriculture.—Rates and taxes on land are mostly levied according to a uniform system of assessment, the unit of which is called a *Tonde Hartkorn*. The Td. Htk., as it is usually abbreviated, has further subdivision, and is intended to correspond to the same value of land throughout the country. The Danish measure for land is a *Tonde Land* (Td. L.), which is equal to 1.363 statute acres. Of the best ploughing land a little over 6 Td. L., or about 8 acres, go to a Td. Htk., but of unprofitable land a Td. Htk. may represent 300 acres or more. On the islands and in the more fertile part of Jutland the average is about 10 Td. L., or 13½ acres. Woodland, tithes, &c., are also assessed to Td. Htk. for fiscal purposes. In the island of Bornholm, the assessment is somewhat different, though the general state of agricultural holdings is the same as in other parts. The selling value of land has shown a decrease in modern times on account of the agricultural depression. A homestead with land assessed less than 1 Td. Htk. is legally called a *Huus* or *Sted*, i.e. cottage, whilst a farm assessed at 1 Td. Htk. or more is called *Gaard*, i.e. farm. Farms of between 1 and 12 Td. Htk. are called *Bøndergaarde*, or peasant farms, and are subject to the restriction that such a holding cannot lawfully be joined to or entirely merged into another. They may be subdivided, and portions may be added to another holding, but the homestead, with a certain amount of land, must be preserved as a separate holding for ever. The seats of the nobility and landed gentry are called *Herregarde*. The peasants hold about 73 % of all the land according to its value. As regards their size about 30 % are assessed from 1 to 4 Td. Htk.; about 33 % from 4 to 8 Td. Htk.; the remainder at about 8 Td. Htk. An annual sum is voted by parliament out of which loans are granted to cottagers who desire to purchase small freehold plots.

The fishery along the coasts of Denmark is of some importance both on account of the supply of food obtained thereby for the population of the country, and on account of the export; but the good fishing grounds, not far from the Danish coast, particularly in the North Sea, are mostly worked by the fishing vessels of other nations, which are so numerous that the Danish government is obliged to keep gun-boats stationed there in order to prevent encroachments on territorial waters.

Other Industries.—The mineral products of Denmark are unimportant. It is one of the poorest countries of Europe in this particular. It is rich, however, in clays, while in the island of Bornholm there are quarries of freestone and marble. The factories of Denmark supply mainly local needs. The largest are those engaged in the construction of engines and iron ships. The manufacture of woollens and cotton, the domestic manufacture of linen in Zealand, sugar refineries, paper mills, breweries, and distilleries may also be mentioned. The most notable manufacture is that of porcelain. The nucleus of this industry was a factory started in 1772, by F. H. Müller, for the making of china out of Bornholm clay. In 1779 it passed into the hands of the

state, and has remained there ever since, though there are also private factories. Originally the Copenhagen potters imitated the Dresden china made at Meissen, but they later produced graceful original designs. The creations of Thorvaldsen have been largely repeated and imitated in this ware. Trade-unionism flourishes in Denmark, and strikes are of frequent occurrence.

Commerce.—Formerly the commercial legislation of Denmark was to such a degree restrictive that imported manufactures had to be delivered to the customs, where they were sold by public auction, the proceeds of which the importer received from the custom-houses after a deduction was made for the duty. To this restriction, as regards foreign intercourse, was added a no less injurious system of inland duties impeding the commerce of the different provinces with each other. The want of roads also, and many other disadvantages, tended to keep down the development of both commerce and industry. During the 19th century, however, several commercial treaties were concluded between Denmark and the other powers of Europe, which made the Danish tariff more regular and liberal.

The vexed question, of many centuries' standing, concerning the claim of Denmark to levy dues on vessels passing through the Sound (*q.v.*), was settled by the abolition of the dues in 1857. The commerce of Denmark is mainly based on home production and home consumption, but a certain quantity of goods is imported with a view to re-exportation, for which the free port and bonded warehouses at Copenhagen give facilities. In modern times the value of Danish commerce greatly increased, being doubled in the last twenty years of the 19th century, and exceeding a total of fifty millions sterling. The value of export is exceeded as a whole by that of import in the proportion, roughly, of 1 to 1.35. By far the most important articles of export may be classified as articles of food of animal origin, a group which covers the vast export trade in the dairy produce, especially butter, for which Denmark is famous. The value of the butter for export reaches nearly 40% of the total value of Danish exports. A small proportion of the whole is imported chiefly from Russia (also Siberia) and Sweden and re-exported as of foreign origin. The production of margarine is large, but not much is exported, margarine being largely consumed in Denmark instead of butter, which is exported. Next to butter the most important article of Danish export is bacon, and huge quantities of eggs are also exported. Exports of less value, but worthy of special notice, are vegetables and wool, bones and tallow, also dairy machinery, and finally cement, the production of which is a growing industry. The classes of articles of food of animal origin, and living animals, are the only ones of which the exportation exceeds the importation; with regard to all other goods, the reverse is the case. In the second of these classes the most important export is home-bred horned cattle. The trade in live sheep and swine, which was formerly important, has mostly been converted into a dead-meat trade. A proportionally large importation of timber is caused by the scarcity of native timber suitable for building purposes, the plantations of firs and pines being insufficient to produce the quantity required, and the quality of the wood being inferior beyond the age of about forty years. The large importation of coal, minerals and metals, and goods made from them is likewise caused by the natural poverty of the country in these respects.

Denmark carries on its principal import trade with Germany, Great Britain and the United States of America, in this order, the proportions being about 30, 20 and 16% respectively of the total. Its principal export trade is with Great Britain, Germany and Sweden, the percentage of the whole being 60, 18 and 10. With Russia, Norway and France (in this order) general trade is less important, but still large. A considerable proportion of Denmark's large commercial fleet is engaged in the carrying trade between foreign, especially British, ports.

Under a law of the 4th of May 1907 it was enacted that the metric system of weights and measures should come into official use in three years from that date, and into general use in five years.

Money and Banking.—The unit of the Danish monetary system, as of the Swedish and Norwegian, is the *krona* (crown), equal to 1s. 1½d., which is divided into 100 *öre*; consequently 7½ *öre* are equal to one penny. Since 1873 gold has been the standard, and gold pieces of 20 and 10 kroner are coined, but not often met with, as the public prefers bank-notes. The principal bank is the National Bank at Copenhagen, which is the only one authorized to issue notes. These are of the value of 10, 50, 100 and 500 kr. Next in importance are the Danske Landmønt Bank, the Handels Bank and the Private Bank, all at Copenhagen. The provincial banks are very numerous; many of them are at the same time savings banks. Their rate of interest, with few exceptions, is 3½ to 4%. There exist, besides, in Denmark several mutual loan associations (*Kreditforeninger*), whose business is the granting of loans on mortgage. Registration of mortgages is compulsory in Denmark, and the system is extremely simple, a fact which has been of the greatest importance for the improvement of the country. There are comparatively large institutions for insurance of all kinds in Denmark. The largest office for life insurance is a state institution. By law of the 9th of April 1891 a system of old-age pensions was established for the benefit of persons over sixty years of age.

Government.—Denmark is a limited monarchy, according to the law of 1849, revised in 1866. The king shares his power with the parliament (*Rigsdag*), which consists of two chambers, the *Landsting* and the *Folkething*, but the constitution contains no indication of any difference in their attributes. The *Landsting*, or upper house, however, is evidently intended to form the conservative element in the constitutional machinery. While the 114 members of the *Folkething* (House of Commons) are elected for three years in the usual way by universal suffrage, 12 out of the 66 members of the *Landsting* are life members nominated by the crown. The remaining 54 members of the *Landsting* are returned for eight years according to a method of proportionate representation by a body of deputy electors. Of these deputies one-half are elected in the same way as members of the *Folkething*, without any property qualification for the voters; the other half of the deputy electors are chosen in the towns by those who during the last preceding year were assessed on a certain minimum of income, or paid at least a certain amount in rates and taxes. In the rural districts the deputy electors returned by election are supplemented by an equal number of those who have paid the highest amounts in taxes and county rates together. In this manner a representation is secured for fairly large minorities, and what is considered a fair share of influence on public affairs given to those who contribute the most to the needs of the state. The franchise is held by every male who has reached his thirtieth year, subject to independence of public charity and certain other circumstances. A candidate for either house of the *Rigsdag* must have passed the age of twenty-five. Members are paid ten kroner each day of the session and are allowed travelling expenses. The houses meet each year on the first Monday in October. The constitutional theory of the *Folkething* is that of one member for every 16,000 inhabitants. The *Færøe* islands, which form an integral part of the kingdom of Denmark in the wider sense, are represented in the Danish parliament, but not the other dependencies of the Danish crown, namely Iceland, Greenland and the West Indian islands of St Thomas, St John and St Croix. The budget is considered by the *Folkething* at the beginning of each session. The revenue and expenditure average annually about £4,700,000. The principal items of revenue are customs and excise, land and house tax, stamps, railways, legal fees, the state lottery and death duties. A considerable reserve fund is maintained to meet emergencies. The public debt is about £13,500,000 and is divided into an internal debt, bearing interest generally at 3½%, and a foreign debt (the larger), with interest generally at 3%. The revenue and expenditure of the *Færøes* are included in the budget for Denmark proper, but Iceland and the West Indies have their separate budgets. The Danish treasury receives nothing from these possessions; on the contrary, Iceland receives an annual grant, and the West Indian islands have been heavily subsidized by the Danish finances to

assist the sugar industry. The administration of Greenland (q.v.) entails an annual loss which is posted on the budget of the ministry of finances. The state council (*Statsraad*) includes the presidency of the council and ministries of war, and marine, foreign affairs, the interior, justice, finance, public institution and ecclesiastical, agriculture and public works.

Local Government.—For administrative purposes the country is divided into eighteen counties (*Amt*, singular *Amt*), as follows. (1) Covering the islands of Zealand and lesser adjacent islands, Copenhagen, Frederiksborg, Holbaek, Sorø, Præstø. (2) Covering the islands of Laaland and Falster, Maribo. (3) Covering Fünen, Langeland and adjacent islets, Svendborg, Odense. (4) On the mainland, Hjørring, Aalborg, Thisted, Ringkjøbing, Viborg, Randers, Aarhus, Vejle, Ribe. (5) Bornholm. The principal civil officer in each of these is the *Amtmand*. Local affairs are managed by the *Amsraad* and *Sogneraad*, corresponding to the English county council and parish council. These institutions date from 1841, but they have undergone several modifications since. The members of these councils are elected on a system similar to that applied to the elections for the Landsting. The same is the case with the provincial town councils. That of Copenhagen is elected by those who are rated on an income of at least 400 kroner (£22). The burgomasters are appointed by the crown, except at Copenhagen, where they are elected by the town council, subject to royal approbation. The financial position of the municipalities in Denmark is generally good. The ordinary budget of Copenhagen amounts to about £1,100,000 a year.

Justice.—For the administration of justice Denmark is divided into *herreds* or hundreds; as, however, they are mostly of small extent, several are generally served by one judge (*herredsfoged*); the townships are likewise separate jurisdictions, each with a *byfoged*. There are 126 such local judges, each of whom deals with all kinds of cases arising in his district, and is also at the head of the police. There are two intermediary Courts of Appeal (*Overret*), one in Copenhagen, another in Viborg; the Supreme Court of Appeal (*Højesteret*) sits at Copenhagen. In the capital the different functions are more divided. There is also a Court of Commerce and Navigation, on which leading members of the trading community serve as assessors. In the country, Land Commissions similarly constituted deal with many questions affecting agricultural holdings. A peculiarity of the Danish system is that, with few exceptions, no civil cause can be brought before a court until an attempt has been made at effecting an amicable settlement. This is mostly done by so-called Committees of Conciliation, but in some cases by the court itself before commencing formal judicial proceedings. In this manner three-fifths of all the causes are settled, and many which remain unsettled are abandoned by the plaintiffs. Sanitary matters are under the control of a Board of Health. The whole country is divided into districts, in each of which a medical man is appointed with a salary, who is under the obligation to attend to poor sick and assist the authorities in medical matters, inquests, &c. The relief of the poor is well organized, mostly on the system of out-door relief. Many workhouses have been established for indigent persons capable of work. There are also many almshouses and similar institutions.

Army and Navy.—The active army consists of a life guard battalion and 10 infantry regiments of 3 battalions each, infantry, 5 cavalry regiments of 3 squadrons each, 12 field batteries (now re-armed with a Krupp Q.F. equipment), 3 battalions of fortress artillery and 6 companies of engineers, with in addition various local troops and details. The peace strength of permanent troops, without the annual contingent of recruits, is about 13,500 officers and men, the annual contingent of men trained two or three years with the colours about 22,500, and the annual contingent of special reservists (men trained for brief periods) about 17,000. Thus the number of men maintained under arms (without calling up the reserves) is as high as 75,000 during certain periods of the year and averages nearly 60,000. Reservists who have definitively left the colours are recalled for short refresher trainings, the number of men so trained in 1907 being

about 80,000. The field army on a war footing, without depot troops, garrison troops and reservists, would be about 50,000 strong, but by constituting new cadres at the outbreak of war and calling up the reserves it could be more than doubled, and as a matter of fact nearly 120,000 men were with the colours in the manoeuvre season in 1907. The term of service is eight years in the active army and its reserves and eight years in the second line. The armament of the infantry is the Krag-jørgensen of .314 in. calibre, model 1880, that of the field artillery a 7.5 cm. Krupp Q.F. equipment, model 1902. The navy consists of 6 small battleships, 3 coast defence armour-clads, 5 protected cruisers, 5 gun-boats, and 24 torpedo craft.

Religion.—The national or state church of Denmark is officially styled "Evangelically Reformed," but is popularly described as Lutheran. The king must belong to it. There is complete religious toleration, but though most of the important Christian communities are represented their numbers are very small. The Mormon apostles for a considerable time made a special raid upon the Danish peasantry and a few hundreds profess this faith. There are seven dioceses, Fünen, Laaland and Falster, Aarhus, Aalborg, Viborg and Ribe, while the primate is the bishop of Zealand, and resides at Copenhagen, but his cathedral is at Roskilde. The bishops have no political function by reason of their office, although they may, and often do, take a prominent part in politics. The greater part of the pastorates comprise more than one parish. The benefices are almost without exception provided with good residences and glebes, and the tithes, &c., generally afford a comfortable income. The bishops have fixed salaries in lieu of tithes appropriated by the state.

Education and Arts.—The educational system of Denmark is maintained at a high standard. The instruction in primary schools is gratuitous. Every child is bound to attend the parish school at least from the seventh to the thirteenth year, unless the parents can prove that it receives suitable instruction in other ways. The schools are under the immediate control of school boards appointed by the parish councils, but of which the incumbent of the parish is *ex-officio* member; superior control is exercised by the *Amtmand*, the rural dean, and the bishop, under the Minister for church and education. Secondary public schools are provided in towns, in which moderate school fees are paid. There are also public grammar-schools. Nearly all schools are day-schools. There are only two public schools, which, though on a much smaller scale, resemble the great English schools, namely, those of Sorø and Herlufsholm, both founded by private munificence. Private schools are generally under a varying measure of public control. The university is at Copenhagen (q.v.). Amongst numerous other institutions for the furtherance of science and training of various kinds may be mentioned the large polytechnic schools; the high school for agriculture and veterinary art; the royal library; the royal society of sciences; the museum of northern antiquities; the society of northern antiquaries, &c. The art museums of Denmark are not considerable, except the museum of Thorvaldsen, at Copenhagen, but much is done to provide first-rate training in the fine arts and their application to industry through the Royal Academy of Arts, and its schools. Finally, it may be mentioned that a sum proportionately large is available from public funds and regular parliamentary grants for furthering science and arts by temporary subventions to students, authors, artists and others of insufficient means, in order to enable them to carry out particular works, to profit by foreign travel, &c. The principal scientific societies and institutions are detailed under COPENHAGEN. During the earlier part of the 19th century not a few men could be mentioned who enjoyed an exceptional reputation in various departments of science, and Danish scientists continue to contribute their full share to the advancement of knowledge. The society of sciences, that of northern antiquaries, the natural history and the botanical societies, &c., publish their transactions and proceedings, but the *Naturhistorisk Tidsskrift*, of which 14 volumes with 259 plates were published (1861-1884), and which was in the foremost rank in its department, ceased with the death in 1884 of the editor, the distinguished zoologist, I. C. Schiødt.

Another extremely valuable publication of wide general interest, the *Meddelelser om Grönland*, is published by the commission for the exploration of Greenland. What may be called the modern "art" current, with its virtues and vices, is as strong in Denmark as in England. Danish sculpture will be always famous, if only through the name of Thorvaldsen. In architecture the prevailing fashion is a return to the style of the first half of the 17th century, called the Christian IV. style; but in this branch of art no marked excellence has been obtained.

AUTHORITIES.—J. P. Trap, *Statistisk Topographisk Beskrivelse af Kongeriget Danmark* (Copenhagen, 1859-1860, 3 vols., 2nd ed., 1872-1879); V. Falbe-Hansen and W. Scharling, *Danmarks Statistik* (Copenhagen, 1878-1891, 6 vols.). (Various writers) *Vort Folk i det niende Aarhundrede* (Copenhagen, 1899 et seq.), illustrated; J. Carlsen, H. Olrik and C. N. Starcke, *Le Danemark* (Copenhagen, 1900), 700 pp.; illustrated, published in connexion with the Paris Exhibition. *Statistisk Aarbog* (1896, &c.). Annual publication, and other publications of Statens Statistiske Bureau, Copenhagen; *Annuaire météorologique*, Danish Meteorological Institution, Copenhagen; E. Löffler, *Danemarks Natur og Volk* (Copenhagen, 1905); Margaret Thomas, *Denmark Past and Present* (London, 1902). (C. A. G.; O. J. R. H.)

HISTORY

Ancient.—Our earliest knowledge of Denmark is derived from Pliny, who speaks of three islands named "Skandia," a name which is also applied to Sweden. He says nothing about the inhabitants of these islands, but tells us more about the Jutish peninsula, or Cimbric Chersonese as he calls it. He places the Saxons on the neck, above them the Sigouloines, Sabaliggoi and Kobandoi, then the Chaloi, then above them the Phoudousioi, then the Charonides and finally the Kimbroi. He also mentions the three islands called Alokiai, at the northern end of the peninsula. This would point to the fact that the Limfjord was then open at both ends, and agree with Adam of Bremen (iv. 16), who also speaks of three islands called Wendilia, Morse and Thud. The Cimbric and Charydes are mentioned in the *Monumentum Ancyranium* as sending embassies to Augustus in A.D. 5. The Promontorium Cimbrorum is spoken of in Pliny, who says that the Sinus Codanus lies between it and Mons Saeco. The latter place is probably to be found in the high-lying land on the N.E. coast of Germany, and the Sinus Codanus must be the S.W. corner of the Baltic, and not the whole sea. Pomponius Mela says that the Cimbric and Teutones dwelt on the Sinus Codanus, the latter also in Scandinavia (or Sweden). The Romans believed that these Cimbric and Teutones were the same as those who invaded Gaul and Italy at the end of the 2nd century B.C. The Cimbric may probably be traced in the province of Aalborg, formerly known as Himmerland; the Teutones, with less certainty, may be placed in Thyth or Thyland, north of the Limfjord. No further reference to these districts is found till towards the close of the migration period, about the beginning of the 6th century, when the Heruli (*q.v.*), a nation dwelling in or near the basin of the Elbe, were overthrown by the Langobardi. According to Procopius (*Bellum Gothicum*, ii. 15), a part of them made their way across the "desert of the Slavs," through the lands of the Warni and the Danes to Thoule (*i.e.* Sweden). This is the first recorded use of the name "Danes." It occurs again in Gregory of Tours (*Historiæ Francorum*, iii. 3) in connexion with an irruption of a Götish (loosely called Danish) fleet into the Netherlands (*c.* 520). From this time the use of the name is fairly common. The heroic poetry of the Anglo-Saxons may carry the name further back, though probably it is not very ancient, at all events on the mainland.

According to late Danish tradition Denmark now consisted of Vitheslaeth (*i.e.* Zealand, Møen, Falster and Laaland), Jutland (with Fyen) and Skaane. Jutland was acquired by Dan, the eponymous ancestor of the Danes. He also won Skaane, including the modern provinces of Halland, Kristianstad, Malmöhus and Blekinge, and these remained part of Denmark until the middle of the 17th century. These three divisions always remained more or less distinct, and the Danish kings had to be recognized at Lund, Ringsted and Viborg, but Zealand was from time immemorial the centre of government, and Lejre was the royal seat and national sanctuary. According to tradition

this dates from the time of Skiöldr, the eponymous ancestor of the Danish royal family of Skiöldungar. He was a son of Othin and husband of the goddess Gefjon, who created Zealand. Anglo-Saxon tradition also speaks of Scyld (*i.e.* Skiöldr), who was regarded as the ancestor of both the Danish and English royal families, and it represented him as coming as a child of unknown origin in a rudderless boat. There can be little doubt that from a remote antiquity Zealand had been a religious sanctuary, and very probably the god Nerthus was worshipped here by the Angli and other tribes as described in Tacitus (*Germania*, c. 40). The Lejre sanctuary was still in existence in the time of Thietmar of Merseburg (i. 9), at the beginning of the 11th century.

In Scandinavian tradition the next great figure is Fröbe the peace-king, but it is not before the 5th century that we meet with the names of any kings which can be regarded as definitely historical. In *Beowulf* we hear of a Danish king Healfdene, who had three sons, Heorogar, Hrothgar and Halga. The hero Beowulf comes to the court of Hrothgar from the land of the Götar, where Hygelac is king. This Hygelac is undoubtedly to be identified with the Chochilauca, king of the Danes (really Götar) who, as mentioned above, made a raid against the Franks *c.* 520. Beowulf himself won fame in this campaign, and by the aid of this definite chronological datum we can place the reign of Healfdene in the last half of the 5th century, and that of Hrothgar's nephew Hrothwulf, son of Halga, about the middle of the 6th century. Hrothgar and Halga correspond to Saxo's Hroar and Helgi, while Hrothwulf is the famous Rolvo or Hrólf Kraki of Danish and Norse saga. There is probably some historical truth in the story that Heorowearð or Hörvarðr was responsible for the death of Hrólf Kraki. Possibly a still earlier king of Denmark was Sigarr or Sigehere, who has won lasting fame from the story of his daughter Signy and her lover Hagbarðr.

From the middle of the 6th to the beginning of the 8th century we know practically nothing of Danish history. There are numerous kings mentioned in Saxo, but it is impossible to identify them historically. We have mention at the beginning of the 8th century of a Danish king Ongendus (*cf.* O. E. *Ongenþeow*) who received a mission led by St Willibrord, and it was probably about this time that there flourished a family of whom tradition records a good deal. The founder of this line was Ivarr Viðfaðmi of Skaane, who became king of Sweden. His daughter Auðr married one Hroerekr and became the mother of Harald Hilditönn. The genealogy of Harald is given differently in Saxo, but there can be no doubt of his historical existence. In his time it is said that the land was divided into four kingdoms—Skaane, Zealand, Fyen and Jutland. After a reign of great splendour Harald met his death in the great battle of Brávalla (Bravik in Östergötland), where he was opposed by his nephew Ring, king of Sweden.

The battle probably took place about the year 750. Fifty years later the Danes begin to be mentioned with comparative frequency in continental annals. From 777-798 we have mention of a certain Sigifrídus as king of the Danes, and then in 804 his name is replaced by that of one Godefrídus. This Godefrídus is the Godefrídus-Guthredus of Saxo, and is to be identified also with Guðröðr the Yngling, king in Vestfold in Norway. He came into conflict with Charlemagne; and was preparing a great expedition against him when he was killed by one of his own followers (*c.* 810). He was succeeded by his brother Hemmingus, but the latter died in 812 and there was a disputed succession. The two claimants were "Sigefridus nepos Godefridi regis" and "Anulo nepos Herioldi quondam regis" (*i.e.* probably Harald Hilditönn). A great battle took place in which both claimants were slain, but the party of Anulo (O.N. *Áli*) were victorious and appointed as kings Anulo's brothers Herioldus and Reginfrídus. They soon paid a visit to Vestfold, "the extreme district of their realm, whose peoples and chief men were refusing to be made subject to them," and on their return had trouble with the sons of Godefrídus. The latter expelled them from their kingdom, and in 814 Reginfrídus fell in a vain attempt to regain it. Herioldus now received the support of the emperor,

and after several unsuccessful attempts a compromise was effected in 819 when the parties agreed to share the realm. In 820 Herioldus was baptized at Mainz and received from the emperor a grant of Riustringen in N.E. Friesland. In 827 he was expelled from his kingdom, but St Anskar, who had been sent with Herioldus to preach Christianity, remained at his post. In 836 we find one Horic as king of the Danes; he was probably a son of Godefridus. During his reign there was trouble with the emperor as to the overlordship of Frisia. In the meantime Herioldus remained on friendly terms with Lothair and received a further grant of Walcheren and the neighbouring districts. In 850 Horic was attacked by his own nephews and compelled to share the kingdom with them, while in 852 Herioldus was charged with treachery and slain by the Franks. In 854 a revolution took place in Denmark itself. Horic's nephew Godwin, returning from exile with a large following of Northmen, overthrew his uncle in a three days' battle in which all members of the royal house except one boy are said to have perished. This boy now became king as "Horicus junior." Of his reign we know practically nothing. The next kings mentioned are Sigafrið and Halfdanc, who were sons of the great Viking leader Ragnar Loðbrok. There is also mention of a third king named Godefridus. The exact chronology and relationship of these kings it is impossible to determine, but we know that Healfdene died in Scotland in 877, while Godefridus was treacherously slain by Henry of Saxony in 885. During these and the next few years there is mention of more than one king of the names Sigefridus and Godefridus: the most important event associated with their names is that two kings Sigefridus and Godefridus fell in the great battle on the Dyle in 891.

We now have the names of several kings, Heilig, Olaph (of Swedish origin), and his sons Chnob and Gurth. Then come a Danish ruler Sigeric, followed by Hardegon, son of Swein, coming from Norway. At some date after 916 we find mention of one "Hardecnuth Urm" ruling among the Danes. Adam of Bremen, from whom these details come, was himself uncertain whether "so many kings or rather tyrants of the Danes ruled together or succeeded one another at short intervals." Hardecnuth Urm is to be identified with the famous Gorm the Old, who married Thyra Danmarkabót: their son was Harold Bluetooth.

(A. M.)

Medical and Modern.—Danish history first becomes authentic at the beginning of the 9th century. The Danes, the southernmost branch of the Scandinavian family, referred to by Alfred (c. 890) as occupying Jutland, the islands and Scania, were, in 777, strong enough to defy the Frank empire by harbouring its fugitives. Five years later we find a Danish king, Sigfrid, among the princes who assembled at Lippe in 782 to make their submission to Charles the Great. About the same time Willibrord, from his see at Utrecht, made an unsuccessful attempt to convert the "wild Danes." These three salient facts are practically the sum of our knowledge of early Danish history previous to the Viking period. That mysterious upheaval, most generally attributed to a love of adventure, stimulated by the pressure of over-population, began with the ravaging of L'edismarne in 793, and virtually terminated with the establishment of Rollo in Normandy (911). There can be little doubt that the earlier of these expeditions were from Denmark, though the term Northmen was originally applied indiscriminately to all these terrible visitants from the unknown north. The rovers who first chastened and finally colonized southern England and Normandy were certainly Danes.

The Viking raids were one of the determining causes of the establishment of the feudal monarchies of western Europe, but the untameable freebooters were themselves finally subdued by the Church. At first sight it seems curious that Christianity should have been so slow to reach Denmark. But we must bear in mind that one very important consequence of the Viking raids was to annihilate the geographical remoteness which had hitherto separated Denmark from the Christian world. Previously to 793 there lay between Jutland and England a sea which no keel had traversed within

the memory of man. The few and peaceful traders who explored those northern waters were careful never to lose sight of the Saxon, Frisian and Frankish shores during their passage. Nor was communication with the west by land any easier. For generations the obstinately heathen Saxons had lain, a compact and impenetrable mass, between Scandinavia and the Frank empire, nor were the measures adopted by Charles the Great for the conversion of the Saxons to the true faith very much to the liking of their warlike Danish neighbours on the other side. But by the time that Charles had succeeded in "converting" the Saxons, the Viking raids were already at their height, and though generally triumphant, necessity occasionally taught the Northmen the value of concessions. Thus it was the desire to secure his Jutish kingdom which induced Harold Klak, in 826, to sail up the Rhine to Ingelheim, and there accept baptism, with his wife, his son Godfred and 400 of his suite, acknowledging the emperor as his overlord, and taking back with him to Denmark the missionary monk Ansgar. Ansgar preached in Denmark from 826 to 861, but it was not till after the subsidence of the Viking raids that Adaldag, archbishop of Hamburg, could open a new and successful mission, which resulted in the erection of the bishoprics of Schleswig, Ribe and Aarhus (c. 948), though the real conversion of Denmark must be dated from the baptism of King Harold Bluetooth (960).

Meanwhile the Danish monarchy was attempting to aggrandize itself at the expense of the Germans, the Wends who then occupied the Baltic littoral as far as the Vistula, and the other Scandinavian kingdoms. Harold Bluetooth ^{Danish expansion.} (940-986) subdued German territory south of the Eider, extended the *Danewirke*, Denmark's great line of defensive fortifications, to the south of Schleswig and planted the military colony of Julin or Jomsborg, at the mouth of the Oder. Part of Norway was first seized after the united Danes and Swedes had defeated and slain King Olaf Trygvesson at the battle of Svoide (1000); and between 1028 and 1035 Canute the Great added the whole kingdom to his own; but the union did not long survive him. Equally short-lived was the Danish dominion in England, which originated in a great Viking expedition of King Sweyn I.

The period between the death of Canute the Great and the accession of Valdemar I. was a troublous time for Denmark. The kingdom was harassed almost incessantly, and more than once partitioned, by pretenders to the throne, who did not scruple to invoke the interference of the neighbouring monarchs, and even of the heathen ^{Consolidation of the kingdom under the Valdemars. 1157-1281.} Wends, who established themselves for a time on the southern islands. Yet, throughout this chaos, one thing made for future stability, and that was the growth and consolidation of a national church, which culminated in the erection of the archbishopric of Lund (c. 1104) and the consequent ecclesiastical independence of Denmark. The third archbishop of Lund was Absalon (1128-1201), Denmark's first great statesman, who so materially assisted Valdemar I. (1157-1182) and Canute VI. (1182-1202) to establish the dominion of Denmark over the Baltic, mainly at the expense of the Wends. The policy of Absalon was continued on a still vaster scale by Valdemar II. (1202-1241), at a time when the German kingdom was too weak and distracted to intervene to save its seaboard; but the treachery of a vassal and the loss of one great battle sufficed to plunge this unwieldy, unsubstantial empire in the dust. (See VALDEMAR I., II., and ABSALON.)

Yet the age of the Valdemars was one of the most glorious in Danish history, and it is of political importance as marking a turning-point. Favourable circumstances had, from the first, given the Danes the lead in Scandinavia. They held the richest and therefore the most populous lands, and geographically they were nearer than their neighbours to western civilization. Under the Valdemars, however, the ancient patriarchal system was merging into a more complicated development, of separate estates. The monarchy, now dominant, and far wealthier than before, rested upon the support of the great nobles, many of whom held their lands by feudal tenure, and constituted the royal *Road*, or council. The clergy, fortified by royal privileges.

had also risen to influence; but celibacy and independence of the civil courts tended to make them more and more of a separate caste. Education was spreading. Numerous Danes, lay as well as clerical, regularly frequented the university of Paris. There were signs too of the rise of a vigorous middle class, due to the extraordinary development of the national resources (chiefly the herring fisheries, horse-breeding and cattle-rearing) and the foundation of gilds, the oldest of which, the *Edslog* of Schleswig, dates from the early 12th century. The *bonder*, or yeomen, were prosperous and independent, with well-defined rights. Danish territory extended over 60,000 sq. kilometres, or nearly double its present area; the population was about 700,000; and 160,000 men and 1400 ships were available for national defence.

On the death of Valdemar II a period of disintegration ensued. Valdemar's son, Eric Plovpenning, succeeded him as king; but his near kinsfolk also received huge appanages, and family discord led to civil wars. Throughout the 13th and part of the 14th century, the struggle raged between the Danish kings and the Schleswig dukes, and of six monarchs no fewer than three died violent deaths. Superadded to these troubles was a prolonged struggle for supremacy between the popes and the crown, and, still more serious, the beginning of a breach between the kings and nobles, which had important constitutional consequences. The prevalent disorder had led to general lawlessness, in consequence of which the royal authority had been widely extended; and a strong opposition gradually arose which protested against the abuses of this authority. In 1282 the nobles extorted from King Eric Glipping the first *Haandjaestning*, or charter, which recognized the *Danehof*, or national assembly, as a regular branch of the administration and gave guarantees against further usurpations. Christopher II. (1310-1331) was constrained to grant another charter considerably reducing the prerogative, increasing the privileges of the upper classes, and at the same time reducing the burden of taxation. But aristocratic licence proved as mischievous as royal incompetence; and on the death of Christopher II. the whole kingdom was on the verge of dissolution. Eastern Denmark was in the hands of one magnate; another magnate held Jutland and Fünen in pawn; the dukes of Schleswig were practically independent of the Danish crown; the Scandian provinces had (1332) surrendered themselves to Sweden.

It was reserved for another Valdemar (Valdemar IV., *q.r.*) to reunite and weld together the scattered members of his heritage. Valdemar IV. (1340-1375). His long reign (1340-1375) resulted in the re-establishment of Denmark as the great Baltic power. It is also a very interesting period of her social and constitutional development. This great ruler, who had to fight, year after year, against foreign and domestic foes, could, nevertheless, always find time to promote the internal prosperity of his much afflicted country. For the dissolution of Denmark, during the long anarchy, had been internal as well as external. The whole social fabric had been convulsed and transformed. The monarchy had been undermined. The privileged orders had aggrandized themselves at the expense of the community. The yeoman class had sunk into semi-serfdom. In a word, the natural cohesion of the Danish nation had been loosened and there was no security for law and justice. To make an end of this universal lawlessness Valdemar IV. was obliged, in the first place, to re-establish the royal authority by providing the crown with a regular and certain income. This he did by recovering the alienated royal demesnes in every direction, and from henceforth the annual *landgilde*, or rent, paid by the royal tenants, became the monarch's principal source of revenue. Throughout his reign Valdemar laboured incessantly to acquire as much land as possible. Moreover, the old distinction between the king's private estate and crown property henceforth ceases; all such property was henceforth regarded as the hereditary possession of the Danish crown.

The national army was also re-established on its ancient footing. Not only were the magnates sharply reminded that they held their lands on military tenure, but the towns were also made to contribute both men and ships, and peasant levies, especially

Valdemar intervened personally. The smallest detail was not beneath his notice. Thus he invented nets for catching wolves and built innumerable water-mills, "for he would not let the waters run into the sea before they had been of use to the community." Under such a ruler law and order were speedily re-established. The popular tribunals regained their authority, and a supreme court of justice, *Det Kongelige Resterling*, presided over by Valdemar himself, not only punished the unruly and guarded the prerogatives of the crown, but also protected the weak and defenceless from the tyranny of the strong. Nor did Valdemar hesitate to meet his people in public and periodically render an account of his stewardship. He voluntarily resorted to the old practice of summoning national assemblies, the so-called *Danehof*. At the first of these assemblies held at Nyborg, Midsummer Day 1314, the bishops and councillors solemnly promised that the commonalty should enjoy all the ancient rights and privileges conceded to them by Valdemar II., and the wise provision that the *Danehof* should meet annually considerably strengthened its authority. The keystone to the whole constitutional system was "King Valdemar's Charter" issued in May 1360 at the *Rigsmdde*, or parliament, held at Kalundborg in May 1360. This charter was practically an act of national pacification, the provisions of which king and people together undertook to enforce for the benefit of the commonweal.

The work of Valdemar was completed and consolidated by his illustrious daughter Margaret (1375-1412), whose crowning achievement was the Union of Kalmar (1397), whereby she sought to combine the three northern kingdoms into a single state dominated by Denmark. In any case Denmark was bound to be the only gainer by the Union. Her population was double that of the two other kingdoms combined, and neither Margaret nor her successors observed the stipulations that each country should retain its own laws and customs and be ruled by natives only. In both Norway and Sweden, therefore, the Union was highly unpopular. The Norwegian aristocracy was too weak, however, seriously to endanger the Union at any time, but Sweden was, from the first, decidedly hostile to Margaret's whole policy. Nevertheless during her lifetime the system worked fairly well; but her pupil and successor, Eric of Pomerania, was unequal to the burden of empire and embroiled himself both with his neighbours and his subjects. The Hanseatic League, whose political ascendancy had been shaken by the Union, enraged by Eric's efforts to bring in the Dutch as commercial rivals, as well as by the establishment of the Sound tolls, materially assisted the Holsteiners in their twenty-five years' war with Denmark (1410-35), and Eric VII. himself was finally deposed (1439) in favour of his nephew, Christopher of Bavaria.

The deposition of Eric marks another turning-point in Danish history. It was the act not of the people but of the *Rigsraad* (Senate), which had inherited the authority of the ancient *Danehof* and, after the death of Margaret, grew steadily in power at the expense of the crown. As the government grew more and more aristocratic, the position of the peasantry steadily deteriorated. It is under Christopher that we first hear, for instance, of the *Vornedskab*, or patriarchal control of the landlords over their tenants, a system which degenerated into rank slavery. In Jutland, too, after the repression, in 1441, of a peasant rising, something very like serfdom was introduced.

On the death of Christopher III. without heirs, in 1448, the *Rigsraad* elected his distant cousin, Count Christian of Oldenburg, king; but Sweden preferred Karl Knutsson (Charles "VIII."), while Norway finally combined with Denmark, at the conference of Halmstad, in a double election which practically terminated the Union, though an agreement was come to that the survivor of the two kings should reign over all three kingdoms. Norway, subsequently, threw in her lot definitively with Denmark. Dissensions resulting in interminable civil wars had, even before the Union, exhausted the resources of the poorest of the three northern realms; and her ruin was completed by the ravages of the Black

Period of disintegration.

The Union of Kalmar, 1397.

Growth of the power of the nobles.

Break-up of the Union.

Death, which wiped out two-thirds of her population. Unfortunately, too, for Norway's independence, the native gentry had gradually died out, and were succeeded by immigrant Danish fortune-hunters; native burghesses there were none, and the peasantry were mostly thralls; so that, excepting the clergy, there was no patriotic class to stand up for the national liberties.

Far otherwise was it in the wealthier kingdom of Sweden. Here the clergy and part of the nobility were favourable to the Union; but the vast majority of the people hated it as a foreign usurpation. Matters were still further complicated by the continual interference of the Hanseatic League; and Christian I. (1448-1481) and Hans (1481-1513), whose chief merit it is to have founded the Danish fleet, were, during the greater part of their reigns, only nominally kings of Sweden. Hans also received in fief the territory of Dietmarsch from the emperor, but, in attempting to subdue the hardy Dietmarschers, suffered a crushing defeat in which the national banner called "Danebrog" fell into the enemy's hands (1500). Moreover, this defeat led to a successful rebellion in Sweden, and a long and ruinous war with Lübeck, terminated by the peace of Malmö, 1512. It was during this war that a strong Danish fleet dominated the Baltic for the first time since the age of the Valdemars.

On the succession of Hans's son, Christian II. (1513-1523), Margaret's splendid dream of a Scandinavian empire seemed, finally, about to be realized. The young king, a man of character and genius, had wide views and original ideas. Elected king of Denmark and Norway, he succeeded in subduing Sweden by force of arms; but he spoiled everything at the culmination of his triumph by the hideous crime and blunder known as the Stockholm massacre, which converted the politically divergent Swedish nation into the irreconcilable foe of the unional government (see CHRISTIAN II.).

Christian's contempt of nationality in Sweden is the more remarkable as in Denmark proper he sided with the people against the aristocracy, to his own undoing in that age of privilege and prejudice. His intentions, as exhibited to his famous *Landelove* (National Code), were progressive and enlightened to an eminent degree; so much so, indeed, that they mystified the people as much as they alienated the patricians; but his actions were often of revolting brutality, and his whole career was vitiated by an incurable double-mindedness which provoked general distrust. Yet there is no doubt that Christian II. was a true patriot, whose ideal it was to weld the three northern kingdoms into a powerful state, independent of all foreign influences, especially of German influence as manifested in the commercial tyranny of the Hansa League. His utter failure was due, partly to the vices of an undisciplined temperament, and partly to the extraordinary difficulties of the most inscrutable period of European history, when the shrewdest heads were at fault and irreparable blunders belonged to the order of the day. That period was the period of the Reformation, which profoundly affected the politics of Scandinavia. Christian II. had always subordinated religion to politics, and was Papist or Lutheran according to circumstances. But, though he treated the Church more like a foe than a friend and was constantly at war with the Curia, he retained the Catholic form of church worship and never seems to have questioned the papal supremacy. On the flight of Christian II. and the election of his uncle, Frederick I. (1523-1533), the Church resumed her jurisdiction and everything was placed on the old footing. The newly elected and still insecure German king at first remained neutral; but in the autumn of 1525 the current of

Lutheranism began to run so strongly in Denmark as to threaten to whirl away every opposing obstacle. This novel and disturbing phenomenon was mainly due to the zeal and eloquence of the ex-monk Hans Tausen and his associates, or disciples, Peder Plad and Sadolin, and, in the autumn of 1526, Tausen was appointed one of the royal chaplains. The three ensuing years were especially favourable for the Reformation, as during that time the king had unlooked-for opportunities for filling the vacant episcopal sees with men after his own heart,

and at heart he was a Lutheran. The reformation movement in Denmark was further promoted by Schleswig-Holstein influence. Frederick's eldest son Duke Christian had, since 1527, resided at Haderslev, where he collected round him Lutheran teachers from Germany, and made his court the centre of the propaganda of the new doctrine. On the other hand, the Odense Recess of the 20th of August 1527, which put both confessions on a footing of equality, remained un repealed; and so long as it remained in force, the spiritual jurisdiction of the bishops, and, consequently, their authority over the "free preachers" (whose ambition convulsed all the important towns of Denmark and aimed at forcibly expelling the Catholic priests from their churches) remained valid, to the great vexation of the reformers. The inevitable ecclesiastical crisis was still further postponed by the superior stress of two urgent political events—Christian II.'s invasion of Norway (1531) and the outbreak, in 1533, of

"*Grevens fejde*," or "The Count's War" (1534-36), the count in question being Christopher of Oldenburg, great-nephew of King Christian I., whom Lübeck and her allies, on the death of Frederick I., raised up against Frederick's son Christian III. The Catholic party and the lower orders generally took the part of Count Christopher, who acted throughout as the nominee of the captive Christian II., while the Protestant party, aided by the Holstein dukes and Gustavus Vasa of Sweden, sided with Christian III. The war ended with the capture of Copenhagen by the forces of Christian III., on the 29th of July 1536, and the triumph of so devoted a Lutheran sealed the fate of the Roman Catholic Church in Denmark, though even now it was necessary for the victorious king to proceed against the bishops and their friends by a *coup d'état*, engineered by his German generals the Rantzaus. The Recess of 1536 enacted that the bishops should forfeit their temporal and spiritual authority, and that all their property should be transferred to the crown for the good of the commonwealth. In the following year a Church ordinance, based upon the canons of Luther, Melancthon and Bugenhagen, was drawn up, submitted to Luther for his approval, and promulgated on the 2nd of September 1537. On the same day seven "superintendents," including Tausen and Sadolin, all of whom had worked zealously for the cause of the Reformation, were consecrated in place of the dethroned bishops. The position of the superintendents and of the reformed church generally was consolidated by the Articles of Ribe in 1542, and the constitution of the Danish church has practically continued the same to the present day. But Catholicism could not wholly or immediately be dislodged by the teaching of Luther. It had struck deep roots into the habits and feelings of the people, and traces of its survival were distinguishable a whole century after the triumph of the Reformation. Catholicism lingered longest in the cathedral chapters. Here were to be found men of ability proof against the eloquence of Hans Tausen or Peder Plad and quite capable of controverting their theories—men like Povl Helgesen, for instance, indisputably the greatest Danish theologian of his day, a scholar whose voice was drowned amidst the clash of conflicting creeds.

Though the Reformation at first did comparatively little for education, and the whole spiritual life of Denmark was poor and feeble in consequence for at least a generation afterwards, the change of religion was of undeniable, if temporary, benefit to the state from the political point of view. The enormous increase of the royal revenue consequent upon the confiscation of the property of the Church could not fail to increase the financial stability of the monarchy. In particular the suppression of the monasteries benefited the crown in two ways. The old church had, indeed, frequently rendered the state considerable financial aid, but such voluntary assistance was, from the nature of the case, casual and arbitrary. Now, however, the state derived a fixed and certain revenue from the confiscated lands; and the possession

¹ It is true the university was established on the 9th of September 1537, but its influence was of very gradual growth and small at first.

The
Count's
War,
1534-
36.

Christian
II., 1513-
1523.

Frederick
I., 1523-
1533. The
Reforma-
tion.

Effects of
the Re-
formation.

of immense landed property at the same time enabled the crown advantageously to conduct the administration. The gross revenue of the state is estimated to have risen threefold. Before the Reformation the annual revenue from land averaged 400,000 bushels of corn; after the confiscations of Church property it averaged 1,200,000 bushels. The possession of a full purse materially assisted the Danish government in its domestic administration, which was indeed epoch-making. It enabled Christian III. to pay off his German mercenaries immediately after the religious *coup d'état* of 1536. It enabled him to prosecute shipbuilding with such energy that, by 1550, the royal fleet numbered at least thirty vessels, which were largely employed as a maritime police in the pirate-haunted Baltic and North Seas. It enabled him to create and remunerate adequately a capable official class, which proved its efficiency under the strictest supervision, and ultimately produced a whole series of great statesmen and admirals like Johan Friis, Peder Oxé, Heriuf Trolle and Peder Skram. It is not too much to say that the increased revenue derived from the appropriation of Church property, intelligently applied, gave

Denmark the hegemony of the North during the latter part of Christian III.'s reign, the whole reign of Frederick II. and the first twenty-five years of the reign of Christian IV., a period embracing, roughly speaking, eighty years (1544-1626). Within this period Denmark was indisputably the leading Scandinavian power.

While Sweden, even after the advent of Gustavus Vasa, was still of but small account in Europe, Denmark easily held her own in Germany and elsewhere, even against Charles V., and was important enough, in 1553, to mediate a peace between the emperor and Saxony. Twice during this period Denmark and Sweden measured their strength in the open field, on the first occasion in the "Scandinavian Seven Years' War" (1562-70), on the second in the "Kalmar War" (1611-13), and on both occasions Denmark prevailed, though the temporary advantage she gained was more than neutralized by the intense feeling of hostility which the unnatural wars, between the two kindred peoples of Scandinavia, left behind them. Still, the fact remains that, for a time, Denmark was one of the great powers of Europe. Frederick II., in his later years (1571-1588), aspired to the dominion of all the seas which washed the Scandinavian coasts, and before he died he was able to enforce the rule that all foreign ships should strike their topsails to Danish men-of-war as a token of his right to rule the northern seas. Favourable political circumstances also contributed to this general acknowledgment of Denmark's maritime greatness. The power of the Hansa had gone; the Dutch were encircled by their contest with Spain, England's sea-power was yet in the making; Spain, still the greatest of the maritime nations, was exhausting her resources in the vain effort to conquer the Dutch. Yet more even than to felicitous circumstances, Denmark owed her short-lived greatness to the great statesmen and administrators whom Frederick II. succeeded in gathering about him. Never before, since the age of Margaret, had Denmark been so well governed, never before had she possessed so many political celebrities nobly emulous for the common good.

Frederick II was succeeded by his son Christian IV. (April 4, 1588), who attained his majority on the 17th of August 1596, at the age of nineteen. The realm which Christian IV. was to govern had undergone great changes within the last two generations. Towards the south the boundaries of the Danish state remained unchanged. Levensaa and the Eider still separated Denmark from the Empire. Schleswig was recognized as a Danish fief, in contradistinction to Holstein, which owed vassalage to the Empire. The "kingdom" stretched as far as Kolding and Skedborg, where the "duchy" began; and this duchy since its amalgamation with Holstein by means of a common *Landtag*, and especially since the union of the dual duchy with the kingdom on almost equal terms in 1533, was, in most respects, a semi-independent state. Denmark, moreover, like Europe in general, was, political

the threshold of a transitional period. During the whole

course of the 16th century the monarchical form of government was in every large country, with the single exception of Poland, rising on the ruins of feudalism. The great powers of the late 16th and early 17th centuries were to be the strong, highly centralized, hereditary monarchies, like France, Spain and Sweden. There seemed to be no reason why Denmark also should not become a powerful state under the guidance of a powerful monarchy, especially as the sister state of Sweden was developing into a great power under apparently identical conditions. Yet, while Sweden was surely ripening into the dominating power of northern Europe, Denmark had as surely entered upon a period of uninterrupted and apparently incurable decline. What was the cause of this anomaly? Something of course must be allowed for the superior and altogether extraordinary genius of the great princes of the house of Vasa; yet the causes of the decline of Denmark lay far deeper than this. They may roughly be summed up under two heads: the inherent weakness of an elective monarchy, and the absence of that public spirit which is based on the intimate alliance of ruler and ruled. Whilst Gustavus Vasa had leaned upon the Swedish peasantry, in other words upon the bulk of the Swedish nation, which was and continued to be an integral part of the Swedish body-politic, Christian III. on his accession had crushed the middle and lower classes in Denmark and reduced them to political insignificance. Yet it was not the king who benefited by this blunder. The Danish monarchy since the days of Margaret had continued to be purely elective, and a purely elective monarchy at that stage of the political development of Europe was a mischievous anomaly. It signified in the first place that the crown was not the highest power in the state, but was subject to the aristocratic *Rigsraad*, or council of state. The *Rigsraad* was the permanent owner of the realm and the crown-lands; the king was only their temporary administrator. If the king died before the election of his successor, the *Rigsraad* stepped into the king's place. Moreover, an elective monarchy implied that, at every fresh succession, the king was liable to be bound by a new *Haandfaestning*, or charter. The election itself might, and did, become a mere formality; but the condition precedent of election, the acceptance of the charter, invariably limiting the royal authority, remained a reality. This period of aristocratic rule, which dates practically from the accession of Frederick I. (1523), and lasted for nearly a century and a half, is known in Danish history as *Adelsvalde*, or rule of the nobles.

Again, the king was the ruler of the realm, but over a very large portion of it he had but a slight control. The crown-lands and most of the towns were under his immediate jurisdiction, but by the side of the crown-lands lay the estates of the nobility, which already comprised about one-half of the superficial area of Denmark, and were in many respects independent of the central government both as regards taxation and administration. In a word, the monarchy had to share its dominion with the nobility; and the Danish nobility in the 16th century was one of the most exclusive and selfish aristocracies in Europe, and already far advanced in decadence. Hermetically sealing itself from any intrusion from below, it deteriorated by close and constant intermarriage, and it was already, both morally and intellectually, below the level of the rest of the nation. Yet this very aristocracy, whose claim to consideration was based not upon its own achievements but upon the length of its pedigrees, insisted upon an amplification of its privileges which endangered the economical and political interests of the state and the nation. The time was close at hand when a Danish magnate was to demonstrate that he preferred the utter ruin of his country to any abatement of his own personal dignity.

All below the king and the nobility were generally classified together as "subjects." Of these lower orders the clergy stood first in the social scale. As a spiritual estate, indeed, it had ceased to exist at the Reformation, though still represented in the *Rigsdag* or diet. Since then too it had become quite detached from the nobility, which ostentatiously despised the teaching profession. The clergy recruited themselves therefore from the class next below them, and looked more and more to the

Denmark at the accession of Christian IV., 1588.

crown for help and protection as they drew apart from the gentry, who, moreover, as dispensers of patronage, lost no opportunity of appropriating church lands and cutting down tithes.

The burghesses had not yet recovered from the disaster of "Grevens fejde"; but while the towns had become more dependent on the central power, they had at the same time been released from their former vexatious subjection to the local magistrates, and could make their voices heard in the *Rigsdag*, where they were still, though inadequately, represented. Within the Estate of Burghesses itself, too, a levelling process had begun. The old municipal patrieate, which used to form the connecting link between the *bourgeoisie* and the nobility, had disappeared, and a feeling of common civic fellowship had taken its place. All this tended to enlarge the political views of the burghesses, and was not without its influence on the future. Yet, after all, the prospects of the burghesses depended mainly on economic conditions; and in this respect there was a decided improvement, due to the increasing importance of money and commerce all over Europe, especially as the steady decline of the Hanse towns immediately benefited the trade of Denmark-Norway; Norway by this time being completely merged in the Danish state, and ruled from Copenhagen. There can, indeed, be no doubt that the Danish and Norwegian merchants at the end of the 16th century flourished exceedingly, despite the intrusion and competition of the Dutch and the dangers to neutral shipping arising from the frequent wars between England, Spain and the Netherlands.

At the bottom of the social ladder lay the peasants, whose condition had decidedly deteriorated. Only in one respect had they benefited by the peculiar conditions of the 16th century: the rise in the price of corn without any corresponding rise in the land-tax must have largely increased their material prosperity. Yet the number of peasant-proprietors had diminished, while the obligations of the peasantry generally had increased; and, still worse, their obligations were vexatiously indefinite, varying from year to year and even from month to month. They weighed especially heavily on the so-called *Ugedasmaend*, who were forced to work two or three days a week in the demesne lands. This increase of villenage morally depressed the peasantry, and widened still further the breach between the yeomanry and the gentry. Politically its consequences were disastrous. While in Sweden the free and energetic peasant was a salutary power in the state, which he served with both mind and plough, the Danish peasant was sinking to the level of a bondman. While the Swedish peasants were well represented in the Swedish *Riksdag*, whose proceedings they sometimes dominated, the Danish peasantry had no political rights or privileges whatever.

Such then, briefly, was the condition of things in Denmark when, in 1588, Christian IV. ascended the throne. Where so much was necessarily uncertain and fluctuating, there was room for an almost infinite variety of development.

Much depended on the character and personality of the young prince who had now taken into his hands the reins of government, and for half a century was to guide the destinies of the nation. In the beginning of his reign the hand of the young monarch, who was nothing if not energetic, made itself felt in every direction. The harbours of Copenhagen, Elsinore and other towns were enlarged; many decaying towns were abolished and many new ones built under more promising conditions, including Christiania, which was founded in August 1624, on the ruins of the ancient city of Oslo. Various attempts were also made to improve trade and industry by abolishing the still remaining privileges of the Hanseatic towns, by promoting a wholesale immigration of skilful and well-to-do Dutch traders and handicraftsmen into Denmark under most favourable conditions, by opening up the rich fisheries of the Arctic seas, and by establishing joint-stock chartered companies both in the East and the West Indies. Copenhagen especially benefited by Christian IV.'s commercial policy. He enlarged and embellished it, and provided it with new harbours and fortifications; in short,

did his best to make it the worthy capital of a great empire. But it was in the foreign policy of the government that the royal influence was most perceptible. Unlike Sweden, Denmark had remained outside the great religious-political movements which were the outcome of the Catholic reaction; and the peculiarity of her position made her rather hostile than friendly to the other Protestant states. The possession of the Sound enabled her to close the Baltic against the Western powers; the possession of Norway carried along with it the control of the rich fisheries which were Danish monopolies, and therefore a source of irritation to England and Holland. Denmark, moreover, was above all things a Scandinavian power. While the territorial expansion of Sweden in the near future was a matter of necessity, Denmark had not only attained, but even exceeded, her natural limits. Aggrandizement southwards, at the expense of the German empire, was becoming every year more difficult; and in every other direction she had nothing more to gain. Nay, more, Denmark's possession of the Scanian provinces deprived Sweden of her proper geographical frontiers. Clearly it was Denmark's wisest policy to seek a close alliance with Sweden in their common interests, and after the conclusion of the "Kalmar War" the two countries did remain at peace for the next thirty-one years. But the antagonistic interests of the two countries in Germany during the Thirty Years' War precipitated a fourth contest between them (1643-45), in which Denmark would have been utterly ruined but for the heroism of King Christian IV. and his command of the sea during the crisis of the struggle. Even so, by the peace of Brömsebro (February 8, 1645) Denmark surrendered the islands of Oesel and Gotland and the provinces of Jemteland and Herjedal (in Norway) definitively, and Halland for thirty years. The freedom from the Sound tolls was by the same treaty also extended to Sweden's Baltic provinces.

The peace of Brömsebro was the first of the long series of treaties, extending down to our own days, which mark the progressive shrinkage of Danish territory into an irreducible minimum. Sweden's appropriation of Danish soil had begun, and at the same time Denmark's power of resisting the encroachments of Sweden was correspondingly reduced. The Danish national debt, too, had risen enormously, while the sources of future income and consequent recuperation had diminished or disappeared. The Sound tolls, for instance, in consequence of the treaties of Brömsebro and Kristianopol (by the latter treaty very considerable concessions were made to the Dutch) had sunk from 400,000 to 140,000 rik-dollars. The political influence of the crown, moreover, had inevitably been weakened, and the conduct of foreign affairs passed from the hands of the king into the hands of the *Rigsraad*. On the accession of Frederick III. (1648-1670) moreover, the already diminished royal prerogative was still further curtailed by the *Haandfaestning*, or charter, which he was compelled to sign. Fear and hatred of Sweden, and the never abandoned hope of recovering the lost provinces, animated king and people alike; but it was Denmark's crowning misfortune that she possessed at this difficult crisis no statesman of the first rank, no one even approximately comparable with such competitors as Charles X. of Sweden or the "Great Elector" Frederick William of Brandenburg. From the very beginning of his reign Frederick III. was resolved upon a rupture at the first convenient opportunity, while the nation was, if possible, even more bellicose than the king. The apparently insuperable difficulties of Sweden in Poland was the feather that turned the scale; on the 1st of June 1657, Frederick III. signed the manifesto justifying a war which was never formally declared and brought Denmark to the very verge of ruin. The extraordinary details of this dramatic struggle will be found elsewhere (see FREDERICK III., king of Denmark, and CHARLES X., king of Sweden); suffice it to say that by the peace of Roskilde

(February 26, 1658), Denmark consented to cede the three Scanian provinces, the island of Bornholm and the Norwegian provinces of Baahus and Trondhjem; to renounce all anti-Swedish alliances and to exempt all Swedish

First losses of territory.

Frederick III., 1648-1670.

Peace of Roskilde, 1658.

vessels, even when carrying foreign goods, from all tolls. These terrible losses were somewhat retrieved by the subsequent treaty of Copenhagen (May 27, 1660) concluded by the Swedish regency with Frederick III. after the failure of Charles X.'s second war against Denmark, a failure chiefly owing to the heroic defence of the Danish capital (1658-60). By this treaty

Sweden gave back the province of Trondhjem and the island of Bornholm and released Denmark from the most onerous of the obligations of the treaty of Roskilde.

In fact the peace of Copenhagen came as a welcome break in an interminable series of disasters and humiliations. Anyhow, it confirmed the independence of the Danish state. On the other hand, if Denmark had emerged from the war with her honour and dignity unimpaired, she had at the same time tacitly surrendered the dominion of the North to her Scandinavian rival.

But the war just terminated had important political consequences, which were to culminate in one of the most curious and interesting revolutions of modern history. In the first place, it marks the termination of the *Adelsvalde*, or rule of the nobility. By their cowardice, incapacity, egotism and treachery during the crisis of the struggle, the Danish aristocracy had justly forfeited the respect of every other class of the community, and emerged from the war hopelessly discredited. On the other hand, Copenhagen, proudly conscious of her intrinsic importance and of her inestimable services to the country, whom she had saved from annihilation by her constancy, now openly claimed to have a voice in public affairs. Still higher had risen the influence of the crown. The courage and resource displayed by Frederick III. in the extremity of the national danger had won for "the least expansive of monarchs" an extraordinary popularity.

On the 20th of September 1660, the *Rigsdag*, which was to repair the ravages of the war and provide for the future, was opened with great ceremony in the *Riddersaal* of the castle of Copenhagen. The first bill laid before the Estates by the government was to impose an excise tax on the principal articles of consumption, together with subsidiary taxes on cattle, poultry, &c., in return for which the abolition of all the old direct taxes was promised. The nobility at first claimed exemption from taxation altogether, while the clergy and burghesses insisted upon an absolute equality of taxation. There were sharp encounters between the presidents of the contending orders, but the position of the Lower Estates was considerably prejudiced by the dissensions of its various sections. Thus the privileges of the bishops and of Copenhagen profoundly irritated the lower clergy and the unprivileged towns, and made a cordial understanding impossible, till Hans Svane, bishop of Copenhagen, and Hans Nansen the burghmaster, who now openly came forward as the leader of the reform movement, proposed that the privileges which divided the non-noble Estates should be abolished. In accordance with this proposal, the two Lower Estates, on the 16th of September, subscribed a memorandum addressed to the *Rigsraad*, declaring their willingness to renounce their privileges, provided the nobility did the same; which was tantamount to a declaration that the whole of the clergy and burghesses had made common cause against the nobility. The opposition so formed took the name of the "Conjoined Estates." The presentation of the memorial provoked an outburst of indignation. But the nobility soon perceived the necessity of complete surrender. On the 30th of September the First Estate abandoned its former standpoint and renounced its privileges, with one unimportant reservation.

The struggle now seemed to be ended, and the financial question having also been settled, the king, had he been so minded, might have dismissed the Estates. But the still more important question of reform was now raised. On the 17th of September the burghesses introduced a bill proposing a new constitution, which was to include local self-government in the towns, the abolition of serfdom, and the formation of a national army. It fell to the ground for want of adequate support; but another proposition, the fruit of secret discussion between the

king and his confederates, which placed all fiefs under the control of the crown as regards taxation, and provided for selling and letting them to the highest bidder, was accepted by the Estate of burghesses. The significance of this ordinance lay in the fact that it shattered the privileged position of the nobility, by abolishing the exclusive right to the possession of fiefs. What happened next is not quite clear. Our sources fail us, and we are at the mercy of doubtful rumours and more or less unreliable anecdotes. We have a vision of intrigues, mysterious conferences, threats and bribery, dimly discernible through a shifting mirage of tradition.

The first glint of light is a letter, dated the 23rd of September, from Frederick III. to Svane and Nansen, authorizing them to communicate the arrangements already made to reliable men, and act quickly, as "if the others gain time they may possibly gain more." The first step was to make sure of the city train-bands: of the garrison of Copenhagen the king had no doubt. The headquarters of the conspirators was the bishop's palace near *Vor Frue* church, between which and the court messages were passing continually, and where the document to be adopted by the Conjoined Estates took its final shape. On the 8th of October the two burghmasters, Hans Nansen and Kristoffer Hansen, proposed that the realm of Denmark should be made over to the king as a hereditary kingdom, without prejudice to the privileges of the Estates; whereupon they proceeded to Brewer's Hall, and informed the Estate of burghesses there assembled of what had been done. A fiery oration from Nansen dissolved some feeble opposition; and simultaneously Bishop Svane carried the clergy along with him. The so-called "Instrument," now signed by the Lower Estates, offered the realm to the king and his house as a hereditary monarchy, by way of thank-offering mainly for his courageous deliverance of the kingdom during the war; and the *Rigsraad* and the nobility were urged to notify the resolution to the king, and desire him to maintain each Estate in its due privileges, and to give a written counter-assurance that the revolution now to be effected was for the sole benefit of the state. Events now moved forward rapidly. On the 10th of October a deputation from the clergy and burghesses proceeded to the Council House where the *Rigsraad* were deliberating, to demand an answer to their propositions. After a tumultuous scene, the aristocratic *Raad* rejected the "Instrument" altogether, whereupon the deputies of the commons proceeded to the palace and were graciously received by the king, who promised them an answer next day. The same afternoon the guards in the streets and on the ramparts were doubled; on the following morning the gates of the city were closed, powder and bullets were distributed among the city train-bands, who were bidden to be in readiness when the alarm bell called them, and cavalry was massed on the environs of the city. The same afternoon the king sent a message to the *Rigsraad* urging them to declare their views quickly, as he could no longer hold himself responsible for what might happen. After a feeble attempt at a compromise the *Raad* gave way. On the 13th of October it signed a declaration to the effect that it associated itself still with the Lower Estates in the making over of the kingdom, as a hereditary monarchy, to his majesty and his heirs male and female. The same day the king received the official communication of this declaration and the congratulation of the burghmasters. Thus the ancient constitution was transformed; and Denmark became a monarchy hereditary in Frederick III. and his posterity.

But although hereditary sovereignty had been introduced, the laws of the land had not been abolished. The monarch was specifically now a sovereign over-lord, but he had not been absolved from his obligations towards his subjects. Hereditary sovereignty *per se* was not held to signify unlimited dominion, still less absolutism. On the contrary, the magnificent gift of the Danish nation to Frederick III. was made under express conditions. The "Instrument" drawn up by the Lower Estates implied the retention of all their rights; and the king, in accepting the gift of a hereditary crown, did not repudiate the implied inviolability of the privileges of the donors.

Unfortunately everything had been left so vague, that it was an easy matter for ultra-royalists like Svane and Nansen to ignore the privileges of the Estates, and even the Estates themselves.

On the 14th of October a committee was summoned to the palace to organize the new government. The discussion turned mainly upon two points, (1) whether a new oath of homage should be taken to the king, and (2) what was to be done with the *Håndfæstning* or royal charter. The first point was speedily decided in the affirmative, and, as to the second, it was ultimately decided that the king should be released from his oath and the charter returned to him; but a rider was added suggesting that he should, at the same time, promulgate a Recess providing for his own and his people's welfare. Thus Frederick III. was not left absolutely his own master; for the provision regarding a Recess, or new constitution, showed plainly enough that such a constitution was expected, and, once granted, would of course have limited the royal power.

It now only remained to execute the resolutions of the committee. On the 17th of October the charter, which the king had sworn to observe twelve years before, was solemnly handed back to him at the palace, Frederick III. thereupon promising to rule as a Christian king to the satisfaction of all the Estates of the realm. On the following day the king, seated on the topmost step of a lofty tribune surmounted by a baldaquin, erected in the midst of the principal square of Copenhagen, received the public homage of his subjects of all ranks, in the presence of an immense concourse, on which occasion he again promised to rule "as a Christian hereditary king and gracious master," and, "as soon as possible, to prepare and set up" such a constitution as should secure to his subjects a Christian and indulgent sway. The ceremony concluded with a grand banquet at the palace. After dinner the queen and the clergy withdrew; but the king remained. An incident now occurred which made a strong impression on all present. With a brimming beaker in his hand, Frederick III. went up to Hans Nansen, drank with him and drew him aside. They communed together in a low voice for some time, till the burgomaster, succumbing to the influence of his potations, fumbled his way to his carriage with the assistance of some of his civic colleagues. Whether Nansen, intoxicated by wine and the royal favour, consented on this occasion to sacrifice the privileges of his order and his city, it is impossible to say; but it is significant that, from henceforth, we hear no more of the Recess which the more liberal of the leaders of the lower orders had hoped for when they released Frederick III. from the obligations of the charter.

We can follow pretty plainly the stages of the progress from a limited to an absolute monarchy. By an act dated the 10th of January 1661, entitled "Instrument, or pragmatic sanction," of the king's hereditary right to the kingdoms of Denmark and Norway, it was declared that all the prerogatives of majesty, and "all regalia as an absolute sovereign lord," had been made over to the king. Yet, even after the issue of the "Instrument," there was nothing, strictly speaking, to prevent Frederick III. from voluntarily conceding to his subjects some share in the administration. Unfortunately the king was bent upon still further emphasizing the plenitude of his power. At Copenhagen his advisers were busy framing drafts of a *Lex Regia Perpetua*; and the one which finally won the royal favour was the famous *Kongelov*, or "King's Law."

This document was in every way unique. In the first place it is remarkable for its literary excellence. Compared with the barbarous macaronic jargon of the contemporary official language it shines forth as a masterpiece of pure, pithy and original Danish. Still more remarkable are the tone and tenor of this royal law. The *Kongelov* has the highly dubious honour of being the one written law in the civilized world which fearlessly carries out absolutism to the last consequences. The monarchy is declared to owe its origin to the surrender of the supreme authority by the Estates to the king. The maintenance of the indivisibility of the realm and of the Christian faith according to the

Augsburg Confession, and the observance of the *Kongelov* itself, are now the sole obligations binding upon the king. The supreme spiritual authority also is now claimed; and it is expressly stated that it becomes none to crown him; the moment he ascends the throne, crown and sceptre belong to him of right. Moreover, par. 26 declares guilty of *lèse-majesté* whomsoever shall in any way usurp or infringe the king's absolute authority. In the following reign the ultra-royalists went further still. In their eyes the king was not merely autocratic, but sacrosanct. Thus before the anointing of Christian V. on the 7th of June 1671, a ceremony by way of symbolizing the new autocrat's humble submission to the Almighty, the officiating bishop of Zealand delivered an oration in which he declared that the king was God's immediate creation, His vicegerent on earth, and that it was the bounden duty of all good subjects to serve and honour the celestial majesty as represented by the king's terrestrial majesty. The *Kongelov* is dated and subscribed the 14th of November 1665, but was kept a profound secret, only two initiated persons knowing of its existence until after the death of Frederick III., one of them being Kristoffer Gabel, the king's chief intermediary during the revolution, and the other the author and custodian of the *Kongelov*, Secretary Peder Schumacher, better known as Griffenfeldt. It is significant that both these confidential agents were plebeians.

The revolution of 1660 was certainly beneficial to Norway. With the disappearance of the *Rigsraad*, which, as representing the Danish crown, had hitherto exercised sovereignty over both kingdoms, Norway ceased to be a subject of the revolution of 1660. The sovereign hereditary king stood in exactly the same relations to both kingdoms; and thus, constitutionally, Norway was placed on an equality with Denmark, united with but not subordinate to it. It is clear that the majority of the Norwegian people hoped that the revolution would give them an administration independent of the Danish government; but these expectations were not realised. Till the cessation of the Union in 1814, Copenhagen continued to be the headquarters of the Norwegian administration; both kingdoms had common departments of state; and the common chancery continued to be called the Danish chancery. On the other hand the condition of Norway was now greatly improved. In January 1661 a land commission was appointed to investigate the financial and economical conditions of the kingdoms; the fiefs were transformed into counties; the nobles were deprived of their immunity from taxation, and in July 1662 the Norwegian towns received special privileges, including the monopoly of the lucrative timber trade.

The *Enevælde*, or absolute monarchy, also distinctly benefited the whole Danish state by materially increasing its reserve of native talent. Its immediate consequence was to throw open every state appointment to the middle classes, and the middle classes of that period, with very few exceptions, monopolized the intellect and the energy of the nation. New blood of the best quality nourished and stimulated the whole body politic. Expansion and progress were the watchwords at home, and abroad it seemed as if Denmark were about to regain her former position as a great power. This was especially the case during the brief but brilliant administration of Chancellor Griffenfeldt. Then, if ever, Denmark had the chance of playing once more a leading part in international politics. But Griffenfeldt's difficulties, always serious, were increased by the instability of the European situation, depending as it did on the ambition of Louis XIV. Resolved to conquer the Netherlands, the French king proceeded, first of all, to isolate her by dissolving the Triple Alliance. (See SWEDEN and GRIFFENFELDT.) In April 1672 a treaty was concluded between France and Sweden, on condition that France should not include Denmark in her system of alliances without the consent of Sweden. This treaty showed that Sweden weighed more in the French balances than Denmark. In June 1672 a French army invaded the Netherlands; whereupon the elector of Brandenburg contracted an alliance with the emperor Leopold. to which Denmark was invited to accede; almost simult

Establishment of absolute rule.

Christian V., 1670-1699.

the States-General began to negotiate for a renewal of the recently expired Dano-Dutch alliance.

In these circumstances it was as difficult for Denmark to remain neutral as it was dangerous for her to make a choice.

An alliance with France would subordinate her to Sweden; an alliance with the Netherlands would expose her to an attack from Sweden. The Franco-Swedish alliance left Griffenfeldt no choice but to accede to the opposite league, for he saw at once that the ruin of the

Netherlands would disturb the balance of power in the north by giving an undue preponderance to England and Sweden. But Denmark's experience of Dutch promises in the past was not reassuring; so, while negotiating at the Hague for a renewal of the Dutch alliance, he at the same time felt his way at Stockholm towards a commercial treaty with Sweden. His Swedish mission proved abortive, but, as he had anticipated, it effectually accelerated the negotiations at the Hague, and frightened the Dutch into unwonted liberality. In May 1673 a treaty of alliance was signed by the ambassador of the States-General at Copenhagen, whereby the Netherlands pledged themselves to pay Denmark large subsidies in return for the services of 10,000 men and twenty warships, which were to be held in readiness in case the United Provinces were attacked by another enemy besides France. Thus, very dexterously, Griffenfeldt had succeeded in gaining his subsidies without sacrificing his neutrality.

His next move was to attempt to detach Sweden from France; but, Sweden showing not the slightest inclination for a *s'approche-ment*, Denmark was compelled to accede to the anti-French league, which she did by the treaty of Copenhagen, of January 1674, thereby engaging to place an army of 20,000 in the field when required; but here again Griffenfeldt safeguarded himself to some extent by stipulating that this provision was not to be operative till the allies were attacked by a fresh enemy. When, in December 1674, a Swedish army invaded Prussian Pomerania, Denmark was bound to intervene as a belligerent, but Griffenfeldt endeavoured to postpone this intervention as long as possible; and Sweden's anxiety to avoid hostilities with her southern neighbour materially assisted him to postpone the evil day. He only wanted to gain time, and he gained it. To the last he endeavoured to avoid a rupture with France even if he broke with Sweden; but he could not restrain for ever the foolish impetuosity of his own sovereign, Christian V., and his fall in the beginning of 1676 not only, as he had foreseen, involved Denmark in an unprofitable war, but, as his friend and disciple, Jens Juel, well observed, relegated her henceforth to the humiliating position of an international catspaw. Thus at the peace of Fontainebleau (September 2, 1679) Denmark, which had borne the brunt of the struggle in the Baltic, was compelled by the inexorable French king to make full restitution to Sweden, the treaty between the two northern powers being signed at Lund on the 26th of September. Freely had she spent her blood and her treasure, only to emerge from the five years' contest exhausted and empty-handed.

By the peace of Fontainebleau Denmark had been sacrificed to the interests of France and Sweden; forty-one years later she was sacrificed to the interests of Hanover and Prussia by the peace of Copenhagen (1720), which ended the Northern War so far as the German powers were concerned. But it would not have terminated advantageously for them at all, had not the powerful and highly efficient Danish fleet effectually prevented the Swedish government from scourging its distressed German provinces, and finally swept the Swedish fleets out of the northern waters. Yet all the compensation Denmark received for her inestimable services during a whole decade was 600,000 rix-dollars! The bishoprics of Bremen and Verden, the province of Farther Pomerania and the isle of Rügen which her armies had actually conquered, and which had been guaranteed to her by a whole catena of treaties, went partly to the upstart electorate of Hanover and partly to the upstart kingdom of Prussia, both of which states had been of no political importance whatever at the beginning of the war of spoliation by which they were, ultimately, to profit so largely and so cheaply.

The last ten years of the reign of Christian V.'s successor, Frederick IV. (1699-1730), were devoted to the nursing and development of the resources of the country, which had suffered only less severely than Sweden from the effects of the Great Northern War. The court, seriously pious, did much for education. A wise economy also contributed to reduce the national debt within manageable limits, and in the welfare of the peasantry Frederick IV. took a deep interest. In 1722 serfdom was abolished in the case of all peasants in the royal estates born after his accession.

The first act of Frederick's successor, Christian VI. (1730-1746), was to abolish the national militia, which had been an intolerable burden upon the peasantry; yet the more pressing agrarian difficulties were not thereby surmounted, as had been hoped. The price of corn continued to fall; the migration of the peasantry assumed alarming proportions; and at last, "to preserve the land" as well as to increase the defensive capacity of the country, the national militia was re-established by the decree of the 4th of February 1733, which at the same time bound to the soil all peasants between the age of nine and forty. Reactionary as the measure was it enabled the agricultural interest, on which the prosperity of Denmark mainly depended, to tide over one of the most dangerous crises in its history; but certainly the position of the Danish peasantry was never worse than during the reign of the religious and benevolent Christian VI.

Under the peaceful reign of Christian's son and successor, Frederick V. (1746-1766), still more was done for commerce, industry and agriculture. To promote Denmark's carrying trade, treaties were made with the Barbary States, Genoa and Naples; and the East Indian Trading Company flourished exceedingly. On the other hand the condition of the peasantry was even worse under Frederick V. than it had been under Christian VI., the *Stovns-baand*, or regulation which bound all males to the soil, being made operative from the age of four. Yet signs of a coming amelioration were not wanting. The theory of the physiocrats now found powerful advocates in Denmark; and after 1755, when the press censorship was abolished so far as regarded political economy and agriculture, a thorough discussion of the whole agrarian question became possible. A commission appointed in 1757 worked zealously for the repeal of many agricultural abuses; and several great landed proprietors introduced hereditary leaseholds, and abolished the servile tenure.

Foreign affairs during the reigns of Frederick V. and Christian VI. were left in the capable hands of J. H. E. Bernstorff, who aimed at steering clear of all foreign complications and preserving inviolable the neutrality of Denmark. This he succeeded in doing, in spite of the Seven Years' War and of the difficulties attending the thorny Gottorp question in which Sweden and Russia were equally interested. The same policy was victoriously pursued by his nephew and pupil Andreas Bernstorff, an even greater man than the elder Bernstorff, who controlled the foreign policy of Denmark from 1773 to 1778, and again from 1784 till his death in 1797. The period of the younger Bernstorff synchronizes with the greater part of the long reign of Christian VII. (1766-1808), one of the most eventful periods of modern Danish history. The king himself was indeed a semi-idiot, scarce responsible for his actions, yet his was the era of such striking personalities as the brilliant charlatan Struensee, the great philanthropist and reformer C. D. F. Reventlow, the ultra-conservative Ove Hoegh-Guldberg, whose mission it was to repair the damage done by Struensee, and that generation of alert and progressive spirits which surrounded the young crown prince Frederick, whose first act, on taking his seat in the council of state, at the age of sixteen, on the 4th of April 1784, was to dismiss Guldberg.

A fresh and fruitful period of reform now began, lasting till nearly the end of the century, and interrupted only by the brief but costly war with Sweden in 1788. The emancipation of the peasantry was now the burning question of the day, and the whole matter was thoroughly ventilated. Bernstorff and the

Denmark
in the
Great
Northern
War.

Frederick
IV., 1699-
1730.

Christian
VI., 1730-
1746.

Frederick
V., 1746-
1766.

Christian
VII., 1766-
1808.

crown prince were the most zealous advocates of the peasantry in the council of state; but the honour of bringing the whole peasant question within the range of practical politics undoubtedly belongs to C. D. F. Reventlow (q.v.). Nor was the reforming principle limited to the abolition of serfdom. In 1788 the corn trade was declared free; the Jews received civil rights; and the negro slave trade was forbidden. In 1796 a special ordinance reformed the whole system of judicial procedure, making it cheaper and more expeditious; while the toll ordinance of the 1st of February 1797 still further extended the principle of free trade. Moreover, until two years after Bernstorff's death in 1797, the Danish press enjoyed a larger freedom of speech than the press of any other absolute monarchy in Europe, so much so that at last Denmark became suspected of favouring Jacobin views. But in September 1799 under strong pressure from the Russian emperor Paul, the Danish government forbade anonymity, and introduced a limited censorship.

It was Denmark's obsequiousness to Russia which led to the first of her unfortunate collisions with Great Britain. In 1800 the Danish government was persuaded by the tsar to accede to the second Armed Neutrality League, which Russia had just concluded with Prussia and Sweden. Great Britain retaliated by laying an embargo on the vessels of the three neutral powers, and by sending a considerable fleet to the Baltic under the command of Parker and Nelson. Surprised and unprepared though they were, the Danes, nevertheless, on the 2nd of April 1801, offered a gallant resistance; but their fleet was destroyed, their capital bombarded, and abandoned by Russia, they were compelled to submit to a disadvantageous peace.

The same vain endeavour of Denmark to preserve her neutrality led to the second breach with England. After the peace of Tilsit there could be no further question of neutrality. Napoleon had determined that if Great Britain refused to accept Russia's mediation, Denmark, Sweden and Portugal were to be forced to close their harbours to her ships and declare war against her. It was the intention of the Danish government to preserve its neutrality to the last, although, on the whole, it preferred an alliance with Great Britain to a league with Napoleon, and was even prepared for a breach with the French emperor if he pressed her too hardily. The army had therefore been assembled in Holstein, and the crown prince regent was with it. But the British government did not consider Denmark strong enough to resist France, and Canning had private trustworthy information of the designs of Napoleon, upon which he was bound to act. He sent accordingly a fleet, with 30,000 men on board, to the Sound to compel Denmark, by way of security for her future conduct, to unite her fleet with the British fleet. Denmark was offered an alliance, the complete restitution of her fleet after the war, a guarantee of all her possessions, compensation for all expenses, and even territorial aggrandizement.

Dictatorially presented as they were, these terms were liberal and even generous; and if a great statesman like Bernstorff had been at the head of affairs in Copenhagen, he would, no doubt, have accepted them, even if with a wry face. But the prince regent, if a good patriot, was a poor politician, and invincibly obstinate. When, therefore, in August 1807, Gambier arrived in the Sound, and the English plenipotentiary Francis James Jackson, not perhaps the most tactful person that could have been chosen, hastened to Kiel to place the British demands before the crown prince, Frederick not only refused to negotiate, but ordered the Copenhagen authorities to put the city in the best state of defence possible. Taking this to be tantamount to a declaration of war, on the 16th of August the British army landed at Vedbäck; and shortly afterwards the Danish capital was invested. Anything like an adequate defence was hopeless; a bombardment began which lasted from the 2nd of September till the 5th of September, and ended with the capitulation of the city and the surrender of the fleet intact, the prince regent having neglected to give orders for its destruction. After this Denmark, unwise, but not unnaturally, threw herself into the arms of Napoleon and

continued to be his faithful ally till the end of the war. She was punished for her obstinacy by being deprived of Norway, which she was compelled to surrender to Sweden by the terms of the treaty of Kiel (1814), on the 14th of January, receiving by way of compensation a sum of money and Swedish Pomerania, with Rügen, which were subsequently transferred to Prussia in exchange for the duchy of Lauenburg and 2,000,000 rix-dollars.

On the establishment of the German Confederation in 1815, Frederick VI. acceded thereto as duke of Holstein, but refused to allow Schleswig to enter it, on the ground that Schleswig was an integral part of the Danish realm.

The position of Denmark from 1815 to 1830 was one of great difficulty and distress. The loss of Norway necessitated considerable reductions of expenditure, but the economies actually practised fell far short of the requirements of Denmark after 1815. the diminished kingdom and its depleted exchequer; while the agricultural depression induced by the enormous fall in the price of corn all over Europe caused fresh demands upon the state, and added 10,000,000 rix-dollars to the national debt before 1835. The last two years of the reign of Frederick VI. (1838-1839) were also remarkable for the revival of political life, provincial consultative assemblies being established for Jutland, the Islands, Schleswig and Holstein, by the ordinance of the 28th of May 1831. But these consultative assemblies were regarded as insufficient by the Danish Liberals, and during the last years of Frederick VI. and the whole reign of his successor, Christian VIII. (1839-1848), the agitation for a free constitution, both in Denmark and the duchies, continued to grow in strength, in spite of press prosecutions and other repressive measures. The rising national feeling in Germany also stimulated the separatist tendencies of the duchies; and "Schleswig-Holsteinism," as it now began to be called, evoked in Denmark the counter-movement known as *Eiderdansk-politik*,

i.e. the policy of extending Denmark to the Eider and obliterating German Schleswig, in order to save Schleswig from being absorbed by Germany. This division of national sentiment within the monarchy, complicated by the approaching extinction of the Oldenburg line of the house of Denmark, by which, in the normal course under the Salic law, the succession to Holstein would have passed away from the Danish crown, opened up the whole complicated Schleswig-Holstein Question with all its momentous consequences. (See SCHLESWIG-HOLSTEIN QUESTION.) Within the monarchy itself, during the following years, "Schleswig-Holsteinism" and "Eiderdanism" faced each other as rival, mutually exacerbating forces; and the efforts of succeeding governments to solve the insoluble problem broke down ever on the rock of nationalist passion and the interests of the German powers. The unionist constitution, devised by Christian VIII., and promulgated by his successor, Frederick VII. (1848-1863), on the 28th of January 1848, led to the armed intervention of Prussia, at the instance of the new German parliament at Frankfurt; and, though with the help of Russian and British diplomacy, the Danes were ultimately successful, they had to submit, in 1851, to the government of Holstein by an international commission consisting of three members, Prussian, Austrian and Danish respectively.

Denmark, meanwhile, had been engaged in providing herself with a parliament on modern lines. The constitutional rescript of the 28th of January 1848 had been withdrawn in favour of an electoral law for a national assembly, of whose 152 members 38 were to be nominated by the king and to form an Upper House (*Landsting*), while the remainder were to be elected by the people and to form a popular chamber (*Folketing*). The *Bondevenlige*, or philo-peasant party, which objected to the king's right of nomination and preferred a one-chamber system, now separated from the National Liberals on this point. But the National Liberals triumphed at the general election; fear of reactionary tendencies finally induced the Radicals to accede to the wishes of the majority; and on the 5th of June 1849 the new constitution received the royal sanction.

Denmark and Great Britain in the Napoleonic Wars.

Constitutional agitation in Schleswig-Holstein.

Unionist Constitution of 1848, and war with Prussia.

At this stage Denmark's foreign relations prejudicially affected her domestic politics. The Liberal Eiderdansk party was for dividing Schleswig into three distinct administrative belts, according as the various nationalities predominated (language rescripts of 1851), but German sentiment was opposed to any such settlement and, still worse, the great continental powers looked askance on the new Danish constitution as far too democratic. The substance of the notes embodying the exchange of views, in 1851 and 1852, between the German great powers and Denmark, was promulgated, on the 28th of January 1852, in the new constitutional decree which, together with the documents on which it was founded, was known as the Conventions of 1851 and 1852. Under this arrangement each part of the monarchy was to have local autonomy, with a common constitution for common affairs. Holstein was now restored to

Denmark, and Prussia and Austria consented to take part in the conference of London, by which the integrity of Denmark was upheld, and the succession to the whole monarchy settled on Prince Christian, youngest son of Duke William of Schleswig-Holstein-Sonderburg-Glücksburg, and husband of Louise of Hesse, the niece of King Christian VIII. The "legitimate" heir to the duchies, under the Salic law, Duke Christian of Sonderburg-Augustenburg, accepted the decision of the London conference in consideration of the purchase by the Danish government of his estates in Schleswig.

On the 2nd of October 1855 was promulgated the new common constitution, which for two years had been the occasion of a fierce contention between the Conservatives and the Radicals. It proved no more final than its predecessors.

The representatives of the duchies in the new common *Rigsraad* protested against it, as subversive of the Conventions of 1851 and 1852; and their attitude had the support of the German powers. In 1857, Carl Christian Hall (q.v.) became prime minister. After putting off the German powers by seven years of astute diplomacy, he realized the impossibility of carrying out the idea of a common constitution and, on the 30th of March 1862, a royal proclamation was issued detaching Holstein as far as possible from the common monarchy. Later in the year he introduced into the *Rigsraad* a common constitution for Denmark and Schleswig, which was carried through and confirmed by the council of state on the 13th of November 1863. It had not, however, received the royal assent when the death of Frederick VII. brought the "Protocol King" Christian IX. to the throne.

Placed between the necessity of offending his new subjects or embroiling himself with the German powers, Christian chose the remoter evil and, on the 18th of November, the new constitution became law. This once more opened up the whole question in an acute form. Frederick, son of Christian of Augustenburg, refusing to be bound by his father's engagements, entered Holstein and, supported by the Estates and the German diet, proclaimed himself duke. The events that followed: the occupation of the duchies by Austria and Prussia, the war of 1864, gallantly fought by the Danes against overwhelming odds, and the astute diplomacy by which Bismarck succeeded in ultimately gaining for Prussia the seaboard so essential for her maritime power, are dealt with elsewhere (see SCHLESWIG-HOLSTEIN QUESTION). For Denmark the question was settled when, by the peace of Vienna (October 30, 1864), the duchies were irretrievably lost to her. At the peace of Prague, which terminated the Austro-Prussian War of 1866, Napoleon III. procured the insertion in the treaty of paragraph v., by which the northern districts of Schleswig were to be reunited to Denmark when the majority of the population by a free vote should so desire; but when Prussia at last thought fit to negotiate with Denmark on the subject, she laid down conditions which the Danish government could not accept. Finally, in 1878, by a separate agreement between Austria and Prussia, paragraph v. was rescinded.

The salient feature of Danish politics during subsequent years

was the struggle between the two *Tings*, the *Folketing* or Lower House, and the *Landsing*, or Upper House of the *Rigsdag*. This contest began in 1872, when a combination of all the Radical parties, known as the "United Left," passed a vote of want of confidence against the government and rejected the budget. Nevertheless, the ministry, supported by the *Landsing*, refused to resign; and the crisis became acute when, in 1875, J. B. Estrup became prime minister. Perceiving that the coming struggle would be essentially a financial one, he retained the ministry of finance in his own hands; and, strong in the support of the king, the *Landsing*, and a considerable minority in the country itself, he devoted himself to the double task of establishing the political parity of the *Landsing* with the *Folketing* and strengthening the national armaments, so that, in the event of a war between the European great powers, Denmark might be able to defend her neutrality.

The Left was willing to vote 30,000,000 crowns for extraordinary military expenses, exclusive of the fortifications of Copenhagen, on condition that the amount should be raised by a property and income tax; and, as the elections of 1875 had given them a majority of three-fourths in the popular chamber, they spoke with no uncertain voice. But the Upper House steadily supported Estrup, who was disinclined to accept any such compromise. As an agreement between the two houses on the budget proved impossible, a provisional financial decree was issued on the 12th of April 1877, which the Left stigmatized as a breach of the constitution. But the difficulties of the ministry were somewhat relieved by a split in the Radical party, still further accentuated by the elections of 1879, which enabled Estrup to carry through the army and navy defence bill and the new military penal code by leaning alternately upon one or the other of the divided Radical groups.

After the elections of 1881, which brought about the reamalgamation of the various Radical sections, the opposition presented a united front to the government, so that, from 1882 onwards, legislation was almost at a standstill. The elections of 1884 showed clearly that the nation was also now on the side of the Radicals, 83 out of the 102 members of the *Folketing* belonging to the opposition. Still Estrup remained at his post. He had underestimated the force of public opinion, but he was conscientiously convinced that a Conservative ministry was necessary to Denmark at this crisis. When therefore the *Rigsdag* rejected the budget, he advised the king to issue another provisional financial decree. Henceforth, so long as the *Folketing* refused to vote supplies, the ministry regularly adopted these makeshifts. In 1886 the Left, having no constitutional means of dismissing the Estrup ministry, resorted for the first time to negotiations; but it was not till the 1st of April 1894 that the majority of the *Folketing* could arrive at an agreement with the government and the *Landsing* as to a budget which should be retrospective and sanction the employment of the funds so irregularly obtained for military expenditure. The whole question of the provisional financial decrees was ultimately regularized by a special resolution of the *Rigsdag*; and the retirement of the Estrup ministry in August 1894 was the immediate result of the compromise.

In spite of the composition of 1894, the animosity between *Folketing* and *Landsing* continues to characterize Danish politics, and the situation has been complicated by the division of both Right and Left into widely divergent groups. The elections of 1895 resulted in an undeniable victory of the extreme Radicals; and the budget of 1895-1896 was passed only at the last moment by a compromise. The session of 1896-1897 was remarkable for a *rapprochement* between the ministry and the "Left Reform Party," caused by the secessions of the "Young Right," which led to an unprecedented event in Danish politics—the voting of the budget by the Radical *Folketing* and its rejection by the Conservative *Landsing* in May 1897; whereupon the ministry resigned in favour of the moderate Conservative Hörring cabinet, which induced the Upper House to pass the budget. The elections of 1898 were a fresh defeat for the Conservatives, and in the autumn session of the same year, the *Folketing*, by a crushing majority of

85 to 12, rejected the military budget. The ministry was saved by a mere accident—the expulsion of Danish agitators from North Schleswig by the German government, which evoked a passion of patriotic protest throughout Denmark, and united all parties, the war minister declaring in the *Folketing*, during the debate on the military budget (January 1899), that the armaments of Denmark were so far advanced that any great power must think twice before venturing to attack her. The chief event of the year 1899 was the great strike of 40,000 artisans, which cost Denmark 50,000,000 crowns, and brought about a reconstruction of the cabinet in order to bring in, as minister of the interior, Ludwig Ernest Bransen, the great specialist in industrial matters, who succeeded (September 2-4) in bringing about an understanding between workmen and employers. The session 1900-1901 was remarkable for the further disintegration of the Conservative party still in office (the Sehested cabinet superseded the Hørring cabinet on the 27th of April 1900) and the almost total paralysis of parliament, caused by the interminable debates on the question of taxation reform. The crisis came in 1901. Deprived of nearly all its supporters in the *Folketing*, the Conservative ministry resigned, and King Christian was obliged to assent to the formation of a "cabinet of the Left" under Professor Deuntzer. Various reforms were carried, but the proposal to sell the Danish islands in the West Indies to the United States fell through. During these years the relations between Denmark and the German empire improved, and in the country itself the cause of social democracy made great progress. In January 1906 King Christian ended his long reign, and was succeeded by his son Frederik VIII. At the elections of 1906 the government lost its small absolute majority, but remained in power with support from the Moderates and Conservatives. It was severely shaken, however, when Herr A. Alberti, who had been minister of justice since 1901, and was admitted to be the strongest member of the cabinet, was openly accused of nepotism and abuse of the power of his position. These charges gathered weight until the minister was forced to resign in July 1908, and in September he was arrested on a charge of forgery in his capacity as director of the Zealand Peasants' Savings Bank. The ministry, of which Herr Jens Christian Christensen was head, was compelled to resign in October. The effect of these revelations was profound not only politically, but also economically; the important export trade in Danish butter, especially, was adversely affected, as Herr Alberti had been interested in numerous dairy companies.

BIBLIOGRAPHY.—I. GENERAL HISTORY. *Danmarks Riges Historie* (Copenhagen, 1897-1905); R. Nisbet Bain, *Scandinavia* (Cambridge, 1905); H. Weitemeyer, *Denmark* (London, 1901); Adolf Ditlev Jørgensen, *Historiske Afsnit* (Copenhagen, 1898); *ib. Fortællinger af Nordens Historie* (Copenhagen, 1892). II. EARLY AND MEDIEVAL HISTORY. Saxo, *Gesta Danorum* (Strassburg, 1886); *Reperitorium diplomaticum regni Daniæ mediævalis* (Copenhagen, 1894); Ludvig Holberg, *Konger og Daneshof* (Copenhagen, 1895); Poul Frederik Barford, *Danmarks Historie 1310-1536* (Copenhagen, 1885); *ib. 1536-1670* (Copenhagen, 1891). III. 16TH TO 19TH CENTURY. Philip P. Munch, *Købstadsstyrelsen i Danmark* (Copenhagen, 1900); Peter Edvard Holm, *Danmark Norges indre Historie, 1660-1720* (Copenhagen, 1885-1886); *ib. Danmark Norges Historie, 1720-1814* (Copenhagen, 1891-1894); Sören Bloch Thrige, *Danmarks Historie i vort Aarhundrede* (Copenhagen, 1888); Marcus Rubin, *Frederik VI.'s Tid fra Kielesfreden* (Copenhagen, 1895); Christian Frederik von Holten, *Erindringer; Der deutsch-dänrische Krieg* (Stuttgart, 1900); S. N. Mouritzen, *Vor Fortfæljnings Historie* (Copenhagen, 1894); Carl Frederik Vilhelm Mathildus Rosenberg, *Danmark i Aare 1848* (Copenhagen, 1891). See also the special bibliographies appended to the biographies of the Danish kings and statesmen. (R. N. B.)

LITERATURE

The present language of Denmark is derived directly from the same source as that of Sweden, and the parent of both is the old Scandinavian (see SCANDINAVIAN LANGUAGES). In Iceland this tongue, with some modifications, has remained in use, and until about 1100 it was the literary language of the whole of Scandinavia. The influence of Low German first, and High German afterwards, has had the effect of drawing modern Danish constantly farther from this early type. The difference began to

show itself in the 12th century. R. K. Rask, and after him N. M. Petersen, have distinguished four periods in the development of the language. The first, which has been called Oldest Danish, dating from about 1100 and 1250, shows a slightly changed character, mainly depending on the system of inflections. In the second period, that of Old Danish, bringing us down to 1400, the change of the system of vowels begins to be settled, and masculine and feminine are mingled in a common gender. An indefinite article has been formed, and in the conjugation of the verb a great simplicity sets in. In the third period, 1400-1530, the influence of German upon the language is supreme, and culminates in the Reformation. The fourth period, from 1530 to about 1680, completes the work of development, and leaves the language as we at present find it.

The earliest work known to have been written in Denmark was a Latin biography of Knud the Saint, written by an English monk Ælnoth, who was attached to the church of St Alban in Odense where King Knud was murdered. Denmark produced several Latin writers of merit. Anders Sunesen (d. 1228) wrote a long poem in hexameters, *Hexæmeron*, describing the creation. Under the auspices of Archbishop Absalon the monks of Sorø began to compile the annals of Denmark, and at the end of the 12th century Svend Aagesen, a cleric of Lund, compiled from Icelandic sources and oral tradition his *Compendiosa historia regum Danicæ*. The great Saxo Grammaticus (q.v.) wrote his *Historia Danica* under the same patronage.

It was not till the 16th century that literature began to be generally practised in the vernacular in Denmark. The oldest laws which are still preserved date from the beginning of the 13th century, and many different collections are in existence.¹ A single work remains us in the 13th century, a treatise on medicine² by Henrik Harpestreng, who died in 1244. The first royal edict written in Danish is dated 1386; and the Act of Union at Kalmar, written in 1397, is the most important piece of the vernacular of the 14th century. Between 1300 and 1500, however, it is supposed that the *Kjæmpeviser*, or Danish ballads, a large collection of about 500 epic and lyrical poems, were originally composed, and these form the most precious legacy of the Denmark of the middle ages, whether judged historically or poetically. We know nothing of the authors of these poems, which treat of the heroic adventures of the great warriors and lovely ladies of the chivalric age in strains of artless but often exquisite beauty. Some of the subjects are borrowed in altered form from the old mythology, while a few derive from Christian legend, and many deal with national history. The language in which we receive these ballads, however, is as late as the 16th or even the 17th century, but it is believed that they have become gradually modernized in the course of oral tradition. The first attempt to collect the ballads was made in 1591 by Anders Sørensen Vedel (1542-1616), who published 100 of them. Peder Syv printed 100 more in 1695. In 1812-1814 an elaborate collection in five volumes appeared at Christiania, edited by W. H. F. Abrahamson, R. Nyerup and K. M. Rahbek. Finally, Svend Grundtvig produced an exhaustive edition, *Danmarks gamle Folkeviser* (Copenhagen, 1853-1883, 5 vols.), which was supplemented (1891) by A. Olrik. In 1490, the first printing press was set up at Copenhagen, by Gottfried of Gemen, who had brought it from Westphalia; and five years later the first Danish book was printed. This was the famous *Rimkrønike*³; a history of Denmark in rhymed Danish verse, attributed by its first editor to Niels (d. 1481), a monk of the monastery of Sorø. It extends to the death of Christian I., in 1481, which may be supposed to be approximately the date of the poem. In 1479 the university of Copenhagen had been founded. In 1506 the same Gottfried of Gemen published a famous collection of proverbs, attributed to Peder Laale. Mikkel, priest of St Alban's Church in Odense, wrote three sacred poems, *The Rose-Garland of Maiden Mary, The Creation and*

¹ Collected as *Samling af gamle danske Love* (5 vols., Copenhagen, 1821-1827).

² *Henrik Harpestraengs Lægebog* (ed. C. Molbech, Copenhagen, 1826).

³ Ed. C. Molbech (Copenhagen, 1825).

Human Life, which came out together in 1514, shortly before his death. The popular *Lucidarius* also appeared in the vulgar tongue.

These few productions appeared along with innumerable works in Latin, and dimly heralded a Danish literature. It was the Reformation that first awoke the living spirit in the popular tongue. Christiern Pedersen (q.v.; 1480-1554) was the first man of letters produced in Denmark. He edited and published, at Paris in 1514, the Latin text of the old chronicler, Saxo Grammaticus; he worked up in their present form the beautiful half-mythical stories of *Karl Magnus* (Charlemagne) and *Holger Danske* (Ogier the Dane). He further translated the Psalms of David and the New Testament, printed in 1520, and finally—in conjunction with Bishop Peder Palladius—the Bible, which appeared in 1550. Hans Tausen, the bishop of Ribe (1494-1561), continued Pedersen's work, but with far less literary talent. He may, however, be considered as the greatest orator and teacher of the Reformation movement. He wrote a number of popular hymns, partly original, partly translations; translated the Pentateuch from the Hebrew; and published (1536) a collection of sermons embodying the reformed doctrine and destined for the use of clergy and laity.

The Catholic party produced one controversialist of striking ability, Povel Helgesen¹ (b. c. 1480), also known as Paulus Eliae. He had at first been inclined to the party of reform, but when Luther broke definitely with the papal authority he became a bitter opponent. His most important polemical work is an answer (1528) to twelve questions on the religious question propounded by Gustavus I. of Sweden. He is also supposed to be the author of the *Skiby Chronicle*,² in which he does not confine himself to the duties of a mere annalist, but records his personal opinion of people and events. Vedel, by the edition of the *Kjoempesiser* which is mentioned above, gave an immense stimulus to the progress of literature. He published an excellent translation of Saxo Grammaticus in 1575. The first edition of a Danish *Reineke Fuchs*, by Herman Weigere, appeared at Lübeck in 1555, and the first authorized Psalter in 1559. Arild Huitfeldt wrote *Chronicle of the Kingdom of Denmark*, printed in ten volumes, between 1595 and 1604.

There are few traces of dramatic effort in Denmark before the Reformation; and many of the plays of that period may be referred to the class of school comedies. Hans Sthen, a lyrical poet, wrote a morality entitled *Kortveending* ("Change of Fortune"), which is really a collection of monologues to be delivered by students. The anonymous *Ludus de Sancto Kanoelo*³ (c. 1530) which in spite of its title, is written in Danish, is the earliest Danish national drama. The burlesque drama assigned to Christian Hansen, *The Faithless Wife*, is the only one of its kind that has survived. But the best of these old dramatic authors was a priest of Viborg, Justesen Ranch (1539-1607), who wrote *Kong Salomons Hylding* ("The Crowning of King Solomon") (1585), *Samsons Fuengsel* ("The Imprisonment of Samson"), which includes lyrical passages which have given it claims to be considered the first Danish opera, and a farce, *Karrig Niding* ("The Miserly Miscreant"). Beside these works Ranch wrote a famous moralizing poem, entitled "A new-song, of the nature and song of certain birds, in which many vices are punished, and many virtues praised." Peder Clausen⁴ (1545-1614), a Norwegian by birth and education, wrote a *Description of Norway*, as well as an admirable translation of Snorri Sturluson's *Heimskringla*, published ten years after Clausen's death. The father of Danish poetry, Anders Kristensen Arrebo (1587-1637), was bishop of Trondhjem, but was deprived of his see for immorality. He was a poet of considerable genius, which is most brilliantly shown in an imitation of Du Bartas's *Divine Semaine*,

¹ See *Povel Eliensens danske Skrifter* (Copenhagen, 1855, &c.), edited by C. E. Secher.

² See *Monumenta historiae Danicae* (ed H. Rördam, vol. i., 1873).

³ Ed. Sophus Birket Smith (Copenhagen, 1868), who also edited the comedies ascribed to Chr. Hansen as *De tre ældste danske Skuespil* (1874), and the works of Ranch (1876).

⁴ His works were edited by Gustav Storm (Christiania, 1877-1879).

the *Hexameron*, a poem on the creation, in six books, which did not appear till 1661. He also made a translation of the Psalms.

He was followed by Anders Bording (1619-1677), a cheerful occasional versifier, and by Thøger Reenberg (1656-1742), a poet of somewhat higher gifts, who lived on into a later age. Among prose writers should be mentioned the grammarian Peder Syv,⁵ (1631-1702); Bishop Erik Pontoppidan (1616-1678), whose *Grammatica Danica*, published in 1668, is the first systematic analysis of the language; Birgitta Thott (1610-1662), a lady who translated Seneca (1658); and Leonora Christina Ulfeld, daughter of Christian IV., who has left a touching account of her long imprisonment in her *Jammersminde*. Ole Worm (1588-1654), a learned pedagogue and antiquarian, preserved in his *Danicorum monumentorum libri sex* (Copenhagen, 1643) the descriptions of many antiquities which have since perished or been lost.

In two spiritual poets the advancement of the literature of Denmark took a further step. Thomas Kingo⁶ (1634-1703) was the first who wrote Danish with perfect ease and grace. He was a Scot by descent, and retained the vital energy of his ancestors as a birthright. In 1677 he became bishop in Fünen, where he died in 1703. His *Winter Psalter* (1680), and the so-called *Kingo's Psalter* (1699), contained brilliant examples of lyrical writing, and an employment of language at once original and national. Kingo had a charming fancy, a clear sense of form and great rapidity and variety of utterance. Some of his very best hymns are in the little volume he published in 1681, and hence the old period of semi-articulate Danish may be said to close with this eventful decade, which also witnessed the birth of Holberg. The other great hymn-writer was Hans Adolf Brorson (1694-1764), who published in 1740 a great psalm-book at the king's command, in which he added his own to the best of Kingo's. Both these men held high posts in the church, one being bishop of Fünen and the other of Ribe; but Brorson was much inferior to Kingo in genius. With these names the introductory period of Danish literature ends. The language was now formed, and was being employed for almost all the uses of science and philosophy.

Ludvig Holberg (q.v.; 1684-1754) may be called the founder of modern Danish literature. His various works still retain their freshness and vital attraction. As an historian his style was terse and brilliant, his spirit philosophical, and his data singularly accurate. He united two unusual gifts, being at the same time the most cultured man of his day, and also in the highest degree a practical person, who clearly perceived what would most rapidly educate and interest the uncultivated. In his thirty-three dramas, sparkling comedies in prose, more or less in imitation of Molière, he has left his most important positive legacy to literature. Nor in any series of comedies in existence is decency so rarely sacrificed to a desire for popularity or a false sense of wit.

Holberg founded no school of immediate imitators, but his stimulating influence was rapid and general. The university of Copenhagen, which had been destroyed by fire in 1728, was reopened in 1742, and under the auspices of the historian Hans Gram (1685-1748), who founded the Danish Royal Academy of Sciences, it inspired an active intellectual life. Gram laid the foundation of critical history in Denmark. He brought to bear on the subject a full knowledge of documents and sources. His best work lies in his annotated editions of the older chroniclers. In 1744 Jakob Langebek (1710-1775) founded the Society for the Improvement of the Danish Language, which opened the field of philology. He began the great collection of *Scriptores rerum Danicarum mediæ ævi* (9 vols., Copenhagen, 1772-1878). In jurisprudence Andreas Hbier (1690-1739) represented the new impulse, and in zoology Erik Pontoppidan (q.v.), the younger. This last name represents a lifelong activity in many branches of literature. From Holberg's college of Sorø, two learned professors, Jens Schelderup Sneedorff (1724-1764) and Jens Kraft (1720-1765), disseminated the seeds of a wider culture. All these men were aided by the generous and enlightened patronage

⁵ See Fr. W. Horn, *Peder Syv* (Copenhagen, 1878).

⁶ See A. C. L. Heiberg, *Thomas Kingo* (Odense, 1852).

of Frederick V. A little later on, the German poet Klopstock settled in Copenhagen, bringing with him the prestige of his great reputation, and he had a strong influence in Germanizing Denmark. He founded, however, the Society for the Fine Arts, and had it richly endowed. The first prize offered was won by Christian Braumann Tullin (1728-1765) for his beautiful poem of *May-day*. Tullin, a Norwegian by birth, represents the first accession of a study of external nature in Danish poetry; he was an ardent disciple of the English poet Thomson. Christian Falster (1690-1752) wrote satires of some merit, but most of his work is in Latin. The *New Heroic Poems* of Jørgen Sorterup are notable as imitations of the old folk-literature. Ambrosius Stub¹ (1705-1758) was a lyrical of great sweetness, born before his due time, whose poems, not published till 1771, belong to a later age than their author.

The Lyrical Revival.—Between 1742 and 1749, that is to say, at the very climax of the personal activity of Holberg, several poets were born, who were destined to enrich the language with its first group of lyrical blossoms. Of these the two oldest, Wessel and Ewald, were men of extraordinary genius, and destined to fascinate the attention of posterity, not only by the brilliance of their productions, but by the suffering and brevity of their lives. Johannes Ewald (q.v.; 1743-1781) was not only the greatest Danish lyrical of the 18th century, but he had few rivals in the whole of Europe. As a dramatist, pure and simple, his bird-like instinct of song carried him too often into a sphere too exalted for the stage; but he has written nothing that is not stamped with the exquisite quality of distinction. Johan Herman Wessel² (1742-1785) excited even greater hopes in his contemporaries, but left less that is immortal behind him. After the death of Holberg, the affectation of Gallicism had reappeared in Denmark; and the tragedies of Voltaire, with their stilted rhetoric, were the most popular dramas of the day. Johan Nordahl Brun (1745-1816), a young writer who did better things later on, gave the finishing touch to the exotic absurdity by bringing out a wretched piece called *Zarina*, which was hailed by the press as the first original Danish tragedy, although Ewald's exquisite *Rolf Krage*, which truly merited that title, had appeared two years before. Wessel, who up to that time had only been known as the president of a club of wits, immediately wrote *Love without Stockings* (1772), in which a plot of the most abject triviality is worked out in strict accordance with the rules of French tragedy, and in most pompous and pathetic Alexandrines. The effect of this piece was magical; the Royal Theatre ejected its cuckoo-brood of French plays, and even the Italian opera. It was now essential that every performance should be national, and in the Danish language. To supply the place of the opera, native musicians, and especially J. P. E. Hartmann, set the dramas of Ewald and others, and thus the Danish school of music originated. Johan Nordahl Brun's best work is to be found in his patriotic songs and his hymns. He became bishop of Bergen in 1803.

Of the other poets of the revival the most important were born in Norway. Nordahl Brun, Claus Frimann (1746-1829), Claus Fasting (1746-1791), who edited a brilliant aesthetic journal, *The Critical Observer*, Christian H. Pram³ (1756-1821), author of *Sterkehoder*, a romantic epic, based on Scandinavian legend, and Edvard Storm (1749-1794), were associates and mainly fellow-students at Copenhagen, where they introduced a style peculiar to themselves, and distinct from that of the true Danes. Their lyrics celebrated the mountains and rivers of the magnificent country they had left; and, while introducing images and scenery unfamiliar to the inhabitants of monotonous Denmark, they enriched the language with new words and phrases. This group of writers is now claimed by the Norwegians as the founders of a Norwegian literature; but their true place is certainly among the Danes, to whom they primarily appealed. They added

¹ His collected works were edited by Fr. Barford (Copenhagen, 5th ed., 1879).

² Wessel's *Digte* (3rd ed., 1895) are edited by J. Levin, with a biographical introduction.

³ A biography by his friend, K. L. Rahbek, is prefixed to a selection of his poetry (6 vols., 1824-1829).

nothing to the development of the drama, except in the person of N. K. Bredal (1733-1778), who became director of the Royal Danish Theatre, and the writer of some mediocre plays.

To the same period belong a few prose writers of eminence. Werner Abrahamson (1744-1812) was the first aesthetic critic Denmark produced. Johan Clemens Tode (1736-1806) was eminent in many branches of science, but especially as a medical writer. Ove Malling (1746-1829) was an untiring collector of historical data, which he annotated in a lively style. Two historians of more definite claim on our attention are Peter Frederik Suhm (1728-1798), whose *History of Denmark* (11 vols., Copenhagen, 1782-1812) contains a mass of original material, and Ove Guldberg (1731-1808). In theology Christian Baltholm (1740-1810) and Nicolai Edinger Balle (1744-1816), bishop of Zealand, a Norwegian by birth, demand a reference. But the only really great prose-writer of the period was the Norwegian, Niels Treschow (1751-1833), whose philosophical works are composed in an admirably lucid style, and are distinguished for their depth and originality.

The poetical revival sank in the next generation to a more mechanical level. The number of writers of some talent was very great, but genius was wanting. Two intimate friends, Jonas Rein (1760-1821) and Jens Zeilitz (1761-1821), attempted, with indifferent success, to continue the tradition of the Norwegian group. Thomas Thaarup (1749-1821) was a fluent and eloquent writer of occasional poems, and of homely dramatic idylls. The early death of Ole Samsøe (1759-1796) prevented the development of a dramatic talent that gave rare promise. But while poetry languished, prose, for the first time, began to flourish in Denmark. Knud Lyne Rahbek (1760-1830) was a pleasing novelist, a dramatist of some merit, a pathetic elegist, and a witty song-writer; he was also a man full of the literary instinct, and through a long life he never ceased to busy himself with editing the works of the older poets, and spreading among the people a knowledge of Danish literature through his magazine, *Minerva*, edited in conjunction with C. H. Pram. Peter Andreas Heiberg (1758-1841) was a political and aesthetic critic of note. He was exiled from Denmark in company with another sympathizer with the principles of the French Revolution, Malte Conrad Brunn (1775-1826), who settled in Paris, and attained a world-wide reputation as a geographer. O. C. Olufsen (1764-1827) was a writer on geography, zoology and political economy. Rasmus Nyerup (1759-1820) expended an immense energy in the compilation of admirable works on the history of language and literature. From 1778 to his death he exercised a great power in the statistical and critical departments of letters. The best historian of this period, however, was Engelstoft (1774-1850), and the most brilliant theologian Bishop Mynster (1775-1854). In the annals of modern science Hans Christian Oersted (1777-1851) is a name universally honoured. He explained his inventions and described his discoveries in language so lucid and so characteristic that he claims an honoured place in the literature of the country of whose culture, in other branches, he is one of the most distinguished ornaments.

On the threshold of the romantic movement occurs the name of Jens Baggesen (q.v.; 1764-1826), a man of great genius, whose work was entirely independent of the influences around him. Jens Baggesen is the greatest comic poet that Denmark has produced; and as a satirist and witty lyricist he has no rival among the Danes. In his hands the difficulties of the language disappear; he performs with the utmost ease extraordinary *lours de force* of style. His astonishing talents were wasted on trifling themes and in a fruitless resistance to the modern spirit in literature.

Romanticism.—With the beginning of the 19th century the new light in philosophy and poetry, which radiated from Germany through all parts of Europe, found its way into Denmark also. In scarcely any country was the result so rapid or so brilliant. There arose in Denmark a school of poets who created for themselves a reputation in all parts of Europe, and would have done honour to any nation or any age. The splendid cultivation of metrical art threw other branches into the shade; and the epoch

of which we are about to speak is eminent above all for mastery over verse. The swallow who heralded the summer was a German by birth, Adolph Wilhelm Schack von Staffeldt¹ (1769-1826), who came over to Copenhagen from Pomerania, and prepared the way for the new movement. Since Ewald no one had written Danish lyrical verse so exquisitely as Schack von Staffeldt, and the depth and scientific precision of his thought won him a title which he has preserved, of being the first philosophic poet of Denmark. The writings of this man are the deepest and most serious which Denmark had produced, and at his best he yields to no one in choice and skillful use of expression. This sweet song of Schack von Staffeldt's, however, was early silenced by the louder choir that one by one broke into music around him. It was Adam Gottlob Öhlschläger (*q.v.*; 1779-1850), the greatest poet of Denmark, who was to bring about the new romantic movement. In 1802 he happened to meet the young Norwegian Henrik Steffens (1773-1845), who had just returned from a scientific tour in Germany, full of the doctrines of Schelling. Under the immediate direction of Steffens, Öhlschläger began an entirely new poetic style, and destroyed all his earlier verses. A new epoch in the language began, and the rapidity and matchless facility of the new poetry was the wonder of Steffens himself. The old Scandinavian mythology lived in the hands of Öhlschläger exactly as the classical Greek religion was born again in Keats. He aroused in his people the slumbering sense of their Scandinavian nationality.

The retirement of Öhlschläger comparatively early in life, left the way open for the development of his younger contemporaries, among whom several had genius little inferior to his own. Steen Steensen Blicher (1782-1848) was a Jutlander, and preserved all through life the characteristics of his sterile and sombre fatherland. After a struggling youth of great poverty, he published, in 1807-1809, a translation of Ossian; in 1814 a volume of lyrical poems; and in 1817 he attracted considerable attention by his descriptive poem of *The Tour in Jutland*. His real genius, however, did not lie in the direction of verse; and his first signal success was with a story, *A Village Sexton's Diary*, in 1824, which was rapidly followed by other tales, descriptive of village life in Jutland, for the next twelve years. These were collected in five volumes (1833-1836). His masterpiece is a collection of short stories, called *The Spinning Room*. He also produced many national lyrics of great beauty. But it was Blicher's use of *patois* which delighted his countrymen with a sense of freshness and strength. They felt as though they heard Danish for the first time spoken in its fulness. The poet Aarestrup (in 1848) declared that Blicher had raised the Danish language to the dignity of Icelandic. Blicher is a stern realist, in many points akin to Crabbe, and takes a singular position among the romantic idealists of the period, being like them, however, in the love of precise and choice language, and hatred of the mere commonplace of imaginative writing.²

Nikolai Frederik Severin Grundtvig (*q.v.*; 1783-1872), like Öhlschläger, learned the principles of the German romanticism from the lips of Steffens. He adopted the idea of introducing the Old Scandinavian element into art, and even into life, still more earnestly than the older poet. Bernhard Severin Ingemann (*q.v.*; 1789-1862) contributed to Danish literature historical romances in the style of Sir Walter Scott. Johannes Carsten Hauch (*q.v.*; 1790-1872) first distinguished himself as a disciple of Öhlschläger, and fought under him in the strife against the old school and Baggesen. But the master misunderstood the disciple; and the harsh repulse of Öhlschläger silenced Hauch for many years. He possessed, however, a strong and fluent genius, which eventually made itself heard in a multitude of volumes, poems, dramas and novels. All that Hauch wrote is marked by great qualities, and by distinction; he had a native bias towards the mystical, which, however, he learned to keep in abeyance.

¹ See F. L. Liebenberg, *Schack Staffeldts samlede Digte* (2 vols., Copenhagen, 1843), and *Samlinger til Schack Staffeldts Lænest* (4 vols., 1846-1851).

² Blicher's *Tales* were edited by P. Hansen (3 vols., Copenhagen, 1871), and his *Poems* in 1870.

Johan Ludvig Heiberg (*q.v.*; 1791-1860) was a critic who ruled the world of Danish taste for many years. His mother, the Baroness Gyllembourg-Ehrens-vård (*q.v.*; 1773-1856), wrote a large number of anonymous novels. Her knowledge of life, her sparkling wit and her almost faultless style, make these short stories masterpieces of their kind.

Christian Hviid Bredahl (1784-1860) produced six volumes of *Dramatic Scenes*² (1819-1833) which, in spite of their many brilliant qualities, were little appreciated at the time. Bredahl gave up literature in despair to become a peasant farmer, and died in poverty.

Ludvig Adolf Bødtker (1793-1874) wrote a single volume of lyrical poems, which he gradually enlarged in succeeding editions. He was a consummate artist in verse, and his impressions are given with the most delicate exactitude of phrase, and in a very fine strain of imagination. He was a quietist and an epicurean, and the closest parallel to Horner in the literature of the North. Most of Bødtker's poems deal with Italian life, which he learned to know thoroughly during a long residence in Rome. He was secretary to Thorwaldsen for a considerable time.

Christian Winther (*q.v.*; 1796-1876) made the island of Zealand his loving study, and that province of Denmark belongs to him no less thoroughly than the Cumberland lakes belong to Wordsworth. Between the latter poet and Winther there was much resemblance. He was, without compeer, the greatest pastoral lyricist of Denmark. His exquisite strains, in which pure imagination is blended with most accurate and realistic descriptions of scenery and rural life, have an extraordinary charm not easily described.

The youngest of the great poets born during the last twenty years of the 18th century was Henrik Hertz (*q.v.*; 1797-1870). As a satirist and comic poet he followed Baggesen, and in all branches of the poetic art stood a little aside out of the main current of romanticism. He introduced into the Danish literature of his time inestimable elements of lucidity and purity. In his best pieces Hertz is the most modern and most cosmopolitan of the Danish writers of his time.

It is noticeable that all the great poets of the romantic period lived to an advanced age. Their prolonged literary activity—for some of them, like Grundtvig, were busy to the last—had a slightly damping influence on their younger contemporaries, but certain names in the next generation have special prominence. Hans Christian Andersen (*q.v.*; 1805-1875) was the greatest of modern fabulists. In 1835 there appeared the first collection of his *Fairy Tales*, and won him a world-wide reputation. Almost every year from this time forward until near his death he published about Christmas time one or two of these unique stories so delicate in their humour and pathos, and so masterly in their simplicity. Carl Christian Bagger (1807-1846) published volumes in 1834 and 1836 which gave promise of a great future,—a promise broken by his early death. Frederik Paludan-Müller (*q.v.*; 1800-1876) developed, as a poet, a magnificent career, which contrasted in its abundance with his solitary and silent life as a man. His mythological or pastoral dramas, his great satiric epos of *Adam Homo* (1841-1848), his comedies, his lyrics, and above all his noble philosophic tragedy of *Kalanus*, prove the immense breadth of his compass, and the inexhaustible riches of his imagination. C. L. Emil Aarestrup (1800-1856) published in 1838 a volume of vivid erotic poetry, but its quality was only appreciated after his death. Edvard Lembocke (1815-1897) made himself famous as the admirable translator of Shakespeare, but the incidents of 1864 produced from him some volumes of direct and manly patriotic verse.

The poets completely ruled the literature of Denmark during this period. There were, however, eminent men in other departments of letters, and especially in philology. Rasmus Christian Rask (1787-1832) was one of the most original and gifted linguists of his age. His grammars of Old Frisian, Icelandic and Anglo-Saxon were unapproached in his own time, and are still admirable. Niels Matthias Petersen (1791-1862), a disciple of Rask, was the author of an admirable *History of Denmark in the Heathen*

² Edited (3 vols., 2nd ed., 1855, Copenhagen) by F. L. Liebenberg.

Antiquity, and the translator of many of the sagas. Martin Frederik Arendt (1773-1823), the botanist and archaeologist, did much for the study of old Scandinavian records. Christian Molbech (1783-1857) was a laborious lexicographer, author of the first good Danish dictionary, published in 1833. In Joachim Frederik Schouw (1789-1852), Denmark produced a very eminent botanist, author of an exhaustive *Geography of Plants*. In later years he threw himself with zeal into politics. His botanical researches were carried on by Frederik Liebmann (1813-1856). The most famous zoologist contemporary with these men was Salomon Dreier (1813-1842).

The romanticists found their philosopher in a most remarkable man, Søren Aaby Kierkegaard (1813-1855), one of the most subtle thinkers of Scandinavia, and the author of some brilliant philosophical and polemical works. A learned philosophical writer, not to be compared, however, for genius or originality to Kierkegaard, was Frederik Christian Sibbern (1785-1872). He wrote a dissertation *On Poetry and Art* (3 vols., 1853-1860) and *The Contents of a MS. from the Year 2135* (3 vols., 1858-1872).

Among novelists who were not also poets was Andreas Nikolai de Saint-Aubain (1798-1865), who, under the pseudonym of Carl Bernhard, wrote a series of charming romances. Mention must also be made of two dramatists, Peter Thun Føersom (1777-1817), who produced an excellent translation of Shakespeare (1807-1816), and Thomas Overskou (1798-1873), author of a long series of successful comedies, and of a history of the Danish theatre (5 vols., Copenhagen, 1854-1864).

Other writers whose names connect the age of romanticism with a later period were Meyer Aron Goldschmidt (1819-1887), author of novels and tales; Herman Frederik Ewald (1821-1908), who wrote a long series of historical novels; Jens Christian Hostrup (1818-1892), a writer of exquisite comedies; and the miscellaneous writer Erik Bøgh (1822-1899). In zoology, J. J. S. Steenstrup (1813-1898); in philology, J. N. Madvig (1804-1886) and his disciple V. Thomsen (b. 1842); in antiquarianism, C. J. Thomsen (1788-1865) and J. J. Asmussen Worsaae (1821-1895); and in philosophy, Rasmus Nielsen (1800-1884) and Hans Brøchner (1820-1875), deserve mention.

The development of imaginative literature in Denmark became very closely defined during the latter half of the 19th century. The romantic movement culminated in several poets of great eminence, whose deaths prepared the way for a new school. In 1874 Bødtker passed away, in 1875 Hans Christian Andersen, in the last week of 1876 Winther, and the greatest of all, Frederik Paludan-Müller. The field was therefore left open to the successors of those idealists, and in 1877 the reaction began to be felt. The eminent critic, Dr Georg Brandes (q.v.), had long foreseen the decline of pure romanticism, and had advocated a more objective and more exact treatment of literary phenomena. Accordingly, as soon as all the great planets had disappeared, a new constellation was perceived to have risen, and all the stars in it had been lighted by the enthusiasm of Brandes. The new writers were what he called Naturalists, and their sympathies were with the latest forms of exotic, but particularly of French literature. Among these fresh forces three immediately took place as leaders—Jacobsen, Drachmann and Schandorph. In J. P. Jacobsen (q.v.: 1847-1885) Denmark was now taught to welcome the greatest artist in prose which she has ever possessed; his romance of *Marie Grubbe* led off the new school with a production of unexampled beauty. But Jacobsen died young, and the work was really carried out by his two companions. Holger Drachmann (q.v.: 1846-1908) began life as a marine painter; and a first little volume of poems, which he published in 1872, attracted slight attention. In 1877 he came forward again with one volume of verse, another of fiction, a third of travel; in each he displayed great vigour and freshness of touch, and he rose at one leap to the highest position among men of promise. Drachmann retained his place, without rival, as the leading imaginative writer in Denmark. For many years he made the aspects of life at sea his particular theme, and he contrived to rouse the patriotic enthusiasm of the Danish public as it had never been roused before. His various and unceasing productiveness, his

freshness and vigour, and the inexhaustible richness of his lyric versatility, early brought Drachmann to the front and kept him there. Meanwhile prose imaginative literature was ably supported by Sophus Schandorph (1836-1901), who had been entirely out of sympathy with the idealists, and had taken no step while that school was in the ascendant. In 1876, in his fortieth year, he was encouraged by the change in taste to publish a volume of realistic stories, *Country Life*, and in 1878 a novel, *Without a Centre*. He has some relation with Guy de Maupassant as a close analyst of modern types of character, but he has more humour. He has been compared with such Dutch painters of low life as Teniers. His talent reached its height in the novel called *Little Folk* (1880), a most admirable study of lower middle-class life in Copenhagen. He was for a while, without doubt, the leading living novelist, and he went on producing works of great force, in which, however, a certain monotony is apparent. The three leaders had meanwhile been joined by certain younger men who took a prominent position. Among these Karl Gjellerup and Erik Skram were the earliest. Gjellerup (b. 1857), whose first works of importance date from 1878, was long uncertain as to the direction of his powers; he was poet, novelist, moralist and biologist in one; at length he settled down into line with the new realistic school, and produced in 1882 a satirical novel of manners which had a great success, *The Disciple of the Teutons*. Erik Skram (b. 1847) had in 1879 written a solitary novel, *Gertrude Coldbjørnsen*, which created a sensation, and was hailed by Brandes as exactly representing the "naturalism" which he desired to see encouraged; but Skram has written little else of importance. Other writers of reputation in the naturalistic school were Edvard Brandes (b. 1847), and Herman Bang (b. 1858). Peter Nansen (b. 1861) has come into wide notoriety as the author, in particularly beautiful Danish, of a series of stories of a pronouncedly sexual type, among which *Maria* (1894) has been the most successful. Meanwhile, several of the elder generation, unaffected by the movement of realism, continued to please the public. Three lyrical poets, H. V. Kaalund (1818-1885), Carl Ploug (1813-1894) and Christian Richardt (1831-1892), of very great talent, were not yet silent, and among the veteran novelists were still active H. F. Ewald and Thomas Lange (1829-1887). Ewald's son Carl (1856-1908) achieved a great name as a novelist, but did his most characteristic work in a series of books for children, in which he used the fairy tale, in the manner of Hans Andersen, as a vehicle for satire and a theory of morals. During the whole of this period the most popular writer of Denmark was J. C. C. Brosbøll (1816-1900), who wrote, under the pseudonym Carit Etlar, a vast number of tales. Another popular novelist was Vilhelm Bergsøe (b. 1835), author of *In the Sabine Mountains* (1871), and other romances. Sophus Bauditz (b. 1850) persevered in composing novels which attain a wide general popularity. Mention must be made also of the dramatist Christian Molbech (1821-1888).

Between 1885 and 1892 there was a transitional period in Danish literature. Up to that time all the leaders had been united in accepting the naturalistic formula, which was combined with an individualist and a radical tendency. In 1885, however, Drachmann, already the recognized first poet of the country, threw off his allegiance to Brandes, denounced the exotic tradition, declared himself a Conservative, and took up a national and patriotic attitude. He was joined a little later by Gjellerup, while Schandorph remained stanchly by the side of Brandes. The camp was thus divided. New writers began to make their appearance, and, while some of these were stanch to Brandes, others were inclined to hold rather with Drachmann. Of the authors who came forward during this period of transition, the strongest novelist proved to be Hendrik Pontoppidan (b. 1857). In some of his books he reminds the reader of Turgeniev. Pontoppidan published in 1898 the first volume of a great novel entitled *Lykke-Per*, the biography of a typical Jutlander named Per Sidenius, a work to be completed in eight volumes. From 1893 to 1909 no great features of a fresh kind revealed themselves. The Danish public, grown tired of realism, and satiated with pathological phenomena, returned to a fresh study of their own national

characteristics. The cultivation of verse, which was greatly discouraged in the eighties, returned. Drachmann was supported by excellent younger poets of his school. J. J. Jørgensen (b. 1866), a Catholic decadent, was very prolific. Otto C. Fønss (b. 1853) published seven little volumes of graceful lyrical poems in praise of gardens and of farm-life. Andreas Døllers (b. 1850), of Vejle, showed himself an occasional poet of merit. Alfred Ipsen (b. 1852) must also be mentioned as a poet and critic. Valdemar Rørdam, whose *The Danish Tongue* was the lyrical success of 1901, may also be named. Some attempts were made to transplant the theories of the symbolists to Denmark, but without signal success. On the other hand, something of a revival of naturalism is to be observed in the powerful studies of low life admirably written by Karl Larsen (b. 1860).

The drama has long flourished in Denmark. The principal theatres are liberally open to fresh dramatic talent of every kind, and the great fondness of the Danes for this form of entertainment gives unusual scope for experiments in halls or private theatres; nothing is too eccentric to hope to obtain somewhere a fair hearing. Drachmann produced with very great success several romantic dramas founded on the national legends. Most of the novelists and poets already mentioned also essayed the stage, and to those names should be added these of Einar Christiansen (b. 1861), Ernst von der Recke (b. 1848), Oskar Benzon (b. 1856) and Gustav Wied (b. 1858).

In theology no names were as eminent as in the preceding generation, in which such writers as H. N. Clausen (1793-1877), and still more Hans Lassen Martensen (1808-1884), lifted the prestige of Danish divinity to a high point. But in history the Danes have been very active. Karl Ferdinand Allen (1811-1871) began a comprehensive history of the Scandinavian kingdoms (5 vols., 1864-1872). Jens Peter Trap (1810-1885) concluded his great statistical account of Denmark in 1879. The 16th century was made the subject of the investigations of Trøels Lund (q.v.). About 1880 several of the younger historians formed the plan of combining to investigate and publish the sources of Danish history; in this the indefatigable Johannes Steenstrup (b. 1844) was prominent. The domestic history of the country began, about 1885, to occupy the attention of Edvard Holm (b. 1833), O. Nielsen and the veteran P. Frederik Barfod (1811-1896). The naval histories of G. Lütken attracted much notice. Besides the names already mentioned, A. D. Jørgensen (1840-1897), J. Fredericia (b. 1849), Christian Erslev (b. 1852) and Vilhelm Møllerup have all distinguished themselves in the excellent school of Danish historians. In 1896 an elaborate composite history of Denmark was undertaken by some leading historians (pub. 1897-1905). In philosophy nothing has recently been published of the highest value. Martensen's *Jakob Böhme* (1881) belongs to an earlier period. H. Höfding (b. 1843) has been the most prominent contributor to psychology. His *Problems of Philosophy* and his *Philosophy of Religion* were translated into English in 1906. Alfred Lehmann (b. 1858) has, since 1896, attracted a great deal of attention by his sceptical investigation of psychical phenomena. F. Rønning has written on the history of thought in Denmark. In the criticism of art, Julius Lange (1838-1896), and later Karl Madsen, have done excellent service. In literary criticism Dr Georg Brandes is notable for the long period during which he remained predominant. His was a steady and stimulating presence, ever pointing to the best in art and thought, and his influence on his age was greater than that of any other Dane.

AUTHORITIES.—R. Nyerup, *Den danske Digtekunsts Historie* (1800-1808), and *Almindeligt Literaturlexikon* (1818-1820); N. M. Petersen, *Literaturhistorie* (2nd ed., 1867-1871, 5 vols.); *Overskou, Den danske Skueplads* (1854-1866, 5 vols.), and with continuation (2 vols., 1873-1876) by E. Collin; Chr. Bruun, *Bibliotheca Danica* (3 vols., 1872-1896); Bricka, *Dansk biografisk Lexikon* (1887-1901); J. Paludan, *Danmarks Literatur i Middelalderen* (Copenhagen, 1896); P. Hansen, *Illustreret Dansk Literaturhistorie* (3 vols., 1901-1902); F. W. Horn, *History of the Scandinavian North from the most ancient times to the present* (English translation by Rasmus B. Anderson (Chicago, 1884), with biographical appendix by Thorwald Solberg); Ph. Schweizer, *Geschichte der Skandinavischen Literatur* (3 pts., Leipzig, 1886-1889), forming vol. viii. of the *Geschichte der Welt-*

literatur. See also Brandes, *Kritiker og Portraiter* (1870); Brandes, *Danske Digere* (1877); Marie Herzfeld, *Die Skandinavische Literatur und ihre Tendenz* (Berlin and Leipzig, 1898); Hjalmar Hjorth Boyesen, *Essays on Scandinavian Literature* (London, 1895); Edmund Gosse, *Studies in the Literature of Northern Europe* (new ed., London, 1883); Vilhelm Andersen, *Litteraturlibeller* (Copenhagen, 1903); A. P. J. Scherer, *Kortfattet Indledning til Romantikkens Periode i Danmarks Litteratur* (Copenhagen, 1894). (E. G.)

DENNERY, or **D'ENNERY**, **ADOLPHE** (1811-1899), French dramatist and novelist, whose real surname was PHILIPPE, was born in Paris on the 17th of June 1811. He obtained his first success in collaboration with Charles Desnoyer in *Émile, ou le fils d'un pair de France* (1831), a drama which was the first of a series of some two hundred pieces written alone or in collaboration with other dramatists. Among the best of them may be mentioned *Gaspard Hauser* (1838) with Anicet Bourgeois; *Les Bohémiens de Paris* (1842) with Eugène Grange; with Mallian, *Marie-Jeanne, ou la femme du peuple* (1845), in which Madame Dorval obtained a great success; *La Case d'Oncle Tom* (1853); *Les Deux Orphelines* (1875), perhaps his best piece, with Eugène Cormon. He wrote the libretto for Gounod's *Tribut de Zamora* (1881); with Louis Gallet and Édouard Blau he composed the book of Massenet's *Cid* (1885); and, again in collaboration with Eugène Cormon, the books of Auber's operas, *Le Premier Jour de bonheur* (1868) and *Rêve d'amour* (1866). He prepared for the stage Balzac's posthumous comedy *Mercadet ou le faiseur*, presented at the Gymnase theatre in 1851. Reversing the usual order of procedure, Dennery adapted some of his plays to the form of novels. He died in Paris in 1899.

DENNEWITZ, a village of Germany, in the Prussian province of Brandenburg, near Jüterbog, 40 m. S.W. from Berlin. It is memorable as the scene of a decisive battle on the 6th of September 1813, in which Marshal Ney, with an army of 58,000 French, Saxons and Poles, was defeated with great loss by 50,000 Prussians under Generals Bülow (afterwards Count Bülow of Dennewitz) and Taubentzien. The site of the battle is marked by an iron obelisk.

DENNIS, **JOHN** (1657-1734), English critic and dramatist, the son of a saddler, was born in London in 1657. He was educated at Harrow School and Caius College, Cambridge, where he took his B.A. degree in 1679. In the next year he was fined and dismissed from his college for having wounded a fellow-student with a sword. He was, however, received at Trinity Hall, where he took his M.A. degree in 1683. After travelling in France and Italy, he settled in London, where he became acquainted with Dryden, Wycherley and others; and being made temporarily independent by inheriting a small fortune, he devoted himself to literature. The duke of Marlborough procured him a place as one of the queen's waiters in the customs with a salary of £120 a year. This he afterwards disposed of for a small sum, retaining, at the suggestion of Lord Halifax, a yearly charge upon it for a long term of years. Neither the poems nor the plays of Dennis are of any account, although one of his tragedies, a violent attack on the French in harmony with popular prejudice, entitled *Liberty Asserted*, was produced with great success at Lincoln's Inn Fields in 1704. His sense of his own importance approached mania, and he is said to have desired the duke of Marlborough to have a special clause inserted in the treaty of Utrecht to secure him from French vengeance. Marlborough pointed out that although he had been a still greater enemy of the French nation, he had no fear for his own security. This tale and others of a similar nature may well be exaggerations prompted by his enemies, but the infirmities of character and temper indicated in them were real. Dennis is best remembered as a critic, and Isaac D'Israeli, who took a by no means favourable view of Dennis, said that some of his criticisms attain classical rank. The earlier ones, which have nothing of the rancour that afterwards gained him the nickname of "Furious," are the best. They are *Remarks . . .* (1696), on Blackmore's epic of Prince Arthur; *Letters upon Several Occasions written by and between Mr Dryden, Mr Wycherley, Mr Moyle, Mr Congreve and Mr Dennis, published by Mr Dennis* (1696); two pamphlets in reply to Jeremy Collier's *Short View; The Advancement and Reformation of*

Modern Poetry (1701), perhaps his most important work; *The Grounds of Criticism in Poetry* (1704), in which he argued that the ancients owed their superiority over the moderns in poetry to their religious attitude; an *Essay upon Publick Spirit* . . . (1711), in which he inveighs against luxury, and servile imitation of foreign fashions and customs; and *Essay on the Genius and Writings of Shakespeare in three Letters* (1712).

Dennis had been offended by a humorous quotation made from his works by Addison, and published in 1713 *Remarks upon Cato*. Much of this criticism was acute and sensible, and it is quoted at considerable length by Johnson in his *Life of Addison*, but there is no doubt that Dennis was actuated by personal jealousy of Addison's success. Pope replied in *The Narrative of Dr Robert Norris, concerning the strange and deplorable frenzy of John Dennis* . . . (1713). This pamphlet was full of personal abuse, exposing Dennis's foibles, but offering no defence of *Cato*. Addison repudiated any connivance in this attack, and indirectly notified Dennis that when he did answer his objections, it would be without personalities. Pope had already assailed Dennis in 1711 in the *Essay on Criticism*, as Appius. Dennis retorted by *Reflections, Critical and Satirical* . . . , a scurrilous production in which he taunted Pope with his deformity, saying among other things that he was "as stupid and as venomous as a hunch-backed toad." He also wrote in 1717 *Remarks upon Mr Pope's Translation of Homer* . . . and *A True Character of Mr Pope*. He accordingly figures in the *Dunciad*, and in a scathing note in the edition of 1729 (bk. i. s. 106) Pope quotes his more outrageous attacks, and adds an insulting epigram attributed to Richard Savage, but now generally ascribed to Pope. More pamphlets followed, but Dennis's day was over. He outlived his annuity from the customs, and his last years were spent in great poverty. Bishop Atterbury sent him money, and he received a small sum annually from Sir Robert Walpole. A benefit performance was organized at the Haymarket (December 18, 1733) on his behalf. Pope wrote for the occasion an ill-natured prologue which Cibber recited. Dennis died within three weeks of this performance, on the 6th of January 1734.

His other works include several plays, for one of which, *Appius and Virginia* (1709), he invented a new kind of thunder. He wrote a curious *Essay on the Operas after the Italian Manner* (1706), maintaining that opera was the outgrowth of effeminate manners, and should, as such, be suppressed. His works were published in 1702, *Select Works* . . . (2 vols.) in 1718, and *Miscellaneous Tracts*, the first volume only of which appeared, in 1727. For accounts of Dennis see Cibber's *Lives of the Poets*, vol. iv.; Isaac D'Israeli's essays on Pope and Addison in the *Quarrels of Authors*, and "On the Influence of a Bad Temper in Criticism" in *Calamities of Authors*; and numerous references in Pope's *Works*.

DENOMINATE (Lat. *denominare*, to give a specific name to), the giving of a specific name to anything, hence the name or designation of a person or thing, and more particularly of a class of persons or things; thus, in arithmetic, it is applied to a unit in a system of weights and measures, currency or numbers. The most general use of "denomination" is for a body of persons holding specific opinions and having a common name, especially with reference to the religious opinions of such a body. More particularly the word is used of the various "sects" into which members of a common religious faith may be divided. The term "denominationalism" is thus given to the principle of emphasizing the distinctions, rather than the common ground, in the faith held by different bodies professing one sort of religious belief. This use is particularly applied to that system of religious education which lays stress on the principle that children belonging to a particular religious sect should be publicly taught in the tenets of their belief by members belonging to it and under the general control of the ministers of the denomination.

DENON, DOMINIQUE VIVANT, BARON DE (1747-1825), French artist and archaeologist, was born at Chalon-sur-Saône on the 4th of January 1747. He was sent to Paris to study law, but he showed a decided preference for art and literature, and soon gave up his profession. In his twenty-third year he produced a comedy, *Le Bon Père*, which obtained a *succès d'estime*, as he had already won a position in society by his agreeable manners and exceptional conversational powers. He became a favourite

of Louis XV., who entrusted him with the collection and arrangement of a cabinet of medals and antique gems for Madame de Pompadour, and subsequently appointed him attaché to the French embassy at St Petersburg. On the accession of Louis XVI. Denon was transferred to Sweden; but he returned, after a brief interval, to Paris with the ambassador M. de Vergennes, who had been appointed foreign minister. In 1775 Denon was sent on a special mission to Switzerland, and took the opportunity of visiting Voltaire at Ferney. He made a portrait of the philosopher, which was engraved and published on his return to Paris. His next diplomatic appointment was to Naples, where he spent seven years, first as secretary to the embassy and afterwards as *chargé d'affaires*. He devoted this period to a careful study of the monuments of ancient art, collecting many specimens and making drawings of others. He also perfected himself in etching and mezzotint engraving. The death of his patron, M. de Vergennes, in 1787, led to his recall, and the rest of his life was given mainly to artistic pursuits. On his return to Paris he was admitted a member of the Academy of Painting. After a brief interval he returned to Italy, living chiefly at Venice. He also visited Florence and Bologna, and afterwards went to Switzerland. While there he heard that his property had been confiscated, and his name placed on the list of the proscribed, and with characteristic courage he resolved at once to return to Paris. His situation was critical, but he was spared, thanks to the friendship of the painter David, who obtained for him a commission to furnish designs for republican costumes. When the Revolution was over, Denon was one of the band of eminent men who frequented the house of Madame de Beauharnais. Here he met Bonaparte, to whose fortunes he wisely attached himself. At Bonaparte's invitation he joined the expedition to Egypt, and thus found the opportunity of gathering the materials for his most important literary and artistic work. He accompanied General Desaix to Upper Egypt, and made numerous sketches of the monuments of ancient art, sometimes under the very fire of the enemy. The results were published in his *Voyage dans la basse et la haute Égypte* (2 vols. fol., with 141 plates, Paris, 1802), a work which crowned his reputation both as an archaeologist and as an artist. In 1804 he was appointed by Napoleon to the important office of director-general of museums, which he filled until the restoration in 1815, when he had to retire. He was a devoted friend of Napoleon, whom he accompanied in his expeditions to Austria, Spain and Poland, taking sketches with his wonted fearlessness on the various battlefields, and advising the conqueror in his choice of spoils of art from the various cities pillaged. After his retirement he began an illustrated history of ancient and modern art, in which he had the co-operation of several skilful engravers. He died at Paris on the 27th of April 1825, leaving the work unfinished. It was published posthumously, with an explanatory text by Amaury Duval, under the title *Monuments des arts du dessin chez les peuples tant anciens que modernes, recueillis par Vivant Denon* (4 vols. fol., Paris, 1829). Denon was the author of a novel, *Point de lendemain* (1777), of which further editions were printed in 1812, 1876 and 1879.

See J. Renouvier, *Histoire de l'art pendant la Révolution*; A. de la Fizelière, *L'Œuvre originale de Vivant Denon* (2 vols., Paris, 1872-1873); Roger Portallias, *Les Dessinateurs d'illustrations au XVIII^e siècle*; D. H. Beraldi, *Les Graveurs d'illustrations au XVIII^e siècle*.

DENOTATION (from Lat. *denotare*, to mark out, specify), in logic, a technical term used strictly as the correlative of Connotation, to describe one of the two functions of a concrete term. The concrete term "connotes" attributes and "denotes" all the individuals which, as possessing these attributes, constitute the genus or species described by the term. Thus "cricketer" denotes the individuals who play cricket, and connotes the qualities or characteristics by which these individuals are marked. In this sense, in which it was first used by J. S. Mill, Denotation is equivalent to Extension, and Connotation to Intension. It is clear that when the given term is qualified by a limiting adjective the Denotation or Extension diminishes, while the Connotation or Intension increases; e.g. a generic term like "flower" has a larger Extension, and a smaller Intension than "rose"; "rose" 14

than "moss-rose." In more general language Denotation is used loosely for that which is meant or indicated by a word, phrase, sentence or even an action. Thus a proper name or even an abstract term is said to have Denotation. (See CONNOTATION.)

DENS, PETER (1690-1775), Belgian Roman Catholic theologian, was born at Boom near Antwerp. Most of his life was spent in the archiepiscopal college of Malines, where he was for twelve years reader in theology and for forty president. His great work was the *Theologia moralis et dogmatica*, a compendium in catechetical form of Roman Catholic doctrine and ethics which has been much used as a students' text-book. Dens died on the 15th of February 1775.

DENSITY (Lat. *densus*, thick), in physics, the mass or quantity of matter contained in unit volume of any substance: this is the *absolute density*; the term *relative density* or *specific gravity* denotes the ratio of the mass of a certain volume of a substance to the mass of the same volume of some standard substance. Since the weights used in conjunction with a balance are really standard masses, the word "weight" may be substituted for the word "mass" in the preceding definitions; and we may symbolically express the relations thus:—If M be the weight of substance occupying a volume V , then the absolute density $\Delta = M/V$; and if m, m_1 be the weights of the substance and of the standard substance which occupy the same volume, the relative density or specific gravity $S = m/m_1$; or more generally if m_1 be the weight of a volume v of the substance, and m_2 the weight of a volume v_1 of the standard, then $S = m_2/m_1 \cdot v_1/v$. In the numerical expression of absolute densities it is necessary to specify the units of mass and volume employed; while in the case of relative densities, it is only necessary to specify the standard substance, since the result is a mere number. Absolute densities are generally stated in the C.G.S. system, i.e. as grammes per cubic centimetre. In commerce, however, other expressions are met with, as, for example, "pounds per cubic foot" (used for woods, metals, &c.), "pounds per gallon," &c. The standard substances employed to determine relative densities are: water for liquids and solids, and hydrogen or atmospheric air for gases; oxygen (as 16) is sometimes used in this last case. Other standards of reference may be used in special connexions; for example, the Earth is the usual unit for expressing the relative density of the other members of the solar system. Reference should be made to the article GRAVITATION for an account of the methods employed to determine the "mean density of the earth."

In expressing the absolute or relative density of any substance, it is necessary to specify the conditions for which the relation holds: in the case of gases, the temperature and pressure of the experimental gas (and of the standard, in the case of relative density); and in the case of solids and liquids, the temperature. The reason for this is readily seen; if a mass M of any gas occupies a volume V at a temperature T (on the absolute scale) and a pressure P , then its absolute density under these conditions is $\Delta = M/V$; if now the temperature and pressure be changed to T_1 and P_1 , the volume V_1 under these conditions is VPT/P_1T_1 , and the absolute density is MP_1T/VPT_1 . It is customary to reduce gases to the so-called "normal temperature and pressure," abbreviated to N.T.P., which is 0°C . and 760 mm.

The relative densities of gases are usually expressed in terms of the standard gas under the same conditions. The density gives very important information as to the molecular weight, since by the law of Avogadro it is seen that the relative density is the ratio of the molecular weights of the experimental and standard gases. In the case of liquids and solids, comparison with water at 4°C ., the temperature of the maximum density of water; at 0°C ., the zero of the Centigrade scale and the freezing-point of water; at 15° and 18° , ordinary room-temperatures; and at 25° , the temperature at which a thermostat may be conveniently maintained, are common in laboratory practice. The temperature of the experimental substance may or may not be the temperature of the standard. In such cases a bracketed fraction is appended to the specific gravity, of which the numerator and denominator are respectively the temperatures of the

substance and of the standard; thus $1.093 (0^\circ/4^\circ)$ means that the ratio of the weight of a definite volume of a substance at 0° to the weight of the same volume of water at 4° is 1.093. It may be noted that if comparison be made with water at 4° , the relative density is the same as the absolute density, since the unit of mass in the C.G.S. system is the weight of a cubic centimetre of water at this temperature. In British units, especially in connexion with the statement of relative densities of alcoholic liquors for Inland Revenue purposes, comparison is made with water at 62°F . (16.6C .); a reason for this is that the gallon of water is defined by statute as weighing 10 lb at 62°F ., and hence the densities so expressed admit of the ready conversion of volumes to weights. Thus if d be the relative density, then 10d represents the weight of a gallon in lb. The brewer has gone a step further in simplifying his expressions by multiplying the density by 100, and speaking of the difference between the density so expressed and 1000 as "degrees of gravity" (see BEER).

Practical Determination of Densities

The methods for determining densities may be divided into two groups according as hydrostatic principles are employed or not. In the group where the principles of hydrostatics are not employed the method consists in determining the weight and volume of a certain quantity of the substance, or the weights of equal volumes of the substance and of the standard. In the case of solids we may determine the volume in some cases by direct measurement—this gives at the best a very rough and ready value; a better method is to immerse the body in a fluid (in which it must sink and be insoluble) contained in a graduated glass, and to deduce its volume from the height to which the liquid rises. The weight may be directly determined by the balance. The ratio "weight to volume" is the absolute density. The separate determination of the volume and mass of such substances as gunpowder, cotton-wool, soluble substances, &c., supplies the only means of determining their densities. The stereometer of Say, which was greatly improved by Regnault and further modified by Kopp, permits an accurate determination of the volume of a given mass of any such substance. In its simplest form the instrument consists of a glass tube PC (fig. 1), of uniform bore, terminating in a cup PE, the mouth of which can be rendered airtight by the plate of glass E. The substance whose volume is to be determined is placed in the cup PE, and the tube PC is immersed in the vessel of mercury D until the mercury reaches the mark P. The plate E is then placed on the cup, and the tube PC raised until the surface of the mercury in the tube stands at M, that in the vessel D being at C, and the height MC is measured. Let h denote this height, and let PM be denoted by l . Let u represent the volume of air in the cup before the body was inserted, v the volume of the body, a the area of the horizontal section of the tube PC, and h the height of the mercurial barometer. Then, by Boyle's law

$(u-v+al)(h-k) = (u-v)h$, and therefore $v = u - al(h-k)/h$. The volume u may be determined by repeating the experiment when only air is in the cup. In this case $v=0$, and the equation becomes $(u+al)(h-k) = uh$, whence $u = al(h-k)^2/h^2$. Substituting this value in the expression for v , the volume of the body inserted in the cup becomes known. The chief errors to which the stereometer is liable are (1) variation of temperature and atmospheric pressure during the experiment, and (2) the presence of moisture which disturbs Boyle's law.

The method of weighing equal volumes is particularly applicable to the determination of the relative densities of liquids. It consists in weighing a glass vessel (1) empty, (2) filled with the liquid, (3) filled with the standard substance. Calling the weight of the empty vessel w , when filled with the liquid W , and when filled with the standard substance W_1 , it is obvious that $W-w$, and W_1-w , are the weights of equal volumes of the liquid and standard, and hence the relative density is $(W-w)/(W_1-w)$.

Many forms of vessels have been devised. The common type of "specific gravity bottle" consists of a thin glass bottle (fig. 2) of a capacity varying from 10 to 100 cc., fitted with an accurately ground stopper, which is vertically perforated by a fine hole. The bottle is carefully cleansed by washing with soda, hydrochloric acid and distilled water, and then dried by heating in an air bath or by blowing in warm air. It is allowed to cool and then weighed. The bottle is then filled with distilled water, and brought to a definite temperature by immersion in a thermostat, and the stopper inserted. It is removed from the thermostat, and carefully



FIG. 1.—Say's mercurial barometer.



FIG. 2.

wiped. After cooling it is weighed. The bottle is again cleaned and dried, and the operations repeated with the liquid under examination instead of water. Numerous modifications of this bottle are in use. For volatile liquids, a flask provided with a long neck which carries a graduation and is fitted with a well-ground stopper is recommended. The bringing of the liquid to the mark is effected by removing the excess by means of a capillary. In many forms a thermometer forms part of the apparatus.

Another type of vessel, named the Sprengel tube or pycnometer (Gr. *σπρῆν*, dense), is shown in fig. 3. It consists of a cylindrical tube of a capacity ranging from 10 to 30 cc., provided at the upper end with a thick-walled capillary bent as shown on the left of the figure.

From the bottom there leads another fine tube, bent upwards, and then at right angles so as to be at the same level as the capillary branch. This tube bears a graduation. A loop of platinum wire passed under these tubes serves to suspend the vessel from the balance arm. The manner of cleansing, &c., is the same as in the ordinary form. The vessel is filled by placing the capillary in a vessel containing the liquid and gently aspirating. Care must be taken that no air bubbles are enclosed. The liquid is adjusted to the mark by withdrawing any excess from the capillary end by a strip of bibulous paper or by a capillary tube. Many variations of this apparatus are in use; in one of the commonest there are two cylindrical chambers, joined at the bottom, and each provided at the top with fine tubes bent at right angles; sometimes the inlet and outlet tubes are provided with caps.

The specific gravity bottle may be used to determine the relative density of a solid which is available in small fragments, and is insoluble in the standard liquid. The method involves three operations:—(1) weighing the solid in air (W), (2) weighing the specific gravity bottle full of liquid (W_1), (3) weighing the bottle containing the solid and filled up with liquid (W_2). It is readily seen that $W+W_1-W_2$ is the weight of the liquid displaced by the solid, and therefore is the weight of an equal volume of liquid; hence the relative density is $W/(W+W_1-W_2)$.

The determination of the absolute densities of gases can only be effected with any high degree of accuracy by a development of this method. As originated by Regnault, it consisted in filling a large glass globe with the gas by alternately exhausting with an air-pump and admitting the pure and dry gas. The flask was then brought to 0° by immersion in melting ice, the pressure of the gas taken, and the stop-cock closed. The flask is removed from the ice, allowed to attain the temperature of the room, and then weighed. The flask is now partially exhausted, transferred to the cooling bath, and after standing the pressure of the residual gas is taken by a manometer. The flask is again brought to room-temperature, and re-weighed. The difference in the weights corresponds to the volume of gas at a pressure equal to the difference of the recorded pressures. The volume of the flask is determined by weighing empty and filled with water. This method has been refined by many experimenters among whom we may notice Morley and Lord Rayleigh. Morley determined the densities of hydrogen and oxygen in the course of his classical investigation of the composition of water. The method differed from Regnault's inasmuch as the flask was exhausted to an almost complete vacuum, a performance rendered possible by the high efficiency of the modern air-pump. The actual experiment necessitates the most elaborate precautions, for which reference must be made to Morley's original papers in the *Smithsonian Contributions to Knowledge* (1895), or to M. Travers, *The Study of Gases*. Lord Rayleigh has made many investigations of the absolute densities of gases, one of which, namely on atmospheric and artificial nitrogen, undertaken in conjunction with Sir William Ramsay, culminated in the discovery of argon (g.2.). He pointed out in 1888 (*Proc. Roy. Soc.* 43, p. 361) an important correction which had been overlooked by previous experimenters with Regnault's method, viz. the change in volume of the experimental globe due to shrinkage under diminished pressure; this may be experimentally determined and amounts to between 0.04 and 0.16 % of the volume of the globe.

Related to the determination of the density of a gas is the determination of the density of a vapour, i.e. matter which at ordinary temperatures exists as a solid or liquid. This subject owes its importance in modern chemistry to the fact that the vapour density, when hydrogen is taken as the standard, gives perfectly definite information as to the molecular condition of the compound, since twice the vapour density equals the molecular weight of the compound. Many methods have been devised. In historical order we may briefly enumerate the following:—in 1811, Gay-Lussac vaporized a weighed quantity of liquid, which must be readily volatile, by letting it rise up a short tube containing mercury and standing inverted in a vessel holding the same metal. This method was developed by Hofmann in 1868, who replaced the short tube of Gay-Lussac by an ordinary barometer tube, thus effecting the volatilization in a Torricellian vacuum. In 1826 Dumas devised a method suitable for substances of high boiling-point; this consisted

in its essential point in vaporizing the substance in a flask made of suitable material, sealing it when full of vapour, and weighing. This method is very tedious in detail. H. Sainte-Claire Deville and L. Troost made it available for specially high temperatures by employing porcelain vessels, sealing them with the oxyhydrogen blow-pipe, and maintaining a constant temperature by a vapour bath of mercury (350°), sulphur (440°), cadmium (860°) and zinc (1040°). In 1878 Victor Meyer devised his air-expulsion method.

Before discussing the methods now used in detail, a summary of the conclusions reached by Victor Meyer in his classical investigations in this field as to the applicability of the different methods will be given:

- (1) For substances which do not boil higher than 260° and have vapours stable for 30° above the boiling-point and which do not react on mercury, use Victor Meyer's "mercury-expulsion method."
- (2) For substances boiling between 260° and 420°, and which do not react on metals, use Meyer's "Wood's alloy expulsion method."
- (3) For substances boiling at higher temperatures, or for any substance which reacts on mercury, Meyer's "air-expulsion method" must be used. It is to be noted, however, that this method is applicable to substances of any boiling-point (see below).
- (4) For substances which can be vaporized only under diminished pressure, several methods may be used. (a) Hofmann's is the best if the substance volatilizes at below 310°, and does not react on mercury; otherwise (b) Demuth and Meyer's, Eykman's, Schall's, or other methods may be used.

1. *Meyer's "Mercury Expulsion" Method*.—A small quantity of the substance is weighed into a tube, of the form shown in fig. 4, which has a capacity of about 35 cc., provided with a capillary tube at the top, and a bent tube about 6 mm. in diameter at the bottom. The vessel is completely filled with mercury, the capillary sealed, and the vessel weighed. The vessel is then lowered into a jacket containing vapour at a known temperature which is sufficient to volatilize the substance. Mercury is expelled, and when this expulsion ceases, the vessel is removed, allowed to cool, and weighed. It is necessary to determine the pressure exerted on the vapour by the mercury in the narrow limb; this is effected by opening the capillary and inclining the tube until the mercury just reaches the top of the narrow tube; the difference between the height of the mercury in the wide tube and the top of the narrow tube represents the pressure due to the mercury column, and this must be added to the barometric pressure in order to deduce the total pressure on the vapour.

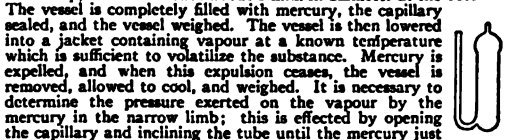

The result is calculated by means of the formula:

$$D = \frac{W}{(t+a)} \times 7.980,000$$

$$D = \frac{(\rho + \rho_1 - \rho_2) [m_1 + \beta(l-h)] - m_2 [t + \gamma(l-h)]}{(1 + \gamma t)}$$

in which W = weight of substance taken; t = temperature of vapour bath; a = 0.00366 = temperature coefficient of gases; ρ = barometric pressure; ρ_1 = height of mercury column in vessel; ρ_2 = vapour tension of mercury at t ; m = weight of mercury contained in the vessel; m_1 = weight of mercury left in vessel after heating; β = coefficient of expansion of glass = 0.000035; γ = coefficient of expansion of mercury = 0.00018 (0.00019 above 240°) (see Ber. 1877, 10, p. 2068; 1886, 19, p. 1862).

2. *Meyer's Wood's Alloy Expulsion Method*.—This method is a modification of the one just described. The alloy used is composed of 15 parts of bismuth, 8 of lead, 4 of tin and 3 of cadmium; it melts at 70°, and can be experimented with as readily as mercury. The cylindrical vessel is replaced by a globular one, and the pressure on the vapour due to the column of alloy in the side tube is readily reduced to millimetres of mercury since the specific gravity of the alloy at the temperature of boiling sulphur, 444° (at which the apparatus is most frequently used), is two-thirds of that of mercury (see Ber. 1876, p. 1220).

3. *Meyer's Air Expulsion Method*.—The simplicity, moderate accuracy, and adaptability of this method to every class of substance which can be vaporized entitles it to rank as one of the most potent methods in analytical chemistry; its invention is indissolubly connected with the name of Victor Meyer, being termed "Meyer's method" to the exclusion of his other original methods. It consists in determining the air expelled from a vessel by the vapour of a given quantity of the substance. The apparatus is shown in fig. 5. A long tube (a) terminates at the bottom in a cylindrical chamber of about 100-150 cc. capacity. The top is fitted with a rubber stopper, or in some forms with a stop-cock, while a little way down there is a bent delivery tube (b). To use the apparatus, the long tube is placed in a vapour bath (c) of the requisite temperature, and after the air within the tube is in equilibrium, the delivery tube is placed beneath the surface of the water in a pneumatic trough, the rubber stopper pushed home, and observation made as to whether any more air is being expelled. If this be not so, a graduated tube (d) is filled with water, and inverted over the delivery tube. The rubber stopper is removed and the experimental substance introduced, and the stopper quickly replaced to the same extent as before. Bubbles are quickly disengaged and collect in the

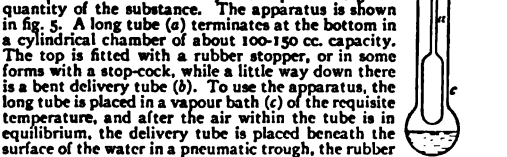

Fig. 5.

graduated tube. Solids may be directly admitted to the tube from a weighing bottle, while liquids are conveniently introduced by means of small stoppered bottles, or, in the case of exceptionally volatile liquids, by means of a bulb blown on a piece of thin capillary tube, the tube being sealed during the weighing operation, and the capillary broken just before transference to the apparatus. To prevent the bottom of the apparatus being knocked out by the impact of the substance, a layer of sand, asbestos or sometimes mercury is placed in the tube. To complete the experiment, the graduated tube containing the expelled air is brought to a constant and determinate temperature and pressure, and this volume is the volume which the given weight of the substance would occupy if it were a gas under the same temperature and pressure. The vapour density is calculated by the following formula:

$$D = \frac{W(1+\alpha) \times 871.780}{(p-v)V}$$

in which W = weight of substance taken, V = volume of air expelled, $\alpha = 1/273 = .003665$, t and p = temperature and pressure at which expelled air is measured, and v = vapour pressure of water at t° .

By varying the material of the bulb, this apparatus is rendered available for exceptionally high temperatures. Vapour baths of iron are used in connexion with boiling anthracene (335°), anthraquinone (368°), sulphur (444°), phosphorus pentasulphide (518°); molten lead may also be used. For higher temperatures the bulb of the vapour density tube is made of porcelain or platinum, and is heated in a gas furnace.

(4a) *Hofmann's Method*.—Both the *modus operandi* and apparatus employed in this method particularly recommend its use for substances which do not react on mercury and which boil in a vacuum at below 310° . The apparatus (fig. 6) consists of a barometer tube, containing mercury and standing in a bath of the same metal, surrounded by a vapour jacket. The vapour is circulated through the jacket, and the height of the mercury read by a cathetometer or otherwise. The substance is weighed into a small stoppered bottle, which is then placed beneath the mouth of the barometer tube.

It ascends the tube, the substance is rapidly volatilized, and the mercury column is depressed; this depression is read off. It is necessary to know the volume of the tube above the second level; this may most efficiently be determined by calibrating the tube prior to its use.

Sir T. E. Thorpe employed a barometer tube 96 cm. long, and determined the volume from the closed end for a distance of about 35 mm. by weighing in mercury; below this mark it was calibrated in the ordinary way so that a scale reading gave the volume at once. The calculation is effected by the following formulae:—

$$D = \frac{760w(1+0.001665t)}{0.0012934 \times V \times B};$$

$$B = \frac{h}{1+0.00018t_1} - \left(\frac{1+0.00018t_2}{1+0.00018t_1} + t_3 \right),$$

in which w = weight of substance taken, t = temperature of vapour jacket; V = volume of vapour at t ; h = height of barometer reduced to 0° ; t_1 = temperature of air; t_2 = height of mercury column below vapour jacket; t_3 = height of temperature of mercury column not heated by vapour; t_4 = height of mercury column within vapour jacket; t_5 = vapour tension of mercury at t° . The vapour tension of mercury need not be taken into account when water is used in the jacket.

(4b) *Demush and Meyer's Method*.—The principle of this method is as follows:—In the ordinary air expulsion method, the vapour always mixes to some extent with the air in the tube, and this involves a reduction of the pressure of the vapour. It is obvious that this reduction may be increased by accelerating the diffusion of the vapour. This may be accomplished by using a vessel with a somewhat wide bottom, and inserting the substance so that it may be volatilized very rapidly, as, for example, in tubes of Wood's alloy, and by filling the tube with hydrogen. (For further details see *Ber.* 23, p. 311.)

We may here notice a modification of Meyer's process in which the increase of pressure due to the volatilization of the substance, and not the volume of the expelled air, is measured. This method has been developed by J. S. Lumsden (*Journ. Chem. Soc.* 1903, 83, p. 342), whose apparatus is shown diagrammatically in fig. 7. The vaporizing bulb A has fused about it a jacket B, provided with a condenser c . Two side tubes are fused on to the neck of A: the lower one leads to a mercury manometer M, and to the air by means of a cock C; the upper tube is provided with a rubber stopper through which a glass rod passes—this rod serves to support the tube containing the substance to be experimented upon, and so avoids the objection to

FIG. 7.

the practice of withdrawing the stopper of the tube, dropping the substance in, and reinserting the stopper. To use the apparatus, a liquid of suitable boiling-point is placed in the jacket and brought to the boiling-point. All parts of the apparatus are open to the air, and the mercury in the manometer is adjusted so as to come to a

fixed mark a . The substance is now placed on the support already mentioned, and the apparatus closed to the air by inserting the cork at D and turning the cock C. By turning or withdrawing the support the substance enters the bulb; and during its vaporization the free limb of the manometer is raised so as to maintain the mercury at a . When the volatilization is quite complete, the level is accurately adjusted, and the difference of the levels of the mercury gives the pressure exerted by the vapour. To calculate the result it is necessary to know the capacity of the apparatus to the mark a , and the temperature of the jacket.

Methods depending on the Principles of Hydrostatics.—Hydrostatic principles can be applied to density determinations in four typical ways: (1) depending upon the fact that the heights of liquid columns supported by the same pressure vary inversely as the densities of the liquids; (2) depending upon the fact that a body which sinks in a liquid loses a weight equal to the weight of liquid which it displaces; (3) depending on the fact that a body remains suspended, neither floating nor sinking, in a liquid of exactly the same density; (4) depending on the fact that a floating body is immersed to such an extent that the weight of the fluid displaced equals the weight of the body.

1. The method of balancing columns is of limited use. Two forms are recognized. In one, applicable only to liquids which do not mix, the two liquids are poured into the limbs of a U tube. The heights of the columns above the surface of junction of the liquids are inversely proportional to the densities of the liquids. In the second form, named after Robert Hare (1781–1858), professor of chemistry at the university of Pennsylvania, the liquids are drawn or aspirated up vertical tubes which have their lower ends placed in reservoirs containing the different liquids, and their upper ends connected to a common tube which is in communication with an aspirator for decreasing the pressure within the vertical tubes. The heights to which the liquids rise, measured in each case by the distance between the surfaces in the reservoirs and in the tubes, are inversely proportional to the densities.

2. The method of "hydrostatic weighing" is one of the most important. The principle may be thus stated: the solid is weighed in air, and then in water. If W be the weight in air, and W_1 the weight in water, then W_1 is always less than W , the difference $W-W_1$ representing the weight of the water displaced, i.e. the weight of a volume of water equal to that of the solid. Hence $W/(W-W_1)$ is the relative density or specific gravity of the body. The principle is readily adapted to the determination of the relative densities of two liquids, for it is obvious that if W be the weight of a solid body in air, W_1 and W_2 its weights when immersed in the liquids, then $W-W_1$ and $W-W_2$ are the weights of equal volumes of the liquids, and therefore the relative density is the quotient $(W-W_1)/(W-W_2)$. The determination in the case of solids lighter than water is effected by the introduction of a sinker, i.e. a body which when affixed to the light solid causes it to sink. If W be the weight of the experimental solid in air, w the weight of the sinker in water, and W_1 the weight of the solid plus sinker in water, then the relative density is given by $W/(W+w-W_1)$. In practice the solid or plummet is suspended from the balance arm by a fibre—silk, platinum, &c.—and carefully weighed. A small stool is then placed over the balance pan, and on this is placed a beaker of distilled water so that the solid is totally immersed. Some balances are provided with a "specific gravity pan," i.e. a pan with short suspending arms, provided with a hook at the bottom to which the fibre may be attached; when this is so, the stool is unnecessary. Any air bubbles are removed from the surface of the body by brushing with a camel-hair brush; if the solid be of a porous nature it is desirable to boil it for some time in water, thus expelling the air from its interstices. The weighing is conducted in the usual way by vibrations, except when the weight be small; it is then advisable to bring the pointer to zero, an operation rendered necessary by the damping due to the adhesion of water to the fibre. The temperature and pressure of the air and water must also be taken.

There are several corrections of the formula $\Delta = W/(W-W_1)$ necessary to the accurate expression of the density. Here we can only summarize the points of the investigation. It may be assumed that the weighing is made with brass weights in air at t° and p mm. pressure. To determine the true weight *in vacuo* at 0° , account must be taken of the different buoyancies, or losses of true weight, due to the different volumes of the solids and weights. Similarly in the case of the weighing in water, account must be taken of the buoyancy of the weights, and also, if absolute densities be required, of the density of water at the temperature of the experiment. In a form of great accuracy the absolute density $\Delta(0^\circ/4^\circ)$ is given by

$$\Delta(0^\circ/4^\circ) = (\rho W - \delta W_1)/(W - W_1),$$

in which W is the weight of the body in air at t° and p mm. pressure, W_1 the weight in water, atmospheric conditions remaining very nearly the same; ρ is the density of the water in which the body is weighed, α is $(1+\alpha t)$ in which α is the coefficient of cubical expansion of the body, and δ is the density of the air at t° , p mm. Less accurate formulae are $\Delta = \rho W/(W-W_1)$, the factor involving the density of the air, and the coefficient of the expansion of the solid being disregarded, and $\Delta = W/(W-W_1)$, in which the density of water is taken as unity. Reference may be made to J. Wade and R. W. Merriman, *Journ. Chem. Soc.* 1909, 95, p. 2174.

The determination of the density of a liquid by weighing a plummet in air, and in the standard and experimental liquids,

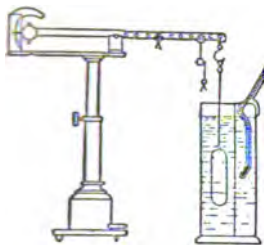

FIG. 8.

has been put into a very convenient laboratory form by means of the apparatus known as a Westphal balance (fig. 8). It consists of a steel yard mounted on a fulcrum; one arm carries at its extremity a heavy bob and pointer, the latter moving along a scale affixed to the stand and serving to indicate when the beam is in its standard position. The other arm is graduated in ten divisions and carries riders—bent pieces of wire of determined weights—and at its extremity a hook from which the glass plummet is suspended. To complete the apparatus there is a glass jar which serves to hold the liquid experimented with. The apparatus is so designed that when the plummet is suspended in air, the index of the beam is at the zero of the scale; if this be not so, then it is adjusted by a levelling screw. The plummet is now placed in distilled water at 15°, and the beam brought to equilibrium by means of a rider, which we shall call 1, hung on a hook; other riders are provided, r_{10} and r_{100} respectively of 1. To determine the density of any liquid it is only necessary to suspend the plummet in the liquid, and to bring the beam to its normal position by means of the riders; the relative density is read off directly from the riders.

3. Methods depending on the free suspension of the solid in a liquid of the same density have been especially studied by Retgers and Commer in view of their applicability to density determinations of crystals. Two typical forms are in use; in one a liquid is prepared in which the crystal freely swims, the density of the liquid being ascertained by the pycnometer or other methods; in the other a liquid of variable density, the so-called "diffusion column," is prepared, and observation is made of the level at which the particle comes to rest. The first type is in commonest use; since both necessitate the use of dense liquids, a summary of the media of most value, and their essential properties, will be given.

Acetylene tetrabromide, $C_2H_2Br_4$, which is very conveniently prepared by passing acetylene into cooled bromine, has a density of 3.001 at 6° C. It is highly convenient, since it is colourless, odourless, very stable and easily mobile. It may be diluted with benzene or toluene.

Methylene iodide, CH_2I_2 , has a density of 3.33, and may be diluted with benzene. Introduced by Brauns in 1886, it was recommended by Retgers. Its advantages rest on its high density and mobility; its main disadvantages are its liability to decomposition, the originally colourless liquid becoming dark owing to the separation of iodine, and its high coefficient of expansion. Its density may be raised to 3.65 by dissolving iodoforn and iodine in it.

Thoulet's solution, an aqueous solution of potassium and mercuric iodides (potassium iodo-mercurate), introduced by Thoulet and subsequently investigated by W. Goldschmidt, has a density of 3.196 at 22.9°. It is almost colourless and has a small coefficient of expansion; its hygroscopic properties, its viscous character, and its action on the skin, however, militate against its use. A. Duboin (*Compt. rend.*, 1905, p. 141) has investigated the solutions of mercuric iodide in other alkaline iodides; sodium iodo-mercurate solution has a density of 3.46 at 26°, and gives with an excess of water a dense precipitate of mercuric iodide, which dissolves without decomposition in alcohol; lithium iodo-mercurate solution has a density of 3.28 at 25.6°; and ammonium iodo-mercurate solution a density of 2.98 at 26°.

Rohrbach's solution, an aqueous solution of barium and mercuric iodides, introduced by Carl Rohrbach, has a density of 3.588.

Klein's solution, an aqueous solution of cadmium borotungstate, $xCd(OH)_2 \cdot yB_2O_3 \cdot zWO_3 \cdot 16H_2O$, introduced by D. Klein, has a density up to 3.28. The salt melts in its water of crystallization at 75°, and the liquid thus obtained goes up to a density of 3.6.

Silver-thallium nitrate, $TlAg(NO_3)_2$, introduced by Retgers, melts at 75° to form a clear liquid of density 4.8; it may be diluted with water.

The method of using these liquids is in all cases the same; a particle is dropped in; if it floats a diluent is added and the mixture well stirred. This is continued until the particle freely swims, and then the density of the mixture is determined by the ordinary methods (see MINERALOGY).

In the "diffusion column" method, a liquid column uniformly varying in density from about 3.3 to 1 is prepared by pouring a little methylene iodide into a long test tube and adding five times as much benzene. The tube is tightly corked to prevent evaporation, and allowed to stand for some hours. The density of the column at any level is determined by means of the areometrical beads proposed by Alexander Wilson (1714-1786), professor of astronomy at Glasgow University. These are hollow glass beads of variable density;

they may be prepared by melting off pieces of very thin capillary tubing, and determining the density in each case by the method just previously described. To use the column, the experimental fragment is introduced, when it takes up a definite position. By successive trials two beads, of known density, say d_1 , d_2 , are obtained, one of which floats above, and the other below, the test crystal; the distances separating the beads from the crystal are determined by means of a scale placed behind the tube. If the bead of density d_1 be at the distance h_1 above the crystal, and that of d_2 at h_2 below, it is obvious that if the density of the column varies uniformly, then the density of the test crystal is $(d_1 h_1 + d_2 h_2) / (h_1 + h_2)$.

Acting on a principle quite different from any previously discussed is the capillary hydrometer or staktometer of Brewster, which is based upon the difference in the surface tension and density of pure water, and of mixtures of alcohol and water in varying proportions.

If a drop of water be allowed to form at the extremity of a fine tube, it will go on increasing until its weight overcomes the surface tension by which it clings to the tube, and then it will fall. Hence any impurity which diminishes the surface tension of the water will diminish the size of the drop (unless the density is proportionately diminished). According to Quincke, the surface tension of pure water in contact with air at 20° C. is 81 dynes per linear centimetre, while that of alcohol is only 25.5 dynes; and a small percentage of alcohol produces much more than a proportional decrease in the surface tension when added to pure water. The capillary hydrometer consists simply of a small pipette with a bulb in the middle of the stem, the pipette terminating in a very fine capillary point. The instrument being filled with distilled water, the number of drops required to empty the bulb and portions of the stem between two marks m and n (fig. 9) on the latter is carefully counted, and the experiments repeated at different temperatures. The pipette having been carefully dried, the process is repeated with pure alcohol or with proof spirits, and the strength of any admixture of water and spirits is determined from the corresponding number of drops, but the formula generally given is not based upon sound data. Sir David Brewster found with one of these instruments that the number of drops of pure water was 734, while of proof spirit, sp. gr. 920, the number was 2117.

REFERENCES.—Density and density determinations are discussed in all works on practical physics; reference may be made to B. Stewart and W. W. Haldane *Gen. Practical Physics*, vol. 1. (1901); Kohlrausch, *Practical Physics*; Ostwald, *Physico-Chemical Measurements*. The density of gases is treated in M. W. Travers, *The Experimental Study of Gases* (1901); and vapour density determinations in Lassar-Cohn's *Arbeitsmethoden für organisch-chemische Laboranten* (1901), and *Manual of Organic Chemistry* (1896), and in H. Biltz, *Practical Methods for determining Molecular Weights* (1899). (C. E. 6)

FIG. 9.
Brewster's
Staktometer.

DENTATUS, MANIUS CURIUS, Roman general, conqueror of the Samnites and Pyrrhus, king of Epirus, was born of humble parents, and was possibly of Sabine origin. He is said to have been called Dentatus because he was born with his teeth already grown (Pliny, *Nat. Hist.* vii. 15). Except that he was tribune of the people, nothing certain is known of him until his first consulship in 290 B.C. when, in conjunction with his colleague P. Cornelius Rufinus, he gained a decisive victory over the Samnites, which put an end to a war that had lasted fifty years. He also reduced the revolted Sabines to submission; a large portion of their territory was distributed among the Roman citizens, and the most important towns received the citizenship without the right of voting for magistrates (*civitas sine suffragio*). With the proceeds of the spoils of the war Dentatus cut an artificial channel to carry off the waters of Lake Velinus, so as to drain the valley of Reate. In 275, after Pyrrhus had returned from Sicily to Italy, Dentatus (again consul) took the field against him. The decisive engagement took place near Beneventum in the Campi Arusini, and resulted in the total defeat of Pyrrhus. Dentatus celebrated a magnificent triumph, in which for the first time a number of captured elephants were exhibited. Dentatus was consul for the third time in 274, when he finally crushed the Lucanians and Samnites, and censor in 272. In the latter capacity he began to build an aqueduct to carry the waters of the Anio into the city, but died (270) before its completion. Dentatus was looked upon as a model of old Roman simplicity and frugality. According to the well-known anecdote, when the Samnites sent ambassadors with costly presents to induce him to exercise his influence on their behalf in the senate, they found

him sitting on the hearth and preparing his simple meal of roasted turnips. He refused their gifts, saying that earthen dishes were good enough for him, adding that he preferred ruling those who possessed gold to possessing it himself. It is also said that he died so poor that the state was obliged to provide dowries for his daughters. But these and similar anecdotes must be received with caution, and it should be remembered that what was a competence in his day would have been considered poverty by the Romans of later times.

Livy, epitome, 11-14; Polybius ii. 19; Eutropius ii. 9, 14; Florus i. 18; Val. Max. iv. 3, vi. 3, 4; Cicero, *De senectute*, 16; Juvenal xi. 78; Plutarch, *Pyrrhus*, 25.

DENTIL (from Lat. *dens*, a tooth), in architecture, a small tooth-shaped block used as a repeating ornament in the bed-mould of a cornice. Vitruvius (iv. 2) states that the dentil represents the end of a rafter (*asser*), and since it occurs in its most pronounced form in the Ionic temples of Asia Minor, the Lycian tombs and the porticoes and tombs of Persia, where it represents distinctly the reproduction in stone of timber construction, there is but little doubt as to its origin. The earliest example is that found on the tomb of Darius, c. 500 B.C., cut in the rock in which the portico of his palace is reproduced. Its first employment in Athens is in the cornice of the Caryatid portico or tribune of the Erechtheum (480 B.C.). When subsequently introduced into the bed-mould of the cornice of the choragic monument of Lysicrates it is much smaller in its dimensions. In the later temples of Ionia, as in the temple of Priene, the larger scale of the dentil is still retained. As a general rule the projection of the dentil is equal to its width, and the intervals between to half the width. In some cases the projecting band has never had the sinkings cut into it to divide up the dentils, as in the Pantheon at Rome, and it is then called a dentil-band. The dentil was the chief decorative feature employed in the bed-mould by the Romans and the Italian Revivalists. In the porch of the church of St John Studius at Constantinople, the dentil and the interval between are equal in width, and the interval is splayed back from top to bottom; this is the form it takes in what is known as the "Venetian dentil," which was copied from the Byzantine dentil in Santa Sophia, Constantinople. There, however, it no longer formed part of a bed-mould; its use at Santa Sophia was to decorate the projecting moulding enclosing the encrusted marbles, and the dentils were cut alternately on both sides of the moulding. The Venetian dentil was also introduced as a label round arches and as a string course.

DENTISTRY (from Lat. *dens*, a tooth), a special department of medical science, embracing the structure, function and therapeutics of the mouth and its contained organs, specifically the teeth, together with their surgical and prosthetic treatment. (For the anatomy of the teeth see **TEETH**.) As a distinct vocation it is first alluded to by Herodotus (500 B.C.). There are evidences that at an earlier date the Egyptians and Hindus attempted to replace lost teeth by attaching wood or ivory substitutes to adjacent sound teeth by means of threads or wires, but the gold fillings reputed to have been found in the teeth of Egyptian mummies have upon investigation been shown to be superficial applications of gold leaf for ornamental purposes. The impetus given to medical study in the Grecian schools by the followers of Aesculapius and especially Hippocrates (500 to 400 B.C.) developed among the practitioners of medicine and surgery considerable knowledge of dentistry. Galen (A.D. 131) taught that the teeth were true bones existing before birth, and to him is credited the belief that the upper canine teeth receive branches from the nerve which supplies the eye, and hence should be called "eye-teeth." Abulcasis (10th cent. A.D.) describes the operation by which artificial crowns are attached to adjacent sound teeth. Vesalius (1514), Ambroise Paré, J. J. Scaliger, T. Kerckring, M. Malpighi, and lesser anatomists of the same period contributed dissertations which threw some small amount of light upon the structure and functions of the teeth. The operation of transplanting teeth is usually attributed to John Hunter (1728-1793), who practised it extensively, and gave to it additional prominence by transplanting

a human tooth to the comb of a cock, but the operation was alluded to by Ambroise Paré (1509-1590), and there is evidence to show that it was practised even earlier. A. von Leeuwenhoek in 1678 described with much accuracy the tubular structure of the dentine, thus making the most important contribution to the subject which had appeared up to that time. Until the latter part of the 18th century extraction was practically the only operation for the cure of toothache.

The early contributions of France exerted a controlling influence upon the development of dental practice. Urbain Hémard, surgeon to the cardinal Georges of Armagnac, whom Dr Blake (1801) calls an ingenious surgeon and a great man, published in 1582 his *Researches upon the Anatomy of the Teeth, their Nature and Properties*. Of Hémard, M. Fauchard says: "This surgeon had read Greek and Latin authors, whose writings he has judiciously incorporated in his own works." In 1728 Fauchard, who has been called the father of modern dentistry, published his celebrated work, entitled *Le Chirurgien Dentiste ou traité des dents*. The preface contains the following statement as to the existing status of dental art and science in France, which might have been applied with equal truth to any other European country:—"The most celebrated surgeons having abandoned this branch of surgery, or having but little cultivated it, their negligence gave rise to a class of persons who, without theoretic knowledge or experience, and without being qualified, practised it at hazard, having neither principles nor system. It was only since the year 1700 that the intelligent in Paris opened their eyes to these abuses, when it was provided that those who intended practising dental surgery should submit to an examination by men learned in all the branches of medical science, who should decide upon their merits." After the publication of Fauchard's work the practice of dentistry became more specialized and distinctly separated from medical practice, the best exponents of the art being trained as apprentices by practitioners of ability, who had acquired their training in the same way from their predecessors. Fauchard suggested porcelain as an improvement upon bone and ivory for the manufacture of artificial teeth, a suggestion which he obtained from R. A. F. de Réaumur, the French savant and physicist, who was a contributor to the royal porcelain manufactory at Sèvres. Later, Duchateau, an apothecary of St Germain, made porcelain teeth, and communicated his discovery to the Academy of Surgery in 1776, but kept the process secret. Du Bois Chémant carried the art to England, and the process was finally made public by M. Du Bois Foucou. M. Fonzi improved the art to such an extent that the Athenæum of Arts in Paris awarded him a medal and crown (March 14, 1808).

In Great Britain the 19th century brought the dawning of dental science. The work of Dr Blake in 1801 on the anatomy of the teeth was distinctly in advance of anything previously written on the subject. Joseph Fox was one of the first members of the medical profession to devote himself exclusively to dentistry, and his work is a repository of the best practice of his time. The processes described, though comparatively crude, involve principles in use at the present time. Thomas Bell, the successor of Fox as lecturer on the structure and disease of the teeth at Guy's Hospital, published his well-known work in 1829. About this period numerous publications on dentistry made their appearance, notably those of Koecker, Johnson and Waite, followed somewhat later by the admirable work of Alexander Nasmyth (1839). By this time Cuvier, Serres, Rousseau, Bertin, Herissant and others in France had added to the knowledge of human and comparative dental anatomy, while M. G. Retzius, of Sweden, and E. H. Weber, J. C. Rosenmüller, Schreger, J. E. von Purkinje, B. Fraenkel and J. Müller in Germany were carrying forward the same lines of research. The sympathetic nervous relationships of the teeth with other parts of the body, and the interaction of diseases of the teeth with general pathological conditions, were clearly established. Thus a scientific foundation was laid, and dentistry came to be practised as a speciality of medicine. Certain minor operations, however, such as the extraction of teeth and the stopping of caries in an imperfect way, were still practised by barbers, and the empirical practice of dentistry, especially of

those operations which were almost wholly mechanical, had developed a considerable body of dental artisans who, though without medical education in many cases, possessed a high degree of manipulative skill. Thus there came to be two classes of practitioners, the first regarding dentistry as a specialty of medicine, the latter as a distinct and separate calling.

In America representatives of both classes of dentists began to arrive from England and France about the time of the Revolution. Among these were John Wooffendale (1766), a student of Robert Bermore of Liverpool, surgeon-dentist to George III.; James Gardette (1778), a French physician and surgeon; and Joseph Lemaire (1781), a French dentist who went out with the army of Count Rochambeau. During the winter of 1781-1782, while the Continental army was in winter quarters at Providence, Rhode Island, Lemaire found time and opportunity to practise his calling, and also to instruct one or two persons, notably Josiah Flagg, probably the first American dentist. Dental practice was thus established upon American soil, where it has produced such fertile results.

Until well into the 19th century apprenticeship afforded the only means of acquiring a knowledge of dentistry. The profits derived from the apprenticeship system fostered secrecy and quackery among many of the early practitioners; but the more liberal minded and better educated of the craft developed an increasing opposition to these narrow methods. In 1837 a local association of dentists was formed in New York, and in

1840 a national association, The American Society of Dental Surgeons, the object of which was "to advance the science by free communication and interchange of sentiments." The first dental periodical in the world, *The American Journal of Dental Science*, was issued in June 1839, and in November 1840 was established the Baltimore College of Dental Surgery, the first college in the world for the systematic education of dentists. Thus the year 1839-1840 marks the birth of the three factors essential to professional growth in dentistry. All this, combined with the refusal of the medical schools to furnish the desired facilities for dental instruction, placed dentistry for the time being upon a footing entirely separate from general medicine. Since then the curriculum of study preparatory to dental practice has been systematically increased both as to its content and length, until in all fundamental principles it is practically equal to that required for the training of medical specialists, and in addition includes the technical subjects peculiar to dentistry. In England, and to some extent upon the continent, the old apprenticeship system is retained as an adjunct to the college course, but it is rapidly dying out, as it has already done in America. Owing to the regulation by law of the educational requirements, the increase of institutions devoted to the professional training of dentists has been rapid in all civilized countries, and during the past twenty years especially so in the United States. Great Britain possesses upwards of twelve institutions for dental instruction, France two, Germany and Switzerland six, all being based upon the conception that dentistry is a department of general medicine. In the United States there were in 1878 twelve dental schools, with about 700 students; in 1907 there were fifty-seven schools, with 6919 students. Of these fifty-seven schools, thirty-seven are departments of universities or of medical institutions, and there is a growing tendency to regard dentistry from its educational aspect as a special department of the general medical and surgical practice.

Recent studies have shown that besides being an important part of the digestive system, the mouth sustains intimate relationship with the general nervous system, and is important as the portal of entrance for the majority of the bacteria that cause specific diseases. This fact has rendered more intimate the relations between dentistry and the general practice of medicine, and has given a powerful impetus to scientific studies in dentistry.

Through the researches of Sir J. Tomes, Mummery, Hopewell Smith, Williams and others in England, O Hertwig, Weil and Rösé in Germany, Andrews, Sudduth and Black in America, the minute anatomy and embryology of the dental tissues have been worked out with great fulness and

precision. In particular, it has been demonstrated that certain general systemic diseases have a distinct oral expression. Through their extensive nervous connexions with the largest of the cranial nerves and with the sympathetic nervous system, the teeth frequently cause irritation resulting in profound reflex nervous phenomena, which are curable only by removal of the local tooth disorder. Gout, lithaemia, scurvy, rickets, lead and mercurial poisoning, and certain forms of chronic nephritis, produce dental and oral lesions which are either pathognomonic or strongly indicative of their several constitutional causes, and are thus of great importance in diagnosis. The most important dental research of modern times is that which was carried out by Professor W. D. Miller of Berlin (1884) upon the cause of caries of the teeth, a disease said to affect the human race more extensively than any other. Miller demonstrated that, as previous observers had suspected, caries is of bacterial origin, and that acids play an important rôle in the process. The disease is brought about by a group of bacteria which develop in the mouth, growing naturally upon the débris of starchy or carbohydrate food, producing fermentation of the mass, with lactic acid as the end product. The lactic acid dissolves the mineral constituent of the tooth structure, calcium phosphate, leaving the organic matrix of the tooth exposed. Another class of germs, the peptonising and putrefactive bacteria, then convert the organic matter into liquid or gaseous end products. The accuracy of the conclusions obtained from his analytic research was synthetically proved, after the manner of Koch, by producing the disease artificially. Caries of the teeth has been shown to bear highly important relation to more remote or systemic diseases. Exposure and death of the dental pulp furnishes an avenue of entrance for disease-producing bacteria, by which invasion of the deeper tissues may readily take place, causing necrosis, tuberculosis, actinomycosis, phlegmon and other destructive inflammations, certain of which, affecting the various sinuses of the head, have been found to cause meningitis, chronic empyema, metastatic abscesses in remote parts of the body, paralysis, epilepsy and insanity.

Operative Dentistry.—The art of dentistry is usually divided arbitrarily into *operative dentistry*, the purpose of which is to preserve as far as possible the teeth and associated tissues, and *prosthetic dentistry*, the purpose of which is to supply the loss of teeth by artificial substitutes. The filling of carious cavities was probably first performed with lead, suggested apparently by an operation recorded by Celsus (100 B.C.), who recommended that frail or decayed teeth be stuffed with lead previous to extraction, in order that they might not break under the forceps. The use of lead as a filling was sufficiently prevalent in France during the 17th century to bring into use the word *plombage*, which is still occasionally applied in that country to the operation of filling. Gold as a filling material came into general use about the beginning of the 19th century.¹ The earlier preparations of gold were so impure as to be virtually without cohesion, so that they were of use only in cavities which had sound walls for its retention. In the form of rolls or tape it was forced into the previously cleaned and prepared cavity, condensed with instruments under heavy hand pressure, smoothed with files, and finally burnished. Tin foil was also used to a limited extent and by the same method. Improvements in the refining of gold for dental use brought the product to a fair degree of purity, and, about 1855, led to the invention by Dr Robert Arthur of Baltimore of a method by which it could be welded firmly within the cavity. The cohesive properties of the foil were developed by passing it through an alcohol flame, which dispelled its surface contaminations. The gold was then welded piece by piece into a homogeneous mass by plugging instruments with serrated points. In this process of cold-welding, the mallet, hitherto in only limited use, was found more efficient than hand pressure, and was rapidly developed. The primitive mallet of wood, ivory, lead or steel, was supplanted by a mallet in which

Filling of
stopping.

¹ The filling of teeth with gold foil is recorded in the oldest known book on dentistry, *Artzney Buchlein*, published anonymously in 1530, in which the operation is quoted from Mesue (A.D. 857), physician to the caliph Haroun al-Raschid.

a hammer was released automatically by a spring condensed by pressure of the operator's hand. Then followed mallets operated by pneumatic pressure, by the dental engine, and finally by the electro-magnet, as utilized in 1867 by Bonwill. These devices greatly facilitated the operation, and made possible a partial or entire restoration of the tooth-crown in conformity with anatomical lines.

The dental engine in its several forms is the outgrowth of the simple drill worked by the hand of the operator. It is used in removing decayed structure and for shaping the cavity for inserting the filling. From time to time its usefulness has been extended, so that it is now used for finishing fillings and polishing them, for polishing the teeth, removing deposits from them and changing their shapes. Its latest development, the *dento-surgical engine*, is of heavier construction and is adapted to operations upon all of the bones, a recent addition to its equipment being the spiral osteotome of Cryer, by which, with a minimum shock to the patient, fenestrae of any size or shape in the brain-case may be made, from a simple trepanning operation to the more extensive openings required in intra-cranial operations. The rotary power may be supplied by the foot of the operator, or by hydraulic or electric motors. The rubber dam invented by S. C. Barnum of New York (1864) provided a means for protecting the field of operations from the oral fluids, and extended the scope of operations even to the entire restoration of tooth-crowns with cohesive gold foil. Its value has been found to be even greater than was at first anticipated. In all operations involving the exposed dental pulp or the pulp-chamber and root-canals, it is the only efficient method of mechanically protecting the field of operation from invasion by disease-producing bacteria.

The difficulty and annoyance attending the insertion of gold, its high thermal conductivity, and its objectionable colour have led to an increasing use of amalgam, gutta-percha, and cements of zinc oxide mixed with zinc chloride or phosphoric acid. Recently much attention has been devoted to restorations with porcelain. A piece of platinum foil of .001 inch thickness is burnished and pressed into the cavity, so that a matrix is produced exactly fitting the cavity. Into this matrix is placed a mixture of powdered porcelain and water or alcohol, of the colour to match the tooth. The mass is carefully dried and then fused until homogeneous. Shrinkage is counteracted by additions of porcelain powder, which are repeatedly fused until the whole exactly fills the matrix. After cooling, the matrix is stripped away and the porcelain is cemented into the cavity. When the cement has hardened, the surface of the porcelain is ground and polished to proper contour. If successfully made, porcelain fillings are scarcely noticeable. Their durability remains to be tested.

Until recent times the exposure of the dental pulp inevitably led to its death and disintegration, and, by invasion of bacteria via the pulp canal, set up an inflammatory process which eventually caused the loss of the entire tooth. A rational system of therapeutics, in conjunction with proper antiseptic measures, has made possible both the conservative treatment of the dental pulp when exposed, and the successful treatment of pulp-canals when the pulp has been devitalized either by design or disease. The conservation of the exposed pulp is affected by the operation of capping. In capping a pulp, irritation is allayed by antiseptic and sedative treatment, and a metallic cap, lined with a non-irritant sedative paste; is applied under aseptic conditions immediately over the point of pulp exposure. A filling of cement is superimposed, and this, after it has hardened, is covered with a metallic or other suitable filling. The utility of arsenious acid for devitalizing the dental pulp was discovered by J. R. Spooner of Montreal, and first published in 1836 by his brother Shearjashub in his *Guide to Sound Teeth*. The painful action of arsenic upon the pulp was avoided by the addition of various sedative drugs,—morphia, atropia, iodoform, &c.,—and its use soon became universal. Of late years it is being gradually supplanted by immediate surgical extirpation under the benumbing effect of cocaine salts. By the use of cocaine also the pain incident to excavating and shaping

of cavities in tooth structure may be controlled, especially when the cocaine is driven into the dentine by means of an electric current. To fill the pulp-chamber and canals of teeth after loss of the pulp, all organic remains of pulp tissue should be removed by sterilization, and then, in order to prevent the entrance of bacteria, and consequent infection, the canals should be perfectly filled. Upon the exclusion of infection depends the future integrity and comfort of the tooth. Numberless methods have been invented for the operation. Pulpless teeth are thus preserved through long periods of usefulness, and even those remains of teeth in which the crowns have been lost are rendered comfortable and useful as supports for artificial crowns, and as abutments for assemblages of crowns, known as bridge-work.

The discoloration of the pulpless tooth through putrefactive changes in its organic matter were first overcome by bleaching it with chlorine. Small quantities of calcium hypochlorite are packed into the pulp-chamber and moistened with dilute acetic acid; the decomposition of the calcium salt liberates chlorine *in situ*, which restores the tooth to normal colour in a short time. The cavity is afterwards washed out, carefully dried, lined with a light-coloured cement and filled. More efficient bleaching agents of recent introduction are hydrogen dioxide in a 25% solution or a saturated solution of sodium peroxide; they are less irritating and much more convenient in application. Unlike chlorine, these do not form soluble metallic salts which may subsequently discolour the tooth. Hydrogen dioxide may be carried into the tooth structure by the electric current. In which case a current of not less than forty volts controlled by a suitable graduated resistance is applied with the patient in circuit, the anode being a platinum-pointed electrode in contact with the dioxide solution in the tooth cavity, and the cathode a sponge or plate electrode in contact with the hand or arm of the patient. The current is gradually turned on until two or three milliamperes are indicated by a suitable ammeter. The operation requires usually twenty to thirty minutes.

Malposed teeth are not only unsightly but prone to disease, and may be the cause of disease in other teeth, or of the associated tissues. The impairment of function which their abnormal position causes has been found to be the primary cause of disturbances of the general bodily health; for example, enlarged tonsils, chronic pharyngitis and nasal catarrh, indigestion and malnutrition. By the use of springs, screws, vulcanized caoutchouc bands, elastic ligatures, &c., as the case may require, practically all forms of dental irregularity may be corrected, even such protrusions and retrusions of the front teeth as cause great disfigurement of the facial contour.

The extraction of teeth, an operation which until quite recent times was one of the crudest procedures in minor surgery, has been reduced to exactitude by improved instruments, designed with reference to the anatomical relations of the teeth and their alveoli, and therefore adapted to the several classes of teeth. The operation has been rendered painless by the use of anaesthetics. The anaesthetic generally employed is nitrous oxide, or laughing-gas, the use of which was discovered in 1844 by Horace Wells, a dentist of Hartford, Conn., U.S.A. Chloroform and ether, as well as other general anaesthetics, have been employed in extensive operations because of their more prolonged effect; but chloroform, especially, is dangerous, owing to its effect upon the heart, which in many instances has suddenly failed during the operation. Ether, while less manageable than nitrous oxide, has been found to be practically devoid of danger. The local injection of solutions of cocaine and allied anaesthetics into the gum-tissue is extensively practised; but is attended with danger, from the toxic effects of an overdose upon the heart, and the local poisonous effect upon the tissues, which lead in numerous cases to necrosis and extensive sloughing.

Dental Prosthesis.—The fastening of natural teeth or carved substitutes to adjoining sound teeth by means of thread or wire preceded their attachment to base-plates of carved wood, bone or ivory, which latter method was practised until the introduction of swaged metallic plates. Where the crown only of a tooth or those of several teeth were lost, the

Dental therapeutics.

Extraction.

Artificial teeth.

restoration was effected by engrafting upon the prepared root a suitable crown by means of a wooden or metallic pivot. When possible, the new crown was that of a corresponding sound tooth taken from the mouth of another individual; otherwise an artificial crown carved from bone or ivory, or sometimes from the tooth of an ox, was used. To replace entire dentures a base-plate of carved hippopotamus ivory was constructed, upon which were mounted the crowns of natural teeth, or later those of porcelain. The manufacture of a denture of this character was tedious and uncertain, and required much skill. The denture was kept in place by spiral springs attached to the buccal sides of the appliance above and below, which caused pressure upon both jaws, necessitating a constant effort upon the part of the unfortunate wearer to keep it in place. Metallic swaged plates were introduced in the latter part of the 18th century. An impression of the gums was taken in wax, from which a cast was made in plaster of Paris. With this as a model, a metallic die of brass or zinc was prepared, upon which the plate of gold or silver was formed, and then swaged into contact with the die by means of a female die or counter-die of lead. The process is essentially the same to-day, with the addition of numerous improvements in detail, which have brought it to a high degree of perfection. The discovery, by Gardette of Philadelphia in 1800, of the utility of atmospheric pressure in keeping artificial dentures in place led to the abandonment of spiral springs. A later device for enhancing the stability is the vacuum chamber, a central depression in the upper surface of the plate, which, when exhausted of air by the wearer, materially increases the adhesion. The metallic base-plate is used also for supporting one or more artificial teeth, being kept in place by metallic clasps fitting to, and partially surrounding, adjacent sound natural teeth, the plate merely covering the edentulous portion of the alveolar ridge. It may also be kept in place by atmospheric adhesion, in which case the palatal vault is included, and the vacuum chamber is utilized in the palatal portion to increase the adhesion.

In the construction usually practised, porcelain teeth are attached to a gold base-plate by means of stay-pieces of gold, perforated to receive the platinum pins baked in the body of the tooth. The stay-pieces or backings are then soldered to the pins and to the plate by means of high-fusing gold solder. The teeth used may be single or in sections, and may be with or without an extension designed in form and colour to imitate the gum of the alveolar border. Even when skillfully executed, the process is imperfect in that the jointing of the teeth to each other, and their adaptation to the base-plate, leaves crevices and recesses, in which food debris and oral secretions accumulate. To obviate these defects the enamelled platinum denture was devised. Porcelain teeth are first attached to a swaged base-plate of pure platinum by a stay-piece of the same metal soldered with pure gold, after which the interstices between the teeth are filled, and the entire surface of the plate, excepting that in contact with the palate and alveolar border, is covered with a porcelain paste called the body, which is modelled to the normal contour of the gums, and baked in a muffle furnace until vitrified. It is then enamelled with a vitreous enamel coloured in imitation of the colour of the natural gum, which is applied and fired as before, the result being the most artistic and hygienic denture known. This is commonly known as the continuous gum method. Originating in France in the early part of the 19th century, and variously improved by several experimenters, it was brought to its present perfection by Dr John Allen of New York about 1846-1847. Dentures supported upon cast bases of metallic alloys and of aluminium have been employed as substitutes for the more expensive dentures of gold and platinum, but have had only a limited use, and are less satisfactory.

Metallic bases were used exclusively as supports for artificial dentures until in 1855-1856 Charles Goodyear, Jun., patented in England a process for constructing a denture upon vulcanized caoutchouc as a base. Several modifications followed, each the subject of patented improvements. Though the cheapness and simplicity of the vulcanite base has led to its abuse in incompetent hands, it has on the whole been productive of much

benefit. It has been used with great success as a means of attaching porcelain teeth to metallic bases of gold, silver and aluminium. It is extensively used also in correcting irregular positions of the teeth, and for making interdental splints in the treatment of fractures of the jaws. For the mechanical correction of palatal defects causing imperfection of deglutition and speech, which comes distinctly within the province of the prosthetic dentist, the vulcanite base produces the best-known apparatus. Two classes of palatal mechanism are recognized—the obturator, a palatal plate, the function of which is to close perforations or clefts in the hard palate, and the artificial velum, a movable attachment to the obturator or palatal plate, which closes the opening in the divided natural velum and, moving with it, enables the wearer to close off the nasopharynx from the oral cavity in the production of the guttural sounds. Vulcanite is also used for extensive restorations of the jaws after surgical operations or loss by disease, and in the majority of instances wholly corrects the deformity.

For a time vulcanite almost supplanted gold and silver as a base for artificial denture, and developed a generation of practitioners deficient in that high degree of skill necessary to the construction of dentures upon metallic bases.

The recent development of crown-and-bridge work has brought about a renaissance, so that a thorough training is more than ever necessary to successful practice in mechanical dentistry. The simplest crown is of porcelain, and is engrafted upon a sound natural tooth-root by means of a metallic pin of gold or platinum, extending into the previously enlarged root-canal and cemented in place. In another type of crown the point between the root-end and the abutting crown-surface is encircled with a metallic collar or band, which gives additional security to the attachment and protects the joints from fluids or bacteria. Crowns of this character are constructed with a porcelain facing attached by a stay-piece or backing of gold to a plate and collar, which has been previously fitted to the root-end like a ferrule, and soldered to a pin which projects through the ferrule into the root-canal. The contour of the lingual surface of the crown is made of gold, which is shaped to conform to the anatomical lines of the tooth. The shell-crown consists of a reproduction of the crown entirely of gold plate, filled with cement, and driven over the root-end, which it closely encircles. The two latter kinds of crowns may be used as abutments for the support of intervening crowns in constructing bridge-work. When artificial crowns are supported not by natural tooth-roots but by soldering them to abutments, they are termed dummies. The number of dummies which may be supported upon a given number of roots depends upon the position and character of the abutments, the character of the alveolar tissues, the age, sex and health of the patient, the character of the occlusion or bite, and the force exerted in mastication. In some cases a root will not properly support more than one additional crown; in others an entire bridge denture has been successfully supported upon four well-placed roots. Two general classes of bridge-work are recognized, namely, the fixed and the removable. Removable bridge-work, though more difficult to construct, is preferable, as it can be more thoroughly and easily cleansed. When properly made and applied to judiciously selected cases, the bridge denture is the most artistic and functionally perfect restoration of prosthetic dentistry.

The entire development of modern dentistry dates from the 19th century, and mainly from its latter half. Beginning with a few practitioners and no organized professional basis, educational system or literature, its practitioners are to be found in all civilized communities, those in Great Britain numbering about 5000; in the United States, 27,000; France, 1600, of whom 376 are graduates; German Empire, qualified practitioners (*Zahnärzte*), 1400; practitioners without official qualification, 4100. Its educational institutions are numerous and well equipped. It possesses a large periodical and standard literature in all languages. Its practice is regulated by legislative enactment in all countries the same as is medical practice. The business of manufacturing and selling dentists' supplies

Modern methods.

represents an enormous industry, in which millions of capital are invested.

AUTHORITIES.—W. F. Litch, *American System of Dentistry*; Julius Scheff, jun., *Handbuch der Zahnheilkunde*; Charles J. Essig, *American Text-Book of Prosthetic Dentistry*; Tomes, *Dental Anatomy and Dental Surgery*; W. D. Miller, *Microorganisms of the Human Mouth*; Hopewell Smith, *Dental Microscopy*; H. H. Burchard, *Dental Pathology, Therapeutics and Pharmacology*; F. J. S. Gorgas, *Dental Medicine*; E. H. Angle, *Treatment of Malocclusion of the Teeth and Fractures of the Maxillae*; G. Evans, *A Practical Treatise on Artificial Crown-and-Bridge Work and Periodontal Dental Art*; C. N. Johnson, *Principles and Practice of Filling Teeth*; *American Text-Book of Operative Dentistry* (3rd ed., 1905); Edward C. Kirk, *Principles and Practice of Operative Dentistry* (2nd ed., 1905); J. S. Marshall, *American Text-Book of Prosthetic Dentistry* (edited by C. R. Turner; 3rd ed., 1907). (E. C. K.)

DENTON, an urban district in the Gorton parliamentary division of Lancashire, England, 4½ m. N.E. from Stockport, on the London & North-Western railway. Pop. (1901) 14,934. In the township are reservoirs for the water supply of Manchester, with a capacity of 1,860,000,000 gallons. The manufacture of felt hats is the leading industry. Coal is extensively mined in the district.

DENVER, the capital of Colorado, U.S.A., the county-seat of Denver county, and the largest city between Kansas City, Missouri, and the Pacific coast, sometimes called the "Queen City of the Plains." Pop. (1870) 4759; (1880) 35,629; (1890) 106,713; (1900) 133,859, of whom 25,301 were foreign-born and 3923 were negroes; (1910 census) 213,381. Of the 25,301 foreign-born in 1900, 5114 were Germans; 3485, Irish; 3376, Swedes; 3344, English; 2623, English-Canadian; 1338, Russians; and 1033, Scots. Denver is an important railway centre, being served by nine railways, of which the chief are the Atchison, Topeka & Santa Fé; the Chicago, Burlington & Quincy; the Chicago, Rock Island & Pacific; the Denver & Rio Grande; the Union Pacific; and the Denver, North-Western & Pacific.

Denver lies on the South Platte river, at an altitude exactly 1 m. above the sea, about 15 m. from the E. base of the Rocky mountains, which stretch along the W. horizon from N. to S. in an unbroken chain of some 175 m. Excursions may be made in all directions into the mountains, affording beautiful scenery and interesting views of the mining camps. Various peaks are readily accessible from Denver: Long's Peak (14,271 ft.), Gray's Peak (14,341 ft.), Torrey Peak (14,336 ft.), Mt. Evans (14,330 ft.), Pike's Peak (14,108 ft.), and many others of only slightly less altitudes. The streets are excellent, broad and regular. The parks are a fine feature of the city; by its charter a fixed percentage of all expenditures for public improvements must be used to purchase park land. Architectural variety and solidity are favoured in the buildings of the city by a wealth of beautiful building stones of varied colours (limestones, sandstones, lavas, granites and marbles), in addition to which bricks and Roman tiles are employed. The State Capitol, built of native granite and marble (1887-1895, cost \$2,500,000), is an imposing building. Noteworthy also are the Denver county court house; the handsome East Denver high school; the Federal building, containing the United States custom house and post office; the United States mint; the large Auditorium, in which the Democratic National convention met in 1908; a Carnegie library (1908) and the Mining Exchange; and there are various excellent business blocks, theatres, clubs and churches. Denver has an art museum and a zoological museum. The libraries of the city contain an aggregate of some 300,000 volumes. Denver is the seat of the Jesuit college of the Sacred Heart (1888; in the suburbs); and the university of Denver (Methodist, 1889), a co-educational institution, succeeding the Colorado Seminary (founded in 1864 by John Evans), and consisting of a college of liberal arts, a graduate school, Chamberlin astronomical observatory and a preparatory school—these have buildings in University Park—and (near the centre of the city) the Denver and Gross College of Medicine, the Denver law school, a college of music in the building of the old Colorado Seminary, and a Saturday college (with classes specially for professional men).

The prosperity of the city depends on that of the rich mining country about it, on a very extensive wholesale trade, for which its situation and railway facilities admirably fit it, and on its large manufacturing and farming interests. The value of manufactures produced in 1900 was \$41,368,698 (increase 1890-1900, 41.5%). The value of the factory product for 1905, however, was 3.3% less than that for 1900, though it represented 36.6% of the product of the state as a whole. The principal industry is the smelting and refining of lead, and the smelting works are among the most interesting sights of the city. The value of the ore reduced annually is about \$10,000,000. Denver has also large foundries and machine shops, flour and grist mills, and slaughtering and meat-packing establishments. Denver is the central live-stock market of the Rocky Mountain states. The beet sugar, fruit and other agricultural products of the surrounding and tributary section were valued in 1906 at about \$20,000,000. The assessed valuation of property in the city in 1905 was \$115,338,920 (about the true value), and the bonded debt \$1,079,595.

At Denver the South Platte is joined by Cherry Creek, and here in October 1858 were established on opposite sides of the creek two bitterly rival settlements, St Charles and Auraria; the former was renamed almost immediately Denver, after General J. W. Denver (1818-1892), ex-governor of Kansas (which then included Colorado), and Auraria was absorbed. Denver had already been incorporated by a provisional local (extra legal) "legislature," and the Kansas legislature gave a charter to a rival company which the Denver people bought out. A city government was organized in December 1859; and continued under a reincorporation effected by the first territorial legislature of 1861. This body adjourned from Colorado City, nominally the capital, to Denver, and in 1862 Golden was made the seat of government. In 1868 Denver became the capital, but feeling in the southern counties was then so strong against Denver that provision was made for a popular vote on the situation of the capital five years after Colorado should become a state. This popular vote confirmed Denver in 1881. Until 1870, when it secured a branch railway from the Union Pacific line at Cheyenne (Wyoming), the city was on one side of the transcontinental travel-routes. The first road was quickly followed by the Kansas Pacific from Kansas City (1870, now also part of the Union Pacific), the Denver & Rio Grande (1871), the Burlington system (1882), the Atchison, Topeka & Santa Fé (1887), and other roads which have made Denver's fortune. In April 1859 appeared the first number of *The Rocky Mountain News*. The same year a postal express to Leavenworth, Kansas (10 days, letters 25 cents an ounce) was established; and telegraph connexion with Boston and New York (\$9 for 10 words) in 1863. A private mint was established in 1860. In the 'seventies all the facilities of a modern city—gas, street-cars, water-works, telephones—were introduced. Much the same might be said of a score of cities in the new West, but none is a more striking example than Denver of marvellous growth. The city thrived on the freighting trade of the mines. In 1864 a tremendous flood almost ruined it, and another flood in 1878, and a famous strike in Denver and Leadville in 1879-1880 were further, but only momentary, checks to its prosperity. As in every western city, particularly those in mining regions whose sites attained speculative values, Denver had grave problems with "squatters" or "land-jumpers" in her early years; and there was the usual gambling and outlawry, sometimes extra-legally repressed by vigilantes. Settled social conditions, however, soon established themselves. In 1880 there was a memorable election riot under the guise of an anti-Chinese demonstration. In the decade 1870-1880 the population increased 648.7%. The 'eighties were notable for great real estate activity, and the population of the city increased 199.5% from 1880 to 1890. In 1882-1884 three successive annual exhibits of a National Mining and Industrial Exposition were held. After 1890 growth was slower but continuous. In 1902 a city-and-county of Denver was created with extensive powers of framing its own charter, and in 1904 a charter was adopted. The constitution of the state was

framed by a convention that sat at Denver from December 1875 to March 1876; various territorial conventions met here; and here W. J. Bryan was nominated in 1908 for the presidency.

DEODAND (Lat. *Deo dandum*, that which is to be given to God), in English law, was a personal chattel (any animal or thing) which, on account of its having caused the death of a human being, was forfeited to the king for pious uses. Blackstone, while tracing in the custom an expiatory design, alludes to analogous Jewish and Greek laws,¹ which required that what occasions a man's death should be destroyed. In such usages the notion of the punishment of an animal or thing, or of its being morally affected from having caused the death of a man, seems to be implied. The forfeiture of the offending instrument in no way depends on the guilt of the owner. This imputation of guilt to inanimate objects or to the lower animals is not inconsistent with what we know of the ideas of uncivilized races. In English law, deodands came to be regarded as mere forfeitures to the king, and the rules on which they depended were not easily explained by any key in the possession of the old commentators. The law distinguished, for instance, between a thing in motion and a thing standing still. If a horse or other animal in motion killed a person, whether infant or adult, or if a cart ran over him, it was forfeited as a deodand. On the other hand, if death were caused by falling from a cart or a horse at rest, the law made the chattel a deodand if the person killed were an adult, but not if he were below the years of discretion. Blackstone accounts for the greater severity against things in motion by saying that in such cases the owner is more usually at fault, an explanation which is doubtful in point of fact, and would certainly not account for other instances of the same tendency. Thus, where a man's death is caused by a thing not in motion, that part only which is the immediate cause is forfeited, as "if a man be climbing up the wheel of a cart, and is killed by falling from it, the wheel alone is a deodand"; whereas, if the cart were in motion, not only the wheel but all that moves along with it (as the cart and the loading) are forfeited. A similar distinction is to be found in Britain. Where a man is killed by a vessel at rest the cargo is not deodand; where the vessel is under sail, hull and cargo are both deodand. For the distinction between the death of a child and the death of an adult Blackstone accounts by suggesting that the child "was presumed incapable of actual sin, and therefore needed no deodand to purchase propitiatory masses; but every adult who died in actual sin stood in need of such atonement, according to the humane superstition of the founders of the English law." Sir Matthew Hale's explanation was that the child could not take care of himself, whereon Blackstone asks why the owner should save his forfeiture on account of the imbecility of the child, which ought to have been an additional reason for caution. The finding of a jury was necessary to constitute a deodand, and the investigation of the value of the instrument by which death was caused occupied an important place among the provisions of early English criminal law. It became a necessary part of an indictment to state the nature and value of the weapon employed—as, that the stroke was given by a certain penknife, of the value of sixpence—so that the king might have his deodand. Accidents on the high seas did not cause forfeiture, being beyond the domain of the common law; but it would appear that in the case of ships in fresh water the law held good. The king might grant his right to deodands to another. In later times these forfeitures became extremely unpopular; and juries, with the connivance of judges, found deodands of trifling value, so as to defeat the equitable claim. At last, by an act of 1846 they were abolished, the date noticeably coinciding with the introduction of railways and modern steam-engines.

DEOGARH, the name of several towns of British India. (1) A town in the Santal Parganas district of Bengal. Pop. (1901) 813. It is famous for a group of twenty-two temples dedicated to Siva, the resort of numerous pilgrims. It is connected with the East Indian railway by a steam tramway, 5 m. in length.

¹ Compare also the rule of the Twelve Tables, by which an animal which had inflicted mischief might be surrendered in lieu of compensation.

(2) The headquarters of the *Bamra* feudatory state in Bengal; 58 m. by road from the Bamra Road station on the Bengal-Nagpur railway. Pop. (1901) 5702. The town, which is well laid out, with parks and gardens, and pleasantly situated in a hollow among hills, rapidly increased in population under the enlightened administration of the raja, Sir Sudhal Rao, K.C.I.E. (b. 1860). It has a state-supported high school affiliated to Calcutta University, with a chemical and physical laboratory. (3) The chief town of the Deogarh estate in the state of Udaipur, Rajputana, about 68 m. N.N.E. of the city of Udaipur. It is walled, and contains a fine palace. Pop. (1901) 5384. The holder of the estate is styled *raja*, and is one of the first-class nobles of Mewar. (4) Deogarh Fort, the ancient Devagiri or Deogiri (see DAULATABAD).

DÉOLS, a suburb of the French town of Châteauroux, in the department of Indre. Pop. (1906) 2337. Déols lies to the north of Châteauroux, from which it is separated by the Indre. It preserves a fine Romanesque tower and other remains of the church of a famous Benedictine abbey, the most important in Berry, founded in 917 by Ebbes the Noble, lord of Déols. A gateway flanked by towers survives from the old ramparts of the town. The parish church of St Stephen (15th and 16th centuries) has a Romanesque façade and a crypt containing the ancient Christian tomb of St Ludre and his father St Leocade, who according to tradition were lords of the town in the 4th century. There are also interesting old paintings of the 10th century representing the ancient abbey. The pilgrimage to the tomb of St Ludre gave importance to Déols, which under the name of *Vicus Dolensis* was in existence in the Roman period. In 468 the Visigoths defeated the Gauls there, the victory carrying with it the supremacy over the district of Berry. In the middle ages the head of the family of Déols enjoyed the title of prince and held sway over nearly all Lower Berry, of which the town itself was the capital. In the 10th century Raoul of Déols gave his castle to the monks of the abbey and transferred his residence to Châteauroux. For centuries this change did not affect the prosperity of the place, which was maintained by the prestige of its abbey. But the burning of the abbey church by the Protestants during the religious wars and in 1622 the suppression of the abbey by the agency of Henry II., prince of Condé and of Déols, owing to the corruption of the monks, led to its decadence.

DEPARTMENT (Fr. *département*, from *départir*, to separate into parts), a division. The word is used of the branches of the administration in a state or municipality; in Great Britain it is applied to the subordinate divisions only of the great offices and boards of state, such as the bankruptcy department of the Board of Trade, but in the United States these subordinate divisions are known as "bureaus," while "department" is used of the eight chief branches of the executive.

A particular use of the word is that for a territorial division of France, corresponding loosely to an English county. Previous to the French Revolution, the local unit in France was the province, but this division was too closely bound up with the administrative mismanagement of the old régime. Accordingly, at the suggestion of Mirabeau, France was redivided on entirely new lines, the thirty-four provinces being broken up into eighty-three departments (see FRENCH REVOLUTION). The idea was to render them as nearly as possible equal to a certain average of size and population, though this was not always adhered to. They derived their names principally from rivers, mountains or other prominent geographical features. Under Napoleon the number was increased to one hundred and thirty, but in 1815 it was reduced to eighty-six. In 1860 three new departments were created out of the newly annexed territory of Savoy and Nice. In 1871 three departments (Bas-Rhin, Haut-Rhin and Moselle) were lost after the German war. Of the remains of the Haut-Rhin was formed the territory of Belfort, and the fragments of the Moselle were incorporated in the department of Meurthe, which was renamed Meurthe-et-Moselle, making the number at present eighty-seven. For a complete list of the departments see FRANCE. Each department is presided over by an officer called a *prefect*, appointed by the government, and assisted by a

prefectorial council (*conseil de préfecture*). The departments are subdivided into arrondissements, each in charge of a sub-prefect. Arrondissements are again subdivided into cantons, and these into communes, somewhat equivalent to the English parish (see FRANCE: *Local Government*).

DE PERE, a city of Brown county, Wisconsin, U.S.A., on both sides of the Fox river, 6 m. above its mouth, and 109 m. N. of Milwaukee. Pop. (1890) 3625; (1900) 4038, of whom 1025 were foreign-born; (1905, state census) 4523. It is served by the Chicago & North-Western and Chicago, Milwaukee & St Paul railways, by interurban electric lines and by lake and river steamboat lines, it being the head of lake navigation on the Fox river. Two bridges here span the Fox, which is from $\frac{1}{2}$ m. to $\frac{3}{4}$ m. in width. It is a shipping and transfer point and has paper mills, machine shops, flour mills, sash, door and blind factories, a launch and pleasure-boat factory, and knitting works, cheese factories and dairies, brick yards and grain elevators. There is an excellent water-power. De Pere is the seat of St Norbert's college (Roman Catholic, 1902) and has a public library. North of the city is located the state reformatory. On the coming of the first European, Jean Nicolet, who visited the place in 1634-1635, De Pere was the site of a polyglot Indian settlement of several thousand attracted by the fishing at the first rapids of the Fox river. Here in 1670 Father Claude Allouez established the mission of St Francis Xavier, the second in what is now Wisconsin. From the name *Rapides des Peres*, which the French applied to the place, was derived the name De Pere. Here Nicolas Perrot, the first French commandant in the North-West, established his headquarters, and Father Jacques Marquette wrote the journal of his journey to the Mississippi. A few miles south of the city lived for many years Eleazer Williams (c. 1787-1857), the alleged "lost dauphin" Louis XVII. of France and an authority on Indians, especially Iroquois. De Pere was incorporated as a village in 1857, and was chartered as a city in 1883.

DEPEW, CHAUNCEY MITCHELL (1834--), American lawyer and politician, was born in Peekskill, New York, on the 23rd of April 1834, of a Huguenot family (originally Du Puis or De Puy). He graduated at Yale in 1856, entered politics as a Whig—his father had been a Democrat—was admitted to the bar in 1858, was a member of the New York Assembly in 1861-1862, and was secretary of state of New York state in 1864-1865. He refused a nomination to be United States minister to Japan, and through his friendship with Cornelius and William H. Vanderbilt in 1866 became attorney for the New York & Harlem railway, in 1869 was appointed attorney of the newly consolidated New York Central & Hudson river railway, of which he soon became a director, and in 1875 was made general counsel for the entire Vanderbilt system of railways. He became second vice-president of the New York Central & Hudson river in 1869 and was its president in 1885-1898, and in 1898 was made chairman of the board of directors of the Vanderbilt system. In 1872 he joined the Liberal-Republican movement, and was nominated and defeated for the office of lieutenant-governor of New York. In 1888 in the National Republican convention he was a candidate for the presidential nomination, but withdrew his name in favour of Benjamin Harrison, whose offer to him in 1889 of the portfolio of state he refused. In 1899 he was elected United States senator from New York state, and in 1904 was re-elected for the term ending in 1911. His great personal popularity, augmented by his ability as an orator, suffered considerably after 1905, the inquiry into life insurance company methods by a committee of the state legislature resulting in acute criticism of his actions as a director of the Equitable Life Assurance Society and as counsel to Henry B. Hyde and his son. Among his best-known orations are that delivered at the unveiling of the Bartholdi statue of Liberty enlightening the World (1886), an address at the Washington Centennial in New York (1889), and the Columbian oration at the dedication ceremonies of the Chicago World's Fair (1892).

DEPILATORY (from Lat. *depliare*, to pull out the *pilus* or hair). any substance, preparation or process which will remove

superfluous hair. For this purpose caustic alkalis, alkaline earths and also orpiment (trisulphide of arsenic) are used, the last being somewhat dangerous. No application is permanent in its effect, as the hair always grows again. The only permanent method, which is, however, painful, slow in operation and likely to leave small scars, is by the use of an electric current for the destruction of the follicles by electrolysis.

DEPORTATION, or TRANSPORTATION, a system of punishment for crime, of which the essential factor is the removal of the criminal to a penal settlement outside his own country. It is to be distinguished from mere expulsion (*q.v.*) from a country, though the term "deportation" is now used in that sense in English law under the Aliens Act 1905 (see ALIEN). Strictly, the deportation or transportation system has ceased to exist in England, though the removal or exclusion of undesirable persons from British territory, under various Orders in Council, is possible in places subject to the Foreign Jurisdiction Acts, and in the case of criminals under the Extradition Acts.

Earlier British Transportation System.—At a time when the British statute-book bristled with capital felonies, when the pick-pocket or sheep-stealer was hanged out of hand, when Sir Samuel Romilly, to whose strenuous exertions the amelioration of the penal code is in a great measure due, declared that the laws of England were written in blood, another and less sanguinary penalty came into great favour. The deportation of criminals beyond the seas grew naturally out of the laws which prescribed banishment for certain offences. The Vagrancy Act of Elizabeth's reign contained in it the germ of transportation, by empowering justices in quarter sessions to banish offenders and order them to be conveyed into such parts beyond the seas as should be assigned by the privy council. Full effect was given to this statute in the next reign, as is proved by a letter of James I. dated 1619, in which the king directs "a hundred dissolute persons" to be sent to Virginia. Another *American plan-* act of similar tenor was passed in the reign of *tion.* Charles II., in which the term "transportation" appears to have been first used. A further and more systematic development of the system of transportation took place in 1617, when an act was passed by which offenders who had escaped the death penalty were handed over to contractors, who engaged to transport them to the American colonies. These contractors were vested with a property in the labour of the convicts for a certain term, generally from seven to fourteen years, and this right they frequently sold. Labour in those early days was scarce in the new settlements; and before the general adoption of negro slavery there was a keen competition for felon hands. An organized system of kidnapping prevailed along the British coasts; young lads were seized and sold into what was practically white slavery in the American plantations. These malpractices were checked, but the legitimate traffic in convict labour continued, until it was ended peremptorily by the revolt of the American colonies and the achievement of their independence in 1776.

The British legislature, making a virtue of necessity, discovered that transportation to the colonies was bound to be attended by various inconveniences, particularly by depriving the kingdom of many subjects whose labour might be useful to the community; and an act was accordingly passed which provides that convicts sentenced to transportation might be employed at hard labour at home. At the same time the consideration of some scheme for their disposal was entrusted to three eminent public men—Sir William Blackstone, Mr Eden (afterwards Lord Auckland) and John Howard. The result of their labours was an act for the establishment of penitentiary houses, dated 1778. This act is of peculiar importance. It contains the first public enunciation of a general principle of prison treatment, and shows that even at that early date the system since nearly universally adopted was fully understood. The object in view was thus stated. It was hoped "by sobriety, cleanliness and medical assistance, by a regular series of labour, by solitary confinement during the intervals of work and by due religious instruction to preserve and amend

¹ See J. C. Ballagh, *White Servitude in Virginia* (Baltimore, 1895.)

the health of the unhappy offenders, to inure them to habits of industry, to guard them from pernicious company, to accustom them to serious reflection and to teach them both the principles and practice of every Christian and moral duty." The experience of succeeding years has added little to these the true principles of penal discipline; they form the basis of every species of prison system carried out since the passing of an act of 1779.

No immediate action was taken by the committee appointed. Its members were not in accord as to the choice of site. One was for Idington, another for Limehouse; Howard only stipulated for some healthy place well supplied with water and conveniently situated for supervision. He was strongly of opinion that the penitentiary should be built by convict labour. Howard withdrew from the commission, and new members were appointed, who were on the eve of beginning the first penitentiary when the discoveries of Captain Cook in the South Seas turned the attention of the government towards these new lands. The vast territories

Australian penal settlements. of Australasia promised an unlimited field for convict colonization, and for the moment the scheme for penitentiary houses fell to the ground. Public opinion generally preferred the idea of establishing penal settlements at a distance from home. "There was general confidence," says Merivale in his work on colonization, "in the favourite theory that the best mode of punishing offenders was that which removed them from the scene of offence and temptation, cut them off by a great gulf of space from all their former connections, and gave them the opportunity of redeeming past crimes by becoming useful members of society." These views so far prevailed that an expedition consisting of nine transports and two men-of-war, the "first fleet" of Australian annals, sailed in March 1787 for New South Wales. This first fleet reached Botany Bay in January 1788, but passed on and landed at Port Jackson, where it entered and occupied Sydney harbour. From that time forward convicts were sent in constantly increasing numbers from England to the Antipodes. Yet the early settlement at Sydney had not greatly prospered. The infant colony had had a bitter struggle for existence. It had been hoped that the community would raise its own produce and speedily become self-supporting. But the soil was unfruitful; the convicts knew nothing of farming. All lived upon rations sent out from home; and when convoys with relief lingered by the way famine stared all in the face. The colony was long a penal settlement and nothing more, peopled only by two classes, convicts and their masters; criminal bondsmen on the one hand who had forfeited their independence and were bound to labour without wages for the state, on the other officials to guard and exact the due performance of tasks. A few free families were encouraged to emigrate, but they were lost in the mass they were intended to leaven, swamped and outnumbered by the convicts, shiploads of whom continued to pour in year after year. When the influx increased, difficulties as to their employment arose. Free settlers were too few to give work to more than a small proportion. Moreover, a new policy was in the ascendant, initiated by Governor Macquarie, who considered the convicts and their rehabilitation his chief care, and steadily discouraged the immigration of any but those who "came out for their country's good." The great bulk of the convict labour thus remained in government hands.

This period marked the first phase in the history of transportation. The penal colony, having triumphed over early dangers and difficulties, was crowded with convicts in a state of semi-freedom, maintained at the public expense and utilized in the development of the latent resources of the country. The methods employed by Governor Macquarie were not, perhaps, invariably the best; the time was hardly ripe as yet for the erection of palatial buildings in Sydney, while the congregation of the workmen in large bodies tended greatly to their demoralization. But some of the works undertaken and carried out were of incalculable service to the young colony; and its early advance in wealth and prosperity was greatly due to the magnificent roads, bridges and other facilities of inter-communication for which it was indebted to Governor Macquarie. As time passed the criminal sewage flowing from the Old World to the New greatly increased in

volume under milder and more humane laws. Many now escaped the gallows, and much of the overcrowding of the gaols at home was caused by the gangs of convicts awaiting transhipment to the Antipodes. They were packed off, however, with all convenient despatch, and the numbers on government hands in the colonies multiplied exceedingly, causing increasing embarrassment as to their disposal. Moreover, the expense of the Australasian convict establishments was enormous.

Some change in system was inevitable, and the plan of "assignment" was introduced; in other words, that of freely lending the convicts to any who would relieve the authorities of the burdensome charge. By this time free settlers were arriving in greater number, invited by a different and more liberal policy than that of Governor Macquarie. *Assignment system.* Inducements were especially offered to persons possessed of capital to assist in the development of the country. Assignment developed rapidly; soon eager competition arose for the convict hands that had been at first so reluctantly taken. Great facilities existed for utilizing them on the wide areas of grazing land and on the new stations in the interior. A pastoral life, without temptations and contaminating influences, was well suited for convicts. As the colony grew richer and more populous, other than agricultural employers became assignees, and numerous enterprises were set on foot. The trades and callings which minister to the needs of all civilized communities were more and more largely pursued. There was plenty of work for skilled convicts in the towns, and the services of the more intelligent were highly prized. It was a great boon to secure gratis the assistance of men specially trained as clerks, book-keepers or handicraftsmen. Hence all manner of intrigues and manoeuvres were afoot on the arrival of drafts and there was a scramble for the best hands. Here at once was a palpable flaw in the system of assignment. The lot of the convict was altogether unequal. Some, the dull, unlettered and unskilled, were drafted up country to heavy manual labour at which they remained, while clever expert rogues found pleasant, congenial and often profitable employment in the towns. The contrast was very marked from the first, but it became the more apparent when in due course it was seen that some were still engaged in irksome toil, while others who had come out by the same ship had already attained to affluence and ease. For the latter transportation was no punishment, but often the reverse. It meant too often transfer to a new world under conditions more favourable to success, removed from the keener competition of the old. By adroit management, too, convicts often obtained the command of funds, the product of nefarious transactions at home, which wives or near relatives or unconvicted accomplices presently brought out to them. It was easy for the free new-comers to secure the assignment of their convict friends; and the latter, although still nominally servants and in the background, at once assumed the real control. Another system productive of much evil was the employment of convict clerks in positions of trust in various government offices; convicts did much of the legal work of the colony; a convict was clerk to the attorney general; others were schoolmasters and were entrusted with the education of youth.

Under a system so anomalous and uncertain the main object of transportation as a method of penal discipline and repression was in danger of being quite overlooked. Yet the state could not entirely abdicate its functions, although it surrendered to a great extent the care of criminals to private persons. It had established a code of penalties for the coercion of the ill-conducted, while it kept the worst perforce in its own hands. The master was always at liberty to appeal to the strong arm of the law. A message carried to a neighbouring magistrate, often by the culprit himself, brought down the prompt retribution of the lash. Convicts might be flogged for petty offences, for idleness, drunkenness, turbulence, absconding and so forth. At the out-stations some show of decorum and regularity was observed, although the work done was generally scanty and the convicts were secretly given to all manner of evil courses. The town convicts were worse, because they were far less controlled. They were nominally under the

Evils of convict system.

surveillance and supervision of the police, which amounted to nothing at all. They came and went, and amused themselves after working hours, so that Sydney and all the large towns were hotbeds of vice and immorality. The masters as a rule made no attempt to watch over their charges; many of them were absolutely unfitted to do so, being themselves of low character, "emancipists" frequently, old convicts conditionally pardoned or who had finished their terms. No effort was made to prevent the assignment of convicts to improper persons; every applicant got what he wanted, even though his own character would not bear inspection. All whom the masters could not manage—the incorrigible upon whom the lash and bread and water had been tried in vain—were returned to government charge. These, in short, comprised the whole of the refuse of colonial convictdom. Every man who could not agree with his master, or who was to undergo a penalty greater than flogging or less than capital punishment, came back to government and was disposed of in one of three ways, (1) the road parties, (2) the chain gang, or (3) the penal settlements. (1) In the first case, the convicts might be kept in the vicinity of the towns or marched about the country according to the work in hand; the labour was severe, but, owing to inefficient supervision, never intolerable; the diet was ample and there was no great restraint upon independence within certain wide limits. To the slackness of control over the road parties was directly traceable the frequent escape of desperadoes, who, defying recapture, recruited the gangs of bushrangers which were a constant terror to the whole country. In (2) the chain or iron gangs, as they were sometimes styled, discipline was far more rigorous. It was maintained by the constant presence of a military guard, and when most efficiently organized the gang was governed by a military officer who was also a magistrate. The work was really hard, the custody close—in hulk, stockaded barrack or caravan; the first was at Sydney, the second in the interior, the last when the undertaking required constant change of place. All were locked up from sunset to sunrise; all wore heavy leg irons; and all were liable to immediate flagellation. The convict "scourger" was one of the regular officials attached to every chain gang. (3) The third and ultimate receptacle was the penal settlement, to which no offenders were transferred till all other methods of treatment had failed. These were terrible cesspools of iniquity, so bad that it seemed, to use the words of one who knew them well, that "the heart of a man who went to them was taken from him and he was given that of a beast." The horrors accumulated at Norfolk Island, Moreton Bay, Port Arthur and Tasman's Peninsula are almost beyond description. The convicts herded together in them were soon utterly degraded and brutalized; no wonder that reckless despair took possession of them, that death on the gallows for murder purposely committed, or the slow terror from starvation following escape into surrounding wilds was often welcomed as a relief.

The stage which transportation was now reaching and the actual condition of affairs in the Australian colonies about this period do not appear to have been much understood in England. Earnest and thoughtful men might busy themselves with prison discipline at home, and the legislature might watch with peculiar interest the results obtained from the special treatment of a limited number of selected offenders in Millbank penitentiary. But for the great mass of criminality deported to a distant shore no very active concern was shown. The country for a long time seemed satisfied with transportation. Portions of the system might be open to criticism. Thus the Commons committee of 1832 freely condemned the hulks at Woolwich and other arsenals in which a large number of convicts were kept while waiting embarkation. It was reported that the indiscriminate association of prisoners in them produced more vice, profaneness and demoralization than in the ordinary prisons. After dark the wildest orgies went on unchecked—dancing, fighting, gambling, singing and so forth; it was easy to get drink and tobacco and to see friends from outside. The labour hours were short and the tasks light; "altogether the situation of the convict in the hulks," says the report, "cannot be considered penal; it is a state of restriction, but hardly of punishment."

But no objection was raised to transportation. It was considered by this same committee "a most valuable expedient in the system of secondary punishment." They only thought it necessary to suggest that exile should be preceded by a period of severe probationary punishment in England, a proposal which was reiterated later on and actually adopted. It was in the country most closely affected that dissatisfaction first began to find voice. Already in 1832 the most reputable sections of Australian society were beginning to murmur grievously. Transportation had fostered the growth of a strong party—that representing convict views—and these were advocated boldly in unprincipled prints. This party, constantly recruited from the emancipists and ticket-of-leave holders, gradually grew very numerous, and threatened soon to swamp the honest and untainted parts of the community. As years passed the prevalence of crime, and the universally low tone of morality due to the convict element, became more and more in the ascendant. At length in 1835 Judge Burton made a loud protest, and in a charge to the grand jury of Sydney plainly intimated that transportation must cease. While it existed, he said, the colonies could never rise to their proper position; they could not claim free institutions. This bold but forcible language commanded attention. It was speedily echoed in England, and particularly by Archbishop Whately, who argued that transportation failed in all the leading requisites of any system of secondary punishment. Transportation exercised no salutary terror in offenders; it was no longer exile to an unknown inhospitable region, but to one flowing with milk and honey, whither innumerable friends and associates had gone already. The most glowing descriptions came back of the wealth which any clever fellow might easily amass; stories were told and names mentioned of those who had made ample fortunes in Australia in a few years. As a matter of fact the convicts, or at least large numbers of them, had prospered exceedingly. Some had incomes of twenty, thirty, even forty thousand pounds a year. The deteriorating effects of the system were plainly manifest on the surface from the condition of the colony,—the profligacy of the towns, the scant reprobation of crimes and those who had committed them. Down below, in the openly sanctioned slavery called assignment, in the demoralizing chain gangs and in the inexpressibly horrible penal settlements, were more abundant and more awful proofs of the general wickedness and corruption. Moreover these appalling results were accompanied by colossal expenditure. The cost of the colonial convict establishments, with the passages out, amounted annually to upwards of £300,000; another £100,000 was expended on the military garrisons; and various items brought the whole outlay to about half a million per annum. It may be argued that this was not a heavy price to pay for peopling a continent and laying the foundations of a vast Australasian empire. But that empire could never have expanded to its present dimensions if it had depended on convict immigration alone. There was a point, too, at which all development, all progress, would have come to a full stop had it not been relieved of its stigma as a penal colony.

That point was reached between 1835 and 1840, when a powerful party came into existence in New South Wales, pledged to bring about the abandonment of transportation. A strongly hostile feeling was also gaining ground in England. In 1837 a new committee of the House of Commons had made a patient and searching investigation into the merited demerits of the system and freely condemned it. The government had no choice but to give way; it could not ignore the protests of the colonists, backed up by such an authoritative expression of opinion. In 1840 orders were issued to suspend the deportation of criminals to New South Wales. But what was to become of the convicts? It was impossible to keep them at home. The hulks which might have served had also failed; the faultiness of their internal management had been fully proved. The committee had recommended the erection of more penitentiaries. But the costly experiment of Millbank had been barren of results. The model prison at Pentonville, in process of construction under the pressure of a

Australian
objec-
tion.

Return
move-
ment.

movement towards prison reform, could offer but limited accommodation. A proposal was put forward to construct convict barracks in the vicinity of the great arsenals; but this, which contained really the germ of the present British penal system, was premature. The government in this dilemma steered a middle course and resolved to adhere to transportation, but under a greatly modified and it was hoped much improved form. The colony of Van Diemen's Land, younger and less self-reliant than its neighbour, had also endured convict immigration but had made no protest. It was resolved to direct the whole stream of deportation upon Van Diemen's Land, which was thus constituted one vast colonial prison. The main principle of the new system was one of probation; hence its name. All convicts were to pass through various stages and degrees of punishment according to their conduct and character. Some general depot was needed where the necessary observation could be made, and it was found at Millbank penitentiary. Thence boys were sent to the prison for juveniles at Parkhurst; the most promising subjects among the adults were selected to undergo the experimental discipline of solitude and separation at Pentonville; less hopeful cases went to the hulks; and all adults alike passed on to the Antipodes. Fresh stages awaited the convict on his arrival at Van Diemen's Land. The first was limited to "lifers" and colonial convicts sentenced a second time. It consisted in detention at one of the penal stations, either Norfolk Island or Tasman's Peninsula, where the disgraceful conditions already described continued unchanged to the very last. The second stage received the largest number, who were subjected in it to gang labour, working under restraint in various parts of the colony. These probation stations, as they were called, were intended to inculcate habits of industry and subordination; they were provided with supervisors and religious instructors; and had they not been tainted by the vicious virus brought to them by others arriving from the penal stations, they might have answered their purpose for a time. But they became as bad as the worst of the penal settlements and contributed greatly to the breakdown of the whole system. The third stage and the first step towards freedom was the concession of a pass which permitted the convict to be at large under certain conditions to seek work for himself; the fourth was a ticket-of-leave, the possession of which allowed him to come and go much as he pleased; the fifth and last was absolute pardon, with the prospects of rehabilitation.

This scheme seemed admirable on paper; yet it failed completely when put into practice. Colonial resources were quite unable to bear the pressure. Within two or three years Van Diemen's Land was inundated with convicts. Sixteen thousand were sent out in four years; the average annual number in the colony was about 30,000, and this when there were only 37,000 free settlers. Half the whole number of convicts remained in government hands and were kept in the probation gangs, engaged upon public works of great utility; but the other half, pass-holders and ticket-of-leave men in a state of semi-freedom, could get little or no employment. The supply greatly exceeded the demand; there were no hirers of labour. Had the colony been as large and as prosperous as its neighbour it could scarcely have absorbed the glut of workmen; but it was really on the verge of bankruptcy—its finances were embarrassed, its trades and industries at a standstill. But not only were the convicts idle; they were utterly depraved. It was soon found that the system which kept large bodies always together had a most pernicious effect upon their moral condition. "The congregation of criminals in large batches without adequate supervision meant simply wholesale, widespread pollution," as was said at the time. These ever-present and constantly increasing evils forced the government to reconsider its position; and in 1846 transportation to Van Diemen's Land was temporarily suspended for a couple of years, during which it was hoped some relief might be afforded. The formation of a new convict colony in North Australia had been contemplated; but the project, warmly espoused by Mr Gladstone, then under-secretary of state for the colonies, was presently abandoned; and it now became clear

that no resumption of transportation was possible. The measures taken to substitute other methods of secondary punishment are set forth in the article PRISON (*g.v.*).

France.—France adopted deportation for criminals as far back as 1763, when a penal colony was founded in French Guiana and failed disastrously. An expedition was sent there, composed of the most evil elements of the Paris population and numbering 14,000, all of whom died. The attempt was repeated in 1766 and with the same miserable result. Other failures are recorded, the worst being the scheme of the philanthropist Baron Milius, who in 1823 planned to form a community on the banks of the Mana (French Guiana) by the marriage of exiled convicts and degraded women, which resulted in the most ghastly horrors. The principle of deportation was then formally condemned by publicists and government until suddenly in 1854 it was reintroduced into the French penal code with many high-sounding phrases. Splendid results were to be achieved in the creation of rich colonies afar, and the regeneration of the criminal by new openings in a new land. The only outlet available at the moment beyond the sea was French Guiana, and it was again to be utilized despite its pestilential climate. Thousands were exiled, more than half to find certain death; none of the penal settlements prospered. No return was made by agricultural development, farms and plantations proved a dead loss under the unfavourable conditions of labour enforced in a malarious climate and unkindly soil, and it was acknowledged by French officials that the attempt to establish a penal colony on the equator was utterly futile. Deportation to Guiana was not abandoned, but instead of native-born French exiles, convicts of subject races, Arabs, Anamites and Asiatic blacks, were sent exclusively, with no better success as regards colonization.

In 1864, however, it was possible to divert the stream elsewhere. New Caledonia in the Australian Pacific was annexed to France in 1853. Ten years later it became a new settlement for convict emigrants. A first shipload was disembarked in 1864 at Noumea, and the foundations of the city laid. Prison buildings were the first erected and were planted upon the island of Nou, a small breakwater to the Bay of Noumea. Outwardly all went well under the fostering care of the authorities. The population steadily increased; an average total of 600 in 1867 rose in the following year to 1554. In 1874 the convict population exceeded 5000; in 1880 it had risen to 8000; the total reached 9008 at the end of December 1883. But from that time forward the numbers transported annually fell, for it was found that this South Pacific island, with its fertile soil and fairly temperate climate, by no means intimidated the dangerous classes; and the French administration therefore resumed deportation of French-born whites to Guiana, which was known as notoriously unhealthy and was likely to act as a more positive deterrent. The authorities divided their exiles between the two outlets, choosing New Caledonia for the convicts who gave some promise of regeneration, and sending criminals with the worst antecedents and presumably incorrigible to the settlements on the equator. This was in effect to hand over a fertile colony entirely to criminals. Free immigration to New Caledonia was checked, and the colony became almost exclusively penal. The natural growth of a prosperous colonial community made no advance, and convict labour did little to stimulate it, the public works, essential for development, and construction of roads were neglected; there was no extensive clearance of lands, no steady development of agriculture. From 1898 simple deportation practically ceased, but the islands were full of convicts already sent, and they still received the product of the latest invention in the criminal code known as "relegation," a punishment directed against the recidivist or incorrigible criminal whom no penal retribution had hitherto touched and whom the French law felt justified in banishing for ever to the "back of beyond." A certain period of time spent in a hard labour prison preceded relegation, but the convicts on arrival were generally unfitted to assist in colonization. They were for the most part decadent, morally and physically; their labour was of no substantial value to

colonists or themselves, and there was small hope of profitable result when they gained conditional liberation, with a concession of colonial land and a possibility of rehabilitation by their own efforts abroad, for by their sentence they were forbidden to hope for return to France. The punishment of relegation was not long in favour, the number of sentences to it fell year after year, and it has now been practically abandoned.

Other Countries.—Penal exile has been practised by some other countries as a method of secondary punishment. Russia since 1823 has directed a stream of offenders, mainly political, upon Siberia, and at one time the yearly average sent was 18,000. The Siberian exile system, the horrors of which cannot be exaggerated, belongs only in part to penitentiary science, but it was very distinctly punitive and aimed at regeneration of the individual and the development of the soil by new settlements. Although the journey was made mostly on foot and not by sea transport, the principle of deportation (or more exactly of removal) was the essence of the system. The later practice, however, has been exactly similar to transportation as originated by England and afterwards followed by France. The penal colonization of the island of Sakhalin reproduced the preceding methods, and the Russian convicts were conveyed by ships through the Suez Canal to the Far East. Sakhalin was hopefully intended as an outlet for released convicts and their rehabilitation by their own efforts, precisely in the manner tried in Australia and New Caledonia. The result repeated previous experiences. There was land to reclaim, forests to cut down, marshes to drain, everything but a temperate climate and a good will of the felon labourers to create a prosperous colony. But the convicts would not work; a few sought to win the right to occupy a concession of soil, but the bulk were pure vagabonds, wandering to and fro in search of food. The agricultural enterprise was a complete failure. The wrong sites for cultivation were chosen, the labourers were unskilled and they handled very indifferent tools. Want amounting to constant starvation was a constant rule; the rations were insufficient and unwholesome, very little meat eked out with salt fish and with entire absence of vegetables. The general tone of morals was inconceivably low, and a universal passion for alcohol and card-playing prevailed. According to one authority the life of the convicts at Sakhalin was a frightful nightmare, "a mixture of debauchery and innocence mixed with real sufferings and almost inconceivable privations, corrupt in every one of its phases." The prisons hopelessly ruined all who entered them, all classes were indiscriminately herded together. It is now generally allowed that deportation, as practised, had utterly failed, the chief reasons being the unmanageable numbers sent and the absence of outlets for their employment, even at great cost.

The prisons on Sakhalin have been described as hotbeds of vice; the only classification of prisoners is one based on the length of sentence. Some imperfect attempt is made to separate those waiting trial from the recidivist or hardened offender, but too often the association is indiscriminate. Prison discipline is generally slack and ineffective, the staff of warders, from ill-judged economy, too weak to supervise or control. The officers themselves are of inferior stamp, drunken, untrustworthy, overbearing, much given to "trafficking" with the prisoners, accepting bribes to assist escape, quick to misuse and oppress their charges. Crime of the worst description is common.

Italy has practised deportation in planting various agricultural colonies upon the islands to be found on her coast. They were meant to imitate the intermediate prisons of the Irish system, where prisoners might work out their redemption, when provisionally released. Two were established on the islands of Pianoso and Gorgona, and there were settlements made on Monte Christo and Capraia. They were used also to give effect to the system of enforced residence or *domicilio coatto*.

Portugal also has tried deportation to the African colony of Angola on a small scale with some success, and combined it with free emigration. The settlers have been represented as well disposed towards the convicts, gladly obtaining their

services or helping them in the matter of security. The convict element is orderly, and, although their treatment is "penal repressive et relativement débonnaire," few commit offences.

The Andaman Islands have been utilized by the Indian government since the mutiny (1857) for the deportation of heinous criminals (see ANDAMAN ISLANDS).

AUTHORITIES.—Captain A. Phillip, R.N., *The Voyage of Governor Phillip to New South Wales* (1790); David Collins, *Account of the English Colony of New South Wales* (1798); Archbishop Whately, *Remarks on Transportation* (1834); Herman Merivale, *Colonisation and Colonies* (1841); d'Haussonville, *Établissements pénitentiaires en France et aux colonies* (1875); George Griffith, *In a Prison Land*; Cuche, *Science et législation pénitentiaires* (1905); Hawes, *The Utmost East* (1906). (A. G.)

DEPOSIT (Lat. *depositum*, from *deponere*, to lay down, to put in the care of), anything laid down or separated; as in geology, any mass of material accumulated by a natural agency (see BED), and in chemistry, a precipitate or matter settling from a solution or suspension. In banking, a deposit may mean, generally, a sum of money lodged in a bank without regard to the conditions under which it is held, but more specially money lodged with a bank on "deposit account" and acknowledged by the banker by a "deposit receipt" given to the depositor. It is then not drawn upon by cheque, usually bears interest at a rate varying from time to time, and can only be withdrawn after fixed notice. Deposit is also used in the sense of earnest or security for the performance of a contract. In the law of mortgage the deposit of title-deeds is usual as a security for the repayment of money advanced. Such a deposit operates as an equitable mortgage. In the law of contract, deposit or simple bailment is delivery or bailment of goods in trust to be kept without recompense, and redelivered on demand (see BAILMENT).

DEPOT (from the Fr. *dépot*, Lat. *depositum*, laid down; the French accent marks are usually dispensed with in English), a place where things may be stored or deposited, such as a furniture or forage depot, the accumulation of military stores, especially in the theatre of operations. In America the word is used of a railway station, whether for passengers or goods; in Great Britain on railways the word, when in use, is applied to goods stations. A particular military application is to a depot, situated as a rule in the centre of the recruiting district of the regiment or other unit, where recruits are received and undergo the necessary preliminary training before joining the active troops. Such depots are maintained in peace time by all armies which have to supply distant or oversea garrisons; in an army raised by compulsory service and quartered in its own country, the regiments are usually stationed in their own districts, and on their taking the field for war leave behind a small nucleus for the formation and training of drafts to be sent out later. These nucleus troops are generally called depot troops.

DEPRETIS, AGOSTINO (1813-1887), Italian statesman, was born at Mezzana Corte, in the province of Stradella on the 31st of January 1813. From early manhood a disciple of Mazzini and affiliated to the *Gionane Italia*, he took an active part in the Mazzinian conspiracies and was nearly captured by the Austrians while smuggling arms into Milan. Elected deputy in 1848, he joined the Left and founded the journal *Il Diritto*, but held no official position until appointed governor of Brescia in 1859. In 1860 he went to Sicily on a mission to reconcile the policy of Cavour (who desired the immediate incorporation of the island in the kingdom of Italy) with that of Garibaldi, who wished to postpone the Sicilian *plebiscite* until after the liberation of Naples and Rome. Though appointed pro-dictator of Sicily by Garibaldi, he failed in his attempt. Accepting the portfolio of public works in the Rattazzi cabinet in 1862, he served as intermediary in arranging with Garibaldi the expedition which ended disastrously at Aspromonte. Four years later, on the outbreak of war against Austria, he entered the Ricasoli cabinet as minister of marine, and, by maintaining Admiral Persano in command of the fleet, contributed to the defeat of Lissa. His apologists contend, however, that, as an inexperienced civilian, he could not have made sudden changes in naval arrangements without disorganizing the fleet, and that in view of the impending hostilities he was

obliged to accept the dispositions of his predecessors. Upon the death of Rattazzi in 1873, Depretis became leader of the Left, prepared the advent of his party to power, and was called upon to form the first cabinet of the Left in 1876. Overthrown by Cairoli in March 1878 on the grist-tax question, he succeeded, in the following December, in defeating Cairoli, became again premier, but on the 3rd of July 1879 was once more overturned by Cairoli. In November 1879 he, however, entered the Cairoli cabinet as minister of the interior, and in May 1881 succeeded to the premiership, retaining that office until his death on the 20th of July 1887. During the long interval he recomposed his cabinet four times, first throwing out Zanardelli and Baccarini in order to please the Right, and subsequently bestowing portfolios upon Ricotti, Robilant and other Conservatives, so as to complete the political process known as "trasformismo." A few weeks before his death he repented of his transformist policy, and again included Crispi and Zanardelli in his cabinet. During his long term of office he abolished the grist tax, extended the suffrage, completed the railway system, aided Mancini in forming the Triple Alliance, and initiated colonial policy by the occupation of Massawa; but, at the same time, he vastly increased indirect taxation, corrupted and destroyed the fibre of parliamentary parties, and, by extravagance in public works, impaired the stability of Italian finance.

DEPTFORD, a south-eastern metropolitan borough of London, England, bounded N. by Bermondsey, E. by the river Thames and Greenwich, S. by Lewisham and W. by Camberwell. Pop. (1901) 110,398. The name is connected with a ford over the Ravensbourne, a stream entering the Thames through Deptford Creek. The borough comprises only the parish of Deptford St Paul, that of Deptford St Nicholas being included in the borough of Greenwich. Deptford is a district of poor streets, inhabited by a large industrial population, employed in engineering and other riverside works. On the river front, extending into the borough of Greenwich, are the royal victualling yard and the site of the old Deptford dockyard. The first supplies the navy with provisions, medicines, furniture, &c., manufactured or stored in the large warehouses here. The dockyard ceased to be used in 1869, and was filled up and converted into a foreign cattle market by the City Corporation. Of public buildings the most noteworthy are St Paul's church (1730), of classic design; the municipal buildings; and the hospital for master mariners, maintained by the corporation of the Trinity House, which was founded at Deptford, the old hall being pulled down in 1787. Other institutions are the Goldsmiths' Polytechnic Institute, New Cross; and the South-eastern fever hospital. A mansion known as Sayes Court, taken down in 1729, was the residence of the duke of Sussex in the reign of Elizabeth; it was occupied in the following century by John Evelyn, author of *Sylva*, and by Peter the Great during his residence in England in 1698. The site of its gardens is occupied by Deptford Park of 11 acres. Another open space is Telegraph Hill (9½ acres). The parliamentary borough of Deptford returns one member. The borough council consists of a mayor, 6 aldermen, and 36 councillors. Area, 1562·7 acres.

DEPUTY (through the Fr. from a Late Lat. use of *deputare*, to cut off, allot; *putare* having the original sense of to trim, prune), one appointed to act or govern instead of another; one who exercises an office in another man's right, a substitute; in representative government a member of an elected chamber. In general, the powers and duties of a deputy are those of his principal (see also REPRESENTATION), but the extent to which he may exercise them is dependent upon the power delegated to him. He may be authorized to exercise the whole of his principal's office, in which case he is a general deputy, or to act only in some particular matter or service, when he is termed a special deputy. In the United Kingdom various officials are specifically empowered by statute to appoint deputies to act for them under certain circumstances. Thus a clerk of the peace, in case of illness, incapacity or absence, may appoint a fit person to act as his deputy. While judges of the supreme court cannot act by deputy, county court judges and recorders can, in cases of illness

or unavoidable absence, appoint deputies. So can registrars of county courts and returning officers at elections.

DE QUINCEY, THOMAS (1785–1859), English author, was born at Greenheys, Manchester, on the 15th of August 1785. He was the fifth child in a family of eight (four sons and four daughters). His father, descended from a Norman family, was a merchant, who left his wife and six children a clear income of £1600 a year. Thomas was from infancy a shy, sensitive child, with a constitutional tendency to dreaming by night and by day; and, under the influence of an elder brother, a lad "whose genius for mischief amounted to inspiration," who died in his sixteenth year, he spent much of his boyhood in imaginary worlds of their own creating. The amusements and occupations of the whole family, indeed, seem to have been mainly intellectual; and in De Quincey's case, emphatically, "the child was father to the man." "My life has been," he affirms in the *Confessions*, "on the whole the life of a philosopher; from my birth I was made an intellectual creature, and intellectual in the highest sense my pursuits and pleasures have been." From boyhood he was more or less in contact with a polished circle; his education, easy to one of such native aptitude, was sedulously attended to. When he was in his twelfth year the family removed to Bath, where he was sent to the grammar school, at which he remained for about two years; and for a year more he attended another public school at Winkfield, Wiltshire. At thirteen he wrote Greek with ease; at fifteen he not only composed Greek verses in lyric measures, but could converse in Greek fluently and without embarrassment; one of his masters said of him, "that boy could harange an Athenian mob better than you or I could address an English one." Towards the close of his fifteenth year he visited Ireland, with a companion of his own age, Lord Westport, the son of Lord Altamont, an Irish peer, and spent there in residence and travel some months of the summer and autumn of the year 1800,—being a spectator at Dublin of "the final ratification of the bill which united Ireland to Great Britain." On his return to England, his mother having now settled at St John's Priory, a residence near Chester, De Quincey was sent to the Manchester grammar school, mainly in the hope of securing one of the school exhibitions to help his expenses at Oxford.

Discontented with the mode in which his guardians conducted his education, and with some view apparently of forcing them to send him earlier to college, he left this school after less than a year's residence—ran away, in short, to his mother's house. There his mother's brother, Colonel Thomas Penson, made an arrangement for him to have a weekly allowance, on which he might reside at some country place in Wales, and pursue his studies, presumably till he could go to college. From Wales, however, after brief trial, "suffering grievously from want of books," he went off as he had done from school, and hid himself from guardians and friends in the world of London. And now, as he says, commenced "that episode, or impassioned parenthesis of my life, which is comprehended in *The Confessions of an English Opium Eater*." This London episode extended over a year or more; his money soon vanished, and he was in the utmost poverty; he obtained shelter for the night in Greek Street, Soho, from a moneylender's agent, and spent his days wandering in the streets and parks; finally the lad was reconciled to his guardians, and in 1803 was sent to Worcester College, Oxford, being by this time about nineteen. It was in the course of his second year at Oxford that he first tasted opium,—having taken it to allay neuralgic pains. De Quincey's mother had settled at Weston Lea, near Bath, and on one of his visits to Bath, De Quincey made the acquaintance of Coleridge; he took Mrs Coleridge to Grasmere, where he became personally acquainted with Wordsworth.

After finishing his career of five years at college in 1808 he kept terms at the Middle Temple; but in 1809 visited the Wordsworths at Grasmere, and in the autumn returned to Dove Cottage, which he had taken on a lease. His choice was of course influenced partly by neighbourhood to Wordsworth, whom he early appreciated,—having been, he says, the only man

in all Europe who quoted Wordsworth so early as 1802. His friendship with Wordsworth decreased within a few years, and when in 1834 De Quincey published in *Tait's Magazine* his reminiscences of the Grasmere circle, the indiscreet references to the Wordsworths contained in the article led to a complete cessation of intercourse. Here also he enjoyed the society and friendship of Coleridge, Southey and especially of Professor Wilson, as in London he had of Charles Lamb and his circle. He continued his classical and other studies, especially exploring the at that time almost unknown region of German literature, and indicating its riches to English readers. Here also, in 1816, he married Margaret Simpson, the "dear M—" of whom a charming glimpse is accorded to the reader of the *Confessions*; his family came to be five sons and three daughters.

For about a year and a half he edited the *Westmorland Gazette*. He left Grasmere for London in the early part of 1820. The Lambs received him with great kindness and introduced him to the proprietors of the *London Magazine*. It was in this journal in 1821 that the *Confessions* appeared. De Quincey also contributed to *Blackwood*, to *Knights' Quarterly Magazine*, and later to *Tait's Magazine*. His connexion with *Blackwood* took him to Edinburgh in 1828, and he lived there for twelve years, contributing from time to time to the *Edinburgh Literary Gazette*. His wife died in 1837, and the family eventually settled at Lasswade, but from this time De Quincey spent his time in lodgings in various places, staying at one place until the accumulation of papers filled the rooms, when he left them in charge of the landlady and wandered elsewhere. After his wife's death he gave way for the fourth time in his life to the opium habit, but in 1844 he reduced his daily quantity by a tremendous effort to six grains, and never again yielded. He died in Edinburgh on the 8th of December 1850, and is buried in the West Churchyard.

During nearly fifty years De Quincey lived mainly by his pen. His patrimony seems never to have been entirely exhausted, and his habits and tastes were simple and inexpensive; but he was reckless in the use of money, and had debts and pecuniary difficulties of all sorts. There was, indeed, his associates affirm, an element of romance even in his impecuniosity, as there was in everything about him; and the diplomatic and other devices by which he contrived to keep clear of clamant creditors, while scrupulously fulfilling many obligations, often disarmed animosity, and converted annoyance into amusement. The famous *Confessions of an English Opium Eater* was published in a small volume in 1822, and attracted a very remarkable degree of attention, not simply by its personal disclosures, but by the extraordinary power of its dream-painting. No other literary man of his time, it has been remarked, achieved so high and universal a reputation from such merely fugitive efforts. The only works published separately (not in periodicals) were a novel, *Klosterheim* (1832), and *The Logic of Political Economy* (1844). After his works were brought together, De Quincey's reputation was not merely maintained, but extended. For range of thought and topic, within the limits of pure literature, no like amount of material of such equality of merit proceeded from any eminent writer of the day. However profuse and discursive, De Quincey is always polished, and generally exact—a scholar, a wit, a man of the world and a philosopher, as well as a genius. He looked upon letters as a noble and responsible calling; in his essay on Oliver Goldsmith he claims for literature the rank not only of a fine art, but of the highest and most potent of fine arts; and as such he himself regarded and practised it. He drew a broad distinction between "the literature of *knowledge* and the literature of *power*," asserting that the function of the first is to *teach*, the function of the second to *move*,—maintaining that the meaneast of authors who moves has pre-eminence over all who merely teach, that the literature of knowledge must perish by supersession, while the literature of power is "triumphant for ever as long as the language exists in which it speaks." It is to this class of motive literature that De Quincey's own works essentially belong; it is by virtue of that vital element of power that they have emerged from the rapid oblivion of periodicalism, and live in the minds of later generations. But their power is weakened by their volume.

De Quincey fully defined his own position and claim to distinction in the preface to his collected works. These he divides into three classes:—"first, that class which proposes primarily to amuse the reader," such as the *Narratives*, *Autobiographic Sketches*, &c.; "second, papers which address themselves purely to the understanding as an insulated faculty, or do so primarily," such as the essays on *Essenism*, the *Caesars*, *Cicero*, &c.; and finally, as a *third* class, "and, in virtue of their aim, as a far higher class of compositions," he ranks those "modes of impassioned prose ranging under no precedents that I am aware of in any literature," such as the *Confessions* and *Suspensio de Profundis*. The high claim here asserted has been questioned; and short and isolated examples of eloquent apostrophe, and highly wrought imaginative description, have been cited from Rousseau and other masters of style; but De Quincey's power of sustaining a fascinating and elevated strain of "impassioned prose" is allowed to be entirely his own. Nor, in regard to his writings as a whole, will a minor general claim which he makes be disallowed, namely, that he "does not write without a thoughtful consideration of his subject," and also with novelty and freshness of view. "Generally," he says, "I claim (not arrogantly, but with firmness) the merit of rectification applied to absolute errors, or to injurious limitations of the truth." Another obvious quality of all his genius is its overflowing fullness of allusion and illustration, recalling his own description of a great philosopher or scholar—"Not one who depends simply on an infinite memory, but also on an infinite and electrical power of combination, bringing together from the four winds, like the angel of the resurrection, what else were dust from dead men's bones into the unity of breathing life." It is useless to complain of his having lavished and diffused his talents and acquirements over so vast a variety of often comparatively trivial and passing topics. The world must accept gifts from men of genius as they offer them; circumstance and the hour often rule their form. Those influences, no less than the idiosyncrasy of the man, determined De Quincey to the illumination of such matter for speculation as seemed to lie before him; he was not careful to search out recondite or occult themes, though these he did not neglect,—a student, a scholar and a recluse, he was yet at the same time a man of the world, keenly interested in the movements of men and in the page of history that unrolled itself before him day by day. To the discussion of things new, as readily as of things old, aided by a capacious, retentive and ready memory, which dispensed with reference to printed pages, he brought also the exquisite keenness and subtlety of his highly analytic and imaginative intellect, the illustrative stores of his vast and varied erudition, and that large infusion of common sense which preserved him from becoming at any time a mere *doctrinaire*, or visionary. If he did not throw himself into any of the great popular controversies or agitations of the day, it was not from any want of sympathy with the struggles of humanity or the progress of the race, but rather because his vocation was to apply to such incidents of his own time, as to like incidents of all history, great philosophical principles and tests of truth and power. In politics, in the party sense of that term, he would probably have been classed as a Liberal Conservative or Conservative Liberal—at one period of his life perhaps the former, and at a later the latter. Originally, as we have seen, his surroundings were aristocratic, in his middle life his associates, notably Wordsworth, Southey and Wilson, were all Tories; but he seems never to have held the extreme and narrow views of that circle. Though a flavour of high breeding runs through his writings, he has no vulgar sneers at the vulgar. As he advanced in years his views became more and more decidedly liberal, but he was always as far removed from Radicalism as from Toryism, and may be described as a philosophical politician, capable of classification under no definite party name or colour. Of political economy he had been an early and earnest student, and projected, if he did not so far proceed with, an elaborate and systematic treatise on the science, of which all that appears, however, are his fragmentary *Dialogues* on the system of Ricardo, published in the *London Magazine* in 1824, and *The Logic of Political Economy* (1844). But political

and economic problems largely exercised his thoughts, and his historical sketches show that he is constantly alive to their interpenetrating influence. The same may be said of his biographies, notably of his remarkable sketch of Dr Parr. Neither politics nor economics, however, exercised an absorbing influence on his mind,—they were simply provinces in the vast domain of universal speculation through which he ranged "with unconfined wings." How wide and varied was the region he traversed a glance at the titles of the papers which make up his collected—or more properly, selected—works (for there was much matter of evanescent interest not reprinted) sufficiently shows. Some things in his own line he has done perfectly; he has written many pages of magnificently mixed argument, irony, humour and eloquence, which, for sustained brilliancy, richness, subtle force and purity of style and effect, have simply no parallels; and he is without peer the prince of dreamers. The use of opium no doubt stimulated this remarkable faculty of reproducing in skillfully selected phrase the grotesque and shifting forms of that "cloudland, gorgeous land," which opens to the sleep-closed eye.

To the appreciation of De Quincey the reader must bring an imaginative faculty somewhat akin to his own—a certain general culture, and large knowledge of books, and men and things. Otherwise much of that slight and delicate allusion that gives point and colour and charm to his writings will be missed; and on this account the full enjoyment and comprehension of De Quincey must always remain a luxury of the literary and intellectual. But his skill in narration, his rare pathos, his wide sympathies, the pomp of his dream-descriptions, the exquisite playfulness of his lighter dissertations, and his abounding though delicate and subtle humour, commend him to a larger class. Though far from being a professed humorist—a character he would have shrunk from—there is no more expert worker in a sort of half-veiled and elaborate humour and irony than De Quincey; but he employs those resources for the most part secondarily. Only in one instance has he given himself up to them unreservedly and set purpose, namely, in the famous "Essay on Murder considered as one of the Fine Arts," published in *Blackwood*,—an effort which, admired and admirable though it be, is also, it must be allowed, somewhat strained. His style, full and flexible, pure and polished, is peculiarly his own; yet it is not the style of a mannerist,—its charm is, so to speak, latent; the form never obtrudes; the secret is only discoverable by analysis and study. It consists simply in the reader's assurance of the writer's complete mastery over all the infinite applicability and resources of the English language. Hence involutions and parentheses, "cycle on epicycle," evolve themselves into a stately clearness and harmony; and sentences and paragraphs, loaded with suggestion, roll on smoothly and musically, without either fatiguing or cloying—rather, indeed, to the surprise as well as delight of the reader; for De Quincey is always ready to indulge in feats of style, witching the world with that sort of noble housemanship which is as graceful as it is daring.

It has been complained that, in spite of the apparently full confidences of the *Confessions* and *Autobiographic Sketches*, readers are left in comparative ignorance, biographically speaking, of the man De Quincey. Two passages in his *Confessions* afford sufficient clues to this mystery. In one he describes himself "as framed for love and all gentle affections," and in another confesses to the "besetting infirmity" of being "too much of an eudaemonist." "I hanker," he says, "too much after a state of happiness, both for myself and others; I cannot face misery, whether my own or not, with an eye of sufficient firmness, and am little capable of surmounting present pain for the sake of any recessionary benefit." His sensitive disposition dictated the ignoring in his writings of traits merely personal to himself, as well as his ever-recurrent resort to opium as a doorway of escape from present ill; and prompted those habits of seclusion, and that apparently capricious abstraction of himself from the society not only of his friends, but of his own family, in which he from time to time persisted. He confessed to occasional accesses of an almost irresistible impulse to flee to the labyrinthine shelter

of some great city like London or Paris,—there to dwell solitary amid a multitude, buried by day in the cloister-like recesses of mighty libraries, and stealing away by night to some obscure lodging. Long indulgence in seclusion, and in habits of study the most lawless possible in respect of regular hours or any considerations of health or comfort,—the habit of working as pleased himself without regard to the divisions of night or day, of times of sleeping or waking, even of the slow procession of the seasons, had latterly so disinclined him to the restraints, however slight, of ordinary social intercourse, that he very seldom submitted to them. On such rare occasions, however, as he did appear, perhaps at some simple meal with a favoured friend, or in later years in his own small but refined domestic circle, he was the most charming of guests, hosts or companions. A short and fragile, but well-proportioned frame; a shapely and compact head; a face beaming with intellectual light, with rare, almost feminine beauty of feature and complexion; a fascinating courtesy of manner; and a fulness, swiftness and elegance of silvery speech,—such was the irresistible "mortal mixture of earth's mould" that men named De Quincey. He possessed in a high degree what James Russell Lowell called "the grace of perfect breeding, everywhere persuasive, and nowhere emphatic"; and his whole aspect and manner exercised an undefinable attraction over every one, gentle or simple, who came within its influence; for shy as he was, he was never rudely shy, making good his boast that he had always made it his "pride to converse familiarly *more socratico* with all human beings—man, woman and child"—looking on himself as a catholic creature standing in an equal relation to high and low, to educated and uneducated. He would converse with a peasant lad or a servant girl in phrase as choice, and sentences as sweetly turned, as if his interlocutor were his equal both in position and intelligence; yet without a suspicion of pedantry, and with such complete adaptation of style and topic that his talk charmed the humblest as it did the highest that listened to it. His conversation was not a monologue; if he had the larger share, it was simply because his hearers were only too glad that it should be so; he would listen with something like deference to very ordinary talk, as if the mere fact of the speaker being one of the same company entitled him to all consideration and respect. The natural bent of his mind and disposition, and his life-long devotion to letters, to say nothing of his opium eating, rendered him, it must be allowed, regardless of ordinary obligations in life—domestic and pecuniary—to a degree that would have been culpable in any less singularly constituted mind. It was impossible to deal with or judge De Quincey by ordinary standards—not even his publishers did so. Much no doubt was forgiven him, but all that needed forgiveness is covered by the kindly veil of time, while his merits as a master in English literature are still gratefully acknowledged.¹

[BIBLIOGRAPHY.—In 1853 De Quincey began to prepare an edition of his works. *Selections Grace and Gay. Writings Published and Unpublished* (14 vols., Edinburgh, 1853–1860), followed by a second edition (1863–1871) with notes by James Hogg and two additional volumes; a further supplementary volume appeared in 1878. The first comprehensive edition, however, was printed in America (Boston, 20 vols., 1850–1855); and the "Riverside" edition (Boston and New York, 12 vols., 1877) is still fuller. The standard English edition is *The Collected Writings of Thomas De Quincey* (14 vols., Edinburgh, 1880–1890), edited by David Masson, who also wrote his biography (1881) for the "English Men of Letters" series. The *Uncollected Writings of Thomas De Quincey* (London, 2 vols., 1890) contains a preface and annotations by James Hogg; *The Posthumous Writings of Thomas De Quincey* (2 vols., 1891–1893) were edited by A. H. Japp ("H. A. Page"), who wrote the standard biography, *Thomas De Quincey: his Life and Writings* (London, 2 vols., 2nd ed., 1879), and *De Quincey Memorials* (2 vols., 1891). See also Arède Barine, *Nevrosés* (Paris, 1898); Sir L. Stephen, *Hours in a Library*; H. S. Salt, *De Quincey* (1904); and *De Quincey and his Friends* (1895), a collection edited by James Hogg, which includes essays by Dr Hill Burton and Shadworth Hodgson.] (J. R. F.)

¹ The above account has been corrected and amplified in some statements of fact for this edition. Its original author, John Ritchie Findlay (1824–1898), proprietor of *The Scotsman* newspaper, and the donor of the Scottish National Portrait Gallery in Edinburgh, had been intimate with De Quincey, and in 1886 published his *Personal Recollections* of him.

DERA GHAZI KHAN, a town and district of British India, in the Punjab. In 1901 the town had a population of 21,700. There are several handsome mosques in the native quarter. It commands the direct approaches to the Baluch highlands by Sakki Sarwar and Fort Monro. For many years past both the town and cantonment have been threatened by the erosion of the river Indus. The town was founded at the close of the 15th century and named after Ghazi Khan, son of Haji Khan, a Baluch chieftain, who after holding the country for the Langah sultans of Multan had made himself independent. Together with the two other *deras* (settlements), Dera Ismail Khan and Dera Fateh Khan, it gave its name to the territorial area locally and historically known as Derajat, which after many vicissitudes came into the possession of the British after the Sikh War, in 1849, and was divided into the two districts of Dera Ghazi Khan and Dera Ismail Khan.

The DISTRICT OF DERA GHAZI KHAN contains an area of 5306 sq. m. The district is a long narrow strip of country, 108 m. in length, sloping gradually from the hills which form its western boundary to the river Indus on the east. Below the hills the country is high and arid, generally level, but sometimes rolling in sandy undulations, and much intersected by hill torrents, 201 in number. With the exceptions of two, these streams dry up after the rains, and their influence is only felt for a few miles below the hills. The eastern portion of the district is at a level sufficiently low to benefit by the floods of the Indus. A barren tract intervenes between these zones, and is beyond the reach of the hill streams on the one hand and of the Indus on the other. Although liable to great extremes of temperature, and to a very scanty rainfall, the district is not unhealthy. The population in 1901 was 471,149, the great majority being Baluch Mahomedans. The principal exports are wheat and indigo. The only manufactures are for domestic use. There is no railway in the district, and only 29 m. of metalled road. The Indus, which is nowhere bridged within the district, is navigable by native boats. The geographical boundary between the Pathan and Baluch races in the hills nearly corresponds with the northern limit of the district. The frontier tribes on the Dera Ghazi Khan border include the Kasranias, Boddars, Khosas, Lagharis, Khetvans, Gurchanis, Mazaris, Mariris and Bugtis. The chief of these are described under their separate names.

DERA ISMAIL KHAN, a town and district in the Derajat division of the North-West Frontier Province of India. The town is situated near the right bank of the Indus, which is here crossed by a bridge of boats during half the year. In 1901 it had a population of 31,737. It takes its name from Ismail Khan, a Baluch chief who settled here towards the end of the 15th century, and whose descendants ruled for 300 years. The old town was swept away by a flood in 1823, and the present town stands 4 m. back from the permanent channel of the river. The native quarters are well laid out, with a large bazaar for Afghan traders. It is the residence of many Mahomedan gentry. The cantonment accommodates about a brigade of troops. There is considerable through trade with Afghanistan by the Gomal Pass, and there are local manufactures of cotton cloth scarves and inland wood-work.

The DISTRICT OF DERA ISMAIL KHAN contains an area of 3403 sq. m. It was formerly divided into two almost equal portions by the Indus, which intersected it from north to south. To the west of the Indus the characteristics of the country resemble those of Dera Ghazi Khan. To the east of the present bed of the river there is a wide tract known as the *Kachi*, exposed to river action. Beyond this, the country rises abruptly, and a barren, almost desert plain stretches eastwards, sparsely cultivated, and inhabited only by nomadic tribes of herdsmen. In 1901 the trans-Indus tract was allotted to the newly formed North-West Frontier Province, the cis-Indus tract remaining in the Punjab jurisdiction. The cis-Indus portions of the Dera Ismail Khan and Bannu districts now comprise the new Punjab district of Mianwali. In 1901 the population was 252,379, chiefly Pathan and Baluch Mahomedans. Wheat and wool are exported.

The Indus is navigable by native boats throughout its course of 120 m. within the district, which is the borderland of Pathan

and Baluch tribes, the Pathan element predominating. The chief frontier tribes are the Sheranis and Ustaranas.

DERBENT, or **DERBEND**, a town of Russia, Caucasia, in the province of Daghestan, on the western shore of the Caspian, 153 m. by rail N.W. of Baku, in 42° 4' N. and 48° 15' E. Pop. (1873) 15,739; (1897) 14,821. It occupies a narrow strip of land beside the sea, from which it climbs up the steep heights inland to the citadel of Naryn-kaleh, and is on all sides except towards the east surrounded by walls built of porous limestone. Its general aspect is Oriental, owing to the flat roofs of its two-storeyed houses and its numerous mosques. The environs are occupied by vineyards, gardens and orchards, in which madder, saffron and tobacco, as well as figs, peaches, pears and other fruits, are cultivated. Earthenware, weapons and silk and cotton fabrics are the principal products of the manufacturing industry. To the north of the town is the monument of the *Kirib-lar*, or "forty heroes," who fell defending Daghestan against the Arabs in 728; and to the south lies the seaward extremity of the Caucasian wall (50 m. long), otherwise known as Alexander's wall, blocking the narrow pass of the Iron Gate or Caspian Gates (*Portas Albanas* or *Portas Caspias*). This, when entire, had a height of 29 ft. and a thickness of about 10 ft., and with its iron gates and numerous watch-towers formed a valuable defence of the Persian frontier. Derbent is usually identified with Albana, the capital of the ancient Albania. The modern name, a Persian word meaning "iron gates," came into use in the end of the 5th or the beginning of the 6th century, when the city was refounded by Kavadh of the Sassanian dynasty of Persia. The walls and the citadel are believed to belong to the time of Kavadh's son, Khosrau (Chosroes) Anosharvan. In 728 the Arabs entered into possession, and established a principality in the city, which they called Bab-el-Abwab ("the principal gate"), Bab-el-Khadid ("the iron gate"), and Serrail-el-Dagab ("the golden throne"). The celebrated caliph, Harun-al-Rashid, lived in Derbent at different times, and brought it into great repute as a seat of the arts and commerce. In 1220 it was captured by the Mongols, and in the course of the succeeding centuries it frequently changed masters. In 1722 Peter the Great of Russia wrested the town from the Persians, but in 1736 the supremacy of Nadir Shah was again recognized. In 1796 Derbent was besieged by the Russians, and in 1813 incorporated with the Russian empire.

DERBY, EARLS OF. The 1st earl of Derby was probably Robert de Ferrers (d. 1139), who is said by John of Hexham to have been made an earl by King Stephen after the battle of the Standard in 1138. Robert and his descendants retained the earldom until 1266, when Robert (c. 1240-c. 1279), probably the 6th earl, having taken a prominent part in the baronial rising against Henry III., was deprived of his lands and practically of his title. These earlier earls of Derby were also known as Earls Ferrers, or de Ferrers, from their surname; as earls of Tutbury from their residence; and as earls of Nottingham because this county was a lordship under their rule. The large estates which were taken from Earl Robert in 1266 were given by Henry III. in the same year to his son, Edmund, earl of Lancaster; and Edmund's son, Thomas, earl of Lancaster, called himself Earl Ferrers. In 1337 Edmund's grandson, Henry (c. 1299-1361), afterwards duke of Lancaster, was created earl of Derby, and this title was taken by Edward III.'s son, John of Gaunt, who had married Henry's daughter, Blanche. John of Gaunt's son and successor was Henry, earl of Derby, who became king as Henry IV. in 1399.

In October 1485 Thomas, Lord Stanley, was created earl of Derby, and the title has since been retained by the Stanleys, who, however, have little or no connexion with the county of Derby. Thomas also inherited the sovereign lordship of the Isle of Man, which had been granted by the crown in 1406 to his great-grandfather, Sir John Stanley; and this sovereignty remained in possession of the earls of Derby till 1736, when it passed to the duke of Atholl.

The earl of Derby is one of the three "catkin earls," the others being the earls of Shrewsbury and Huntingdon. The term "catkin" is possibly a corruption of *quatre-skin*, derived from

the fact that in ancient times the robes of an earl (as depicted in some early representations) were decorated with four rows of ermine, as in the robes of a modern duke, instead of the three rows to which they were restricted in later centuries. The three "catskin" earldoms are the only earldoms now in existence which date from creations prior to the 17th century. (A. W. H.*)

THOMAS STANLEY, 1st earl of Derby (c. 1435-1504), was the son of Thomas Stanley, who was created Baron Stanley in 1456 and died in 1459. His grandfather, Sir John Stanley (d. 1414), had founded the fortunes of his family by marrying Isabel Lathom, the heiress of a great estate in the hundred of West Derby in Lancashire; he was lieutenant of Ireland in 1389-1391, and again in 1399-1401, and in 1405 received a grant of the lordship of Man from Henry IV. The future earl of Derby was a squire to Henry VI. in 1454, but not long afterwards married Eleanor, daughter of the Yorkist leader, Richard Neville, earl of Salisbury. At the battle of Blore Heath in August 1459 Stanley, though close at hand with a large force, did not join the royal army, whilst his brother William fought openly for York. In 1461 Stanley was made chief justice of Cheshire by Edward IV., but ten years later he sided with his brother-in-law Warwick in the Lancastrian restoration. Nevertheless, after Warwick's fall, Edward made Stanley steward of his household. Stanley served with the king in the French expedition of 1475, and with Richard of Gloucester in Scotland in 1482. About the latter date he married, as his second wife, Margaret Beaufort, mother of the exiled Henry Tudor. Stanley was one of the executors of Edward IV., and was at first loyal to the young king Edward V. But he acquiesced in Richard's usurpation, and retaining his office as steward avoided any entanglement through his wife's share in Buckingham's rebellion. He was made constable of England in succession to Buckingham, and granted possession of his wife's estates with a charge to keep her in some secret place at home. Richard could not well afford to quarrel with so powerful a noble, but early in 1485 Stanley asked leave to retire to his estates in Lancashire. In the summer Richard, suspicious of his continued absence, required him to send his eldest son, Lord Strange, to court as a hostage. After Henry of Richmond had landed, Stanley made excuses for not joining the king; for his son's sake he was obliged to temporize, even when his brother William had been publicly proclaimed a traitor. Both the Stanleys took the field; but whilst William was in treaty with Richmond, Thomas professedly supported Richard. On the morning of Bosworth (August 22), Richard summoned Stanley to join him, and when he received an evasive reply ordered Strange to be executed. In the battle it was William Stanley who turned the scale in Henry's favour, but Thomas, who had taken no part in the fighting, was the first to salute the new king. Henry VII. confirmed Stanley in all his offices, and on the 27th of October created him earl of Derby. As husband of the king's mother Derby held a great position, which was not affected by the treason of his brother William in February 1495. In the following July the earl entertained the king and queen with much state at Knowsley. Derby died on the 29th of July 1504. Strange had escaped execution in 1485, through neglect to obey Richard's orders; but he died before his father in 1497, and his son Thomas succeeded as second earl. An old poem called *The Song of the Lady Bessy*, which was written by a retainer of the Stanleys, gives a romantic story of how Derby was enlisted by Elizabeth of York in the cause of his wife's son.

For fuller narratives see J. Gairdner's *Richard III.* and J. H. Ramsay's *Lancaster and York*; also Seacome's *Memoirs of the House of Stanley* (1741). (C. L. K.)

EDWARD STANLEY, 3rd earl of Derby (1508-1572), was a son of Thomas Stanley, 2nd earl and grandson of the 1st earl, and succeeded to the earldom on his father's death in May 1521. During his minority Cardinal Wolsey was his guardian, and as soon as he came of age he began to take part in public life, being often in the company of Henry VIII. He helped to quell the rising in the north of England known as the Pilgrimage of Grace in 1536; but remaining true to the Roman Catholic faith he disliked and opposed the religious changes made under Edward

VI. During Mary's reign the earl was more at ease, but under Elizabeth his younger sons, Sir Thomas (d. 1576) and Sir Edward Stanley (d. 1609), were concerned in a plot to free Mary, queen of Scots, and he himself was suspected of disloyalty. However, he kept his numerous dignities until his death at Lathom House, near Ormskirk, on the 24th of October 1572.

Derby's first wife was Katherine, daughter of Thomas Howard, duke of Norfolk, by whom he had, with other issue, a son Henry, the 4th earl (c. 1531-1593), who was a member of the council of the North, and like his father was lord-lieutenant of Lancashire. Henry was one of the commissioners who tried Mary, queen of Scots, and was employed by Elizabeth on other high undertakings both at home and abroad. He died on the 25th of September 1593. His wife Margaret (d. 1596), daughter of Henry Clifford, 2nd earl of Cumberland, was descended through the Brandons from King Henry VII. Two of his sons, Ferdinando (c. 1559-1594), and William (c. 1561-1642), became in turn the 5th and 6th earls of Derby. Ferdinando, the 5th earl (d. 1594), wrote verses, and is eulogized by the poet Spenser under the name of Amyntas. (A. W. H.*)

JAMES STANLEY, 7th earl of Derby (1607-1651), sometimes styled the Great Earl of Derby, eldest son of William, 6th earl, and Elizabeth de Vere, daughter of Edward, 17th earl of Oxford, was born at Knowsley on the 31st of January 1607. During his father's life he was known as Lord Strange. After travelling abroad he was chosen member of parliament for Liverpool in 1625, was created knight of the Bath on the occasion of Charles's coronation in 1626, and was joined with his father the same year as lieutenant of Lancashire and Cheshire and chamberlain of Chester, and in the administration of the Isle of Man, being appointed subsequently lord-lieutenant of North Wales. On the 7th of March 1628 he was called up to the House of Lords as Baron Strange. He took no part in the political disputes between king and parliament and preferred country pursuits and the care of his estates to court or public life. Nevertheless when the Civil War broke out in 1642, Lord Strange devoted himself to the king's cause. His plan of securing Lancashire at the beginning and raising troops there, which promised success, was however discouraged by Charles, who was said to be jealous of his power and royal lineage and who commanded his presence at Nottingham. His subsequent attempts to recover the county were unsuccessful. He was unable to get possession of Manchester, was defeated at Chouvent and Lowton Moor, and in 1643 after gaining Preston failed to take Bolton and Lancaster castles. Finally, after successfully beating off Sir William Brereton's attack on Warrington, he was defeated at Whalley and withdrew to York, Warrington in consequence surrendering to the enemy's forces. In June he left for the Isle of Man to attend to affairs there, and in the summer of 1644 he took part in Prince Rupert's successful campaign in the north, when Lathom House, where Lady Derby had heroically resisted the attacks of the besiegers, was relieved, and Bolton Castle taken. He followed Rupert to Marston Moor, and after the complete defeat of Charles's cause in the north withdrew to the Isle of Man, where he held out for the king and offered an asylum to royalist fugitives. His administration of the island imitated that of Strafford in Ireland. It was strong rather than just. He maintained order, encouraged trade, remedied some abuses, and defended the people from the exactions of the church; but he crushed opposition by imprisoning his antagonists, and aroused a prolonged agitation by abolishing the tenant-right and introducing leaseholds. In July 1649 he refused scornfully terms offered to him by Ireton. By the death of his father on the 29th of September 1642 he had succeeded to the earldom, and on the 12th of January 1650 he obtained the Garter. He was chosen by Charles II. to command the troops of Lancashire and Cheshire, and on the 15th of August 1651 he landed at Wyre Water in Lancashire in support of Charles's invasion, and met the king on the 17th. Proceeding to Warrington he failed to obtain the support of the Presbyterians through his refusal to take the Covenant, and on the 25th was totally defeated at Wigan, being severely wounded and escaping with difficulty. He joined

Charles at Worcester; after the battle on the 3rd of September he accompanied him to Boscobel, and while on his way north alone was captured near Nantwich and given quarter. He was tried by court-martial at Chester on the 29th of September, and on the ground that he was a traitor and not a prisoner of war under the act of parliament passed in the preceding month, which declared those who corresponded with Charles guilty of treason, his quarter was disallowed and he was condemned to death. When his appeal for pardon to parliament was rejected, though supported by Cromwell, he endeavoured to escape; but was recaptured and executed at Bolton on the 15th of October 1651. He was buried in Ormskirk church. Lord Derby was a man of deep religious feeling and of great nobility of character, who though unsuccessful in the field served the king's cause with single-minded purpose and without expectation of reward. His political usefulness was handicapped in the later stages of the struggle by his dislike of the Scots, whom he regarded as guilty of the king's death and as unfit instruments of the restoration. According to Clarendon he was "a man of great honour and clear courage," and his defects the result of too little knowledge of the world. Lord Derby left in MS. "A Discourse concerning the Government of the Isle of Man" (printed in the *Stanley Papers* and in F. Peck's *Desiderata Curiosa*, vol. ii.) and several volumes of historical collections, observations, devotions (*Stanley Papers*) and a commonplace book. He married on the 26th of June 1626 Charlotte de la Tremoille (1599-1664), daughter of Claude, duc de Thouars, and granddaughter of William the Silent, prince of Orange, by whom besides four daughters he had five sons, of whom the eldest, Charles (1628-1672), succeeded him as 8th earl.

Charles's two sons, William, the 9th earl (c. 1655-1702), and James, the 10th earl (1664-1736), both died without sons, and consequently, when James died in February 1736, his titles and estates passed to Sir Edward Stanley (1689-1776), a descendant of the 1st earl. From him the later earls were descended, the 12th earl (d. 1834) being his grandson.

BIBLIOGRAPHY.—Article in *Dict. of Nat. Biog.* with authorities and article in same work on Charlotte Stanley, countess of Derby; the *Stanley Papers*, with the too laudatory memoir by F. R. Haines (Chetham Soc. publications, vols. 62, 66, 67, 70); *Memoirs*, by De Lloyd (1668), 572; *State Trials*, v. 293-324; *Notes & Queries*, viii. Ser. iii. 246; Seacombe's *House of Stanley*; Clarendon's *Hist. of the Rebellion*; Gardiner's *Hist. of the Civil War and Protectorate*; *The Land of Home Rule*, by Spencer Walpole (1893); *Hist. of the Isle of Man*, by A. W. Moore (1900); Manx Soc. publications, vols. 3, 25, 27. (P. C. Y.)

EDWARD GEOFFREY SMITH STANLEY, 14th earl of Derby (1799-1869), the "Rupert of Debate," born at Knowsley in Lancashire on the 20th of March 1799, grandson of the 12th earl and eldest son of Lord Stanley, subsequently (1834) 13th earl of Derby (1775-1851). He was educated at Eton and at Christ Church, Oxford, where he distinguished himself as a classical scholar, though he took no degree. In 1819 he obtained the Chancellor's prize for Latin verse, the subject being "Syracuse." He gave early promise of his future eminence as an orator, and in his youth he used to practise elocution under the instruction of Lady Derby, his grandfather's second wife, the actress, Elizabeth Farren. In 1820 he was returned for Stockbridge in Hampshire, one of the nomination boroughs whose electoral rights were swept away by the Reform Bill of 1832, Stanley being a warm advocate of their destruction.

His maiden speech was delivered early in the session of 1824 in the debate on a private bill for lighting Manchester with gas. On the 6th of May 1824 he delivered a vehement and eloquent speech against Joseph Hume's motion for a reduction of the Irish Church establishment, maintaining in its most conservative form the doctrine that church property is as sacred as private property. From this time his appearances became frequent; and he soon asserted his place as one of the most powerful speakers in the House. Specially noticeable almost from the first was the skill he displayed in reply. Macaulay, in an essay published in 1834, remarked that he seemed to possess intuitively the faculty which in most men is developed only by long and laborious practice. In the autumn of 1824 Stanley went on an extended tour through

Canada and the United States in company with Mr Labouchere; afterwards Lord Taunton, and Mr Evelyn Denison, afterwards Lord Ossington. In May of the following year he married the second daughter of Edward Bootle-Wilbraham, created Baron Skelmersdale in 1828, by whom he had a family of two sons and one daughter who survived.

At the general election of 1826 Stanley renounced his connection with Stockbridge, and became the representative of the borough of Preston, where the Derby influence was paramount. The change of seats had this advantage, that it left him free to speak against the system of rotten boroughs, which he did with great force during the Reform Bill debates, without laying himself open to the charge of personal inconsistency as the representative of a place where, according to Gay, cobblers used to "feast three years upon one vote." In 1827 he and several other distinguished Whigs made a coalition with Canning on the defection of the more unyielding Tories, and he commenced his official life as under-secretary for the colonies, but the coalition was broken up by Canning's death in August. Lord Goderich succeeded to the premiership, but he never was really in power, and he resigned his place after the lapse of a few months. During the succeeding administration of the duke of Wellington (1828-1830), Stanley and those with whom he acted were in opposition. His robust and assertive Liberalism about this period seemed curious afterwards to a younger generation who knew him only as the very embodiment of Conservatism.

By the advent of Lord Grey to power in November 1830, Stanley obtained his first opportunity of showing his capacity for a responsible office. He was appointed to the chief secretaryship of Ireland, a position in which he found ample scope for both administrative and debating skill. On accepting office he had to vacate his seat for Preston and seek re-election; and he had the mortification of being defeated by the Radical "orator" Hunt. The contest was a peculiarly keen one, and turned upon the question of the ballot, which Stanley refused to support. He re-entered the House as one of the members for Windsor, Sir Hussey Vivian having resigned in his favour. In 1832 he again changed his seat, being returned for North Lancashire.

Stanley was one of the most ardent supporters of Lord Grey's Reform Bill. Of this no other proof is needed than his frequent parliamentary utterances, which were fully in sympathy with the popular cry "The bill, the whole bill, and nothing but the bill." Reference may be made especially to the speech he delivered on the 4th of March 1831 on the adjourned debate on the second reading of the bill, which was marked by all the higher qualities of his oratory. Apart from his connexion with the general policy of the government, Stanley had more than enough to have employed all his energies in the management of his own department. The secretary of Ireland has seldom an easy task; Stanley found it one of peculiar difficulty. The country was in a very unsettled state. The just concession that had been somewhat tardily yielded a short time before in Catholic emancipation had excited the people to make all sorts of demands, reasonable and unreasonable. Undaunted by the fierce denunciations of O'Connell, who styled him Scorpion Stanley, he discharged with determination the ungrateful task of carrying a coercion bill through the House. It was generally felt that O'Connell, powerful though he was, had fairly met his match in Stanley, who, with invective scarcely inferior to his own, evaded no challenge, ignored no argument, and left no taunt unanswered. The title "Rupert of Debate" is peculiarly applicable to him in connexion with the fearless if also often reckless method of attack he showed in his parliamentary war with O'Connell. It was first applied to him, however, thirteen years later by Sir Edward Bulwer Lytton in *The New Timon*:—

"One after one the lords of time advance;
Here Stanley meets—here Stanley scorns the glance!
The brilliant chief, irregularly great,
Frank, haughty, rash,—the Rupert of debate."

The best answer, however, which he made to the attacks of the great agitator was not the retorts of debate, effective though these were, but the beneficial legislation he was instrumental in

passing. He introduced and carried the first national education act for Ireland, one result of which was the remarkable and to many almost incredible phenomenon of a board composed of Catholics, Episcopalians and Presbyterians harmoniously administering an efficient education scheme. He was also chiefly responsible for the Irish Church Temporalities Act, though the bill was not introduced into parliament until after he had quitted the Irish secretaryship for another office. By this measure two archbishoprics and eight bishoprics were abolished, and a remedy was provided for various abuses connected with the revenues of the church. As originally introduced, the bill contained a clause authorizing the appropriation of surplus revenues to non-ecclesiastical purposes. This had, however, been strongly opposed from the first by Stanley and several other members of the cabinet, and it was withdrawn by the government before the measure reached the Lords.

In 1833, just before the introduction of the Irish Church Temporalities Bill, Stanley had been promoted to be secretary for the colonies with a seat in the cabinet. In this position it fell to his lot to carry the emancipation of the slaves to a successful practical issue. The speech which he delivered on introducing the bill for freeing the slaves in the West Indies, on the 14th of May 1833, was one of the finest specimens of his eloquence.

The Irish Church question determined more than one turning-point in his political career. The most important occasion on which it did so was in 1834, when the proposal of the government to appropriate the surplus revenues of the church to educational purposes led to his secession from the cabinet, and, as it proved, his complete and final separation from the Whig party. In the former of these steps he had as his companions Sir James Graham, the earl of Ripon and the duke of Richmond. Soon after it occurred, O'Connell, amid the laughter of the House, described the secession in a couplet from Canning's *Loves of the Triangles*—

"Still down thy steep, romantic Ashbourne, glides
The Derby dilly carrying six insiders."

Stanley was not content with marking his disapproval by the simple act of withdrawing from the cabinet. He spoke against the bill to which he objected with a vehemence that showed the strength of his feeling in the matter, and against its authors with a bitterness that he himself is understood to have afterwards admitted to have been unseemly towards those who had so recently been his colleagues. The course followed by the government was "marked with all that timidity, that want of dexterity, which led to the failure of the unpractised shoplifter." His late colleagues were compared to "thimble-riggers at a country fair," and their plan was "petty larceny, for it had not the redeeming qualities of bold and open robbery."

In the end of 1834, Lord Stanley, as he was now styled by courtesy, his father having succeeded to the earldom in October, was invited by Sir Robert Peel to join the short-lived Conservative ministry which he formed after the resignation of Lord Melbourne. Though he declined the offer for reasons stated in a letter published in the Peel memoirs, he acted from that date with the Conservative party, and on its next accession to power, in 1841, he accepted the office of colonial secretary, which he had held under Lord Grey. His position and his temperament alike, however, made him a thoroughly independent supporter of any party to which he attached himself. When, therefore, the injury to health arising from the late hours in the Commons led him in 1844 to seek elevation to the Upper House in the right of his father's barony, Sir Robert Peel, in acceding to his request, had the satisfaction of at once freeing himself from the possible effects of his "candid friendship" in the House, and at the same time greatly strengthening the debating power on the Conservative side in the other. If the premier in taking this step had any presentiment of an approaching difference on a vital question, it was not long in being realized. When Sir Robert Peel accepted the policy of free trade in 1846, the breach between him and Lord Stanley was, as might have been anticipated from the antecedents of the latter, instant and irreparable. Lord Stanley at once asserted himself as the uncompromising opponent of that policy, and he became the recognized leader of the Protectionist party,

having Lord George Bentinck and Disraeli for his lieutenants in the Commons. They did all that could be done in a case in which the logic of events was against them, though Protection was never to become more than their watchword.

It is one of the peculiarities of English politics, however, that a party may come into power because it is the only available one at the time, though it may have no chance of carrying the very principle to which it owes its organized existence. Such was the case when Lord Derby, who had succeeded to the earldom on the death of his father in June 1851, was called upon to form his first administration in February 1852. He was in a minority, but the circumstances were such that no other than a minority government was possible, and he resolved to take the only available means of strengthening his position by dissolving parliament and appealing to the country at the earliest opportunity. The appeal was made in autumn, but its result did not materially alter the position of parties. Parliament met in November, and by the middle of the following month the ministry had resigned in consequence of their defeat on Disraeli's budget. For the six following years, during Lord Aberdeen's "ministry of all the talents" and Lord Palmerston's premiership, Lord Derby remained at the head of the opposition, whose policy gradually became more generally Conservative and less distinctively Protectionist as the hopelessness of reversing the measures adopted in 1846 made itself apparent. In 1855 he was asked to form an administration after the resignation of Lord Aberdeen, but failing to obtain sufficient support, he declined the task. It was in somewhat more hopeful circumstances that, after the defeat of Lord Palmerston on the Conspiracy Bill in February 1858, he assumed for the second time the reins of government. Though he still could not count upon a working majority, there was a possibility of carrying on affairs without sustaining defeat, which was realized for a full session, owing chiefly to the dexterous management of Mr Disraeli in the Commons. The one rock ahead was the question of reform, on which the wishes of the country were being emphatically expressed, but it was not so pressing as to require to be immediately dealt with. During the session of 1858 the government contrived to pass two measures of very considerable importance, one a bill to remove Jewish disabilities, and the other a bill to transfer the government of India from the East India Company to the crown. Next year the question of parliamentary reform had to be faced, and, recognizing the necessity, the government introduced a bill at the opening of the session, which, in spite of, or rather in consequence of, its "fancy franchises," was rejected by the House, and, on a dissolution, rejected also by the country. A vote of no confidence having been passed in the new parliament on the 10th of June, Lord Derby at once resigned.

After resuming the leadership of the Opposition Lord Derby devoted much of the leisure the position afforded him to the classical studies that had always been congenial to him. It was his reputation for scholarship as well as his social position that had led in 1852 to his appointment to the chancellorship of the university of Oxford, in succession to the duke of Wellington; and perhaps a desire to justify the possession of the honour on the former ground had something to do with his essays in the field of authorship. His first venture was a poetical version of the ninth ode of the third book of Horace, which appeared in Lord Ravensworth's collection of translations of the *Odes*. In 1862 he printed and circulated in influential quarters a volume entitled *Translations of Poems Ancient and Modern*, with a very modest dedicatory letter to Lord Stanhope, and the words "Not published" on the title-page. It contained, besides versions of Latin, Italian, French and German poems, a translation of the first book of the *Iliad*. The reception of this volume was such as to encourage him to proceed with the task he had chosen as his *magnum opus*, the translation of the whole of the *Iliad*, which accordingly appeared in 1864.

During the seven years that elapsed between Lord Derby's second and third administrations an industrial crisis occurred in his native county, which brought out very conspicuously his public spirit and his philanthropy. The destitution in Lancashire

caused by the stoppage of the cotton-supply in consequence of the American Civil War, was so great as to threaten to overtax the benevolence of the country. That it did not do so was probably due to Lord Derby more than to any other single man. From the first he was the very life and soul of the movement for relief. His personal subscription, munificent though it was, represented the least part of his service. His noble speech at the meeting in Manchester in December 1862, where the movement was initiated, and his advice at the subsequent meetings of the committee, which he attended very regularly, were of the very highest value in stimulating and directing public sympathy. His relations with Lancashire had always been of the most cordial description, notwithstanding his early rejection by Preston; but it is not surprising that after the cotton famine period the cordiality passed into a warmer and deeper feeling, and that the name of Lord Derby was long cherished in most grateful remembrance by the factory operatives.

On the rejection of Earl Russell's Reform Bill in 1866, Lord Derby was for the third time entrusted with the formation of a cabinet. Like those he had previously formed it was destined to be short-lived, but it lived long enough to settle on a permanent basis the question that had proved fatal to its predecessor. The "education" of the party that had so long opposed all reform to the point of granting household suffrage was the work of another; but Lord Derby fully concurred in, if he was not the first to suggest, the statesmanlike policy by which the question was disposed of in such a way as to take it once for all out of the region of controversy and agitation. The passing of the Reform Bill was the main business of the session 1867. The chief debates were, of course, in the Commons, and Lord Derby's failing powers prevented him from taking any large share in those which took place in the Lords. His description of the measure as a "leap in the dark" was eagerly caught up, because it exactly represented the common opinion at the time,—the most experienced statesmen, while they admitted the granting of household suffrage to be a political necessity, being utterly unable to foresee what its effect might be on the constitution and government of the country.

Finding himself unable, from declining health, to encounter the fatigues of another session, Lord Derby resigned office early in 1868. The step he had taken was announced in both Houses on the evening of the 25th of February, and warm tributes of admiration and esteem were paid by the leaders of the two great parties. He yielded the entire leadership of the party as well as the premiership to Disraeli. His subsequent appearances in public were few and unimportant. It was noted as a consistent close to his political life that his last speech in the House of Lords should have been a denunciation of Gladstone's Irish Church Bill marked by much of his early fire and vehemence. A few months later, on the 23rd of October 1869, he died at Knowsley.

Sir Archibald Alison, writing of him when he was in the zenith of his powers, styles him "by the admission of all parties the most perfect orator of his day." Even higher was the opinion of Lord Aberdeen, who is reported by *The Times* to have said that no one of the giants he had listened to in his youth, Pitt, Fox, Burke or Sheridan, "as a speaker, is to be compared with our own Lord Derby, when Lord Derby is at his best." (W.B.S.)

EDWARD HENRY STANLEY, 15th earl of Derby (1826-1893), eldest son of the 14th earl, was educated at Rugby and Trinity College, Cambridge, where he took a high degree and became a member of the society known as the Apostles. In March 1848 he unsuccessfully contested the borough of Lancaster, and then made a long tour in the West Indies, Canada and the United States. During his absence he was elected member for King's Lynn, which he represented till October 1869, when he succeeded to the peerage. He took his place, as a matter of course, among the Conservatives, and delivered his maiden speech in May 1850 on the sugar duties. Just before, he had made a very brief tour in Jamaica and South America. In 1852 he went to India, and while travelling in that country he was appointed under-secretary for foreign affairs in his father's first administration. From the outset of his career he was known to be a most Liberal Conservative, and in 1855 Lord Palmerston offered him

the post of colonial secretary. He was much tempted by the proposal, and hurried down to Knowsley to consult his father, who called out when he entered the room, "Hallo, Stanley! what brings you here?—Has Dizzy cut his throat, or are you going to be married?" When the object of his sudden appearance had been explained, the Conservative chief received the courteous suggestion of the prime minister with anything but favour, and the offer was declined. In his father's second administration Lord Stanley held, at first, the office of secretary for the colonies, but became president of the Board of Control on the resignation of Lord Ellenborough. He had the charge of the India Bill of 1858 in the House of Commons, became the first secretary of state for India, and left behind him in the India Office an excellent reputation as a man of business. After the revolution in Greece and the disappearance of King Otto, the people most earnestly desired to have Queen Victoria's second son, Prince Alfred, for their king. He declined the honour, and they then took up the idea that the next best thing they could do would be to elect some great and wealthy English noble, not concealing the hope that although they might have to offer him a Civil List he would decline to receive it. Lord Stanley was the prime favourite as an occupant of this bed of thorns, and it has been said that he was actually offered the crown. That, however, is not true; the offer was never formally made. After the fall of the Russell government in 1866 he became foreign secretary in his father's third administration. He compared his conduct in that great post to that of a man floating down a river and fending off from his vessel, as well as he could, the various obstacles it encountered. He thought that that should be the normal attitude of an English foreign minister, and probably under the circumstances of the years 1866-1868 it was the right one. He arranged the collective guarantee of the neutrality of Luxemburg in 1867, negotiated a convention about the "Alabama," which, however, was not ratified, and most wisely refused to take any part in the Cretan troubles. In 1874 he again became foreign secretary in Disraeli's government. He acquiesced in the purchase of the Suez Canal shares, a measure then considered dangerous by many people, but ultimately most successful; he accepted the Andrassy Note, but declined to accede to the Berlin Memorandum. His part in the later phases of the Russo-Turkish struggle has never been fully explained for with equal wisdom and generosity he declined to gratify public curiosity at the cost of some of his colleagues. A later generation will know better than his contemporaries what were the precise developments of policy which obliged him to resign. He kept himself ready to explain in the House of Lords the course he had taken if those whom he had left challenged him to do so, but from that course they consistently refrained. Already in October 1879 it was clear enough that he had thrown in his lot with the Liberal party, but it was not till March 1880 that he publicly announced this change of allegiance. He did not at first take office in the second Gladstone government, but became secretary for the colonies in December 1882, holding this position till the fall of that government in the summer of 1885. In 1886 the old Liberal party was run on the rocks and went to pieces. Lord Derby became a Liberal Unionist, and took an active part in the general management of that party, leading it in the House of Lords till 1891, when Lord Hartington became duke of Devonshire. In 1892 he presided over the Labour Commission, but his health never recovered an attack of influenza which he had in 1891, and he died at Knowsley on the 21st of April 1893.

During a great part of Lord Derby's life he was deflected from his natural course by the accident of his position as the son of the leading Conservative statesman of the day. From first to last he was at heart a moderate Liberal. After making allowance, however, for this deflecting agency, it must be admitted that in the highest quality of the statesman, "aptness to be right," he was surpassed by none of his contemporaries, or—if by anybody—by Sir George Cornwall Lewis alone. He would have been more at home in a state of things which did not demand from its leading statesman great popular power; he had none of those "isms" and "prisms of fancy" which stood in such good stead

some of his rivals. He had another defect besides the want of popular power. He was so anxious to arrive at right conclusions that he sometimes turned and turned and turned a subject over till the time for action had passed. One of his best lieutenants said of him in a moment of impatience: "Lord Derby is like the God of Hegel: 'Er setzt sich, er vermeint sich, er vermeint seine Negation.'" His knowledge, acquired both from books and by the ear, was immense, and he took every opportunity of increasing it. He retained his old university habit of talking long walks with a congenial companion, even in London, and although he cared but little for what is commonly known as society—the society of crowded rooms and fragments of sentences—he very much liked conversation. During the many years in which he was a member of "The Club" he was one of its most assiduous frequenters, and his loss was acknowledged by a formal resolution. His talk was generally grave, but every now and then was lit up by dry humour. The late Lord Arthur Russell once said to him, after he had been buying some property in southern England: "So you still believe in land, Lord Derby." "Hang it," he replied, "a fellow must believe in something!" He did an immense deal of work outside politics. He was lord rector of the University of Glasgow from 1868 to 1871, and later held the same office in that of Edinburgh. From 1875 to 1893 he was president of the Royal Literary Fund, and attended most closely to his duties then. He succeeded Lord Granville as chancellor of the University of London in 1891, and remained in that position till his death. He lived much in Lancashire, managed his enormous estates with great skill, and did a great amount of work as a local magnate. He married in 1870 Maria Catharine, daughter of the 5th earl de la Warr, and widow of the 2nd marquess of Salisbury.

The earl left no children and he was succeeded as 16th earl by his brother Frederick Arthur Stanley (1841–1908), who had been made a peer as Baron Stanley of Preston in 1886. He was secretary of state for war and for the colonies and president of the board of trade; and was governor-general of Canada from 1888 to 1893. He died on the 14th of June 1908, when his eldest son, Edward George Villiers Stanley, became earl of Derby. As Lord Stanley the latter had been member of parliament for the West Houghton division of Lancashire from 1892 to 1906; he was financial secretary to the War Office from 1900 to 1903, and postmaster-general from 1903 to 1905.

The best account of the 15th Lord Derby is that which was prefixed by W. E. H. Lecky, who knew him very intimately, to the edition of his speeches outside parliament, published in 1894. (M. G. D.)

DERBY, a city of New Haven county, Connecticut, U.S.A., coextensive with the township of Derby, about 10 m. W. of New Haven, at the junction of the Housatonic and Naugatuck rivers. Pop. (1900) 7930 (2635 foreign-born); (1910) 8991. It is served by the New York, New Haven & Hartford railway, and by interurban electric railways. In Derby there are an opera house, owned by the city, and a public library. Across the Housatonic is the borough of Shelton (pop. 1910, 4807), which is closely related, socially and industrially, to Derby, the two having a joint board of trade. Adjoining Derby on the N. along the Naugatuck is Ansonia. Derby, Ansonia and Shelton form one of the most important manufacturing communities in the state; although their total population in 1900 (23,448) was only 2.9% of the state's population, the product of their manufactories was 7.4% of the total manufactured product of Connecticut. Among the manufactures of Derby are pianos and organs, woollen goods, pins, keys, dress stays, combs, typewriters, corsets, hosiery, guns and ammunition, and foundry and machine-shop products. Derby was settled in 1642 as an Indian trading post under the name *Faugasset*, and received its present name in 1675. The date of organization of the township is unknown. Ansonia was formed from a part of Derby in 1889. In 1893 the borough of Birmingham, on the opposite side of the Naugatuck, was annexed to Derby, and Derby was chartered as a city. In the 18th century Derby was the centre of a thriving commerce with the West Indies. Derby is the birthplace of David Humphreys

(1752–1818), a soldier, diplomatist and writer, General Washington's aide and military secretary from 1780 until the end of the War of Independence, the first minister of the United States to Portugal (1790–1797) and minister to Spain in 1797–1802, and one of the "Hartford Wits."

See Samuel Orcutt and Ambrose Beardsley, *History of the Old Town of Derby* (Springfield, 1880); and the *Town Records of Derby from 1655 to 1710* (Derby, 1901).

DERBY, a municipal, county and parliamentary borough, and the county town of Derbyshire, England, 128½ m. N.N.W. of London by the Midland railway; it is also served by the Great Northern railway. Pop. (1891) 94,146; (1901) 114,848. Occupying a position almost in the centre of England, the town is situated chiefly on the western bank of the river Derwent, on an undulating site encircled with gentle eminences, from which flow the Markeaton and other brooks. In the second half of the 19th century the prosperity of the town was enhanced by the establishment of the head offices and principal workshops of the Midland Railway Company. Derby possesses several handsome public buildings, including the town hall, a spacious range of buildings erected for the postal and inland revenue offices, the county hall, corn exchange and market hall. Among churches may be mentioned St Peter's a fine building principally of Perpendicular date but with earlier portions; St Alkmund's with its lofty spire, Decorated in style; St Andrew's, in the same style, by Sir G. G. Scott; and All Saints', which contains a beautiful choir-screen, good stained glass and monuments by L. F. Roubiliac, Sir Francis Chantrey and others. The body of this church is in classic style (1725), but the tower was built 1509–1527, and is one of the finest in the midland counties, built in three tiers, and crowned with battlements and pinnacles, which give it a total height of 210 ft. The Roman Catholic church of St Mary is one of the best examples of the work of A. W. Pugin. The Derby grammar school, one of the most ancient in England, was placed in 1160 under the administration of the chapter of Darley Abbey, which lay a little north of Derby. It occupies St Helen's House, once the town residence of the Strutt family, and has been enlarged in modern times, accommodating about 160 boys. The Derby municipal technical college is administered by the corporation. Other institutions include schools of science and art, public library, museum and art gallery, the Devonshire almshouses, a remodelled foundation inaugurated by Elizabeth, countess of Shrewsbury, in the 16th century, and the town and county infirmary. The free library and museum buildings, together with a recreation ground, were gifts to the town from M. T. Bass, M.P. (d. 1884), while an arboretum of seventeen acres was presented to the town by Joseph Strutt in 1840.

Derby has been long celebrated for its porcelain, which rivalled that of Saxony and France. This manufacture was introduced about 1750, and although for a time partially abandoned, it has been revived. There are also spar works where the fluor-spar, or Blue John, is wrought into a variety of useful and ornamental articles. The manufacture of silk, hosiery, lace and cotton formerly employed a large portion of the population, and there are still numerous silk mills and elastic web works. Silk "throwing" or spinning was introduced into England in 1717 by John Lombe, who found out the secrets of the craft when visiting Piedmont, and set up machinery in Derby. Other industries include the manufacture of paint, shot, white and red lead and varnish; and there are sawmills and tanneries. The manufacture of hosiery profited greatly by the inventions of Jedediah Strutt about 1750. In the northern suburb of Littlechester, there are chemical and steam boiler works. The Midland railway works employ a large number of hands. Derby is a suffragan bishopric in the diocese of Southwell. The parliamentary borough returns two members. The town is governed by a mayor, sixteen aldermen and forty-two councillors. Area, 3449 acres.

Littlechester, as its name indicates, was the site of a Roman fort or village; the site is in great part built over and the remains practically effaced. Derby was known in the time of the heptarchy as Northwithig, and did not receive the name of

Derby or Derby until after it was given up to the Danes by the treaty of Wedmore and had become one of their five boroughs, probably ruled in the ordinary way by an earl with twelve "lawmen" under him. Being won back among the sweeping conquests of Æthelflæd, lady of the Mercians, in 917, it prospered during the 10th century, and by the reign of Edward the Confessor there were 243 burgesses in Derby. However, by 1086 this number had decreased to 100, while 103 "manse" which used to be assessed were waste. In spite of this the amount rendered by the town to the lord had increased from £24 to £30. The first extant charter granted to Derby is dated 1206 and is a grant of all those privileges which the burgesses of Nottingham had in the time of Henry I. and Henry II., which included freedom from toll, a gild merchant, power to elect a provost at their will, and the privilege of holding the town at the ancient farm with an increase of £10 yearly. The charter also provides that no one shall dye cloth within ten leagues of Derby except in the borough. A second charter, granted by Henry III. in 1229, limits the power of electing a provost by requiring that he shall be removed if he be displeasing to the king. Henry III. also granted the burgesses two other charters, one in 1225 confirming their privileges and granting that the *comitatus* of Derby should in future be held on Thursdays in the borough, the other in 1260 granting that no Jew should be allowed to live in the town. In 1337 Edward III. on the petition of the burgesses granted that they might have two bailiffs instead of one. Derby was incorporated by James I. in 1611 under the name of the bailiffs and burgesses of Derby, but Charles I. in 1637 appointed a mayor, nine aldermen, fourteen brethren and fourteen capital burgesses. In 1680 the burgesses were obliged to resign their charters, and received a new one, which did not, however, alter the government of the town. Derby has been represented in parliament by two members since 1295. In the rebellion of 1745 the young Pretender marched with his army as far south as Derby, where the council was held which decided that he should return to Scotland instead of going on to London.

Among early works on Derby are W. Hutton, *History of Derby* (London, 1791); R. Simpson, *History and Antiquities of Derby* (Derby, 1826).

DERBYSHIRE, a north midland county of England, bounded N. and N.E. by Yorkshire, E. by Nottinghamshire, S.E. and S. by Leicestershire, S. and S.W. by Staffordshire, and W. and N.W. by Cheshire. The area is 1029.5 sq. m. The physical aspect is much diversified. The extreme south of the county is lacking in picturesqueness, being for the most part level, with occasional slight undulations. The Peak District of the north, on the other hand, though inferior in grandeur to the mountainous Lake District, presents some of the finest hill scenery in England, deriving a special beauty from the richly wooded glens and valleys, such as those of Castleton, Glossop, Dovedale and Millersdale. The character of the landscape ranges from the wild moorland of the Cheshire borders or the grey rocks of the Peak, to the park lands and woods of the Chatsworth district. Some of the woods are noted for their fine oaks, those at Kedleston, 3 m. from Derby, ranking among the largest and oldest in the kingdom. From the northern hills the streams of the county radiate. Those of the north-west belong to the Mersey, and those of the north-east to the Don, but all the others to the Trent, which, like the Don, falls into the Humber. The principal river is the Trent, which, rising in the Staffordshire moorlands, intersects the southern part of Derbyshire, and forms part of its boundary with Leicestershire. After the Trent the most important river is the Derwent, one of its tributaries, which, taking its rise in the lofty ridges of the High Peak, flows southward through a beautiful valley, receiving a number of minor streams in its course, including the Wye, which, rising near Buxton, traverses the fine Millersdale and Monsal Dale. The other principal rivers are the following: The Dane rises at the junction of the three counties, Staffordshire, Cheshire and Derbyshire. The Goyt has its source a little farther north, at the base of the same hill, and, taking a N.N.E. direction, divides Derbyshire from Cheshire, and falls into the Mersey. The Dove rises on the southern slope, and flows as

the boundary stream between Derbyshire and Staffordshire for nearly its entire course. It receives several feeders, and falls into the Trent near Repton. The Erewash is the boundary stream between Nottinghamshire and Derbyshire. The Rother rises about Baslow, and flows into Yorkshire, with a northerly course, joining the Don. Besides the attractions of its scenery Derbyshire possesses, in Buxton, Matlock and Bakewell, three health resorts in much favour on account of their medicinal springs.

The whole northward extension of the county is occupied by the plateau of the Peak and other plateau-like summits, the highest of which are of almost exactly similar elevation. Thus in the extreme north Bleaklow Hill reaches 2060 ft., while southward from this point along the axis of main elevation are found Shelf Moss (2046 ft.), and Kinder Scout and other summits of the Peak itself, ranging up to 2088 ft. This plateau-mass is demarcated on the north and west by the vales of the Etherow and Goyt, by the valley of the Derwent on the east, and in part by that of its tributary the Noe on the south. The flanks of the plateau are deeply scored by abrupt ravines, often known as "cloughs" (an Anglo-Saxon word, *cloh*) watered by streams which sometimes descend over precipitous ledges in picturesque falls, such as the Kinder Downfall, formed by the brook of that name which rises on Kinder Scout. The most picturesque cloughs are found on the south, descending to Edale, and on the west. Edale is the upper part of the Noe valley, and the narrow gorge at its head is exceedingly beautiful, as is the more gentle scenery of the Vale of Hope, the lower part of the valley. In a branch vale is situated Castleton (*q.v.*), with the ruined Peak Castle or Castle of the Peak, and the Peak Cavern, Blue John Mine and other caves. The upper Derwent valley, or Derwent Dale, is narrow and well wooded. In it, near the village of Derwent Chapel, is Derwent Hall, a fine old mansion formerly a seat of the Newdigate family. On Derwent Edge, above the village, are various peculiar rock formations, known by such names as the Salt-cellar. Ashopton, another village lower down the dale, is a favourite centre, and here the main valley is joined by Ashop Dale, a bold defile in its upper part, penetrating the heart of the Peak.

The well-known high road crossing the plateau from east to west, between the lower Derwent valley, Bakewell, Buxton and Macclesfield, shows the various types of scenery characteristic of the limestone hill-country of Derbyshire south of the Peak itself. The lower Derwent valley, about Chatsworth, Rowsley, Darley and Matlock, is open, fertile and well wooded. The road leads up the tributary valley of the Wye, which after Bakewell quickly narrows, and in successive portions is known as Monsal Dale, Millersdale (which the main road does not touch), Chee Dale and Wye Dale. On the flanks of these beautiful dales bold cliffs and bastions of limestone stand out among rich woods. Near the mouth of the valley, about Stanton, the fantastic effects of weathering on the limestone are especially well seen, as in Rowtor Rocks and Robin Hood's Stride, and in the same locality are a remarkable number of tumuli and other early remains, and the Hermitage, a cave containing sacred carvings. From Buxton the road ascends over the high moors, here open and grassy in contrast to the heather of the Peak, and shortly after crossing the county boundary, reaches the head of the pass well known by the name of an inn, the Cat and Fiddle, at its highest point, 1690 ft.

South of Buxton the elevations along the main axis decrease, thus Axe Edge reaches 1600 ft., and this height is nowhere exceeded as the hills sink to the plain valley of the Trent. The dales and ravines which ramify among the limestone heights are characteristic and beautiful, and the valley of the Dove (*q.v.*) or Dovedale, on the border with Staffordshire, is as famous as any of the northern dales. Swallow-holes or waterworn caverns are common in many parts of the limestone region. The hills east of the Derwent are nowhere so high as those to the west—Margley Hill reaches 1793 ft., Howden Edge 1787 ft. and Derwent Moors 1505 ft. The plateau type is maintained. The valley of the Derwent provides the most attractive scenery in

the southern part of the county, from Matlock southward by Heage, Belper and Duffield to Derby.

Geology.—Five well-contrasted types of scenery in Derbyshire are clearly traceable to as many varieties of rock; the bleak dry uplands of the north and east, with deep-cut ravines and swift clear streams, are due to the great mass of Mountain Limestone; round the limestone boundary are the valleys with soft outcrops in the Pendleside Shales; these are succeeded by the rugged moorlands, covered with heather and peat, which are due to the Millstone Grit series; eastward lies the Derbyshire Coalfield with its gently moulded grass-covered hills; southward is the more level tract of red Triassic rocks. The principal structural feature is the broad anticline, its axis running north and south, which has brought up the Carboniferous Limestone; this uplifted region is the southern extremity of the Pennine Range. The Carboniferous or "Mountain" Limestone is the oldest formation in the county; its thickness is not known, but it is certainly over 2000 ft.; it is well exposed in the numerous narrow gorges cut by the Derwent and its tributaries and by the Dove on the Staffordshire border.

Ashwood Dale, Chee Dale, Millersdale, Monsal Dale and the valley at Matlock are all flanked by abrupt sides of this rock. It is usually a pale, thick-bedded rock, sometimes blue and occasionally, as at Ashford, black. In some places, e.g. Thorpe Cloud, it is highly fossiliferous, but it is usually somewhat barren except for abundant crinoids and smaller organisms. It is polished in large slabs at Ashford, where crinoidal, black and "rosewood" marbles are produced. Volcanic rocks, locally called "Toadstone," are represented in the limestones by intrusive sills and flows of dolerite and by necks of agglomerate, notably near Tideswell, Millersdale and Matlock. Beds and nodules of chert are abundant in the upper parts of the limestone; at Bakewell it is quarried for use in the Potteries. At some points the limestone has been dolomitized; near Bonny it has been converted into a granular silicified rock. A series of black shales with nodular limestones, the Pendleside series, rests upon the Mountain Limestone on the east, south and north-west; much of the upper course of the Derwent has been cut through these soft beds. Mam Tor, or the Shivering Mountain, is made of these shales. Next in upward sequence is a thick mass of sandstones, grits and shales—the Millstone Grit series. On the west side these extend from Blacklow Hill to Aze Edge; on the east, from Derwent Edge to near Derby; outlying masses form the rough moorland on Kinder Scout and the picturesque tors near Stanton-by-Youlgreave. A small patch of Millstone Grit and Limestone occurs in the south of the county about Melbourne and Ticknall. The Coal Measures repose upon the Millstone Grit; the largest area of these rockfields on the east, where they are continuous with the coalfields of Yorkshire and Nottingham. A small tract, part of the Leicestershire coalfield, lies in the south-east corner, and in the north-west corner a portion of the Lancashire coalfield appears about New Mills and Whaley Bridge. They yield valuable coals, clays, marls and ganister. East of Bolsover, the Coal Measures are covered unconformably by the Permian breccias and magnesian limestone. Flanking the hills between Ashbourne and Quarndon are red beds of Bunter marl, sandstone and conglomerate; they also appear at Morley, east of the Derwent, and again round the small southern coalfield. Most of the southern part of the county is occupied by Keuper marls and sandstones, the latter yield good building stone; and at Chellaston the gypsum beds in the former are excavated on a large scale. Much of the Triassic area is covered superficially by glacial drift and alluvium of the Trent. Local boulders as well as northern erratics are found in the valley of the Derwent. The bones of Pleistocene mammals, the rhinoceros, mammoth, bison, hyaena, &c., have been found at numerous places, often in caves and fissures in the limestones, e.g. at Castleton, Wirksworth and Creswell. At Doveholes the Pleistocene *Mastodon* has been reported. Galena and other lead ores are abundant in veins in the limestone, but they are now only worked on a large scale at Mill Close, near Winstan; calamine, zinc, blende, barytes, calcite and fluor-spar are common. A peculiar variety of the last named, called "Blue John," is found only near Castleton; at the same place occurs the remarkable elastic bitumen, "elaterite." Limestone is quarried at Buxton, Millersdale and Matlock for lime, facing and chemical purposes. Good sandstone is obtained from the Millstone Grit at Stancliffe, Tansley and Whatstandwell. Calcareous tufa or travertine occurs in the valley of Matlock and elsewhere, and in some places is still being deposited by springs. Large pits containing deposits of white sand, clay and pebbles are found in the limestone at Longcliff, Newhaven and Carraington.

Climate.—From the elevation which it attains in its northern division the county is colder and is rainier than other midland counties. Even in summer cold and thick fogs are often seen hanging over the rivers, and clinging to the lower parts of the hills, and hoar-frosts are by no means unknown even in June and July. The winters in the uplands are generally severe, and the rainfall heavy. At Buxton, at an elevation of about 1000 ft., the mean temperature in January is 34° F., and in July 57° F., the mean annual being 45° F. These conditions contrast with those at Derby, in the southern lowland, where the figures are

respectively 37° 5', 61° 2' and 48° 8', while intermediate conditions are found at Belper, 9 m. higher up the Derwent valley, where the figures are 36° 3', 59° 0' and 47° 3'. The contrasts shown by the mean annual rainfall are similarly marked. Thus at Woodhead, lying high in the extreme north, it is 52·03 in., at Buxton 49·33 in., at Matlock, in the middle part of the Derwent valley, 35·2 in., and at Derby 24·35 in.

Agriculture.—A little over seven-tenths of the total area of the county is under cultivation. Among the higher altitudes of north Derbyshire, where the soil is poor and the climate harsh, grain is unable to flourish, while even in the more sheltered parts of this region the harvest is usually belated. In such districts sheep farming is chiefly practised, and there is a considerable area of heath pasture. Farther south, heavy crops of wheat, turnips and other cereals and green crops are not uncommon, while barley is cultivated about Repton and Gresley, and also in the east of the county, in order to supply the Burton breweries. A large part of the Trent valley is under permanent pasture, being devoted to cattle-feeding and dairy-farming. This industry has prospered greatly, and the area of permanent pasture encroaches continually upon that of arable land. Derbyshire cheeses are exported or sent to London in considerable quantities; and cheese fairs are held in various parts of the county, as at Ashbourne and Derby. A feature of the upland districts is the total absence of hedges, and the substitution of limestone walls, put together without any mortar or cement.

Other Industries.—The manufactures of Derbyshire are both numerous and important, embracing silks, cotton hosiery, iron, woollen manufactures, lace, elastic web and brewing. For many of these this county has long been famous, especially for that of silk, which is carried on to a large extent in Derby, as well as in Belper and Duffield. Derby is also celebrated for its china, and silk-throwing is the principal industry of the town. Elastic web weaving by power looms is carried on to a great extent, and the manufacture of lace and net curtains, gimp trimmings, braids and cords. In the county town and neighbourhood are several important chemical and colour works; and in various parts of the county, as at Belper, Cromford, Matlock, Tutbury, are cotton-spinning mills, as well as hosiery and tape manufactories. The principal works of the Midland Railway Company are at Derby. The principal mineral is coal. Ironstone is not extensively wrought, but, on account of the abundant supply of coal, large quantities are imported for smelting purposes. There are smelting furnaces in several districts, as at Alfreton, Chesterfield, Derby, Ilkeston. Besides lead, gypsum and zinc are raised, to a small extent; and for the quarrying of limestone Derbyshire is one of the principal English counties. The east and the extreme south-west parts are the principal industrial districts.

Communications.—The chief railway serving the county is the Midland, the south, east and north being served by its main-line and branches. In the north-east and north the Great Central system touches the county; in the west the North Staffordshire and a branch of the London & North-Western; while a branch of the Great Northern serves Derby and other places in the south. The Trent & Mersey canal crosses the southern part of the county, and there is a branch canal (the Derby) connecting Derby with this and with the Erewash canal, which runs north from the Trent up the Erewash valley. From it there is a little-used branch (the Cromford canal) to Matlock.

Population and Administration.—The area of the ancient county is 658,885 acres, with a population in 1801 of 528,033, and 1901 of 620,322. The area of the administrative county is 652,272 acres. The county contains six hundreds. The municipal boroughs are Chesterfield (pop. 27,185), Derby, a county borough and the county town (114,848), Glossop (21,526), Ilkeston (25,384). The other urban districts are Alfreton (17,505), Alvaston and Boulton (1279), Ashbourne (4039), Bakewell (2850), Baslow and Bunnell (797), Belper (10,934), Bolsover (6844), Bonsall (1360), Brampton and Walton (2608), Buxton (10,181), Clay Cross (8358), Dronfield (3809), Fairfield (2069), Heage (2889), Heanor (16,249), Long Eaton (13,045), Matlock (5979), Matlock Bath and Scarthin Nick (1819), Newbold and Dunston (5986).

New Mills (7773), North Darley (2756), Ripley (10,111), South Darley (788), Swadlincote (18,014), Whittington (9416), Wirksworth (3807). Among other towns may be mentioned Ashover (2426), Barlborough (2056), Chapel-en-le-Frith (4626), Clowne (3896), Crich (3063), Killamarsh (3644), Staveley (11,420), Whitwell (3380). The county is in the Midland circuit, and assizes are held at Derby. It has one court of quarter sessions and is divided into fifteen petty sessional divisions. The boroughs of Derby, Chesterfield and Glossop have separate commissions of the peace, and that of Derby has also a separate court of quarter sessions. The total number of civil parishes is 314. The county is mainly in the diocese of Southwell, with small portions in the dioceses of Peterborough and Lichfield, and contains 255 ecclesiastical parishes or districts. The parliamentary divisions of the county are High Peak, North-Eastern, Chesterfield, Mid, Ilkeston, Southern and Western, each returning one member, while the parliamentary borough of Derby returns two members.

History.—The earliest English settlements in the district which is now Derbyshire were those of the West Angles, who in the course of their northern conquests in the 6th century pushed their way up the valleys of the Derwent and the Dove, where they became known as the Pecsætian. Later the district formed the northern division of Mercia, and in 848 the Mercian witenagemot assembled at Repton. In the 9th century the district suffered frequently from the ravages of the Danes, who in 874 wintered at Repton and destroyed its famous monastery, the burial-place of the kings of Mercia. Derby under Guthrum was one of the five Danish burghs, but in 917 was recovered by Æthelred. In 924 Edward the Elder fortified Bakewell, and in 942 Edmund regained Derby, which had fallen under the Danish yoke. Barrows of the Saxon period are numerous in Wirksworth hundred and the Bakewell district, among the most remarkable being White-low near Winstar and Bower's-low near Tissington. There are Saxon cemeteries at Stapenhill and Foremark Hall.

Derbyshire probably originated as a shire in the time of Æthelstan, but for long it maintained a very close connexion with Nottinghamshire, and the Domesday Survey gives a list of local customs affecting the two counties alike. The two shire-courts sat together for the Domesday Inquest, and the counties were united under one sheriff until the time of Elizabeth. The villages of Appleby, Oakthorpe, Donisthorpe, Stretton-en-le-Field, Willealey, Chilcote and Measham were reckoned as part of Derbyshire in 1086, although separated from it by the Leicester-shire parishes of Over and Nether Seat.

The early divisions of the county were known as wapentakes, five being mentioned in Domesday, while 13th-century documents mention seven wapentakes, corresponding with the six present hundreds, except that Repton and Greasley were then reckoned as separate divisions. In the 14th century the divisions were more frequently described as hundreds, and Wirksworth alone retained the designation wapentake until modern times. Ecclesiastically the county constituted an archdeaconry in the diocese of Lichfield, comprising the six deaneries of Derby, Ashbourne, High Peak, Castillar, Chesterfield and Repington. In 1884 it was transferred to the newly formed diocese of Southwell. The assizes for Nottinghamshire and Derbyshire were held at Nottingham until the reign of Henry III., when they were held alternately at Nottingham and Derby until 1569, after which the Derbyshire assizes were held at Derby. The court of the Honour of Peverel, held at Basford in Nottinghamshire, which formerly exercised jurisdiction in the hundreds of Scarsdale, the Peak and Wirksworth, was abolished in 1840. The miners of Derbyshire formed an independent community under the jurisdiction of a steward and barmasters, who held two Barmote courts (g.s.) every year. The forests of Peak and Duffield had their separate courts and officers, the justice seat of the former being in an extra-parochial part at equal distances from Castleton, Tideswell and Bowden, while the pleas of Duffield Forest were held at Tutbury. Both were disafforested in the 17th century.

The greatest landholder in Derbyshire at the time of the Domesday Survey was Henry de Ferrers, who owned almost the

whole of the modern hundred of Appletree. The Ferrers estates were forfeited by Robert, earl of Derby, in the reign of Henry III. Another great Domesday landholder was William Peverel, the historic founder of Peak Castle, whose vast possessions were known as the Honour of Peverel. In 1155 the younger Peverel was disinherited for poisoning the earl of Chester, and his estates forfeited to the crown. Few Englishmen retained estates of any importance after the Conquest, but one, Elin, an under-tenant of Henry de Ferrers, not only held a considerable property but was the ancestor of the Derbyshire family of Brailsford. The families of Shirley and Greasley can also boast an unbroken descent from Domesday tenants.

During the rebellion of Prince Henry against Henry II. the castles of Tutbury and Duffield were held against the king, and in the civil wars of John's reign Bolsover and Peak Castles were garrisoned by the rebellious barons. In the Barons' War of the reign of Henry III. the earl of Derby was active in stirring up feeling in the county against the king, and in 1266 assembled a considerable force, which was defeated by the king's party at Chesterfield. At the time of the Wars of the Roses discontent was rife in Derbyshire, and riots broke out in 1443, but the county did not lend active support to either party. On the outbreak of the Civil War of the 17th century, the county at first inclined to support the king, who received an enthusiastic reception when he visited Derby in 1642, but by the close of 1643 Sir John Gell of Hopton had secured almost the whole county for the parliament. Derby, however, was always royalist in sympathy, and did not finally surrender till 1646; in 1659 it rebelled against Richard Cromwell, and in 1745 entertained the young Pretender.

Derbyshire has always been mainly a mining and manufacturing county, though the rich land in the south formerly produced large quantities of corn. The lead mines were worked by the Romans, and the Domesday Survey mentions lead mines at Wirksworth, Matlock, Bakewell, Ashford and Crich. Iron has also been produced in Derbyshire from an early date, and coal mines were worked at Norton and Alfreton in the beginning of the 14th century. The woollen industry flourished in the county before the reign of John, when an exclusive privilege of dyeing cloth was conceded to the burgesses of Derby. Thomas Fuller writing in 1662 mentions lead, malt and ale as the chief products of the county, and the Buxton waters were already famous in his day. The 18th century saw the rise of numerous manufactures. In 1778 Sir Thomas and John Lombe set up an improved silk-throwing machine at Derby, and in 1758 Jedediah Strutt introduced a machine for making ribbed stockings, which became famous as the "Derby rib." In 1771 Sir Richard Arkwright set up one of his first cotton mills in Cromford, and in 1787 there were twenty-two cotton mills in the county. The Derby porcelain or china manufactory was started about 1750.

From 1295 until the Reform Act of 1832 the county and town of Derby each returned two members to parliament. From this latter date the county returned four members in two divisions until the act of 1868, under which it returned six members for three divisions.

Antiquities.—Monastic remains are scanty, but there are interesting portions of a priory incorporated with the school buildings at Repton. The village church of Beauchief Abbey, near Dronfield, is a remnant of an abbey founded c. 1175 by Robert Fitzranulf. It has a stately transitional Norman tower, and three fine Norman arches. Dale Abbey, near Derby, was founded early in the 13th century for the Premonstratensian order. The ruins are scanty, but the east window is preserved, and the present church incorporates remains of the ancient rest-house for pilgrims. The church has a peculiar music gallery, entered from without. The abbey church contained famous stained glass, and some of this is preserved in the neighbouring church at Morley. Derbyshire is rich in ecclesiastical architecture as a whole. The churches are generally of various styles. The chancel of the church at Repton is assigned to the second half of the 10th century, though subsequently altered, and the crypt beneath is supposed to be earlier still; its roof is supported by

four round pillars, and it is approached by two stairways. Other remains of pre-Conquest date are the chancel arches in the churches of Marston Montgomery and of Sawley; and the curiously carved font in Wilne church is attributed to the same period. Examples of Norman work are frequent in doorways, as in the churches of Allestree and Willington near Repton, while a fine tympanum is preserved in the modern church of Findern. There is a triple-recessed doorway, with arcade above, in the west end of Bakewell church, and there is another fine west doorway in Melbourne church, a building principally of the late Norman period, with central and small western towers. In restoring this church curious mural paintings were discovered. At Steetley, near Worksop, is a small Norman chapel, with apse, restored from a ruinous condition; Youlgrave church, a building of much general interest, has Norman nave pillars and a fine font of the same period, and Normanton church has a peculiar Norman corbel table. The Early English style is on the whole less well exemplified in the county, but Ashbourne church, with its central tower and lofty spire, contains beautiful details of this period, notably the lancet windows in the Cockayne chapel.

The parish churches of Dronfield, Hathersage (with some notable stained glass), Sandiacre and Tideswell exemplify the Decorated period; the last is a particularly stately and beautiful building, with a lofty and ornate western tower and some good early brasses. The churches of Dethic, Wirksworth and Chesterfield are typical of the Perpendicular period; that of Wirksworth contains noteworthy memorial chapels, monuments and brasses, and that of Chesterfield is celebrated for its crooked spire.

The remains of castles are few; the ancient Bolsover Castle is replaced by a castellated mansion of the 17th century; of the Norman Peak Castle near Castleton little is left; of Codnor Castle in the Erewash valley there are picturesque ruins of the 13th century. Among ancient mansions Derbyshire possesses one of the most famous in England in Haddon Hall, of the 15th century. Wingfield manor house is a ruin dating from the same century. Hardwick Hall is a very perfect example of Elizabethan building; ruins of the old Tudor hall stand near by. Other Elizabethan examples are Barlborough and Tissington Halls.

The village of Tissington is noted for the maintenance of an old custom, that of "well-dressing." On the Thursday before Easter a special church service is celebrated, and the wells are beautifully ornamented with flowers, prayers being offered at each. The ceremony has been revived also in several other Derbyshire villages.

See Davies, *New Historical and Descriptive View of Derbyshire* (Belper, 1817); D. Lysons, *Magna Britannia*, vol. v. (London, 1817); *Miners' Glossary* (Bakewell, 1824); R. Simpson, *Collection of Fragments illustrative of the History of Derbyshire* (1826); S. Glover, *History and Gazetteer of the County of Derby*, ed. T. Noble, part 1 of vols. i. and ii. (Derby, 1831-1833); T. Bateman, *Vestiges of the Antiquities of Derbyshire* (London, 1848); L. Jewitt, *Ballads and Songs of Derbyshire* (London, 1867); J. C. Cox, *Notes on the Churches of Derbyshire* (Chester, 1875), and *Three Centuries of Derbyshire Annals* (2 vols., London, 1890); R. N. Worth, *Derby, in "Popular County Histories"* (London, 1886); J. P. Yeatman, *Federal History of the County of Derby* (3 vols., London, 1886-1895); *Victoria County History, Derbyshire*. See also *Notes and Derbyshire Notes and Queries*.

DEREHAM (properly EAST DEREHAM), a market town in the Mid parliamentary division of Norfolk, England, 122 m. N.N.E. from London by the Great Eastern railway. Pop. of urban district (1901) 5545. The church of St Nicholas is a cruciform Perpendicular structure with a beautiful central tower, and some portions of earlier date. It contains a monument to William Cowper, who came to live here in 1796, and the Congregational chapel stands on the site of the house where the poet spent his last days. Dereham is an important agricultural centre with works for the manufacture of agricultural implements, iron foundries and a malting industry.

DERELICT (from Lat. *derelinquere*, to forsake), in law, property thrown away or abandoned by the owner in such a manner as to indicate that he intends to make no further claim to

it. The word is used more particularly with respect to property abandoned at sea (see **WRECK**), but it is also applied in other senses; for example, land gained from the sea by receding of the water is termed *dereliction*. Land gained gradually and slowly by dereliction belongs to the owner of the adjoining land, but in the case of sudden or considerable dereliction the land belongs to the Crown. This technical use of the term "dereliction" is to be distinguished from the more general modern sense, dereliction or abandonment of duty, which implies a culpable failure or neglect in moral or legal obligation.

DERENBOURG, JOSEPH (1811-1895), Franco-German orientalist. He was a considerable force in the educational revival of Jewish education in France. He made great contributions to the knowledge of Saadia, and planned a complete edition of Saadia's works in Arabic and French. A large part of this work appeared during his lifetime. He also wrote an *Essai sur l'histoire et la géographie de la Palestine* (Paris, 1867). This was an original contribution to the history of the Jews and Judaism in the time of Christ, and has been much used by later writers on the subject (e.g. by Schrürer). He also published in collaboration with his son Hartwig, *Opuscules et traités d'Abou-'l-Walid* (with translation, 1830); *Deux Vaseaux hébraïques du livre de Kalild et Dimnah* (1881), and a Latin translation of the same story under the title *Joannis de Capua directorium vite humane* (1889); *Commentaire de Matmonide sur la Mischnah Seder Tohorot* (Berlin, 1886-1891); and a second edition of S. de Sacy's *Séances de Hariri*. He died on the 29th of July 1895, at Ems.

His son, **HARTWIG DERENBOURG** (1844-1908), was born in Paris on the 17th of June 1844. He was educated at Göttingen and Leipzig. Subsequently he studied Arabic at the École des Langues Orientales. In 1879 he was appointed professor of Arabic, and in 1886 professor of Mahomedan Religion, at the École des Hautes Études in Paris. He collaborated with his father in the great edition of Saadia and the edition of Abu-'l-Walid, and also produced a number of important editions of other Arabic writers. Among these are *Le Dîwan de Nâbîga Dhobyânî*; *Le Livre de Sibawaihi* (2 vols., Paris, 1881-1889); *Chrestomathie élémentaire de l'arabe littéral* (in collaboration with Spiro, 1885; 2nd ed., 1892); *Ousma ibn Mounkidd, un émir syrien* (1889); *Ousma ibn Mounkidd, préface du livre du bâton* (with trans., 1887); *Al-Fâhrî* (1895); *Oumdra du Gémec* (1897), a catalogue of Arabic MSS. in the Escorial (vol. i., 1884).

DERG, LOUGH, a lake of Ireland, on the boundary of the counties Galway, Clare and Tipperary. It is an expansion of the Shannon, being the lowest lake on that river, and is 23 m. long and generally from 1 to 3 m. broad. It lies where the Shannon leaves the central plain of Ireland and flows between the hills which border the plain. While the northerly shores of the lake, therefore, are flat, the southern are steep and picturesque, being backed by the Slieve Aughty, Slieve Bernagh and Arra Mountains. Ruined churches and fortresses are numerous on the eastern shore, and on Iniscaltra Island are a round tower and remains of five churches.

Another **LOUGH DERG**, near Pettigo in Donegal, though small, is famous as the traditional scene of St Patrick's purgatory. In the middle ages its pilgrimages had a European reputation, and they are still observed annually by many of the Irish from June 1 to August 15. The hospice, chapels, &c., are on Station Island, and there is a ruined monastery on Saints' Island.

DERHAM, WILLIAM (1657-1735), English divine, was born at Stoulton, near Worcester, on the 26th of November 1657. He was educated at Blockley, in his native county, and at Trinity College, Oxford. In 1682 he became vicar of Wargrave, in Berkshire; and in 1689 he was preferred to the living of Upminster, in Essex. In 1696 he published his *Artificial Clockmaker*, which went through several editions. The best known of his subsequent works are *Physico-Theology*, published in 1713; *Astro-Theology*, 1714; and *Christo-Theology*, 1730. The first two of these books were theological arguments for the being and attributes of God, and were used by Paley nearly a century later. In 1702 Derham

was elected fellow of the Royal Society, and in 1716 was made a canon of Windsor. He was Boyle lecturer in 1711-1712. His last work, entitled *A Defence of the Church's Right in Leasehold Estates*, appeared in 1731. He died on the 5th of April 1735. Besides the works published in his own name, Derham, who was keenly interested in natural history, contributed a variety of papers to the *Transactions of the Royal Society*, revised the *Miscellanea Curiosa*, edited the correspondence of John Ray and Eleazar Albin's *Natural History*, and published some of the MSS. of Robert Hooke, the natural philosopher.

D'ERLON, JEAN BAPTISTE DROUET, COUNT (1765-1844), marshal of France, was born at Reims on the 29th of July 1765. He entered the army as a private soldier in 1782, was discharged after five years' service, re-entered it in 1792, and rose rapidly to the rank of an officer. From 1794 to 1796 he was aide-de-camp to General Lefebvre. He did good service in the campaigns of the revolutionary wars and in 1799 attained the rank of general of brigade. In the campaign of that year he was engaged in the Swiss operations under Masséna. In 1800 he fought under Moreau at Hohenlinden. As a general of division he took part in Napoleon's campaigns of 1805 and 1806, and rendered excellent service at Jena. He was next engaged under Lefebvre in the siege of Danzig and negotiated the terms of surrender; after this he rejoined the field army and fought at Friedland (1807), receiving a severe wound. After this battle he was made grand officer of the Legion of Honour, was created Count d'Erlon and received a pension. For the next six years d'Erlon was almost continuously engaged as commander of an army corps in the Peninsular War, in which he added greatly to his reputation as a capable general. At the pass of Maya in the Pyrenees he inflicted a defeat upon Lord Hill's troops, and in the subsequent battles of the 1814 campaign he distinguished himself further. After the first Restoration he was named commander of the 16th military division, but he was soon arrested for conspiring with the Orléans party, to which he was secretly devoted. He escaped, however, and gave in his adhesion to Napoleon, who had returned from Elba. The emperor made him a peer of France, and gave him command of the I. army corps, which formed part of the Army of the North. In the Waterloo campaign d'Erlon's corps formed part of Ney's command on the 16th of June, but, in consequence of an extraordinary series of misunderstandings, took part neither at Ligny nor at Quatre Bras (see WATERLOO CAMPAIGN). He was not, however, held to account by Napoleon, and as the latter's practice in such matters was severe to the verge of injustice, it may be presumed that the failure was not due to d'Erlon.

He was in command of the right wing of the French army throughout the great battle of the 18th of June, and fought in the closing operations around Paris. At the second Restoration d'Erlon fled into Germany, only returning to France after the amnesty of 1825. He was not restored to the service until the accession of Louis Philippe, in whose interests he had engaged in several plots and intrigues. As commander of the 12th military division (Nantes), he suppressed the legitimist agitation in his district and caused the arrest of the duchess of Berry (1832). His last active service was in Algeria, of which country he was made governor-general in 1834 at the age of seventy. He returned to France after two years, and was made marshal of France shortly before his death at Paris on the 25th of January 1844.

DERMOT MAC MURROUGH (d. 1171), Irish king of Leinster, succeeded his father in the principality of the *Huí Cinsellaigh* (1115) and eventually in the kingship of Leinster. The early events of his life are obscure; but about 1152 we find him engaged in a feud with O Ruairc, the lord of Breifne (Leitrim and Cavan). Dermot abducted the wife of O Ruairc more with the object of injuring his rival than from any love of the lady. The injured husband called to his aid Roderic, the high king (aird-ri) of Connaught; and in 1166 Dermot fled before this powerful coalition to invoke the aid of England. Obtaining from Henry II. a licence to enlist allies among the Welsh marchers, Dermot secured the aid of the Clares and Geraldines. To Richard

Strongbow, earl of Pembroke and head of the house of Clare, Dermot gave his daughter Eva in marriage; and on his death was succeeded by the earl in Leinster. The historical importance of Dermot lies in the fact that he was the means of introducing the English into Ireland. Through his aid the towns of Waterford, Wexford and Dublin had already become English colonies before the arrival of Henry II. in the island.

See *The Song of Dermot and the Earl, an old French Poem (by M. Regan?)*, ed. with trans. by G. H. Orpen, 1892; Kate Norygate, *England under the Angevin Kings*, vol. ii. (H. W. C. D.)

DERNA (anc. *Darnis-Zarine*), a town on the north coast of Africa and capital of the eastern half of the Ottoman province of Bengazi or Barca. Situated below the eastern butt of Jebel Akhdar on a small but rich deltaic plain, watered by fine perennial springs, it has a growing population and trade, the latter being mainly in fruits grown in its extensive palm gardens, and in hides and wool brought down by the nomads from the interior. If the port were better there would be more rapid expansion. The bay is open from N.W. round to S.E. and often inaccessible in winter and spring, and the steamers of the *Nav. Gen. Italiana* sometimes have to pass without calling. The population has recovered from the great plague epidemic of 1821 and reached its former figure of about 7000. A proportion of it is of Moorish stock, of Andalusian origin, which emigrated in 1493; the descendants preserve a fine facial type. The sheikhs of the local Bedouin tribes have houses in the place, and a Turkish garrison of about 250 men is stationed in barracks. There is a lighthouse W. of the bay. A British consular agent is resident and the Italians maintain a vice-consul. The names Darnis and Zarine are philologically identical and probably refer to the same place. No traces are left of the ancient town except some rock tombs. Darnis continued to be of some importance in early Moslem times as a station on the Alexandria-Kairwan road, and has served on more than one occasion as a base for Egyptian attacks on Cyrenaica and Tripolitana. In 1805 the government of the United States, having a quarrel with the dey of Tripoli on account of piracies committed on American shipping, landed a force to co-operate in the attack on Derna then being made by Sidi Ahmet, an elder brother of the dey. This force, commanded by William Eaton (q.v.), built a fort, whose ruins and rusty guns are still to be seen, and began to improve the harbour; but its work quickly came to an end with the conclusion of peace. After 1835 Derna passed under direct Ottoman control, and subsequently served as the point whence the sultan exerted a precarious but increasing control over eastern Cyrenaica and Marmarica. It is now in communication by wireless telegraphy with Rhodes and western Cyrenaica. It is the only town, or even large village, between Bengazi and Alexandria (600 m.) (D. G. H.)

DÉROULEDE, PAUL (1846-), French author and politician, was born in Paris on the 2nd of September 1846. He made his first appearance as a poet in the pages of the *Revue nationale*, under the pseudonym of Jean Rebel, and in 1869 produced at the Théâtre Français a one-act drama in verse entitled *Juan Strenner*. On the outbreak of the Franco-German War he enlisted as a private, was wounded and taken prisoner at Sedan, and sent to Breslau, but effected his escape. He then served under Chanzy and Bourbaki, took part in the latter's disastrous retreat to Switzerland, and fought against the Commune in Paris. After attaining the rank of lieutenant, he was forced by an accident to retire from the army. He published in 1872 a number of patriotic poems (*Chants du soldat*), which enjoyed unbounded popularity. This was followed in 1875 by another collection, *Nouveaux Chants du soldat*. In 1877 he produced a drama in verse called *L'Helman*, which derived a passing success from the patriotic fervour of its sentiments. For the exhibition of 1878 he wrote a hymn, *Vive la France*, which was set to music by Gounod. In 1880 his drama in verse, *La Modibite*, which had been accepted by the Théâtre Français, was forbidden by the censor on religious grounds. In 1888 M. Déroulède founded the *Ligue des patriotes*, with the object of furthering France's "revanche" against Germany. He was one of the first advocates of a Franco-Russian alliance, and as early as 1883 undertook a journey to Russia for

the furtherance of that object. On the rise of General Boulanger, M. Déroulède attempted to use the *Ligue des patriotes*, hitherto a non-political organization, to assist his cause, but was deserted by a great part of the league and forced to resign his presidency. Nevertheless he used the section that remained faithful to him with such effect that the government found it necessary in 1889 to decree its suppression. In the same year he was elected to the chamber as member for Angoulême. He was expelled from the chamber in 1890 for his disorderly interruptions during debate. He did not stand at the elections of 1893, but was re-elected in 1898, and distinguished himself by his violence as a nationalist and anti-Dreyfusard. After the funeral of President Faure, on the 23rd of February 1899, he endeavoured to persuade General Roge to lead his troops upon the *Élysée*. For this he was arrested, but on being tried for treason was acquitted (May 31). On the 12th of August he was again arrested and accused, together with André Buffet, Jules Guérin and others, of conspiracy against the republic. After a long trial before the high court, he was sentenced, on the 4th of January 1900, to ten years' banishment from France, and retired to San Sebastian. In 1901, he was again brought prominently before the public by a quarrel with his Royalist allies, which resulted in an abortive attempt to arrange a duel with M. Buffet in Switzerland. In November 1905, however, the law of amnesty enabled him to return to France.

Besides the works already mentioned, he published *Le Sergent*, in the *Théâtre de campagne* (1880); *De l'éducation nationale* (1882); *Monsieur le Uhlán et les trois couleurs* (1884); *Le Premier grenadier de France; La Tour d'Auvergne* (1886); *Le Livre de la ligue des patriotes* (1887); *Refrains militaires* (1888); *Histoire d'amour* (1890); a pamphlet entitled *Désarmement* (1891); *Chants du paysan* (1894); *Poésies Militaires* (1896) and *Messire du Guesclin, drame en vers* (1895); *La mort de Hoche. Cinq actes en prose* (1897); *La Plus belle fille du monde, conte dialogué en vers libres* (1898).

DERRICK, a sort of crane (q.v.); the name is derived from that of a famous early 17th-century Tyburn hangman, and was originally applied as a synonym.

DERRING-DO, valour, chivalrous conduct, or "desperate courage," as it is defined by Sir Walter Scott. The word in its present accepted substantival form is a misconstruction of the verbal substantive *dorryng* or *durring*, daring, and *do* or *dom*, the present infinitive of "do," the phrase *dorryng do* thus meaning "daring to do." It is used by Chaucer in *Troilus*, and by Lydgate in the *Chronicles of Troy*. Spenser in the *Shepherd's Calendar* first adapted *derring-do* as a substantive meaning "manhood and chivalrie," and this use was revived by Scott, through whom it came into vogue with writers of romance.

DE RUYTER, MICHAEL ADRIANZON (1607-1676), Dutch naval officer, was born at Flushing on the 24th of March 1607. He began his seafaring life at the age of eleven as a cabin boy, and in 1636 was entrusted by the merchants of Flushing with the command of a cruiser against the French pirates. In 1640 he entered the service of the States, and, being appointed rear-admiral of a fleet fitted out to assist Portugal against Spain, specially distinguished himself at Cape St Vincent, on the 3rd of November 1641. In the following year he left the service of the States, and, until the outbreak of war with England in 1652, held command of a merchant vessel. In 1653 a squadron of seventy vessels was despatched against the English, under the command of Admiral Tromp. Ruyter, who accompanied the admiral in this expedition, seconded him with great skill and bravery in the three battles which were fought with the English. He was afterwards stationed in the Mediterranean, where he captured several Turkish vessels. In 1659 he received a commission to join the king of Denmark in his war with the Swedes. As a reward of his services, the king of Denmark ennobled him and gave him a pension. In 1661 he grounded a vessel belonging to Tunis, released forty Christian slaves, made a treaty with the Tunisians, and reduced the Algerine corsairs to submission. From his achievements on the west coast of Africa he was recalled in 1665

to take command of a large fleet which had been organized against England, and in May of the following year, after a long contest off the North Foreland, he compelled the English to take refuge in the Thames. On the 7th of June 1672 he fought a drawn battle with the combined fleets of England and France, in Southwold or Sole Bay, and after the fight he convoyed safely home a fleet of merchantmen. His valour was displayed to equal advantage in several engagements with the French and English in the following year. In 1676 he was despatched to the assistance of Spain against France in the Mediterranean, and, receiving a mortal wound in the battle on the 21st of April off Messina, died on the 29th at Syracuse. A patent by the king of Spain, investing him with the dignity of duke, did not reach the fleet till after his death. His body was carried to Amsterdam, where a magnificent monument to his memory was erected by command of the states-general.

See *Life of De Ruyter* by Brandt (Amsterdam, 1687), and by Klopp (2nd ed., Hanover, 1858).

DERVISH, a Persian word, meaning "seeking doors," i.e. "beggar," and thus equivalent to the Arabic *faqir* (fakir). Generally in Islam it indicates a member of a religious fraternity, whether mendicant or not; but in Turkey and Persia it indicates more exactly a wandering, begging religious, called, in Arabic-speaking countries, more specifically a *faqir*. With important differences, the dervish fraternities may be compared to the regular religious orders of Roman Christendom, while the *Ulema* (q.v.) are, also with important differences, like the secular clergy. The origin and history of the mystical life in Islam, which led to the growth of the order of dervishes, are treated under *ŞŪR'ISM*. It remains to treat here more particularly of (1) the dervish fraternities, and (2) the *Şūfi* hierarchy.

1. *The Dervish Fraternities*.—In the earlier times, the relation between devotees was that of master and pupil. Those inclined to the spiritual life gathered round a revered sheikh (*murshid*, "guide," *ustadh*, *pir*, "teacher"), lived with him, shared his religious practices and were instructed by him. In time of war against the unbelievers, they might accompany him to the threatened frontier, and fight under his eye. Thus *murābī*, "one who pickets his horse on a hostile frontier," has become the *marabout* (q.v.) or dervish of French Algeria; and *ribat*, "a frontier fort," has come to mean a monastery. The relation, also, might be for a time only. The pupil might at any time return to the world, when his religious education and training were complete. On the death of the master the memory of his life and sayings might go down from generation to generation, and men might boast themselves as pupils of his pupils. Continuous corporations to perpetuate his name were slow in forming. Ghazali himself, though he founded, taught and ruled a *Şūfi* cloister (*khānqāh*) at Tus, left no order behind him. But 'Adī al-Hakkārī, who founded a cloister at Mosul and died about 1163, was long revered by the 'Adawite Fraternity, and in 1166 died 'Abd al-Qādir al-Jilāni, from whom the Qādirite order descends, one of the greatest and most influential to this day. The troublous times of the break up of the Seljuk rule may have been a cause in this, as, with St Benedict, the crumbling Roman empire. Many existing fraternities, it is true, trace their origin to saints of the third, second and even first Moslem centuries, but that is legend purely. Similar is the tendency to claim all the early pious Moslems as good *Şūfis*; collections of *Şūfi* biography begin with the ten to whom Mahomet promised Paradise. So, too, the ultimate origin of fraternities is assigned to either Al or Abu Bekr. and in Egypt all are under the rule of a direct descendant of the latter.

To give a complete list of these fraternities is quite impossible. Commonly, thirty-two are reckoned, but many have vanished or have been suppressed, and there are sub-orders innumerable. Each has a "rule" dating back to its founder, and a ritual which the members perform when they meet together in their convent (*khānqāh*, *sūriya*, *takya*). This may consist simply in the repetition of sacred phrases, or it may be an elaborate performance, such as the whirlings of the dancing dervishes, the Mevlevites, an order founded by Jelāl ud-Dīn ar-Rūmī, the author of the

great Persian mystical poem, the *Mesnevi*, and always ruled by one of his descendants. Jelâl ud-Dîn was an advanced pantheist, and so are the Mevlevites, but that seems only to earn them the dislike of the Ulama, and not to affect their standing in Islam. They are the most broad-minded and tolerant of all. There are also the performances of the Rifâ'ites or "howling dervishes." In ecstasy they cut themselves with knives, eat live coals and glass, handle red-hot iron and devour serpents. They profess miraculous healing powers, and the head of the Sa'dites, a sub-order, used, in Cairo, to ride over the bodies of his dervishes without hurting them, the so-called *Döseb* (*dausa*). These different abilities are strictly regulated. Thus, one sub-order may eat glass and another may eat only serpents. Another division is made by their attitude to the law of Islam. When a dervish is in a state of ecstasy (*majdhâb*), he is supposed to be unconscious of the actions of his body. Reputed saints, therefore, can do practically anything, as their souls will be supposed to be out of their bodies and in the heavenly regions. They may not only commit the vilest of actions, but neglect in general the ceremonial and ritual law. This goes so far that in Persia and Turkey dervish orders are classified as *bâ-shar*, "with law," and *bi-shar*, "without law." The latter are really antinomians, and the best example of them is the Baktashite order, widely spread and influential in Turkey and Albania and connected by legend with the origin of the Janissaries. The Qalandarite order is known to all from the "Calenders" of the *Thousand and One Nights*. They separated from the Baktashites and are under obligation of perpetual travelling. The Senussi (Senussia) were the last order to appear, and are distinguished from the others by a severely puritanic and reforming attitude and strict orthodoxy, without any admixture of mystical slackness in faith or conduct. Each order is distinguished by a peculiar garb. Candidates for admission have to pass through a novitiate, more or less lengthy. First comes the *ahd*, or initial covenant, in which the neophyte or *murid*, "seeker," repents of his past sins and takes the sheikh of the order he enters as his guide (*murshid*) for the future. He then enters upon a course of instruction and discipline, called a "path" (*tarikqa*), on which he advances through diverse "stations" (*maqâmat*) or "passes" (*'aqâbat*) of the spiritual life. There is a striking resemblance here to the gnostic system, with its seven Archon-guarded gates. On another side, it is plain that the sheikh, along with ordinary instruction of the novice, also hypnotizes him and causes him to see a series of visions, marking his penetration of the divine mystery. The part that hypnosis and autohypnosis, conscious and unconscious, has played here cannot easily be overestimated. The Mevlevites seem to have the most severe novitiate. Their aspirant has to labour as a lay servant of the lowest rank for 100 days—called the *kârâ kolâk*, or "jackal"—before he can be received. For one day's failure he must begin again from the beginning.

But besides these full members there is an enormous number of lay adherents, like the tertiaries of the Franciscans. Thus, nearly every religious man of the Turkish Moslem world is a lay member of one order or another, under the duty of saying certain prayers daily. Certain trades, too, affect certain orders. Most of the Egyptian Qâdirites, for example, are fishermen and, on festival days, carry as banners nets of various colours. On this side, the orders bear a striking resemblance to lodges of Freemasons and other friendly societies, and points of direct contact have even been alleged between the more pantheistic and antinomian orders, such as the Baktashite, and European Freemasonry. On another side, just as the *dihirs* of the early ascetic mystics suggest comparison with the class-meetings of the early Methodists, so these orders are the nearest approach in Islam to the different churches of Protestant Christendom. They are the only ecclesiastical organization that Islam has ever known, but it is a multiform organization, unclassified internally or externally. They differ thus from the Roman monastic orders, in that they are independent and self-developing, each going its own way in faith and practice, limited only by the universal conscience (*shimâ*, "agreement": see MAHOMMEDAN LAW) of Islam. Strange doctrines and moral defects may develop, but

freedom is saved, and the whole people of Islam can be reached and affected.

2. *Saints and the Şûfi Hierarchy*.—That an elaborate doctrine of wonder-working saints should have grown up in Islam may, at first sight, appear an extreme paradox. It can, however, be conditioned and explained. First, Mahomet left undoubted loop-holes for a minor inspiration, legitimate and illegitimate. Secondly, the Şûfis, under various foreign influences, developed these to the fullest. Thirdly, just as the Christian church has absorbed much of the mythology of the supposed exterminated heathen religions into its cult of local saints, so Islam, to an even higher degree, has been overlaid and almost buried by the superstitions of the peoples to which it has gone. Their religious and legal customs have completely overcome the direct commands of the Koran, the traditions from Mahomet and even the "Agreement" of the rest of the Moslem world (see MAHOMMEDAN LAW). The first step in this, it is true, was taken by Mahomet himself when he accepted the Meccan pilgrimage and the Black Stone. The worship of saints, therefore, has appeared everywhere in Islam, with an absolute belief in their miracles and in the value of their intercession, living or dead.

Further, there appeared very early in Islam a belief that there was always in existence some individual in direct intercourse with God and having the right and duty of teaching and ruling all mankind. This individual might be visible or invisible; his right to rule continued. This is the basis of the Ismâ'îlite and Shi'ite positions (see MAHOMMEDAN RELIGION and MAHOMMEDAN INSTITUTIONS). The Şûfis applied this idea of divine right to the doctrine of saints, and developed it into the Şûfi hierarchy. This is a single, great, invisible organization, forming a saintly board of administration, by which the invisible government of the world is supposed to be carried on. Its head is called the *Qutb* (AXIS); he is presumably the greatest saint of the time, is chosen by God for the office and given greater miraculous powers and rights of intercession than any other saint enjoys. He wanders through the world, often invisible and always unknown, performing the duties of his office. Under him there is an elaborate organization of *walis*, of different ranks and powers, according to their sanctity and faith. The term *wali* is applied to a saint because of Kor. x. 63, "Ho! the *walis* of God; there is no fear upon them, nor do they grieve," where *wali* means "one who is near," friend or favourite.

In the fraternities, then, all are dervishes, cloistered or lay, those whose faith is so great that God has given them miraculous powers—and there are many—are *walis*; begging friars are *fukirs*. All forms of life—solitary, monastic, secular, celibate, married, wandering, stationary, ascetic, free—are open. Their theology is some form of Sûfîism.

AUTHORITIES.—The bibliography of this subject is very large, and the following only a selection:—(1) *On Dervishes*. In Egypt, Lane's *Modern Egyptians*, chap. x. xx., xxiv., xxv.; in Turkey, D'Osson, *Tableau général de l'emp. ottoman*, ii. (Paris, 1790): *Turkey in Europe* by "Odysseus" (London, 1900); in Persia, E. G. Browne, *A Year among the Persians* (1893); in Morocco, T. H. Weir, *Sheikhs of Morocco* (Edinburgh, 1904); B. Meakin, *The Moors* (London, 1902), chap. xix.; in Central Asia, all Vambéry's books of travel and history. In general, Hughes, *Dict. of Islam*, s.v. "Faquir"; Depont and Cappelani, *Les Confréries religieuses musulmanes* (Alger, 1897); J. P. Brown, *The Dervishes, or Oriental Spiritualism* (London, 1868). (2) *On Saints*. I. Goldziher, *Muhammedanische Studien*, ii. 277 ff., and "De l'ascétisme aux premiers temps de l'Islam" in *Revue de l'histoire des religions*, vol. xxxvii. pp. 134 ff.; Lane, *Modern Egyptians*, chap. x.; Arabus *Nights*, chap. iii. note 63; Vollers in *Zeitsch. d. morgenl. Gesellsch.* liii. 115 ff. (D. B. MA.)

DERWENT (Celtic *Dur-ent*, clear water), the name of several English rivers. (1) The Yorkshire Derwent collects the greater part of the drainage of the North Yorkshire moors, rising in their eastern part. A southern head-stream, however, rises in the Yorkshire Wolds near Filey, little more than a mile from the North Sea, from which it is separated by a morainic deposit, and thus flows in an inland direction. The early course of the Derwent lies through a flat open valley between the North Yorkshire moors and the Yorkshire Wolds, the upper part of which is known as the Carrs, when the river follows an artificial drainage cut. It receives numerous tributaries from the moors, then breaches the

low hills below Malton in a narrow picturesque valley, and debouches upon the central plain of Yorkshire. Its direction, hitherto westerly and south-westerly from the Carrs, now becomes southerly, and it flows roughly parallel to the Ouse, which it joins near Barmby-on-the-Marsh, in the level district between Selby and the head of the Humber estuary, after a course, including minor sinuosities, of about 70 m. As a tributary of the Ouse it is included in the Humber basin. It is tidal up to Sutton-upon-Derwent, 15 m. from the junction with the Ouse, and is locked up to Malton, but the navigation is little used. A canal leads east from the tidal water to the small market town of Pecklington.

(2) The Derbyshire Derwent rises in Bleaklow Hill north of the Peak and traverses a narrow dale, which, with those of such tributary streams as the Noc, watering Hope Valley, and the Wye, is famous for its beauty (see DERBYSHIRE). The Derwent flows south past Chatsworth, Matlock and Belper and then, passing Derby, debouches upon a low plain, and turns south-eastward, with an extremely sinuous course, to join the Trent near Sawley. Its length is about 60 m. It falls in all some 1700 ft. (from Matlock 200 ft.), and no part is navigable, save certain reaches at Matlock and elsewhere for pleasure boats.

(3) The Cumberland Derwent rises below Great End in the Lake District, draining Spinkling and Sty Head tarns, and flows through Borrowdale, receiving a considerable tributary from Lang Strath. It then drains the lakes of Derwentwater and Bassenthwaite, after which its course, hitherto N. and N.N.W., turns W. and W. by S. past Cockermouth to the Irish Sea at Workington. The length is about 34 m., and the fall about 2000 ft. (from Derwentwater 244 ft.); the waters are usually beautifully clear, and the river is not navigable. At a former period this stream must have formed one large lake covering the whole area which includes Derwentwater and Bassenthwaite; between which a flat alluvial plain is formed of the deposits of the river Greta, which now joins the Derwent from the east immediately below Derwentwater, and the Newlands Beck, which enters Bassenthwaite. In time of high flood this plain is said to have been submerged, and the two lakes thus reunited.

(4) A river Derwent rises in the Pennines near the borders of Northumberland and Durham, and, forming a large part of the boundary between these counties, takes a north-easterly course of 30 m. to the Tyne, which it joins 3 m. above Newcastle.

DERWENTWATER, EARL OF, an English title borne by the family of Radclyffe, or Radcliffe, from 1688 to 1716 when the 3rd earl was attainted and beheaded, and claimed by his descendants, adherents of the exiled house of Stewart, from that date until the death of the last male heir in 1814. Sir Francis Radclyffe, 3rd baronet (1625-1697), was the lineal descendant of Sir Nicholas Radclyffe, who acquired the extensive Derwentwater estates in 1417 through his marriage with the heiress of John de Derwentwater, and of Sir Francis Radclyffe, who was made a baronet in 1619. In 1688 Sir Francis was created Viscount Radclyffe and earl of Derwentwater by James II., and dying in 1697 was succeeded as 2nd earl by his eldest son Edward (1655-1705), who had married Lady Mary Tudor (d. 1726), a natural daughter of Charles II. The 2nd earl died in 1705, and was succeeded by his eldest son James (1689-1716), who was born in London on the 28th of June 1689, and was brought up at the court of the Stewarts in France as companion to Prince James Edward, the old Pretender. In 1710 he came to reside on his English estates, and in July 1712 was married to Anna Maria (d. 1723), daughter of Sir John Webb, baronet, of Willock, Wiltshire. Joining without any hesitation in the Stuart rising of 1715, Derwentwater escaped arrest owing to the leniency of his tenantry, and in October, with about seventy followers, he joined Thomas Forster at Green-rig. Like Forster the earl was lacking in military experience, and when the rebels were defeated at Preston he was conveyed to London and imprisoned. Pleading guilty at his trial he was attainted and condemned to death. Great efforts were made to obtain a mitigation of the sentence, but the government was obdurate, and Derwentwater was beheaded on Tower Hill on the 24th

of February 1716, declaring on the scaffold his devotion to the Roman Catholic religion and to King James III. The earl was very popular among his tenantry and in the neighbourhood of his residence, Dilston Hall. His gallant bearing and his sad fate have been celebrated in song and story, and the *aurora borealis*, which shone with exceptional brightness on the night of his execution, is known locally as "Lord Derwentwater's lights." He left an only son John, who, in spite of his father's attainder, assumed the title of earl of Derwentwater, and who died unmarried in 1731; and a daughter Alice Mary (d. 1760), who married in 1732 Robert James, 8th Baron Petre (1713-1742).

On the death of John Radclyffe in 1731 his uncle Charles (1693-1746), the only surviving son of the 2nd earl, took the title of earl of Derwentwater. Charles Radclyffe had shared the fate of his brother, the 3rd earl, at Preston in November 1715, and had been condemned to death for high treason; but, more fortunate than James, he had succeeded in escaping from prison, and had joined the Stewarts on the Continent. In 1724 he married Charlotte Maria (d. 1755), in her own right countess of Newburgh, and after spending some time in Rome, he was captured by an English ship in November 1745 whilst proceeding to join Charles Edward, the young Pretender, in Scotland. Condemned to death under his former sentence he was beheaded on the 8th of December 1746. His eldest son, James Bartholomew (1725-1786), who had shared his father's imprisonment, then claimed the title of earl of Derwentwater, and on his mother's death in 1755 became 3rd earl of Newburgh. His only son and successor, Anthony James (1757-1814), died without issue in 1814, when the title became extinct *de facto* as well as *de jure*. Many of the forfeited estates in Northumberland and Cumberland had been settled upon Greenwich Hospital, and in 1749 a sum of £30,000 had been raised upon them for the benefit of the earl of Newburgh. The present representative of the Radclyffe family is Lord Petre, and in 1874 the bodies of the first three earls of Derwentwater were reburied in the family vault of the Petres at Thorndon, Essex.

In 1865 a woman appeared in Northumberland who claimed to be a grand-daughter of the 4th earl and, as there were no male heirs, to be countess of Derwentwater and owner of the estates. She said the 4th earl had not died in 1731 but had married and settled in Germany. Her story aroused some interest, and it was necessary to eject her by force from Dilston Hall.

See R. Patten, *History of the Late Rebellion* (London, 1717); W. S. Gibson, *Dilston Hall, or Memoirs of James Radcliffe, earl of Derwentwater* (London, 1848-1850); G. E. Cokayne, *Complete Peerage* (Exeter, 1887-1898); and *Dictionary of National Biography*, vol. xlvii. (London, 1896).

DERWENTWATER, a lake of Cumberland, England, in the northern part of the celebrated Lake District (*q.v.* for the physical relations of the lake with the district at large). It is of irregular figure, approaching to an oval, about 3 m. in length and from $\frac{1}{2}$ m. to $1\frac{1}{2}$ m. in breadth. The greatest depth is 70 ft. The lake is seen at one view, within an amphitheatre of mountains of varied outline, overlooked by others of greater height. Several of the lesser elevations near the lake are especially famous as view-points, such as Castle Head, Walla Crag, Ladder Brow and Cat Bells. The shores are well wooded, and the lake is studded with several islands, of which Lord's Island, Derwent Isle and St Herbert's are the principal. Lord's Island was the residence of the earls of Derwentwater. St Herbert's Isle receives its name from having been the abode of a holy man of that name mentioned by Bede as contemporary with St Cuthbert of Farne Island in the 7th century. Derwent Isle, about six acres in extent, contains a handsome residence surrounded by lawns, gardens and timber of large growth. The famous Falls of Lodore, at the upper end of the lake, consist of a series of cascades in the small Watendlath Beck, which rushes over an enormous pile of protruding crags from a height of nearly 200 ft. The "Floating Island" appears at intervals on the upper portion of the lake near the mouth of the beck. This singular phenomenon is supposed to owe its appearance to an accumulation of gas, formed by the decay of

vegetable matter, detaching and raising to the surface the matted weeds which cover the floor of the lake at this point. The river Derwent (q.v.) enters the lake from the south and leaves it on the north, draining it through Bassenthwaite lake, to the Irish Sea. To the north-east of the lake lies the town of Keswick.

DES ADRETS, FRANÇOIS DE BEAUMONT, BARON (c. 1512-1587), French Protestant leader, was born in 1512 or 1513 at the château de La Frette (Isère). During the reign of Henry II. of France he served with distinction in the royal army and became colonel of the "legions" of Dauphiné, Provence and Languedoc. In 1562, however, he joined the Huguenots, not from religious conviction but probably from motives of ambition and personal dislike of the house of Guise. His campaign against the Catholics in 1562 was eminently successful. In June of that year Des Adrets was master of the greater part of Dauphiné. But his brilliant military qualities were marred by his revolting atrocities. The reprisals he exacted from the Catholics after their massacres of the Huguenots at Orange have left a dark stain upon his name. The garrisons that resisted him were butchered with every circumstance of brutality, and at Montbrison, in Forez, he forced eighteen prisoners to precipitate themselves from the top of the keep. Having alienated the affections of the Huguenots by his pride and violence, he entered into communication with the Catholics, and declared himself openly in favour of conciliation. On the 10th of January 1563 he was arrested on suspicion by some Huguenot officers and confined in the citadel of Nîmes. He was liberated at the edict of Amboise in the following March, and, distrusted alike by Huguenots and Catholics, retired to the château de La Frette, where he died, a Catholic, on the 2nd of February 1587.

AUTHORITIES.—J. Roman, *Documents inédits sur le baron des Adrets* (1878); and memoirs and histories of the time. See also Guy Allard, *Vie de François de Beaumont* (1675); l'abbé J. C. Martin, *Histoire politique et militaire de François de Beaumont* (1803); Eugène and Émile Haag, *La France protestante* (2nd ed., 1877 seq.).

DESAIX DE VEYGOUX, LOUIS CHARLES ANTOINE (1768-1800), French general, was born of a noble though impoverished family. He received a military education at the school founded by Marshal d'Éfiat, and entered the French royal army. During the first six years of his service the young officer devoted himself assiduously to duty and the study of his profession, and at the outbreak of the Revolution threw himself whole-heartedly into the cause of liberty. In spite of the pressure put upon him by his relatives, he refused to "emigrate," and in 1792 is found serving on Broglie's staff. The disgrace of this general nearly cost young Desaix his life, but he escaped the guillotine, and by his conspicuous services soon drew upon himself the favour of the Republican government. Like many other members of the old ruling classes who had accepted the new order of things, the instinct of command, joined to native ability, brought Desaix rapidly to high posts. By 1794 he had attained the rank of general of division. In the campaign of 1795 he commanded Jourdan's right wing, and in Moreau's invasion of Bavaria in the following year he held an equally important command. In the retreat which ensued when the archduke Charles won the battles of Amberg and Würzburg (see **FRENCH REVOLUTIONARY WARS**) Desaix commanded Moreau's rearguard, and later the fortress of Kehl, with the highest distinction, and his name became a household word, like those of Bonaparte, Jourdan, Hoche, Marceau and Kléber. Next year his initial successes were interrupted by the Preliminaries of Leoben, and he procured for himself a mission into Italy in order to meet General Bonaparte, who spared no pains to captivate the brilliant young general from the almost rival camps of Germany. Provisionally appointed commander of the "Army of England," Desaix was soon transferred by Bonaparte to the expeditionary force intended for Egypt. It was his division which bore the brunt of the Mameluke attack at the battle of the Pyramids, and he crowned his reputation by his victories over Murad Bey in Upper Egypt. Amongst the fellaheen he acquired the significant appellation of the "Just Sultan." When his chief handed over the command to Kléber and prepared to return to France,

Desaix was one of the small party selected to accompany the future emperor. But, from various causes, it was many months before he could join the new Consul. The campaign of 1800 was well on its way to the climax when Desaix at last reported himself for duty in Italy. He was immediately assigned to the command of a corps of two infantry divisions. Three days later (June 14), detached, with Boudet's division, at Rivalta, he heard the cannon of Marengo on his right. Taking the initiative he marched at once towards the sound, meeting Bonaparte's staff officer, who had come to recall him, half way on the route. He arrived with Boudet's division at the moment when the Austrians were victorious all along the line. Exclaiming, "There is yet time to win another battle!" he led his three regiments straight against the enemy's centre. At the moment of victory Desaix was killed by a musket ball. Napoleon paid a just tribute to the memory of one of the most brilliant soldiers of that brilliant time by erecting the monuments of Desaix on the Place Dauphiné and the Place des Victoires in Paris.

See F. Martha-Beker, Comte de Mons, *Le Général L. C. A. Desaix* (Paris, 1852).

DÉSAUGIERS, MARC ANTOINE MADELEINE (1772-1827), French dramatist and song-writer, son of Marc Antoine Désaugiers, a musical composer, was born at Fréjus (Var) on the 17th of November 1772. He studied at the Mazarin college in Paris, where he had for one of his teachers the critic Julien Louis Geoffroy. He entered the seminary Saint Lazare with a view to the priesthood, but soon gave up his intention. In his nineteenth year he produced in collaboration with his father a light opera (1791) adapted from the *Médécin malgré lui* of Molière.

During the Revolution he emigrated to St Domingo, and during the negro revolt he was made prisoner, barely escaping with his life. He took refuge in the United States, where he supported himself by teaching the piano. In 1797 he returned to his native country, and in a very few years he became famous as a writer of comedies, operas and vaudevilles, which were produced in rapid succession at the Théâtre des Variétés and the Vaudeville. He also wrote convivial and satirical songs, which, though different in character, can only worthily be compared with those of Béranger. He was at one time president of the *Carcass*, a convivial society whose members were then chiefly drawn from literary circles. He had the honour of introducing Béranger as a member. In 1815 Désaugiers succeeded Pierre Yves Barré as manager of the Vaudeville, which prospered under his management until, in 1820, the opposition of the Gymnase proved too strong for him, and he resigned. He died in Paris on the 9th of August 1827.

Among his pieces may be mentioned *Le Valet d'emprunt* (1807); *Monsieur Vautour* (1811); and *Le Règne d'un terme et le terme d'un règne*, aimed at Napoleon.

An edition of Désaugiers' *Chansons et Poésies diverses* appeared in 1827. A new selection with a notice by Alfred de Bougy appeared in 1858. See also Sainte-Beuve's *Portraits contemporains*, vol. v.

DESAULT, PIERRE JOSEPH (1744-1795), French anatomist and surgeon, was born at Magny-Vernois (Haute Saône) on the 6th of February 1744. He was destined for the church, but his own inclination was towards the study of medicine; and, after learning something from the barber-surgeon of his native village, he was settled as an apprentice in the military hospital of Belfort, where he acquired some knowledge of anatomy and military surgery. Going to Paris when about twenty years of age, he opened a school of anatomy in the winter of 1766, the success of which excited the jealousy of the established teachers and professors, who endeavoured to make him give up his lectures. In 1776 he was admitted a member of the corporation of surgeons; and in 1782 he was appointed surgeon-major to the hospital *De la Charité*. Within a few years he was recognized as one of the leading surgeons of France. The clinical school of surgery which he instituted at the Hôtel Dieu attracted great numbers of students, not only from every part of France but also from other countries; and he frequently had an audience of about 600. He introduced many improvements into the practice of surgery, as well as into the construction of various surgical

instruments. In 1791 he established a *Journal de chirurgie*, edited by his pupils, which was a record of the most interesting cases that had occurred in his clinical school, with the remarks which he had made upon them in the course of his lectures. But in the midst of his labours he became obnoxious to some of the revolutionists, and he was, on some frivolous charge, denounced to the popular sections. After being twice examined, he was seized on the 28th of May 1793, while delivering a lecture, carried away from his theatre, and committed to prison in the Luxembourg. In three days, however, he was liberated, and permitted to resume his functions. He died in Paris on the 1st of June 1795, the story that his death was caused by poison being disproved by the autopsy carried out by his pupil, M. F. X. Bichat. A pension was settled on his widow by the republic. Together with François Chopart (1743-1795) he published a *Traité des maladies chirurgicales* (1779), and Bichat published a digest of his surgical doctrines in *Œuvres chirurgicales de Desault* (1792-1799).

DES BARREAUX, JACQUES VALLÉE, SEUR (1602-1673), French poet, was born in Paris in 1602. His great-uncle, Geoffroy-Vallée, had been hanged in 1574 for the authorship of a book called *Le Fléau de la foy*. His nephew appears to have inherited his scepticism, which on one occasion nearly cost him his life. The peasants of Touraine attributed to the presence of the unbeliever an untimely frost that damaged the vines, and proposed to stone him. His authorship of the sonnet on "Pénitence," by which he is generally known, has been disputed. He had the further distinction of being the first of the lovers of Marion Delorme. He died at Chalon-sur-Saône on the 9th of May 1673.

See *Poésies de Des Barreaux* (1904), edited by F. Lachèvre.

DESBOROUGH, JOHN (1608-1680), English soldier and politician, son of James Desborough of Eltisle, Cambridgeshire, and of Elizabeth Hatley of Over, in the same county, was baptized on the 13th of November 1608. He was educated for the law. On the 23rd of June 1636 he married Eltisle Jane, daughter of Robert Cromwell of Huntingdon, and sister of the future Protector. He took an active part in the Civil War when it broke out, and showed considerable military ability. In 1645 he was present as major in the engagement at Langport on the 10th of July, at Hambleton Hill on the 4th of August, and on the 10th of September he commanded the horse at the storming of Bristol. Later he took part in the operations round Oxford. In 1648 as colonel he commanded the forces at Great Yarmouth. He avoided all participation in the trial of the king in June 1649, being employed in the settlement of the west of England. He fought at Worcester as major-general and nearly captured Charles II. near Salisbury. After the establishment of the Commonwealth he was chosen, on the 17th of January 1652, a member of the committee for legal reforms. In 1653 he became a member of the Protectorate council of state, and a commissioner of the treasury, and was appointed one of the four generals at sea and a commissioner for the army and navy. In 1654 he was made constable of St Briavel's Castle in Gloucestershire. Next year he was appointed major-general over the west. He had been nominated a member of Barebones' parliament in 1653, and he was returned to the parliament of 1654 for Cambridgeshire, and to that of 1656 for Somersetshire. In July 1657 he became a member of the privy council, and in 1658 he accepted a seat in Cromwell's House of Lords. In spite of his near relationship to the Protector's family, he was one of the most violent opponents of the assumption by Cromwell of the royal title, and after the Protector's death, instead of supporting the interests and government of his nephew Richard Cromwell, he was, with Fleetwood, the chief instigator and organizer of the hostility of the army towards his administration, and forced him by threats and menaces to dissolve his parliament in April 1659. He was chosen a member of the council of state by the restored Rump, and made colonel and governor of Plymouth, but presenting with other officers a seditious petition from the army council, on the 5th of October, was about a week later dismissed. After the expulsion of the Rump by Fleetwood on the 13th of

October he was chosen by the officers a member of the new administration and commissary-general of the horse. The new military government, however, rested on no solid foundation, and its leaders quickly found themselves without any influence. Desborough himself became an object of ridicule, his regiment even revolted against him, and on the return of the Rump he was ordered to quit London. At the restoration he was excluded from the act of indemnity but not included in the clause of pains and penalties extending to life and goods, being therefore only incapacitated from public employment. Soon afterwards he was arrested on suspicion of conspiring to kill the king and queen, but was quickly liberated. Subsequently he escaped to Holland, where he engaged in republican intrigues. Accordingly he was ordered home, in April 1666, on pain of incurring the charge of treason, and obeying was imprisoned in the Tower till February 1667, when he was examined before the council and set free. Desborough died in 1680. By his first wife, Cromwell's sister, he had one daughter and seven sons; he married a second wife in April 1658 whose name is unrecorded. Desborough was a good soldier and nothing more; and his only conception of government was by force and by the army. His rough person and manners are the constant theme of ridicule in the royalist ballads, and he is caricatured in Butler's *Hudibras* and in the *Parable of the Lion and the Fox*.

DESCARTES, RENÉ (1596-1650), French philosopher, was born at La Haye, in Touraine, midway between Tours and Poitiers, on the 31st of March 1596, and died at Stockholm on the 11th of February 1650. The house where he was born is still shown, and a *mémoire* about 3 m. off retains the name of Les Cartes. His family on both sides was of Poitevin descent. Joachim Descartes, his father, having purchased a commission as counsellor in the parlement of Rennes, introduced the family into that demi-noblesse of the robe which, between the bourgeoisie and the high nobility, maintained a lofty rank in French society. He had three children, a son who afterwards succeeded to his father in the parlement, a daughter who married a M. du Crevis, and René, after whose birth the mother died.

Descartes, known as Du Perron, from a small estate destined for his inheritance, soon showed an inquisitive mind. From 1604 to 1612 he studied at the school of La Flèche, which Henry IV. had lately founded and endowed for the Jesuits. He enjoyed exceptional privileges; his feeble health excused him from the morning duties, and thus early he acquired the habit of reflection in bed, which clung to him throughout life. Even then he had begun to distrust the authority of tradition and his teachers. Two years before he left school he was selected as one of the twenty-four who went forth to receive the heart of Henry IV. as it was borne to its resting-place at La Flèche. At the age of sixteen he went home to his father, who was now settled at Rennes, and had married again. During the winter of 1612 he completed his preparations for the world by lessons in horsemanship and fencing; and then started as his own master to taste the pleasures of Parisian life. Fortunately he went to no perilous lengths; the worst we hear of is a passion for gaming. Here, too, he made the acquaintance of Claude Mydorge, one of the foremost mathematicians of France, and renewed an early intimacy with Marin Mersenne (*q.v.*), now Father Mersenne, of the order of Minim friars. The withdrawal of Mersenne in 1614 to a post in the provinces was the signal for Descartes to abandon social life and shut himself up for nearly two years in a secluded house of the faubourg St Germain. Accident betrayed the secret of his retirement; he was compelled to leave his mathematical investigations, and to take part in entertainments, where the only thing that chimed in with his theorizing reveries was the music. French politics were at that time characterized by violence and intrigue to such an extent that Paris was no fit place for a student, and there was little honourable prospect for a soldier. Accordingly, in May 1617, Descartes set out for the Netherlands and took service in the army of Prince Maurice of Orange. At Breda he enlisted as a volunteer, and the first and only pay which he accepted he kept as a curiosity through life. There was a lull in the war, and

Netherlands was distracted by the quarrels of Gomarists and Arminians. During the leisure thus arising, Descartes one day had his attention drawn to a placard in the Dutch tongue; as the language, of which he never became perfectly master, was then strange to him, he asked a bystander to interpret it into either French or Latin. The stranger, Isaac Beekman, principal of the college of Dort, offered to do so into Latin, if the inquirer would bring him a solution of the problem,—for the advertisement was one of those challenges which the mathematicians of the age were accustomed to throw down to all comers, daring them to discover a geometrical mystery known as they fancied to themselves alone. Descartes promised and fulfilled; and a friendship grew up between him and Beekman—broken only by the dishonesty of the latter, who in later years took credit for the novelty contained in a small essay on music (*Compendium Musicum*) which Descartes wrote at this period and entrusted to Beekman.¹

After spending two years in Holland as a soldier in a period of peace, Descartes, in July 1619, attracted by the news of the impending struggle between the house of Austria and the Protestant princes, consequent upon the election of the palatine of the Rhine to the kingdom of Bohemia, set out for upper Germany, and volunteered into the Bavarian service. The winter of 1619, spent in quarters at Neuburg on the Danube, was the critical period in his life. Here, in his warm room (*dans un poêle*), he indulged those meditations which afterwards led to the *Discourse of Method*. It was here that, on the eve of St Martin's day, he "was filled with enthusiasm, and discovered the foundations of a marvellous science." He retired to rest with anxious thoughts of his future career, which haunted him through the night in three dreams that left a deep impression on his mind. The date of his philosophical conversion is thus fixed to a day. But as yet he had only glimpses of a logical method which should invigorate the syllogism by the co-operation of ancient geometry and modern algebra. For during the year that elapsed before he left Swabia (and whilst he sojourned at Neuburg and Ulm), and amidst his geometrical studies, he would fain have gathered some knowledge of the mystical wisdom attributed to the Rosicrucians; but the Invisibles, as they called themselves, kept their secret. He was present at the battle of Weisser Berg (near Prague), where the hopes of the elector palatine were blasted (November 8, 1620), passed the winter with the army in southern Bohemia, and next year served in Hungary under Karl Bonaventura de Longueval, Graf von Buquoy or Boucquoy (1571-1621). On the death of this general Descartes quitted the imperial service, and in July 1621 began a peaceful tour through Moravia, the borders of Poland, Pomerania, Brandenburg, Holstein and Friesland, from which he reappeared in February 1622 in Belgium, and betook himself directly to his father's home at Rennes in Brittany.

At Rennes Descartes found little to interest him; and, after he had visited the maternal estate of which his father now put him in possession, he went to Paris, where he found the Rosicrucians the topic of the hour, and heard himself credited with partnership in their secrets. A short visit to Brittany enabled him, with his father's consent, to arrange for the sale of his property in Poitou. The proceeds were invested in such a way at Paris as to bring him in a yearly income of between 6000 and 7000 francs (equal now to more than £500). Towards the end of the year Descartes was on his way to Italy. The natural phenomena of Switzerland, and the political complications in the Valtellina, where the Catholic inhabitants had thrown off the yoke of the Grisons and called in the Papal and Spanish troops to their assistance, delayed him some time; but he reached Venice in time to see the ceremony of the doge's wedlock with the Adriatic. After paying his vows at Loretto, he came to Rome, which was then on the eve of a year of jubilee—an occasion which Descartes seized to observe the variety of men and manners which the city then embraced within its walls. In the spring of 1625

he returned home by Mont Cenis, observing the avalanches,² instead of, as his relatives hoped, securing a post in the French army in Piedmont.

For an instant Descartes seems to have concurred in the plan of purchasing a post at Châtellerault, but he gave up the idea, and settled in Paris (June 1625), in the quarter where he had sought seclusion before. By this time he had ceased to devote himself to pure mathematics, and in company with his friends Mersenne and Mydorge was deeply interested in the theory of the refraction of light, and in the practical work of grinding glasses of the best shape suitable for optical instruments. But all the while he was engaged with reflections on the nature of man, of the soul and of God, and for a while he remained invisible even to his most familiar friends. But their importunity made a hermitage in Paris impossible; a graceless friend even surprised the philosopher in bed at eleven in the morning meditating and taking notes. In disgust, Descartes started for the west to take part in the siege of La Rochelle, and entered the city with the troops (October 1628). A meeting at which he was present after his return to Paris decided his vocation. He had expressed an opinion that the true art of memory was not to be gained by technical devices, but by a philosophical apprehension of things; and the cardinal de Berulle, the founder of the Congregation of the Oratory, was so struck by the tone of the remarks as to impress upon the speaker the duty of spending his life in the examination of truth. Descartes accepted the philosophic mission, and in the spring of 1629 he settled in Holland. His financial affairs he had entrusted to the care of the abbé Picot, and as his literary and scientific representative he adopted Mersenne.

Till 1649 Descartes lived in Holland. Thrice only did he revisit France—in 1644, 1647 and 1648. The first of these occasions was in order to settle family affairs after the death of his father in 1640. The second brief visit, in 1647, partly on literary, partly on family business, was signalized by the award of a pension of 3000 francs, obtained from the royal bounty by Cardinal Mazarin. The last visit in 1648 was less fortunate. A royal order summoned him to France for new honours—an additional pension and a permanent post—for his fame had by this time gone abroad, and it was the age when princes sought to attract genius and learning to their courts. But when Descartes arrived, he found Paris rent asunder by the civil war of the Fronde. He paid the costs of his royal parchment, and left without a word of reproach. The only other occasions on which he was out of the Netherlands were in 1630, when he made a flying visit to England to observe for himself some alleged magnetic phenomena, and in 1634, when he took an excursion to Denmark.

During his residence in Holland he lived at thirteen different places, and changed his abode twenty-four times. In the choice of these spots two motives seem to have influenced him—the neighbourhood of a university or college, and the amenities of the situation. Among these towns were Franeker in Friesland, Harderwyk, Deventer, Utrecht, Leiden, Amersfoort, Amsterdam, Leeuwarden in Friesland. His favourite residences were Endegeest, Egmond op den Hoef and Egmond the Abbey (west of Zaandam).

The time thus spent seems to have been on the whole happy, even allowing for warm discussions with the mathematicians and metaphysicians of France, and for harassing controversies in the Netherlands. Friendly agents—chiefly Catholic priests—were the intermediaries who forwarded his correspondence from Dort, Haarlem, Amsterdam and Leiden to his proper address, which he kept completely secret; and Father Mersenne sent him objections and questions. His health, which in his youth had been bad, improved. "I sleep here ten hours every night," he writes from Amsterdam, "and no care ever shortens my slumber." "I take my walk every day through the confusion of a great multitude with as much freedom and quiet as you could find in your rural avenues."³ At his first coming to Franeker he arranged to get a cook acquainted with French cookery; but,

¹ It was only published after the author's death; and of it, besides the French version, there exists an English translation "by a Person of Quality."

² *Cæuvres*, v. 255.

³ *Ib.* vi. 199.

to prevent misunderstanding, it may be added that his diet was mainly vegetarian, and that he rarely drank wine. New friends gathered round him who took a keen interest in his researches. Once only do we find him taking an interest in the affairs of his neighbours,—to ask pardon from the government for a homicide.¹ He continued the profession of his religion. Sometimes from curiosity he went to the ministrations of anabaptists,² to hear the preaching of peasants and artisans. He carried few books to Holland with him, but a Bible and the *Summa* of Thomas Aquinas were amongst them.³ One of the recommendations of Emond the Abbot was the free exercise there allowed to the Catholic religion. At Franeker his house was a small château, "separated by a moat from the rest of the town, where the mass could be said in safety."⁴ And one motive in favour of accepting an invitation to England lay in the alleged leanings of Charles I. to the older church.

The best account of Descartes's mental history during his life in Holland is contained in his letters, which extend over the whole period, and are particularly frequent in the latter half. The majority of them are addressed to Mersenne, and deal with problems of physics, musical theory (in which he took a special interest), and mathematics. Several letters between 1643 and 1649 are addressed to the princess Elizabeth, the eldest daughter of the ejected elector palatine, who lived at The Hague, where her mother maintained the semblance of a royal court. The princess was obliged to quit Holland, but kept up a philosophical correspondence with Descartes. It is to her that the *Principles of Philosophy* were dedicated; and in her alone, according to Descartes, were united those generally separated talents for metaphysics and for mathematics which are so characteristically co-operative in the Cartesian system. Two Dutch friends, Constantijn Huygens (von Zuylichem), father of the more celebrated Huygens, and Hoogheland, figure amongst the correspondents, not to mention various savants, professors and churchmen (particularly Jesuits).

His residence in the Netherlands fell in the most prosperous and brilliant days of the Dutch state, under the stadtholdership of Frederick Henry (1625-1647). Abroad its navigators monopolized the commerce of the world, and explored unknown seas; at home the Dutch school of painting reached its acme in Rembrandt (1607-1669); and the philological reputation of the country was sustained by Grotius, Vossius and the elder Heinsius. And yet, though Rembrandt's "Nightwatch" is dated the very year after the publication of the *Méditations*, not a word in Descartes breathes of any work of art or historical learning. The contempt of aesthetics and erudition is characteristic of the most typical members of what is known as the Cartesian school, especially Malebranche. Descartes was not in any strict sense a reader. His wisdom grew mainly out of his own reflections and experiments. The story of his disgust when he found that Queen Christina devoted some time every day to the study of Greek under the tuition of Vossius is at least true in substance.⁵ It gives no evidence of science, he remarks, to possess a tolerable knowledge of the Roman tongue, such as once was possessed by the populace of Rome.⁶ In all his travels he studied only the phenomena of nature and human life. He was a spectator rather than an actor on the stage of the world. He entered the army, merely because the position gave a vantage-ground from which to make his observations. In the political interests which these contests involved he took no part; his favourite disciple, the princess Elizabeth, was the daughter of the banished king, against whom he had served in Bohemia; and Queen Christina, his second royal follower, was the daughter of Gustavus Adolphus.

Thus Descartes is a type of that spirit of science to which tradition and all the heritage of the past seem but elegant trifling. The science of Descartes was physics in all its branches, but especially as applied to physiology. Science, he says, may be compared to a tree; metaphysics is the root, physics is the trunk, and the three chief branches are mechanics, medicine and

morals,—the three applications of our knowledge to the outward world, to the human body, and to the conduct of life.⁷

Such then was the work that Descartes had in view in Holland. His residence was generally divided into two parts—one his workshop for science, the other his reception-room for society. "Here are my books," he is reported to have told a visitor, as he pointed to the animals he had dissected. He worked hard at his book on refraction, and dissected the heads of animals in order to explain imagination and memory, which he considered physical processes.⁸ But he was not a laborious student. "I can say with truth," he writes to the princess Elizabeth,⁹ "that the principle which I have always observed in my studies, and which I believe has helped me most to gain what knowledge I have, has been never to spend beyond a very few hours daily in thoughts which occupy the imagination, and a very few hours yearly in those which occupy the understanding, and to give all the rest of my time to the relaxation of the senses and the repose of the mind." But his expectations from the study of anatomy and physiology went a long way. "The conservation of health," he writes in 1646, "has always been the principal end of my studies."¹⁰ In 1629 he asks Mersenne to take care of himself "till I find out if there is any means of getting a medical theory based on infallible demonstrations, which is what I am now inquiring."¹¹ Astronomical inquiries in connexion with optics, meteorological phenomena, and, in a word, the whole field of natural laws, excited his desire to explain them. His own observation, and the reports of Mersenne, furnished his data. Of Bacon's demand for observation and collection of facts he is an imitator; and he wishes (in a letter of 1632) that "some one would undertake to give a history of celestial phenomena after the method of Bacon, and describe the sky exactly as it appears at present, without introducing a single hypothesis."¹²

He had several writings in hand during the early years of his residence in Holland, but the main work of this period was a physical doctrine of the universe which he termed *The World*. Shortly after his arrival he writes to Mersenne that it will probably be finished in 1633, but meanwhile asks him not to disclose the secret to his Parisian friends. Already anxieties appear as to the theological verdict upon two of his fundamental views—the infinitude of the universe, and the earth's rotation round the sun.¹³ But towards the end of year 1633 we find him writing as follows:—"I had intended sending you my *World* as a New Year's gift, and a fortnight ago I was still minded to send you a fragment of the work, if the whole of it could not be transcribed in time. But I have just been at Leyden and Amsterdam to ask after Galileo's cosmical system as I imagined I had heard of its being printed last year in Italy. I was told that it had been printed, but that every copy had been at the same time burnt at Rome, and that Galileo had been himself condemned to some penalty."¹⁴ He has also seen a copy of Galileo's condemnation at Liège (September 20, 1633), with the words "although he professes that the [Copernican] theory was only adopted by him as a hypothesis." His friend Beekman lent him a copy of Galileo's work, which he glanced through in his usual manner with other men's books; he found it good, and "failing more in the points where it follows received opinions than where it diverges from them."¹⁵ The consequence of these reports of the hostility of the church led him to abandon all thoughts of publishing. *The World* was consigned to his desk; and although doctrines in all essential respects the same constitute the physical portion of his *Principia*, it was not till after the death of Descartes that fragments of the work, including *Le Monde*, or a treatise on light, and the physiological tracts *L'Homme* and *La Formation du fœtus*, were given to the world by his admirer Claude Clerselier (1614-1684) in 1664. Descartes was not disposed to be a martyr; he had a sincere respect for the church, and had no wish to begin an open conflict with established doctrines.

In 1636 Descartes had resolved to publish some specimens of the fruits of his method, and some general observations on its

¹ *Œuvres*, viii. 59.
² *Ib.* vi. 123.

³ *Ib.* viii. 173.
⁴ *Ib.* x. 375.

⁵ *Ib.* viii. 181.
⁶ *Ib.* ix. 6.

⁷ *Ib.* iii. 24.
⁸ *Ib.* ix. 341.
⁹ *Ib.* vi. 73.

¹⁰ *Ib.* vi. 234.
¹¹ *Ib.* vi. 89.
¹² *Ib.* vi. 239.

¹³ *Ib.* ix. 131.
¹⁴ *Ib.* vi. 210.
¹⁵ *Ib.* vi. 248.

nature which, under an appearance of simplicity, might sow the good seed of more adequate ideas on the world and man. "I should be glad," he says, when talking of a publisher,¹ "if the whole book were printed in good type, on good paper, and I should like to have at least 200 copies for distribution. The book will contain four essays, all in French, with the general title of 'Project of a Universal science, capable of raising our nature to its highest perfection; also Dioptrics, Meteors and Geometry, wherein the most curious matters which the author could select as a proof of the universal science which he proposes are explained in such a way that even the unlearned may understand them.'" The work appeared anonymously at Leiden (published by Jean Maire) in 1637, under the modest title of *Essais philosophiques*; and the project of a universal science becomes the *Discours de la méthode pour bien conduire sa raison et chercher la vérité dans les sciences*. In 1644 it appeared in a Latin version, revised by Descartes, as *Specimina philosophica*. A work so widely circulated by the author naturally attracted attention, but in France it was principally the mathematicians who took it up, and their criticisms were more pungent than complimentary. Fermat, Roberval and Desargues took exception in their various ways to the methods employed in the geometry, and to the demonstrations of the laws of refraction given in the Dioptrics and Meteors. The dispute on the latter point between Fermat and Descartes was continued, even after the philosopher's death, as late as 1662. In the youthful Dutch universities the effect of the essays was greater.

The first public teacher of Cartesian views was Henri Renery, a Belgian, who at Deventer and afterwards at Utrecht had introduced the new philosophy which he had learned from personal intercourse with Descartes. Renery only survived five years at Utrecht, and it was reserved for Heinrich Regius (van Roy)—who in 1638 had been appointed to the new chair of botany and theoretical medicine at Utrecht, and who visited Descartes at Egmond in order more thoroughly to learn his views—to throw down the gauntlet to the adherents of the old methods. With more eloquence than judgment, he propounded theses bringing into relief the points in which the new doctrines clashed with the old. The attack was opened by Gisbert Voët, foremost among the orthodox theological professors and clergy of Utrecht. In 1639 he published a series of arguments against atheism, in which the Cartesian views were not obscurely indicated as perilous for the faith, though no name was mentioned. Next year he persuaded the magistracy to issue an order forbidding Regius to travel beyond the received doctrine. The magisterial views seem to have prevailed in the professoriate, which formally in March 1642 expressed its disapprobation of the new philosophy as well as of its expositors. As yet Descartes was not directly attacked. Voët now issued, under the name of Martin Schoock, one of his pupils, a pamphlet with the title of *Methodus novae philosophiae Renati Descartes*, in which atheism and infidelity were openly declared to be the effect of the new teaching. Descartes replied to Voët directly in a letter, published at Amsterdam in 1643. He was summoned before the magistrates of Utrecht to defend himself against charges of irreligion and slander. What might have happened we cannot tell; but Descartes threw himself on the protection of the French ambassador and the prince of Orange, and the city magistrates, from whom he vainly demanded satisfaction in a dignified letter,² were snubbed by their superiors. About the same time (April 1645) Schoock was summoned before the university of Groningen, of which he was a member, and forthwith disavowed the more abusive passages in his book. So did the effects of the *odiosum theologium*, for the meanwhile at least, die away.

In the *Discourse of Method* Descartes had sketched the main points in his new views, with a mental autobiography which might explain their origin, and with some suggestions as to their applications. His second great work, *Meditations on the First Philosophy*, which had been begun soon after his settlement in the Netherlands, expounded in more detail the foundations of his system,

laying especial emphasis on the priority of mind to body, and on the absolute and ultimate dependence of mind as well as body on the existence of God. In 1640 a copy of the work in manuscript was despatched to Paris, and Mersenne was requested to lay it before as many thinkers and scholars as he deemed desirable, with a view to getting their views upon its argument and doctrine. Descartes soon had a formidable list of objections to reply to. Accordingly, when the work was published at Paris in August 1641, under the title of *Méditations de prima philosophia ubi de Dei existentia et animae immortalitate* (though it was in fact not the immortality but the immateriality of the mind, or, as the second edition described it, *animae humanae a corpore distinctio*, which was maintained), the title went on to describe the larger part of the book as containing various objections of learned men, with the replies of the author. These objections in the first edition are arranged under six heads: the first came from Caterus, a theologian of Louvain; the second and sixth are anonymous criticisms from various hands; whilst the third, fourth and fifth being respectively to Hobbes, Arnauld and Gassendi. In the second edition appeared the seventh—objections from Père Bourdin, a Jesuit teacher of mathematics in Paris; and subsequently another set of objections, known as those of *Hyperaspistes*, was included in the collection of Descartes's letters. The anonymous objections are very much the statement of common-sense against philosophy; those of Caterus criticize the Cartesian argument from the traditional theology of the church; those of Arnauld are an appreciative inquiry into the bearings and consequences of the meditations for religion and morality; while those of Hobbes (*q.v.*) and Gassendi—both somewhat senior to Descartes and with a dogmatic system of their own already formed—are a keen assault upon the spiritualism of the Cartesian position from a generally "sensational" standpoint. The criticisms of the last two are the criticisms of a hostile school of thought; those of Arnauld are the difficulties of a possible disciple.

In 1644 the third great work of Descartes, the *Principia philosophiae*, appeared at Amsterdam. Passing briefly over the conclusions arrived at in the *Meditations*, it deals in its second, third and fourth parts with the general principles of physical science, especially the laws of motion, with the theory of vortices, and with the phenomena of heat, light, gravity, magnetism, electricity, &c., upon the earth. This work exhibits some curious marks of caution. Undoubtedly, says Descartes, the world was in the beginning created in all its perfection. "But yet as it is best, if we wish to understand the nature of plants or of men, to consider how they may by degrees proceed from seeds, rather than how they were created by God in the beginning of the world, so, if we can excogitate some extremely simple and comprehensible principles, out of which, as if they were seeds, we can prove that stars, and earth and all this visible scene could have originated, although we know full well that they never did originate in such a way, we shall in that way expound their nature far better than if we merely described them as they exist at present."³ The Copernican theory is rejected in name, but retained in substance. The earth, or other planet, does not actually move round the sun; yet it is carried round the sun in the subtle matter of the great vortex, where it lies in equilibrium,—carried like the passenger in a boat, who may cross the sea and yet not rise from his berth.

In 1647 the difficulties that had arisen at Utrecht were repeated on a smaller scale at Leiden. There the Cartesian innovations had found a patron in Adrian Heerebord, and were openly discussed in theses and lectures. The theological professors took the alarm at passages in the *Méditations*; an attempt to prove the existence of God savoured, as they thought, of atheism and heresy. When Descartes complained to the authorities of this unfair treatment,⁴ the only reply was an order by which all mention of the name of Cartesianism, whether favourable or adverse, was forbidden in the university. This was scarcely what Descartes wanted, and again he had to apply to the prince of Orange, whereupon the theologians were asked to behave with

Discourse of Method, and Meditations.

¹ *Œuvres*, vi. 276.

² *Ib.* ix. 250.

³ *Princip.* L. iii. S. 45.

⁴ *Œuvres*, x. 26.

divility, and the name of Descartes was no longer proscribed. But other annoyances were not wanting from unfaithful disciples and unsympathetic critics. The *Instantiæ* of Gassendi appeared at Amsterdam in 1644 as a reply to the reply which Descartes had published of his previous objections; and the publication by Heinrich Regius of his work on physical philosophy (*Fundamenta physica*, 1646) gave the world to understand that he had ceased to be a thorough adherent of the philosophy which he had so enthusiastically adopted.

It was about 1648 that Descartes lost his friends Mersenne and Mydorge by death. The place of Mersenne as his Parisian representative was in the main taken by Claude Clerselier (the French translator of the *Objections and Responses*), whom he had become acquainted with in Paris. Through Clerselier he came to know Pierre Chanut, who in 1645 was sent as French ambassador to the court of Sweden. Queen Christina was not yet twenty, and took a lively if a somewhat whimsical interest in literary and philosophical culture. Through Chanut, with whom she was on terms of familiarity, she came to hear of Descartes, and a correspondence which the latter nominally carried on with the ambassador was in reality intended for the eyes of the queen. The correspondence took an ethical tone. It began with a long letter on love in all its aspects (February 1647),¹ a topic suggested by Chanut, who had been discussing it with the queen; and this was soon followed by another to Christina herself on the chief good. An essay on the passions of the mind (*Passions de l'Âme*), which had been written originally for the princess Elizabeth, in development of some ethical views suggested by the *De vita beata* of Seneca, was enclosed at the same time for Chanut. It was a draft of the work published in 1650 under the same title. Philosophy, particularly that of Descartes, was becoming a fashionable *délectissement* for the queen and her courtiers, and it was felt that the presence of the sage himself was necessary to complete the good work of education. An invitation to the Swedish court was urged upon Descartes, and after much hesitation accepted; a vessel of the royal navy was ordered to wait upon him, and in September 1649 he left Egmond for the north.

The position on which he entered at Stockholm was unsuited for a man who wished to be his own master. The young queen wanted Descartes to draw up a code for a proposed academy of the sciences, and to give her an hour of philosophic instruction every morning at five. She had already determined to create him a noble, and begun to look out an estate in the lately annexed possessions of Sweden on the Pomeranian coast. But these things were not to be. His friend Chanut fell dangerously ill; and Descartes, who devoted himself to attend in the sick-room, was obliged to issue from it every morning in the chill northern air of January, and spend an hour in the palace library. The ambassador recovered, but Descartes fell a victim to the same disease, inflammation of the lungs. The last time he saw the queen was on the 1st of February 1650, when he handed to her the statutes he had drawn up for the proposed academy. On the 11th of February he died. The queen wished to bury him at the feet of the Swedish kings, and to raise a costly mausoleum to his honour; but these plans were overruled, and a plain monument in the Catholic cemetery was all that marked the place of his rest. Sixteen years after his death the French treasurer d'Alibert made arrangements for the conveyance of the ashes to his native land; and in 1667 they were interred in the church of Ste Geneviève du Mont, the modern Pantheon. In 1819, after being temporarily deposited in a stone sarcophagus in the court of the Louvre during the Revolutionary epoch, they were transferred to St Germain-des-Près, where they now repose between Montfaucon and Mabillon. A monument was raised to his memory at Stockholm by Gustavus III.; and a modern statue has been erected to him at Tours, with an inscription on the pedestal: "Je pense, donc je suis."

Descartes never married, and had little of the amorous in his temperament. He has alluded to a childish fancy for a young girl with a slight obliquity of vision; but he only mentions it

à propos of the consequent weakness which led him to associate such a defect with beauty.² In person he was small, with large head, projecting brow, prominent nose, and eyes wide apart, with black hair coming down almost to his eyebrows. His voice was feeble. He usually dressed in black, with unobtrusive propriety.

Philosophy.—The end of all study, says Descartes, in one of his earliest writings, ought to be to guide the mind to form true and sound judgments on every thing that may be presented to it.³ The sciences in their totality are but the intelligence of man; and all the details of knowledge have no value save as they strengthen the understanding. The mind is not for the sake of knowledge, but knowledge for the sake of the mind. This is the reassertion of a principle which the middle ages had lost sight of—that knowledge, if it is to have any value, must be intelligence, and not erudition.

But how is intelligence, as opposed to erudition, possible? The answer to that question is the method of Descartes. That idea of a method grew up with his study of geometry and arithmetic,—the only branches of knowledge which he would allow to be "made sciences." But they did not satisfy his demand for intelligence. "I found in them," he says, "different propositions on numbers of which, after a calculation, I perceived the truth; as for the figures, I had, so to speak, many truths put before my eyes, and many others concluded from them by analogy; but it did not seem to me that they told my mind with sufficient clearness why the things were as I was shown, and by what means their discovery was attained."⁴ The mathematics of which he thus speaks included the geometry of the ancients, as it had been handed down to the modern world, and arithmetic with the developments it had received in the direction of algebra. The ancient geometry, as we know it, is a wonderful monument of ingenuity—a series of *lours de force*, in which each problem to all appearance stands alone, and, if solved, is solved by methods and principles peculiar to itself. Here and there particular curves, for example, had been obliged to yield the secret of their tangent; but the ancient geometers apparently had no consciousness of the general bearings of the methods which they so successfully applied. Each problem was something unique; the elements of transition from one to another were wanting; and the next step which mathematics had to make was to find some method of reducing, for instance, all curves to a common notation. When that was found, the solution of one problem would immediately entail the solution of all others which belonged to the same series as itself.

The arithmetical half of mathematics, which had been gradually growing into algebra, and had decidedly established itself as such in the *Ad logisticen speciosam notas priores* of François Vieta (1540–1603), supplied to some extent the means of generalizing geometry. And the algebraists or arithmeticians of the 16th century, such as Luca Pacioli (Lucas de Borgo), Geronimo or Girolamo Cardano (1501–1576), and Nicola Tartaglia (1506–1559), had used geometrical constructions to throw light on the solution of particular equations. But progress was made difficult, in consequence of the clumsy and irregular nomenclature employed. With Descartes the use of exponents as now employed for denoting the powers of a quantity becomes systematic; and without some such step by which the homogeneity of successive powers is at once recognized, the binomial theorem could scarcely have been detected. The restriction of the early letters of the alphabet to known, and of the late letters to unknown, quantities is also his work. In this and other details he crowns and completes, in a form henceforth to be dominant for the language of algebra, the work of numerous obscure predecessors, such as Étienne de la Roche, Michael Stüfel or Stüfel (1487–1567), and others.

Having thus perfected the instrument, his next step was to apply it in such a way as to bring uniformity of method into the isolated and independent operations of geometry. "I had no intention," he says in the *Method*, "of attempting to master all

¹ *Ib.* x. 53.

² *Œuvres*, xi. 219.

³ *Regulæ*, *Œuvres*, xi. 202.

⁴ *Disc. de méthode*, part ii.

¹ *Œuvres*, x. 3.

the particular sciences commonly called mathematics; but as I observed that, with all differences in their objects, they agreed in considering merely the various relations or proportions subsisting among these objects, I thought it best for my purpose to consider these relations in the most general form possible, without referring them to any objects in particular except such as would most facilitate the knowledge of them. Perceiving further, that in order to understand these relations I should sometimes have to consider them one by one, and sometimes only to bear them in mind or embrace them in the aggregate, I thought that, in order the better to consider them individually, I should view them as subsisting between straight lines, than which I could find no objects more simple, or capable of being more distinctly represented to my imagination and senses; and on the other hand that, in order to retain them in the memory or embrace an aggregate of many, I should express them by certain characters, the briefest possible." Such is the basis of the algebraical or modern analytical geometry. The problem of the curves is solved by their reduction to a problem of straight lines; and the locus of any point is determined by its distance from two given straight lines—the axes of co-ordinates. Thus Descartes gave to modern geometry that abstract and general character in which consists its superiority to the geometry of the ancients. In another question connected with this, the problem of drawing tangents to any curve, Descartes was drawn into a controversy with Pierre (de) Fermat (1601–1663), Gilles Personne de Roberval (1602–1675), and Girard Desargues (1593–1661). Fermat and Descartes agreed in regarding the tangent to a curve as a secant of that curve with the two points of intersection coinciding, while Roberval regarded it as the direction of the composite movement by which the curve can be described. Both these methods, differing from that now employed, are interesting as preliminary steps towards the method of fluxions and the differential calculus. In pure algebra Descartes expounded and illustrated the general methods of solving equations up to those of the fourth degree (and believed that his method could go beyond), stated the law which connects the positive and negative roots of an equation with the changes of sign in the consecutive terms, and introduced the method of indeterminate coefficients for the solution of equations.¹ These innovations have been attributed on inadequate evidence to other algebraists, e.g. William Oughtred (1575–1660) and Thomas Harriot (1560–1621).

The *Geometry* of Descartes, unlike the other parts of his essays, is not easy reading. It dashes at once into the middle of the subjects with the examination of a problem which had baffled the ancients, and seems as if it were tossed at the heads of the French geometers as a challenge. An edition of it appeared subsequently, with notes by his friend Florimond de Beaugrand (1601–1652), calculated to smooth the difficulties of the work. All along mathematics was regarded by Descartes rather as the envelope than the foundation of his method; and the "universal mathematical science" which he sought after was only the prelude of a universal science of all-embracing character.²

The method of Descartes rests upon the proposition that all the objects of our knowledge fall into series, of which the members are more or less known by means of one another. In *Discartes' method*, every such series or group there is a dominant element, simple and irresolvable, the standard on which the rest of the series depends, and hence, so far as that group or series is concerned, absolute. The other members of the group are relative and dependent, and only to be understood as in various degrees subordinate to the primitive conception. The characteristic by which we recognize the fundamental element in a series is its intuitive or self-evident character; it is given by "the evident conception of a healthy and attentive mind so clear and distinct that no doubt is left."³ Having discovered this prime or absolute member of the group, we proceed to consider the degrees in which the other members enter into relation with it. Here deduction comes into play to show the dependence of one term upon the others; and, in the case of a long chain of intervening links, the

problem for intelligence is so to enunciate every element, and so to repeat the connexion that we may finally grasp all the links of the chain in one. In this way we, as it were, bring the causal or primal term and its remotest dependent immediately together, and raise a derivative knowledge into one which is primary and intuitive. Such are the four points of Cartesian method:—(1) Truth requires a clear and distinct conception of its object, excluding all doubt; (2) the objects of knowledge naturally fall into series or groups; (3) in these groups investigation must begin with a simple and indecomposable element, and pass from it to the more complex and relative elements; (4) an exhaustive and immediate grasp of the relations and interconnexion of these elements is necessary for knowledge in the fullest sense of that word.⁴

"There is no question," he says in anticipation of Locke and Kant, "more important to solve than that of knowing what human knowledge is and how far it extends." "This is a question which ought to be asked at least once in their lives by all who seriously wish to gain wisdom. The inquirer will find that the first thing to know is intellect, because on it depends the knowledge of all other things. Examining next what immediately follows the knowledge of pure intellect, he will pass in review all the other means of knowledge, and will find that they are two (or three), the imagination and the senses (and the memory). He will therefore devote all his care to examine and distinguish these three means of knowledge; and seeing that truth and error can, properly speaking, be only in the intellect, and that the two other modes of knowledge are only occasions, he will carefully avoid whatever can lead him astray."⁵ This separation of intellect from sense, imagination and memory is the cardinal precept of the Cartesian logic; it marks off clear and distinct (i.e. adequate and vivid) from obscure, fragmentary and incoherent conceptions.

The *Discourse of Method* and the *Meditations* apply what the *Rules for the Direction of the Mind* had regarded in particular instances to our conceptions of the world as a whole. They propose, that is, to find a simple and indecomposable point, or absolute element, which gives to the world and thought their order and systematization. The grandeur of this attempt is perhaps unequalled in the annals of philosophy. The three main steps in the argument are the veracity of our thought when that thought is true to itself, the inevitable uprising of thought from its fragmentary aspects in our habitual consciousness to the infinite and perfect existence which God is, and the ultimate reduction of the material universe to extension and local movement. There are the central dogmas of logic, metaphysics and physics, from which start the subsequent inquiries of Locke, Leibnitz and Newton. They are also the direct antitheses to the scepticism of Montaigne and Pascal, to the materialism of Gassendi and Hobbes, and to the superstitious anthropomorphism which defaced the reawakening sciences of nature. Descartes laid down the lines on which modern philosophy and science were to build. But himself no trained metaphysician, and unsusceptible to the lessons of history, he gives but fragments of a system which are held together, not by their intrinsic consistency, but by the vigour of his personal conviction transcending the weaknesses and collisions of his several arguments. "All my opinions," he says, "are so conjoined, and depend so closely upon one another, that it would be impossible to appropriate one without knowing them all."⁶ Yet every disciple of Cartesianism seems to disprove the dictum by his example.

The very moment when we begin to think, says Descartes, when we cease to be merely receptive, when we draw back and fix our attention on any point whatever of our belief,—that moment doubt begins. If we even stop for an instant to ask ourselves how a word ought to be spelled, the deeper we ponder that one word by itself the more hopeless grows the hesitation. The doubts thus awakened must not be stifled, but pressed systematically on to the point, if such a point there be, where doubt confutes itself. The doubt as to the details is natural; it

¹ *Géométrie*, book iii.² *Œuvres*, xi. 224.³ *Ib.* xi. 212.⁴ *Disc. de méthode*, part. ii. ⁵ *Œuvres*, xi. 243. ⁶ *Ib.* vii. 381.

Fundamental principles of philosophy.

is no less natural to have recourse to authority to silence the doubt. The remedy proposed by Descartes is (while not neglecting our duties to others, ourselves and God) to let doubt range unchecked through the whole fabric of our customary convictions. One by one they refuse to render any reasonable account of themselves; each seems a mere chance, and the whole tends to elude us like a mirage which some malignant power creates for our illusion. Attacked in detail, they vanish one after another into as many teasing spectra of uncertainty. We are seeking from them what they cannot give. But when we have done our worst in unsettling them, we come to an ultimate point in the fact that it is we who are doubting, we who are thinking. We may doubt that we have hands or feet, that we sleep or wake, and that there is a world of material things around us; but we cannot doubt that we are doubting. We are certain that we are thinking, and in so far as we are thinking we are.

Je pense, donc je suis. In other words, the criterion of truth is a clear and distinct conception, excluding all possibility of doubt.

The fundamental point thus established is the veracity of consciousness when it does not go beyond itself, or does not postulate something which is external to itself. At this point Cassendi arrested Descartes and addressed his objections to him as pure intelligence,—*O mens!* But even this *mens*, or mind, is but a point—we have found no guarantee as yet for its continuous existence. The analysis must be carried deeper, if we are to gain any further conclusions.

Amongst the elements of our thought there are some which we can make and unmake at our pleasure; there are others which come and go without our wish; there is also a third class which is of the very essence of our thinking, and which dominates our conceptions. We find that all our ideas of limits, sorrows and weaknesses presuppose an infinite, perfect and ever-blessed something beyond them and including them,—that all our ideas, in all their series, converge to one central idea, in which they find their explanation. The formal fact of thinking is what constitutes our being; but this thought leads us back, when we consider its concrete contents, to the necessary pre-supposition on which our ideas depend, the permanent cause on which they and we as conscious beings depend. We have therefore the idea of an infinite, perfect and all-powerful being—an idea which cannot be the creation of ourselves, and must be given by some being who really possesses all that we in idea attribute to him. Such a being he identifies with God. But the ordinary idea of God can scarcely be identified with such a conception. "The majority of men," he says himself, "do not think of God as an infinite and incomprehensible being, and as the sole author from whom all things depend; they go no further than the letters of his name."¹ "The vulgar almost imagine him as a finite thing."

Nature of God. The God of Descartes is not merely the creator of the material universe; he is also the father of all truth in the intellectual-world. "The metaphysical truths," he says, "styled eternal have been established by God, and, like the rest of his creatures, depend entirely upon him. To say that these truths are independent of him is to speak of God as a Jupiter or a Saturn,—to subject him to Styx and the Fates."² The laws of thought, the truths of number, are the decrees of God. The expression is anthropomorphic, no less than the dogma of material creation; but it is an attempt to affirm the unity of the intellectual and the material world. Descartes establishes a philosophic monotheism,—by which the medieval polytheism of substantial forms, essences and eternal truths fades away before God, who is the ruler of the intellectual world no less than of the kingdom of nature and of grace.

To attach a clear and definite meaning to the Cartesian doctrine of God, to show how much of it comes from the Christian theology and how much from the logic of idealism, how far the conception of a personal being as creator and preserver mingles with the pantheistic conception of an infinite and perfect something which is all in all, would be to go beyond Descartes and to ask for a solution of difficulties of which he was

¹ *Leviens*, vi. 132. ² *Ib.*, vi. 109.

scarcely aware. It seems impossible to deny that the tendency of his principles and his arguments is mainly in the line of a metaphysical absolute, as the necessary completion and foundation of all being and knowledge. Through the truthfulness of that God as the author of all truth he derives a guarantee for our perceptions in so far as these are clear and distinct. And it is in guaranteeing the veracity of our clear and distinct conceptions that the value of his deduction of God seems in his own estimate to rest. All conceptions which do not possess these two attributes—of being vivid in themselves and discriminated from all others—cannot be true. But the larger part of our conceptions are in such a predicament. We think of things not in the abstract elements of the things themselves, but in connexion with, and in language which presupposes, other things. Our idea of body, e.g., involves colour and weight, and yet when we try to think carefully, and without assuming anything, we find that we cannot attach any distinct idea to these terms when applied to body. In truth therefore these attributes do not belong to body at all; and if we go on in the same way testing the received qualities of matter, we shall find that in the last resort we understand nothing by it but extension, with the secondary and derivative characters of divisibility and mobility.

But it would again be useless to ask how extension as the characteristic attribute of matter is related to mind which thinks, and how God is to be regarded in reference to extension. The force of the universe is swept up and gathered in God, who communicates motion to the parts of extension, and sustains that motion from moment to moment; and in the same way the force of mind has really been concentrated in God. Every moment one expects to find Descartes saying with Hobbes that man's thought has created God, or with Spinoza and Malebranche that it is God who really thinks in the apparent thought of man. After all, the metaphysical theology of Descartes, however essential in his own eyes, serves chiefly as the ground for constructing his theory of man and of the universe. His fundamental hypothesis relegates to God all forces in their ultimate origin. Hence the world is left open for the free play of mechanics and geometry. The disturbing conditions of will, life and organic forces are eliminated from the problem; he starts with the clear and distinct idea of extension, figured and moved, and thence by mathematical laws he gives a hypothetical explanation of all things. Such explanation of physical phenomena is the main problem of Descartes, and it goes on encroaching upon territories once supposed proper to the mind. Descartes began with the certainty that we are thinking beings; that region remains untouched; but up to its very borders the mechanical explanation of nature reigns unchecked.

The physical theory, in its earlier form in *The World*, and later in the *Principles of Philosophy* (which the present account follows), rests upon the metaphysical conclusions of the *Meditations*. It proposes to set forth the genesis of the existing universe from principles which can be plainly understood, and according to the acknowledged laws of the transmission of movement. The idea of force is one of those obscure conceptions which originate in an obscure region, in the sense of muscular power. The true physical conception is motion, the ultimate ground of which is to be sought in God's infinite power. Accordingly the quantity of movement in the universe, like its mover, can neither increase nor diminish. The only circumstance which physics has to consider is the transference of movement from one particle to another, and the change of its direction. Man himself cannot increase the sum of motion; he can only alter its direction. The whole conception of force may disappear from a theory of the universe; and we can adopt a geometrical definition of motion as the shifting of one body from the neighbourhood of those bodies which immediately touch it, and which are assumed to be at rest, to the neighbourhood of other bodies. Motion, in short, is strictly locomotion, and nothing else.

Descartes has laid down three laws of nature, and seven secondary laws regarding impact. The latter are to a large extent incorrect. The first law affirms that every body, so far as it is altogether unaffected by extraneous causes, always

perseveres in the same state of motion or of rest; and the second law that simple or elementary motion is always in a straight line.¹ These doctrines of inertia, and of the composite character of curvilinear motion, were scarcely apprehended even by Kepler or Galileo; but they follow naturally from the geometrical analysis of Descartes.

Extended body has no limits to its extent, though the power of God has divided it in lines discriminating its parts in endless ways. The infinite universe is infinitely full of matter. Empty space, as distinguished from material extension, is a fictitious abstraction. There is no such thing really as a vacuum, any more than there are atoms or ultimate indivisible particles. In both these doctrines of *à priori* science Descartes has not been subverted, but, if anything, corroborated by the results of experimental physics; for the so-called atoms of chemical theory already presuppose, from the Cartesian point of view, certain aggregations of the primitive particles of matter. Descartes regards matter as uniform in character throughout the universe; he anticipates, as it were, from his own transcendental ground, the revelations of spectrum analysis as applied to the sun and stars. We have then to think of a full universe of matter (and matter = extension) divided and figured with endless variety, and set (and kept) in motion by God; and any sort of division, figure and motion will serve the purposes of our supposition as well as another. "Scarcely any supposition,"² he says, "can be made from which the same result, though possibly with greater difficulty, might not be deduced by the same laws of nature; for since, in virtue of these laws, matter successively assumes all the forms of which it is capable, if we consider these forms in order, we shall at one point or other reach the existing form of the world, so that no error need here be feared from a false supposition." As the movement of one particle in a closely-packed universe is only possible if all other parts move simultaneously, so that the last in the series steps into the place of the first; and as the figure and division of the particles varies in each point in the universe, there will inevitably at the same instant result throughout the universe an innumerable host of more or less circular movements, and of vortices or whirlpools of material particles varying in size and velocity. Taking for convenience a limited

Theory of vortices.

portion of the universe, we observe that in consequence of the circular movement, the particles of matter have their corners pared off by rubbing against each other; and two species of matter thus arise,—one consisting of small globules which continue their circular motion with a (centrifugal) tendency to fly off from the centre as they swing round the axis of rotation, while the other, consisting of the fine dust—the filings and parings of the original particles—gradually becoming finer and finer, and losing its velocity, tends (centripetally) to accumulate in the centre of the vortex, which has been gradually left free by the receding particles of globular matter. This finer matter which collects in the centre of each vortex is the *first* matter of Descartes—it constitutes the sun or star. The spherical particles are the *second* matter of Descartes, and their tendency to propel one another from the centre in straight lines towards the circumference of each vortex is what gives rise to the phenomenon of light radiating from the central star. This second matter is atmosphere or firmament, which envelops and revolves around the central accumulation of first matter.

A third form of matter is produced from the original particles. As the small filings produced by friction seek to pass through the interstices between the rapidly revolving spherical particles in the vortex, they are detained and become twisted and channelled in their passage, and when they reach the edge of the inner ocean of solar dust they settle upon it as the froth and foam produced by the agitation of water gathers upon its surface. These form what we term spots in the sun. In some cases they come and go, or dissolve into an aether round the sun; but in other cases they gradually increase until they form a dense crust round the central nucleus. In course of time the star, with its expansive force diminished, suffers encroachments from the neighbouring vortices, and at length they catch it up. If the

¹ *Princip.* part ii. 37.

² *Ib.* part iii. 47.

velocity of the decaying star be greater than that of any part of the vortex which has swept it up, it will ere long pass out of the range of that vortex, and continue its movement from one to another. Such a star is a comet. But in other cases the encrusted star settles in that portion of the revolving vortex which has a velocity equivalent to its own, and so continues to revolve in the vortex, wrapped in its own firmament. Such a reduced and impoverished star is a planet; and the several planets of our solar system are the several vortices which from time to time have been swept up by the central sun-vortex. The same considerations serve to explain the moon and other satellites. They too were once vortices, swallowed up by some other, which at a later day fell a victim to the sweep of our sun.

Such in mere outline is the celebrated theory of *vortices*, which for about twenty years after its promulgation reigned supreme in science, and for much longer time opposed a tenacious resistance to rival doctrines. It is one of the grandest hypotheses which ever have been formed to account by mechanical processes for the movements of the universe. While chemistry rests in the acceptance of ultimate heterogeneous elements, the vortex-theory assumed uniform matter through the universe, and reduced cosmical physics to the same principles as regulate terrestrial phenomena. It ended the old Aristotelian distinction between the sphere beneath the moon and the stary spaces beyond. It banished the spirits and genii, to which even Kepler had assigned the guardianship of the planetary movements; and, if it supposes the globular particles of the envelope to be the active force in carrying the earth round the sun, we may remember that Newton himself assumed an aether for somewhat similar purposes. The great argument on which the Cartesians founded their opposition to the Newtonian doctrine was that attraction was an occult quality, not wholly intelligible by the aid of mere mechanics. The Newtonian theory is an analysis of the elementary movements which in their combination determine the planetary orbits, and gives the formula of the proportions according to which they act. But the Cartesian theory, like the later speculations of Kant and Laplace, proposes to give a hypothetical explanation of the circumstances and motions which in the normal course of things led to the state of things required by the law of attraction. In the judgment of D'Alembert the Cartesian theory was the best that the observations of the age admitted; and "its explanation of gravity was one of the most ingenious hypotheses which philosophy ever imagined." That the explanation fails in detail is undoubted: it does not account for the ellipticity of the planets; it would place the sun, not in one focus, but in the centre of the ellipse; and it would make gravity directed towards the centre only under the equator. But these defects need not blind us to the fact that this hypothesis made the mathematical progress of Hooke, Borelli and Newton much more easy and certain. Descartes professedly assumed a simplicity in the phenomena which they did not present. But such a hypothetical simplicity is the necessary step for solving the more complex problems of nature. The danger lies not in forming such hypotheses, but in regarding them as final, or as more than an attempt to throw light upon our observation of the phenomena. In doing what he did, Descartes actually exemplified that reduction of the processes of nature to mere transposition of the particles of matter, which in different ways was a leading idea in the minds of Bacon, Hobbes and Gassendi. The defects of Descartes lie rather in his apparently imperfect apprehension of the principle of movements uniformly accelerated which his contemporary Galileo had illustrated and insisted upon, and in the indistinctness which attaches to his views of the transmission of motion in cases of impact. It should be added that the modern theory of vortex-atoms (Lord Kelvin's) to explain the constitution of matter has but slight analogy with Cartesian doctrine, and finds a parallel, if anywhere, in a modification of that doctrine by Malebranche.

Besides the last two parts of the *Principles of Philosophy*, the physical writings of Descartes include the *Dioptrics* and *Meteors*, as well as passages in the letters. His optical investigations are perhaps the subject in which he most contributed to the progress

of science; and the lucidity of exposition which marks his *Dioptrics* stands conspicuous even amid the generally luminous style of his works. Its object is a practical one, to determine by scientific considerations the shape of lens best adapted to improve the capabilities of the telescope, which had been invented not long before. The conclusions at which he arrives have not been so useful as he imagined, in consequence of the mechanical difficulties. But the investigation by which he reaches them has the merit of first prominently publishing and establishing the law of the refraction of light. Attempts have been made, principally founded on some remarks of Huygens, to show that Descartes had learned the principles of refraction from the manuscript of a treatise by Willebrord Snell, but the facts are uncertain; and, so far as Descartes founds his optics on any one, it is probably on the researches of Kepler. In any case the discovery is to some extent his own, for his proof of the law is founded upon the theory that light is the propagation of the aether in straight lines from the sun or luminous body to the eye (see LIGHT). Thus he approximates to the wave theory of light, though he supposed that the transmission of light was instantaneous. The chief of his other contributions to optics was the explanation of the rainbow—an explanation far from complete, since the unequal refrangibility of the rays of light was yet undiscovered—but a decided advance upon his predecessors, notably on the *De radiis visis et tactis* (1611) of Marc-Antonio de Dominis, archbishop of Spalato.

If Descartes had contented himself with thus explaining the phenomena of gravity, heat, magnetism, light and similar forces by means of the molecular movements of his vortices, even such a theory would have excited admiration. But he did not stop short in the region of what is usually termed physics. Chemistry and biology are alike swallowed up in the one science of physics, and reduced to a problem of mechanism. This theory, he believed, would afford an explanation of every phenomenon whatever, and in nearly every department of knowledge he has given specimens of its power. But the most remarkable and daring application of the theory was to account for the phenomena of organic life, especially in animals and man. "If we possessed a thorough knowledge," he says, "of all the parts of the seed of any species of animal (e.g. man), we could from that alone, by reasons entirely mathematical and certain, deduce the whole figure and conformation of each of its members, and, conversely, if we knew several peculiarities of this conformation, we could from these deduce the nature of its seed." The organism in this way is regarded as a machine, constructed from the particles of the seed, which in virtue of the laws of motion have arranged themselves (always under the governing power of God) in the particular animal shape in which we see them. The doctrine of the circulation of the blood, which Descartes adopted from Harvey, supplied additional arguments in favour of his mechanical theory, and he probably did much to popularize the discovery. A fire without light, compared to the heat which gathers in a haystack when the hay has been stored before it was properly dry—heat, in short, as an agitation of the particles—is the motive cause of the contraction and dilatations of the heart. Those finer particles of the blood which become extremely rarefied during this process pass off in two directions—one portion, and the least important in the theory, to the organs of generation, the other portion to the cavities of the brain. There not merely do they serve to nourish the organ, they also give rise to a fine ethereal flame or wind through the action of the brain upon them, and thus form the so-called "animal" spirits. From the brain these spirits are conveyed through the body by means of the nerves, regarded by Descartes as tubular vessels, resembling the pipes conveying the water of a spring to act upon the mechanical appliances in an artificial fountain. The nerves conduct the animal spirits to act upon the muscles, and in their turn convey the impressions of the organs to the brain.

Man and the animals as thus described are compared to automata, and termed machines. The vegetative and sensitive souls which the Aristotelians had introduced to break the leap

between inanimate matter and man are ruthlessly swept away; only one soul, the rational, remains, and that is restricted to man. One hypothesis supplants the various principles of life; the rule of absolute mechanism is as complete in the animal as in the cosmos. Reason and thought, the essential quality of the soul, do not belong to the brutes; there is an impassable gulf fixed between man and the lower animals. The only sure sign of reason is the power of language—i.e. of giving expression to general ideas; and language in that sense is not found save in man. The cries of animals are but the working of the curiously-contrived machine, in which, when one portion is touched in a certain way, the wheels and springs concealed in the interior perform their work, and, it may be, a note supposed to express joy or pain is evolved; but there is no consciousness or feeling. "The animals act naturally and by springs, like a watch."² "The greatest of all the prejudices we have retained from our infancy is that of believing that the beasts think."³ If the beasts can properly be said to see at all, "they see as we do when our mind is distracted and keenly applied elsewhere; the images of outward objects paint themselves on the retina, and possibly even the impressions made in the optic nerves determine our limbs to different movements, but we feel nothing of it all, and move as if we were automata."⁴ The sentence of the animal to the lash of his tyrant is not other than the sensitivity of the plant to the influences of light and heat. "It is not much comfort to learn further from Descartes that he denies life to no animal, but makes it consist in the mere heat of the heart. Nor does he deny them feeling in so far as it depends on the bodily organs."⁵

Descartes, with an unusual fondness for the letter of Scripture, quotes oftener than once in support of this monstrous doctrine the dictum, "the blood is the life"; and he remarks, with some sarcasm possibly, that it is a comfortable theory for the eaters of animal flesh. And the doctrine found acceptance among some whom it enabled to get rid of the difficulties raised by Montaigne and those who allowed more difference between animal and animal than between the higher animals and man. It also encouraged vivisection—a practice common with Descartes himself.⁶ The recluses of Port Royal seized it eagerly, discussed automatism, dissected living animals in order to show to a morbid curiosity the circulation of the blood, were careless of the cries of tortured dogs, and finally embalmed the doctrine in a syllogism of their logic,—No matter thinks; every soul of beast is matter: therefore no soul of beast thinks.

But whilst all the organic processes in man go on mechanically, and though by reflex action he may repel attack unconsciously, still the first affirmation of the system was that man was essentially a thinking being; and, while we retain this original dictum, it must not be supposed that the mind is a mere spectator, or like the boatman in the boat. Of course a unity of nature is impossible between mind and body so described. And yet there is a unity of composition, a unity so close that the compound is "really one and in a sense indivisible." You cannot in the actual man cut soul and body asunder; they interpenetrate in every member. But there is one point in the human frame—a point midway in the brain, single and free, which may in a special sense be called the seat of the mind. This is the so-called *corion*, or pineal gland, where in a minimized point the mind on one hand and the vital spirits on the other meet and communicate. In that gland the mystery of creation is concentrated; thought meets extension and directs it; extension moves towards thought and is perceived. Two clear and distinct ideas, it seems, produce an absolute mystery. Mind, driven from the field of extension, erects its last fortress in the pineal gland. In such a state of despair and destitution there is no hope for spiritualism, save in God; and Clauberg, Geulincx and Malebranche all take refuge under the shadow of his wings to escape the tyranny of extended matter.

In the psychology of Descartes there are two fundamental

² *Ib.* ix. 426.

³ *Ib.* x. 204.

⁴ *Ib.* vi. 339.

⁵ *Ib.* x. 208.

⁶ *Ib.* iv. 452 and 454.

¹ *Œuvres*, iv. 494.

Psychology. modes of thought,—perception and volition. "It seems to me," he says, "that in receiving such and such an idea the mind is passive, and that it is active only in volition; that its ideas are put in it partly by the objects which touch the senses, partly by the impressions in the brain, and partly also by the dispositions which have preceded in the mind itself and by the movements of its will."¹ The will, therefore, as being more originate, has more to do with true or false judgments than the understanding. Unfortunately, Descartes is too lordly a philosopher to explain distinctly what either understanding or will may mean. But we gather that in two directions our reason is bound up with bodily conditions, which make or mar it, according as the will, or central energy of thought, is true to itself or not. In the range of perception, intellect is subjected to the material conditions of sense, memory and imagination; and in infancy, when the will has allowed itself to assent precipitately to the conjunctions presented to it by these material processes, thought has become filled with obscure ideas. In the moral sphere the passions or emotions (which Descartes reduces to the six primitive forms of admiration, love, hatred, desire, joy and sadness) are the perceptions or sentiments of the mind, caused and maintained by some movement of the vital spirits, but specially referring to the mind only. The presentation of some object of dread, for example, to the eye has or may have a double effect. On one hand the animal spirits "reflected"² from the image formed on the pineal gland proceed through the nervous tubes to make the muscles turn the back and lift the feet, so as to escape the cause of the terror. Such is the reflex and mechanical movement independent of the mind. But, on the other hand, the vital spirits cause a movement in the gland by which the mind perceives the affection of the organs, learns that something is to be loved or hated, admired or shunned. Such perceptions dispose the mind to pursue what nature dictates as useful. But the estimate of goods and evils which they give is indistinct and unsatisfactory. The office of reason is to give a true and distinct appreciation of the values of goods and evils; or firm and determinate judgments touching the knowledge of good and evil are our proper arms against the influence of the passions.³ We are free, therefore, through knowledge: *ex magna luce in intellectu sequitur magna propensio in voluntate, and omnis peccans est ignorans*. "If we clearly see that what we are doing is wrong, it would be impossible for us to sin, so long as we saw it in that light."⁴ Thus the highest liberty, as distinguished from mere indifference, proceeds from clear and distinct knowledge, and such knowledge can only be attained by firmness and resolution, *i.e.* by the continued exercise of the will. Thus in the perfection of man, as in the nature of God, will and intellect must be united. For thought, will is as necessary as understanding. And innate ideas therefore are mere capacities or tendencies,—possibilities which apart from the will to think may be regarded as nothing at all.

† *The Cartesian School*.—The philosophy of Descartes fought its first battles and gained its first triumphs in the country of his adoption. In his lifetime his views had been taught in Utrecht and Leiden. In the universities of the Netherlands and of lower Germany, as yet free from the conservatism of the old-established seats of learning, the new system gained an easy victory over Aristotelianism, and, as it was adapted for lectures and examinations, soon became almost as scholastic as the doctrines it had supplanted. At Leiden, Utrecht, Groningen, Franeker, Breda, Nimeguen, Harderwyk, Duisburg and Herborn, and at the Catholic university of Louvain, Cartesianism was warmly expounded and defended in seats of learning, of which many are now left desolate, and by adherents whose writings have for the most part long lost interest for any but the antiquary.

The Cartesianism of Holland was a child of the universities, and its literature is mainly composed of commentaries upon the original texts, of theses discussed in the schools, and of systematic expositions of Cartesian philosophy for the benefit of the student. Three names stand out in this

Cartesian professoriate,—Wittich, Clauberg and Geulincx. Christoph Wittich (1625–1687), professor at Duisburg and Leiden, is a representative of the moderate followers who professed to reconcile the doctrines of their school with the faith of Christendom and to refute the theology of Spinoza. Johann Clauberg (*q.v.*) commented clause by clause upon the *Méditations* of Descartes; but he specially claims notice for his work *De corporis et animas in homine conjunctione*, where he maintains that the bodily movements are merely procatartic causes (*i.e.* antecedents, but not strictly causes) of the mental action, and sacrifices the independence of man to the omnipotence of God. The same tendency is still more pronounced in Arnold Geulincx (*q.v.*). With him the reciprocal action of mind and body is altogether denied; they resemble two clocks, so made by the artificer as to strike the same hour together. The mind can act only upon itself; beyond that limit, the power of God must intervene to make any seeming interaction possible between body and soul. Such are the half-hearted attempts at consistency in Cartesian thought, which eventually culminate in the pantheism of Spinoza (see *CARTESIANISM*).

Descartes occasionally had not scrupled to interpret the Scriptures according to his own tenets, while still maintaining, when their letter contradicted him, that the Bible was not meant to teach the sciences. Similar tendencies are found amongst his followers. Whilst Protestant opponents put him in the list of atheists like Vanini, and the Catholics held him as dangerous as Luther or Calvin, there were zealous adherents who ventured to prove the theory of vortices in harmony with the book of Genesis. It was this rationalistic treatment of the sacred writings which helped to confound the Cartesians with the allegorical school of John Cocceius, as their liberal doctrines in theology justified the vulgar identification of them with the heresies of Socinian and Arminian. The chief names in this advanced theology connected with Cartesian doctrines are Ludwig Meyer, the friend and editor of Spinoza, author of a work termed *Philosophia scripturarum interpretes* (1666); Balthasar Bekker, whose *World Bewitched* helped to discredit the superstitious fancies about the devil; and Spinoza, whose *Tractatus theologico-politicus* is in some respects the classical type of rational criticism up to the present day. Against this work and the *Ethics* of Spinoza the orthodox Cartesians (who were in the majority), no less than sceptical hangers-on like Bayle, raised an all but universal howl of reprobation, scarcely broken for about a century.

In France Cartesianism won society and literature before it penetrated into the universities. Clerselier (the friend of Descartes and his literary executor), his son-in-law France. Rohault (who achieved that relationship through his Cartesianism), and others, opened their houses for readings to which the intellectual world of Paris—its learned professors not more than the courtiers and the fair sex,—flocked to hear the new doctrines explained, and possibly discuss their value. Grand seigneurs, like the prince of Condé, the duc de Nevers and the marquis de Vardes, were glad to vary the monotony of their feudal castles by listening to the eloquent rehearsals of Malebranche or Regis. And the salons of Mme de Sévigné, of her daughter Mme de Grignan, and of the duchesse de Maine for a while gave the questions of philosophy a place among the topics of polite society, and furnished to Molière the occasion of his *Femmes savantes*. The Château of the duc de Luynes, the translator of the *Méditations*, was the home of a Cartesian club, that discussed the questions of automatism and of the composition of the sun from filings and parings, and rivalled Port Royal in its vivisections. The cardinal de Retz in his leisurely age at Commercy found amusement in presiding at disputations between the more moderate Cartesians and Don Robert Desgabets, who interpreted Descartes in an original way of his own. Though rejected by the Jesuits, who found peripatetic formulæ a faithful weapon against the enemies of the church, Cartesianism was warmly adopted by the Oratory, which saw in Descartes something of St Augustine, by Port Royal, which discovered a connexion between the new system and Jansenism, and by some amongst the Benedictines and the order of Ste Geneviève.

¹ *Œuvres*, ix. 166.

² *ib.* 48.

³ *Passions de l'âme*, 36.

⁴ *Œuvres*, ix. 170.

The popularity which Cartesianism thus gained in the social and literary circles of the capital was largely increased by the labours of Pierre-Sylvain Regis (1632-1707). On his visit to Toulouse in 1665, with a mission from the Cartesian chiefs, his lectures excited boundless interest; ladies threw themselves with zeal and ability into the study of philosophy; and Regis himself was made the guest of the civic corporation. In 1671 scarcely less enthusiasm was roused in Montpellier; and in 1680 he opened a course of lectures at Paris, with such acceptance that hearers had to take their seats in advance. Regis, by removing the paradoxes and adjusting the metaphysics to the popular powers of apprehension, made Cartesianism popular, and reduced it to a regular system.

But a check was at hand. Descartes, in his correspondence with the Jesuits, had shown an almost cringing eagerness to have their powerful organization on his side. Especially he had written to Père Mesland, one of the order, to show how the Catholic doctrine of the eucharist might be made compatible with his theories of matter. But his undue haste to arrange matters with the church only served to compromise him more deeply. Unwise admirers and malicious opponents exaggerated the theological bearings of his system in this detail; and the efforts of the Jesuits succeeded in getting the works of Descartes, in November 1663, placed upon the index of prohibited books,—*donesc corrigantur*. Thereupon the power of church and state enforced by positive enactments the passive resistance of old institutions to the novel theories. In 1667, the oration at the interment was forbidden by royal order. In 1669, when the chair of philosophy at the Collège Royal fell vacant, one of the four selected candidates had to sustain a thesis against "the pretended new philosophy of Descartes." In 1671 the archbishop of Paris, by the king's order, summoned the heads of the university to his presence, and enjoined them to take stricter measures against philosophical novelties dangerous to the faith. In 1673 a decree of the parlement against Cartesian and other unlicensed theories was on the point of being issued, and was only checked in time by the appearance of a burlesque mandamus against the intruder Reason, composed by Boileau and some of his brother-poets. Yet in 1675 the university of Angers was empowered to repress all Cartesian teaching within its domain, and actually appointed a commission charged to look for such heresies in the theses and the students' note-books of the college of Anjou belonging to the Oratory. In 1677 the university of Caen adopted not less stringent measures against Cartesianism. And so great was the influence of the Jesuits, that the congregation of St Maur, the canons of Ste Geneviève, and the Oratory laid their official ban on the obnoxious doctrines. From the real or fancied *rapprochements* between Cartesianism and Jansenism, it became for a while impolitic, if not dangerous, to avow too loudly a preference for Cartesian theories. Regis was constrained to hold back for ten years his *System of Philosophy*; and when it did appear, in 1690, the name of Descartes was absent from the title-page. There were other obstacles besides the mild persecutions of the church. Pascal and other members of Port Royal openly expressed their doubts about the place allowed to God in the system; the adherents of Gassendi met it by resuscitating atoms; and the Aristotelians maintained their substantial forms as of old; the Jesuits argued against the arguments for the being of God, and against the theory of innate ideas; whilst Pierre Daniel Huet (1630-1721), bishop of Avranches, once a Cartesian himself, made a vigorous onslaught on the contempt in which his former comrades held literature and history, and enlarged on the vanity of all human aspirations after rational truth.

The greatest and most original of the French Cartesians was Malebranche (q.v.). His *Recherche de la vérité*, in 1674, was the baptism of the system into a theistic religion which borrowed its imagery from Augustine; it brought into prominence the metaphysical base which Louis Delaforge, Jacques Rohault and Regis had neither cared for nor understood. But this doctrine was a criticism and a divergence, no less than a consequence, from the principles in Descartes; and it brought upon Malebranche the opposition, not merely of the Cartesian

physicists, but also of Arnauld, Fénelon and Bossuet, who found, or hoped to find, in the *Meditations*, as properly understood, an ally for theology. Popular enthusiasm, however, was with Malebranche, as twenty years before it had been with Descartes; he was the fashion of the day; and his disciples rapidly increased both in France and abroad.

In 1705 Cartesianism was still subject to prohibitions from the authorities; but in a project of new statutes, drawn up for the faculty of arts at Paris in 1720, the *Method* and *Meditations* of Descartes were placed beside the *Organon* and the *Metaphysics* of Aristotle as text-books for philosophical study. And before 1725, readings, both public and private, were given from Cartesian texts in some of the Parisian colleges. But when this happened, Cartesianism was no longer either interesting or dangerous; its theories, taught as ascertained and verified truths, were as worthless as the systematic verbiage which preceded them. Already antiquated, it could not resist the wit and raillery with which Voltaire, in his *Lettres sur les Anglois* (1728), brought against it the principles and results of Locke and Newton. The old Cartesians, Jean Jacques Dortous de Mairan (1678-1771) and especially Fontenelle, with his *Théorie des tourbillons* (1752), struggled in vain to refute Newton by styling attraction an occult quality. Fortunately the Cartesian method had already done its service, even where the theories were rejected. The Port Royalists, Pierre Nicole (1625-1695) and Antoine Arnauld (1612-1694), had applied it to grammar and logic; Jean Domat or Daumat (1625-1696) and Henri François Daguesseau (1668-1751) to jurisprudence; Fontenelle, Charles Perrault (1628-1703) and Jean Terrasson (1670-1750) to literary criticism, and a worthier estimate of modern literature. Though it never ceased to influence individual thinkers, it had handed on to Condillac its popularity with the masses. A Latin abridgment of philosophy, dated 1784, tells us that the innate ideas of Descartes are founded on no arguments, and are now universally abandoned. The ghost of innate ideas seems to be all that it had left.

In Germany a few Cartesian lecturers taught at Leipzig and Halle, but the system took no root, any more than in Switzerland, where it had a brief reign at Geneva after 1669. In *Germany*. Italy the effects were more permanent. What is termed the iatro-mechanical school of medicine, with G. A. Borelli (1668-1679) as its most notable name, entered in a way on the mechanical study of anatomy suggested by Descartes, but was probably much more dependent upon the positive researches of Galileo. At Naples there grew up a Cartesian school, of which the best known members are Michel Angelo Fardella (1650-1708) and Cardinal Gerdil (1718-1802), both of whom, however, attached themselves to the characteristic views of Malebranche.

In England Cartesianism took but slight hold. Henry More, who had given it a modified sympathy in the lifetime of the author, became its opponent in later years; and *England*. Cudworth differed from it in most essential points.

Antony Legrand, from Douai, attempted to introduce it into Oxford, but failed. He is the author of several works, amongst others a system of Cartesian philosophy, where a chapter on "Angels" revives the methods of the schoolmen. His chief opponent was Samuel Parker (1640-1688), bishop of Oxford, who, in his attack on the irreligious novelties of the Cartesian, treats Descartes as a fellow-criminal in infidelity with Hobbes and Gassendi. Rohault's version of the Cartesian physics was translated into English; and Malebranche found an ardent follower in John Norris (1667-1711). Of Cartesianism towards the close of the 17th century the only remnants were an overgrown theory of vortices, which received its death-blow from Newton, and a dubious phraseology anent innate ideas, which found a witty executioner in Locke.

For an account of the metaphysical doctrines of Descartes, in their connexions with Malebranche and Spinoza, see CARTESIANISM.

BIBLIOGRAPHY.—I. *Editions and Translations*.—The collected works of Descartes were published in Latin in 8 vols. at Amsterdam (1670-1683), in 7 vols. at Frankfurt (1697) and in 9 vols. by Elsevier

(1713); in French in 13 vols. (Paris, 1724-1729), republished by Victor Cousin (Paris, 1824-1826) in 11 vols., and again under the authority of the minister of public instruction by C. Adam and P. Tannery (1897 foll.). These include his so-called posthumous works: *The Rules for the Direction of the Mind*, *The Search for Truth by the Light of Nature*, and other unimportant fragments, published (in Latin) in 1701. In 1859-1860 Foucher de Careil published in two parts some unedited writings of Descartes from copies taken by Leibnitz from the original papers. Six editions of the *Opera philosophica* appeared at Amsterdam between 1650 and 1678; a two-volume edition at Leipzig in 1843; there are also French editions, *Œuvres philosophiques*, by A. Garnier, 3 vols. (1834-1835), and L. Aimé-Martin (1838) and *Œuvres morales et philosophiques* by Aimé-Martin with an introduction on life and works by Amedée Prévost (Paris, 1855); *Œuvres choisies* (1850) by Jules Simon. A complete French edition of the collected works was begun in the Romance Library (1907 foll.). German translations by J. H. von Kirchmann under the title *Philosophische Werke* (with biography, &c., Berlin, 1868; 2nd ed., 1882-1891), by Kuno Fischer, *Die Hauptschriften zur Grundlegung seiner Philosophie* (1863), with introduction by Ludw. Fischer (1892). There are also numerous editions and translations of separate works, especially the *Method*, in French, German, Italian, Spanish and Hungarian. There are English translations by J. Veitch, *Method, Meditations and Selections from the Principles* (1850-1853; 11th ed., 1897; New York, 1899); by H. A. P. Torrey (New York, 1892).

II. *Biographical*.—A. Baillet, *La Vie de M. Des Cartes* (Paris, 1691; Eng. trans., 1692), exhaustive but uncritical; notices in the editions of Garnier and Aimé-Martin; A. Hoffmann, *René Descartes* (1905); Elizabeth S. Haldane, *Descartes, his Life and Times* (1905), containing full bibliography; A. Barbier, *René Descartes, sa famille, son lieu de naissance*, &c. (1901); Richard Lowndes, *René Descartes, his Life and Meditations* (London, 1878); J. P. Mahaffy, *Descartes* (1902), with an appendix on Descartes's mathematical work by Frederick Purser; Victor de Swarte, *Descartes directeur spirituel* (Paris, 1904), correspondence with the Princess Palatine; C. J. Jeannel, *Descartes et la princesse palatine* (Paris, 1860); *Lettres de M. Descartes*, ed. Claude Clerseiler (1657). A useful sketch of recent biographies is to be found in *The Edinburgh Review* (July 1906).

III. *Philosophy*.—Beside the histories of philosophy, the article CARTESIANISM, and the above works, consult J. B. Bordas-Demoulini *Le Cartésianisme* (2nd ed., Paris, 1874); J. P. Damiron, *Histoire de la philosophie du XVII^e siècle* (Paris, 1846); V. C. B. Renouvier, *Manuel de philosophie moderne* (Paris, 1842); F. Cousin, *Fragmentes philosophiques*, vol. ii. (3rd ed., Paris, 1838), *Fragmentes de philosophie cartésienne* (Paris, 1845), and in the *Journal des savants* (1860-1861); F. Bouillier, *Hist. de la philosophie cartésienne* (Paris, 1854), 2 vols., and *Hist. et critique de la révolution cartésienne* (Paris, 1842); J. Millet, *Descartes, sa vie, ses travaux, ses découvertes avant 1637* (Paris, 1867), and *Hist. de Descartes depuis 1637* (Paris, 1870); L. Liard, *Descartes* (Paris, 1882); A. Fouillée, *Descartes* (Paris, 1893); *Revue de métaphysique et de morale* (July, 1896, Descartes number); Norman Smith, *Studies in the Cartesian Philosophy* (1902); R. Keussen, *Bewusstsein und Erkenntnis bei Descartes* (1906); A. Kayserling, *Die Idee der Kausalität in den Lehren der Occasionalisten* (1896); J. Iverach, *Descartes, Spinoza and the New Philosophy* (1904); R. Joerges, *Die Lehre von den Empfindungen bei Descartes* (1901); Kuno Fischer, *Hist. of Mod. Phil. Descartes and his School* (Eng. trans., 1887); B. Christiansen, *Das Urteil bei Descartes* (1902); E. Boutroux, "Descartes and Cartesianism" in *Cambridge Modern History*, vol. iv. (1906), chap. 27, with a very full bibliography, pp. 950-953; P. Natorp, *Descartes' Erkenntnistheorie* (Marburg, 1882); L. A. Prévost-Paradol, *Les Moralistes français* (Paris, 1865); C. Schaarschmidt, *Descartes and Spinoza* (Bonn, 1859); R. Adamson, *The Development of Modern Philosophy* (Edinburgh, 1903); J. Müller, *Der Begriff der ethischen Unvollkommenheit bei Descartes und Spinoza* (1890); J. H. von Kirchmann, *R. Descartes' Principien der Philos.* (1863); G. Touchard, *La Morale de Descartes* (1898); Lucien Lévy-Bruhl, *Hist. of Mod. Philos. in France* (Eng. trans., 1899), pp. 1-76.

IV. *Science and Mathematics*.—F. Cajori, *History of Mathematics* (London, 1894); M. Cantor, *Vorlesungen über die Geschichte der Mathematik* (Leipzig, 1894-1901); Sir Michael Foster, *Hist. of Physiol. during the Sixteenth, Seventeenth and Eighteenth Centuries* (1901); Duboux, *La Physique de Descartes* (Lausanne, 1881); G. H. Zeuthen, *Geschichte der Mathematik im 16. und 17. Jahrhundert* (1903); Chasles, *Aperçu historique sur l'origine et le développement des méthodes en géométrie* (3rd ed., 1889). (W. W.; X.)

DESCHAMPS, ÉMILE (1791-1871), French poet and man of letters, was born at Bourges on the 20th of February 1791. The son of a civil servant, he adopted his father's career, but as early as 1812 he distinguished himself by an ode, *La Paix conquise*, which won the praise of Napoleon. In 1818 he collaborated with Henri de Latouche in two verse comedies, *Salmours de Florian* and *Le Tour de faveur*. He and his brother were among the most enthusiastic disciples of the *cénacle* gathered round Victor Hugo, and in July 1823 Émile founded with his master the *Muse française*, which during the year of its existence was the special

organ of the romantic party. His *Études françaises et étrangères* (1828) were preceded by a preface which may be regarded as one of the manifestos of the romanticists. The versions of Shakespeare's *Romeo and Juliet* (1830) and of *Macbeth* (1844), important as they were in the history of the romantic movement, were never staged. He was the author of several libretti, among which may be mentioned the *Roméo et Juliette* of Berlioz. The list of his more important works is completed by his two volumes of stories, *Contes physiologiques* (1854) and *Réalités fantastiques* (1854). He died at Versailles in April 1871. His *Œuvres complètes* were published in 1872-1874 (6 vols.).

His brother, Antoine François Marie, known as ANTONY DESCHAMPS, was born in Paris on the 12th of March 1800 and died at Passy on the 29th of October 1869. Like his brother, he was an ardent romanticist, but his production was limited by a nervous disorder, which has left its mark on his melancholy work. He translated the *Divina Commedia* in 1820, and his poems, *Dernières Paroles* and *Résignation*, were republished with his brother's in 1841.

DESCHAMPS, EUSTACHE, called MOREL (1346?-1406?), French poet, was born at Vertus in Champagne about 1346. He studied at Reims, where he is said to have received some lessons in the art of versification from Guillaume de Machaut, who is stated to have been his uncle. From Reims he proceeded about 1360 to the university of Orleans to study law and the seven liberal arts. He entered the king's service as royal messenger about 1367, and was sent on missions to Bohemia, Hungary and Moravia. In 1372 he was made *huissier d'armes* to Charles V. He received many other important offices, was *bailli* of Valois, and afterwards of Senlis, squire to the Dauphin, and governor of Fismes. In 1380 his patron, Charles V., died, and in the same year the English burnt down his house at Vertus. In his childhood he had been an eye-witness of the English invasion of 1358; he had been present at the siege of Reims and seen the march on Chartres; he had witnessed the signing of the treaty of Bretigny; he was now himself a victim of the English fury. His violent hatred of the English found vent in numerous appeals to carry the war into England, and in the famous prophecy that England would be destroyed so thoroughly that no one should be able to point to her ruins. His own misfortunes and the miseries of France embittered his temper. He complained continually of poverty, railed against women and lamented the woes of his country. His last years were spent on his *Miroir de mariage*, a satire of 13,000 lines against women, which contains some real comedy. The mother-in-law of French farce has her prototype in the *Miroir*.

The historical and patriotic poems of Deschamps are of much greater value. He does not, like Froissart, cast a glamour over the miserable wars of the time but gives a faithful picture of the anarchy of France, and inveighs ceaselessly against the heavy taxes, the vices of the clergy and especially against those who enrich themselves at the expense of the people. The terrible ballad with the refrain "*Sà, de l'argent; sà, de l'argent*" is typical of his work. Deschamps excelled in the use of the ballade and the chant royal. In each of these forms he was the greatest master of his time. In ballade form he expressed his regret for the death of Du Guesclin, who seems to have been the only man except his patron, Charles V., for whom he ever felt any admiration. One of his ballades (No. 285) was sent with a copy of his works to Geoffrey Chaucer, whom he addresses with the words:—

"Tu es d'amours mondains dieux en Albie
Et de la Rose en la terre Angliëque."

Deschamps was the author of an *Art poétique*, with the title of *L'Art de dicter et de fere chansons, balades, virelais et rondeaulz*. Besides giving rules for the composition of the kinds of verse mentioned in the title he enunciates some curious theories on poetry. He divides music into music proper and poetry. Music proper he calls artificial on the ground that everyone could by dint of study become a musician; poetry he calls natural because

¹ "De la prophétie Merlin sur la destruction d'Angleterre qui doit brief advenir" (*Œuvres*, No. 211).

he says it is not an art that can be acquired but a gift. He lays immense stress on the harmony of verse, because, as was the fashion of his day, he practically took it for granted that all poetry was to be sung.

The work of Deschamps marks an important stage in the history of French poetry. With him and his contemporaries the long, formless narrations of the *brochures* give place to complicated and exacting kinds of verse. He was perhaps by nature a moralist and satirist rather than a poet, and the force and truth of his historical pictures gives him a unique place in 14th-century poetry. M. Raynaud fixes the date of his death in 1406, or at latest, 1407. Two years earlier he had been relieved of his charge as *bailli* of Senlis, his plain-spoken satires having made him many enemies at court.

His *Œuvres complètes* were edited (10 vols., 1878-1901) for the *Société des anciens textes français* by Queux de Saint-Hilaire and Gaston Raynaud. A supplementary volume consists of an Introduction by G. Raynaud. See also Dr E. Hoepfner, *Eustache Deschamps* (Strasbourg, 1904).

DESCHANEL, PAUL EUGÈNE LOUIS (1856-), French statesman, son of Émile Deschanel (1819-1904), professor at the Collège de France and senator, was born at Brussels, where his father was living in exile (1851-1859), owing to his opposition to Napoleon III. Paul Deschanel studied law, and began his career as secretary to Deshayes de Marçère (1876), and to Jules Simon (1876-1877). In October 1885 he was elected deputy for Eure and Loire. From the first he took an important place in the chamber, as one of the most notable orators of the Progressist Republican group. In January 1896 he was elected vice-president of the chamber, and henceforth devoted himself to the struggle against the Left, not only in parliament, but also in public meetings throughout France. His addresses at Marseilles on the 25th of October 1896, at Carmaux on the 27th of December 1896, and at Roubaix on the 10th of April 1897, were triumphs of clear and eloquent exposition of the political and social aims of the Progressist party. In June 1898 he was elected president of the chamber, and was re-elected in 1901, but rejected in 1902. Nevertheless he came forward brilliantly in 1904 and 1905 as a supporter of the law on the separation of church and state. He was elected a member of the French Academy in 1899, his most notable works being *Orateurs et hommes d'État* (1888), *Figures de femmes* (1889), *La Décentralization* (1895), *La Question sociale* (1898).

DES CLOIZEAUX, ALFRED LOUIS OLIVIER LEGRAND (1817-1897), French mineralogist, was born at Beauvais, in the department of Oise, on the 17th of October 1817. He became professor of mineralogy at the École Normale Supérieure and afterwards at the Musée d'Histoire Naturelle in Paris. He studied the geysers of Iceland, and wrote also on the classification of some of the eruptive rocks; but his main work consisted in the systematic examination of the crystals of numerous minerals, in researches on their optical properties and on the subject of polarization. He wrote specially on the means of determining the different feldspars. He was awarded the Wollaston medal by the Geological Society of London in 1886. He died in May 1897. His best-known books are *Leçons de cristallographie* (1861); *Manuel de minéralogie* (2 vols., Paris, 1862, 1874 and 1893).

DESCLOIZITE, a rare mineral species consisting of basic lead and zinc vanadate, $(Pb, Zn)_2(OH)VO_4$, crystallizing in the orthorhombic system and isomorphous with olivenite. It was discovered by A. Damour in 1854, and named by him in honour of the French mineralogist Des Cloizeaux. It occurs as small prismatic or pyramidal crystals, usually forming drusy crusts and stalactitic aggregates; also as fibrous encrusting masses with a mammillary surface. The colour is deep cherry-red to brown or black, and the crystals are transparent or translucent with a creamy lustre; the streak is orange-yellow to brown; specific gravity 5.9 to 6.2; hardness 3½. A variety known as cupro-descloizite is dull green in colour; it contains a considerable amount of copper replacing zinc and some arsenic replacing vanadium. Descloizite occurs in veins of lead ores in association with pyromorphite, vanadinite, wulfenite, &c. Localities are

the Sierra de Cordoba in Argentina, Lake Valley in Sierra county, New Mexico, Arizona, Phoenixville in Pennsylvania, and Kappel (Eisen-Kappel) near Klagenfurt in Carinthia.

Other names which have been applied to this species are vanadite, tritochorite and ramirite; the uncertain vanadates euschynite, araeoxene and decbenite are possibly identical with it.

DESCRIPTIVE POETRY, the name given to a class of literature, which may be defined as belonging mainly to the 16th, 17th and 18th centuries in Europe. From the earliest times, all poetry which was not subjectively lyrical was apt to indulge in ornament which might be named descriptive. But the critics of the 17th century formed a distinction between the representations of the ancients and those of the moderns. We find Boileau emphasizing the statement that, while Virgil paints, Tasso describes. This may be a useful indication for us in defining not what should, but what in practice has been called "descriptive poetry." It is poetry in which it is not imaginative passion which prevails, but a didactic purpose, or even something of the instinct of a sublimated auctioneer. In other words, the landscape, or architecture, or still life, or whatever may be the object of the poet's attention, is not used as an accessory, but is itself the centre of interest. It is, in this sense, not correct to call poetry in which this description is only the occasional ornament of a poem, and not its central subject, descriptive poetry. The landscape or still life must fill the canvas, or, if human interest is introduced, that must be treated as an accessory. Thus, in the *Hero and Leander* of Marlowe and in the *Alastor* of Shelley, description of a very brilliant kind is largely introduced, yet these are not examples of what is technically called "descriptive poetry," because it is not the strait between Sestos and Abydos, and it is not the flora of a tropical glen, which concentrates the attention of the one poet or of the other, but it is an example of physical passion in the one case and of intellectual passion in the other, which is diagnosed and dilated on. On the other hand Thomson's *Seasons*, in which landscape takes the central place, and Drayton's *Polyolbion*, where everything is sacrificed to a topographical progress through Britain, are strictly descriptive.

It will be obvious from this definition that the danger ahead of all purely descriptive poetry is that it will lack intensity, that it will be frigid, if not dead. Description for description's sake, especially in studied verse, is rarely a vitalized form of literature. It is threatened, from its very conception, with languor and coldness; it must exercise an extreme art or be condemned to immediate sterility. Boileau, with his customary intelligence, was the first to see this, and he thought that the danger might be avoided by care in technical execution. His advice to the poets of his time was:—

"Soyez riche et pompeux dans vos descriptions;
C'est-là qu'il faut des vers étaler l'élegance;"

and:—

"De figure sans nombre égayer votre ouvrage;
Que toute y fasse aux yeux une riant image,"

and in verses of brilliant humour he mocked the writer who, too full of his subject, and describing for description's sake, will never quit his theme until he has exhausted it:—

"Fuyez de ces auteurs l'abondance stérile
Et ne vous chargez point d'un détail inutile."

This is excellent advice, but Boileau's humorous sallies do not quite meet the question whether such purely descriptive poetry as he criticizes is legitimate at all.

In England had appeared the famous translation (1592-1611), by Josuah Sylvester, of the *Divine Weeks and Works of Du Bartas*, containing such lines as those which the juvenile Dryden admired so much:—

"But when winter's keener breath began
To crystallize the Baltic ocean,
To glaze the lakes, and bridle up the floods,
And perriv with wool the bald-pate woods."

There was also the curious physiological epic of Phineas Fletcher, *The Purple Island* (1633). But on the whole it was not until French influences had made themselves felt on English poetry,

that description, as Boileau conceived it, was cultivated as a distinct art. The *Cooper's Hill* (1642) of Sir John Denham may be contrasted with the less ambitious *Penshurst* of Ben Jonson, and the one represents the new no less completely than the other does the old generation. If, however, we examine *Cooper's Hill* carefully, we perceive that its aim is after all rather philosophical than topographical. The Thames is described indeed, but not very minutely, and the poet is mainly absorbed in moral reflections. Marvell's long poem on the beauties of Nunappleton comes nearer to the type. But it is hardly until we reach the 18th century that we arrive, in English literature, at what is properly known as descriptive poetry. This was the age in which poets, often of no mean capacity, began to take such definite themes as a small country estate (Pomfret's *Choice*, 1700), the cultivation of the grape (Gay's *Wine*, 1708), a landscape (Pope's *Windsor Forest*, 1713), a military manoeuvre (Addison's *Campaign*, 1704), the industry of an apple-orchard (Philip's *Cyder*, 1708) or a piece of topography (Tickell's *Kensington Gardens*, 1722), as the sole subject of a lengthy poem, generally written in heroic or blank verse. These *lours de force* were supported by minute efforts in miniature-painting, by touch applied to touch, and were often monuments of industry, but they were apt to lack personal interest, and to suffer from a general and deplorable frigidity. They were infected with the faults which accompany an artificial style; they were monotonous, rhetorical and symmetrical, while the uniformity of treatment which was inevitable to their plan rendered them hopelessly tedious, if they were prolonged to any great extent.

This species of writing had been cultivated to a considerable degree through the preceding century, in Italy and (as the remarks of Boileau testify) in France, but it was in England that it reached its highest importance. The classic of descriptive poetry, in fact, the specimen which the literature of the world presents which must be considered as the most important and the most successful, is *The Seasons* (1726-1730) of James Thomson (q.v.). In Thomson, for the first time, a poet of considerable eminence appeared, to whom external nature was all sufficient, and who succeeded in conducting a long poem to its close by a single appeal to landscape, and to the emotions which it directly evokes. Coleridge, somewhat severely, described *The Seasons* as the work of a good rather than of a great poet, and it is an indisputable fact that, at its very best, descriptive poetry fails to awaken the highest powers of the imagination. A great part of Thomson's poem is nothing more nor less than a skillfully varied catalogue of natural phenomena. The famous description of twilight in "the fading many-coloured woods" of autumn may be taken as an example of the highest art to which purely descriptive poetry has ever attained. It is obvious, even here, that the effect of these rich and sonorous lines, in spite of the splendid effort of the artist, is monotonous, and leads us up to no final crisis of passion or rapture. Yet Thomson succeeds, as few other poets of his class have succeeded, in producing nobly-massed effects and comprehensive beauties such as were utterly unknown to his predecessors. He was widely imitated in England, especially by Armstrong, by Akenside, by Shenstone (in *The Schoolmistress*, 1742), by the anonymous author of *Albania*, 1737, and by Goldsmith (in *The Deserted Village*, 1770). No better example of the more pedestrian class of descriptive poetry could be found than the last-mentioned poem, with its minute and Dutch-like painting:—

"How often have I paused on every charm:
The sheltered cot, the cultivated farm;
The never-failing brook, the busy mill,
The decent church that topped the neighbouring hill:
The hawthorn-bush, with seats beneath the shade,
For talking age and whispering lovers made."

On the continent of Europe the example of Thomson was almost immediately fruitful. Four several translations of *The Seasons* into French contended for the suffrages of the public, and J. F. de Saint-Lambert (1716-1803) imitated Thomson in *Les Saisons* (1769), a poem which enjoyed popularity for half a century, and of which Voltaire said that it was the only one of its generation

which would reach posterity. Nevertheless, as Madame du Deffand told Walpole, Saint-Lambert is "froid, fade et faux," and the same may be said of J. A. Roucher (1745-1794), who wrote *Les Mois* in 1779, a descriptive poem famous in its day. The Abbé Jacques Delille (1738-1813), perhaps the most ambitious descriptive poet who has ever lived, was treated as a Virgil by his contemporaries; he published *Les Géorgiques* in 1769, *Les Jardins* in 1782, and *L'Homme des champs* in 1803, but he went furthest in his brilliant, though artificial, *Trois règnes de la nature* (1809), which French critics have called the masterpiece of this whole school of descriptive poetry. Delille, however, like Thomson before him, was unable to avoid monotony and want of coherency. Picture follows picture, and no progress is made. The satire of Marie Joseph Chénier, in his famous and witty *Discours sur les poèmes descriptifs*, brought the vogue of this species of poetry to an end.

In England, again, Wordsworth, who treated the genius of Thomson with unmerited severity, revived descriptive poetry in a form which owed more than Wordsworth realized to the model of *The Seasons*. In *The Excursion* and *The Prelude*, as well as in many of his minor pieces, Wordsworth's philosophical and moral intentions cannot prevent us from perceiving the large part which pure description takes; and the same may be said of much of the early blank verse of S. T. Coleridge. Since their day, however, purely descriptive poetry has gone more and more completely out of fashion, and its place has been taken by the richer and directer effects of such prose as that of Ruskin in English, or of Frémontin and Pierre Loti in French. It is almost impossible in descriptive verse to obtain those vivid and impassioned appeals to the imagination which are of the very essence of genuine poetry, and it is unlikely that descriptive poetry, as such, will again take a prominent place in living literature. (E. G.)

DESERT, a term somewhat loosely employed to describe those parts of the land surface of the earth which do not produce sufficient vegetation to support a human population. Few areas of large extent in any part of the world are absolutely devoid of vegetation, and the transition from typical desert conditions is often very gradual and ill-defined. ("Desert" comes from Lat. *deserere*, to abandon; distinguish "desert," merit, and "dessert," fruit eaten after dinner, from *de* and *servare*, to serve.)

Deserts are conveniently divided into two classes according to the causes which give rise to the desert conditions. In "cold deserts" the want of vegetation is wholly due to the prevailing low temperature, while in "hot deserts" the surface is unproductive because, on account of high temperature and deficient rainfall, evaporation is largely in excess of precipitation. Cold deserts accordingly occur in high latitudes (see TUNDRA and POLAR REGIONS). Hot desert conditions are primarily found along the tropical belts of high atmospheric pressure in which the conditions of warmth and dryness are most fully realized, and on their equatorial sides, but the zonal arrangement is considerably modified in some regions by the monsoonal influence of elevated land. Thus we have in the northern hemisphere the Sahara desert, the deserts of Arabia, Iran, Turan, Takla Makan and Gobi, and the desert regions of the Great Basin in North America; and in the southern hemisphere the Kalahari desert in Africa, the desert of Australia, and the desert of Atacama in South America. Where the line of elevated land runs east and west, as in Asia, the desert belt tends to be displaced into higher latitudes, and where the line runs north and south, as in Africa, America and Australia, the desert zone is cut through on the windward side of the elevation and the arid conditions intensified on the lee side. Desert conditions also arise from local causes, as in the case of the Indian desert situated in a region inaccessible to either of the two main branches of the south-west monsoon.

Although rivers rising in more favoured regions may traverse deserts on their way to the sea, as in the case of the Nile and the Colorado, the fundamental physical condition of an arid area is that it contributes nothing to the waters of the ocean. The rainfall chiefly occurs in violent cloudbursts, and the soluble matter in the soil is carried down by intermittent streams to salt lakes

around which deposits are formed as evaporation takes place. The land forms of a desert are exceedingly characteristic. Surface erosion is chiefly due to rapid changes of temperature through a wide range, and to the action of wind transferring sand and dust, often in the form of "dunes" resembling the waves of the sea. Dry valleys, narrow and of great depth, with precipitous sides, and ending in "cirques," are probably formed by the intense action of the occasional cloud-bursts.

When water can be obtained and distributed over an arid region by irrigation, the surface as a rule becomes extremely productive. Natural springs give rise to oases at intervals and make the crossing of large deserts possible. Where a river crosses a desert at a level near that of the general surface, irrigation can be carried on with extremely profitable results, as has been done in the valley of the Nile and in parts of the Great Basin of North America; in cases, however, where the river has cut deeply and flows far below the general surface, irrigation is too expensive. Much has been done in parts of Australia by means of artesian wells.

For a general account of deserts see Professor Johannes Walther, *Des Gesetze der Wüstenbildung* (Berlin, 1900), in which many references to other original authorities will be found. (H. N. D.)

DESERTION, the act of forsaking or abandoning; more particularly, the wilful abandonment of an employment or of duty, in violation of a legal or moral obligation.

The offence of naval or military desertion is constituted when a man absents himself with the intention either of not returning or of escaping some important service, such as embarkation for foreign service, or service in aid of the civil power. In the United Kingdom desertion has always been recognized by the civil law, and until 1827 (7 & 8 Geo. IV. c. 28) was a felony punishable by death. It was subsequently dealt with by the various Mutiny Acts, which were replaced by the Army Act 1881, renewed annually by the Army (Annual) Act. By § 12 of the act every person subject to military law who deserts or attempts to desert, or who persuades or procures any person to desert, shall, on conviction by court martial, if he committed the offence when on active service or under orders for active service, be liable to suffer death, or such less punishment as is mentioned in the act. When the offence is committed under any other circumstances, the punishment for the first offence is imprisonment, and for the second or any subsequent offence penal servitude or such less punishment as is mentioned in the act. § 44 contains a scale of punishments, and §§ 175-184 an enumeration of persons subject to military law. By § 153 any person who persuades a soldier to desert or aids or assists him or conceals him is liable, on conviction, to be imprisoned, with or without hard labour, for not more than six months. § 154 makes provision for the apprehension of deserters. § 161 lays down that where a soldier has served continuously in an exemplary manner for not less than three years in any corps of regular forces he is not to be tried or punished for desertion which has occurred before the commencement of the three years. Desertion from the regular forces can only be tried by a military court, but in the case of the militia and reserve forces desertion can be tried by a civil court. The Army Act of 1881 made a welcome distinction between actual desertion, as defined at the commencement of this article, and the quitting one regiment in order to enlist in another. This offence is now separately dealt with as fraudulent enlistment; formerly, it was termed "desertion and fraudulent enlistment," and the statistics of desertion proper were consequently and erroneously magnified. The gross total of desertions in the British Army in an average year (1903-1904) was nearly 4000, or 1.4% of the average strength of the army, but owing to men rejoining from desertion, fraudulent enlistment, &c., the net loss was no more than 1286, i.e. less than .5%. The army of the United States suffers very severely from desertion, and very few deserters rejoin or are recaptured (see *Journal of the Roy. United Service Inst.*, December 1905, p. 1469). In the year 1900-1901, 3110 men deserted (4.3% of average strength); in 1901-1902, 4667 (or 5.9%); in 1904-1905, 6553 (or 6.8%); and in 1905-1906, 6158 out of less than 60,000 men, or 7.4%.

In all armies desertion while on active service is punishable by death; on the continent of Europe, owing to the system of compulsory service, desertion is infrequent, and takes place usually when the deserter wishes to leave his country altogether. It was formerly the practice in the English army to punish a man convicted of desertion by tattooing on him the letter "D" to prevent his re-enlistment, but this has been long abandoned in deference to public opinion, which erroneously adopted the idea that the "marking" was effected by red-hot irons or in some other manner involving torture. The Navy Discipline Act 1866, and the Naval Deserters Act 1847, contain similar provisions to the Army Act of 1881 for dealing with desertions from the navy. In the United States navy the term "straggling" is applied to absence without leave, where the probability is that the person does not intend to desert. The United States government offers a monetary reward of between \$20 and \$30 for the arrest and delivery of deserters from the army and navy.

In the British merchant service the offence of desertion is defined as the abandonment of duty by quitting the ship before the termination of the engagement, without justification, and with the intention of not returning.

Desertion is also the term applied to the act by which a man abandons his wife and children, or either of them. Desertion of a wife is a matrimonial offence; under the Matrimonial Causes Act 1857, a decree of judicial separation may be obtained in England by either husband or wife on the ground of desertion, without cause, for two years and upwards (see also DIVORCE).

For the desertion of children see CHILDREN, LAW RELATING TO; INFANT. (T. A. I.)

DES ESSARTS, EMMANUEL ADOLPHE (1839-), French poet and man of letters, was born at Paris on the 5th of February 1839. His father, Alfred Stanislas Langlois des Essarts (d. 1893), was a poet and novelist of considerable reputation. The son was educated at the École Normale Supérieure, and became a teacher of rhetoric and finally professor of literature at Dijon and at Clermont. His works are: *Poésies parisiennes* (1862), a volume of light verse on trifling subjects; *Les Élévations* (1864), philosophical poems; *Origines de la poésie lyrique en France au XVI^e siècle* (1873); *Du génie de Chateaubriand* (1876); *Poèmes de la Révolution* (1879); *Pallas Athènes* (1887); *Portraits de maîtres* (1888), &c.

DESFONTAINES, RENÉ LOUCHE (1750-1833), French botanist, was born at Tremblay (Ile-et-Vilaine) on the 14th of February 1750. After graduating in medicine at Paris, he was elected a member of the Academy of Sciences in 1783. In the same year he set out for North Africa, on a scientific exploring expedition, and on his return two years afterwards brought with him a large collection of plants, animals, &c., comprising, it is said, 1600 species of plants, of which about 300 were described for the first time. In 1786 he was nominated to the post of professor at the Jardin des Plantes, vacated in his favour by his friend, L. G. Lemoussier. His great work, *Flora Atlantica sive historia plantarum quae in Atlantide, agro Tunetano et Algeriensis crescunt*, was published in 2 vols. 4to in 1798, and he produced in 1804 a *Tableau de l'école botanique du muséum d'histoire naturelle de Paris*, of which a third edition appeared in 1831, under the new title *Catalogus plantarum horti regii Parisiensis*. He was also the author of many memoirs on vegetable anatomy and physiology, descriptions of new genera and species, &c., one of the most important being a "Memoir on the Organization of the Monocotyledons." He died at Paris on the 16th of November 1833. His Barbary collection was bequeathed to the Muséum d'Histoire Naturelle, and his general collection passed into the hands of the English botanist, Philip Barker Webb.

DESFORGES, PIERRE JEAN BAPTISTE CHOUDARD (1746-1806), French dramatist and man of letters, natural son of Dr Antoine Petit, was born in Paris on the 15th of September 1746. He was educated at the Collège Mazarin and the Collège de Beauvais, and at his father's desire began the study of medicine. Dr Petit's death left him dependent on his own resources, and after appearing on the stage of the Comédie Italienne in Paris he joined a troupe of wandering actors, whom he served in the

capacity of playwright. He married an actress, and the two spent three years in St Petersburg, where they were well received. In 1782 he produced at the Comédie Italienne an adaptation of Fielding's novel with the title *Tom Jones à Londres*. His first great success was achieved with *L'Épave villageoise* (1785) to the music of Grétry. *La Femme jalouse*, a five-act comedy in verse (1785), *Jocande* (1790) for the music of Louis Jaden, *Les Époux divorcés* (1790), a comedy, and other pieces followed. Desforges was one of the first to avail himself of the new facilities afforded under the Revolution for divorce and re-marriage. The curious record of his own early indiscretions in *Le Poète, ou mémoires d'un homme de lettres écrits par lui-même* (4 vols., 1798) is said to have been undertaken at the request of Madame Desforges. He died in Paris on the 13th of August 1806.

DESGARCINS, MAGDELEINE MARIE [LOUISE] (1769-1797), French actress, was born at Mont Dauphin (Hautes Alpes). In her short career she became one of the greatest of French tragédiennes, the associate of Talma, with whom she nearly always played. Her début at the Comédie Française occurred on the 24th of May 1788, in *Bajazet*, with such success that she was at once made *sociétaire*. She was one of the actresses who left the Comédie Française in 1791 for the house in the rue Richelieu, soon to become the Théâtre de la République, and there her triumphs were no less—in *King Lear*, *Othello*, La Harpe's *Mélanie et Virginie*, &c. Her health, however, failed, and she died insane, in Paris, on the 27th of October 1797.

DESHAYES, GÉRARD PAUL (1795-1875), French geologist and conchologist, was born at Nancy on the 13th of May 1797, his father at that time being professor of experimental physics in the École Centrale of the department of la Meurthe. He studied medicine at Strassburg, and afterwards took the degree of *bachelier ès lettres* in Paris in 1821; but he abandoned the medical profession in order to devote himself to natural history. For some time he gave private lessons on geology, and subsequently became professor of natural history in the Muséum d'Histoire Naturelle. He was distinguished for his researches on the fossil mollusca of the Paris Basin and of other Tertiary areas. His studies on the relations of the fossil to the recent species led him as early as 1829 to conclusions somewhat similar to those arrived at by Lyell, to whom Deshayes rendered much assistance in connexion with the classification of the Tertiary system into Eocene, Miocene and Pliocene. He was one of the founders of the Société Géologique de France. In 1839 he began the publication of his *Traité élémentaire de conchyliologie*, the last part of which was not issued until 1858. In the same year (1839) he went to Algeria for the French Government, and spent three years in explorations in that country. His principal work, which resulted from the collections he made, *Mollusques de l'Algérie*, was issued (incomplete) in 1848. In 1870 the Wollaston medal of the Geological Society of London was awarded to him. He died at Born on the 9th of June 1875. His publications included *Description des coquilles fossiles des environs de Paris* (2 vols. and atlas, 1824-1837); *Description des animaux sans vertèbres découverts dans le bassin de Paris* (3 vols. and atlas, 1856-1866); *Catalogue des mollusques de l'île de la Réunion* (1863).

DESHOULIÈRES, ANTOINETTE DU LIGIER DE LA GARDE (1638-1694), French poet, was born in Paris on the 1st of January 1638. She was the daughter of Melchior du Ligier, sieur de la Garde, *maître d'hôtel* to the queens Marie de' Medici and Anne of Austria. She received a careful and very complete education, acquiring a knowledge of Latin, Spanish and Italian, and studying prosody under the direction of the poet Jean Hesnault. At the age of thirteen she married Guillaume de Boisguerin, seigneur Deshoulières, who followed the prince of Condé as lieutenant-colonel of one of his regiments to Flanders about a year after the marriage. Madame Deshoulières returned for a time to the house of her parents, where she gave herself to writing poetry and studying the philosophy of Gassendi. She rejoined her husband at Rocroi, near Brussels, where, being distinguished for her personal beauty, she became the object of embarrassing attentions on the part of the prince of Condé. Having made herself obnoxious to the government by her urgent demand for

the arrears of her husband's pay, she was imprisoned in the château of Wilworden. After a few months she was freed by her husband, who attacked the château at the head of a small band of soldiers. An amnesty having been proclaimed, they returned to France, where Madame Deshoulières soon became a conspicuous personage at the court of Louis XIV. and in literary society. She won the friendship and admiration of the most eminent literary men of the age—some of her more zealous flatterers even going so far as to style her the tenth muse and the French Calliope. Her poems were very numerous, and included specimens of nearly all the minor forms, odes, eclogues, idylls, elegies, chansons, ballads, madrigals, &c. Of these the idylls alone, and only some of them, have stood the test of time, the others being entirely forgotten. She wrote several dramatic works, the best of which do not rise to mediocrity. Her friendship for Corneille made her take sides for the *Phèdre* of Pradon against that of Racine. Voltaire pronounced her the best of women French poets; and her reputation with her contemporaries is indicated by her election as a member of the Academy of the Ricovrati of Padua and of the Academy of Arles. In 1688 a pension of 2000 livres was bestowed upon her by the king, and she was thus relieved from the poverty in which she had long lived. She died in Paris on the 17th February 1694. Complete editions of her works were published at Paris in 1695, 1747, &c. These include a few poems by her daughter, Antoinette Thérèse Deshoulières (1656-1718), who inherited her talent.

DESICCATION (from the Lat. *desiccare*, to dry up), the operation of drying or removing water from a substance. It is of particular importance in practical chemistry. If a substance admits of being heated to say 100°, the drying may be effected by means of an air-bath, which is simply an oven heated by gas or by steam. Otherwise a *desiccator* must be employed; this is essentially a closed vessel in which a hygroscopic substance is placed together with the substance to be dried. The process may be accelerated by exhausting the desiccator; this so-called vacuum desiccation is especially suitable for the concentration of aqueous solutions of readily decomposable substances. Of the hygroscopic substances in common use, phosphoric anhydride, concentrated sulphuric acid, and dry potassium hydrate are almost equal in power; sodium hydrate and calcium chloride are not much behind.

Two common types of desiccator are in use. In one the absorbent is placed at the bottom, and the substance to be dried above. Hempel pointed out that the efficiency would be increased by inverting this arrangement, since water vapour is lighter than air and consequently rises. Liquids are dried either by means of the desiccator, or, as is more usual, by shaking with a substance which removes the water. Fused calcium chloride is the commonest absorbent; but it must not be used with alcohols and several other compounds, since it forms compounds with these substances. Quicklime, barium oxide, and dehydrated copper sulphate are especially applicable to alcohol and ether; the last traces of water may be removed by adding metallic sodium and distilling. Gases are dried by leading them through towers or tubes containing an appropriate drying material. The experiments of H. B. Baker on the influence of moisture on chemical combination have shown the difficulty of removing the last traces of water.

In chemical technology, apparatus on the principle of the laboratory air-bath are mainly used. Crystals and precipitates, deprived of as much water as possible by centrifugal machines or filter-presses, are transported by means of a belt, screw, or other form of conveyer, on to trays staged in brick chambers heated directly by flue gases or steam pipes; the latter are easily controlled, and if the steam be superheated a temperature of 300° and over may be maintained. In some cases the material traverses the chamber from the coolest to the hottest part on a conveyer or in wagons. Rotating cylinders are also used; the material to be dried being placed inside, and the cylinder heated by a steam jacket or otherwise.

DESIDERIO DA SETTIGNANO (1428-1464), Italian sculptor, was born at Settignano, a village on the southern slope of the hill

of Fiesole, still surrounded by the quarries of sandstone of which the hill is formed, and inhabited by a race of "stone-cutters." Desiderio was for a short time a pupil of Donatello, who, according to Vasari, he assisted in the work on the pedestal of David, and he seems to have worked also with Mino da Fiesole, with the delicate and refined style of whose works those of Desiderio seem to have a closer affinity than with the perhaps more masculine tone of Donatello. Vasari particularly extols the sculptor's treatment of the figures of women and children. It does not appear that Desiderio ever worked elsewhere than at Florence; and it is there that those who are interested in the Italian sculpture of the Renaissance must seek his few surviving decorative and monumental works, though a number of his delicately carved marble busts of women and children are to be found in the museums and private collections of Germany and France. The most prominent of his works are the tomb of the secretary of state, Marsuppini, in Santa Croce, and the great marble tabernacle of the Annunciation in San Lorenzo, both of which belong to the latter period of Desiderio's activity; and the cherubs' heads which form the exterior frieze of the Pazzi Chapel. Vasari mentions a marble bust by Desiderio of Marietta degli Strozzi, which for many years was held to be identical with a very beautiful bust bought in 1878 from the Strozzi family for the Berlin Museum. This bust is now, however, generally acknowledged to be the work of Francesco Laurana; whilst Desiderio's bust of Marietta has been recognized in another marble portrait acquired by the Berlin Museum in 1842. The Berlin Museum also owns a coloured plaster bust of an Urbino lady by Desiderio, the model for which is in the possession of the earl of Wemyss. Other important busts by the master are in the Bargello, Florence, the Louvre in Paris, the collections of M. Figdor and M. Benda in Vienna, and of M. Dreyfus in Paris. Like most of Donatello's pupils, Desiderio worked chiefly in marble, and not a single work in bronze has been traced to his hand.

See Wilhelm Bode, *Die italienische Plastik* (Berlin, 1893).

DESIDERIUS, the last king of the Lombards, is chiefly known through his connexion with Charlemagne. He was duke of Tuscany and became king of the Lombards after the death of Aistulf in 756. Seeking, like his predecessors, to extend the Lombard power in Italy, he came into collision with the papacy, and about 772 the new pope, Adrian I., implored the aid of Charlemagne against him. Other causes of quarrel already existed between the Frankish and the Lombard kings. In 770 Charlemagne had married a daughter of Desiderius; but he soon put this lady away, and sent her back to her father. Moreover, Gerberga, the widow of Charlemagne's brother Carloman, had sought the protection of the Lombard king after her husband's death in 771; and in return for the slight cast upon his daughter, Desiderius had recognized Gerberga's sons as the lawful Frankish kings, and had attacked Adrian for refusing to crown them. Such was the position when Charlemagne led his troops across the Alps in 773, took the Lombard capital, Ticinum, the modern Pavia, in June 774, and added the kingdom of Lombardy to his own dominions. Desiderius was carried to France, where he died, and his son, Adalgis, spent his life in futile attempts to recover his father's kingdom. The name of Desiderius appears in the romances of the Carolingian period.

See S. Abel, *Untergang des Langobardenreichs* (Göttingen, 1859); and *Jahrbücher des fränkischen Reiches unter Karl dem Grossen* (Leipzig, 1865); L. M. Hartmann, *Geschichte Italiens im Mittelalter* (Gotha, 1903); and Paulus Diaconus, *Historia Langobardorum*, edited by L. Bethmann and G. Waitz (Hanover, 1878).

DESIGN (Fr. *dessin*, drawing; Lat. *designare*, to mark out), in the arts, a drawing, more especially when made as a guide for the execution of work; that side of drawing which deals with arrangement rather than representation; and generally, by analogy, a deliberate planning, scheming or purpose. Modern use has tended to associate design with the word "original" in the sense of new or abnormal. The end of design, however, is properly utility, fitness and delight. If a discovery, it should be a discovery of what seems inevitable, an inspiration arising out of the conditions, and parallel to invention in the sciences. The faculty of design has best flourished when an almost spontaneous

development was taking place in the arts, and while certain classes of arts, more or less noble, were generally demanded and the demand copiously satisfied, as in the production of Greek vases, Byzantine mosaics, Gothic cathedrals, and Renaissance paintings. Thus where a "school of design" arises there is much general likeness in the products but also a general progress. The common experience—"tradition"—is a part of each artist's stock in trade; and all are carried along in a stream of continuous exploration. Some of the arts, writing, for instance, have been little touched by conscious originality in design, all has been progress, or, at least, change, in response to conditions. Under such a system, in a time of progress, the proper limitations react as intensity; when limitations are removed the designer has less and less upon which to react, and unconditioned liberty gives him nothing at all to lean on. Design is response to needs, conditions and aspirations. The Greeks so well understood this that they appear to have consciously restrained themselves to the development of selected types, not only in architecture and literature, but in domestic arts, like pottery. Design with them was less the new than the true.

For the production of a school of design it is necessary that there should be a considerable body of artists working together, and a large demand from a sympathetic public. A process of continuous development is thus brought into being which sustains the individual effort. It is necessary for the designer to know familiarly the processes, the materials and the skilful use of the tools involved in the productions of a given art, and properly only one who practises a craft can design for it. It is necessary to enter into the traditions of the art, that is, to know past achievements. It is necessary, further, to be in relation with nature, the great reservoir of ideas, for it is from it that fresh thought will flow into all forms of art. These conditions being granted, the best and most useful meaning we can give to the word design is exploration, experiment, consideration of possibilities. Putting too high a value on originality other than this is to restrict natural growth from vital roots, in which true originality consists. To take design in architecture as an example, we have rested too much on definite precedent (a different thing from living tradition) and, on the other hand, hoped too much from newness. Exploration of the possibilities in arches, vaults, domes and the like, as a chemist or a mathematician explores, is little accepted as a method in architecture at this time, although in antiquity it was by such means that the great master-works were produced: the Pantheon, Santa Sophia, Durham and Amiens cathedrals. The same is true of all forms of design. Of course the genius and inspiration of the individual artist is not here ignored, but assumed. What we are concerned with is a mode of thought which shall make it most fruitful. (W. R. L.)

DESIRE, in popular usage, a term for a wishing or longing for something which one has not got. For its technical use see **PSYCHOLOGY**. The word is derived through the French from Lat. *desiderare*, to long or wish for, to miss. The substantive *desiderium* has the special meaning of desire for something one has once possessed but lost, hence regret or grief. The usual explanation of the word is to connect it with *sidus*, star, as in *considerare*, to examine the stars with attention, hence, to look closely at. If this is so, the history of the transition in meaning is unknown. J. B. Greenough (*Harvard Studies in Classical Philology*, i. 96) has suggested that the word is a military slang term. According to this theory *desiderare* meant originally to miss a soldier from the ranks at roll-call, the root being that seen in *sedere*, to sit, *sedes*, seat, place, &c.

DESK (from Lat. *discus*, quoit, in med. sense of "table," cf. "dish" and Ger. *Tisch*, table, from same source), any kind of flat or sloping table for writing or reading. Its earliest shape was probably that with which we are familiar in pictures of the monastic *scriptorium*—rather high and narrow with a sloping slab. The primitive desk had little accommodation for writing materials, and no storage room for papers; drawers, cupboards and pigeon-holes were the evolution of periods when writing grew common, and when letters and other documents requiring preservation became numerous. It

was long the custom to secure papers in chests or cabinets, whereas the modern desk serves the double purpose of a writing-table and a storehouse for documents. The first development from the early stall-like desk consisted of the addition of a drawer; then the table came to be supported upon legs or columns, which, as in the many beautiful examples constructed by Bouille and his school, were often of elaborate grace. Eventually the legs were replaced by a series of superimposed drawers forming pedestals—hence the familiar pedestal writing-table.

For a long period there were two distinct contemporary forms of desk—the table and the bureau or *escritoire*. The latter shape attained a popularity so great that, especially in England and America, it was found even in houses in which there was little occasion for writing. The English-speaking people of the 18th century were amazingly fond of pieces of furniture which served a double or triple purpose. The bureau—the word is the French generic appellation for a desk—derives its name from the material with which it was originally covered (Fr. *bure*, woollen cloth). It consists of an upright carcass sloping inward at the top, and provided with long drawers below. The upper part is fitted with small drawers and pigeon-holes, and often with secret places, and the writing space is formed by a hinged slab supported on runners; when not in use this slab closes up the sloping top. During the 18th century innumerable thousands of these bureaux were made on both sides of the Atlantic—indeed, if we except tables and chairs, no piece of old furniture is more common. In the first part of that period they were usually of oak, but when mahogany was introduced into Europe it speedily ousted the heavier-looking wood. Its deep rich colour and the high polish of which it was capable added appreciably to its ornamental appearance. While the pigeon-holes and small drawers were used for papers, the long drawers were often employed for purposes other than literary. In time the bureau-secretaire became a bureau-bookcase, the glazed shelves, which were often a separate erection, resting upon the top of the bureau. The cabinetmakers of the second half of the 18th century, the period of the greatest *floraison* of this combination, competed with each other in devising elegant frets for the glass fronts. Solid and satisfying to the eye, if somewhat severe in form, the mahogany bureau was usually an exceedingly presentable piece of furniture. Occasionally it had a *bombé* front which mitigated its severity; this was especially the case in the Dutch varieties, which were in a measure free adaptations of the French Louis Quinze *commode*. These Dutch bureaux, and the English ones made in imitation of them, were usually elaborately inlaid with floral designs in coloured woods; but whereas the Batavian marquetry was often rough and crude, the English work was usually of considerable excellence. Side by side with this form of writing apparatus was one variety or another of the writing-table proper. In so far as it is possible to generalize upon such a detail it would appear that the bureau was the desk of the yeoman and what we now call the lower middle class, and that the slighter and more table-like forms were preferred by those higher in the social scale. This probably means no more than that while the one class preserved the old English affection for the solid and heavy furniture which would last for generations, those who were more free to follow the fashions and fancies of their time were, as the peculiarly easy classes always have been, ready to abandon the old for the new.

Just about the time when the flat table with its drawers in a single row, or in nests serving as pedestals, was finally assuming its familiar modern shape, an invention was introduced which was destined eventually, so far as numbers and convenience go, to supersede all other forms of desk. This was the cylinder-top writing-table. Nothing is known of the originator of this device, but it is certain that if not French himself he worked in France. The historians of French furniture agree in fixing its introduction about the year 1750, and we know that a desk worked on this principle was in the possession of the French crown in the year 1760. Even in its early days the cylinder took more than one form. It sometimes consisted of a solid piece of curved wood,

times of a tambour frame—that is to say, of a series of

narrow jointed strips of wood mounted on canvas; the revolving shutters of a shop-front are an adaptation of the idea. For a long period, however, the cylinder was most often solid, and remained so until the latter part of the 19th century, when the "American roll-top desk" began to be made in large numbers. This is indeed the old French form with a tambour cylinder, and it is now the desk that is most frequently met with all over the world for commercial purposes. Its popularity is due to its large accommodation, and to the facility with which the closing of the cylinder conceals all papers, and automatically locks every drawer. To France we owe not only the invention of this ubiquitous form, but the construction of many of the finest and most historic desks that have survived—the characteristic marquetry writing-tables of the Bouille period, and the gilded splendours of that of Louis Quinze have never been surpassed in the history of furniture. Indeed, the "Bureau du roi" which was made for Louis XV. is the most famous and magnificent piece of furniture that, so far as we know, was ever constructed. This desk, which is now one of the treasures of the Louvre, was the work of several artist-artificers, chief among whom were Oeben and Riesener—Oeben, it may be added here as a matter of artistic interest, became the grandfather of Eugene Delacroix. The bureau is signed "Riesener fa. 1769 à l' Arsenal de Paris," but it has been established that, however great may have been the share of its construction which fell to him, the conception was that of Oeben. The work was ordered in 1760; it would thus appear that nine years were consumed in perfecting it, which is not surprising when we learn from the detailed account of its construction that the work began with making a perfect miniature model followed by one of full size. The "bureau du roi" is a large cylinder desk elaborately inlaid in marquetry of woods, and decorated with a wonderful and ornate series of mounts consisting of mouldings, plaques, vases and statuettes of gilt bronze cast and chased. These bronzes are the work of Duplessis, Winant and Hervieux. The desk, which shows plainly the transition between the Louis Quinze and Louis Seize styles, is as remarkable for the boldness of its conception as for the magnificent finish of its details. Its lines are large, flowing and harmonious, and although it is no longer exactly as it left the hands of its makers (Oeben died before it was finished) the alterations that have been made have hardly interfered with the general effect. For the head of the king for whom it was made that of Minerva in a helmet was substituted under his successor. The ciphers of Louis XV. have been removed and replaced by Sèvres plaques, and even the key which bore the king's initial crowned with laurels and palm leaves, with his portrait on the one side, and the fleur de lys on the other, has been interfered with by an austere republicanism. Yet no tampering with details can spoil the monumental nobility of this great conception. (J. P. B.)

DESLONGCHAMPS, JACQUES AMAND EUDES (1794-1867), French naturalist and palaeontologist, was born at Caen in Normandy on the 17th of January 1794. His parents, though poor, contrived to give him a good education, and he studied medicine in his native town to such good effect that in 1812 he was appointed assistant-surgeon in the navy, and in 1815 surgeon assistant major to the military hospital of Caen. Soon afterwards he proceeded to Paris to qualify for the degree of doctor of surgery, and there the researches and teachings of Cuvier attracted his attention to subjects of natural history and palaeontology. In 1822 he was elected surgeon to the board of relief at Caen, and while he never ceased to devote his energies to the duties of this post, he sought relaxation in geological studies. Soon he discovered remains of *Telesaurus* in one of the Caen quarries, and he became an ardent palaeontologist. He was one of the founders of the museum of natural history at Caen, and acted as honorary curator; he was likewise one of the founders of the *Société linnéenne de Normandie* (1823), to the transactions of which society he communicated papers on *Telesaurus*, *Poecilopleuron* (*Megalosaurus*), on Jurassic mollusca and brachiopoda. In 1825 he became professor of zoology to the faculty of sciences, and in 1847, dean. He died on the 17th of January 1867.

His son EUGÈNE EUDES-DESLONGCHAMPS (1830-1889), French

palaeontologist, was born in 1830. He succeeded his father about the year 1856 as professor of zoology at the faculty of sciences at Caen, and in 1861 he became also professor of geology and dean. After the death of his father in 1867, he devoted himself to the completion of a memoir on the Telesaurians: the joint labours being embodied in his *Prodrome des Téléosauriens du Calvados*. To the Société Linnéenne de Normandie he contributed memoirs on Jurassic brachiopods, on the geology of the department of La Manche (1856), of Calvados (1856-1863), on the *Terrain callovien* (1859), on *Nouvelle-Calédonie* (1864), and *Études sur les étages jurassiques inférieurs de la Normandie* (1864). His work *Le Jura normand* was issued in 1877-1878 (incomplete). He died at Château Matthieu, Calvados, on the 21st of December 1889.

DESMASEAUX, PIERRE (1673-1745); French writer, was born at Saillat, probably in 1673. His father, a minister of the reformed church, had to leave France on the revocation of the edict of Nantes, and took refuge in Geneva, where Pierre was educated. Bayle gave him an introduction to the 3rd Lord Shaftesbury, with whom, in 1699, he came to England, where he engaged in literary work. He remained in close touch with the religious refugees in England and Holland, and constantly in correspondence with the leading continental savants and writers, who were in the habit of employing him to conduct such business as they might have in England. In 1720 he was elected a fellow of the Royal Society. Among his works are *Vie de St Evremont* (1711), *Vie de Boileau-Despreaux* (1712), *Vie de Bayle* (1730). He also took an active part in preparing the *Bibliothèque raisonnée des ouvrages de l'Europe* (1728-1753), and the *Bibliothèque britannique* (1733-1747), and edited a selection of St Evremont's writings (1706). Part of Desmaseaux's correspondence is preserved in the British Museum, and other letters are in the royal library at Copenhagen. He died on the 11th of July 1745.

DESMAREST, NICOLAS (1725-1815), French geologist, was born at Soulaïnes, in the department of Aube, on the 16th of September 1725. Of humble parentage, he was educated at the college of the Oratorians of Troyes and Paris. Taking full advantage of the instruction he received, he was able to support himself by teaching, and to continue his studies independently. Buffon's *Theory of the Earth* interested him, and in 1753 he successfully competed for a prize by writing an essay on the ancient connexion between England and France. This attracted much attention, and ultimately led to his being employed in studying and reporting on manufactures in different countries, and in 1788 to his appointment as inspector-general of the manufactures of France. He utilized his journeys, travelling on foot, so as to add to his knowledge of the earth's structure. In 1763 he made observations in Auvergne, recognizing that the pyramatic basalts were old lava streams, comparing them with the columns of the Giant's Causeway in Ireland, and referring them to the operations of extinct volcanoes. It was not, however, till 1774 that he published an essay on the subject, accompanied by a geological map, having meanwhile on several occasions traversed the district. He then pointed out the succession of volcanic outbursts and the changes the rocks had undergone through weathering and erosion. As remarked by Sir A. Geikie, the doctrine of the origin of valleys by the erosive action of the streams which flow through them was first clearly taught by Desmarest. An enlarged and improved edition of his map of the volcanic region of Auvergne was published after his death, in 1811, by his son ANSELME GAËTAN DESMAREST (1784-1838), who was distinguished as a zoologist, and author of memoirs on recent fossil crustacea. He died in Paris on the 20th of September 1815.

See *The Founders of Geology*, by Sir A. Geikie (1897), pp. 48-78. (H. B. Wo.)

DESMARETS (or DESMARETZ), JEAN, SIEUR DE SAINT-SURIN (1595-1676), French dramatist and miscellaneous writer, was born in Paris in 1595. When he was about thirty he was introduced to Richelieu, and became one of the band of writers who carried out the cardinal's literary ideas. Desmarets's own contribution was to novel-writing, and the success of his romance *Amour* in 1631 led to his formal admission to the circle that met

at the house of Valentine Conrart and later developed into the Académie Française. Desmarets was its first chancellor. It was at Richelieu's request that he began to write for the theatre. In this kind he produced a comedy long regarded as a masterpiece, *Les Visionnaires* (1637); a prose-tragedy, *Érigone* (1638); and *Scipion* (1639), a tragedy in verse. His success led to official preferment, and he was made *conseiller du roi*, *contrôleur-général de l'extraordinaire des guerres*, and secretary-general of the fleet of the Levant. His long epic *Cléon* (1657) is noteworthy because Desmarets rejected the traditional pagan background, and maintained that Christian imagery should supplant it. With this standpoint he contributed several works in defence of the moderns in the famous quarrel between the Ancients and Moderns. In his later years Desmarets devoted himself chiefly to producing a quantity of religious poems, of which the best-known is perhaps his verse translation of the *Office de la Vierge* (1645). He was a violent opponent of the Jansenists, against whom he wrote a *Réponse à l'insolente apologie de Port-Royal* . . . (1666). He died in Paris on the 28th of October 1676.

See also H. Rigault, *Histoire de la querelle des anciens et des modernes* (1856), pp. 80-103.

DESMARETS, NICOLAS, SIEUR DE MAILLEBOIS (1648-1721), French statesman, was born in Paris on the 10th of September 1648. His mother was the sister of J. B. Colbert, who took him into his offices as a clerk. He became councillor to the parlement in 1672, master of requests in 1674 and intendant of finances in 1678. In these last functions he had to treat with the financiers for the coinage of new silver pieces of four sous. After Colbert's death he was involved in the legal proceedings taken against those financiers who had manufactured coins of bad alloy. The prosecution, conducted by the members of the family of Le Tellier, rivals of the Colberts, presented no proof against Desmarets. Nevertheless he was stripped of his offices and exiled to his estates by the king, on the 23rd of December 1683. In March 1686 he was authorized to return to Paris, and again entered into relations with the controllers-general of finance, to whom he furnished for more than ten years remarkable memoirs on the economic situation in France. As early as 1687 he showed the necessity for radical reforms in the system of taxation, insisting on the ruin of the people and the excessive expenses of the king. By these memoirs he established his claim to a place among the great economists of the time, Vauban, Boisguilbert and the comte de Boulainvilliers. When in September 1699 Chamillart was named controller-general of finances, he took Desmarets for councillor; and when he created the two offices of directors of finances, he gave one to Desmarets (October 22, 1703). Henceforth Desmarets was veritable minister of finance. Louis XIV. had long conversations with him. Madame de Maintenon protected him. The economists Vauban and Boisguilbert exchanged long conversations with him. When Chamillart found his double functions too heavy, and retaining the ministry of war resigned that of finance in 1708, Desmarets succeeded him. The situation was exceedingly grave. The ordinary revenues of the year 1708 amounted to 81,977,007 livres, of which 57,833,233 livres had already been spent by anticipation, and the expenses to meet were 200,251,447 livres. In 1709 a famine reduced still more the returns from taxes. Yet Desmarets's reputation renewed the credit of the state, and financiers consented to advance money they had refused to the king. The emission of paper money, and a reform in the collection of taxes, enabled him to tide over the years 1709 and 1710. Then Desmarets decided upon an "extreme and violent remedy," to use his own expression,—an income tax. His "tenth" was based on Vauban's plan; but the privileged classes managed to avoid it, and it proved no better than other expedients. Nevertheless Louis XIV. managed to meet the most urgent expenses, and the deficit of 1715, about 350,000,000 livres, was much less than it would have been had it not been for Desmarets's reforms. The honourable peace which Louis was enabled to conclude at Utrecht with his enemies was certainly due to the resources which Desmarets procured for him.

After the death of Louis XIV. Desmarets was dismissed by the regent along with all the other ministers. He withdrew to

his estates. To justify his ministry he addressed to the regent a *Compte rendu*, which showed clearly the difficulties he had to meet. His enemies even, like Saint Simon, had to recognize his honesty and his talent. He was certainly, after Colbert, the greatest finance minister of Louis XIV.

See Forbonnais, *Recherches et considérations sur les finances de la France* (a vols., Basel, 1758); Montyon, *Particularités et observations sur les ministres des finances de la France* (Paris, 1812); De Boislaie, *Correspondance des contrôleurs-généraux des finances* (3 vols., Paris, 1873-1897); and the same author's "Desmarets et l'affaire des picques de quatre sols" in the appendix to the seventh volume of his edition of the *Mémoires de Saint-Simon*. (E. Es.)

DES MOINES, the capital and the largest city of Iowa, U.S.A., and the county-seat of Polk county, in the south central part of the state, at the confluence of the Raccoon with the Des Moines river. Pop. (1890) 59,093; (1900) 62,139, of whom 7946 were foreign-born, including 1907 from Sweden and 1432 from Germany; (1910 census) 86,368. Des Moines is served by the Chicago, Burlington & Quincy, the Chicago & North-Western, the Chicago Great Western, the Chicago, Milwaukee & St. Paul, the Chicago, Rock Island & Pacific, the Wabash, the Minneapolis & St. Louis, and the Des Moines, Iowa Falls & Northern railways; also by several interurban electric lines. The chief building in Des Moines is the State Capitol, erected at a cost of about \$3,000,000; other important buildings are the public library (containing, in 1908, 40,415 volumes), the court house, the post office, the Iowa State Historical building, a large auditorium and two hospitals. As a manufacturing centre the city has considerable importance. Among the leading products are those of the furnaces, foundries and machine shops, flour and grist mills, planing mills, creameries, bridge and iron works, publishing houses and a packing house; and brick, tile, pottery, patent medicines, furniture, caskets, tombstones, carriages, farm machinery, Portland cement, glue, gloves and hosiery. The value of the factory product in 1905 was \$15,084,958, an increase of 79.7% in five years. The city is in one of the most productive coal regions of the state, has a large jobbing trade, and is an important centre for the insurance business. The Iowa state fair is held here annually. In 1908 this city had a park system of 750 acres. Des Moines is the seat of Des Moines College, a Baptist institution, co-educational, founded in 1865 (enrollment, 1907-1908, 214); of Drake University (co-educational; founded in 1881 by the Disciples of Christ; non-sectarian), with colleges of liberal arts, law, medicine, dental surgery and of the Bible, a conservatory of music, and a normal school, in which are departments of oratory and commercial training, and having in 1907-1908 1764 students, of whom 520 were in the summer school only; of the Highland Park College, founded in 1890; of Grand View College (Danish Lutheran), founded in 1895; and of the Capital City commercial college (founded 1884). A new city charter, embodying what has become known as the "Des Moines Plan" of municipal government, was adopted in 1907. It centralizes power in a council of five (mayor and four councilmen), nominated at a non-partisan primary and voted for on a non-partisan ticket by the electors of the entire city, ward divisions having been abolished. Elections are biennial. Other city officers are chosen by the council, and city employees are selected by a civil service commission of three members, appointed by the council. The mayor is superintendent of the department of public affairs, and each of the other administrative departments (accounts and finances, public safety, streets and public improvements, and parks and public property) is under the charge of one of the councilmen. After petition signed by a number of voters not less than 25% of the number voting at the preceding municipal election, any member of the council may be removed by popular vote, to which all public franchises must be submitted, and by which the council may be compelled to pass any law or ordinance.

A fort called Fort Des Moines was established on the site of the city in 1843 to protect the rights of the Sacs and Foxes. In 1843 the site was opened to settlement by the whites; in 1851 Des Moines was incorporated as a town; in 1857 it was first chartered as a city, and, for the purpose of a more central location, the seat

of government was removed hither from Iowa City. A fort was re-established here by act of Congress in 1900 and named Fort Des Moines. It is occupied by a full regiment of cavalry. The name of the city was taken from that of the river, which in turn is supposed to represent a corruption by the French of the original Indian name, *Moingona*,—the French at first using the abbreviation "moine," and calling the river "la rivière des moines" and then, the name having become associated with the Trappist monks, changing it into "la rivière des moines."

DESMOND, GERALD FITZGERALD, 15TH EARL OF (d. 1583). Irish leader, was son of James, 14th earl, by his second wife More O'Carroll. His father had agreed in January 1541, as one of the terms of his submission to Henry VIII., to send young Gerald to be educated in England. At the accession of Edward VI. proposals to this effect were renewed; Gerald was to be the companion of the young king. Unfortunately for the subsequent peace of Munster these projects were not carried out. The Desmond estates were held by a doubtful title, and claims on them were made by the Butlers, the hereditary enemies of the Geraldines, the 9th earl of Ormonde having married Lady Joan Fitzgerald, daughter and heiress-general of the 11th earl of Desmond. On Ormonde's death she proposed to marry Gerald Fitzgerald, and eventually did so, after the death of her second husband, Sir Francis Bryan. The effect of this marriage was a temporary cessation of open hostility between the Desmonds and her son, Thomas Butler, 10th earl of Ormonde.

Gerald succeeded to the earldom in 1558; he was knighted by the lord deputy Sussex, and did homage at Waterford. He soon established close relations with his namesake Gerald Fitzgerald, 11th earl of Kildare (1525-1585), and with Shane O'Neill. In spite of an award made by Sussex in August 1560 regulating the matters in dispute between Ormonde and the Fitzgeralds, the Geraldine outlaws were still plundering their neighbours. Desmond neglected a summons to appear at Elizabeth's court for some time on the plea that he was at war with his uncle Maurice. When he did appear in London in May 1562 his insolent conduct before the privy council resulted in a short imprisonment in the Tower. He was detained in England until 1564, and soon after his return his wife's death set him free from such restraint as was provided by her Butler connexion. He now raided Thomond, and in Waterford he sought to enforce his feudal rights on Sir Maurice Fitzgerald of Decies, who invoked the help of Ormonde. The two nobles thereupon resorted to open war, fighting a battle at Affane on the Blackwater, where Desmond was defeated and taken prisoner. Ormonde and Desmond were bound over in London to keep the peace, being allowed to return early in 1566 to Ireland, where a royal commission was appointed to settle the matters in dispute between them. Desmond and his brother Sir John of Desmond were sent over to England, where they surrendered their lands to the queen after a short experience of the Tower. In the meanwhile Desmond's cousin, James Fitzmaurice Fitzgerald, caused himself to be acclaimed captain of Desmond in defiance of Sidney, and in the evident expectation of usurping the earldom. He sought to give the movement an ultra-Catholic character, with the idea of gaining foreign assistance, and allied himself with John Burke, son of the earl of Clanricarde, with Connor O'Brien, earl of Thomond, and even secured Ormonde's brother, Sir Edmund Butler, whom Sidney had offended. Piers and Edward Butler also joined the rebellion, but the appearance of Sidney and Ormonde in the south-west was rapidly followed by the submission of the Butlers. Most of the Geraldines were subjugated by Humphrey Gilbert, but Fitzmaurice remained in arms, and in 1571 Sir John Perrot undertook to reduce him. Perrot hunted him down, and at last on the 23rd of February 1573 he made formal submission at Kilmallock, lying prostrate on the floor of the church by way of proving his sincerity.

Against the advice of the queen's Irish counsellors Desmond was allowed to return to Ireland in 1573, the earl promising not to exercise palatinate jurisdiction in Kerry until his rights to it were proved. He was detained for six months in Dublin, but in November slipped through the hands of the government, and

within a very short time had reduced to a state of anarchy the province which Perrot thought to have pacified by his severities. Edward Fitzgerald, brother of the earl of Kildare, and lieutenant of the queen's pensioners in London, was sent to remonstrate with Desmond, but accomplished nothing. Desmond asserted that none but Brehon law should be observed between Geraldines; and Fitzmaurice seized Captain George Bouchier, one of Elizabeth's officers in the west. Essex met the earl near Waterford in July, and Bouchier was surrendered, but Desmond refused the other demands made in the queen's name. A document offering £500 for his head, and £1000 to any one who would take him alive, was drawn up but was vetoed by two members of the council. On the 18th of July 1574 the Geraldine chiefs signed the "Combination" promising to support the earl unconditionally; shortly afterwards Ormonde and the lord deputy, Sir William Fitzwilliam, marched on Munster, and put Desmond's garrison at Derrinlaur Castle to the sword. Desmond submitted at Cork on the 2nd of September, handing over his estates to trustees. Sir Henry Sidney visited Munster in 1575, and affairs seemed to promise an early restoration of order. But Fitzmaurice had fled to Brittany in company with other leading Geraldines, John Fitzgerald, seneschal of Imokilly, who had held Ballymartyr against Sidney in 1567, and Edmund Fitzgibbon, the son of the White Knight who had been attainted in 1571. He intrigued at the French and Spanish courts for a foreign invasion of Ireland, and at Rome met the adventurer Stucley, with whom he projected an expedition which was to make a nephew of Gregory XIII. king of Ireland. In 1579 he landed in Smerwick Bay, where he was joined later by some Spanish soldiers at the Fort del Ore. His ships were captured on the 27th of July and he himself was slain in a skirmish while on his way to Tipperary. Nicholas Sanders, the papal legate who had accompanied Fitzmaurice, worked on Desmond's weakness, and sought to draw him into open rebellion. Desmond had perhaps been restrained before by jealousy of Fitzmaurice; his indecisions ceased when on the 1st of November Sir William Pelham proclaimed him a traitor. The sack of Youghal and Kinsale by the Geraldines was speedily followed by the successes of Ormonde and Pelham acting in concert with Admiral Winter. In June 1581 Desmond had to take to the woods, but he maintained a considerable following for some time, which, however, in June 1583, when Ormonde set a price on his head, was reduced to four persons. Five months later, on the 11th of November, he was seized and murdered by a small party of soldiers. His brother Sir John de Desmond had been caught and killed in December 1581, and the seneschal of Imokilly had surrendered on the 14th of June 1583. After his submission the seneschal acted loyally, but his lands excited envy; he was arrested in 1587, and died in Dublin Castle two days later.

By his second marriage with Eleanor Butler, the 15th earl left two sons, the elder of whom, James, 16th earl (1570-1601), spent most of his life in prison. After an unsuccessful attempt in 1600-1601 to recover his inheritance he returned to England, where he died, the title becoming extinct.

See G. E. C(okayne). *Complete Peerage*; R. Bagwell, *Ireland under the Tudors* (1885-1890); *Annals of Ireland by the Four Masters* (ed. J. O'Donovan, 1851); and the article FITZGERALD.

DESMOND (*Des-Musko*), an ancient territorial division of Ireland, covering the eastern part of the modern Co. Kerry and the western part of Co. Cork. Its creation as a kingdom is placed in the year 248, when Oliol Olum, king of Munster, divided his territory between his two sons, giving Desmond to Eoghan, and Thomond or North Munster to Cormac. In 1320 Maurice Fitzthomas or Fitzgerald (d. 1356), lord of Decies and Desmond, was created 1st earl of Desmond by Edward III.; like other earls created about that time he ruled his territory as a palatinate, and his family acquired enormous powers and a large measure of independence. Meanwhile native kings continued to reign in a restricted territory until 1506. In 1583 came the attainder of Gerald Fitzgerald, 15th earl of Desmond (q.v.), and in 1586 an act of parliament declared the forfeiture of the Desmond estates to the crown. In 1571 a commission provided for the formation of

Desmond into a county, and it was regarded as such for a few years, but by the beginning of the 17th century it was joined to Co. Kerry.

In 1619 the title of earl of Desmond was conferred on Richard Preston, Lord Dingwall, at whose death in 1628 it again became extinct. It was then bestowed on George Feilding, second son of William, earl of Denbigh, who had held the reversion of the earldom from 1622. His son William Feilding succeeded as earl of Denbigh in 1675, and thenceforward the title of Desmond was held in conjunction with that honour.

DESMOSCOLECIDÆ, a group of minute marine worm-like creatures. The body tapers towards each end and is marked by a number of well-defined ridges. These ridges resemble on a small scale those which surround the body of a *Poroccephalus* (Linguatulida), and like them have no segmental significance. Their number varies in the different species. The head bears four setae, and some of the ridges bear a pair either dorsally or ventrally. The setae are movable. Two pigment spots between the fourth and fifth ridges are regarded as eyes. The Desmoscolecida move by looping their bodies like geometrid caterpillars or leeches, as well as by creeping on their setae. The mouth is terminal, and leads into a muscular oesophagus which opens into a straight intestine terminating in an anus, which is said to be dorsal in position. The sexes are distinct. The testis is single, and its duct opens into the intestine and is provided with two chitinous spicules. The ovary is also single, opening independently and anterior to the anus. The nervous system is as yet unknown.

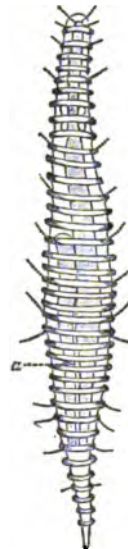

From Cambridge *Natural History*, vol. II, "Worms," &c., by permission of Macmillan & Co. Ltd.

Female *Desmoscoleles elongatus* Panceri, ventral view. σ , Ovary. (From Panceri.)

There are several species. *D. minutus* Clap. has been met with in the English Channel. Others are *D. nematoides* Greef, *D. adelphus* Greef, *D. chaetogaster* Greef, *D. elongatus* Panceri, *D. lanuginosa* Panceri. *Trichoderma oxyzacudatum* Greef is 0.3 mm. long, and is also a "ringed creature with long hair-like bristles." The male has two spicules, and there is some doubt as to whether it should be placed with the Desmoscolecida or with the Nematoda. With regard to the systematic position of the group, it certainly comes nearest—especially in the structure of its reproductive organs—to the Nematoda. We still, however, are very ignorant of the internal anatomy of these forms, and until we know more it is impossible to arrive at a very definite conclusion as to their position in the animal kingdom

See Panceri, *Atti Acc. Napoli*. vii. (1878); Greef, *Arch. Naturg.* 35 (1. (1869), p. 112. (A. E. S.)

DESMOULINS, LUCIE SIMPLICE CAMILLE BENOIST (1760-1794), French journalist and politician, who played an important part in the French Revolution, was born at Guise, in Picardy, on the 2nd of March 1760. His father was lieutenant-general of the *bailliage* of Guise, and through the efforts of a friend obtained a *bourse* for his son, who at the age of fourteen left home for Paris, and entered the college of Louis le Grand. In this school, in which Robespierre was also a bursar and a distinguished student, Camille Desmoulins laid the solid foundation of his learning. Destined by his father for the law, at the completion of his legal studies he was admitted an advocate of the parlement of Paris in 1785. His professional success was not great; his manner was violent, his appearance unattractive, and his speech impaired by a painful stammer. He indulged, however, his love for literature, was closely observant of public affairs, and thus gradually

prepared himself for the main duties of his life—those of a political *littérateur*.

In March 1789 Desmoulin began his political career. Having been nominated deputy from the *bailliage* of Guise, he appeared at Laon as one of the commissioners for the election of deputies to the States-General summoned by royal edict of January 24th. Camille heralded its meeting by his *Ode to the States-General*. It is, moreover, highly probable that he was the author of a radical pamphlet entitled *La Philosophie au peuple français*, published in 1783, the text of which is not known. His hopes of professional success were now scattered, and he was living in Paris in extreme poverty. He, however, shared to the full the excitement which attended the meeting of the States-General. As appears from his letters to his father, he watched with exultation the procession of deputies at Versailles, and with violent indignation the events of the latter part of June which followed the closing of the Salle des Menus to the deputies who had named themselves the National Assembly. It is further evident that Desmoulin was already sympathizing, not only with the enthusiasm, but also with the fury and cruelty, of the Parisian crowds.

The sudden dismissal of Necker by Louis XVI. was the event which brought Desmoulin to fame. On the 12th of July 1789 Camille, leaping upon a table outside one of the *cafés* in the garden of the Palais Royal, announced to the crowd the dismissal of their favourite. Losing, in his violent excitement, his stammer, he inflamed the passions of the mob by his burning words and his call "To arms!" "This dismissal," he said, "is the tocsin of the St Bartholomew of the patriots." Drawing, at last, two pistols from under his coat, he declared that he would not fall alive into the hands of the police who were watching his movements. He descended amid the embraces of the crowd, and his cry "To arms!" resounded on all sides. This scene was the beginning of the actual events of the Revolution. Following Desmoulin the crowd surged through Paris, procuring arms by force; and on the 13th it was partly organized as the Parisian militia which was afterwards to be the National Guard. On the 14th the Bastille was taken.

Desmoulin may be said to have begun on the following day that public literary career which lasted till his death. In May and June 1789 he had written *La France libre*, which, to his chagrin, his publisher refused to print. The taking of the Bastille, however, and the events by which it was preceded, were a sign that the times had changed; and on the 18th of July Desmoulin's work was issued. Considerably in advance of public opinion, it already pronounced in favour of a republic. By its erudite, brilliant and courageous examination of the rights of king, of nobles, of clergy and of people, it attained a wide and sudden popularity; it secured for the author the friendship and protection of Mirabeau, and the studied abuse of numerous royalist pamphleteers. Shortly afterwards, with his vanity and love of popularity inflamed, he pandered to the passions of the lower orders by the publication of his *Discours de la lanterne aux Parisiens* which, with an almost fiendish reference to the excesses of the mob, he headed by a quotation from St John, *Qui male agit odit lucem*. Camille was dubbed "Procureur-général de la lanterne."

In November 1789 Desmoulin began his career as a journalist by the issue of the first number of a weekly publication, *Les Révolutions de France et de Brabant*. The title of the publication changed after the 73rd number. It ceased to appear at the end of July 1791.¹

Success attended the *Révolutions* from its first to its last number, Camille was everywhere famous, and his poverty was relieved. These numbers are valuable as an exhibition not so much of events as of the feelings of the Parisian people; they are adorned, moreover, by the erudition, the wit and the genius of the author, but they are disfigured, not only by the most biting personalities and the defence and even advocacy of the excesses of the mob, but by the entire absence of the forgiveness and pity for which the writer was afterwards so eloquently to plead.

¹ In April 1792 Desmoulin founded with Stanislas Fréron a new journal, *La Trièune des patriotes*, but only four numbers appeared.

Desmoulin was powerfully swayed by the influence of more vigorous minds; and for some time before the death of Mirabeau, in April 1791, he had begun to be led by Danton, with whom he remained associated during the rest of his life. In July 1791 Camille appeared before the municipality of Paris as head of a deputation of petitioners for the deposition of the king. In that month, however, such a request was dangerous, there was excitement in the city over the presentation of the petition, and the private attacks to which Desmoulin had often been subject were now followed by a warrant for the arrest of himself and Danton. Danton left Paris for a little, Desmoulin, however, remained there, appearing occasionally at the Jacobin club. Upon the failure of this attempt of his opponents, Desmoulin published a pamphlet, *Jean Pierre Brissot démasqué*, which abounded in the most violent personalities. This pamphlet, which had its origin in a petty squabble, was followed in 1793 by a *Fragment de l'histoire secrète de la Révolution*, in which the party of the Gironde, and specially Brissot, were most mercilessly attacked. Desmoulin took an active part on the 10th of August and became secretary to Danton, when the latter became minister of justice. On the 8th of September he was elected one of the deputies for Paris to the National Convention, where, however, he was not successful as an orator. He was of the party of the "Mountain," and voted for the abolition of royalty and the death of the king. With Robespierre he was now more than ever associated, and the *Histoire des Brissolins*, the fragment above alluded to, was inspired by the arch-revolutionist. The success of the *brochure*, so terrible as to send the leaders of the Gironde to the guillotine, alarmed Danton and the author. Yet the rôle of Desmoulin during the Convention was of but secondary importance.

In December 1793 was issued the first number of the *Vieux Cordelier*, which was at first directed against the Hébertists and approved of by Robespierre, but which soon formulated Danton's idea of a committee of clemency. Then Robespierre turned against Desmoulin and took advantage of the popular indignation roused against the Hébertists to send them to death. The time had come, however, when Saint Just and he were to turn their attention not only to *les enragés*, but to *les indulgens*—the powerful faction of the Dantonists. On the 7th of January 1794 Robespierre, who on a former occasion had defended Camille when in danger at the hands of the National Convention, in addressing the Jacobin club counselled not the expulsion of Desmoulin, but the burning of certain numbers of the *Vieux Cordelier*. Camille sharply replied that he would answer with Rousseau,—“burning is not answering,” and a bitter quarrel thereupon ensued. By the end of March not only were Hébert and the leaders of the extreme party guillotined, but their opponents, Danton, Desmoulin and the best of the moderates, were arrested. On the 31st the warrant of arrest was signed and executed, and on the 3rd, 4th and 5th of April the trial took place before the Revolutionary Tribunal. It was a scene of terror not only to the accused but to judges and to jury. The retorts of the prisoners were notable. Camille on being asked his age, replied, "I am thirty-three, the age of the *sans-culotte* Jesus, a critical age for every patriot." This was false, he was thirty-four.² The accused were prevented from defending themselves; a decree of the Convention denied them the right of speech. Armed with this and the false report of a spy, who charged the wife of Desmoulin with conspiring for the escape of her husband and the ruin of the republic, Fouquier-Tinville by threats and entreaties obtained from the jury a sentence of death. It was passed in absence of the accused, and their execution was appointed for the same day.

Since his arrest the courage of Camille had miserably failed. He had exhibited in the numbers of the *Vieux Cordelier* almost a disregard of the death which he must have known hovered over him. He had with consummate ability exposed the terrors of

² This is borne out by the register of his birth and baptism, and by words in his last letter to his wife,—“I die at thirty-four.” The dates (1762–1794) given in so many biographies of Desmoulin are certainly inaccurate.

the Revolution, and had adorned his pages with illustrations from Tacitus, the force of which the commonest reader could feel. In his 1st number, the seventh, which his publisher refused to print, he had dared to attack even Robespierre, but at his trial it was found that he was devoid of physical courage. He had to be torn from his seat ere he was removed to prison, and as he sat next to Danton in the tumbrel which conveyed them to the guillotine, the calmness of the great leader failed to impress him. In his violence, bound as he was, he tore his clothes into shreds, and his bare shoulders and breast were exposed to the gaze of the surging crowd. Of the fifteen guillotined together, including among them Marie Jean Héralut de Séchelles, François Joseph Westermann and Pierre Philippeaux, Desmoulin died third; Danton, the greatest, died last.

On the 20th of December 1790 Camille had married Lucile Duplessis, and among the witnesses of the ceremony are observed the names of Brissot, Pétion and Robespierre. The only child of the marriage, Horace Camille, was born on the 6th of July 1792. Two days afterwards Desmoulin brought it into notice by appearing with it before the municipality of Paris to demand "the formal statement of the civil estate of his son." The boy was afterwards pensioned by the French government, and died in Haiti in 1825. Lucile, Desmoulin's accomplished and affectionate wife, was, a few days after her husband, and on a false charge, condemned to the guillotine. She astonished all onlookers by the calmness with which she braved death (April 13, 1794).

See J. Claretie, *Œuvres de Camille Desmoulin avec une étude biographique* . . . &c. (Paris, 1874), and *Camille Desmoulin, Lucile Desmoulin, étude sur les Dantonistes* (Paris, 1875; Eng. trans., London, 1876); F. A. Aulard, *Les Orateurs de la Législative et de la Convention* (Paris, 1905, 2nd ed.); G. Lenôtre, "La Maison de Camille Desmoulin" (*Le Temps*, March 25, 1899).

DESNOYERS, JULES PIERRE FRANÇOIS STANISLAS (1800-1857), French geologist and archaeologist, was born at Nogent-le-Rotrou, in the department of Eure-et-Loir, on the 8th of October 1800. Becoming interested in geology at an early age, he was one of the founders of the Société Géologique de France in 1830. In 1834 he was appointed librarian of the Museum of Natural History in Paris. His contributions to geological science comprise memoirs on the Jurassic, Cretaceous and Tertiary Strata of the Paris Basin and of Northern France, and other papers relating to the antiquity of man, and to the question of his co-existence with extinct mammalia. His separate books were *Sur la Craie et sur les terrains tertiaires du Cotentin* (1825), *Recherches géologiques et historiques sur les cavernes* (1845). He died in 1857.

DESOR, PIERRE JEAN ÉDOUARD (1811-1882), Swiss geologist, was born at Friedrichsdorf, near Frankfort-on-Main, on the 13th of February 1811. Associated in early years with Deshayes he studied palaeontology and glacial phenomena, and in company with J. D. Forbes ascended the Jungfrau in 1841. He afterwards became professor of geology in the academy at Neuchâtel, continued his studies on the structure of glaciers, but gave special attention to the study of Jurassic Echinoderms. He also investigated the old lake-habitations of Switzerland, and made important observations on the physical features of the Sahara. Having inherited considerable property he retired to Combe Varin in Val Travers. He died at Nizza on the 33rd of February 1882. His chief publications were: *Synopsis des fossiles jurassiques* (1858), *Aus Sahara* (1865), *Der Gebirgsbau der Alpen* (1865), *Die Pfahlbauten des Neuenburger Sees* (1866), *Geologie helvétique* (2 vols., 1868-1873, with P. de Loriol).

DE SOTO, a city of Jefferson county, Missouri, U.S.A., on Indian Creek, 42 m. S.S.W. of St. Louis. Pop. (1890) 3060; (1900) 5611 (1337 being foreign-born and 364 negroes); (1910) 4721. It is served by the St. Louis, Iron Mountain & Southern railway, which has extensive repair shops here. About 2½ m. from De Soto is the Robert mineral spring. In De Soto are Mount St Clement's Church (Roman Catholic, 1900), a theological seminary of the Congregation of the Most Holy Redeemer under the charge of the Oblate Fathers, and a Young Men's Christian Association building. De Soto is in a good agricultural and fruit-growing

region, which produces Indian corn, apples, plums, pears and small fruit. Lead and zinc are mined in the vicinity and shipped from the city in considerable quantities; and among the city's manufactures are shoes, flour and agricultural implements. The municipality owns the water-works, the water supply of which is furnished by artesian wells. De Soto was laid out in 1855 and was incorporated in 1869.

DESPARD, EDWARD MARCUS (1751-1803), Irish conspirator, was born in Queen's Co., Ireland, in 1751. In 1766 he entered the British navy, was promoted lieutenant in 1772, and stationed at Jamaica, where he soon proved himself to have considerable engineering talent. He served in the West Indies with credit, being promoted captain after the San Juan expedition (1779), then made governor of the Mosquito Shore and the Bay of Honduras, and in 1782 commander of a successful expedition against the Spanish possessions on the Black river. In 1784 he took over the administration of Yucatan. Upon frivolous charges he was suspended by Lord Grenville, and recalled to England. From 1790 to 1792 these charges were held over him, and when dismissed no compensation was forthcoming. His complaints caused him to be arrested in 1798, and with a short interval he remained in gaol until 1800. By that time Despard was desperate, and engaged in a plot to seize the Tower of London and Bank of England and assassinate George III. The whole idea was patently preposterous, but Despard was arrested, tried before a special commission, found guilty of high treason, and, with six of his fellow-conspirators, sentenced in 1803 to be hanged, drawn and quartered. These were the last men to be so sentenced in England. Despard was executed on the 21st of February 1803.

His eldest brother, **JOHN DESPARD** (1745-1820), had a long and distinguished career in the British army; gazetted an ensign in 1760, he was promoted through the various intermediate grades and became general in 1814. His most active service was in the American War of Independence, during which he was twice made prisoner.

DESPENSER, HUGH LE (d. 1265), chief justiciar of England, first plays an important part in 1258, when he was prominent on the baronial side in the Mad Parliament of Oxford. In 1260 the barons chose him to succeed Hugh Bigod as justiciar, and in 1263 the king was further compelled to put the Tower of London in his hands. On the outbreak of civil war he joined the party of Simon de Montfort, earl of Leicester, and led the Londoners when they sacked the manor-house of Isleworth, belonging to Richard, earl of Cornwall, king of the Romans. Having fought at Lewes (1264) he was made governor of six castles after the battle, and was then appointed one of the four arbitrators to mediate between Simon de Montfort and Gilbert de Clare, earl of Gloucester. He was summoned to Simon de Montfort's parliament in 1264, and acted as justiciar throughout the earl's dictatorship. Despensier was killed at Evesham in August 1265.

See C. Bémont, *Simon de Montfort* (Paris, 1884); T. F. Tout in *Owens College Historical Essays*, pp. 76 ff. (Manchester, 1902).

DESPENSER, HUGH LE (1262-1326), English courtier, was a son of the English justiciar who died at Evesham. He fought for Edward I. in Wales, France and Scotland, and in 1295 was summoned to parliament as a baron. Ten years later he was sent by the king to Pope Clement V. to secure Edward's release from the oaths he had taken to observe the charters in 1297. Almost alone Hugh spoke out for Edward II.'s favourite, Piers Gaveston, in 1308; but after Gaveston's death in 1312 he himself became the king's chief adviser, holding power and influence until Edward's defeat at Bannockburn in 1314. Then, hated by the barons, and especially by Earl Thomas of Lancaster, as a deserter from their party, he was driven from the council, but was quickly restored to favour and loaded with lands and honours, being made earl of Winchester in 1322. Before this time Hugh's son, the younger Hugh le Despenser, had become associated with his father, and having been appointed the king's chamberlain was enjoying a still larger share of the royal favour. About 1306 this baron had married Eleanor (d. 1337), one of the sisters and heiresses of Gilbert de Clare, earl of Gloucester, who was slain at

Bannockburn, and after a division of the immense Clare lands had been made in 1317 violent quarrels broke out between the Despensers and the husbands of the other heiresses, Roger of Amory and Hugh of Audley. Intertwoven with this dispute was another between the younger Despenser and the Mowbrays, who were supported by Humphrey Bohun, earl of Hereford, about some lands in Glamorganshire. Fighting having begun in Wales and on the Welsh borders, the English barons showed themselves decidedly hostile to the Despensers, and in 1321 Edward II. was obliged to consent to their banishment. While the elder Hugh left England the younger one remained; soon the king persuaded the clergy to annul the sentence against them, and father and son were again at court. They fought against the rebellious barons at Boroughbridge, and after Lancaster's death in 1322 they were practically responsible for the government of the country, which they attempted to rule in a moderate and constitutional fashion. But their next enemy, Queen Isabella, was more formidable, or more fortunate, than Lancaster. Returning to England after a sojourn in France in 1326 the queen directed her arms against her husband's favourites. The elder Despenser was seized at Bristol, where he was hanged on the 27th of October 1326, and the younger was taken with the king at Llantrisant and hanged at Hereford on the 24th of November following. The attainder against the Despensers was reversed in 1398. The intense hatred with which the barons regarded the Despensers was due to the enormous wealth which had passed into their hands, and to the arrogance and rapacity of the younger Hugh.

The younger Despenser left two sons, Hugh (1308-1349), and Edward, who was killed at Vannes in 1342.

The latter's son EDWARD LE DESPENSER (d. 1375) fought at the battle of Poitiers, and then in Italy for Pope Urban V.; he was a patron of Froissart, who calls him *le grand sire Despensier*. His son, THOMAS LE DESPENSER (1373-1400), the husband of Constance (d. 1416), daughter of Edmund of Langley, duke of York, supported Richard II. against Thomas of Woodstock, duke of Gloucester, and the other lords appellant in 1397, when he himself was created earl of Gloucester, but he deserted the king in 1399. Then, degraded from his earldom for participating in Gloucester's death, Despenser joined the conspiracy against Henry IV., but he was seized and was executed by a mob at Bristol in January 1400.

The elder Edward le Despenser left another son, HENRY (c. 1341-1406), who became bishop of Norwich in 1370. In early life Henry had been a soldier, and when the peasants revolted in 1381 he took readily to the field, defeated the insurgents at North Walsham, and suppressed the rising in Norfolk with some severity. More famous, however, was the militant bishop's enterprise on behalf of Pope Urban VI., who in 1382 employed him to lead a crusade in Flanders against the supporters of the anti-pope Clement VII. He was very successful in capturing towns until he came before Ypres, where he was checked, his humiliation being completed when his army was defeated by the French and decimated by a pestilence. Having returned to England the bishop was impeached in parliament and was deprived of his lands; Richard II., however, stood by him, and he soon regained an influential place in the royal council, and was employed to defend his country on the seas. Almost alone among his peers Henry remained true to Richard in 1399; he was then imprisoned, but was quickly released and reconciled with the new king, Henry IV. He died on the 23rd of August 1406. Despenser was an active enemy of the Lollards, whose leader, John Wycliffe, had fiercely denounced his crusade in Flanders.

The barony of Despenser, called out of abeyance in 1604, was held by the Fanes, earls of Westmorland, from 1626 to 1781; by the notorious Sir Francis Dashwood from 1763 to 1781; and by the Stapletons from 1788 to 1891. In 1891 it was inherited, through his mother, by the 7th Viscount Falmouth.

DES PÉRIERS, BONAVENTURE (c. 1500-1544), French author, was born of a noble family at Arnay-le-duc in Burgundy at the end of the 15th century. The circumstances of his education are uncertain, but he became a good classical scholar, and

was attached to various noble houses in the capacity of tutor. In 1533 or 1534 Des Périers visited Lyons, then the most enlightened town of France, and a refuge for many liberal scholars who might elsewhere have had to suffer for their opinions. He gave some assistance to Robert Olivetan and Lefèvre d'Étaples in the preparation of the vernacular version of the Old Testament, and to Étienne Dolet in the *Commentarii lingue latinæ*. In 1536 he put himself under the protection of Marguerite d'Angoulême, queen of Navarre, who made him her *valet-de-chambre*. He acted as the queen's secretary, and transcribed the *Heptameron* for her. It is probable that his duties extended beyond those of a mere copyist, and some writers have gone so far as to say that the *Heptameron* was his work. The free discussions permitted at Marguerite's court encouraged a licence of thought as displeasing to the Calvinists as to the Catholics. This free inquiry became scepticism in Bonaventure's *Cymbalum Mundi* . . . (1537), and the queen of Navarre thought it prudent to disavow the author, though she continued to help him privately until 1541. The book consisted of four dialogues in imitation of Lucian. Its allegorical form did not conceal its real meaning, and, when it was printed by Morin, probably early in 1538, the Sorbonne secured the suppression of the edition before it was offered for sale. The dedication provides a key to the author's intention: *Thomas du Clovier (or Clesier) à son ami Pierre Tryocan* was recognized by 19th-century editors to be an anagram for *Thomas l'Incrédulé à son ami Pierre Croyant*. The book was reprinted in Paris in the same year. It made many bitter enemies for the author. Henri Estienne called it *détestable*, and Étienne Pasquier said it deserved to be thrown into the fire with its author if he were still living. Des Périers prudently left Paris, and after some wanderings settled at Lyons, where he lived in poverty, until in 1544 he put an end to his existence by falling on his sword. In 1544 his collected works were printed at Lyons. The volume, *Recueil des œuvres de feu Bonaventure des Périers*, included his poems, which are of small merit, the *Traité des quatre vertus cardinales après Sénèque*, and a translation of the *Lysis* of Plato. In 1558 appeared at Lyons the collection of stories and fables entitled the *Nouvelles récréations et joyeux devis*. It is on this work that the claim put forward for Des Périers as one of the early masters of French prose rests. Some of the tales are attributed to the editors, Nicholas Denisot and Jacques Pelletier, but their share is certainly limited to the later ones. The book leaves something to be desired on the score of morality, but the stories never lack point and are models of simple, direct narration in the vigorous and picturesque French of the 16th century.

His *Œuvres françaises* were published by Louis Lacour (Paris, 2 vols., 1856). See also the preface to the *Cymbalum Mundi* (ed. F. Franck, 1874); A. Chenevierre, *Bonaventure Despériers, sa vie, ses poésies* (1885); and P. Toldo, *Contributo allo studio della novella francese del XV. e XVI. secolo* (Rome, 1895).

DESORTES, PHILIPPE (1546-1606), French poet, was born at Chartres in 1546. As secretary to the bishop of Le Puy he visited Italy, where he gained a knowledge of Italian poetry afterwards turned to good account. On his return to France he attached himself to the duke of Anjou, and followed him to Warsaw on his election as king of Poland. Nine months in Poland satisfied the civilized Desportes, but in 1574 his patron became king of France as Henry III. He showered favours on the poet, who received, in reward for the skill with which he wrote occasional poems at the royal request, the abbey of Tiron and four other valuable benefices. A good example of the light and dainty verse in which Desportes excelled is furnished by the well-known *villanelle* with the refrain "Qui premier s'en repentira," which was on the lips of Henry, duke of Guise, just before his tragic death. Desportes was above all an imitator. He imitated Petrarch, Ariosto, Sannazaro, and still more closely the minor Italian poets, and in 1604 a number of his plagiarisms were exposed in the *Rencontres des Muses de France et d'Italie*. As a sonneteer he showed much grace and sweetness, and English poets borrowed freely from him. In his old age Desportes acknowledged his ecclesiastical preferment by a translation of

the Psalms remembered chiefly for the brutal *mot* of Malherbe: "Votre potage vaut mieux que vos psaumes." Desportes died on the 5th of October 1606. He had published in 1573 an edition of his works including *Diane, Les Amours d'Hippolyte, Élégies, Bergeries, Œuvres chrétiennes, &c.*

An edition of his *Œuvres*, by Alfred Michiels, appeared in 1858.

DESPOT (Gr. *δеспότης*, lord or master; the origin of the first part of the Gr. word is unknown, the second part is cognate with *κύριος*, husband, Lat. *potens*, powerful), in Greek usage the master of a household, hence the ruler of slaves. It was also used by the Greeks of their gods, as was the feminine form *δеспοτῶνα*. It was, however, principally applied by the Greeks to the absolute monarchs of the eastern empires with which they came in contact; and it is in this sense that the word, like its equivalent "tyrant," is in current usage for an absolute sovereign whose rule is not restricted by any constitution. In the Roman empire of the East "despot" was early used as a title of honour or address of the emperor, and was given by Alexius I. (1081-1118) to the sons, brothers and sons-in-law of the emperor (Gibbon, *Decline and Fall*, ed. Bury, vol. vi. 80). It does not seem that the title was confined to the heir-apparent by Alexius II. (see Selden, *Titles of Honour*, part ii. chap. i. s. vi.). Later still it was adopted by the vassal princes of the empire. This gave rise to the name "despotats" as applied to these tributary states, which survived the break-up of the empire in the independent "despotats" of Epirus, Cyprus, Trebizond, &c. Under Ottoman rule the title was preserved by the despots of Servia and of the Morea, &c. The early use of the term as a title of address for ecclesiastical dignitaries survives in its use in the Greek Church as the formal mode of addressing a bishop..

DES PRÉS, JOSQUIN (c. 1445-1521), also called DEPRÉS or DESPREZ, and by a latinized form of his name, JODOCUS PRÆTENSIS or A PRATO, French musical composer, was born, probably in Condé in the Hennegau, about 1445. He was a pupil of Ockenheim, and himself one of the most learned musicians of his time. In spite of his great fame, the accounts of his life are vague and the dates contradictory. Fétis contributed greatly towards elucidating the doubtful points in his *Biographie musicale*. In his early youth Josquin seems to have been a member of the choir of the collegiate church at St Quentin; when his voice changed he went (about 1455) to Ockenheim to take lessons in counterpoint; afterwards he again lived at his birth-place for some years, till Pope Sixtus IV. invited him to Rome to teach his art to the musicians of Italy, where musical knowledge at that time was at a low ebb. In Rome Des Prés lived till the death of his protector (1484), and it was there that many of his works were written. His reputation grew rapidly, and he was considered by his contemporaries to be the greatest master of his age. Luther, who was a good judge, is credited with the saying that "other musicians do with notes what they can, Josquin what he likes." The composer's journey to Rome marks in a manner the transference of the art from its Gallo-Belgian birthplace to Italy, which for the next two centuries remained the centre of the musical world. To Des Prés and his pupils Arcadelt, Mouton and others, much that is characteristic in modern music owes its rise, particularly in their influence upon Italian developments under Palestrina. After leaving Rome Des Prés went for a time to Ferrara, where the duke Hercules I. offered him a home; but before long he accepted an invitation of King Louis XII. of France to become the chief singer of the royal chapel. According to another account, he was for a time at least in the service of the emperor Maximilian I. The date of his death has by some writers been placed as early as 1501. But this is sufficiently disproved by the fact of one of his finest compositions, *A Dirge (Déploration) for Five Voices*, being written to commemorate the death of his master Ockenheim, which took place after 1512. The real date of Josquin's decease has since been settled as the 27th of August 1521. He was at that time a canon of the cathedral of Condé (see Victor Delant's *Œuvres de Flandre*, No. 118).

The most complete list of his compositions—consisting of masses, motets, psalms and other pieces of sacred music—will be found in

Fétis. The largest collection of his MS. works, containing no less than twenty masses, is in the possession of the papal chapel in Rome. In his lifetime Des Prés was honoured as an eminent composer, and the musicians of the 16th century are loud in his praise. During the 17th and 18th centuries his value was ignored, nor does his work appear in the collections of Martini and Paolucci. Burney was the first to recover him from oblivion, and Forkel continued the task of rehabilitation. Ambros furnishes the most exhaustive account of his achievements. An admirable account of Josquin's art, from the rare point of view of a modern critic who knows how to allow for modern difficulties, will be found in the article "Josquin," in Grove's *Dictionary of Music and Musicians*, new ed. vol. II. The *Répertoire des chanteurs de St Gervais* contains an excellent modern edition of Josquin's *Miserere*.

DESPRÉS, SUZANNE (1875-), French actress, was born at Verdun, and trained at the Paris Conservatoire, where in 1897 she obtained the first prize for comedy, and the second for tragedy. She then became associated with, and subsequently married, Aurelien Lugné-Poë (b. 1870), the actor-manager, who had founded a new school of modern drama, *L'Œuvre*, and she had a brilliant success in several plays produced by him. In succeeding years she played at the Gymnase and at the Porte Saint-Martin, and in 1902 made her début at the Comédie Française, appearing in *Phèdre* and other important parts.

DESRUES, ANTOINE FRANÇOIS (1744-1777), French poisoner, was born at Chartres in 1744, of humble parents. He went to Paris to seek his fortune, and started in business as a grocer. He was known as a man of great piety and devotion, and his business was reputed to be a flourishing one, but when, in 1773, he gave up his shop, his finances, owing to personal extravagance, were in a deplorable condition. Nevertheless he entered into negotiations with a Madame de la Mothe for the purchase from her of a country estate, and, when the time came for the payment of the purchase money, invited her to stay with him in Paris pending the transfer. While she was still his guest, he poisoned first her and then her son, a youth of sixteen. Then, having forged a receipt for the purchase money, he endeavoured to obtain possession of the property. But by this time the disappearance of Madame de la Mothe and her son had aroused suspicion. Desrues was arrested, the bodies of his victims were discovered, and the crime was brought home to him. He was tried, found guilty and condemned to be torn asunder alive and burned. The sentence was carried out (1777). Desrues repeating hypocritical protestations of his innocence to the last. The whole affair created a great sensation at the time, and as late as 1828 a dramatic version of it was performed in Paris.

DESSAIX, JOSEPH MARIE, COUNT (1764-1834), French general, was born at Thonon in Savoy on the 24th of September 1764. He studied medicine, took his degree at Turin, and then went to Paris, where in 1789 he joined the National Guard. In 1791 he tried without success to raise an *Émeute* in Savoy, in 1792 he organized the "Legion of the Allobroges," and in the following years he served at the siege of Toulon, in the Army of the Eastern Pyrenees, and in the Army of Italy. He was captured at Rivoli, but was soon exchanged. In the spring of 1798 Dessaix was elected a member of the Council of Five Hundred. He was one of the few in that body who opposed the *coup d'État* of the 18th Brumaire (November 9, 1799). In 1803 he was promoted general of brigade, and soon afterwards commander of the Legion of Honour. He distinguished himself greatly at the battle of Wagram (1809), and was about this time promoted general of division and named grand officer of the Legion of Honour, and in 1810 was made a count. He took part in the expedition to Russia, and was twice wounded. For several months he was commandant of Berlin, and afterwards delivered the department of Mont Blanc from the Austrians. After the first restoration Dessaix held a command under the Bourbons. He nevertheless joined Napoleon in the Hundred Days, and in 1816 he was imprisoned for five months. The rest of his life was spent in retirement. He died on the 26th of October 1834.

See *Le Général Dessaix, sa vie politique et militaire*, by his nephew Joseph Dessaix (Paris, 1879).

DESSAU, a town of Germany, capital of the duchy of Anhalt, on the left bank of the Mulde, 2 m. from its confluence with the

Elbe, 67 m. S.W. from Berlin and at the junction of lines to Cöthen and Zerbst. Pop. (1905) 55,134. Apart from the old quarter lying on the Mulde, the town is well built, is surrounded by pleasant gardens and contains many handsome streets and spacious squares. Among the latter is the Grosse Markt with a statue of Prince Leopold I. of Anhalt-Dessau, "the old Dessauer." Of the six churches, the Schlosskirche, adorned with paintings by Lucas Cranach, in one of which ("The Last Supper") are portraits of several reformers, is the most interesting. The ducal palace, standing in extensive grounds, contains a collection of historical curiosities and a gallery of pictures, which includes works by Cimabue, Lippi, Rubens, Titian and Van Dyck. Among other buildings are the town hall (built 1809-1900), the palace of the hereditary prince, the theatre, the administration offices, the law courts, the Amalienstift, with a picture gallery, several high-grade schools, a library of 30,000 volumes and an excellently appointed hospital. There are monuments to the philosopher Moses Mendelssohn (born here in 1729), to the poet Wilhelm Müller, father of Professor Max Müller, also a native of the place, to the emperor William I., and an obelisk commemorating the war of 1870-71. The industries of Dessau include the production of sugar, which is the chief manufacture, woollen, linen and cotton goods, carpets, hats, leather, tobacco and musical instruments. There is also a considerable trade in corn and garden produce. In the environs are the ducal villas of Georgium and Luisium, the gardens of which, as well as those of the neighbouring town of Wörlitz, are much admired.

Dessau was probably founded by Albert the Bear; it had attained civic rights as early as 1213. It first began to grow into importance at the close of the 17th century, in consequence of the religious emancipation of the Jews in 1686, and of the Lutherans in 1697.

See Wüding, *Chronik der Stadt Dessau* (Dessau, 1876).

DESSEWFFY, AUREL, COUNT (1808-1842), Hungarian journalist and politician, eldest son of Count József Dessewffy and Eleonora Sztaray, was born at Nagy-Mihály, county Zemplén, Hungary. Carefully educated at his father's house, he was accustomed to the best society of his day. While still a child he could declaim most of the *Iliad* in Greek without a book, and read and quoted Tacitus with enthusiasm. Under the noble influence of Ferenc Kazinczy he became acquainted with the chief masterpieces of European literature in their original tongues. He was particularly fond of the English, and one of his early idols was Jeremy Bentham. He regularly accompanied his father to the diets of which he was a member, followed the course of the debates, of which he kept a journal, and made the acquaintance of the great Széchenyi, who encouraged his aspirations. On leaving college, he entered the royal aulic chancellery, and in 1832 was appointed secretary of the royal stadtholder at Buda. The same year he turned his attention to politics and was regarded as one of the most promising young orators of the day, especially during the sessions of the diet of 1832-1836, when he had the courage to oppose Kossuth. At the Pressburg diet in 1840 Dessewffy was already the leading orator of the more enlightened and progressive Conservatives, but incurred great unpopularity for not going far enough, with the result that he was twice defeated at the polls. But his reputation in court circles was increasing; he was appointed a member of the committee for the reform of the criminal law in 1840; and, the same year with a letter of recommendation from Metternich in his pocket, visited England and France, Holland and Belgium, made the acquaintance of Thiers and Heine in Paris, and returned home with an immense and precious store of practical information. He at once proceeded to put fresh life into the despondent and irresolute Conservative party, and the Magyar aristocracy, by gallantly combating in the *Világ* the opinions of Kossuth's paper, the *Pesti Hírlap*. But the multiplicity of his labours was too much for his feeble physique, and he died on the 9th of February 1842, at the very time when his talents seemed most indispensable.

See *Aus den Papieren des Grafen Aurel Dessewffy* (Pest, 1843); *Memorial Wreath to Count Aurel Dessewffy* (Hung.), (Budapest, 1857); *Collected Works of Count Dessewffy, with a Biography* (Hung.), (Budapest, 1887).

DESSOIR, LUDWIG (1810-1874), German actor, whose name was originally Leopold Dessauer, was born on the 15th of December 1810 at Posen, the son of a Jewish tradesman. He made his first appearance on the stage there in 1824 in a small part. After some experience at the theatre in Posen and on tour, he was engaged at Leipzig from 1834 to 1836. Then he was attached to the municipal theatre of Breslau, and in 1837 appeared at Prague, Brünn, Vienna and Budapest, where he accepted an engagement which lasted until 1839. He succeeded Karl Devrient at Karlsruhe, and went in 1847 to Berlin, where he acted Othello and Hamlet with such extraordinary success that he received a permanent engagement at the Hof-theater. From 1849 to 1872, when he retired on a pension, he played 110 parts, frequently on tour, and in 1853 acting in London. He died on the 30th of December 1874 in Berlin. Dessoir was twice married; his first wife, Theresa, a popular actress (1810-1866), was separated from him a year after marriage; his second wife went mad on the death of her child. By his first wife Dessoir had one son, the actor Ferdinand Dessoir (1836-1892). In spite of certain physical disabilities Ludwig Dessoir's genius raised him to the first rank of actors, especially as interpreter of Shakespeare's characters. G. H. Lewes placed Dessoir's Othello above that of Kean, and the *Athenaeum* preferred him in this part to Brooks or Macready.

DESTOUCHES, PHILIPPE (1680-1754), French dramatist, whose real name was Néricault, was born at Tours in April 1680. When he was nineteen years of age he became secretary to M. de Puysieux, the French ambassador in Switzerland. In 1716 he was attached to the French embassy in London, where he remained for six years under the abbé Dubois. He contracted with a Lancashire lady, Dorothea Johnston, a marriage which was not avowed for some years. He drew a picture later of his own domestic circumstances in *Le Philosophe marié* (1726). On his return to France (1723) he was elected to the Academy, and in 1727 he acquired considerable estates, the possession of which conferred the privileges of nobility. He spent his later years at his château of Fortoiseau near Melun, dying on the 4th of July 1754. His early comedies were: *Le Curieux Impertinent* (1710), *L'Ingrat* (1712), *L'Irrésolu* (1713) and *Le Médisant* (1715). The best of these is *L'Irrésolu*, in which Dorante, after hesitating throughout the play between Julie and Cléimène, marries Julie, but concludes the play with the reflection:—

"J'aurais mieux fait, je crois, d'épouser Cléimène."

After eleven years of diplomatic service Destouches returned to the stage with the *Philosophe marié* (1727), followed in 1732 by his masterpiece *Le Glorieux*, a picture of the struggle then beginning between the old nobility and the wealthy *parvenus* who found their opportunity in the poverty of France. Destouches wished to revive the comedy of character as understood by Molière, but he thought it desirable that the moral should be directly expressed. This moralizing tendency spoils his later comedies. Among them may be mentioned: *Le Tambour nocturne* (1736), *La Force du naturel* (1750) and *Le Dissipateur* (1736).

His works were issued in collected form in 1755, 1757, 1811 and in a limited edition (6 vols.), 1822.

DESTRUCTORS. The name destructors is applied by English municipal engineers to furnaces, or combinations of furnaces, commonly called "garbage furnaces" in the United States, constructed for the purpose of disposing of burning of town refuse, which is a heterogeneous mass of material, including, besides general household and ash-bin refuse, small quantities of garden refuse, trade refuse, market refuse and often street sweepings. The mere disposal of this material is not, however, by any means the only consideration in dealing with it upon the destructor system. For many years past scientific experts, municipal engineers and public authorities have been directing careful attention to the utilization of refuse as fuel for steam production, and such progress in this direction has been made that in many towns its calorific value is now being utilized daily for motive-power purposes. On the other hand, that proper degree of caution which is obtained only by actual experience must be

A large main flue, which also forms the dust chamber, is placed underneath the furnace hearth. The Fryer furnace ordinarily burns from 4 to 6 tons of refuse per cell per 24 hours. It will be observed that the outlets for the products of combustion are placed at the back near the refuse feed opening, an arrangement which is imperfect in design, inasmuch as while a charge of refuse is burning upon the furnace bars the charge which is to follow lies on the dead hearth near the outlet flue. Here it undergoes drying and partial decomposition, giving off offensive empyreumatic vapours which pass into the flue without being exposed to sufficient heat to render them entirely

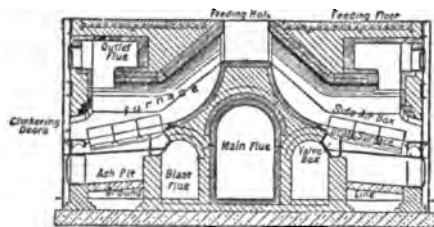

FIG. 2.—Horsfall's Improved Destructor.

inoffensive. The serious nuisances thus produced in some instances led to the introduction of a second furnace, or "cremator," patented by C. Jones of Ealing in 1885, which was placed in the main flue leading to the chimney-shaft, for the purpose of resolving the organic matters present in the vapour, but the greatly increased cost of burning due to this device led to its abandonment in many cases. This type of cell was largely used during the early period of the history of destructors, but has to a considerable extent given place to furnaces of more modern design.

A furnace¹ patented in 1891 by Mr Henry Whiley, superintendent of the scavenging department of the Manchester corporation, is automatic in its action and was designed primarily with a view to saving labour—the cells being fed, stoked and clinkered automatically. There is no drying hearth, and the refuse carts tip direct into a shoot or hopper at the back which conducts the material directly on to movable eccentric grate bars. These automatically traverse the material forward into the furnace, and finally push it against a flap-door which opens and allows it to fall out. This apparatus is adapted for dealing with screened rather than unscreened refuse, since it suffers from the objection that the motion of the bars tends to allow fine particles to drop through unburnt. Some difficulty has been experienced from the refuse sticking in the

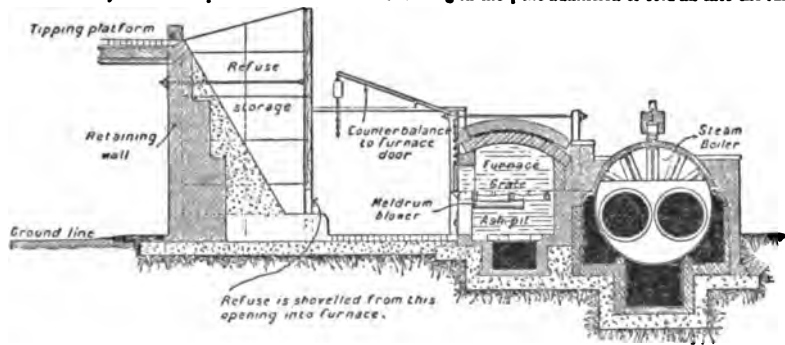

FIG. 3.—Meldrum's Destructor at Darwin.

hopper, and exception may also be taken to the continual flapping of the door when the clinker passes out, as cold air is thereby admitted into the furnace. As in the Fryer cell, the outlet for the products of combustion into the main flue is close to the point where the crude refuse is fed into the furnace, and the escape of unburnt vapours is thus facilitated. Forced draught is applied by means of a Roots blower. The Manchester corporation has 28 cells of this type in use, and the approximate amount of refuse burnt per cell per 24 hours is from 6 to 8 tons at a cost per ton for labour of 3-47 pence.

Horsfall's destructor² (fig. 2) is a high-temperature furnace of modern type which has been adopted largely in Great Britain and on the continent of Europe. In it some of the general features of the Fryer cell are retained, but the details differ considerably from those of the furnaces already described. Important

points in the design are the arrangement of the flues and flue outlets for the products of combustion, and the introduction of a blast duct through which air is forced into a closed ash-pit. The feeding-hopper is situated at the back of and above the furnace, while the flue opening for the emission of the gaseous products is placed at the front of the furnace over the dead plate; thus the gases distilled from the raw refuse are caused to pass on their way to the main flue over the hottest part of the furnace and through the flue opening in the red-hot reverberatory arch. The steam jet, which plays an important part in the Horsfall furnace, forces air into the closed ash-pit at a pressure of about $\frac{1}{2}$ to 1 in. of water, and in this way a temperature varying from 1500° to 2000° F., as tested by a thermo-electric pyrometer, is maintained in the main flue. In a battery of cells the gases from each are delivered into one main flue, so that a uniform temperature is maintained therein sufficiently high to prevent noxious vapours from reaching the chimney. The cells being charged and clinkered in rotation, when the fire in one is green, in the others it is at its hottest, and the products of combustion do not reach the boiler surfaces until after they have been mixed in the main flue. The cast iron boxes which are provided at the sides of the furnaces, and through which the blast air is conveyed on its way to the grate, prevent the adhesion of clinker to the side walls of the cells, and very materially preserve the brickwork, which otherwise becomes damaged by the tools used to remove the clinker. The wide clinkering doors are suspended by counterbalance weights and open vertically. The rate of working of these cells varies from 8 tons per cell per 24 hours at Oldham to 10 tons per cell at Bradford, where the furnaces are of a later type. The cost of labour in stoking and clinkering is about 6d. per ton of the refuse treated at Bradford, and 9d. per ton at Oldham, where the rate of wages is higher. Well-constructed and properly-worked plants of this type should give rise to no nuisance, and may be located in populous neighbourhoods without danger to the public health or comfort. Installations were put down at Fulham (1901), Hammerton Street, Bradford (1900), West Hartlepool (1904), and other places, and the surplus power generated is employed in the production of electric energy.

Warner's destructor,³ known as the "Perfectus," is in general arrangement, similar to Fryer's, but differs in being provided with special charging hoppers, dampers in flues, dust-catching arrangements, rocking grate bars and other improvements. Warner's. The refuse is tipped into feeding-hoppers, consisting of rectangular cast iron boxes over which plates are placed to prevent the escape of smoke and fumes. At the lower portion of the feeding-hopper is a flap-door working on an axis and controlled by an iron lever from the tipping platform. When refuse is to be fed into the furnace the lever is thrown over, the contents of the hopper drop on to the sloping firebrick hearth beneath, and the door is at once closed again. The door should be kept open as short a time as possible in order to prevent the admission of cold air into the furnace at the back end, since this

leads to the lowering of the temperature of the cells and main flue, and also to paper and other light refuse being carried into the flues and chimneys. The flues of each furnace are provided with dampers, which are closed during the process of clinkering in order to keep up the heat. The cells are each 5 ft. wide and 11 ft. deep, the rearmost portion consisting of a firebrick drying hearth, and the front of rocking grate bars upon which the combustion takes place. The crown of each cell is formed of a reverberatory firebrick arch having openings for the emission of the products of combustion. The flap dampers which are fitted to these openings are operated by horizontal spindles passing through the brickwork to the

front of the cell, where they are provided with levers or handles; thus each cell can be worked independently of the others. With the view of increasing the steam-raising capabilities of the furnace, forced draught is sometimes applied and a tubular boiler is placed close to the cells. The amount of refuse consumed varies from 5 tons to 8 tons per cell per 24 hours. At Hornsey, where 12 cells of this type are in use, the cost of labour for burning the refuse is 9½d. per ton.

The Meldrum "Simplex" destructor (fig. 3), a type of furnace which yields good steam-raising results, is in successful operation at Rochdale, Herford, Darwin, Nelson, Plumstead and Woolwich, at each of which towns the production of steam Meldrum's is an important consideration. Cells have also been laid down at Burton, Hunstanton, Blackburn and Shipley, and more recently at Burnley, Clackheaton, Lancaster, Nelson, Sheerness and Weymouth. In general arrangement the destructor differs considerably from

¹ Patent No. 8271 (1891).

² Patents No. 8999 (1887); No. 14,709 (1888); No. 22,531 (1891).

³ Patent No. 18,719 (1888).

those previously described. The grates are placed side by side without separation except by dead plates, but, in order to localize the forced draught, the ash-pit is divided into parts corresponding with the different grate areas. Each ash-pit is closed air-tight by a cast iron plate, and is provided with an air-tight door for removing the fine ash. Two patent Meldrum steam-jet blowers are provided for each furnace, supplying any required pressure of blast up to 6 in. water column, though that usually employed does not exceed 1½ in. The furnaces are designed for hand-feeding from the front, but hopper-feeding can be applied if desirable. The products of combustion either pass away from the back of each fire-grate into a common flue leading to boilers and the chimney-shaft, or are conveyed sideways over the various grates and a common fire-bridge to the boilers or chimney. The heat in the gases, after passing the boilers, is still further utilized to heat the air supplied to the furnaces, the gases being passed through an air heater or continuous regenerator consisting of a number of cast iron pipes from which the air is delivered through the Meldrum "blowers" at a temperature of about 300° F. That a high percentage (15 to 18%) of CO₂ is obtained in the furnaces proves a small excess of free oxygen, and no doubt explains the high fuel efficiency obtained by this type of destructor. High-pressure boilers of ample capacity are provided for the accumulation during periods of light load of a reserve of steam, the storage being obtained by utilizing the difference between the highest and lowest water-levels and the difference between the maximum and working steam-pressure. Patent locking fire-bars, to prevent lifting when clinkering, are used in the furnace and have a good life. At Rochdale the Meldrum furnaces consume from 53 lb to 66 lb of refuse per square foot of grate area per hour, as compared with 22.4 lb per square foot in a low-temperature destructor burning 6 tons per cell per 24 hours with a grate area of 25 sq. ft. The evaporative efficiency of the Rochdale furnaces varies from 1.39 lb to 1.87 lb of water (actual) per 1 lb of refuse burned, and an average steam-pressure of about 114 lb per square inch is maintained. The cost of labour and

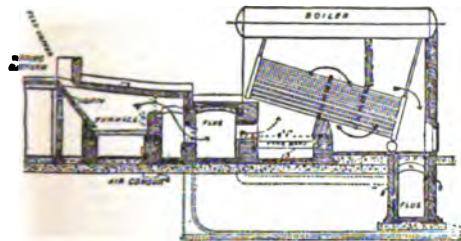

Fig. 4.—Beaman and Deas Destructor at Leyton.

supervision amounts to 10d. per ton of refuse dealt with. A Lancashire boiler (22 ft. by 6 ft. 6 in.) at the Sewage Outfall Works, Hereford, evaporates with refuse fuel 2980 lb of water per hour, equal to 149 indicated horse-power. About 54 lb of refuse are burnt per square foot of grate area per hour with an evaporation of 1.82 lb of water per pound of refuse.

The Beaman and Deas destructor¹ (fig. 4) has attracted much attention from public authorities, and successful installations are in operation at Warrington, Dewsbury, Leyton, Canterbury, Llandudno, Colne, Streatham, Rotherhithe, Wimbledon, Bolton and elsewhere. Its essential features include a level-fire grate with ordinary type bars, a high-temperature combustion chamber at the back of the cells, a closed ash-pit with forced draught, provision for the admission of a secondary air-supply at the fire-bridge, and a firebrick hearth sloping at an angle of about 12°. From the refuse storage platform the material is fed into a hopper mouth about 18 in. square, and slides down the firebrick hearth, supported by T-iron, to the grate bars, over which it is raked and spread with the assistance of long rods manipulated through clinkering doors placed at the sides of the cells. A secondary door in the rear of the cell facilitates the operation. The fire-bars, spaced only 3 in. apart, are of the ordinary stationary type. Vertically under the fire-bridge, is an air-conduit, from the top of which lead air blast pipes 12 in. in diameter discharging into a hermetically closed ash-pit under the grate area. The air is supplied from fans (Schiele's patent) at a pressure of from 14 to 2 in. of water, and is controlled by means of baffle valves worked by handles on either side of the furnace, conveniently placed for the attendant. The forced draught tends to keep the bars cool and lessen wear and tear. The flames from the charge drying on the hearth pass through the fire and over the red-hot fire-bridge, which is perforated longitudinally with air-passages connected with a small flue leading from a grated opening on the face of the brickwork outside; in this way an auxiliary supply of heated oxygen is fed into the combustion chamber. This

chamber, in which a temperature approaching 2000° F. is attained, is fitted with large iron doors, sliding with balance weights, which allow the introduction of infected articles, bad meat, &c., and also give access for the periodical removal of fine ash from the flues. The high temperatures attained are utilized by installing one boiler, preferably of the Babcock & Wilcox water-tube type, for each pair of cells, so that the gases, on their way from the combustion chamber to the main flue, pass three times between the boiler tubes. A secondary furnace is provided under the boiler for raising steam by coal, if required, when the cells are out of use. The grate area of each cell is 25 sq. ft., and the consumption varies from 16 up to 20 tons of refuse per cell per 24 hours. In a 24-hours' test made by the superintendent of the cleansing department, Leeds, at the Warrington installation, the quantity of water evaporated per pound of refuse was 1.14 lb, the average temperature in the combustion chamber 2000° F. by copper-wire test, and the average air pressure with forced draught 2½ in. (water-gauge). At Leyton, which has a population of over 100,000, an 8-cell plant of this type is successfully dealing with house refuse and filter press cakes of sewage sludge from the sewage disposal works adjoining, and even with material of this low calorific value the total steam-power produced is considerable. Each cell burns about 16 tons of the mixture in 24 hours and develops about 35 indicated horse-power continuously, at an average steam-pressure in the boilers of 105 lb. The cost of labour at Leyton for burning the mixed refuse is about 1s. 7d. per ton; at Llandudno, where four cells were laid down in connexion with the electric-light station in 1898, it is 1s. 3½d., and at Warrington 9½d. per ton of refuse consumed. Combustion is complete, and the destructor may be installed in populous districts without nuisance to the inhabitants. Further patents (Wilkie's improvements) have been obtained by Meldrum Brothers (Manchester) in connexion with this destructor.

The Heenan furnaces are in operation at Farnworth, Gloucester, Barrow-in-Furness, Northampton, Mansfield, Wakefield, Blackburn, Levenshulme, Kings Norton, Worthing, Birmingham and Heenan, other places, and are now dealing with over 1200 tons of refuse per day. The general arrangement of this destructor somewhat resembles that of the Meldrum type. The cells intercommunicate, and the mechanical mixture of the gases arising from the furnace grates of the various cells is sought by the introduction of a special design of reverberatory arch overlying the grates. The standard arrangement of this destructor embodies all modern arrangements for high-temperature refuse destruction and steam-power generation.

Destructors of the "Sterling" type, combined with electric-power generating stations, are installed at Hackney (1901), Bermondsey (1902) and Frederiksberg (1903)—the first-named plant being probably the most powerful combined destructor and electricity station yet erected. In these modern stations the recognized requirements of an up-to-date refuse-destruction plant have been well considered and good calorific results are also obtained.

In addition to the above-described destructors, other forms have been introduced from time to time, but adopted to a less degree; amongst these may be mentioned Baker's destructor, Willshear's, Hanson's Utilizer, Mason's Gasifier, the Bennett-Phythan, Cracknell's (Melbourne, Victoria), Coltman's (Loughborough), Willoughby's, and Healey's improved destructors. On the continent of Europe systems for the treatment of refuse have also been devised. Amongst these may be mentioned those of M. Defosse and M. Helouis. The former has endeavoured to burn the refuse in large quantities by using a forced draught and only washing the smoke.² Helouis has extended the operation by using the heat from the combustion of the refuse for drying and distilling the material which is brought gradually on to the grate.

Boulnois and Brodie's improved charging tank is a labour-saving apparatus consisting of a wrought iron truck, 5 ft. wide by 3 ft. deep, and of sufficient length to hold not less than 12 hours' Destructor supply for the two cells which it serves. The truck, which moves along a pair of rails across the top of the destructor, may be worked by one man. It is divided into compartments holding a charge of refuse in each, and is provided with a pair of doors in the bottom, opening downwards, which are supported by a series of small wheels running on a central rail. A special feeding opening in the reverberatory arch of the cell of the width of the truck, situated over the drying hearth, is formed by a firebrick arch fitted into a frame capable of being moved backwards and forwards by means of a lever. The charging truck, when empty, is brought under the tipping platform, and the carts tip directly into it. When one of the cells has to be fed, the truck is moved along, so that one of the divisions is immediately over the feeding opening, and the wheel holding up the bottom doors rests upon the central rail, which is continued over the movable covering arch. Then the movable arch is rolled back, the doors are released, and the contents are discharged into the cell, so that no handling of the refuse is required from tipping to feeding. This apparatus is in operation at Liverpool, Shoreditch, Cambridge and elsewhere.

Various forms of patent movable fire-bars have been employed

¹ Patents No. 15,598 (1893) and 23,712 (1893); also Beaman and Deas Sludge Furnace, Patent No. 13,029 (1894).

² *Compte Rendu des Travaux de la Société des Ingénieurs Civils de France*, folio 775 (June 1897).

in destructor furnaces. Among these may be mentioned Settle's,¹ Vicar's,² Riddle's rocking bars,³ Horsfall's self-feeding apparatus,⁴ and Healey's movable bars;⁵ but complicated movable arrangements are not to be recommended, and experience greatly favours the use of a simple stationary type of fire-bar.

A dust-catching apparatus has been designed and erected at Edinburgh, by the Horsfall Furnace Syndicate, in order to overcome difficulties in regard to the escape of flue dust, &c., from the destructor chimney. Externally, it appears a large circular block of brickwork, 18 ft. in diameter and 13 ft. 7 in. high, connected with the main flue, and situated between the destructor cells and the boiler. Internally it consists of a spiral flue traversing the entire circumference and winding upwards to the top of the chamber. There is an interior well or chamber 6 ft. diameter by 12 ft. high, having a domed top, and communicating with the outer spiral flue by four ports at the top of the chamber. Dust traps, baffle walls

Other accessory plant in use at most modern destructor stations includes machinery for the removal, crushing and various means of utilization of the residual clinker, stoking tools, air heaters or regenerators for the production of hot-air blast to the furnaces, superheaters and thermal storage arrangements for equalizing the output of power from the station during the 24-hours' day.

The general arrangement of a battery of refuse cells at a destructor station is illustrated by fig. 5. The cells are arranged either side by side, with a common main flue in the rear, or back to back with the main flue placed in the centre and leading to a tall chimney-shaft. The heated gases on leaving the cells pass through the combustion chamber into the main flue, and thence go forward to the boilers, where their heat is absorbed and utilized. Forced draught, or

Working
of de-
structors.

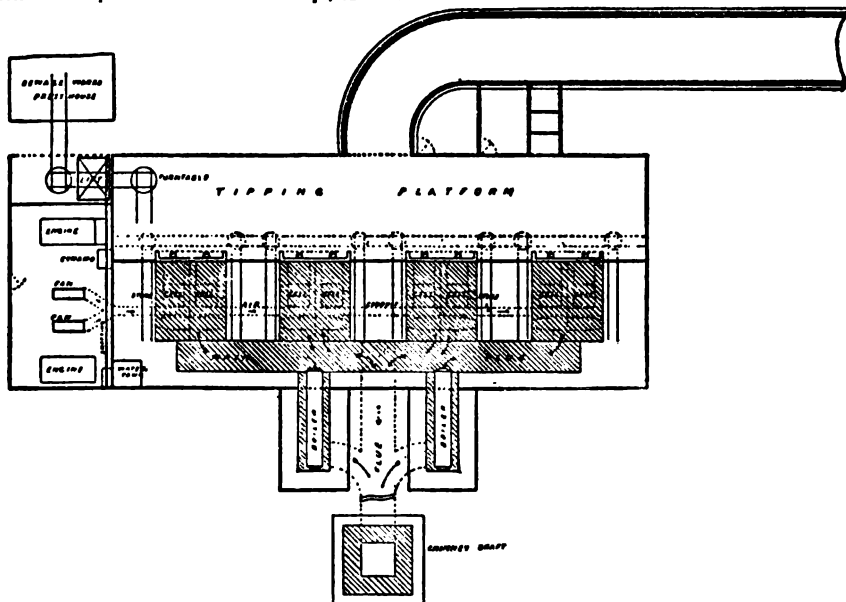

FIG. 5.—Leyton Destructor. Block Plan, showing general arrangement of the Works.

and cleaning doors are also provided for the retention and subsequent weekly removal of the flue dust. The apparatus forms a large reservoir of heat maintained at a steady temperature of from 1500° to 1800° F., and is useful in keeping up steam in the boiler at an equable pressure for a long period. It requires no attention, and has proved successful for its purpose.

Travelling cranes for transporting refuse and feeding cells are sometimes employed at destructor stations, as, for example, at Hamburg. Here the transportation of the refuse is effected by means of specially constructed water-tight iron wagons, containing detachable boxes provided with two double-flap doors at the top for loading, and one flap-door at the back for unloading. There are thirty-six furnaces of the Horsfall type placed in two ranks, each arranged in three blocks of six in the large furnace hall. An electric crane running above each rank lifts the boxes off the wagons and carries them to the feeding-hole of each well. Here the box is tipped up by an electric pulley and emptied on to the furnace platform. When the travelling crane is used, the carts (four-wheeled) bringing the refuse may be constructed so that the body of the carriage can be taken off the wheels, lifted up and tipped direct over the furnace as required, and returned again to its frame. The adoption of the travelling crane admits of the reduction in size of the main building, as less platform space for unloading refuse carts is required; the inclined roadway may also be dispensed with. Where a destructor site will not admit of an inclined roadway and platform, the refuse may be discharged from the collecting carts into a lift, and thence elevated into the feeding-bins.

In many cases, hot blast, is supplied from fans through a conduit commanding the whole of the cells. An inclined roadway, of as easy gradient as circumstances will admit, is provided for the conveyance of the refuse to the tipping platform, from which it is fed through feed-holes into the furnaces. In the installation of a destructor, the choice of suitable plant and the general design of the works must be largely dependent upon local requirements, and should be entrusted to an engineer experienced in these matters. The following primary considerations, however, may be enumerated as materially affecting the design of such works:—

(a) The plant must be simple, easily worked without stoppages, and without mechanical complications upon which stokers may lay the blame for bad results. (b) It must be strong, must withstand variations of temperature, must not be liable to get out of order, and should admit of being readily repaired. (c) It must be such as can be easily understood by stokers or firemen of average intelligence, so that the continuous working of the plant may not be disorganized by change of workmen. (d) A sufficiently high temperature must be attained in the cells to reduce the refuse to an entirely innocuous clinker, and all fumes or gases should pass either through an adjoining red-hot cell or through a chamber whose temperature is maintained by the ordinary working of the destructor itself at a degree sufficient to exclude the possibility of the escape of any unconsumed gases, vapours or particles. The temperature may vary between 1500° and 2000°. (e) The plant must be so worked that while some of the cells are being recharged, others are at a glowing red heat, in order that a high temperature may be uniformly maintained. (f) The design of the furnaces must admit of clinkering and recharging being easily and quickly performed, the furnace doors being open for a minimum of time so as to obviate the inrush of cold air to lower the temperature

¹ Patent No. 15,482 (1885).

² Patents No. 1955 (1867) and No. 378 (1879).

³ Patent No. 4896 (1861).

⁴ Patent No. 20,207 (1892).

⁵ Patents No. 18,398 (1892) and No. 12,990 (1892).

in main flue; &c. (g) The chimney draught must be assisted with forced draught from fans or steam jet to a pressure of 1½ in. to 2 in. under grates by water-gauge. (h) Where a destructor is required to work without risk of nuisance to the neighbouring inhabitants, its efficiency as a refuse destructor plant must be primarily kept in view in designing the works, steam-raising being regarded as a secondary consideration. Boilers should not be placed immediately over a furnace so as to present a large cooling surface, whereby the temperature of the gases is reduced before the organic matter has been thoroughly burned. (i) Where steam-power and a high fuel efficiency are desired a large percentage of CO₂ should be sought in the furnaces with as little excess of air as possible, and the fine gases should be utilized in heating the air-supply to the grates, and the feed-water to the boilers. (j) Ample boiler capacity and hot-water storage feed-tanks should be included in the design where steam-power is required.

As to the initial cost of the erection of refuse destructors, few trustworthy data can be given. The outlay necessarily depends, amongst other things, upon the difficulty of preparing the site, upon the nature of the foundations required, the height of the chimney-shaft, the length of the inclined or approach roadway, and the varying prices of labour and materials in different localities. As an example may be mentioned the case of Bristol, where, in 1892, the total cost of constructing a 16-cell Fryer destructor was £11,418, of which £909 was expended on foundations, and £1689 on the chimney-shaft; the cost of the destructor proper, buildings and approach road was therefore £6820, or about £426 per cell. The cost per ton of burning refuse in destructors depends mainly upon—(a) The price of labour in the locality, and the number of "shifts" or changes of workmen per day; (b) the type of furnace adopted; (c) the nature of the material to be consumed; (d) the interest on and repayment of capital outlay. The cost of burning ton for ton consumed, in high-temperature furnaces, including labour and repairs, is not greater than in slow-combustion destructors. The average cost of burning refuse at twenty-four different towns throughout England, exclusive of interest on the cost of the works, is 1s. 1½d. per ton burned; the minimum cost is 6d. per ton at Bradford, and the maximum cost 2s. 10d. per ton at Battersea. At Shoreditch the cost per ton for the year ending on the 25th of March 1899, including labour, supervision, stores, repairs, &c. (but exclusive of interest on cost of works), was 2s. 6½d. The quantity of refuse burned per cell per day of 24 hours varies from about 4 tons up to 30 tons. The ordinary low-temperature destructor, with 25 sq. ft. grate area, burns about 20 lb of refuse per square foot of grate area per hour, or between 5 and 6 tons per cell per 24 hours. The Meldrum destructor furnaces at Rochdale burn as much as 66 lb per square foot of grate area per hour, and the Beaman and Deas destructor at Llandudno 71·7 lb per square foot per hour. The amount, however, always depends materially on the care observed in stoking, the nature of the material, the frequency of removal of clinker, and on the question whether the whole of the refuse passed into the furnace is thoroughly cremated.

The amount of residue in the shape of clinker and fine ash varies from 22 to 37% of the bulk dealt with. From 25 to 30% is a very usual amount. At Shoreditch, where the refuse consists of about 8% of straw, paper, shavings, &c., the residue contains about 29% clinker, 2·7% fine ash, 5% flue dust, and 6% old tin, making a total residue of 32·8%. As the residuum amounts to from one-fourth to one-third of the total bulk of the refuse dealt with, it is a question of the utmost importance that some profitable, or at least inexpensive, means should be devised for its regular disposal. Among other purposes, it has been used for bottoming for macadamised roads, for the manufacture of concrete, for making paving slabs, for forming suburban footpaths or cinder footwalks, and for the manufacture of mortar. The last is a very general, and in many places profitable, mode of disposal. An entirely new outlet has also arisen for the disposal of good well-ventilated destructor clinker in connexion with the construction of bacteria beds for sewage disposal, and in many districts its value has, by this means, become greatly enhanced. Through defects in the design and management of many of the early destructors complaints of nuisance frequently arose, and these have, to some extent, brought destructor installations into disrepute. Although some of the older furnaces were decided offenders in this respect, that is by no means the case with the modern improved type of high-temperature furnace; and often, were it not for the great prominence in the landscape of a tall chimney-shaft, the existence of a refuse destructor in a neighbourhood would not be generally known to the inhabitants. A modern furnace, properly designed and worked, will give rise to no nuisance, and may be safely erected in the midst of a populous neighbourhood. To ensure the perfect cremation of the refuse and of the gases given off, forced draught is essential.

This is supplied either as air draught delivered from a rapidly revolving fan, or as steam blast, as in the Horsfall steam jet or the Meldrum blower. With a forced blast less air is required to obtain complete combustion than by chimney draught. The forced draught grate requires little more than the quantity theoretically necessary, while with chimney draught more than double the theoretical amount of air must be supplied. With forced draught, too, a much higher temperature is attained, and if it is properly worked, little or no cold air will enter the furnaces during raising operations. As far as possible a balance of pressure in the

cells during clinking should be maintained just sufficient to prevent an inrush of cold air through the flues. The forced draught pressure should not exceed 2 in. water-gauge. The efficiency of the combustion in the furnace is conveniently measured by the "Economometer," which registers continuously and automatically the proportion of CO₂ passing away in the waste gases; the higher the percentage of CO₂ the more efficient the furnace, provided there is no formation of CO, the presence of which would indicate incomplete combustion. The theoretical maximum of CO₂ for refuse burning is about 20%; and, by maintaining an even clean fire, by admitting secondary air over the fire, and by regulating the dampers or the air-pressure in the ash-pit, an amount approximating to this percentage may be attained in a well-designed furnace if properly worked. If the proportion of free oxygen (i.e. excess of air) is large, more air is passed through the furnace than is required for complete combustion, and the heating of this excess is clearly a waste of heat. The position of the econometer in testing should be as near the furnace as possible, as there may be considerable air leakage through the brickwork of the flues.

The air supply to modern furnaces is usually delivered hot, the inlet air being first passed through an air-heater the temperature of which is maintained by the waste gases in the main flue.

The modern high-temperature destructor, to render the refuse and gases perfectly innocuous and harmless, is worked at a temperature varying from 1250° to 2000° F., and the maintenance of such temperatures has very naturally suggested the possibility of utilizing this heat-energy for the production of steam-power. Experience shows that a considerable amount of energy may be derived from steam-raising destructor stations, amply justifying a reasonable increase of expenditure on plant and labour. The actual calorific value of the refuse material necessarily varies, but, as a general average, with suitably designed and properly managed plant, an evaporation of 1 lb of water per pound of refuse burned is a result which may be readily attained, and affords a basis of calculation which engineers may safely adopt in practice. Many destructor steam-raising plants, however, give considerably higher results, evaporations approaching 2 lb of water per pound of refuse being often met with under favourable conditions.

From actual experience it may be accepted, therefore, that the calorific value of unscreened house refuse varies from 1 to 2 lb of water evaporated per pound of refuse burned, the exact proportion depending upon the quality and condition of the material dealt with. Taking the evaporative power of coal at 10 lb of water per pound of coal, this gives for domestic house refuse a value of from 1/10 to 1/5 that of coal; or, with coal at 20s. per ton, refuse has a commercial value of from 2s. to 4s. per ton. In London the quantity of house refuse amounts to about 1½ million tons per annum, which is equivalent to from 4 cwt. to 5 cwt. per head per annum. If it is burned in furnaces giving an evaporation of 1 lb of water per pound of refuse, it would yield a total power annually of about 138 million brake horse-power, and equivalent cost of coal at 20s. per ton for this amount of power even when calculated upon the very low estimate of 2 lb¹ of coal per brake horse-power hour, works out at over £123,000. On the same basis, the refuse of a medium-sized town, with, say, a population of 70,000 yielding refuse at the rate of 5 cwt. per head per annum, would afford 112 indicated horse-power per ton burned, and the total indicated horse-power hours per annum would be

$$\frac{70,000 \times 5 \text{ cwt.} \times 112 = 1,960,000 \text{ I.H.P. hours annually,}}{20}$$

If this were applied to the production of electric energy, the electrical horse-power hours would be (with a dynamo efficiency of 90%)

$$\frac{1,960,000 \times 90}{100} = 1,764,000 \text{ E.H.P. hours per annum;}$$

and the watt-hours per annum at the central station would be

$$1,764,000 \times 746 = 1,315,944,000.$$

Allowing for a loss of 10% in distribution, this would give 1,184,349,600 watt-hours available in lamps, or with 8-candle-power lamps taking 30 watts of current per lamp, we should have

$$\frac{1,184,349,600 \text{ watt-hours}}{30 \text{ watts}} = 39,478,320 \text{ 8-c.p. lamp-hours per annum;}$$

$$\text{that is, } \frac{39,478,320}{70,000 \text{ population}} = 563 \text{ 8-c.p. lamp-hours per annum per head of population.}$$

Taking the loss due to the storage which would be necessary at 20% on three-quarters of the total or 15% upon the whole, there would be 478 8-c.p. lamp-hours per annum per head of the population: i.e. if the power developed from the refuse were fully utilized, it would supply electric light at the rate of one 8-c.p. lamp per head of the population for about 1½ hours for every night of the year.

In actual practice, when the electric energy is for the purposes of lighting only, difficulty has been experienced in fully utilizing the thermal energy from a destructor plant owing to the want of adequate means of storage either of the thermal or of the electric energy. A destructor station usually yields a fairly definite amount of thermal energy uniformly throughout the 24 hours, while the consumption of electric-lighting current is extremely

¹ With medium-sized steam plants, a consumption of 4 lb of coal per brake horse-power per hour is a very usual performance.

irregular, the maximum demand being about four times the mean demand. The period during which the demand exceeds the mean is comparatively short, and does not exceed about 6 hours out of the 24, while for a portion of the time the demand may not exceed 1/10th of the maximum. This difficulty, at first regarded as somewhat grave, is substantially minimized by the provision of ample boiler capacity, or by the introduction of feed thermal storage vessels in which hot feed-water may be stored during the hours of light load (say 18 out of the 24), so that at the time of maximum load the boiler may be filled directly from these vessels, which work at the same pressure and temperature as the boiler. Further, the difficulty above mentioned will disappear entirely at stations where there is a fair day load which practically ceases at about the hour when the illuminating load comes on, thus equalizing the demand upon both destructor and electric plant throughout the 24 hours. This arises in cases where current is consumed during the day for motors, fans, lifts, electric tramways, and other like purposes, and, as the employment of electric energy for these services is rapidly becoming general, no difficulty need be anticipated in the successful working of combined destructor and electric plants where these conditions prevail. The more uniform the electrical demand becomes, the more fully may the power from a destructor station be utilized.

In addition to combination with electric-lighting works, refuse destructors are now very commonly installed in conjunction with various other classes of power-using undertakings, including tramways, water-works, sewage-pumping, artificial slab-making and clinker-crushing works and others; and the increasingly large sums which are being yearly expended in combined undertakings of this character is perhaps the strongest evidence of the practical value of such combinations where these several classes of work must be carried on.

For further information on the subject, reference should be made to William H. Maxwell, *Removal and Disposal of Town Refuse, with an exhaustive treatment of Refuse Destructor Plants* (London, 1899), with a special Supplement embodying later results (London, 1905).

See also the *Proceedings of the Incorporated Association of Municipal and County Engineers*, vols. xiii. p. 216, xxii. p. 211, xxiv. p. 214 and xxv. p. 138; also the *Proceedings of the Institution of Civil Engineers*, vols. cxxii. p. 443, cxxiv. p. 469, cxxxi. p. 413, cxxxviii. p. 508, cxxxix. p. 434, cxxx. pp. 213 and 347, cxxxii. pp. 369 and 498, cxxxvii. p. 293 and cxxxix. p. 300. (W. H. M.A.)

DE TABLEY, JOHN BYRNE LEICESTER WARREN, 3RD BARON (1835-1895), English poet, eldest son of George Fleming Leicester (afterwards Warren), and Baron De Tabley, was born on the 26th of April 1835. He was educated at Eton and Christ Church, Oxford, where he took his degree in 1856 with second classes in classics and in law and modern history. In the autumn of 1858 he went to Turkey as unpaid attaché to Lord Stratford de Redcliffe, and two years later was called to the bar. He became an officer in the Cheshire Yeomanry, and unsuccessfully contested Mid-Cheshire in 1868 as a Liberal. After his father's second marriage in 1871 he removed to London, where he became a close friend of Tennyson for several years. From 1877 till his succession to the title in 1887 he was lost to his friends, assuming the life of a recluse. It was not till 1892 that he returned to London life, and enjoyed a sort of renaissance of reputation and friendship. During the later years of his life Lord De Tabley made many new friends, besides reopening old associations, and he almost seemed to be gathering around him a small literary company when his health broke, and he died on the 22nd of November 1895 at Ryde, in his sixty-first year. He was buried at Little Peover in Cheshire. Although his reputation will live almost exclusively as that of a poet, De Tabley was a man of many studious tastes. He was at one time an authority on numismatics; he wrote two novels; published *A Guide to the Study of Book Plates* (1880); and the fruit of his careful researches in botany was printed posthumously in his elaborate *Flora of Cheshire* (1899). Poetry, however, was his first and last passion, and to that he devoted the best energies of his life. De Tabley's first impulse towards poetry came from his friend George Fortescue, with whom he shared a close companionship during his Oxford days, and whom he lost, as Tennyson lost Hallam, within a few years of their taking their degrees. Fortescue was killed by falling from the mast of Lord Drogheda's yacht in November 1859, and this gloomy event plunged De Tabley into deep depression. Between 1859 and 1864 De Tabley issued four little volumes of pseudonymous verse (by G. F. Preston), in the production of which he had been greatly stimulated by the sympathy of Fortescue. Once more he assumed a pseudonym—his *Præterita* (1863) bearing the name of William Lancaster. In the next year he published *Elogues and Mono-*

dramas, followed in 1865 by *Studies in Verse*. These volumes all displayed technical grace and much natural beauty; but it was not till the publication of *Philoctetes* in 1866 that De Tabley met with any wide recognition. *Philoctetes* bore the initials "M.A.," which, to the author's dismay, were interpreted as meaning Matthew Arnold. He at once disclosed his identity, and received the congratulations of his friends, among whom were Tennyson, Browning and Gladstone. In 1867 he published *Orestes*, in 1870 *Rehearsals* and in 1873 *Searching the Net*. These last two bore his own name, John Leicester Warren. He was somewhat disappointed by their lukewarm reception, and when in 1876 *The Soldier of Fortune*, a drama on which he had bestowed much careful labour, proved a complete failure, he retired altogether from the literary arena. It was not until 1893 that he was persuaded to return, and the immediate success in that year of his *Poems, Dramatic and Lyrical*, encouraged him to publish a second series in 1895, the year of his death. The genuine interest with which these volumes were welcomed did much to lighten the last years of a somewhat sombre and solitary life. His posthumous poems were collected in 1902. The characteristics of De Tabley's poetry are pre-eminently magnificence of style, derived from close study of Milton, sonority, dignity, weight and colour. His passion for detail was both a strength and a weakness: it lent a loving fidelity to his description of natural objects, but it sometimes involved him in a loss of simple effect from over-elaboration of treatment. He was always a student of the classic poets, and drew much of his inspiration directly from them. He was a true and a whole-hearted artist, who, as a brother poet well said, "still climbed the clear cold altitudes of song." His ambition was always for the heights, a region naturally ice-bound at periods, but always a country of clear atmosphere and bright, vivid outlines.

See an excellent sketch by E. Gosse in his *Critical Kù-Kats* (1896). (A. WA.)

DETAILLE, JEAN BAPTISTE ÉDOUARD (1848-), French painter, was born in Paris on the 5th of October 1848. After working as a pupil of Meissonier's, he first exhibited, in the Salon of 1867, a picture representing "A Corner of Meissonier's Studio." Military life was from the first a principal attraction to the young painter, and he gained his reputation by depicting the scenes of a soldier's life with every detail truthfully rendered. He exhibited "A Halt" (1868); "Soldiers at rest, during the Manœuvres at the Camp of Saint Maur" (1869); "Engagement between Cossacks and the Imperial Guard, 1814" (1870). The war of 1870-71 furnished him with a series of subjects which gained him repeated successes. Among his more important pictures may be named "The Conquerors" (1872); "The Retreat" (1873); "The Charge of the 9th Regiment of Cuirassiers in the Village of Morsbronn, 6th August 1870" (1874); "The Marching Regiment, Paris, December 1874" (1875); "A Reconnaissance" (1876); "Hail to the Wounded!" (1877); "Bonaparte in Egypt" (1878); the "Inauguration of the New Opera House"—a water-colour; the "Defence of Champigny by Faron's Division" (1879). He also worked with Alphonse de Neuville on the panorama of Rezonville. In 1884 he exhibited at the Salon the "Evening at Rezonville," a panoramic study, and "The Dream" (1888), now in the Luxemburg. Detaille recorded other events in the military history of his country: the "Sortie of the Garrison of Huningue" (now in the Luxemburg), the "Vincendon Brigade," and "Bizerte," reminiscences of the expedition to Tunis. After a visit to Russia, Detaille exhibited "The Cossacks of the Ataman" and "The Hereditary Grand Duke at the Head of the Hussars of the Guard." Other important works are: "Victims to Duty," "The Prince of Wales and the Duke of Connaught" and "Pasteur's Funeral." In his picture of "Châlons, 9th October 1896," exhibited in the Salon, 1898, Detaille painted the emperor and empress of Russia at a review, with M. Félix Faure. Detaille became a member of the French Institute in 1898.

See Marius Vachon, *Detaille* (Paris, 1898); Frédéric Masson, *Edouard Detaille and his work* (Paris and London, 1891); J. Claretie, *Peintres et sculpteurs contemporains* (Paris, 1876); G. Goetschy, *Les Jeunes peintres militaires* (Paris, 1878).

DETAINDER (from *detain*, Lat. *detinere*), in law, the act of keeping a person against his will, or the wrongful keeping of a person's goods, or other real or personal property. A writ of detainer was a form for the beginning of a personal action against a person already lodged within the walls of a prison; it was superseded by the Judgment Act 1838.

DETERMINANT, in mathematics, a function which presents itself in the solution of a system of simple equations.

1. Considering the equations

$$\begin{aligned} ax + by + cz &= d, \\ a'x + b'y + c's &= d', \\ a''x + b''y + c''s &= d'', \end{aligned}$$

and proceeding to solve them by the so-called method of cross multiplication, we multiply the equations by factors selected in such a manner that upon adding the results the whole coefficient of y becomes $= 0$, and the whole coefficient of z becomes $= 0$; the factors in question are $b'c'' - b''c'$, $b''c - bc''$, $bc' - b'c$ (values which, as at once seen, have the desired property); we thus obtain an equation which contains on the left-hand side only a multiple of x , and on the right-hand side a constant term, the coefficient of x has the value

$$a(b'c'' - b''c') + a'(b''c - bc'') + a''(bc' - b'c).$$

and this function, represented in the form

$$\begin{vmatrix} a & b & c \\ a' & b' & c' \\ a'' & b'' & c'' \end{vmatrix}$$

is said to be a determinant; or, the number of elements being 3², it is called a determinant of the third order. It is to be noticed that the resulting equation is

$$\begin{vmatrix} a & b & c \\ a' & b' & c' \\ a'' & b'' & c'' \end{vmatrix} x = \begin{vmatrix} d & b & c \\ d' & b' & c' \\ d'' & b'' & c'' \end{vmatrix}$$

where the expression on the right-hand side is the like function with d, d', d'' in place of a, a', a'' respectively, and is of course also a determinant. Moreover, the functions $b'c'' - b''c'$, $b''c - bc''$, $bc' - b'c$ used in the process are themselves the determinants of the second order

$$\begin{vmatrix} b' & c' \\ b'' & c'' \end{vmatrix}, \begin{vmatrix} b'' & c'' \\ b & c \end{vmatrix}, \begin{vmatrix} b & c \\ b' & c' \end{vmatrix}$$

We have herein the suggestion of the rule for the derivation of the determinants of the orders 1, 2, 3, 4, &c., each from the preceding one, viz. we have

$$\begin{aligned} a &= a, \\ \begin{vmatrix} a & b \\ a' & b' \end{vmatrix} &= ab' - a'b, \\ \begin{vmatrix} a & b & c \\ a' & b' & c' \end{vmatrix} &= a(b'c'' - b''c') + a'(b''c - bc'') + a''(bc' - b'c), \\ \begin{vmatrix} a & b & c & d \\ a' & b' & c' & d' \\ a'' & b'' & c'' & d'' \\ a''' & b''' & c''' & d''' \end{vmatrix} &= a \begin{vmatrix} b' & c' & d' \\ b'' & c'' & d'' \\ b''' & c''' & d''' \end{vmatrix} - a' \begin{vmatrix} b & c & d \\ b'' & c'' & d'' \\ b''' & c''' & d''' \end{vmatrix} + a'' \begin{vmatrix} b & c & d \\ a' & b' & c' \\ a''' & b''' & c''' \end{vmatrix} - a''' \begin{vmatrix} b & c & d \\ a' & b' & c' \\ a'' & b'' & c'' \end{vmatrix} \end{aligned}$$

and so on, the terms being all + for a determinant of an odd order, but alternately + and - for a determinant of an even order. It is easy, by induction, to arrive at the general result:—

A determinant of the order n is the sum of the $1.2.3...n$ products which can be formed with n elements out of n^2 elements arranged in the form of a square, no two of the n elements being in the same line or in the same column, and each such product having the coefficient \pm unity.

The products in question may be obtained by permuting in every possible manner the columns (or the lines) of the determinant, and then taking for the factors the n elements in the dexter diagonal. And we thence derive the rule for the signs, viz. considering the primitive arrangement of the columns as positive, the arrangement obtained therefrom by a single interchange (inversion, or derangement) of two columns is regarded as negative, and so in general an arrangement is positive or negative according as it is derived from the primitive arrangement by an even or an odd number of interchanges. [This implies the theorem that a given arrangement can be derived from the primitive arrangement only by an odd number, or else only by an even

number of interchanges.—a theorem the verification of which may be easily obtained from the theorem (in fact a particular case of the general one), an arrangement can be derived from itself only by an even number of interchanges.] And this being so, each product has the sign belonging to the corresponding arrangement of the columns, in particular, a determinant contains with the sign + the product of the elements in its dexter diagonal. It is to be observed that the rule gives as many positive as negative arrangements, the number of each being $= \frac{1}{2} 1.2...n$.

The rule of signs may be expressed in a different form. Giving to the columns in the primitive arrangement the numbers 1, 2, 3, ... n, to obtain the sign belonging to any other arrangement we take, as often as a lower number succeeds a higher one, the sign -, and, compounding together all these minus signs, obtain the proper sign, + or - as the case may be.

Thus, for three columns, it appears by either rule that 123, 231, 312 are positive; 213, 321, 132 are negative, and the developed expression of the foregoing determinant of the third order is

$$= ab'c'' - ab''c' + a'b'c - a'bc'' - a''bc' - a''b'c.$$

3. It further appears that a determinant is a linear function¹ of the elements of each column thereof, and also a linear function of the elements of each line thereof, moreover, that the determinant retains the same value, only its sign being altered, when any two columns are interchanged, or when any two lines are interchanged; more generally, when the columns are permuted in any manner, or when the lines are permuted in any manner, the determinant retains its original value, with the sign + or - according as the new arrangement (considered as derived from the primitive arrangement) is positive or negative according to the foregoing rule of signs. It at once follows that, if two columns are identical, or if two lines are identical, the value of the determinant is $= 0$. It may be added, that if the lines are converted into columns, and the columns into lines, in such a way as to leave the dexter diagonal unaltered, the value of the determinant is unaltered; the determinant is in this case said to be *transposed*.

4. By what precedes it appears that there exists a function of the n^2 elements, linear as regards the terms of each column (or say for shortness, linear as to each column), and such that only the sign is altered when any two columns are interchanged; these properties completely determine the function, except as to a common factor which may multiply all the terms. In, to get rid of this arbitrary common factor, we assume that the product of the elements in the dexter diagonal has the coefficient + 1, we have a complete definition of the determinant, and it is interesting to show how from these properties, assumed for the definition of the determinant, it at once appears that the determinant is a function serving for the solution of a system of linear equations. Observe that the properties show at once that if any column is $= 0$ (that is, if the elements in the column are each $= 0$), then the determinant is $= 0$; and further, that if any two columns are identical, then the determinant is $= 0$.

5. Reverting to the system of linear equations written down at the beginning of this article, consider the determinant

$$\begin{vmatrix} ax + by + cz - d & b & c \\ a'x + b'y + c's - d' & b' & c' \\ a''x + b''y + c''s - d'' & b'' & c'' \end{vmatrix}$$

it appears that this is

$$= x \begin{vmatrix} a & b & c \\ a' & b' & c' \\ a'' & b'' & c'' \end{vmatrix} + y \begin{vmatrix} b & b & c \\ b' & b' & c' \\ b'' & b'' & c'' \end{vmatrix} + z \begin{vmatrix} b & b & c \\ b' & b' & c' \\ b'' & b'' & c'' \end{vmatrix} - d \begin{vmatrix} b & b & c \\ b' & b' & c' \\ b'' & b'' & c'' \end{vmatrix}$$

viz. the second and third terms each vanishing, it is

$$= x \begin{vmatrix} a & b & c \\ a' & b' & c' \\ a'' & b'' & c'' \end{vmatrix} - d \begin{vmatrix} b & b & c \\ b' & b' & c' \\ b'' & b'' & c'' \end{vmatrix}$$

But if the linear equations hold good, then the first column of the

¹ The expression, a linear function, is here used in its narrowest sense, a linear function without constant term; what is meant is that the determinant is in regard to the elements a, a', a'', \dots of any column or line thereof, a function of the form $Aa + A'a' + A''a'' + \dots$ without any term independent of a, a', a''

original determinant = 0, and therefore the determinant itself is = 0; that is, the linear equations give

$$x \begin{vmatrix} a & b & c \\ a' & b' & c' \\ a'' & b'' & c'' \end{vmatrix} - \begin{vmatrix} d & b & c \\ d' & b' & c' \\ d'' & b'' & c'' \end{vmatrix} = 0;$$

which is the result obtained above.

We might in a similar way find the values of y and z , but there is a more symmetrical process. Join to the original equations the new equation

$$ax + \beta y + \gamma z = \delta;$$

a like process shows that, the equations being satisfied, we have

$$\begin{vmatrix} a & \beta & \gamma & \delta \\ a' & b' & c' & d' \\ a'' & b'' & c'' & d'' \end{vmatrix} = 0;$$

or, as this may be written,

$$\begin{vmatrix} a & \beta & \gamma \\ a' & b' & c' \\ a'' & b'' & c'' \end{vmatrix} - \delta \begin{vmatrix} a & b & c \\ a' & b' & c' \\ a'' & b'' & c'' \end{vmatrix} = 0;$$

which, considering δ as standing herein for its value $ax + \beta y + \gamma z$, is a consequence of the original equations only: we have thus an expression for $ax + \beta y + \gamma z$, an arbitrary linear function of the unknown quantities x, y, z ; and by comparing the coefficients of a, β, γ on the two sides respectively, we have the values of x, y, z ; in fact, these quantities, each multiplied by

$$\begin{vmatrix} a & b & c \\ a' & b' & c' \\ a'' & b'' & c'' \end{vmatrix}$$

are in the first instance obtained in the forms

$$\begin{vmatrix} 1 & b & c & d \\ a' & b' & c' & d' \\ a'' & b'' & c'' & d'' \end{vmatrix}, \begin{vmatrix} a & 1 & c & d \\ a' & b' & c' & d' \\ a'' & b'' & c'' & d'' \end{vmatrix}, \begin{vmatrix} a & b & 1 & d \\ a' & b' & c' & d' \\ a'' & b'' & c'' & d'' \end{vmatrix};$$

but these are

$$- \begin{vmatrix} b & c & d \\ b' & c' & d' \\ b'' & c'' & d'' \end{vmatrix}, - \begin{vmatrix} c & d & a \\ c' & d' & a' \\ c'' & d'' & a'' \end{vmatrix}, \begin{vmatrix} d & a & b \\ d' & a' & b' \\ d'' & a'' & b'' \end{vmatrix},$$

or, what is the same thing,

$$- \begin{vmatrix} b & c & d \\ b' & c' & d' \\ b'' & c'' & d'' \end{vmatrix}, \begin{vmatrix} c & a & d \\ c' & a' & d' \\ c'' & a'' & d'' \end{vmatrix}, \begin{vmatrix} d & a & b \\ d' & a' & b' \\ d'' & a'' & b'' \end{vmatrix}$$

respectively.

6. *Multiplication of two Determinants of the same Order.*—The theorem is obtained very easily from the last preceding definition of a determinant. It is most simply expressed thus—

$$\begin{pmatrix} (a, b, c) \\ (a', b', c') \\ (a'', b'', c'') \end{pmatrix} \begin{pmatrix} (\alpha, \beta, \gamma) \\ (\alpha', \beta', \gamma') \\ (\alpha'', \beta'', \gamma'') \end{pmatrix} = \begin{vmatrix} a & b & c \\ a' & b' & c' \\ a'' & b'' & c'' \end{vmatrix} \begin{vmatrix} \alpha & \beta & \gamma \\ \alpha' & \beta' & \gamma' \\ \alpha'' & \beta'' & \gamma'' \end{vmatrix},$$

where the expression on the left side stands for a determinant, the terms of the first line being (a, b, c) (a, a', a''), that is, $ax + by + cz + ca'$, (a, b, c) (β, β', β''), that is, $a\beta + b\beta' + c\beta''$, (a, b, c) ($\gamma, \gamma', \gamma''$), that is $a\gamma + b\gamma' + c\gamma''$; and similarly the terms in the second and third lines are the like functions with (a', b', c') and (a'', b'', c'') respectively.

There is an apparently arbitrary transposition of lines and columns; the result would hold good if on the left-hand side we had written (a, β, γ) , (a', β', γ') , (a'', β'', γ'') , or what is the same thing, if on the right-hand side we had transposed the second determinant; and either of these changes would, it might be thought, increase the elegance of the form, but, for a reason which need not be explained,¹ the form actually adopted is the preferable one.

To indicate the method of proof, observe that the determinant on the left-hand side, *qua* linear function of its columns, may be

¹ The reason is the connexion with the corresponding theorem for the multiplication of two matrices.

broken up into a sum of $(3^3 = 27)$ determinants, each of which is either of some such form as

$$= a\beta\gamma' \begin{vmatrix} a & a & b \\ a' & a' & b' \\ a'' & a'' & b'' \end{vmatrix},$$

where the term $a\beta\gamma'$ is not a term of the $a\beta\gamma$ -determinant, and its coefficient (as a determinant with two identical columns) vanishes; or else it is of a form such as

$$= a\beta'\gamma' \begin{vmatrix} a & b & c \\ a' & b' & c' \\ a'' & b'' & c'' \end{vmatrix},$$

that is, every term which does not vanish contains as a factor the abc -determinant last written down; the sum of all other factors $= a\beta'\gamma'$ is the $a\beta\gamma$ -determinant of the formula; and the final result then is, that the determinant on the left-hand side is equal to the product on the right-hand side of the formula.

7. *Decomposition of a Determinant into complementary Determinants.*—Consider, for simplicity, a determinant of the fifth order, $s = 2 + 3$, and let the top two lines be

$$\begin{vmatrix} a & b & c & d & e \\ a' & b' & c' & d' & e' \end{vmatrix}$$

then, if we consider how these elements enter into the determinant, it is at once seen that they enter only through the determinants of the second order $\begin{vmatrix} a & b \\ a' & b' \end{vmatrix}$, &c., which can be formed by selecting any two columns at pleasure. Moreover, representing the remaining three lines by

$$\begin{vmatrix} a'' & b'' & c'' & d'' & e'' \\ a''' & b''' & c''' & d''' & e''' \\ a^{(4)} & b^{(4)} & c^{(4)} & d^{(4)} & e^{(4)} \end{vmatrix}$$

it is further seen that the factor which multiplies the determinant formed with any two columns of the first set is the determinant of the third order formed with the complementary three columns of the second set; and it thus appears that the determinant of the fifth order is a sum of all the products of the form

$$\begin{vmatrix} a & b \\ a' & b' \end{vmatrix} \begin{vmatrix} c'' & d'' & e'' \\ c''' & d''' & e''' \\ c^{(4)} & d^{(4)} & e^{(4)} \end{vmatrix}$$

the sign $=$ being in each case such that the sign of the term $= a\beta'c''d'''e^{(4)}$ obtained from the diagonal elements of the component determinants may be the actual sign of this term in the determinant of the fifth order; for the product written down the sign is obviously +.

Observe that for a determinant of the n -th order, taking the decomposition to be $1 + (n-1)$, we fall back upon the equations given at the commencement, in order to show the genesis of a determinant.

8. Any determinant $\begin{vmatrix} a & b \\ a' & b' \end{vmatrix}$ formed out of the elements of the original determinant, by selecting the lines and columns at pleasure, is termed a *minor* of the original determinant; and when the number of lines and columns, or order of the determinant, is $n-1$, then such determinant is called a *first minor*; the number of the first minors is $= n^2$, the first minors, in fact, corresponding to the several elements of the determinant—that is, the coefficient therein of any term whatever is the corresponding first minor. The first minors, each divided by the determinant itself, form a system of elements *inverse* to the elements of the determinant.

A determinant is *symmetrical* when every two elements symmetrically situated in regard to the dexter diagonal are equal to each other; if they are equal and opposite (that is, if the sum of the two elements be = 0), this relation not extending to the diagonal elements themselves, which remain arbitrary, then the determinant is *skew*; but if the relation does extend to the diagonal terms (that is, if these are each = 0), then the determinant is *skew symmetrical*; thus the determinants

$$\begin{vmatrix} a & h & g \\ h & b & f \\ g & f & c \end{vmatrix}; \begin{vmatrix} a & b & -\mu \\ -\nu & b & \lambda \\ \mu & -\lambda & c \end{vmatrix}; \begin{vmatrix} 0 & \nu & -\mu \\ \nu & 0 & \lambda \\ \mu & -\lambda & 0 \end{vmatrix}$$

are respectively *symmetrical*, *skew* and *skew symmetrical*;

The theory admits of very extensive algebraic developments, and applications in algebraical geometry and other parts of mathematics. For further developments of the theory of determinants see ALGEBRAIC FORMS. (A. Ca.)

9. *History*.—These functions were originally known as "resistants," a name applied to them by Pierre Simon Laplace, but now replaced by the title "determinants," a name first applied to certain forms of them by Carl Friedrich Gauss. The germ of the theory of determinants is to be found in the writings of Gottfried Wilhelm Leibnitz (1693), who incidentally discovered certain properties when reducing the eliminant of a system of linear equations. Gabriel Cramer, in a note to his *Analyse des lignes courbes algebriques* (1750), gave the rule which establishes the sign of a product as *plus* or *moins* according as the number of displacements from the typical form has been even or odd. Determinants were also employed by Etienne Bezout in 1764, but the first connected account of these functions was published in 1773 by Charles Auguste Vandermonde. Laplace developed a theorem of Vandermonde for the expansion of a determinant, and in 1773 Joseph Louis Lagrange, in his memoir on *Pyramids*, used determinants of the third order, and proved that the square of a determinant was also a determinant. Although he obtained results now identified with determinants, Lagrange did not discuss these functions systematically. In 1801 Gauss published his *Disquisitiones arithmeticae*, which, although written in an obscure form, gave a new impetus to investigations on this and kindred subjects. To Gauss is due the establishment of the important theorem, that the product of two determinants both of the second and third orders is a determinant. The formulation of the general theory is due to Augustin Louis Cauchy, whose work was the forerunner of the brilliant discoveries made in the following decades by Hotaf-Wronski and J. Binet in France, Carl Gustav Jacobi in Germany, and James Joseph Sylvester and Arthur Cayley in England. Jacobi's researches were published in *Crelle's Journal* (1826-1841). In these papers the subject was recast and enriched by new and important theorems, through which the name of Jacobi is indissolubly associated with this branch of science. The far-reaching discoveries of Sylvester and Cayley rank as one of the most important developments of pure mathematics. Numerous new fields were opened up, and have been diligently explored by many mathematicians. Skew-determinants were studied by Cayley; asymmetric-determinants by Jacobi, V. A. Lebesgue, Sylvester and O. Hesse, and centro-symmetric determinants by W. R. F. Scott and G. Zeilens. Continuants have been discussed by Sylvester; alternants by Cauchy, Jacobi, N. Trudi, H. Nagelbach and C. Garbieri; circulants by E. Catalan, W. Spottiswoode and J. W. L. Glauber, and Wronskians by E. B. Christoffel and G. Frobenius. Determinants composed of binomial coefficients have been studied by V. von Zeipel; the expansion of definite integrals as determinants by A. Tresselt and A. Enneper, and the expression of continued fractions as determinants by Jacobi, V. Nachreiner, S. Günther and E. Fästenau. (See T. Muir, *Theory of Determinants*, 1906).

DETERMINISM (Lat. *determinare*, to prescribe or limit), in ethics, the name given to the theory that all moral choice, so called, is the determined or necessary result of psychological and other conditions. It is opposed to the various doctrines of Free-Will, known as voluntarism, libertarianism, indeterminism, and is from the ethical standpoint more or less akin to necessitarianism and fatalism. There are various degrees of determinism. It may be held that every action is causally connected not only externally with the sum of the agent's environment, but also internally with his motives and impulses. In other words, if we could know exactly all these conditions, we should be able to forecast with mathematical certainty the course which the agent would pursue. In this theory the agent cannot be held responsible for his action in any sense. It is the extreme antithesis of Indeterminism or Indifferentism, the doctrine that a man is absolutely free to choose between alternative courses (the *liberum arbitrium indifferentiae*). Since, however, the evidence of ordinary consciousness almost always goes to prove that the individual, especially in relation to future acts, regards himself as being free within certain limitations to make his own choice of alternatives, many determinists go so far as to admit that there may be in any action which is neither reflex nor determined by external causes solely an element of freedom. This view is corroborated by the phenomenon of remorse, in which the agent feels that he ought to, and could, have chosen a different course of action. These two kinds of determinism are sometimes distinguished as "hard" and "soft" determinism. The controversy between determinism and libertarianism hinges largely on the significance of the word "motive"; indeed in no other philosophical controversy has so much difficulty been caused

by purely verbal disputation and ambiguity of expression. How far, and in what sense, can action which is determined by motives be said to be free? For a long time the advocates of free-will, in their eagerness to preserve moral responsibility, went so far as to deny all motives as influencing moral action. Such a contention, however, clearly defeats its own object by reducing all action to chance. On the other hand, the scientific doctrine of evolution has gone far towards obliterating the distinction between external and internal compulsion, e.g. motives, character and the like. In so far as man can be shown to be the product of, and a link in, a long chain of causal development, so far does it become impossible to regard him as self-determined. Even in his motives and his impulses, in his mental attitude towards outward surroundings, in his appetites and aversions, inherited tendency and environment have been found to play a very large part; indeed many thinkers hold that the whole of a man's development, mental as well as physical, is determined by external conditions.

In the Bible the philosophical-religious problem is nowhere discussed, but Christian ethics as set forth in the New Testament assumes throughout the freedom of the human will. It has been argued by theologians that the doctrine of divine fore-knowledge, coupled with that of the divine origin of all things, necessarily implies that all human action was fore-ordained from the beginning of the world. Such an inference is, however, clearly at variance with the whole doctrine of sin, repentance and the atonement, as also with that of eternal reward and punishment, which postulates a real measure of human responsibility.

For the history of the free-will controversy see the articles, WILL, PREDESTINATION (for the theological problems), ETHICS.

DETINUE (O. Fr. *detenue*, from *detenir*, to hold back), in law, an action whereby one who has an absolute or a special property in goods seeks to recover from another who is in actual possession and refuses to redeliver them. If the plaintiff succeeds in an action of detinue, the judgment is that he recover the chattel or, if it cannot be had, its value, which is assessed by the judge and jury, and also certain damages for detaining the same. An order for the restitution of the specific goods may be enforced by a special writ of execution, called a writ of delivery. (See CONTRACT; TROVER.)

DETMOLD, a town of Germany, capital of the principality of Lippe-Detmold, beautifully situated on the east slope of the Teutoburger Wald, 25 m. S. of Minden, on the Herford-Altenbeken line of the Prussian state railways. Pop. (1905) 13,164. The residential chateau of the princes of Lippe-Detmold (1550) in the Renaissance style, is an imposing building, lying with its pretty gardens nearly in the centre of the town; whilst at the entrance to the large park on the south is the New Palace (1708-1718), enlarged in 1850, used as the dower-house. Detmold possesses a natural history museum theatre, high school, library, the house in which the poet Ferdinand Freiligrath (1810-1876) was born, and that in which the dramatist Christian Dietrich Grabbe (1801-1836), also a native, died. The leading industries are linen-weaving, tanning, brewing, horse-dealing and the quarrying of marble and gypsum. About 3 m. to the south-west of the town is the Grotenburg, with Ernst von Bandel's colossal statue of Hermann or Arminius, the leader of the Cherusci. Detmold (Thiatmelli) was in 783 the scene of a conflict between the Saxons and the troops of Charlemagne.

DETROIT, the largest city of Michigan, U.S.A., and the county-seat of Wayne county, on the Detroit river opposite Windsor, Canada, about 4 m. W. from the outlet of Lake St Clair and 18 m. above Lake Erie. Pop. (1880) 116,340; (1890) 205,876; (1900) 285,704, of whom 96,503 were foreign-born and 4111 were negroes; (1910 census) 465,766. Of the foreign-born in 1900, 32,027 were Germans and 10,703 were German Poles, 25,403 were English Canadians and 3541 French Canadians, 6347 were English and 6412 were Irish. Detroit is served by the Michigan Central, the Lake Shore & Michigan Southern, the Wabash, the Grand Trunk, the P&E Marquette, the Detroit & Toledo Shore Line, the Detroit, Toledo & Ironton and the Canadian Pacific railways. Two belt lines, one 2 m. to 3 m., and

the other 6 m. from the centre of the city, connect the factory districts with the main railway lines. Trains are ferried across the river to Windsor, and steamboats make daily trips to Cleveland, Wyandotte, Mount Clemens, Port Huron, to less important places between, and to several Canadian ports. Detroit is also the S. terminus for several lines to more remote lake ports, and electric lines extend from here to Port Huron, Flint, Pontiac, Jackson, Toledo and Grand Rapids.

The city extended in 1907 over about 41 sq. m., an increase from 29 sq. m. in 1900 and 36 sq. m. in 1905. Its area in proportion to its population is much greater than that of most of the larger cities of the United States. Baltimore, for example, had in 1904 nearly 70% more inhabitants (estimated), while its area at that time was a little less and in 1907 was nearly one-quarter less than that of Detroit. The ground within the city limits as well as that for several miles farther back is quite level, but rises gradually from the river bank, which is only a few feet in height. The Detroit river, along which the city extends for about 10 m., is here $\frac{1}{2}$ m. wide and 30 ft. to 40 ft. deep; its current is quite rapid; its water, a beautiful clear blue; at its mouth it has a width of about 10 m., and in the river there are a number of islands, which during the summer are popular resorts. The city has a 3 m. frontage on the river Rouge, an estuary of the Detroit, with a 16 ft. channel. Before the fire by which the city was destroyed in 1805, the streets were only 12 ft. wide and were unpaved and extremely dirty. But when the rebuilding began, several avenues from 100 ft. to 200 ft. wide were—through the influence of Augustus B. Woodward (c. 1775-1827), one of the territorial judges at the time and admirer of the plan of the city of Washington—made to radiate from two central points. From a half circle called the Grand Circus there radiate avenues 120 ft. and 200 ft. wide. About $\frac{1}{2}$ m. toward the river from this was established another focal point called the Campus Martius, 600 ft. long and 400 ft. wide, at which commence radiating or cross streets 80 ft. and 100 ft. wide. Running north from the river through the Campus Martius and the Grand Circus is Woodward Avenue, 120 ft. wide, dividing the present city, as it did the old town, into nearly equal parts. Parallel with the river is Jefferson Avenue, also 120 ft. wide. The first of these avenues is the principal retail street along its lower portion, and is a residence avenue for 4 m. beyond this. Jefferson is the principal wholesale street at the lower end, and a fine residence avenue E. of this. Many of the other residence streets are 80 ft. wide. The setting of shade trees was early encouraged, and large elms and maples abound. The intersections of the diagonal streets left a number of small, triangular parks, which, as well as the larger ones, are well shaded. The streets are paved mostly with asphalt and brick, though cedar and stone have been much used, and kerdone block to some extent. In few, if any, other American cities of equal size are the streets and avenues kept so clean. The Grand Boulevard, 150 ft. to 200 ft. in width and 12 m. in length, has been constructed around the city except along the river front. A very large proportion of the inhabitants of Detroit own their homes: there are no large congested tenement-house districts; and many streets in various parts of the city are faced with rows of low and humble cottages often having a garden plot in front.

Of the public buildings the city hall (erected 1868-1871), overlooking the Campus Martius, is in Renaissance style, in three storeys; the flagstaff from the top of the tower reaches a height of 200 ft. On the four corners above the first section of the tower are four figures, each 14 ft. in height, to represent Justice, Industry, Art and Commerce, and on the same level with these is a clock weighing 7670 lb.—one of the largest in the world. In front of the building stands the Soldiers' and Sailors' monument, 60 ft. high, designed by Randolph Rogers (1825-1892) and unveiled in 1872. At each of the four corners in each of three sections rising one above the other are bronze eagles and figures representing the United States Infantry, Marine, Cavalry and Artillery, also Victory, Union, Emancipation and History; the figure by which the monument is surmounted was designed to symbolize Michigan. A larger and more massive and stately

building than the city hall is the county court house, facing Cadillac Square, with a lofty tower surmounted by a gilded dome. The Federal building is a massive granite structure, finely decorated in the interior. Among the churches of greatest architectural beauty are the First Congregational, with a fine Byzantine interior, St John's Episcopal, the Woodward Avenue Baptist and the First Presbyterian, all on Woodward Avenue, and St. Anne's and Sacred Heart of Mary, both Roman Catholic. The municipal museum of art, in Jefferson Avenue, contains some unusually interesting Egyptian and Japanese collections, the Scripps' collection of old masters, other valuable paintings, and a small library; free lectures on art are given here through the winter. The public library had 228,500 volumes in 1908, including one of the best collections of state and town histories in the country. A large private collection, owned by C. M. Burton and relating principally to the history of Detroit, is also open to the public. The city is not rich in outdoor works of art. The principal ones are the Merrill fountain and the soldiers' monument on the Campus Martius, and a statue of Mayor Pingree in West Grand Circus Park.

The parks of Detroit are numerous and their total area is about 1200 acres. By far the most attractive is Belle Isle, an island in the river at the E. end of the city, purchased in 1879 and having an area of more than 700 acres. The Grand Circus Park of 4½ acres, with its trees, flowers and fountains, affords a pleasant resting place in the busiest quarter of the city. Six miles farther out on Woodward Avenue is Palmer Park of about 140 acres, given to the city in 1894 and named in honour of the donor. Clark Park (28 acres) is in the W. part of the city, and there are various smaller parks. The principal cemeteries are Elmwood (Protestant) and Mount Elliott (Catholic), which lie adjoining in the E. part of the city; Woodmere in the W. and Woodlawn in the N. part of the city.

Charity and Education.—Among the charitable institutions are the general hospitals (Harper, Grace and St Mary's); the Detroit Emergency, the Children's Free and the United States Marine hospitals; St Luke's hospital, church home, and orphanage; the House of Providence (a maternity hospital and infant asylum); the Woman's hospital and founding's home; the Home for convalescent children, &c. In 1894 the mayor, Hazen Senter Pingree (1842-1901), instituted the practice of preparing, through municipal aid and supervision, large tracts of vacant land in and about the city for the growing of potatoes and other vegetables and then, in conjunction with the board of poor commissioners, assigning it in small lots to families of the unemployed, and furnishing them with seed for planting. This plan served an admirable purpose through three years of industrial depression, and was copied in other cities; it was abandoned when, with the renewal of industrial activity, the necessity for it ceased. The leading penal institution of the city is the Detroit House of Correction, noted for its efficient reformatory work; the inmates are employed ten hours a day, chiefly in making furniture. The house of correction pays the city a profit of \$35,000 to \$40,000 a year. The educational institutions, in addition to those of the general public school system, include several parochial schools, schools of art and of music, and commercial colleges; Detroit College (Catholic), opened in 1877; the Detroit College of Medicine, opened in 1885; the Michigan College of Medicine and Surgery, opened in 1888; the Detroit College of Law, founded in 1891, and a city normal school.

Commerce.—Detroit's location gives to the city's shipping and shipbuilding interests a high importance. All the enormous traffic between the upper and lower lakes passes through the Detroit river. In 1907 the number of vessels recorded was 34,149, with registered tonnage of 53,959,769, carrying 71,226,895 tons of freight, valued at \$697,311,302. This includes vessels which delivered part or all of their cargo at Detroit. The largest item in the freights is iron ore on vessels bound down. The next is coal on vessels up bound. Grain and lumber are the next largest items. Detroit is a port of entry, and its foreign commerce, chiefly with Canada, is of growing importance. The city's exports increased from \$11,325,807 in 1896 to \$37,085,027 in

1909. The imports were \$3,153,609 in 1896 and \$7,100,659 in 1909.

As a manufacturing city, Detroit holds high rank. The total number of manufacturing establishments in 1890 was 1746, with a product for the year valued at \$77,351,546; in 1900 there were 2847 establishments with a product for the year valued at \$100,892,838, or an increase of 30.4% in the decade. In 1900 the establishments under the factory system, omitting the hand trades and neighbourhood industries, numbered 1259 and produced goods valued at \$88,365,924; in 1904 establishments under the factory system numbered 1363 and the product had increased 45.7% to \$128,761,658. In the district subsequently annexed the product in 1904 was about \$12,000,000, making a total of \$140,000,000. The output for 1906 was estimated at \$180,000,000. The state factory inspectors in 1905 visited 1721 factories having 83,231 employees. In 1906 they inspected 1790 factories with 93,071 employees. Detroit is the leading city in the country in the manufacture of automobiles. In 1904 the value of its product was one-fifth that for the whole country. In 1906 the city had twenty automobile factories, with an output of 17,000 cars, valued at \$12,000,000. Detroit is probably the largest manufacturer in the country of freight cars, stoves, pharmaceutical preparations, varnish, soda ash and similar alkali products. Other important manufactures are ships, paints, foundry and machine shop products, brass goods, furniture, boots and shoes, clothing, matches, cigars, malt liquors and fur goods; and slaughtering and meat packing is an important industry.

The Detroit Board of Commerce, organized in 1903, brought into one association the members of three former bodies, making a compact organization with civic as well as commercial aims. The board has brought into active co-operation nearly all the leading business men of the city and many of the professional men. Their united efforts have brought many new industries to the city, have improved industrial conditions, and have exerted a beneficial influence upon the municipal administration. Other business organizations are the Board of Trade, devoted to the grain trade and kindred lines, the Employers' Association, which seeks to maintain satisfactory relations between employer and employed, the Builders' & Traders' Exchange, and the Credit Men's Association.

Administration.—Although the city received its first charter in 1806, and another in 1815, the real power rested in the hands of the governor and judges of the territory until 1824; the charters of 1824 and 1827 centred the government in a council and made the list of elective officers long; the charter of 1827 was revised in 1857 and again in 1859 and the present charter dates from 1881. Under this charter only three administrative officers are elected,—the mayor, the city clerk and the city treasurer,—elections being biennial. The administration of the city departments is largely in the hands of commissions. There is one commissioner each, appointed by the mayor, for the parks and boulevards, police and public works departments. The four members of the health board are nominated by the governor and confirmed by the state senate. The school board is an independent body, consisting of one elected member from each ward holding office for four years, but the mayor has the veto power over its proceedings as well as those of the common council. In each case a two-thirds vote overrules his veto. The other principal officers and commissions, appointed by the mayor and confirmed by the council, are controller, corporation counsel, board of three assessors, fire commission (four members), public lighting commission (six members), water commission (five members), poor commission (four members), and inspectors of the house of correction (four in number). The members of the public library commission, six in number, are elected by the board of education. Itemized estimates of expenses for the next fiscal year are furnished by the different departments to the controller in February. He transmits them to the common council with his recommendations. The council has four weeks in which to consider them. It may reduce or increase the amounts asked, and may add new items. The budget then goes to the board of

estimates, which has a month for its consideration. This body consists of two members elected from each ward and five elected at large. The mayor and heads of departments are advisory members, and may speak but not vote. The members of the board of estimates can hold no other office and they have no appointing power, the intention being to keep them as free as possible from all political motives and influences. They may reduce or cut out any estimates submitted, but cannot increase any or add new ones. No bonds can be issued without the assent of the board of estimates. The budget is apportioned among twelve committees which have almost invariably given close and conscientious examination to the actual needs of the departments. A reduction of \$1,000,000 to \$1,500,000, without impairing the service, has been a not unusual result of their deliberations. Prudent management under this system has placed the city in the highest rank financially. Its debt limit is 2% on the assessed valuation, and even that low maximum is not often reached. The debt in 1907 was only about \$5,500,000, a smaller *per capita* debt than that of any other city of over 100,000 inhabitants in the country; the assessed valuation was \$330,000,000; the city tax, \$14.70 on the thousand dollars of assessed valuation. Both the council and the estimators are hampered in their work by legislative interference. Nearly all the large salaries and many of those of the second grade are made mandatory by the legislature, which has also determined many affairs of a purely administrative character.

Detroit has made three experiments with municipal ownership. On account of inadequate and unsatisfactory service by a private company, the city bought the water-works as long ago as 1836. The works have been twice moved and enlargements have been made in advance of the needs of the city. In 1907 there were six engines in the works with a pumping capacity of 152,000,000 gallons daily. The daily average of water used during the preceding year was 61,357,000 gallons. The water is pumped from Lake St Clair and is of exceptional purity. The city began its own public lighting in April 1895, having a large plant on the river near the centre of the city. It lights the streets and public buildings, but makes no provision for commercial business. The lighting is excellent, and the cost is probably less than could be obtained from a private company. The street lighting is done partly from pole and arm lights, but largely from steel towers from 100 ft. to 180 ft. in height, with strong reflected lights at the top. The city also owns two portable asphalt plants, and thus makes a saving in the cost of street repairing and resurfacing. With a view of effecting the reduction of street car fares to three cents, the state legislature in 1899 passed an act for purchasing or leasing the street railways of the city, but the Supreme Court pronounced this act unconstitutional on the ground that, as the constitution prohibited the state from engaging in a work of internal improvement, the state could not empower a municipality to do so. Certain test votes indicated an almost even division on the question of municipal ownership of the railways.

History.—Detroit was founded in 1701 by Antoine Laumet de la Mothe Cadillac (*c.* 1661–1730), who had pointed out the importance of the place as a strategic point for determining the control of the fur trade and the possession of the North-west and had received assistance from the French government soon after Robert Livingston (1654–1725), the secretary of the Board of Indian Commissioners in New York, had urged the English government to establish a fort at the same place. Cadillac arrived on the 24th of July with about 100 followers. They at once built a palisade fort about 200 ft. square S. of what is now Jefferson Avenue and between Griswold and Shelby streets, and named it Fort Pontchartrain in honour of the French colonial minister. Indians at once came to the place in large numbers, but they soon complained of the high price of French goods; there was serious contention between Cadillac and the French Canadian Fur Company, to which a monopoly of the trade had been granted, as well as bitter rivalry between him and the Jesuits. After the several parties had begun to complain to the home government the monopoly of the fur trade was transferred to Cadillac and he was exhorted to cease quarrelling with the

Jesuits. Although the inhabitants then increased to 200 or more, dissatisfaction with the paternal rule of the founder increased until 1710, when he was made governor of Louisiana. The year before, the soldiers had been withdrawn; by the second year after there was serious trouble with the Indians, and for several years following the population was greatly reduced and the post threatened with extinction. But in 1722, when the Mississippi country was opened, the population once more increased, and again in 1748, when the settlement of the Ohio Valley began, the governor-general of Canada offered special inducements to Frenchmen to settle at Detroit, with the result that the population was soon more than 1000 and the cultivation of farms in the vicinity was begun. In 1760, however, the place was taken by the British under Colonel Robert Rogers and an English element was introduced into the population which up to this time had been almost exclusively French. Three years later, during the conspiracy of Pontiac, the fort first narrowly escaped capture and then suffered from a siege lasting from the 9th of May until the 12th of October. Under English rule it continued from this time on as a military post with its population usually reduced to less than 500. In 1778 a new fort was built and named Fort Lernault, and during the War of Independence the British sent forth from here several Indian expeditions to ravage the frontiers. With the ratification of the treaty which concluded that war the title to the post passed to the United States in 1783, but the post itself was not surrendered until the 11th of January 1796, in accordance with Jay's Treaty of 1794. It was then named Fort Shelby; but in 1802 it was incorporated as a town and received its present name. In 1805 all except one or two buildings were destroyed by fire. General William Hull (1753-1825), a veteran of the War of American Independence, governor of Michigan territory in 1805-1812, as commander of the north-western army in 1812 occupied the city. Failing to hear immediately of the declaration of war between the United States and Great Britain, he was cut off from his supplies shipped by Lake Erie. He made from Detroit on the 12th of July an awkward and futile advance into Canada, which, if more vigorous, might have resulted in the capture of Malden and the establishment of American troops in Canada, and then retired to his fortifications. On the 16th of August 1812, without any resistance and without consulting his officers, he surrendered the city to General Brock, for reasons of humanity, and afterwards attempted to justify himself by criticism of the War Department in general and in particular of General Henry Dearborn's armistice with Prevost, which had not included in its terms Hull, whom Dearborn had been sent out to reinforce.¹ After Perry's victory on the 14th of September on Lake Erie, Detroit on the 29th of September was again occupied by the forces of the United States. Its growth was rather slow until 1830, but since then its progress has been unimpeded. Detroit was the capital of Michigan from 1805 to 1847.

AUTHORITIES.—Silas Farmer, *The History of Detroit and Michigan* (Detroit, 1884 and 1889), and "Detroit, the Queen City," in L. P. Powell's *Historic Towns of the Western States* (New York and London, 1901); D. F. Wilcox, "Municipal Government in Michigan and Ohio," in *Columbia University Studies* (New York, 1896); C. M. Burton, "Cadillac's Village" or *Detroit under Cadillac* (Detroit, 1896); Francis Parkman, *A Half Century of Conflict* (Boston, 1897); and *The Conspiracy of Pontiac* (Boston, 1898); and the annual *Reports of the Detroit Board of Commerce* (1904 sqq.).

DETTINGEN, a village of Germany in the kingdom of Bavaria, on the Main, and on the Frankfurt-on-Main-Aschaffenburg railway, 10 m. N.W. of Aschaffenburg. It is memorable as the scene of a decisive battle on the 27th of June 1743, when the English, Hanoverians and Austrians (the "Pragmatic army"), 42,000 men under the command of George II. of England, routed the numerically superior French forces under the duc de Noailles. It was in memory of this victory that Handel composed his *Dettingen Te Deum*.

¹Hull was tried at Albany in 1814 by court martial, General Dearborn presiding; was found guilty of treason, cowardice, neglect of duty and officerlike conduct, and was sentenced to be shot; the president remitted the sentence because of Hull's services in the Revolution.

DEUCALION, in Greek legend, son of Prometheus, king of Phthia in Thessaly, husband of Pyrrha, and father of Hellen, the mythical ancestor of the Hellenic race. When Zeus had resolved to destroy all mankind by a flood, Deucalion constructed a boat or ark, in which, after drifting nine days and nights, he landed on Mount Parnassus (according to others, Othrys, Aetna or Athos) with his wife. Having offered sacrifice and inquired how to renew the human race, they were ordered to cast behind them the "bones of the great mother," that is, the stones from the hillside. The stones thrown by Deucalion became men, those thrown by Pyrrha, women.

See Apollodorus i. 7, 2; Ovid, *Metam.* i. 243-415; Apollonius Rhodius iii. 1085 ff.; H. Usener, *Die Sinfultagen* (1899).

DEUCE (a corruption of the Fr. *deux*, two), a term applied to the "two" of any suit of cards, or of dice. It is also a term used in tennis when both sides have each scored three points in a game, or five games in a set; to win the game or set two points or games must then be won consecutively. The earliest instances in English of the use of the slang expression "the deuce," in exclamations and the like, date from the middle of the 17th century. The meaning was similar to that of "plague" or "mischief" in such phrases as "plague on you," "mischief take you" and the like. The use of the word as an euphemism for "the devil" is later. According to the *New English Dictionary* the most probable derivation is from a Low German *das daws*, i.e. the "deuce" in dice, the lowest and therefore the most unlucky throw. The personification, with a consequent change of gender, to *der daws*, came later. The word has also been identified with the name of a giant or goblin in Teutonic mythology.

DEUS, JOÃO DE (1830-1896), the greatest Portuguese poet of his generation, was born at San Bartholomeu de Messines in the province of Algarve on the 8th of March 1830. Matriculating in the faculty of law at the university of Coimbra, he did not proceed to his degree but settled in the city, dedicating himself wholly to the composition of verses, which circulated among professors and undergraduates in manuscript copies. In the volume of his art, as in the conduct of life, he practised a rigorous self-control. He printed nothing previous to 1855, and the first of his poems to appear in a separate form was *La Lata*, in 1860. In 1862 he left Coimbra for Beja, where he was appointed editor of *O Bejense*, the chief newspaper in the province of Alemtejo, and four years later he edited the *Folha do Sul*. As the pungent satirical verses entitled *Eleições* prove, he was not an ardent politician, and; though he was returned as Liberal deputy for the constituency of Silves in 1860, he acted independently of all political parties and promptly resigned his mandate. The renunciation implied in the act, which cut him off from all advancement, is in accord with nearly all that is known of his lofty character. In the year of his election as deputy, his friend José Antonio Garcia Blanco collected from local journals the series of poems, *Flores do campo*, which is supplemented by the *Ramo de flores* (1869). This is João de Deus's masterpiece. *Pires de Marmalada* (1869) is an improvisation of no great merit. The four theatrical pieces—*Amemos o nosso proximo*, *Seu aprensivado*, *Ensaio de Casamento*, and *A Vidua inconsolavel*—are prose translations from Méry, cleverly done, but not worth the doing. *Horacio e Lydia* (1872), a translation from Ronsard, is a good example of artifice in manipulating that dangerously monotonous measure, the Portuguese couplet. As an indication of a strong spiritual reaction three prose fragments (1873)—*Anna, Mãe de Maria*, *A Virgem Maria* and *A Mulher do Levito de Ephraim*—translated from Darbois's *Femmes de la Bible*, are full of significance. The *Folhas soltas* (1876) is a collection of verse in the manner of *Flores do campo*, brilliantly effective and exquisitely refined. Within the next few years the writer turned his attention to educational problems, and in his *Cartilha maternal* (1876) first expressed the conclusions to which his study of Pestalozzi and Fröbel had led him. This patriotic, pedagogical apostolate was a misfortune for Portuguese literature; his educational mission absorbed João de Deus completely, and is responsible for numerous controversial letters, for a translation of Théodore-Henri Barrau's treatise, *Des devoirs des enfants envers leurs*

parent, for a prosodic dictionary and for many other publications of so literary value. A copy of verses in Antonio Vieira's *Grinalda de Maria* (1877), the *Loas á Virgem* (1878) and the *Prerobias de Salomão* are evidence of a complete return to orthodoxy during the poet's last years. By a lamentable error of judgment some worthless pornographic verses entitled *Cryptianas* have been inserted in the completest edition of João de Deus's poems—*Campo de Flores* (Lisbon, 1893). He died at Lisbon on the 11th of January 1896, was accorded a public funeral and was buried in the National Pantheon, the Jeronymite church at Belem, where repose the remains of Camoens, Herculano and Garrett. His scattered minor prose writings and correspondence have been posthumously published by Dr Theophilo Braga (Lisbon, 1898).

Next to Camoens and perhaps Garrett, no Portuguese poet has been more widely read, more profoundly admired than João de Deus; yet no poet in any country has been more indifferent to public opinion and more deliberately careless of personal fame. He is not responsible for any single edition of his poems, which were put together by pious but ill-informed enthusiasts, who ascribed to him verses that he had not written; he kept no copies of his compositions, seldom troubled to write them himself, and was content for the most part to dictate them to others. He has no great intellectual force, no philosophic doctrine, is limited in theme as in outlook, is curiously uncertain in his touch, often marring a fine poem with a slovenly rhyme or with a misplaced accent; and, on the only occasion when he was induced to revise a set of proofs, his alterations were nearly all for the worse. And yet, though he never appealed to the patriotic spirit, though he wrote nothing at all comparable in force or majesty to the restrained splendour of *Os Lusíadas*, the popular instinct which links his name with that of his great predecessor is eminently just. For Camoens was his model; not the Camoens of the epic, but the Camoens of the lyrics and the sonnets, where the passion of tenderness finds its supreme utterance. Braga has noted five stages of development in João de Deus's artistic life—the imitative, the idyllic, the lyric, the pessimistic and the devout phases. Under each of these divisions is included much that is of extreme interest, especially to contemporaries who have passed through the same succession of emotional experience, and it is highly probable that *Caturras* and *Gaspar*, pieces as witty as anything in Bocage but free from Bocage's coarse impiety, will always interest literary students. But it is as the singer of love that João de Deus will delight posterity as he delighted his own generation. The elegiac music of *Rachet* and of *Maria*, the melancholy of *Adeus* and of *Remoimho*, the tenderness and sincerity of *Mes casto lório*, of *Lágrima cileste*, of *Descalça*, and a score more songs are distinguished by the large, vital simplicity which withstands time. It is precisely in the quality of unstudied simplicity that João de Deus is incomparably strong. The temptations to a display of virtuosity are almost irresistible for a Portuguese poet; he has the tradition of virtuosity in his blood, he has before him the example of all contemporaries, and he has at hand an instrument of wonderful sonority and compass. Yet not once is João de Deus clamorous or rhetorical, not once does he indulge in idle ornament. His prevailing note is that of exquisite sweetness and of reverent purity; yet with all his caressing softness he is never sentimental, and, though he has not the strength for a long fight, emotion has seldom been set to more delicate music. Had he included among his other gifts the gift of selection, had he continued the poetic discipline of his youth instead of dedicating his powers to a task which, well as he performed it, might have been done no less well by a much lesser man, there is scarcely any height to which he might not have risen.

See also Maxime Formont, *Le Mouvement politique contemporain en Portugal* (Lyon, 1892). (J. F. K.)

DEUTERONOMY, the name of one of the books of the Old Testament. This book was long the storm-centre of Pentateuchal criticism, orthodox scholars boldly asserting that any who questioned its Mosaic authorship reduced it to the level of a pious fraud. But Biblical facts have at last triumphed over tradition, and the non-Mosaic authorship of Deuteronomy is now

a commonplace of criticism. It is still instructive, however, to note the successive phases through which scholarly opinion regarding the composition and date of his book has passed.

In the 17th century the characteristics which so clearly mark off Deuteronomy from the other four books of the Pentateuch were frankly recognized, but the most advanced critics of that age were inclined to pronounce it the earliest and most authentic of the five. In the beginning of the 19th century de Wette startled the religious world by declaring that Deuteronomy, so far from being Mosaic, was not known till the time of Josiah. This theory he founded on 2 Kings xxii.; and ever since, this chapter has been one of the recognized foci of Biblical criticism. The only other single chapter of the Bible which is responsible for having brought about a somewhat similar revolution in critical opinion is Ezek. xlv. From this chapter, some seventy years after de Wette's discovery, Wellhausen with equal acumen inferred that Leviticus was not known to Ezekiel, the priest, and therefore could not have been in existence in his day; for had Leviticus been the recognized Law-book of his nation Ezekiel could not have represented as a degradation the very position which that Law-book described as a special honour conferred on the Levites by Yahweh himself. Hence Leviticus, so far from belonging to an earlier stratum of the Pentateuch than Deuteronomy, as de Wette thought, must belong to a much later stratum, and be at least exilic, if not post-exilic.

The title "Deuteronomy" is due to a mistranslation by the Septuagint of the clause in chap. xvii. 18, rendered "and he shall write out for himself this Deuteronomy." The Hebrew really means "and he [the king] shall write out for himself a copy of this law," where there is not the slightest suggestion that the author intended to describe "this law" delivered on the plains of Moab as a second code in contradistinction to the first code given on Sinai thirty-eight years earlier. Moreover the phrase "this law" is so ambiguous as to raise a much greater difficulty than that caused by the Greek mistranslation of the Hebrew word for "copy." How much does "this law" include? It was long supposed to mean the whole of our present Deuteronomy; indeed, it is on that supposition that the traditional view of the Mosaic authorship is based. But the context alone can determine the question; and that is often so ambiguous that a sure inference is impossible. We may safely assert, however, that nowhere need "this law" mean the whole book. In fact, it invariably means very much less, and sometimes, as in xxvii. 3, 8, so little that it could all be engraved in large letters on a few plastered stones set up beside an altar.

Deuteronomy is not the work of any single writer but the result of a long process of development. The fact that it is legislative as well as hortatory is enough to prove this, for most of the laws it contains are found elsewhere in the Pentateuch, sometimes in less developed, sometimes in more developed forms, a fact which is conclusive proof of prolonged historical development. According to the all-pervading law of evolution, the less complex form must have preceded the more complex. Still, the book does bear the stamp of one master-mind. Its style is as easily recognized as that of Deutero-Isaiah, being as remarkable for its copious diction as for its depths of moral and religious feeling.

The original Deuteronomy, D, read to King Josiah, cannot have been so large as our present book, for not only could it be read at a single sitting, but it could be easily read twice in one day. On the day it was found, Shaphan first read it himself, and then went to the king and read it aloud to him. But perhaps the most conclusive proof of its brevity is that it was read publicly to the assembled people immediately before they, as well as their king, pledged themselves to obey it; and not a word is said as to the task of reading it aloud, so as to be heard by such a great multitude, being long or difficult.

The legislative part of D consists of fifteen chapters (xii.-xxvi.), which, however, contain many later insertions. But the impression made upon Josiah by what he heard was far too deep to have been produced by the legislative part alone. The king must have listened to the curses as well as the blessings in chap. xviii., and

no doubt also to the exhortations in chaps. v.-xi. Hence we may conclude that the original book consisted of a central mass of religious, civil and social laws, preceded by a hortatory introduction and followed by an effective peroration. The book read to Josiah must therefore have comprised most of what is found in Deut. v.-xxvii., xxvii. 9, 10 and xxviii. But something like two centuries elapsed before the book reached its present form, for in the closing chapter, as well as elsewhere, e.g. i. 41-43 (where the joining is not so deftly done as usual) and xxxii. 48-52, there are undoubted traces of the Priestly Code, P, which is generally acknowledged to be post-exilic.

The following is an analysis of the main divisions of the book as we now have it. There are two introductions, the first i.-iv. 44, more historical than hortatory; the second v.-xi., more hortatory than historical. These may at first have been prefixed to separate editions of the legislative portion, but were eventually combined. Then, before D was united to P, five appendices of very various dates and embracing poetry as well as prose, were added so as to give a fuller account of the last days of Moses and thus lead up to the narrative of his death with which the book closes. (1) Chap. xxvii., where the elders of Israel are introduced for the first time as acting along with Moses (xxvii. 1) and then the priests, the Levites (xxvii. 9). Some of the curses refer to laws given not in D but in Lev. xxix., so that the date of this chapter must be later than Leviticus or at any rate than the laws codified in the Law of Holiness (Lev. xvii.-xxvi.). (2) The second appendix, chaps. xxxi.-xxxii. 29, xxxiii. 45-47, gives us the farewell address of Moses and is certainly later than D. Moses is represented as speaking not with any hope of preventing Israel's apostasy but because he knows that the people will eventually prove apostate (xxxii. 29), a point of view very different from D's. (3) The Song of Moses, chap. xxxii. That this didactic poem must have been written late in the nation's history, and not at its very beginning, is evident from v. 7: "Remember the days of old, Consider the years of many generations." Such words cannot be interpreted so as to fit the lips of Moses. It must have been composed in a time of natural gloom and depression, after Yahweh's anger had been provoked by "a very froward generation," certainly not before the Assyrian Empire had loomed up against the political horizon, aggressive and menacing. Some critics bring the date down even to the time of Jeremiah and Ezekiel. (4) The Blessing of Moses, chap. xxxiii. The first line proves that this poem is not by D, who speaks invariably of Horeb, never of Sinai. The situation depicted is in striking contrast with that of the Song. Everything is bright because of promises fulfilled, and the future bids fair to be brighter still. Bruston maintains with reason that the Blessing, strictly so called, consists only of vv. 6-25, and has been inserted in a Psalm celebrating the goodness of Jehovah to his people on their entrance into Canaan (vv. 1-5, 26-29). The special prominence given to Joseph (Ephraim and Manasseh) in vv. 13-17 has led many critics to assign this poem to the time of the greatest warrior-king of Northern Israel, Jeroboam II. (5) The account of Moses' death, chap. xxxiv. This appendix, containing, as it does, manifest traces of P, proves that even Deuteronomy was not put into its present form until after the exile.

From the many coincidences between D and the Book of the Covenant (Ex. xx.-xxiii.) it is clear that D was acquainted with E, the prophetic narrative of the Northern kingdom; but it is not quite clear whether D knew E as an independent work, or after its combination with J, the somewhat earlier prophetic narrative of the Southern kingdom, the combined form of which is now indicated by the symbol JE. Kittel certainly puts it too strongly when he asserts that D quotes always from E and never from J, for some of the passages alluded to in D may just as readily be ascribed to J as to E, cf. Deut. i. 7 and Gen. xv. 18; Deut. x. 14 and Ex. xxiv. 1-4. Consequently D must have been written certainly after E and possibly after E was combined with J.

In Amos, Hosea and Isaiah there are no traces of D's ideas, whereas in Jeremiah and Ezekiel their influence is everywhere manifest. Hence this school of thought arose between the age of

Isaiah and that of Jeremiah; but how long D itself may have been in existence before it was read in 622 to Josiah cannot be determined with certainty. Many argue that D was written immediately before it was found and that, in fact, it was put into the temple for the purpose of being "found." This theory gives some plausibility to the charge that the book is a pious fraud. But the narrative in 2 Kings xxii. warrants no such inference. The more natural explanation is that it was written not in the early years of Josiah's reign, and with the cognizance of the temple priests then in office, but some time during the long reign of Manasseh, probably when his policy was most reactionary and when he favoured the worship of the "host of heaven" and set up altars to strange gods in Jerusalem itself. This explains why the author did not publish his work immediately, but placed it where he hoped it would be safely preserved till opportunity should arise for its publication. One need not suppose that he actually foresaw how favourable that opportunity would prove, and that, as soon as discovered, his work would be promulgated as law by the king and willingly accepted by the people. The author believed that everything he wrote was in full accordance with the mind of Moses, and would contribute to the national weal of Yahweh's covenant people, and therefore he did not scruple to represent Moses as the speaker. It is not to be expected that modern scholars should be able to fix the exact year or even decade in which such a book was written. It is enough to determine with something like probability the century or half-century which best fits its historical data; and these appear to point to the reign of Manasseh.

Between D and P there are no verbal parallels; but in the historical résumés JE is followed closely, whole clauses and even verses being copied practically verbatim. As Dr Driver points out in his careful analysis, there are only three facts in D which are not also found in JE, viz. the number of the spies, the number of souls that went down into Egypt with Jacob, and the ark being made of acacia wood. But even these may have been in J or E originally, and left out when JE was combined with P. Steuernagel divides the legal as well as the hortatory parts of D between two authors, one of whom uses the 2nd person plural when addressing Israel, and the other the 2nd person singular; but as a similar alternation is constantly found in writings universally acknowledged to be by the same author, this clue seems anything but trustworthy, depending as it does on the presence or absence of a single Hebrew letter, and resulting, as it frequently does, in the division of verses which otherwise seem to be from the same pen (cf. xx. 2). The inference as to diversity of authorship is much more conclusive when difference of standpoint can be proved, cf. v. 3, xi. 2 ff. with viii. 2. The first two passages represent Moses as addressing the generation that was alive at Horeb, whereas the last represents him as speaking to those who were about to pass over Jordan a full generation later; and it may well be that the one author may, in the historical and hortatory parts, have preferred the 2nd plural and the other the 2nd singular; without the further inference being justified that every law in which the 2nd singular is used must be assigned to the latter, and every law in which the 2nd plural occurs must be due to the former.

The law of the Single Sanctuary, one of D's outstanding characteristics, is, for him, an innovation, but an innovation towards which events had long been tending. 2 Kings xxiii. 9 shows that even the zeal of Josiah could not carry out the instructions laid down in D xviii. 6-8. Josiah's acceptance of D made it the first canonical book of scripture. Thus the religion of Judah became henceforward a religion which enabled its adherents to learn from a book exactly what was required of them. D requires the destruction not only of the high places and the idols, but of the Asheras (wooden posts) and the Mazzebas (stone pillars) often set up beside the altar of Jehovah (xvi. 21). These reforms made too heavy demands upon the people, as was proved by the reaction which set in at Josiah's death. Indeed the country people would look on the destruction of the high places with their Asheras and Mazzebas as sacrilege and would consider Josiah's death in battle as a divine punishment for his

sacrilegious deeds. On the other hand, the destruction of Jerusalem and the exile of the people would appear to those who had obeyed D's instructions as a well-merited punishment for national apostasy.

Moreover, D regarded religion as of the utmost moment to each individual Israelite; and it is certainly not by accident that the declaration of the individual's duty towards God immediately follows the emphatic intimation to Israel of Yahweh's unity. "Hear, O Israel, Yahweh is our God, Yahweh is one: and thou shalt love Yahweh thy God with all thine heart and with all thy soul and with all thy strength" (vi. 4, 5).

In estimating the religious value of Deuteronomy it should never be forgotten that upon this passage the greatest eulogy ever pronounced on any scripture was pronounced by Christ himself, when he said "on these words hang all the law and the prophets," and it is also well to remember that when tempted in the wilderness he repelled each suggestion of the Tempter by a quotation from Deuteronomy.

Nevertheless even such a writer as D could not escape the influence of the age and atmosphere in which he lived; and despite the spirit of love which breathes so strongly throughout the book, especially for the poor, the widow and the fatherless, the stranger and the homeless Levite (xxiv. 10-22), and the humanity shown towards both beasts and birds (xxii. 1, 4, 6 f., xxv. 4), there are elements in D which go far to explain the intense exclusiveness and the religious intolerance characteristic of Judaism. Should a man's son or friend dear to him as his own soul seek to tempt him from the faith of his fathers, D's pitiless order to that man is "Thou shalt surely kill him; thine hand shall be first upon him to put him to death." From this single instance we see not only how far mankind has travelled along the path of religious toleration since Deuteronomy was written, but also how very far the criticism implied in Christ's method of dealing with what "was said to them of old time" may be legitimately carried. (J. A. P.*)

DEUTSCH, IMMANUEL OSCAR MENAHEM (1829-1873), German oriental scholar, was born on the 28th of October 1829, at Neisse in Prussian Silesia, of Jewish extraction. On reaching his sixteenth year he began his studies at the university of Berlin, paying special attention to theology and the Talmud. He also mastered the English language and studied English literature. In 1855 Deutsch was appointed assistant in the library of the British Museum. He worked intensely on the Talmud and contributed no less than 100 papers to *Chambers's Encyclopaedia*, in addition to essays in Kitto's and Smith's Biblical Dictionaries, and articles in periodicals. In October 1867 his article on "The Talmud," published in the *Quarterly Review*, made him known. It was translated into French, German, Russian, Swedish, Dutch and Danish. He died at Alexandria on the 12th of May 1873.

His *Literary Remains*, edited by Lady Strangford, were published in 1874, consisting of nineteen papers on such subjects as "The Talmud," "Islam," "Semitic Culture," "Egypt, Ancient and Modern," "Semitic Languages," "The Targums," "The Samaritan Pentateuch," and "Arabic Poetry."

DEUTSCHKROWÉ, a town of Germany, kingdom of Prussia, between the two lakes of Arens and Radau, 15 m. N.W. of Schaeidemühl, a railway junction 60 m. north of Posen. Pop. (1905) 7282. It is the seat of the public offices for the district, possesses an Evangelical and a Roman Catholic church, a synagogue, and a gymnasium established in the old Jesuit college, and has manufactures of machinery, woollens, tiles, brady and beer.

BEUTZ (anc. *Divitio*), formerly an independent town of Germany, in the Prussian Rhine Province, on the right bank of the Rhine, opposite to Cologne, with which it has been incorporated since 1888. It contains the church of St Heribert, built in the 17th century, cavalry barracks, artillery magazines, and gas, porcelain, machine and carriage factories. It has a handsome railway station on the banks of the Rhine, negotiating the local traffic with Elberfeld and Königswinter. The fortifications of the town form part of the defences of Cologne. To the east is the manufacturing suburb of Kalk.

The old castle in Deutz was in 1002 made a Benedictine monastery by Heribert, archbishop of C logne. Permission to fortify the town was in 1230 granted to the citizens by the archbishop of Cologne, between whom and the counts of Berg it was in 1240 divided. It was burnt in 1376, 1445 and 1583; and in 1678, after the peace of Nijmegen, the fortifications were dismantled; rebuilt in 1816, they were again razed in 1888.

DEUX-SÈVRES, an inland department of western France, formed in 1790 mainly of the three districts of Poitou, Thouarsais, Gâtine and Niortais, added to a small portion of Saintonge and a still smaller portion of Aunis. Area, 2337 sq. m. Pop. (1906) 339,466. It is bounded N. by Maine-et-Loire, E. by Vienne, S.E. by Charente, S. by Charente-Inférieure and W. by Vendée. The department takes its name from two rivers—the Sèvre de Niort which traverses the southern portion, and the Sèvre of Nantes (an affluent of the Loire) which drains the north-west. There are three regions—the Gâtine, occupying the north and centre of the department, the Plaine in the south and the Marais, —distinguished by their geological character and their general physical appearance. The Gâtine, formed of primitive rocks (granite and schists), is the continuation of the "Bocage" of Vendée and Maine-et-Loire. Its surface is irregular and covered with hedges and clumps of wood or forests. The systematic application of lime has much improved the soil, which is naturally poor. The Plaine, resting on oolite limestone, is treeless but fertile. The Marais, a low-lying district in the extreme south-west, consists of alluvial clays which also are extremely productive when properly drained. The highest points, several of which exceed 700 ft., are found in a line of hills which begins in the centre of the department, to the south of Parthenay, and stretches north-west into the neighbouring department of Vendée. It divides the region drained by the Sèvre Nantaise and the Thouet (both affluents of the Loire) in the north from the basins of the Sèvre Niortaise and the Charente in the south. The climate is mild, the annual temperature at Niort being 54° Fahr., and the rainfall nearly 25 in. The winters are colder in the Gâtine, the summers warmer in the Plaine.

Three-quarters of the entire area of Deux-Sèvres, which is primarily an agricultural department, consists of arable land. Wheat and oats are the main cereals. Potatoes and mangold-wurzels are the chief root-crops. Niort is a centre for the growing of vegetables (onions, asparagus, artichokes, &c.) and of angelica. Considerable quantities of beetroot are raised to supply the distilleries of Melle. Colza, hemp, rape and flax are also cultivated. Vineyards are numerous in the neighbourhood of Bressuire in the north, and of Niort and Melle in the south. The department is well known for the Parthenay breed of cattle and the Poitou breed of horses; and the mules reared in the southern arrondissements are much sought after both in France and in Spain. The system of co-operative dairying is practised in some localities. The apple-trees of the Gâtine and the walnut-trees of the Plaine bring a good return. Coal is mined, and the department produces building-stone and lime. A leading industry is the manufacture of textiles (serges, druggets, linen, handkerchiefs, flannels, swan-skins and knitted goods). Tanning and leather-dressing are carried on at Niort and other places, and gloves are made at Niort. Wool and cotton spinning, hat and shoe making, distilling, brewing, flour-milling and oil-refining are also main industries. The department exports cattle and sheep to Paris and Poitiers; also cereals, oils, wines, vegetables and its industrial products.

The Sèvre Niortaise and its tributary the Mignon furnish 19 m. of navigable waterway. The department is served by the Ouest-État railway. It contains a large proportion of Protestants, especially in the south-east. The four arrondissements are Niort, Bressuire, Melle and Parthenay; the cantons number 31, and the communes 356. Deux-Sèvres is part of the region of the IX. army corps, and of the diocese and the académie (educational circumscription) of Poitiers, where also is its court of appeal.

Niort (the capital), Bressuire, Melle, Parthenay, St Maixent, Thouars and Oiron are the principal places in the department. Several other towns contain features of interest. Among these

are Airvault, where there is a church of the 12th and 14th centuries which once belonged to the abbey of St Pierre, and an ancient bridge built by the monks; Celles-sur-Belle, where there is an old church rebuilt by Louis XI., and again in the 17th century; and St Jouin-de-Marnes, with a fine Romanesque church with Gothic restoration, which belonged to one of the most ancient abbeys of Gaul.

DEVA (Sanskrit "heavenly"), in Hindu and Buddhist mythology, spirits of the light and air, and minor deities generally beneficent. In Persian mythology, however, the word is used for evil spirits or demons. According to Zoroaster the devas were created by Ahriman.

DEVA (mod. *Chester*), a Roman legionary fortress in Britain on the Dee. It was occupied by Roman troops about A.D. 48 and held probably till the end of the Roman dominion. Its garrison was the Legio XX. Valeria Victrix, with which another legion (II. Adjutrix) was associated for a few years, about A.D. 75-85. It never developed, like many Roman legionary fortresses, into a town, but remained military throughout. Parts of its north and east walls (from Morgan's Mount to Peppergate) and numerous inscriptions remain to indicate its character and area.

See F. J. Haverfield, *Catalogue of the Grosvenor Museum, Chester* (Chester, 1900), Introduction.

DEVADATTA, the son of Suklodana, who was younger brother to the father of the Buddha (*Mahāvastu*, iii. 76). Both he and his brother Ananda, who were considerably younger than the Buddha, joined the brotherhood in the twentieth year of the Buddha's ministry. Four other cousins of theirs, chiefs of the Sākya clan, and a barber named Upālī, were admitted to the order at the same time; and at their own request the barber was admitted first, so that as their senior in the order he should take precedence of them (*Vinaya Texts*, iii. 238). All the others continued loyal disciples, but Devadatta, fifteen years afterwards, having gained over the crown prince of Magadha, Ajātasattu, to his side, made a formal proposition, at the meeting of the order, that the Buddha should retire, and hand over the leadership to him, Devadatta (*Vinaya Texts*, iii. 238; *Jātaka*, i. 142). This proposal was rejected, and Devadatta is said in the tradition to have successfully instigated the prince to the execution of his aged father and to have made three abortive attempts to bring about the death of the Buddha (*Vinaya Texts*, iii. 242-250; *Jātaka*, vi. 131), shortly afterwards, relying upon the feeling of the people in favour of asceticism, he brought forward four propositions for ascetic rules to be imposed on the order. These being refused, he appealed to the people, started an order of his own, and gained over 500 of the Buddha's community to join in the secession. We hear nothing further about the success or otherwise of the new order, but it may possibly be referred to under the name of the Gotamakās, in the *Anguttara* (see *Dialogues of the Buddha* i. 222), for Devadatta's family name was Gotama. But his community was certainly still in existence in the 4th century A.D., for it is especially mentioned by Fa Hien, the Chinese pilgrim (Legge's translation, p. 62). And it possibly lasted till the 7th century, for Hsüan Tsang mentions that in a monastery in Bengal the monks then followed a certain regulation of Devadatta's (T. Watters, *On Yuan Chwang*, ii. 191). There is no mention in the canon as to how or when Devadatta died; but the commentary on the *Jātaka*, written in the 5th century A.D., has preserved a tradition that he was swallowed up by the earth near Svātthi, when on his way to ask pardon of the Buddha (*Jātaka*, iv. 158). The spot where this occurred was shown to both the pilgrims just mentioned (Fa Hien, *loc. cit.* p. 60; and T. Watters, *On Yuan Chwang*, i. 390). It is a striking example of the way in which such legends grow, that it is only the latest of these authorities, Hsüan Tsang, who says that, though ostensibly approaching the Buddha with a view to reconciliation, Devadatta had concealed poison in his nail with the object of murdering the Buddha.

AUTHORITIES.—*Vinaya Texts*, translated by Rhys Davids and H. Oldenberg (3 vols., Oxford, 1881-1885); *The Jātaka*, edited by V. Fausbøll (7 vols., London, 1877-1897); T. Watters, *On Yuan Chwang* (ed. Rhys Davids and Bushell, 2 vols., London, 1904-1905);

Fa Hien, translated by J. Legge (Oxford, 1886); *Mahāvastu* (ed. Tenant, 3 vols., Paris, 1882-1897). (T. W. R. D.)

DEVAPRAYAG (DEOPRAYAG), a village in Tehri State of the United Provinces, India. It is situated at the spot where the rivers Alaknanda and Bhagirathi unite and form the Ganges, and as one of the five sacred confluences in the hills is a great place of pilgrimage for devout Hindus. Devaprayag stands at an elevation of 2265 ft. on the side of a hill which rises above it 800 ft. On a terrace in the upper part of the village is the temple of Raghunath, built of huge uncemented stones, pyramidal in form and capped by a white cupola.

DEVENS, CHARLES (1820-1891), American lawyer and jurist, was born in Charlestown, Massachusetts, on the 4th of April 1820. He graduated at Harvard College in 1838, and at the Harvard law school in 1840, and was admitted to the bar in Franklin county, Mass., where he practised from 1841 to 1849. In the year 1848 he was a Whig member of the state senate, and from 1849 to 1853 was United States marshal for Massachusetts, in which capacity he was called upon in 1851 to remand the fugitive slave, Thomas Sims, to slavery. This he felt constrained to do, much against his personal desire; and subsequently he attempted in vain to purchase Sims's freedom, and many years later appointed him to a position in the department of justice at Washington. Devens practised law at Worcester from 1853 until 1861, and throughout the Civil War served in the Federal army, becoming colonel of volunteers in July 1861 and brigadier-general of volunteers in April 1862. At the battle of Ball's Bluff (1861) he was severely wounded; he was again wounded at Fair Oaks (1862) and at Chancellorsville (1863), where he commanded a division. He later distinguished himself at Cold Harbor, and commanded a division in Grant's final campaign in Virginia (1864-65), his troops being the first to occupy Richmond after its fall. Brevetted major-general in 1865, he remained in the army for a year as commander of the military district of Charleston, South Carolina. He was a judge of the Massachusetts superior court from 1867 to 1873, and was an associate justice of the supreme court of the state from 1873 to 1877, and again from 1881 to 1891. From 1877 to 1881 he was attorney-general of the United States in the cabinet of President Hayes. He died at Boston, Mass., on the 7th of January 1891.

See his *Orations and Addresses*, with a memoir by John Codman Ropes (Boston, 1891).

DEVENTER, a town in the province of Overysel, Holland, on the right bank of the Ysel, at the confluence of the Schipbeek, and a junction station 10 m. N. of Zutphen by rail. It is also connected by steam tramway S.E. with Brokulo. Pop. (1900) 26,212. Deventer is a neat and prosperous town situated in the midst of prettily wooded environs, and containing many curious old buildings. There are three churches of special interest: the Groot Kerk (St Lebuinus), which dates from 1334, and occupies the site of an older structure of which the 11th-century crypt remains; the Roman Catholic Broederkerk, or Brothers' Church, containing among its relics three ancient gospels said to have been written by St Lebuinus (Lebwin), the English apostle of the Frisians and Westphalians (d. c. 773); and the Bergkerk, dedicated in 1206, which has two late Romanesque towers. The town hall (1693) contains a remarkable painting of the town council by Terburg. In the fine square called the Brink is the old weigh-house, now a school (gymnasium), built in 1528, with a large external staircase (1644). The gymnasium is descended from the Latin school of which the celebrated Alexander Hegius was master in the third quarter of the 15th century, when the young Erasmus was sent to it, and at which Adrian Floreizon, afterwards Pope Adrian VI., is said to have been a pupil about the same time. Another famous educational institution was the "Athenaeum" or high school, founded in 1630, at which Henri Renery (d. 1639) taught philosophy, while Johann Friedrich Gronovius (Gronovius) (1611-1671) taught rhetoric and history in the middle of the same century. The "Athenaeum" disappeared in 1876. In modern times Deventer possessed a famous teacher in Dr Burgersdyk (d. 1900), the Dutch translator of Shakespeare. The town library, also called the library of the

Athensum, includes many MSS. and *incunabula*, and a 13th-century copy of *Reynard the Fox*. The archives of the town are of considerable value. Besides a considerable agricultural trade, Deventer has important iron foundries and carpet factories (the royal manufactory of Smyrna carpets being especially famous); while cotton-printing, rope-making and the weaving of woollens and silks are also carried on. A public official is appointed to supervise the proper making of a form of gingerbread known as "*Deventer Koek*," which has a reputation throughout Holland. In the church of Bathmen, a village 5 m. E. of Deventer, some 14th-century frescoes were discovered in 1870.

In the 14th century Deventer was the centre of the famous religious and educational movement associated with the name of Gerhard Groot (q.v.), who was a native of the town (see *BROTHERS OF COMMON LIFE*).

DE VERE, AUBREY THOMAS (1814-1902), Irish poet and critic, was born at Curragh Chase, Co. Limerick, on the 10th of January 1814, being the third son of Sir Aubrey de Vere Hunt (1783-1846). In 1833 his father dropped the final name by royal licence. Sir Aubrey was himself a poet. Wordsworth called his sonnets the "most perfect of the age." These and his drama, *Mary Tudor*, were published by his son in 1875 and 1884. Aubrey de Vere was educated at Trinity College, Dublin, and in his twenty-eighth year published *The Waldenses*, which he followed up in the next year by *The Search after Prosperpine*. Thenceforward he was continually engaged, till his death on the 20th of January 1902, in the production of poetry and criticism. His best-known works are: in verse, *The Sisters* (1861); *The Infant Bridal* (1864); *Irish Odes* (1869); *Legends of St Patrick* (1872); and *Legends of the Saxon Saints* (1879); and in prose, *Essays chiefly on Poetry* (1887); and *Essays chiefly Literary and Ethical* (1886). He also wrote a picturesque volume of travel-sketches, and two dramas in verse, *Alexander the Great* (1874); and *St Thomas of Canterbury* (1876); both of which, though they contain fine passages, suffer from diffuseness and a lack of dramatic spirit. The characteristics of Aubrey de Vere's poetry are "high seriousness" and a fine religious enthusiasm. His research in questions of faith led him to the Roman Church; and in many of his poems, notably in the volume of sonnets called *St Peter's Chains* (1888), he made rich additions to devotional verse. He was a disciple of Wordsworth, whose calm meditative serenity he often echoed with great felicity; and his affection for Greek poetry, truly felt and understood, gave dignity and weight to his own versions of mythological idylls. But perhaps he will be chiefly remembered for the impulse which he gave to the study of Celtic legend and literature. In this direction he has had many followers, who have sometimes assumed the appearance of pioneers; but after Matthew Arnold's fine lecture on "Celtic Literature," nothing perhaps did more to help the Celtic revival than Aubrey de Vere's tender insight into the Irish character, and his stirring reproductions of the early Irish epic poetry.

A volume of *Selections* from his poems was edited in 1894 (New York and London) by G. E. Woodberry.

DEVISE, a scheme, plan, simple mechanical contrivance; also a pattern or design, particularly an heraldic design or emblem, often combined with a motto or legend. "Devise" and its doublet "devis" come from the two Old French forms *devis* and *desise* of the Latin *diviso*, things divided, from *dividere*, to separate, used in the sense of to arrange, set out, apportion. "Devise," as a substantive, is now only used as a legal term for a disposition of property by will, by a modern convention restricted to a disposition of real property, the term "bequest" being used of personalty (see *WILL*). This use is directly due to the Medieval Latin meaning of *dividere* = *testamento disponere*. In its verbal form, "devise" is used not only in the legal sense, but also in the sense of to plan, arrange, scheme.

DEVIL (Gr. *δαιμόλιος*, "slanderer" from *δαιβάλλειν*, τ to slander), the generic name for a spirit of evil, especially the supreme spirit of evil, the foe of God and man. The word is used for minor evil spirits in much the same sense as "demon." From the various characteristics associated with this idea, the term has come to be applied by analogy in many different senses. From

the idea of evil as degraded, contemptible and doomed to failure, the term is applied to persons in evil plight, or of slight consideration. In English legal phraseology "devil" and "devilling" are used of barristers who act as substitutes for others. Any remuneration which the legal "devil" may receive is purely a matter of private arrangement between them. In the chancery division such remuneration is generally in the proportion of one half of the fee which the client pays; "in the king's bench division remuneration for 'devilling' of briefs or assisting in drafting and opinions is not common" (see *Annual Practice*, 1907, p. 717). In a similar sense an author may have his materials collected and arranged by a literary hack or "devil." The term "printer's devil" for the errand boy in a printing office probably combines this idea with that of his being black with ink. The common notions of the devil as black, ill-favoured, malicious, destructive and the like, have occasioned the application of the term to certain animals (the Tasmanian devil, the devil-fish, the coot), to mechanical contrivances (for tearing up cloth or separating wool), to pungent, highly seasoned dishes, broiled or fried. In this article we are concerned with the primary sense of the word, as used in mythology and religion.

The primitive philosophy of animism involves the ascription of all phenomena to personal agencies. As phenomena are good or evil, produce pleasure or pain, cause weal or woe, a distinction in the character of these agencies is gradually recognized; the agents of good become gods, those of evil, demons. A tendency towards the simplification and organization of the evil as of the good forces, leads towards belief in outstanding leaders among the forces of evil. When the divine is most completely conceived as unity, the demonic is also so conceived; and over against God stands Satan, or the devil.

Although it is in connexion with Hebrew and Christian monotheism that this belief in the devil has been most fully developed, yet there are approaches to the doctrine in other religions. In Babylonian mythology "the old serpent goddess" the lady Nina was transformed into the embodiment of all that was hostile to the powers of heaven" (Sayce's *Hibbert Lectures*, p. 283), and was confounded with the dragon Tiamat, "a terrible monster, reappearing in the Old Testament writings as Rahab and Leviathan, the principle of chaos, the enemy of God and man" (Tennant's *The Fall and Original Sin*, p. 43), and according to Gunkel (*Schöpfung und Chaos*, p. 383) "the original of the 'old serpent' of Rev. xii. 9." In Egyptian mythology the serpent Apap with an army of monsters strives daily to arrest the course of the boat of the luminous gods. While the Greek mythology described the Titans as "enchained once for all in their dark dungeons" yet Prometheus' threat remained to disturb the tranquillity of the Olympian Zeus. In the German mythology the army of darkness is led by Hel, the personification of twilight, sunk to the goddess who enchains the dead and terrifies the living, and Loki, originally the god of fire, but afterwards "looked upon as the father of the evil powers, who strips the goddess of earth of her adornments, who robs Thor of his fertilizing hammer, and causes the death of Balder the beneficent sun." In Hindu mythology the Maruts, Indra, Agni and Vishnu wage war with the serpent Ahi to deliver the celestial cows or spouses, the waters held captive in the caverns of the clouds. In the *Trimurti*, Brahmā (the impersonal) is manifested as Brahmā (the personal creator), Vishnu (the preserver), and Siva (the destroyer). In Siva is perpetuated the belief in the god of Vedic times Rudra, who is represented as "the wild hunter who storms over the earth with his bands, and lays low with arrows the men who displease him" (Chantepie de la Saussaye's *Religionsgeschichte*, 2nd ed., vol. ii. p. 25). The evil character of Siva is reflected in his wife, who as Kali (the black) is the wild and cruel goddess of destruction and death. The opposition of good and evil is most fully carried out in Zoroastrianism. Opposed to Ormuzd, the author of all good, is Ahriman, the source of all evil; and the opposition runs through the whole universe (D'Alviella's *Hibbert Lectures*, pp. 158-164).

The conception of *Satan* (Heb. שָׂטָן, the adversary, Gr. *Zaravās*, or *Zarāt*, 2 Cor. xii. 7) belongs to the post-exilic period of Hebrew development, and probably shows traces of

influence of Persian on Jewish thought, but it has also its roots in much older beliefs. An "evil spirit" possesses Saul (1 Sam. xvi. 14), but it is "from the Lord." The same agency produces discord between Abimelech and the Shechemites (Judges ix. 23). "A lying spirit in the mouth of all his prophets" as Yahweh's messenger entices Ahab to his doom (1 Kings xxii. 22). Growing human corruption is traced to the fleshy union of angels and women (Gen. vi. 1-4). But generally evil, whether as misfortune or as sin, is assigned to divine causality (1 Sam. xviii. 10; 2 Sam. xxiv. 1; 1 Kings xxii. 20; Isa. vi. 10, lxiii. 17). After the Exile there is a tendency to protect the divine transcendence by the introduction of mediating angelic agency, and to separate all evil from God by ascribing its origin to Satan, the enemy of God and man. In the prophecy of Zechariah (iii. 1-2) he stands as the adversary of Joshua, the high priest, and is rebuked by Yahweh for desiring that Jerusalem should be further punished. In the book of Job he presents himself before the Lord among the sons of God (ii. 1), yet he is represented both as accuser and tempter. He disbelieves in Job's integrity, and desires him to be so tried that he may fall into sin. While, according to 2 Sam. xxiv. 1, God himself tests David in regard to the numbering of the people, according to 1 Chron. xxi. 1 it is Satan who tempts him.

The development of the conception continued in later Judaism, which was probably more strongly influenced by Persian dualism. It is doubtful, however, whether the Asmodeus (q.v.) of the book of Tobit is the same as the Ashma Datwa of the Bundahesh. He is the evil spirit who slew the seven husbands of Sara (iii. 8), and the name probably means "Destroyer." In the book of Enoch Satan is represented as the ruler of a rival kingdom of evil, but here are also mentioned Satans, who are distinguished from the fallen angels and who have a threefold function, to tempt, to accuse and to punish. Satan possesses the ungodly (Ecclesiasticus xxi. 27), is identified with the serpent of Gen. iii. (Wisdom ii. 24), and is probably also represented by Asmodeus, to whom lustful qualities are assigned (Tobit vi. 14); Gen. iii. is probably referred to in Psalms of Solomon xvii. 49, "a serpent speaking with the words of transgressors, words of deceit to pervert wisdom." The *Book of the Secrets of Enoch* not only identifies Satan with the Serpent, but also describes his revolt against God, and expulsion from heaven. In the Jewish *Targums* Samael, "the highest angel that stands before God's throne, caused the serpent to seduce the woman"; he coalesces with Satan, and has inferior Satans as his servants. The birth of Cain is ascribed to a union of Satan with Eve. As accuser affecting man's standing before God he is greatly feared.

This doctrine, stripped of much of its grossness, is reproduced in the New Testament. Satan is the *δαιμόλιος* (Matt. xiii. 39; John xiii. 2; Eph. iv. 27; Heb. ii. 14; Rev. ii. 10), slanderer or accuser, the *ῥεπάλω* (Matt. iv. 3; 1 Thess. iii. 5), the tempter, the *πρωτότος* (Matt. v. 37; John xvii. 15; Eph. vi. 16), the evil one, and the *ἐχθρός* (Matt. xiii. 39), the enemy. He is apparently identified with Beelzebub (or Beelzebul) in Matt. xii. 26, 27. Jesus appears to recognize the existence of demons belonging to a kingdom of evil under the leadership of Satan "the prince of demons" (Matt. xii. 24, 26, 27), whose works in demonic possessions it is his function to destroy (Mark i. 34, iii. 11, vi. 7; Luke x. 17-20). But he himself conquers Satan in resisting his temptations (Matt. iv. 1-11). Simon is warned against him, and Judas yields to him as tempter (Luke xxii. 31; John xiii. 27). Jesus's cures are represented as a triumph over Satan (Luke x. 18). This Jewish doctrine is found in Paul's letters also. Satan rules over a world of evil, supernatural agencies, whose dwelling is in the lower heavens (Eph. vi. 12); hence he is the "prince of the power of the air" (ii. 2). He is the tempter (1 Thess. iii. 5; 1 Cor. vii. 5), the destroyer (x. 10), to whom the offender is to be handed over for bodily destruction (v. 5), identified with the serpent (Rom. xvi. 20; 2 Cor. xi. 3), and probably with Beliar or Belial (vi. 15); and the surrender of man to him brought death into the world (Rom. v. 17). Paul's own "stake in the flesh" is Satan's messenger (2 Cor. xii. 7). According to Hebrews Satan's power over death Jesus destroys by dying (ii. 14). Revela-

tion describes the war in heaven between God with his angels and Satan or the dragon, the "old serpent," the deceiver of the whole world (xii. 9), with his hosts of darkness. After the overthrow of the Beast and the kings of the earth, Satan is imprisoned in the bottomless pit a thousand years (xx. 2). Again loosed to deceive the nations, he is finally cast into the lake of fire and brimstone (xx. 10; cf. Enoch liv. 5, 6; 2 Peter ii. 4). In John's Gospel and Epistles Satan is opposed to Christ. Sinner and murderer from the beginning (1 John iii. 8) and liar by nature (John viii. 44), he enslaves men to sin (viii. 34), causes death (verse 44), rules the present world (xiv. 30), but has no power over Christ or those who are his (xiv. 30, xvi. 11; 1 John v. 18). He will be destroyed by Christ with all his works (John xvi. 33; 1 John iii. 8).

In the common faith of the Gentile churches after the Apostolic Age "the present dominion of evil demons, or of one evil demon, was just as generally presupposed as man's need of redemption, which was regarded as a result of that dominion. The tenacity of this belief may be explained among other things by the living impression of the polytheism that surrounded the communities on every side. By means of this assumption too, humanity seemed to be unburdened, and the presupposed capacity for redemption could, therefore, be justified in its widest range" (Harnack's *History of Dogma*, i. p. 181). While Christ's First Advent delivered believers from Satan's bondage, his overthrow would be completed only by the Second Advent. The Gnostics held that "the present world sprang from a fall of man, or from an undertaking hostile to God, and is, therefore, the product of an evil or intermediate being" (p. 257). Some taught that while the future had been assigned by God to Christ, the devil had received the present age (p. 309). The fathers traced old doctrines not held by the Catholic Church to the devil, and the virtues of heretics were regarded as an instance of the devil transforming himself into an angel of light (ii. 91). Irenaeus ascribes Satan's fall to "pride and arrogance and envy of God's creation"; and traces man's deliverance from Satan to Christ's victory in resisting his temptations; but also, guided by certain Pauline passages, represents the death of Christ "as a ransom paid to the 'apostasy' for men who had fallen into captivity" (ii. 209). He does not admit that Satan has any lawful claim on man, or that God practised a deceit on him, as later fathers taught. This theory of the *atonement* was formulated by Origen. "By his successful temptation the devil acquired a right over men. God offered Christ's soul for that of men. But the devil was duped, as Christ overcame both him and death" (p. 367). It was held by Gregory of Nyssa, Ambrose, who uses the phrase *piā fraus*, Augustine, Leo I., and Gregory I., who expresses it in its worst form. "The humanity of Christ was the bait; the fish, the devil, snapped at it, and was left hanging on the invisible hook, Christ's divinity" (iii. 307). In Athanasius the relation of the work of Christ to Satan retires into the background, Gregory of Nazianzus and John of Damascus felt scruples about this view. It is expressly repudiated by Anselm and Abelard. Peter the Lombard asserted it, disregarding these objections. Bernard represents man's bondage to Satan "as righteously permitted as a just retribution for sin," he being "the executioner of the divine justice." Another theory of Origen's found less acceptance. The devil, as a being resulting from God's will, cannot always remain a devil. The possibility of his redemption, however, was in the 5th century branded as a heresy. Persian dualism was brought into contact with Christian thought in the doctrine of Mani; and it is permissible to believe that the gloomy views of Augustine regarding man's condition are due in some measure to this influence. Mani taught that Satan with his demons, sprung from the kingdom of darkness, attacked the realm of light, the earth, defeated man sent against him by the God of light, but was overthrown by the God of light, who then delivered the primeval man (iii. 324). "During the middle ages," says Tulloch, "the belief in the devil was absorbing—saints conceived themselves and others to be in constant conflict with him." This superstition, perhaps at its strongest in the 13th to the 15th century, passed into Protestantism. Luther

was always conscious of the presence and opposition of Satan. "As I found he was about to begin again," says Luther, "I gathered together my books, and got into bed. Another time in the night I heard him above my cell walking on the cloister, but as I knew it was the devil I paid no attention to him and went to sleep." He held that this world will pass away with its pleasures, as there can be no real improvement in it, for the devil continues in it to ply his daring and seductive devices (vii. 191). I. A. Dörner (*Christian Doctrine*, iii. p. 93) sums up Protestant doctrine as follows:—"He is brought into relation with natural sinfulness, and the impulse to evil thoughts and deeds is ascribed to him. The dominion of evil over men is also represented as a slavery to Satan, and this as punishment. He has his full power in the extra-Christian world. But his power is broken by Christ, and by his word victory over him is to be won. The power of creating anything is also denied the devil, and only the power of corrupting substances is conceded to him. But it is only at the Last Judgment that his power is wholly annihilated; he is himself delivered up to eternal punishment." This belief in the devil was specially strong in Scotland among both clergy and laity in the 17th century. "The devil was always and literally at hand," says Buckle, "he was haunting them, speaking to them, and tempting them. Go where they would he was there."

In more recent times a great variety of opinions has been expressed on this subject. J. S. Semler denied the reality of demonic possession, and held that Christ in his language accommodated himself to the views of the sick whom he was seeking to cure. Kant regarded the devil as a personification of the radical evil in man. Daub in his *Judas Iscariot* argued that a finite evil presupposes an absolute evil, and the absolute evil as real must be in a person. Schelling regarded the devil as, not a person, but a real principle, a spirit let loose by the freedom of man. Schlegelmacher was an uncompromising opponent of the common belief. "The problem remains to seek evil rather in self than in Satan, Satan only showing the limits of our self-knowledge." Dörner has formulated a theory which explains the development of the conception of Satan in the Holy Scriptures as in correspondence with an evolution in the character of Satan. "Satan appears in Scripture under four leading characters:—first as the tempter of freedom, who desires to bring to decision, secondly as the accuser, who by virtue of the law retorts criminality on man; thirdly as the instrument of the Divine, which brings evil and death upon men; fourthly and lastly he is described, especially in the New Testament, as the enemy of God and man." He supposes "a change in Satan in the course of the history of the divine revelation, in conflict with which he came step by step to be a sworn enemy of God and man, especially in the New Testament times, in which, on the other hand, his power is broken at the root by Christ." He argues that "the world-order, being in process as a moral order, permits breaches everywhere into which Satan can obtain entrance" (pp. 99, 102). H. L. Martensen gives even freer rein to speculation. "The evil principle," he says, "has in itself no personality, but attains a progressively universal personality in its kingdom; it has no individual personality, save only in individual creatures, who in an especial manner make themselves its organs; but among these is one creature in whom the principle is so hypostatized that he has become the centre and head of the kingdom of evil" (*Dogmatics*, p. 199). A. Ritschl gives no place in his constructive doctrine to the belief in the devil; but recognizes that the mutual action of individual sinners on one another constitutes a kingdom of sin, opposed to the Kingdom of God (A. E. Garvie, *The Ritschlian Theology*, p. 304). Kaftan affirms that a "doctrine about Satan can as little be established as about angels, as faith can say nothing about it, and nothing is gained by it for the dogmatic explanation of evil. This whole province must be left to the immediate world-view of the pious. The idea of Satan will on account of the Scriptures not disappear from it, and it would be arrogant to wish to set it aside. Only let everyone keep the thought that Satan also stands under the commission of the Almighty God, and that no one must suppose that by leading back his sins to a Satanic temptation he can get rid of his own

guilt. To transgress these limits is to assail faith" (*Dogmatics*, p. 348). In the book entitled *Evil and Evolution* there is "an attempt to turn the light of modern science on to the ancient mystery of evil." The author contends that the existence of evil is best explained by assuming that God is confronted with Satan, who in the process of evolution interferes with the divine designs, an interference which the instability of such an evolving process makes not incredible. Satan is, however, held to be a creature who has by abuse of his freedom been estranged from, and opposed to his Creator, and who at last will be conquered by moral means. W. M. Alexander in his book on demonic possession maintains that "the confession of Jesus as the Messiah or Son of God is the classical criterion of genuine demonic possession" (p. 150), and argues that as "the Incarnation indicated the establishment of the kingdom of heaven upon earth," there took place "a counter movement among the powers of darkness," of which "genuine demonic possession was one of the manifestations" (p. 249).

Interesting as these speculations are, it may be confidently affirmed that belief in Satan is not now generally regarded as an essential article of the Christian faith, nor is it found to be an indispensable element of Christian experience. On the one hand science has so explained many of the processes of outer nature and of the inner life of man as to leave no room for Satanic agency. On the other hand the modern view of the inspiration of the Scriptures does not necessitate the acceptance of the doctrine of the Scriptures on this subject as finally and absolutely authoritative. The teaching of Jesus even in this matter may be accounted for as either an accommodation to the views of those with whom he was dealing, or more probably as a proof of the limitation of knowledge which was a necessary condition of the Incarnation, for it cannot be contended that as revealer of God and redeemer of men it was imperative that he should either correct or confirm men's beliefs in this respect. The possibility of the existence of evil spirits, organized under one leader, Satan to tempt man and oppose God, cannot be denied; the sufficiency of the evidence for such evil agency may, however, be doubted; the necessity of any such belief for Christian thought and life cannot, therefore, be affirmed. (See also DEMONOLOGY; POSSESSION.) (A. E. G.)

DEVIZES, a market town and municipal borough in the Devizes parliamentary division of Wiltshire, England, 86 m. W. by S. of London by the Great Western railway. Pop. (1901) 6532. Its castle was built on a tongue of land flanked by two deep ravines, and behind this the town grew up in a semicircle on a stretch of bare and exposed tableland. Its main streets, in which a few ancient timbered houses are left, radiate from the market place, where stands a Gothic cross, the gift of Lord Sidmouth in 1814. The Kennet and Avon Canal skirts the town on the N., passing over the high ground through a chain of thirty-nine locks. St John's church, one of the most interesting in Wiltshire, is cruciform, with a massive central tower, based upon two round and two pointed arches. It was originally Norman of the 12th century, and the chancel arch and low vaulted chancel, in this style, are very fine. In the interior several ancient monuments of the Suttons and Heathcotes are preserved, besides some beautiful carved stone work, and two rich ceilings of oak over the chapels. St Mary's, a smaller church, is partly Norman, but was rebuilt in the 15th and again in the 19th century. Its lofty clerestoried nave has an elaborately carved timber roof, and the south porch, though repaired in 1612, preserves its Norman mouldings. The woollen industries of Devizes have lost their prosperity; but there is a large grain trade, with engineering works, breweries, and manufactures of silk, snuff, tobacco and agricultural implements. The town is governed by a mayor, six aldermen and eighteen councillors. Area, 906 acres.

Devizes (*Divinis, la Devise, De Vies*) does not appear in any historical document prior to the reign of Henry I., when the construction of a castle of exceptional magnificence by Roger, bishop of Salisbury, at once constituted the town an important political centre, and led to its speedy development. After the

disgrace of Roger in 1139 the castle was seized by the Crown; in the 14th century it formed part of the dowry of the queens of England, and figured prominently in history until its capture and demolition by Cromwell in the Civil War of the 17th century. Devizes became a borough by prescription, and the first charter from Matilda, confirmed by successive later sovereigns, merely grants exemption from certain tolls and the enjoyment of undisturbed peace. Edward III. added a clause conferring on the town the liberties of Marlborough, and Richard II. instituted a coroner. A gild merchant was granted by Edward I., Edward II. and Edward III., and in 1614 was divided into the three companies of drapers, mercers and leathersellers. The present governing charters were issued by James I. and Charles I., the latter being little more than a confirmation of the former, which instituted a common council consisting of a mayor, a town clerk and thirty-six capital burgesses. These charters were surrendered to Charles II., and a new one was conferred by James II., but abandoned three years later in favour of the original grant. Devizes returned two members to parliament from 1295, until deprived of one member by the Representation of the People Act of 1867, and of the other by the Redistribution Act of 1885. The woollen manufacture was the staple industry of the town from the reign of Edward III. until the middle of the 18th century, when complaints as to the decay of trade began to be prevalent. In the reign of Elizabeth the market was held on Monday, and there were two annual fairs at the feasts of the Purification of the Virgin and the Decollation of John the Baptist. The market was transferred to Thursday in the next reign, and the fairs in the 18th century had become seven in number.

See *Victoria County History, Wiltshire; History of Devizes* (Devizes, 1859).

DEVOLUTION, WAR OF (1667-68), the name applied to the war which arose out of Louis XIV.'s claims to certain Spanish territories in right of his wife Maria Theresa, upon whom the ownership was alleged to have "devolved." (See, for the military operations, *Dutch Wars*.) The war was ended by the treaty of Aix-la-Chapelle in 1668.

DEVON, EARLS OF. From the family of De Redvers (De Ripuariis; Riviers), who had been earls of Devon from about 1100, this title passed to Hugh de Courtenay (c. 1275-1340), the representative of a prominent family in the county (see Gibbon's "digression" in chap. lxi. of the *Decline and Fall*, ed. Bury), but was subsequently forfeited by Thomas Courtenay (1432-1462), a Lancastrian who was beheaded after the battle of Towton. It was revived in 1485 in favour of Edward Courtenay (d. 1509), whose son Sir William (d. 1511) married Catherine, daughter of Edward IV. Too great proximity to the throne led to his attainder, but his son Henry (c. 1498-1539) was restored in blood in 1517 as earl of Devon, and in 1525 was created marquis of Exeter; his second wife was a daughter of William Blount, 4th Lord Mountjoy. The title again suffered forfeiture on Henry's execution, but in 1553 it was recreated for his son Edward (1526-1556). At the latter's death it became dormant in the Courtenay family, till in 1831 a claim by a collateral branch was allowed by the House of Lords, and the earldom of Devon was restored to the peerage, still being held by the head of the Courtenays. The earlier earls of Devon were referred to occasionally as earls of Devonshire, but the former variant has prevailed, and the latter is now solely used for the earldom and dukedom held by the Cavendishes (see *DEVONSHIRE, EARLS AND DUKES OF*, and also the article *COURTENAY*).

DEVONIAN SYSTEM, in geology, the name applied to series of stratified fossiliferous and igneous rocks that were formed during the Devonian period, that is, in the interval of time between the close of the Silurian period and the beginning of the Carboniferous; it includes the marine Devonian and an estuarine Old Red Sandstone series of strata. The name "Devonian" was introduced in 1829 by Sir R. Murchison and A. Sedgwick to describe the older rocks of Cornwall and Devon which W. Lonsdale had shown, from an examination of the fossils, to be intermediate between the Silurian and Carboniferous. The same two workers also carried on further researches upon the same rocks of the

European continent, where already several others, F. Roemer, H. E. Beyrich, &c., were endeavouring to elucidate the succession of strata in this portion of the "Transition Series." The labours of these earlier workers, including in addition to those already mentioned, the brothers F. and G. von Sandberger, A. Dumont, J. Gosselet, E. J. A. d'Archiac, E. P. de Verneuil and H. von



Dechen, although somewhat modified by later students, formed the foundation upon which the modern classification of the Devonian rocks is based.

Stratigraphy of the Devonian Facies.

Notwithstanding the fact that it was in Devonshire and Cornwall that the Devonian rocks were first distinguished, it is in central Europe that the succession of strata is most clearly made out, and here, too, their geological position was first indicated by the founders of the system, Sedgwick and Murchison.

Continental Europe.—Devonian rocks occupy a large area in the centre of Europe, extending from the Ardenne through the south of Belgium across Rhenish Prussia to Darmstadt. They are best known from the picturesque gorges which have been cut through them by the Rhine below Bingen and by the Moselle below Treves. They reappear from under younger formations in Brittany, in the Harz and Thuringia, and are exposed in Franconia, Saxony, Silesia, North Moravia and eastern Galicia. The principal subdivisions of the system in the more typical areas are indicated in Table I.

This threefold subdivision, with a central mass of calcareous strata, is traceable westwards through Belgium (where the Calcaire de Givet represents the *Silesites* group of the Eifel) and eastwards into the Harz. The rocks reappear with local petrographical modifications, but with a remarkable persistence of general paleontological characters, in Eastern Thuringia, Franconia, Saxony, Silesia, the north of Moravia and East Galicia. Devonian rocks have been detected among the crumpled rocks of the Styrian Alps by means of the evidence of abundant corals, cephalopods, gastropods, lamelli-branches and other organic remains. Perhaps in other tracts of the Alps, as well as in the Carpathian range, similar shales, limestones and dolomites, though as yet unossiferous, but containing ores of silver, lead, mercury, zinc, cobalt and other metals, may be referable to the Devonian system.

In the centre of Europe, therefore, the Devonian rocks consist of a vast thickness of dark-grey sandy and shaly rocks, with occasional seams of limestone, and in particular with one thick central calcareous zone. These rocks are characterized in the lower zones by numerous broad-winged spirifers and by peculiar trilobites (*Phacops*, *Elonotus*, &c.) which, though generically like those of the Silurian system, are specifically distinct. The central calcareous zone abounds in corals and crinoids as well as in numerous brachiopods. In the highest bands a profusion of coiled cephalopods (*Clymenia*) occurs in some of the limestones, while the shales are crowded with a small but characteristic ostracod crustacean (*Cypridina*). Here and there traces of fishes have been found, more especially in the Eifel, but seldom in such a state of preservation as to warrant their being assigned to any definite place in the zoological scale. Subsequently, however, E. Beyrich has described from Gerolstein in the Eifel an undoubted species of *Pterichthys*, which, as it cannot be certainly identified with any known form, he names *P. Rhenanus*. A *Coccosteus* has been described by F. A. Roemer from the Harz, and still later one has been cited from Bicken near Herborn by V. Koenen; but, as Beyrich points out, there may be some doubt as to whether the latter is not a *Pterichthys*. A *Clenacanthus*, seemingly undistinguishable from the *C. Bohemicus* of Barrande's Etage G, has also been

obtained from the Lower Devonian "Neritenschichten" of Thuringia. The characteristic *Holoptychius nobilissimus* has been detected in the Psammite of Condroz, which in Belgium forms a characteristic sandy portion of the Upper Devonian rocks. These are interesting facts, as helping to link the Devonian and Old Red Sandstone types together. But they are as yet too few and unsupported to warrant any large deduction as to the correlations between these types.

It is in the north-east of Europe that the Devonian and Old Red Sandstone appear to be united into one system, where the limestones and marine organisms of the one are interstratified with the fish-bearing sandstones and shales of the other. In Russia, as was

of the Silurian rocks on which they rest, for they are found gradually to overlap Upper and Lower Silurian formations.

The chief interest of the Russian rocks of this age lies in the fact, first signalized by Murchison and his associates, that they unite within themselves the characters of the Devonian and the Old Red Sandstone types. In some districts they consist largely of limestones, in others of red sandstones and marls. In the former they present molluscs and other marine organisms of known Devonian species; in the latter they afford remains of fishes, some of which are specifically identical with those of the Old Red Sandstone of Scotland. The distribution of these two palaeontological types in Russia is traced by Murchison to the lithological characters of the

TABLE I.

Stages.	Ardenne.	Rhineland.	Brittany and Normandy.	Bohemia.	Harz.	
UPPER DEVONIAN	Famennien (<i>Clymenia</i> beds).	Limestone of Etraungt. Psammites of Condroz (sandy series). Slates of Famenne (shaly series).	<i>Cypridina</i> slates. Pön sandstone (Sauerland). Crumbly limestone (Kramenzellalk) with <i>Clymenia</i> . Neheim slates in Sauerland, and diabases, tufts, &c., in Dillmulde, &c.	Slates of Rostellec.		<i>Cypridina</i> slates. <i>Clymenia</i> limestone and limestone of Altenau.
	Frasien (<i>Isidomesurus</i> beds).	Slates of Matagne. Limestones, marls and shale of Fraane, and red marble of Flanders.	Adorf limestone of Waldeck and shales with <i>Goniatites</i> (Eifel and Aix) = Budesheimer shales. Marls, limestone and dolomite with <i>Rhynchonella cuboides</i> (Flinz in part). Iberg limestone of Dillmulde.	Limestone of Cop-Choux and green slates of Travuloria.		Iberg limestone and Winterberg limestone; also Adorf limestone and shales (Budcsheim).
MIDDLE DEVONIAN.	Givetien (<i>Stringocephalus</i> beds).	Limestone of Givet.	<i>Stringocephalus</i> limestone, ironstone of Brilon and Lahnmulde. Upper Lenne shales, crinoidal limestone of Eifel, red sandstones of Aix. Tufts and diabases of Brilon and Lahnmulde. Red conglomerate of Aix.	Limestones of Chalonnes, Montjean and l'Écochère.	H ₁ (of Barrande) dark plant-bearing shales. H ₁ .	<i>Stringocephalus</i> shales with Flaser and Knollenkalk. Wissenbach slates.
	Eifelien (<i>Calceola</i> beds).	<i>Calceola</i> slates and limestones of Couvin. Greywacke with <i>Spirifer cultrijugatus</i> .	<i>Calceola</i> beds, Wissenbach slates, Lower Lenne beds, Gütroder limestone and clay slate of Lahnmulde, Dillmulde, Wildungen, Griefenstein limestone, Ballersbach limestone.	Slates of Porqugen, greywacke of Fret.	G ₂ Cephalopod limestone. G ₂ Tentaculite limestone. G ₁ Knollenkalk and mottled Mnenian limestone.	<i>Calceola</i> beds. Nereite slates, slates of Wieda and limestones of Hasselfeld.
LOWER DEVONIAN.	Coblentzien.	Greywacke of Hierges. Shales and conglomerate of Burnot with quartzite, of Bierlé and red slates of Vireux, greywacke of Vireux, greywacke of Montigny, sandstone of Anor.	Upper Coblentz slates. Red sandstone of Eifel, Coblentz quartzite, lower Coblentz slates. Hunarlick and Siegener greywacke and slates. Taunus quartzite and greywacke.	Limestones of Erbray, Brulon, Viré and Néhou, greywacke of Faou, sandstone of Cahard.	F ₁ of Barrande. White Konjeprus limestone with Hercynian fauna.	Haupt quartzite (of Lössen) = Rammelsberg slates, Schalkers slates = Kahleberg sandstone. Hercynian slates and limestones.
	Gédinnien.	Slates of St Hubert and Fooz, slates of Mondrepuits, arkose of Weismes, conglomerate of Fébin.	Slates of Gédinne.	Slates and quartzites of Plougastel.		

shown in the great work *Russia and the Ural Mountains* by Murchison, De Verneuil and Keyserling, rocks intermediate between the Upper Silurian and Carboniferous Limestone formations cover an extent of surface larger than the British Islands. This wide development arises not from the thickness but from the undisturbed horizontal character of the strata. Like the Silurian formations described elsewhere, they remain to this day nearly as flat and unaltered as they were originally laid down. Judged by mere vertical depth, they present but a meagre representative of the massive Devonian greywacke and limestone of Germany, or of the Old Red Sandstone of Britain. Yet vast though the area is over which they form the surface rock, it is probably only a small portion of their total extent; for they are found turned up from under the newer formations along the flank of the Ural chain. It would thus seem that they spread continuously across the whole breadth of Russia in Europe. Though almost everywhere undisturbed, they afford evidence of some terrestrial oscillation between the time of their formation and that

rocks, and consequent original diversities of physical conditions, rather than to differences of age. Indeed cases occur where in the same band of rock Devonian shells and Old Red Sandstone fishes lie commingled. In the belt of the formation which extends southwards from Archangel and the White Sea, the strata consist of sands and marls, and contain only fish remains. Traced through the Baltic provinces, they are found to pass into red and green marls, clays, thin limestones and sandstones, with beds of gypsum. In some of the calcareous bands such fossils occur as *Orthis striatula*, *Spiriferina prisca*, *Leptaena productoides*, *Spirifer calcaratus*, *Spirorbis omphaloides* and *Orthoceras subfusiforme*. In the higher beds *Holoptychius* and other well-known fishes of the Old Red Sandstone occur. Followed still farther to the south, as far as the watershed between Orel and Voronezh, the Devonian rocks lose their red colour and sandy character, and become thin-bedded yellow limestones, and dolomites with soft green and blue marls. Traces of salt deposits are indicated by occasional saline springs. It is evident

that the geographical conditions of the Russian area during the Devonian period must have closely resembled those of the Rhine basin and central England during the Triassic period. The Russian Devonian rocks have been classified in Table II. There is an unquestionable passage of the uppermost Devonian rocks of Russia into the base of the Carboniferous system. The Lower Devonian of the Harz contains a fauna which is very different from that of the Rhenish region; to this facies the name

The fossil evidence clearly shows the close agreement of the Rhenish and south Devonshire areas. In north Devonshire the Devonian rocks pass upward without break into the Culm. *North America*.—In North America the Devonian rocks are extensively developed; they have been studied most closely in the New York region, where they are classified according to Table IV. The classification below is not capable of application over the states generally and further details are required from many of the

TABLE II.

	North-West Russia.	Central Russia.	Petchoraland.	Ural Region.
UPPER.	Red sandstone (Old Red). Limestones with <i>Spirifer Verneuili</i> and <i>Sp. Archiaci</i> .	Limestones with <i>Arca oreliana</i> . Limestones with <i>Sp. Verneuili</i> and <i>Sp. Archiaci</i> .	Domanik slates and limestones with <i>Sp. Verneuili</i> .	<i>Cypridina</i> slates, <i>Clymenia</i> limestones (Famennien). Limestones with <i>Gephyoceras intumescens</i> and <i>Rhynchonella cuboides</i> (Frasnien).
MIDDLE.	Dolomites and limestones with <i>Spirifer Anosoffi</i> .		Marl with <i>Spirifer Anosoffi</i> and corals.	Limestones and slates with <i>Sp. Anosoffi</i> (Givétien). Limestones and slates with <i>Pentamerus baichkiricus</i> (Eifélien).
LOWER.	Absent.			Limestones and slates of the Yuresan and Ufa rivers, slate and quartzite, marble of Byelaya and of Bogoslovsk, phyllitic schists and quartzite.

"Hercynian" has been applied, and the correlation of the strata has been a source of prolonged discussion among continental geologists. A similar fauna appears in Lower Devonian of Bohemia, in Brittany (limestone of Erbray) and in the Urals. The Upper Devonian of the Harz passes up into the Culm.

In the eastern Thuringian Fichtelgebirge the upper division is represented by *Clymenia* limestone and *Cypridina* slates with Adorf limestone, diabase and Planschwitzer tuff in the lower part. The middle division has diabases and tuffs at the top with Tentaculite and Nereite shales and limestones below. The upper part of the Lower Devonian, the sandy shale of Steinach, rests unconformably upon Silurian rocks. In the Carnic Alps are coral reef limestones, the equivalents of the Iberg limestone, which attain an enormous thickness; these are underlain by coral limestones with fossils similar to those of the Konjprus limestone of Bohemia; below these are shales and nodular limestones with goniatites. The Devonian rocks of Poland are sandy in the lower, and more calcareous in the upper parts. They are of interest because while the upper portions agree closely with the Rhenish facies, from the top of the Coblenzien upwards, in the sandy beds near the base Old Red Sandstone fishes (*Cocosteus*, &c.) are found. In France Devonian rocks are found well developed in Brittany, as indicated in the table, also in Normandy and Maine; in the Boulonnais district only the middle and upper divisions are known. In south France in the neighbourhood of Cabrières, about Montpellier and in the Montagne Noire, all three divisions are found in a highly calcareous condition. Devonian rocks are recognized, though frequently much metamorphosed, on both the northern and southern flanks of the Pyrenees; while on the Spanish peninsula they are extensively developed. In Asturias they are no less than 3280 ft. thick, all three divisions and most of the central European subdivisions are present. In general, the Lower Devonian fossils of Spain bear a marked resemblance to those of Brittany.

Asia.—From the Ural Mountains eastward, Devonian rocks have been traced from point to point right across Asia. In the Altai Mountains they are represented by limestones of Coblenzien age with a fauna possessing Hercynian features. The same features are observed in the Devonian of the Kougnetsk basin, and in Turkestan. Well-developed quartzites with slates and diabases are found south of Yarkand and Khotan. Middle and Upper Devonian strata are widespread in China. Upper Devonian rocks are recorded from Persia, and from the Hindu Kush on the right bank of the Chitral river.

England.—In England the original Devonian rocks are developed in Devon and Cornwall and west Somerset. In north Devonshire these rocks consist of sandstones, grits and slates, while in south Devon there are, in addition, thick beds of massive limestone, and intercalations of lavas and tuffs. The interpretation of the stratigraphy in this region is a difficult matter, partly on account of the absence of good exposures with fossils, and partly through the disturbed condition of the rocks. The system has been subdivided as shown in Table III.

regions where Devonian rocks have been recognized, but everywhere the broad threefold division seems to obtain. In Maryland the following arrangement has been adopted—(1) Helderberg = Coeymans; (2) Oriskany; (3) Romney = Erian; (4) Jennings = Genesee and Portage; (5) Hampshire = Catalkill in part. In the

TABLE III.

	North Devon and West Somerset.	South Devon.
UPPER.	Pilton group. Grits, slates and thin limestones. Baggy group. Sandstones and slates. Pickwell Down group. Dark slates and grits. Morte slates (?).	Ashburton slates. Livaton slates. Red and green <i>Entonia</i> slates (Famennien). Red and grey slates with tuffs. Chudleigh goniatite limestone. Petherwyn beds (Frasnien).
MIDDLE.	Ilfracombe slates with lenticles of limestone. Combe Martin grits and slates.	Torquay and Plymouth limestones and Ashprington volcanic series. (Givétien and Eifélien.) Slates and limestones of Hope's Nose.
LOWER.	Hangman grits and slates. Lynton group, grits and calcareous slates. Foreland grits and slates.	Looe beds (Cornwall). Meadfoot, Cockington and Warberry series of slates and greywackes. (Coblenzien and Gédinnien.)

interior the Helderbergian is missing and the system commences with (1) Oriskany, (2) Onondaga, (3) Hamilton, (4) Portage (and Genesee), (5) Chemung.

The Helderbergian series is mainly confined to the eastern part of the continent; there is a northern development in Maine, and in Canada (Gaspé, New Brunswick, Nova Scotia and Montreal); an Appalachian belt, and a lower Mississippian region. The series as a whole is mainly calcareous (2000 ft. in Gaspé), and thins out towards the west. The fauna has Hercynian affinities. The Oriskany formation consists largely of coarse sandstones; it is thin in New York, but in Maryland and Virginia it is several hundred feet thick. It is more widespread than the underlying Helderbergian. The Lower Devonian appears to be thick in northern Maine and in Gaspé, New Brunswick and Nova Scotia, but neither the palaeontology nor the stratigraphy has been completely worked out.

In the Middle Devonian the thin clastic deposits at the base, Esopus and Schoharie grits, have not been differentiated west of the Appalachian region; but the Onondaga limestones are much more extensive. The Erian series is often described as the Hamilton series outside the New York district, where the *Marcellus* shales are grouped together with the Hamilton shales, and numerous local subdivisions are included, as in Ohio, Kentucky and Tennessee. The rocks are mostly shales or slates, but limestones predominate in the western development. In Pennsylvania the Hamilton series is from 1500 ft. to 5000 ft. thick, but in the more calcareous western extension it is much thinner. The *Marcellus* shales are bituminous in places.

The Senecan series is composed of shallow-water deposits; the Tully limestone, a local bed in New York, thus out in places into a layer of pyrites which contains a remarkable dwarfed fauna. The bituminous Senecan shales are thickest in Pennsylvania (300 ft.); 25 ft. on Lake Erie. The shales and sandstones of the Portage formation reach 1000 ft. to 1400 ft. in western New York. In the Chatauquan series the Chemung formation is not always clearly separable from the Portage beds, it is a sandstone and conglomerate

in the same manner into the base of the Carboniferous system, while they are separated from each other by an unconformability." The Old Red strata appear to have been deposited in a number of elongated lakes or lagoons, approximately parallel to one another, with a general alignment in a N.E.-S.W. direction. To these areas of deposit Sir A. Geikie has assigned convenient distinctive names.

In Scotland the two divisions of the system are sharply separated by a pronounced unconformability which is probably indicative of a prolonged interval of erosion. In the central valley between the base of the Highlands and the southern uplands lay "Lake Caledonia." Here the lower division is made up of some 20,000 ft. of shallow-water deposits, reddish-brown, yellow and grey sandstones and conglomerates, with occasional "coronstones," and thin limestones. The grey flagstones with shales are almost confined to Forfarshire, and are known as the "Arbroath flags." Interbedded volcanic rocks, andesites, dacites, diabases, with agglomerates and tuffs constitute an important feature, and attain a thickness of 6000 ft. in the Pentland and Ochil hills. A line of old volcanic vents may be traced in a direction roughly parallel to the trend of the great central valley. On the northern side of the Highlands was "Lake Orcadie," presumably much larger than the foregoing lake, though its boundaries are not determinable. It lay over Moray Firth and the east of Ross and Sutherland, and extended from Caithness to the Orkney Islands and S. Shetlands. It may even have stretched across to Norway, where similar rocks are found in Sognefjord and Dalsfjord, and may have had communications with some parts of northern Russia. Very characteristic of this area are the Caithness flags, dark grey and bituminous, which, with the red sandstones and conglomerates at their base, probably attain a thickness of 16,000 ft. The somewhat peculiar fauna of this series led Murchison to class the flags as Middle Devonian. In the Shetland Islands contemporaneous volcanic rocks have been observed. Over the west of Argyllshire lay "Lake Lorne"; here the volcanic rocks predominate, they are intercalated with shallow-water deposits. A similar set of rocks occupy the Cheviot district.

The upper division of the Old Red Sandstone is represented in Shropshire and South Wales by a great series of red rocks, shales, sandstones and marls, some 10,000 ft. thick. They contain few fossils, and no break has yet been found in the series. In Scotland this series was deposited in basins which correspond only partially with those of the earlier period. They are well developed in central Scotland over the lowlands bordering the Moray Firth. Interbedded lavas and tuffs are found in the island of Hoy. An interesting feature of this series is the occurrence of great crowds of fossil fishes in some localities, notably at Dura Den in Fife. In the north of England this series rests unconformably upon the Lower Old Red and the Silurian.

Flanking the Silurian high ground of Cumberland and Westmorland, and also in the Lammernuir hills and in Flint and Anglesey, a brecciated conglomerate, presenting many of the characters of a glacial deposit in places, has often been classed with the Old Red Sandstone, but in parts, at least, it is more likely to belong to the base of the Carboniferous system. In Ireland the lower division appears to be represented by the Dingle beds and Glengariff grits, while the Kerry rocks and the Kiltoran beds of Cork are the equivalents of the upper division. Rocks of Old Red type, both lower and upper, are found in Spitzbergen and in Bear Island. In New Brunswick and Nova Scotia the Old Red facies is extensively developed. The Gaspé sandstones have been estimated at 7036 ft. thick. In parts of western Russia Old Red Sandstone fossils are found in beds intercalated with others containing marine fauna of the Devonian facies.

Devonian and Old Red Sandstone Faunas.

The two types of sediment formed during this period—the marine Devonian and the lagoonal Old Red Sandstone—representing as they do two different but essentially contemporaneous phases of physical condition, are occupied by two strikingly dissimilar faunas. Doubtless at all times there were regions of the earth that were marked off no less clearly from the normal marine conditions of which we have records; but this period is the earliest in which these variations of environment are made obvious. In some respects the faunal break between the older Silurian below and the younger Carboniferous above is not strongly marked; and in certain areas a very close relationship can be shown to exist between the older Devonian and the former, and the younger Devonian and the latter. Nevertheless, taken as a whole, the life of this period bears a distinct stamp of individuality.

The two most prominent features of the Devonian seas are presented by corals and brachiopods. The corals were abundant individually and varied in form; and they are so distinctive of the period that no Devonian species has yet been found either in the Silurian or in the Carboniferous. They built reefs, as in the present day, and contributed to the formation of limestone masses in Devonshire, on the continent of Europe and in North America. Rugose and tabulate forms prevailed; among the former the cyathophyllids (*Cyathophyllum*) were important, *Phyllostroma*, *Zaphrentis*, *Aceradrina* and the curious *Calceola* (*sanadina*), an operculate genus which has given palaeontologists much trouble in its diagnosis, for it has been regarded as a pelecypod (*hippurite*) and

TABLE IV.

Group.	Formations.	Probable European Equivalent.
UPPER.	Chatauquan.	Famennien.
	Senecan.	Frasnien.
MIDDLE.	Erian.	Givétien.
	Usterian.	Eifélien.
LOWER.	Oriskanian.	Coblentzien.
	Helderbergian.	Gédinnien.

formation which reaches its maximum thickness (8000 ft.) in Pennsylvania, but thins rapidly towards the west. In the Catskill region the Upper Devonian has an Old Red facies—red shales and sandstones with a freshwater and brackish fauna.

Although the correlation of the strata has only advanced a short distance, there is no doubt as to the presence of undifferentiated Devonian rocks in many parts of the continent. In the Great Plains this system appears to be absent, but it is represented in Colorado, Utah, Nevada, Wyoming, Montana, California and Arizona; Devonian rocks occur between the Sierras and the Rocky Mountains, in the Arbuckle Mountains of Oklahoma and in Texas. In the western interior limestones predominate; 6000 ft. of limestone are found at Eureka, Nevada, beneath 2000 ft. of shale. On the Pacific coast metamorphism of the rocks is common, and lava-flows and tuffs occur in them.

In Canada, besides the occurrences previously mentioned in the eastern region, Devonian strata are found in considerable force along the course of the Mackenzie river and the Canadian Rockies, whence they stretch out into Alaska. It is probable, however, that much that is now classed as Devonian in Canada will prove on fossil evidence to be Carboniferous.

South America, Africa, Australia, &c.—In South America the Devonian is well developed; in Argentina, Bolivia, Brazil, Peru and the Falkland Islands, the palaeontological horizon is about the junction of the Lower and Middle divisions, and the fauna has affinities with the Hamilton shales of North America. Nearly allied to the South American Devonian is that of South Africa, where they are represented by the Bokkeveld beds in the Cape system. In Australia we find Lower Devonian consisting of coarse littoral deposits with volcanic rocks; and a Middle division with coral limestones in Victoria, New South Wales and Queensland; an Upper division has also been observed. In New Zealand the Devonian is well exposed in the Reefton mining field; and it has been suggested that much of the highly metamorphosed rock may belong to this system.

Stratigraphy of the Old Red Sandstone Facies.

The Old Red Sandstone of Britain, according to Sir Archibald Geikie, consists of two subdivisions, the lower of which passes down conformably into the Upper Silurian deposits, the upper shading off

a brachiopod. The tabulate corals were represented by *Favosites*, *Melchioria*, *Pleurodictyum*, *Fistulipora*, *Pachypora* and others. *Heliodites* and *Plasmopora* represent the alcyonarians. Stromatoporeids were important reef builders. A well-known fossil is *Receptaculites*, a genus to which it has been difficult to assign a definite place; it has been thought to be a sponge, it may be a calcareous alga, or a curious representative of the foraminifera.

In the Devonian period the brachiopods reached the climax of their development: they compose three-quarters of the known fauna, and more than 1100 species have been described. Changes were taking place from the beginning of the period in the relative importance of genera; several Silurian genera dropped out, and new types were coming in. A noticeable feature was the development of broad-winged shells in the genus *Spinifer*, other spiriferids were *Ambocoelia*, *Unclites*, *Vernonia*. Orthis and pentamerids were waning in importance, while the productida (*Productella*, *Chonetes*, *Strophalonia*) were increasing. The strophomenoids were still flourishing, represented by the genera *Leptaena*, *Strophodonta*, *Kaysereia*, and others. The ancient *Lingula*, along with *Crania* and *Orthisuloidea*, occur among the inarticulate forms. Another long-lived and wide-ranging species is *Atrypa reticularis*. The atrypids were very numerous (*Atrypa*, *Retzia*, *Merista*, *Meristella*, *Kaysereia*, &c.); and the rhyntonellids were well represented by *Pugnax*, *Hypothyris*, and several other genera. The important group of terebratulids appears in this system; amongst them *Siringocephalus* is an eminently characteristic Devonian brachiopod; others are *Dielasma*, *Cryptonella*, *Rensselaeria* and *Oriskania*.

The pelecypod molluscs were represented by *Pterinea*, abundant in the lower members along with other large-winged forms, and by *Cucullella*, *Buchiola* and *Curtonotus* in the upper members of the system. Other genera are *Actinodesma*, *Cardiola*, *Nucula*, *Megalodon*, *Aviculpectes*, &c. Gasteropoda were becoming more important, but the simple capulid forms prevailed: *Platyceras* (*Capulus*), *Straparolus*, *Pleurotomaria*, *Murchisonia*, *Macrochelina*, *Euomphalus*. Among the pteropods, *Tentaculites* was very abundant in some quarters; others were *Conularia* and *Styolites*. In the Devonian period the cephalopods began to make a distinct advance in numbers, and in development. The goniatites appear with the genera *Anarcestes*, *Aponalites*, *Tornoceras*, *Bacrites* and others; and in the upper strata the clymenoids, forerunners of the later ammonoids, began to take definite shape. While several new nautiloids (*Homoiceras*, *Reticeras*, &c.) made their appearance several of the older genera still lived in (*Orthoceras*, *Potericeras*, *Actinoceras*).

Crinoids were very abundant in some parts of the Devonian series, though they were relatively scarce in others; they include the genera *Melocrinus*, *Haplocrinus*, *Cyprinoscrinus*, *Calcoscrinus* and *Eleutheroocrinus*. The cyrtidians were falling off (*Proteocystis*, *Tiaracrinus*), but blastoids were in the ascendant (*Nucleocrinus*, *Codaster*, &c.). Both brittle-stars, *Ophiura*, *Palaeophiura*, *Exogaster*, and true starfishes, *Palaeaster*, *Aspidosoma*, were present, as well as urchins (*Lepidocentrus*).

When we turn to the crustaceans we have to deal with two distinct assemblages, one purely marine, trilobitic, the other mainly lacustrine or lagoonal with a eurypterid faunas. The trilobites had already begun to decline in importance, and as happens not infrequently with degenerating races of beasts and men, they began to develop strange eccentricities of ornamentation in some of their genera. A number of Silurian genera lived on into the Devonian period, and some gradually developed into new and distinctive forms; such were *Protius*, *Harpes*, *Cheirurus*, *Bronius* and others. Distinct species of *Phacops* mark the Lower and Upper Devonian respectively, while the genus *Dalmania* (*Odonolochie*) was represented by species with an almost world-wide range. The Ostracod *Entomis* (*Cypridina*) was extremely abundant in places—*Cypridinen-Schiefer*—while the true *Cypridina* was also present along with *Beyrichia*, *Leperditia*, &c. The Phyllocarids, *Echinocaris*, *Eleuthero-caris*, *Tropidocaris*, are common in the United States. It is in the Old Red Sandstone that the eurypterids are best preserved; foremost among these was *Pterygotus*: *P. anglicus* has been found in Scotland with a length of nearly 6 ft.; *Eurypterus*, *Stimodia*, *Stylonurus* were other genera.

Insects appear well developed, including both orthopterous and neuropterous forms in the New Brunswick rocks. Mr. Scudder believed he had obtained a specimen of Orthoptera in which a stridulating organ was present. A species of *Ephemera*, allied to the modern may-fly, had a spread of wing extending to 5 in. In the Scottish Old Red Sandstone myriapods, *Kampearis* and *Archidesmus*, have been described; they are somewhat simpler than more recent forms, each segment being separate, and supplied with only one pair of walking legs. Spiders and scorpions also lived upon the land.

The great number of fish remains in the Devonian and Old Red strata, coupled with the truly remarkable characters possessed by some of the forms, has caused the period to be described as the "age of fishes." As in the case of the crustaceans, referred to above, we find one assemblage more or less peculiar to the freshwater or brackish conditions of the Old Red, and another characteristic of the marine Devonian; on the whole the former is the richer in variety, but there seems little doubt that quite a number of genera were capable of living in either environment, whatever may have been the real condition of the Old Red waters. Foremost in interest are the curious ostracoderms, a remarkable group of creatures possessing many of

the characteristics of fishes, but more probably belonging to a distinct class of organisms, which appears to link the vertebrates with the arthropods. They had come into existence late in Silurian times; but it is in the Old Red strata that their remains are most fully preserved. They were abundant in the fresh or brackish waters of Scotland, England, Wales, Russia and Canada, and are represented by such forms as *Pteraspis*, *Cephalaspis*, *Cyathaspis*, *Tremataspis*, *Bothriolepis* and *Pterichthys*.

In the lower members of the Old Red series *Dipterus*, and in the upper members *Phaneropterus*, represented the diploid lung-fishes; and it is of extreme interest to note that a few of these curious forms still survive in the African *Protopterus*, the Australian *Ceratodus* and the South American *Lepidostren*,—all freshwater fishes. Distantly related to the lung-fishes were the singular arthrodroids, a group possessing the unusual faculty of moving the head in a vertical plane. These comprise the wide-ranging *Cocosteus* with *Homosteus* and *Dinichthys*, the largest fish of the period. The latter probably reached 20 ft. in length; it was armed with exceedingly prominent jaws provided with turtle-like beaks. Sharks were fairly prominent denizens of the sea; some were armed with cutting teeth, others with crushing dental plates; and although they were on the whole marine fishes, they were evidently able to live in fresher waters, like some of their modern representatives, for their remains, mostly teeth and large dermal spines, are found both in the Devonian and Old Red rocks. *Mesacanthus*, *Diplacanthus*, *Climatis*, *Cheiracanthus* are characteristic genera. The crossoterygians, ganoids with a scaly lobe in the centre of the fins, were represented by *Holoptychius* and *Glyptopomus* in the Upper Old Red, and by such genera as *Diplopterus*, *Osteolepis*, *Gyroptichthys* in the lower division. The *Polypterus* of the Nile and *Calamiochthys* of South Africa are the modern exemplars of this group. *Chirolepis*, found in the Old Red of Scotland and Canada, is the only Devonian representative of the actinopterygian fishes. The cyclostome fishes have, so far, been discovered only in Scotland, in the tiny *Palaeospondylus*. Amphibian remains have been found in the Devonian of Belgium; and footprints supposed to belong to a creature of the same class (*Thimopus antiquus*) have been described by Professor Marsh from the Chemung formation of Pennsylvania.

Plant Life.—In the lacustrine deposits of the Old Red Sandstone we find the earliest well-defined assemblage of terrestrial plants. In some regions so abundant are the vegetable remains that in places they form thin seams of vertical coal. These plants evidently flourished around the shores of the lakes and lagoons in which their remains were buried along with the other forms of life. Lycopods and ferns were the predominant types; and it is important to notice that both groups were already highly developed. The ferns include the genera *Sphenopteris*, *Megalopteris*, *Archaeopteris*, *Neuropteris*. Among the Lycopods are *Lycopodium*, *Psilophyton*, *Lepidodendron*. Modern horsetails are represented by *Calamocallis*, *Asterocalmites*, *Annularia*. Of great interest are the genera *Cordaites*, *Araucarioxylon*, &c., which were synthetic types, uniting in some degree the Coniferae and the Cycadofilices. With the exception of obscure markings, aquatic plants are not so well represented as might have been expected; *Paria*, a common fossil, has been regarded as a water plant with a creeping stem and two kinds of sporangia in sessile sporocarps.

Physical Conditions, &c.—Perhaps the most striking fact that is brought out by a study of the Devonian rocks and their fossils is the gradual transgression of the sea over the land, which took place quietly in every quarter of the globe shortly after the beginning of the period. While in most places the Lower Devonian sediments succeed the Silurian formations in a perfectly conformable manner, the Middle and Upper divisions, on account of this encroachment of the sea, rest unconformably upon the older rocks, the Lower division being unrepresented. This is true over the greater part of South America, so far as our limited knowledge goes, in much of the western side of North America, in western Russia, in Thuringia and other parts of central Europe. Of the distribution of land and sea and the position of the coast lines in Devonian times we can state nothing with precision. The known deposits all point to shallow waters of epicontinental seas; no abyssal formations have been recognized. E. Kayser has pointed out the probability of a Eurasian sea province extending through Europe towards the east, across north and central Asia towards Manitoba in Canada, and an American sea province embracing the United States, South America and South Africa. At the same time there existed a great North Atlantic land area caused partly by the uplift of the Caledonian range just before the beginning of the period, which stretched across north Europe to eastern Canada; on the fringe of this land the Old Red Sandstone was formed.

In the European area C. Barrois has indicated the existence of three zones of deposition: (1) A northern, Old Red, region,

including Great Britain, Scandinavia, European Russia and Spitzbergen; here the land was close at hand; great brackish lagoons prevailed, which communicated more or less directly with the open sea. In European Russia, during its general advance, the sea occasionally gained access to wide areas, only to be driven off again, during pauses in the relative subsidence of the land, when the continued terrigenous sedimentation once more established the lagoonal conditions. These alternating phases were frequently repeated. (2) A middle region, covering Devonshire and Cornwall, the Ardennes, the northern part of the lower Rhenish mountains, and the upper Harz to the Polish Mittelgebirge; here we find evidence of a shallow sea, clastic deposits and a sublittoral fauna. (3) A southern region reaching from Brittany to the south of the Rhenish mountains, lower Harz, Thuringia and Bohemia; here was a deeper sea with a more pelagic fauna. It must be borne in mind that the above-mentioned regions are intended to refer to the time when the extension of the Devonian sea was near its maximum. In the case of North America it has been shown that in early and middle Devonian time more or less distinct faunas invaded the continent from five different centres, viz. the Helderberg, the Oriskany, the Onondaga, the southern Hamilton and the north-western Hamilton; these reached the interior approximately in the order given.

Towards the close of the period, when the various local faunas had mingled one with another and a more generalized life assemblage had been evolved, we find many forms with a very wide range, indicating great uniformity of conditions. Thus we find identical species of brachiopods inhabiting the Devonian seas of England, France, Belgium, Germany, Russia, southern Asia and China; such are, *Hypothyris (Rhychnonella) cuboides*, *Spirifer disjunctus* and others. The fauna of the *Calceola* shales can be traced from western Europe to Armenia and Siberia; the *Sriniocephalus* limestones are represented in Belgium, England, the Urals and Canada; and the (*Gephyroceras*) *intumescens* shales are found in western Europe and in Manitoba.

The Devonian period was one of comparative quietude; no violent crustal movements seem to have taken place, and while some changes of level occurred towards its close in Great Britain, Bohemia and Russia, generally the passage from Devonian to Carboniferous conditions was quite gradual. In later periods these rocks have suffered considerable movement and metamorphism, as in the Harz, Devonshire and Cornwall, and in the Belgian coalfields, where they have frequently been thrust over the younger Carboniferous rocks. Volcanic activity was fairly widespread, particularly during the middle portion of the period. In the Old Red rocks of Scotland there is a great thickness (6000 ft.) of igneous rocks, including diabases and andesitic lavas with agglomerates and tuffs. In Devonshire diabases and tuffs are found in the middle division. In west central Europe volcanic rocks are found at many horizons, the most common rocks are diabases and diabase tuffs, *schalstein*. Felsitic lavas and tuffs occur in the Middle Devonian of Australia. Contemporaneous igneous rocks are generally absent in the American Devonian, but in Nova Scotia and New Brunswick there appear to be some.

There is little evidence as to the climate of this period, but it is interesting to observe that local glacial conditions may have existed in places, as is suggested by the coarse conglomerate with striated boulders in the upper Old Red of Scotland. On the other hand, the prevalence of reef-building corals points to moderately warm temperatures in the Middle Devonian seas.

The economic products of Devonian rocks are of some importance: in many of the metamorphosed regions veins of tin, lead, copper, iron are exploited, as in Cornwall, Devon, the Harz; in New Zealand, gold veins occur. Anthracite of Devonian age is found in China and a little coal in Germany, while the Upper Devonian is the chief source of oil and gas of western Pennsylvania and south-western New York. In Ontario the middle division is oil-bearing. Black phosphates are worked in central Tennessee, and in England the marls of the "Old Red" are employed for brick-making.

REFERENCES.—The literature of the Devonian rocks and fossils is very extensive; important papers have been contributed by the following geologists: J. Barrande, C. Barrois, F. Bédard, E. W. Benecke, L. Beushausen, A. Champnerowne, J. M. Clarke, Sir J. W. Dawson, A. Denckmann, J. S. Diller, E. Dupont, F. Frech, J. Fournet, Sir A. Geikie, G. Gürich, R. Hoernes, E. Kayser, C. and M. Koch, A. von Koenen, Hugh Miller, D. P. Oehlert, C. S. Prosser, P. de Rouville, C. Schuchert, T. Tschernyschew, E. O. Ulrich, W. A. E. Ussher, P. N. Wenjukoff, G. F. Whidborne, J. F. Whiteaves and H. S. Williams. Sedgwick and Murchison's original description appeared in the *Trans. Geol. Soc.* (2nd series, vol. v., 1839). Good general accounts will be found in Sir A. Geikie's *Text-Book of Geology* (vol. ii., 4th ed., 1903), in E. Kayser's *Lehrbuch der Geologie* (vol. ii., 2nd ed., 1902), and, for North America, in Chamberlin and Salisbury's *Geology* (vol. ii., 1906). See the *Index to the Geological Magazine* (1864-1903), and in subsequent annual volumes; *Geological Literature added to the Geological Society's Library* (London), annually since 1893; and the *Neues Jahrbuch für Min., Geologie und Paläontologie* (Stuttgart, 2 annual volumes). The U.S. Geological Survey publishes at intervals a *Bibliography and Index of North American Geology, &c.*, and this (e.g. Bulletin 301,—the *Bibliog. and Index for 1901-1905*) contains numerous references for the Devonian system in North America. (J. A. H.)

DEVONPORT, a municipal, county and parliamentary borough of Devonshire, England, contiguous to East Stonehouse and Plymouth, the seat of one of the royal dockyards, and an important naval and military station. Pop. (1901) 70,437. It is situated immediately above the N.W. angle of Plymouth Sound, occupying a triangular peninsula formed by Stonehouse Pool on the E. and the Hamoaze on the W. It is served by the Great Western and the London & South Western railways. The town proper was formerly enclosed by a line of ramparts and a ditch excavated out of the limestone, but these are in great part demolished. Adjoining Devonport are East Stonehouse (an urban district, pop. 15,111), Stoke and Morice Town, the two last being suburbs of Devonport. The town hall, erected in 1821-1822 partly after the design of the Parthenon, is distinguished by a Doric portico; while near it are the public library, in Egyptian style, and a conspicuous Doric column built of Devonshire granite. This monument, which is 100 ft. high, was raised in commemoration of the naming of the town in 1824. Other institutions are the Naval Engineering College, Keyham (1880); the municipal technical schools, opened in 1890, the majority of the students being connected with the dockyard; the naval barracks, Keyham (1885); the Raglan barracks and the naval and military hospitals. On Mount Wise, which was formerly defended by a battery (now a naval signalling station), stands the military residence, or Government House, occupied by the commander of the Plymouth Coast Defences; and near at hand is the principal naval residence, the naval commander-in-chief's house. The prospect from Mount Wise over the Hamoaze to Mount Edgcumbe on the opposite shore is one of the finest in the south of England. The most noteworthy feature of Devonport, however, is the royal dockyard, originally established by William III. in 1689 and until 1824 known as Plymouth Dock. It is situated within the old town boundary and contains four docks. To this in 1853 was added Keyham steamyard, situated higher up the Hamoaze beyond the old boundary and connected with the Devonport yard by a tunnel. In 1896 further extensions were begun at the Keyham yard, which became known as Devonport North yard. Before these were begun the yard comprised two basins, the northern one being 9 acres and the southern 7 acres in area, and three docks, having floor-lengths of 295, 347 and 413 ft., together with iron and brass foundries, machinery shops, engineer students' shop, &c. The new extensions, opened by the Prince of Wales on the 21st of February 1907, cover a total area of 118 acres lying to the northward in front of the Naval Barracks, and involved the reclamation of 77 acres of mudflats lying below high-water mark. The scheme presented three leading features—a tidal basin, a group of three graving docks with entrance lock, and a large enclosed basin with a coaling depot at the north end. The tidal basin, close to the old Keyham north basin, is 740 ft. long with a mean width of 590 ft., and has an area of 10 acres, the depth being 32 ft. at low water of spring tides. It affords access to two graving docks, one with a floor-length of 745 ft. and 203 ft. of water over the sill, and

the other with a length of 741 ft. and 32 ft. of water over the sill. Each of these can be subdivided by means of an intermediate caisson, and (when unoccupied) may serve as an entrance to the closed basin. The lock which leads from the tidal to the closed basin is 730 ft. long, and if necessary can be used as a dock. The closed basin, out of which opens a third graving dock, 660 ft. long, measures 1550 ft. by 1000 ft. and has an area of 35½ acres, with a depth of 32 ft. at low-water springs; it has a direct entrance from the Hamoaze, closed by a caisson. The foundations of the walls are carried down to the rock, which in some places lies covered with mud 100 ft. or more below coping level. Compressed air is used to work the sliding caissons which close the entrances of the docks and closed basin. A ropery at Devonport produces half the hempen ropes used in the navy.

By the Reform Act of 1832 Devonport was erected into a parliamentary borough including East Stonehouse and returning two members. The ground on which it stands is for the most part the property of the St Aubyn family (Barons St Levan), whose steward holds a court leet and a court baron annually. The town is governed by a mayor, sixteen aldermen and forty-eight councillors. Area, 3044 acres.

DEVONPORT, EAST AND WEST, a town of Devon county, Tasmania, situated on both sides of the mouth of the river Mersey, 193 m. by rail N.W. of Hobart. Pop. (1901), East Devonport, 673, West Devonport, 2101. There is regular communication from this port to Melbourne and Sydney, and it ranks as the third port in Tasmania. A celebrated regatta is held on the Mersey annually on New Year's day.

DEVONSHIRE, EARLS AND DUKES OF. The Devonshire title, now in the Cavendish family, had previously been held by Charles Blount (1563-1606), 8th Lord Mountjoy, great-grandson of the 4th Lord Mountjoy (d. 1534), the pupil of Erasmus; he was created earl of Devonshire in 1603 for his services in Ireland, where he became famous in subduing the rebellion between 1600 and 1603; but the title became extinct at his death. In the Cavendish line the 1st earl of Devonshire was William (d. 1626), second son of Sir William Cavendish (q.v.), and of Elizabeth Hardwick, who afterwards married the 6th earl of Shrewsbury. He was created earl of Devonshire in 1618 by James I., and was succeeded by William, 2nd earl (1591-1628), and the latter by his son William (1617-1684), a prominent royalist, and one of the original members of the Royal Society, who married a daughter of the 2nd earl of Salisbury.

WILLIAM CAVENDISH, 1st duke of Devonshire (1640-1707), English statesman, eldest son of the earl of Devonshire last mentioned, was born on the 25th of January 1640. After completing his education he made the tour of Europe according to the custom of young men of his rank, being accompanied on his travels by Dr Killigrew. On his return he obtained, in 1661, a seat in parliament for Derbyshire, and soon became conspicuous as one of the most determined and daring opponents of the general policy of the court. In 1678 he was one of the committee appointed to draw up articles of impeachment against the lord treasurer Danby. In 1679 he was re-elected for Derby, and made a privy councillor by Charles II.; but he soon withdrew from the board with his friend Lord Russell, when he found that the Roman Catholic interest uniformly prevailed. He carried up to the House of Lords the articles of impeachment against Lord Chief-Justice Scroggs, for his arbitrary and illegal proceedings in the court of King's bench; and when the king declared his resolution not to sign the bill for excluding the duke of York, afterwards James II., he moved in the House of Commons that a bill might be brought in for the association of all his majesty's Protestant subjects. He also openly denounced the king's counsellors, and voted for an address to remove them. He appeared in defence of Lord Russell at his trial, at a time when it was scarcely more criminal to be an accomplice than a witness. After the condemnation he gave the utmost possible proof of his attachment by offering to exchange clothes with Lord Russell in the prison, remain in his place, and so allow him to effect his escape. In Novembr 1684 he succeeded to the earldom on the death of his father. He opposed arbitrary government under

James II. with the same consistency and high spirit as during the previous reign. He was withdrawn from public life for a time, however, in consequence of a hasty and imprudent act of which his enemies knew how to avail themselves. Fancying that he had received an insulting look in the presence chamber from Colonel Colepepper, a swaggerer whose attendance at court the king encouraged, he immediately avenged the affront by challenging the colonel, and, on the challenge being refused, striking him with his cane. This offence was punished by a fine of £30,000, which was an enormous sum even to one of the earl's princely fortune. Not being able to pay he was imprisoned in the king's bench, from which he was released only on signing a bond for the whole amount. This was afterwards cancelled by King William. After his discharge the earl went for a time to Chatsworth, where he occupied himself with the erection of a new mansion, designed by William Talman, with decorations by Verrio, Thornhill and Grinling Gibbons. The Revolution again brought him into prominence. He was one of the seven who signed the original paper inviting the prince of Orange from Holland, and was the first nobleman who appeared in arms to receive him at his landing. He received the order of the Garter on the occasion of the coronation, and was made lord high steward of the new court. In 1690 he accompanied King William on his visit to Holland. He was created marquis of Hartington and duke of Devonshire in 1694 by William and Mary, on the same day on which the head of the house of Russell was created duke of Bedford. Thus, to quote Macaulay, "the two great houses of Russell and Cavendish, which had long been closely connected by friendship and by marriage, by common opinions, common sufferings and common triumphs, received on the same day the highest honour which it is in the power of the crown to confer." His last public service was assisting to conclude the union with Scotland, for negotiating which he and his eldest son, the marquis of Hartington, had been appointed among the commissioners by Queen Anne. He died on the 18th of August 1707, and ordered the following inscription to be put on his monument:—

Willielmus Dux Devon.
Bonorum Principum Fidelis Subditus,
Inimicus et Invisus Tyrannus.

He had married in 1661 the daughter of James, duke of Ormonde, and he was succeeded by his eldest son William as 2nd duke, and by the latter's son William as 3rd duke (viceroys of Ireland, 1737-1744). The latter's son William (1720-1764) succeeded in 1755 as 4th duke; he married the daughter and heiress of Richard Boyle, earl of Burlington and Cork, who brought Lismore Castle and the Irish estates into the family; and from November 1756 to May 1757 he was prime minister, mainly in order that Pitt, who would not then serve under the duke of Newcastle, should be in power. His son William (1748-1811), 5th duke, is memorable as the husband of the beautiful Georgiana Spencer, duchess of Devonshire (1757-1806), and of the intellectual Elizabeth Foster, duchess of Devonshire (1758-1824), both of whom Gainsborough painted. His son William, 6th duke (1790-1858), who died unmarried, was sent on a special mission to the coronation of the tsar Nicholas at Moscow in 1826, and became famous for his expenditure on that occasion; and it was he who employed Sir Joseph Paxton at Chatsworth. The title passed in 1858 to his cousin William (1808-1891), 2nd earl of Burlington, as 7th duke, a man who, without playing a prominent part in public affairs, exercised great influence, not only by his position but by his distinguished abilities. At Cambridge in 1829 he was second wrangler, first Smith's prizeman, and eighth classic, and subsequently he became chancellor of the university.

SPENCER COMPTON CAVENDISH, 8th duke (1833-1908), born on the 23rd of July 1833, was the son of the 7th duke (then earl of Burlington) and his wife Lady Blanche Howard (sister of the earl of Carlisle). In 1854 Lord Cavendish, as he then was, took his degree at Trinity College, Cambridge; in 1856 he was attached to the special mission to Russia for the new tsar's accession; and in 1857 he was returned to parliament as Liberal member for North Lancashire. At the opening of the new parliament of 1859 the

marquis of Hartington (as he had now become) moved the amendment to the address which overthrew the government of Lord Derby. In 1863 he became first a lord of the admiralty, and then under-secretary for war, and on the formation of the Russell-Gladstone administration at the death of Lord Palmerston he entered it as war secretary. He retired with his colleagues in July 1866; but upon Mr Gladstone's return to power in 1868 he became postmaster-general, an office which he exchanged in 1871 for that of secretary for Ireland. When Mr Gladstone, after his defeat and resignation in 1874, temporarily withdrew from the leadership of the Liberal party in January 1875, Lord Hartington was chosen Liberal leader in the House of Commons, Lord Granville being leader in the Lords. Mr W. E. Forster, who had taken a much more prominent part in public life, was the only other possible nominee, but he declined to stand. Lord Hartington's rank no doubt told in his favour, and Mr Forster's education bill had offended the Nonconformist members, who would probably have withheld their support. Lord Hartington's prudent management in difficult circumstances laid his followers under great obligations, since not only was the opposite party in the ascendant, but his own former chief was indulging in the freedom of independence. After the complete defeat of the Conservatives in the general election of 1880, a large proportion of the party would have rejoiced if Lord Hartington could have taken the Premiership instead of Mr Gladstone, and the queen, in strict conformity with constitutional usage (though Gladstone himself thought Lord Granville should have had the preference), sent for him as leader of the Opposition. Mr Gladstone, however, was clearly master of the situation: no cabinet could be formed without him, nor could he reasonably be expected to accept a subordinate post. Lord Hartington, therefore, gracefully abdicated the leadership, and became secretary of state for India, from which office, in December 1882, he passed to the war office. His administration was memorable for the expeditions of General Gordon and Lord Wolseley to Khartum, and a considerable number of the Conservative party long held him chiefly responsible for the "betrayal of Gordon." His lethargic manner, apart from his position as war minister, helped to associate him in their minds with a disaster which emphasized the fact that the government acted "too late"; but Gladstone and Lord Granville were no less responsible than he. In June 1885 he resigned along with his colleagues, and in December was elected to the Rossendale Division of Lancashire, created by the new reform bill. Immediately afterwards the great political opportunity of Lord Hartington's life came to him in Mr Gladstone's conversion to home rule for Ireland. Lord Hartington's refusal to follow his leader in this course inevitably made him the chief of the new Liberal Unionist party, composed of a large and influential section of the old Liberals. In this capacity he moved the first resolution at the famous public meeting at the opera house, and also, in the House of Commons, moved the rejection of Mr Gladstone's Bill on the second reading. During the memorable electoral contest which followed, no election excited more interest than Lord Hartington's for the Rossendale division, where he was returned by a majority of nearly 1500 votes. In the new parliament he held a position much resembling that which Sir Robert Peel had occupied after his fall from power, the leader of a small, compact party, the standing and ability of whose members were out of all proportion to their numbers, generally esteemed and trusted beyond any other man in the country, yet to his own opinion forbidden to think of office. Lord Salisbury's offers to serve under him as prime minister (both after the general election, and again when Lord Randolph Churchill resigned) were declined, and Lord Hartington continued to discharge the delicate duties of the leader of a middle party with no less judgment than he had shown when leading the Liberals during the interregnum of 1875-1880. It was not until 1895, when the differences between Conservatives and Liberal Unionists had become almost obliterated by changed circumstances, and the habit of acting together, that the duke of Devonshire, as he had become by the death of his father in 1891, consented to enter Lord Salisbury's third ministry as president of the council. The duke thus was

the nominal representative of education in the cabinet at a time when educational questions were rapidly becoming of great importance; and his own technical knowledge of this difficult and intricate question being admittedly superficial, a good deal of criticism from time to time resulted. He had however by this time an established position in public life, and a reputation for weight of character, which procured for him universal respect and confidence, and exempted him from bitter attack, even from his most determined political opponents. Wealth and rank combined with character to place him in a measure above party; and his succession to his father as chancellor of the university of Cambridge in 1892 indicated his eminence in the life of the country. In the same year he had married the widow of the 7th duke of Manchester.

He continued to hold the office of lord president of the council till the 3rd of October 1903, when he resigned on account of differences with Mr Balfour (q.v.) over the latter's attitude towards free trade. As Mr Chamberlain had retired from the cabinet, and the duke had not thought it necessary to join Lord George Hamilton and Mr Ritchie in resigning a fortnight earlier, the defection was unanticipated and was sharply criticized by Mr Balfour, who, in the rearrangement of his ministry, had only just appointed the duke's nephew and heir, Mr Victor Cavendish, to be secretary to the treasury. But the duke had come to the conclusion that while he himself was substantially a free-trader,¹ Mr Balfour did not mean the same thing by the term. He necessarily became the leader of the Free Trade Unionists who were neither Balfourites nor Chamberlainites, and his weight was thrown into the scale against any association of Unionism with the constructive policy of tariff reform, which he identified with *sheer Protection*. A struggle at once began within the Liberal Unionist organization between those who followed the duke and those who followed Mr Chamberlain (q.v.); but the latter were in the majority and a reorganization in the Liberal Unionist Association took place, the Unionist free-traders seceding and becoming a separate body. The duke then became president of the new organizations, the Unionist Free Food League and the Unionist Free Trade Club. In the subsequent developments the duke played a dignified but somewhat silent part, and the Unionist rout in 1906 was not unaffected by his open hostility to any taint of compromise with the tariff reform movement. But in the autumn of 1907 his health gave way, and grave symptoms of cardiac weakness necessitated his abstaining from public effort and spending the winter abroad. He died, rather suddenly, at Cannes on the 24th of March 1908.

The head of an old and powerful family, a wealthy territorial magnate, and an Englishman with thoroughly national tastes for sport, his weighty and disinterested character made him a statesman of the first rank in his time, in spite of the absence of showy or brilliant qualities. He had no self-seeking ambitions, and on three occasions preferred not to become prime minister. Though his speeches were direct and forcible, he was not an orator, nor "clever"; and he lacked all subtlety of intellect; but he was conspicuous for solidity of mind and straightforwardness of action, and for conscientious application as an administrator, whether in his public or private life. The fact that he once yawned in the middle of a speech of his own was commonly quoted as characteristic; but he combined a great fund of common sense and knowledge of the average opinion with a patriotic sense of duty towards the state. Throughout his career he remained an old-fashioned Liberal, or rather Whig, of a type which in his later years was becoming gradually more and more rare.

There was no issue of his marriage, and he was succeeded as 9th duke by his nephew VICTOR CHRISTIAN CAVENDISH (b. 1868), who had been Liberal Unionist member for West Derbyshire since 1891, and was treasurer of the household (1900 to 1903) and

¹ His own words to Mr Balfour at the time were: "I believe that our present system of free imports is on the whole the most advantageous to the country, though I do not contend that the principles on which it rests possess any such authority or sanctity as to forbid any departure from it, for sufficient reasons."

financial secretary to the treasury (1903 to 1905); in 1892 he married a daughter of the marquess of Lansdowne, by whom he had two sons. (H. Cx.)

DEVONSHIRE (Devon), a south-western county of England, bounded N.W. and N. by the Bristol Channel, N.E. by Somerset and Dorset, S.E. and S. by the English Channel, and W. by Cornwall. The area, 2604.9 sq. m., is exceeded only by those of Yorkshire and Lincolnshire among the English counties. Nearly the whole of the surface is uneven and hilly. The county contains the highest land in England south of Derbyshire (excepting points on the south Welsh border); and the scenery, much varied, is in most parts striking and picturesque. The heather-clad uplands of Exmoor, though chiefly within the borders of Somerset, extend into North Devon, and are still the haunt of red deer, and of the small hardy ponies called after the district. Here, as on Dartmoor, the streams are rich in trout. Dartmoor, the principal physical feature of the county, is a broad and lofty expanse of moorland which rises in the southern part. Its highest point, 2039 ft., is found in the north-western portion. Its rough wastes contrast finely with the wild but wooded region which immediately surrounds the granite of which it is composed, and with the rich cultivated country lying beyond. Especially noteworthy in this fertile tract are the South Hams, a fruitful district of apple orchards, lying between the Erme and the Dart; the rich meadow-land around Crediton, in the vale of Exeter; and the red rocks near Sidmouth. Two features which lend a characteristic charm to the Devonshire landscape are the number of picturesque old cottages roofed with thatch; and the deep lanes, sunk below the common level of the ground, bordered by tall hedges, and overshadowed by an arch of boughs. The north and south coasts of the county differ much in character, but both have grand cliff and rock scenery, not surpassed by any in England or Wales, resembling the Mediterranean seaboard in its range of colour. As a rule the long combes or glens down which the rivers flow seaward are densely wooded, and the country immediately inland is of great beauty. Apart from the Tamar, which constitutes the boundary between Devon and Cornwall, and flows into the English Channel, after forming in its estuary the harbours of Devonport and Plymouth, the principal rivers rise on Dartmoor. These include the Teign, Dart, Plym and Tavvy, falling into the English Channel, and the Taw flowing north towards Bideford Bay. The river Torridge, also discharging northward, receives part of its waters from Dartmoor through the Okement, but itself rises in the angle of high land near Hartland point on the north coast, and makes a wide sweep southward. The lesser Dartmoor streams are the Avon, the Erme and the Vealm, all running south. The Exe rises on Exmoor in Somersetshire; but the main part of its course is through Devonshire (where it gives name to Exeter), and it is joined on its way to the English Channel by the lesser streams of the Culm, the Credeney and the Clyst. The Otter, rising on the Blackdown Hills, also runs south, and the Axe, for part of its course, divides the counties of Devon and Dorset. These eastern streams are comparatively slow; while the rivers of Dartmoor have a shorter and more rapid course.

Geology.—The greatest area occupied by any one group of rocks in Devonshire is that covered by the Culm, a series of slates, grits and greywackes, with some impure limestones and occasional radiolarian cherts as at Coddan Hill; beds of "culm," an impure variety of coal, are found at Bideford and elsewhere. This series of rocks occurs at Bampton, Exeter and Chudleigh and extends thence to the western boundary. North and south of the Culm an older series of slates, grits and limestones appears; it was considered so characteristic of the county that it was called the Devonian system (*gr.*), the marine equivalent of the Old Red Sandstone of Hereford and Scotland. It lies in the form of a trough with its axis running east and west. In the central hollow the Culm reposes, while the northern and southern rims rise to the surface respectively north of the latitude of Barnstaple and South Molton and south of the latitude of Tavistock. These Devonian rocks have been subdivided into upper, middle and lower divisions, but the stratigraphy is difficult to follow as the beds have suffered much crumpling; fine examples of contorted strata may be seen almost anywhere on the north coast, and in the south, at Bolt Head and Start Point they have undergone severe metamorphism. Limestones are only poorly developed in the north, but in the south important masses occur, in the middle and at the base

of the upper subdivisions, about Plymouth, Torquay, Brixham and between Newton Abbot and Totnes. Fossil corals abound in these limestones, which are largely quarried and when polished are known as Devonshire marbles.

On the eastern side of the county is found an entirely different set of rocks which cover the older series and dip away from them gently towards the east. The lower and most westerly situated members of the younger rocks is a series of breccias, conglomerates, sandstones and marls which are probably of lower Bunter age, but by some geologists have been classed as Permian. These red rocks are beautifully exposed on the coast by Dawlish and Teignmouth, and they extend inland, producing a red soil, past Exeter and Tiverton. A long narrow strip of the same formation reaches out westward on the top of the Culm as far as Jacobstow. Farther east, the Bunter pebble beds are represented by the well-known pebble deposit of Budleigh Salterton, whence they are traceable inland towards Rockbeare. These are succeeded by the Keuper marls and sandstones, well exposed at Sidmouth, where the upper Greensand plateau is clearly seen to overlie them. The Greensand covers all the high ground northward from Sidmouth as far as the Blackdown Hills. At Beer Head and Axmouth the Chalk is seen, and at the latter place is a famous landing on the coast, caused by the springs which issue from the Greensand below the Chalk. The Lower Chalk at Beer has been mined for building stone and was formerly in considerable demand. At the extreme east of the county, Rhaetic and Lias beds make their appearance, the former with a "bone" bed bearing the remains of saurians and fish.

Dartmoor is a mass of granite that was intruded into the Culm and Devonian strata in post-Carboniferous times and subsequently exposed by denudation. Evidences of Devonian volcanic activity are abundant in the masses of diabase, dolerite, &c., at Bradford and Trusham, south of Exeter, around Plymouth and at Ashprington. Perhaps the most interesting is the Carboniferous volcano of Brent Tor near Tavistock. An Eocene deposit, the product of the denudation of the Dartmoor Hills, lies in a small basin at Bovey Tracey (see BOVEY BAYS); it yields beds of lignite and valuable clays.

Raised beaches occur at Hope's Nose and the Thatcher Stone near Torquay and at other points, and a submerged forest lies in the bay south of the same place. The caves and fissures in the Devonian limestone at Kent's Hole near Torquay, Brixham and Oreston are famous for the remains of extinct mammals; bones of the elephant, rhinoceros, bear and hyaena have been found as well as flint implements of early man.

Minerals.—Silver-lead was formerly worked at Combe Martin near the north coast, and elsewhere. Tin has been worked on Dartmoor (in stream works) from an unknown period. Copper was not much worked before the end of the 18th century. Tin occurs in the granite of Dartmoor, and along its borders, but rather where the Devonian than where the Carboniferous rocks border the granite. It is found most plentifully in the district which surrounds Tavistock, which, for tin and other ores, is in effect the great mining district of the county. Here, about 4 m. from Tavistock, are the Devon Great Consols mines, which from 1843 to 1871 were among the richest copper mines in the world, and by far the largest and most profitable in the kingdom. The divided profits during this period amounted to £1,102,960. But the mining interests of Devonshire are affected by the same causes, and in the same way, as those of Cornwall. The quantity of ore has greatly diminished, and the cost of raising it from the deep mines prevents competition with foreign markets. In many mines tin underlies the general depth of the copper, and is worked when the latter has been exhausted. The mineral products of the Tavistock district are various, and besides tin and copper, ores of zinc and iron are largely distributed. Great quantities of refined arsenic have been produced at the Devon Great Consols mine, by elimination from the iron pyrites contained in the various lodes. Manganese occurs in the neighbourhood of Exeter, in the valley of the Teign and in N. Devon; but the most profitable mines, which are shallow, are, like those of tin and copper, in the Tavistock district.

The other mineral productions of the county consist of marbles, building stones, slates and potters' clay. Among building stones, the granite of Dartmoor holds the foremost place. It is much quarried near Princetown, near Morcton Hampstead on the N.E. of Dartmoor and elsewhere. The annual export is considerable. Hard traps, which occur in many places, are also much used, as are the limestones of Buckfastleigh and of Plymouth. The Roborough stone, used from an early period in Devonshire churches, is found near Tavistock, and is a hard, porphyritic elvan, taking a fine polish. Excellent roofing slates occur in the Devonian series round the southern part of Dartmoor. The chief quarries are near Ashburton and Plymouth (Cann quarry). Potters' clay is worked at King's Teignton, whence it is largely exported; at Bovey Tracey; and at Watcombe near Torquay. The Watcombe clays is of the finest quality. China clay or kaolin is found on the southern side of Dartmoor, at Lee Moor, and near Trowlesworthy. There is a large deposit of amber close to Ashburton.

Climate and Agriculture.—The climate varies greatly in different parts of the county, but everywhere it is more humid

than that of the eastern or south-eastern parts of England. The mean annual temperature somewhat exceeds that of the midlands, but the average summer heat is rather less than that of the southern counties to the east. The air of the Dartmoor highlands is sharp and bracing. Mists are frequent, and snow often lies long. On the south coast frost is little known, and many half hardy plants, such as hydrangeas, myrtles, geraniums and heliotropes, live through the winter without protection. The climate of Sidmouth, Teignmouth, Torquay and other watering places on this coast is very equable, the mean temperature in January being 43.6° at Plymouth. The north coast, exposed to the storms and swell of the Atlantic, is more bracing; although there also, in the more sheltered nooks (as at Combe Martin), myrtles of great size and age flower freely, and produce their annual crop of berries.

Rather less than three-quarters of the total area of the county is under cultivation; the cultivated area falling a little below the average of the English counties. There are, however, about 160,000 acres of hill pasture in addition to the area in permanent pasture, which is more than one-half that of the cultivated area. The Devon breed of cattle is well adapted both for fattening and for dairy purposes; while sheep are kept in great numbers on the hill pastures. Devonshire is one of the chief cattle-farming and sheep-farming counties. It is specially famous for two products of the dairy—the clotted cream to which it gives its name, and junket. Of the area under grain crops, oats occupy about three times the acreage under wheat or barley. The bulk of the acreage under green crops is occupied by turnips, swedes and mangold. Orchards occupy a large acreage, and consist chiefly of apple-trees, nearly every farm maintaining one for the manufacture of cider.

Fisheries.—Though the fisheries of Devon are less valuable than those of Cornwall, large quantities of the pilchard and herrings caught in Cornish waters are landed at Plymouth. Much of the fishing is carried on within the three-mile limit; and it may be asserted that trawling is the main feature of the Devonshire industry, whereas seining and driving characterize that of Cornwall. Pilchard, cod, sprats, brill, plaice, soles, turbot, shrimps, lobsters, oysters and mussels are met with, besides herring and mackerel, which are fairly plentiful. After Plymouth, the principal fishing station is at Brixham, but there are lesser stations in every bay and estuary.

Other Industries.—The principal industrial works in the county are the various Government establishments at Plymouth and Devonport. Among other industries may be noted the lace-works at Tiverton; the manufacture of pillow-lace for which Honiton and its neighbourhood has long been famous; and the potteries and terra-cotta works of Bovey Tracey and Watcombe. Woollen goods and serges are made at Buckfastleigh and Ashburton, and boots and shoes at Crediton. Convict labour is employed in the direction of agriculture, quarrying, &c., in the great prison of Dartmoor.

Communications.—The main line of the Great Western railway, entering the county in the east from Taunton, runs to Exeter, skirts the coast as far as Teignmouth, and continues a short distance inland by Newton Abbot to Plymouth, after which it crosses the estuary of the Tamar by a great bridge to Saltash in Cornwall. Branches serve Torquay and other seaside resorts of the south coast; and among other branches are those from Taunton to Barnstaple and from Plymouth northward to Tavistock and Launceston. The main line of the London & South-Western railway between Exeter and Plymouth skirts the north and west of Dartmoor by Okehampton and Tavistock. A branch from Yeoford serves Barnstaple, Ilfracombe, Bideford and Torrington, while the Lynton & Barnstaple and the Bideford, Westward Ho & Appledore lines serve the districts indicated by their names. The branch line to Princetown from the Plymouth-Tavistock line of the Great Western company in part follows the line of a very early railway—that constructed to connect Plymouth with the Dartmoor prison in 1810-1825, which was worked with horse cars. The only waterways of any importance are the Tamar, which is navigable up to Gunnislake

(3 m. S.W. of Tavistock), and the Exeter ship canal, noteworthy as one of the oldest in England, for it was originally cut in the reign of Elizabeth.

Population and Administration.—The area of the ancient county is 1,667,154 acres, with a population in 1801 of 631,808, and 1901 of 661,314. The area of the administrative county is 1,671,168 acres. The county contains 33 hundreds. The municipal boroughs are Barnstaple (pop. 14,137), Bideford (8754), Dartmouth (6579), Devonport, a county borough (70,437), Exeter, a city and county borough (47,185), Torrington, officially Great Torrington (3241), Honiton (3271), Okehampton (2569), Plymouth, a county borough (107,636), South Molton (2848), Tiverton (10,382), Torquay (33,625), Totnes (4035). The other urban districts are Ashburton (2628), Bampton (1657), Brixham (6092), Buckfastleigh (2520), Budleigh Salterton (1883), Crediton (3974), Dawlish (4003), East Stonehouse (15,111), Exmouth (10,485), Heavitree (7520), Holsworthy (1371), Ilfracombe (8557), Ivy-bridge (1575), Kingsbridge (3025), Lynton (1641), Newton Abbot (12,517), Northam (5355), Ottery St Mary (3495), Paignton (8358), Salcombe (1710), Seaton (1325), Sidmouth (4201), Tavistock (4728), Teignmouth (8636). The county is in the western circuit, and assizes are held at Exeter. It has one court of quarter sessions, and is divided into twenty-four petty sessional divisions. The boroughs of Barnstaple, Bideford, Devonport, Exeter, Plymouth, South Molton, and Tiverton have separate commissions of the peace and courts of quarter sessions, and those of Dartmouth, Great Torrington, Torquay and Totnes have commissions of the peace only. There are 461 civil parishes. Devonshire is in the diocese of Exeter, with the exception of small parts in those of Salisbury and Truro; and there are 516 ecclesiastical parishes or districts wholly or in part within the county. The parliamentary divisions are the Eastern or Honiton, North-eastern or Tiverton, Northern or South Molton, North-western or Barnstaple, Western or Tavistock, Southern or Totnes, Torquay, and Mid or Ashburton, each returning one member; and the county also contains the parliamentary boroughs of Devonport and Plymouth, each returning two members, and that of Exeter, returning one member.

History.—The Saxon conquest of Devonshire must have begun some time before the 8th century, for in 700 there existed at Exeter a famous Saxon school. By this time, however, the Saxons had become Christians, and established their supremacy, not by destructive inroads, but by a gradual process of colonization, settling among the native Welsh and allowing them to hold lands under equal laws. The final incorporation of the district which is now Devonshire with the kingdom of Wessex must have taken place about 766, but the county, and even Exeter, remained partly Welsh until the time of Æthelstan. At the beginning of the 9th century Wessex was divided into definite *pagi*, probably corresponding to the later shires, and the Saxon Chronicle mentions Devonshire by name in 823, when a battle was fought between the Welsh in Cornwall and the people of Devonshire at Camelford. During the Danish invasions of the 9th century aldermen of Devon are frequently mentioned. In 851 the invaders were defeated by the fyrd and aldermen of Devon, and in 878, when the Danes under Hubba were harrying the coast with a squadron of twenty-three ships, they were again defeated with great slaughter by the fyrd. The modern hundreds of Devonshire correspond in position very nearly with those given in the Domesday Survey, though the names have in many cases been changed, owing generally to alterations in their places of meeting. The hundred of Bampton formerly included estates west of the Exe, now transferred to the hundred of Witheridge. Ten of the modern hundreds have been formed by the union of two or more Domesday hundreds, while the Domesday hundred of Liston has had the new hundred of Tavistock severed from it since 1114. Many of the hundreds were separated by tracts of waste and forest land, of which Devonshire contained a vast extent, until in 1204 the inhabitants paid 5000 marks to have the county disafforested, with the exception only of Dartmoor and Exmoor.

Devonshire in the 7th century formed part of the vast bishopric

of Dorchester-on-Thames. In 705 it was attached to the newly created diocese of Sherborne, and in 910 Archbishop Plegmund constituted Devonshire a separate diocese, and placed the see at Crediton. About 1030 the dioceses of Devonshire and Cornwall were united, and in 1049 the see was fixed at Exeter. The archdeacons of Exeter, Barnstaple and Totnes are all mentioned in the 12th century and formerly comprised twenty-four deaneries. The deaneries of Three Towns, Collumpton and Ottery have been created since the 16th century, while those of Tamerton, Dunkswell, Dunsford and Plymptre have been abolished, bringing the present number to twenty-three.

At the time of the Norman invasion Devonshire showed an active hostility to Harold, and the easy submission which it rendered to the Conqueror accounts for the exceptionally large number of Englishmen who are found retaining lands after the Conquest. The many vast fiefs held by Norman barons were known as honours, chief among them being Plympton, Okehampton, Barnstaple, Harberton and Totnes. The honour of Plympton was bestowed in the 12th century on the Redvers family, together with the earldom of Devon; in the 13th century it passed to the Courtenay family, who had already become possessed of the honour of Okehampton, and who in 1335 obtained the earldom. The dukedom of Exeter was bestowed in the 14th century on the Holland family, which became extinct in the reign of Edward IV. The ancestors of Sir Walter Raleigh, who was born at Budleigh, had long held considerable estates in the county.

Devonshire had an independent sheriff, the appointment being at first hereditary, but afterwards held for one year only. In 1320 complaint was made that all the hundreds of Devonshire were in the hands of the great lords, who did not appoint a sufficiency of bailiffs for their proper government. The miners of Devon had independent courts, known as stannary courts, for the regulation of mining affairs, the four stannary towns being Tavistock, Ashburton, Chagford, and Plympton. The ancient miners' parliament was held in the open air at Crockern's Tor.

The castles of Exeter and Plympton were held against Stephen by Baldwin de Redvers, and in the 14th and 15th centuries the French made frequent attacks on the Devonshire coast, being repulsed in 1404 by the people of Dartmouth. In the Wars of the Roses the county was much divided, and frequent skirmishes took place between the earl of Devon and Lord Bonville, the respective champions of the Lancastrian and Yorkist parties. Great disturbances in the county followed the Reformation of the 16th century and in 1549 a priest was compelled to say mass at Sampford Courtenay. On the outbreak of the Civil War the county as a whole favoured the parliament, but the prevailing desire was for peace, and in 1643 a treaty for the cessation of hostilities in Devonshire and Cornwall was agreed upon. Skirmishes, however, continued until the capture of Dartmouth and Exeter in 1646 put an end to the struggle. In 1688 the prince of Orange landed at Torbay and was entertained for several days at Ford and at Exeter.

The tin mines of Devon have been worked from time immemorial, and in the 14th century mines of tin, copper, lead, gold and silver are mentioned. Agriculturally the county was always poor, and before the disafforestation rendered especially so through the ravages committed by the herds of wild deer. At the time of the Domesday Survey the salt industry was important, and there were ninety-nine mills in the county and thirteen fisheries. From an early period the chief manufacture was that of woollen cloth, and a statute 4 Ed. IV. permitted the manufacture of cloths of a distinct make in certain parts of Devonshire. About 1505 Anthony Bonvis, an Italian, introduced an improved method of spinning into the county, and cider-making is mentioned in the 16th century. In 1680 the lace industry was already flourishing at Colyton and Ottery St Mary, and flax, hemp and malt were largely produced in the 17th and 18th centuries.

Devonshire returned two members to parliament in 1290, and in 1295 Barnstaple, Exeter, Plympton, Tavistock, Torrington and Totnes were also represented. In 1831 the county with its

boroughs returned a total of twenty-six members, but under the Reform Act of 1832 it returned four members in two divisions, and with ten boroughs was represented by a total of eighteen members. Under the act of 1868 the county returned six members in three divisions, and four of the boroughs were disfranchised, making a total of seventeen members.

Antiquities.—In primeval antiquities Devonshire is not so rich as Cornwall; but Dartmoor abounds in remains of the highest interest, the most peculiar of which are the long parallel alignments of upright stones, which, on a small scale, resemble those of Carnac in Brittany. On Dartmoor the lines are invariably straight, and are found in direct connexion with cairns, and with circles which are probably sepulchral. These stone avenues are very numerous. Of the so-called sacred circles the best examples are the "Longstones" on Scorhill Down, and the "Grey Wethers" under Sittaford Tor. By far the finest cromlech is the "Spinster's Rock" at Drewsteignton, a three-pillared cromlech which may well be compared with those of Cornwall. There are numerous menhirs or single upright stones; a large dolmen or holed stone lies in the bed of the Teign, near the Scorhill circle; and rock basins occur on the summit of nearly every tor on Dartmoor (the largest are on Kestor, and on Heltor, above the Teign). It is, however, tolerably evident that these have been produced by the gradual disintegration of the granite, and that the dolmen in the Teign is due to the action of the river. Clusters of hut foundations, circular, and formed of rude granite blocks, are frequent; the best example of such a primitive village is at Batworthy, near Chagford; the type resembles that of East Cornwall. Walled enclosures, or pounds, occur in many places; Grimspound is the most remarkable. Boundary lines, also called trackways, run across Dartmoor in many directions; and the rude bridges, formed of great slabs of granite, deserve notice. All these remains are on Dartmoor. Scattered over the county are numerous large hill castles and camps,—all earthworks, and all apparently of the British period. Roman relics have been found from time to time at Exeter (*Iscadammuniorum*), the only large Roman station in the county.

The churches are for the most part of the Perpendicular period, dating from the middle of the 14th to the end of the 15th century. Exeter cathedral is of course an exception, the whole (except the Norman towers) being very beautiful Decorated work. The special features of Devonshire churches, however, are the richly carved pulpits and chancel screens of wood, in which this county exceeded every other in England, with the exception of Norfolk and Suffolk. The designs are rich and varied, and the skill displayed often very great. Granite crosses are frequent, the finest and earliest being that of Copelstone, near Crediton. Monastic remains are scanty; the principal are those at Tor, Buckfast, Tavistock and Buckland Abbeys. Among domestic buildings the houses of Wear Gifford, Bradley and Dartington of the 15th century; Bradfield and Holcombe Rogus (Elizabethan), and Forde (Jacobean), deserve notice. The ruined castles of Okehampton (Edward I.), Exeter, with its vast British earthworks, Berry Pomeroy (Henry III., with ruins of a large Tudor mansion), Totnes (Henry III.), and Compton (early 15th century), are all interesting and picturesque.

AUTHORITIES.—T. Westcote, *Survey of Devon*, written about 1630, and first printed in 1845; J. Prince, *Worthies of Devon* (Exeter, 1701); Sir W. Pole, *Collections towards a History of the County of Devon* (London, 1791); R. Polwhele, *History of Devonshire* (3 vols. Exeter, 1797, 1798-1800); T. Moore, *History of Devon from the Earliest Period to the Present Time* (vols. i., ii., London, 1829-1831); G. Oliver, *Historic Collections relating to the Monasteries in Devon* (Exeter, 1820); D. and S. Lysons, *Magna Britannia* (vol. vi., London, 1822); *Ecclesiastical Antiquities in Devon* (Exeter, 1844); Mrs Bray, *Traditions of Devonshire*, in a series of letters to Robert Southey (London, 1838); G. C. Beaze, *Devonshire Bibliography* (London, 1883); Sir W. R. Drake, *Devonshire Notes and Notices* (London, 1888); S. Hewett, *Peasant Speech of Devon* (London, 1892); R. N. Worth, *History of Devonshire* (London, 1886, new edition, 1895); C. Worthy, *Devonshire Parishes* (Exeter, 1887); *Devonshire Wills* (London, 1896); *Victoria County History, Devonshire*.

DEVRIENT, the name of a family of German actors.

LUDWIG DEVRIENT (1784-1832), born in Berlin on the 15th of December 1784, was the son of a silk merchant. He was

apprenticed to an upholsterer, but, suddenly leaving his employment, joined a travelling theatrical company, and made his first appearance on the stage at Gera in 1804 as the messenger in Schiller's *Brant von Messina*. By the interest of Count Brühl, he appeared at Rudolstadt as Franz Moor in Schiller's *Räuber*, so successfully that he obtained a permanent engagement at the ducal theatre in Dessau, where he played until 1809. He then received a call to Breslau, where he remained for six years. So brilliant was his success in the title-parts of several of Shakespeare's plays, that Iffland began to fear for his own reputation; yet that great artist was generous enough to recommend the young actor as his only possible successor. On Iffland's death Devrient was summoned to Berlin, where he was for fifteen years the popular idol. He died there on the 30th of December 1831. Ludwig Devrient was equally great in comedy and tragedy. Falstaff, Franz Moor, Shylock, King Lear and Richard II. were among his best parts. Karl von Holtei in his *Reminiscences* has given a graphic picture of him and the "demonic fascination" of his acting.

See Z. Funck, *Aus dem Leben zweier Schauspieler, Ifflands und Devrients* (Leipzig, 1838); H. Smidt in *Devrient-Novellen* (3rd ed., Berlin, 1882); R. Springer in the novel *Devrient und Hoffmann* (Berlin, 1873); and Eduard Devrient's *Geschichte der deutschen Schauspielkunst* (Leipzig, 1861).

Three of the nephews of Ludwig Devrient, sons of his brother, a merchant, were also connected with the stage. KARL AUGUST DEVRIENT (1797-1872) was born at Berlin on the 5th of April 1797. After being for a short time in business, he entered a cavalry regiment as volunteer and fought at Waterloo. He then joined the stage, making his first appearance on the stage in 1819 at Brunswick. In 1821 he received an engagement at the court theatre in Dresden, where, in 1823, he married Wilhelmine Schröder (see SCHRÖDER-DEVRIENT). In 1835 he joined the company at Karlsruhe, and in 1839 that at Hanover. His best parts were Wallenstein and King Lear. He died on the 5th of April 1872. His brother PHILIPP EDUARD DEVRIENT (1801-1877), born at Berlin on the 11th of August 1801, was for a time an opera singer. Turning his attention to theatrical management, he was from 1844 to 1846 director of the court theatre in Dresden. Appointed to Karlsruhe in 1852, he began a thorough reorganization of the theatre, and in the course of seventeen years of assiduous labour, not only raised it to a high position, but enriched its repertory by many noteworthy librettos, among which *Die Kunst des Augenblicks* and *Verirrungen* are the best known. But his chief work is his history of the German stage—*Geschichte der deutschen Schauspielkunst* (Leipzig, 1848-1874). He died on the 4th of October 1877. A complete edition of his works—*Dramatische und dramaturgische Schriften*—was published in ten volumes (Leipzig, 1846-1873).

The youngest and the most famous of the three nephews of Ludwig Devrient was GUSTAV EMIL DEVRIENT (1803-1872), born at Berlin on the 4th of September 1803. He made his first appearance on the stage in 1821, at Brunswick, as Raoul in Schiller's *Jugfrau von Orleans*. After a short engagement in Leipzig, he received in 1829 a call to Hamburg, but after two years accepted a permanent appointment at the court theatre in Dresden, to which he belonged until his retirement in 1868. His chief characters were Hamlet, Uriel Acosta (in Karl Gutzkow's play), Marquis Posa (in Schiller's *Don Carlos*), and Goethe's Torquato Tasso. He acted several times in London, where his Hamlet was considered finer than Kemble's or Edmund Kean's. He died on the 7th of August 1872.

OTTO DEVRIENT (1838-1894), another actor, born in Berlin on the 3rd of October 1838, was the son of Philipp Eduard Devrient. He joined the stage in 1856 at Karlsruhe, and acted successively in Stuttgart, Berlin and Leipzig, until he received a fixed appointment at Karlsruhe, in 1863. In 1873 he became stage manager at Weimar, where he gained great praise for his *mise en scène* of Goethe's *Faust*. After being manager of the theatres in Magdeburg and Frankfurt he retired to Jena, where in 1883 he was given the honorary degree of doctor of philosophy. In 1884 he was appointed director of the court theatre in Oldenburg, and

in 1889 director of dramatic plays in Berlin. He died at Stettin on the 23rd of June 1894.

DEW. The word "dew" (O.E. *deaw*; cf. Ger. *Tau*) is a very ancient one and its meaning must therefore be defined on historical principles. According to the *New English Dictionary*, it means "the moisture deposited in minute drops upon any cool surface by condensation of the vapour of the atmosphere; formed after a hot day, during or towards night and plentiful in the early morning." Huxley in his *Physiography* makes the addition "without production of mist." The formation of mist is not necessary for the formation of dew, nor does it necessarily prevent it. If the deposit of moisture is in the form of ice instead of water it is called hoarfrost. The researches of Aitken suggest that the words "by condensation of the vapour in the atmosphere" might be omitted from the definition. He has given reasons for believing that the large dewdrops on the leaves of plants, the most characteristic of all the phenomena of dew, are to be accounted for, in large measure at least, by the exuding of drops of water from the plant through the pores of the leaves themselves. The formation of dewdrops in such cases is the continuation of the irrigation process of the plant for supplying the leaves with water from the soil. The process is set up in full vigour in the daytime to maintain tolerable thermal conditions at the surface of the leaf in the hot sun, and continued after the sun has gone.

On the other hand, the most typical physical experiment illustrating the formation of dew is the production of a deposit of moisture, in minute drops, upon the exterior surface of a glass or polished metal vessel by the cooling of a liquid contained in the vessel. If the liquid is water, it can be cooled by pieces of ice; if volatile like ether, by bubbling air through it. No deposit is formed by this process until the temperature is reduced to a point which, from that circumstance, has received a special name, although it depends upon the state of the air round the vessel. So generally accepted is the physical analogy between the natural formation of dew and its artificial production in the manner described, that the point below which the temperature of a surface must be reduced in order to obtain the deposit is known as the "dew-point."

In the view of physicists the dew-point is the temperature at which, by being cooled without change of pressure, the air becomes saturated with water vapour, not on account of any increase of supply of that compound, but by the diminution of the capacity of the air for holding it in the gaseous condition. Thus, when the dew-point temperature has been determined, the pressure of water vapour in the atmosphere at the time of the deposit is given by reference to a table of saturation pressures of water vapour at different temperatures. As it is a well-established proposition that the pressure of the water vapour in the air does not vary while the air is being cooled without change of its total external pressure, the saturation pressure at the dew-point gives the pressure of water vapour in the air when the cooling commenced. Thus the artificial formation of dew and consequent determination of the dew-point is a recognized method of measuring the pressure, and thence the amount of water vapour in the atmosphere. The dew-point method is indeed in some ways a fundamental method of hygrometry.

The dew-point is a matter of really vital consequence in the question of the oppressiveness of the atmosphere or its reverse. So long as the dew-point is low, high temperature does not matter, but when the dew-point begins to approach the normal temperature of the human body the atmosphere becomes insupportable.

The physical explanation of the formation of dew consists practically in determining the process or processes by which leaves, blades of grass, stones, and other objects in the open air upon which dew may be observed, become cooled "below the dew-point."

Formerly, from the time of Aristotle at least, dew was supposed to "fall." That view of the process was not extinct at the time of Wordsworth and poets might even now use the figure without reproach. To Dr Charles Wells of London belongs the credit of bringing to a focus the ideas which originated with the study of

radiation at the beginning of the 19th century, and which are expressed by saying that the cooling necessary to produce dew on exposed surfaces is to be attributed to the radiation from the surfaces to a clear sky. He gave an account of the theory of automatic cooling by radiation, which has found a place in all text-books of physics, in his first *Essay on Dew* published in 1818. The theory is supported in that and in a second essay by a number of well-planned observations, and the essays are indeed models of scientific method. The process of the formation of dew as represented by Wells is a simple one. It starts from the point of view that all bodies are constantly radiating heat, and cool automatically unless they receive a corresponding amount of heat from other bodies by radiation or conduction. Good radiators, which are at the same time bad conductors of heat, such as blades of grass, lose heat rapidly on a clear night by radiation to the sky and become cooled below the dew-point of the atmosphere.

The question was very fully studied by Melloni and others, but little more was added to the explanation given by Wells until 1885, when John Aitken of Falkirk called attention to the question whether the water of dewdrops on plants or stones came from the air or the earth, and described a number of experiments to show that under the conditions of observation in Scotland, it was the earth from which the moisture was probably obtained, either by the operation of the vascular system of plants in the formation of exuded dewdrops, or by evaporation and subsequent condensation in the lowest layer of the atmosphere. Some controversy was excited by the publication of Aitken's views, and it is interesting to revert to it because it illustrates a proposition which is of general application in meteorological questions, namely, that the physical processes operative in the evolution of meteorological phenomena are generally complex. It is not radiation alone that is necessary to produce dew, nor even radiation from a body which does not conduct heat. The body must be surrounded by an atmosphere so fully supplied with moisture that the dew-point can be passed by the cooling due to radiation. Thus the conditions favourable for the formation of dew are (1) a good radiating surface, (2) a still atmosphere, (3) a clear sky, (4) thermal insulation of the radiating surface, (5) warm moist ground or some other provision to produce a supply of moisture in the surface layers of air.

Aitken's contribution to the theory of dew shows that in considering the supply of moisture we must take into consideration the ground as well as the air and concern ourselves with the temperature of both. Of the five conditions mentioned, the first four may be considered necessary, but the fifth is very important for securing a copious deposit. It can hardly be maintained that no dew could form unless there were a supply of water by evaporation from warm ground, but, when such a supply is forthcoming, it is evident that in place of the limited process of condensation which deprives the air of its moisture and is therefore soon terminable, we have the process of distillation which goes on as long as conditions are maintained. This distinction is of some practical importance for it indicates the protecting power of wet soil in favour of young plants as against night frost. If distillation between the ground and the leaves is set up, the temperature of the leaves cannot fall much below the original dew-point because the supply of water for condensation is kept up; but if the compensation for loss of heat by radiation is dependent simply on the condensation of water from the atmosphere, without renewal of the supply, the dew-point will gradually get lower as the moisture is deposited and the process of cooling will go on.

In these questions we have to deal with comparatively large changes taking place within a small range of level. It is with the layer a few inches thick on either side of the surface that we are principally concerned, and for an adequate comprehension of the conditions close consideration is required. To illustrate this point reference may be made to figs. 1 and 2, which represent the condition of affairs at 10.40 P.M. on about the 20th of October 1885, according to observations by Aitken. Vertical distances represent heights in feet, while the temperatures of the air and

the dew-point are represented by horizontal distances and their variations with height by the curved lines of the diagram. The line marked *o* is the ground level itself, a rather indefinite quantity when the surface is grass. The whole vertical distance represented is from 4 ft. above ground to 1 ft. below ground, and the special phenomena which we are considering take place in the layer which represents the rapid transition between the temperature of the ground 3 in. below the surface and that of the air a few inches above ground.

The point of interest is to determine where the dew-point curve and dry-bulb curve will cut.

If they cut above the surface, mist will result; if they cut at the surface, dew will be formed. Below the surface, it may be assumed that the air is saturated with moisture and any difference in temperature of the dew-point is accompanied by distillation. It may be remarked, by the way, that such distillation between soil layers of different temperatures must be productive of the transference of large quantities of water between different levels in the soil either upward or downward according to the time of year.

These diagrams illustrate the importance of the warmth and moisture of the ground in the phenomena which have been considered. From the surface there is a continual loss of heat going on by radiation and a continual supply of warmth and moisture from below. But while the heat can escape, the moisture cannot. Thus the dry-bulb line is deflected to the left as it approaches the surface, the dew-point line to the right. Thus the effect of the moisture of the ground is to cause the lines to approach. In the case of grass, fig. 2, the deviation of the dry-bulb line to the left to form a sharp minimum of temperature at the surface is well shown. The dew-point line is also shown diverted to the left to the same point as the dry-bulb; but that could only happen if there were so copious a condensation from the atmosphere as actually to make the air drier at the surface than up above. In diagram 1, for soil, the effect on air temperature and moisture is shown; the two lines converge to cut at the surface where a dew deposit will be formed. Along the underground line there must be a gradual creeping of heat and moisture towards the surface by distillation, the more rapid the greater the temperature gradient.

The amount of dew deposited is considerable, and, in tropical countries, is sometimes sufficiently heavy to be collected by gutters and spouts, but it is not generally regarded as a large percentage of the total rainfall. Loesch estimates the amount of dew for a single night on the Loango coast at 3 mm., but the estimate seems a high one. Measurements go to show that the depth of water corresponding with the aggregate annual deposit of dew is 1 in. to 1.5 in. near London (G. Dines), 1.2 in. at Munich (Wollny), 0.3 in. at Montpellier (Crova), 1.6 in. at Tenbury, Worcestershire (Badgley).

With the question of the amount of water collected as dew, that of the maintenance of "dew ponds" is intimately associated. The name is given to certain isolated ponds on the upper levels of the chalk downs of the south of England and elsewhere. Some of these ponds are very ancient, as the title of a work on *Natural Dewponds* by A. J. and G. Hubbard indicates. Their name seems to imply the hypothesis that they depend upon dew and not entirely upon rain for their maintenance as a source of water supply for cattle, for which they are used. The question has been discussed a good deal, but not settled; the balance of evidence seems to be against the view that dew deposits make any important contribution to the supply of water. The construction of dew ponds is, however, still practised on traditional lines, and it is said that a new dew pond has first to be filled artificially.

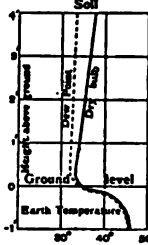

FIG. 1.

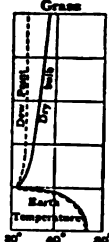

FIG. 2.

It does not come into existence by the gradual accumulation of water in an impervious basin.

AUTHORITIES.—For *Dew*, see the two essays by Dr Charles Wells (London, 1818), also "An Essay on Dew," edited by Casella (London, 1866), Longmans, with additions by Strachan; Melloni, *Pogg. Ann.* lxxi. pp. 416, 424, and lxxiii. p. 467; Jamini; Compléments à la théorie de la rosée," *Journal de physique*, viii. p. 41; J. Aitken, on "Dew," *Trans. Roy. Soc. of Edinburgh*, xxxiii., part i. 2, and "Nature," vol. xxxiii. p. 256; C. Tomlinson, "Remarks on a new Theory of Dew," *Phil. Mag.* (1866), 5th series, vol. 21, p. 483 and vol. 22, p. 270; Russell, *Nature*, vol. 47, p. 210; also *Met. Zeit.* (1893), p. 390; Hömén, *Bodenphysikalische und meteorologische Beobachtungen* (Berlin, 1894), iii.; *Taubbildung*, p. 88, &c.; Rubenson, "Die Temperatur- und Feuchtigkeitsverhältnisse in den unteren Luftschichten bei der Taubildung," *Met. Zeit.* xi. (1876), p. 65; H. E. Hamburg, "Température et humidité de l'air à différentes hauteurs à Upsal," *Soc. R. des sciences d'Upsal* (1876); review in *Met. Zeit.* xii. (1877), p. 105.

For *Dew Ponds*, see Stephen Hales, *Statical Essays*, vol. i., experiment six., pp. 52-57 (2nd ed., London, 1731); Gilbert White, *Natural History and Antiquities of Selborne*, letter xxix. (London, 1789); Dr C. Wells, *An Essay on Dew* (London, 1818, 1821, and 1866); Rev. J. C. Clutterbuck, "Prize Essay on Water Supply," *Journ. Roy. Agric. Soc.*, 2nd series, vol. i., pp. 271-287 (1865); Field and Symons, "Evaporation from the Surface of Water," *Brit. Assoc. Rep.* (1869), sect. pp. 25, 26; J. Lucas, "Hydrogeology: One of the Developments of Modern Practical Geology," *Trans. Inst. Surveyors*, vol. ix. pp. 153-232 (1877); H. P. Slade, "A Short Practical Treatise on Dew Ponds" (London, 1877); Clement Reid, "The Natural History of Isolated Ponds," *Trans. Norfolk and Norwich Naturalists' Society*, vol. v. pp. 272-286 (1892); Professor G. S. Brady, *On the Nature and Origin of Freshwater Faunas* (1899); Professor L. C. Miall, "Dew Ponds," *Reports of the British Association* (Bradford Meeting, 1900), pp. 579-585; A. J. and G. Hubbard, "Neolithic Dewponds and Cattle-Ways" (London, 1904, 1907). (W. N. S.)

DEWAN or **DIWAN**, an Oriental term for finance minister. The word is derived from the Arabian *diwan*, and is commonly used in India to denote a minister of the Mogul government, or in modern days the prime minister of a native state. It was in the former sense that the grant of the *dewanny* to the East India Company in 1765 became the foundation of the British empire in India.

DEWAR, SIR JAMES (1842-), British chemist and physicist, was born at Kincardine-on-Forth, Scotland, on the 20th of September 1842. He was educated at Dollar Academy and Edinburgh University, being at the latter first a pupil, and afterwards the assistant, of Lord Playfair, then professor of chemistry; he also studied under Kekulé at Ghent. In 1875 he was elected Jacksonian professor of natural experimental philosophy at Cambridge, becoming a fellow of Peterhouse, and in 1877 he succeeded Dr J. H. Gladstone as Fullerian professor of chemistry in the Royal Institution, London. He was president of the Chemical Society in 1897, and of the British Association in 1902, served on the Balfour Commission on London Water Supply (1893-1894), and as a member of the Committee on Explosives (1888-1891) invented cordite jointly with Sir Frederick Abel. His scientific work covers a wide field. Of his earlier papers, some deal with questions of organic chemistry, others with Graham's hydrogenium and its physical constants, others with high temperatures, e.g. the temperature of the sun and of the electric spark, others again with electro-photometry and the chemistry of the electric arc. With Professor J. G. M'Kendrick, of Glasgow, he investigated the physiological action of light, and examined the changes which take place in the electrical condition of the retina under its influence. With Professor G. D. Livinge, one of his colleagues at Cambridge, he began in 1878 a long series of spectroscopic observations, the later of which were devoted to the spectroscopic examination of various gaseous constituents separated from atmospheric air by the aid of low temperatures; and he was joined by Professor J. A. Fleming, of University College, London, in the investigation of the electrical behaviour of substances cooled to very low temperatures. His name is most widely known in connexion with his work on the liquefaction of the so-called permanent gases and his researches at temperatures approaching the zero of absolute temperature. His interest in this branch of inquiry dates back at least as far as 1874, when he discussed the "Latent Heat of Liquid Gases" before the British Association. In 1878

he devoted a Friday evening lecture at the Royal Institution to the then recent work of L. P. Cailletet and R. P. Pictet, and exhibited for the first time in Great Britain the working of the Cailletet apparatus. Six years later, in the same place, he described the researches of Z. F. Wroblewski and K. S. Olszewski, and illustrated for the first time in public the liquefaction of oxygen and air, by means of apparatus specially designed for optical projection so that the actions taking place might be visible to the audience. Soon afterwards he constructed a machine from which the liquefied gas could be drawn off through a valve for use as a cooling agent, and he showed its employment for this purpose in connexion with some researches on meteorites; about the same time he also obtained oxygen in the solid state. By 1891 he had designed and erected at the Royal Institution an apparatus which yielded liquid oxygen by the pint, and towards the end of that year he showed that both liquid oxygen and liquid ozone are strongly attracted by a magnet. About 1892 the idea occurred to him of using vacuum-jacketed vessels for the storage of liquid gases, and so efficient did this device prove in preventing the influx of external heat that it is found possible not only to preserve the liquids for comparatively long periods, but also to keep them so free from ebullition that examination of their optical properties becomes possible. He next experimented with a high-pressure hydrogen jet by which low temperatures were realized through the Thomson-Joule effect, and the successful results thus obtained led him to build at the Royal Institution the large refrigerating machine by which in 1898 hydrogen was for the first time collected in the liquid state, its solidification following in 1899. Later he investigated the gas-absorbing powers of charcoal when cooled to low temperatures, and applied them to the production of high vacua and to gas analysis (see LIQUID GASES). The Royal Society in 1894 bestowed the Rumford medal upon him for his work in the production of low temperatures, and in 1899 he became the first recipient of the Hodgkins gold medal of the Smithsonian Institution, Washington, for his contributions to our knowledge of the nature and properties of atmospheric air. In 1904 he was the first British subject to receive the Lavoisier medal of the French Academy of Sciences, and in 1906 he was the first to be awarded the Matteucci medal of the Italian Society of Sciences. He was knighted in 1904, and in 1908 he was awarded the Albert medal of the Society of Arts.

DEWAS, two native states of India, in the Malwa Political Charge of Central India, founded in the first half of the 18th century by two brothers, Punwar Maharrats, who came into Malwa with the peshwa, Baji Rao, in 1728. Their descendants are known as the senior and junior branches of the family, and since 1841 each has ruled his own portion as a separate state, though the lands belonging to each are so intimately entangled, that even in Dewas, the capital town, the two sides of the main street are under different administrations and have different arrangements for water supply and lighting. The senior branch has an area of 446 sq. m. and a population of 62,312, while the area of the junior branch is 440 sq. m. and its population 54,904.

DEWBERRY, *Rubus coesius*, a trailing plant, allied to the bramble, of the natural order Rosaceae. It is common in woods, hedges and the borders of fields in England and other countries of Europe. The leaves have three leaflets, are hairy beneath, and of a dusky green; the flowers which appear in June and July are white, or pale rose-coloured. The fruit is large, and closely embraced by the calyx, and consists of a few drupules, which are black, with a glaucous bloom; it has an agreeable acid taste.

DEW-CLAW, the rudimentary toes, two in number, or the "false hoof" of the deer, sometimes also called the "nails." In dogs the dew-claw is the rudimentary toe or hallux (corresponding to the big toe in man) hanging loosely attached to the skin, low down on the hinder part of the leg. The origin of the word is unknown, but it has been fancifully suggested that, while the other toes touch the ground in walking, the dew-claw merely brushes the dew from the grass.

D'EWES, SIR SIMONDS, Bart. (1602-1650), English antiquarian, eldest son of Paul D'Ewes of Milden, Suffolk, and of

Cecilia, daughter and heir of Richard Simonds, of Coaxdon or Coxden, Dorsetshire, was born on the 18th of December 1602, and educated at the grammar school of Bury St Edmunds, and at St John's College, Cambridge. He had been admitted to the Middle Temple in 1611, and was called to the bar in 1623, when he immediately began his collections of material and his studies in history and antiquities. In 1626 he married Anne, daughter and heir of Sir William Clopton, of Luton's Hall in Suffolk, through whom he obtained a large addition to his already considerable fortune. On the 6th of December he was knighted. He took an active part as a strong Puritan and member of the moderate party in the opposition to the king's arbitrary government in the Long Parliament of 1640, in which he sat as member for Sudbury. On the 15th of July he was created a baronet by the king, but nevertheless adhered to the parliamentary party when war broke out, and in 1643 took the Covenant. He was one of the members expelled by Pride's Purge in 1648, and died on the 18th of April 1650. He had married secondly Elizabeth, daughter of Sir Henry Willoughby, Bart., of Risley in Derbyshire, by whom he had a son, who succeeded to his estates and title, the latter becoming extinct on the failure of male issue in 1731. D'Ewes appears to have projected a work of very ambitious scope, no less than the whole history of England based on original documents. But though excelling as a collector of materials, and as a laborious, conscientious and accurate transcriber, he had little power of generalization or construction, and died without publishing anything except an uninteresting tract, *The Primitive Practice for Preserving Truth* (1645), and some speeches. His *Journals of all the Parliaments during the Reign of Queen Elizabeth*, however, a valuable work, was published in 1682. His large collections, including transcripts from ancient records, many of the originals of which are now dispersed or destroyed, are in the Harleian collection in the British Museum. His unprinted Diaries from 1621-1624 and from 1643-1647, the latter valuable for the notes of proceedings in parliament, are often the only authority for incidents and speeches during that period, and are amusing from the glimpses the diarist affords of his own character, his good estimation of himself and his little jealousies; some are in a cipher and some in Latin.

Extracts from his *Autobiography and Correspondence* from the MSS. in the British Museum were published by J. O. Halliwell-Phillips in 1845, by Hearne in the appendix to his *Historia vias et regni Ricardi II.* (1720), and in the *Bibliotheca topographica Britannica*, No. xv. vol. vi. (1783); and from a Diary of later date, *College Life in the Time of James I.* (1851). His Diaries have been extensively drawn upon by Forster, Gardiner, and by Sanford in his *Studies of the Great Rebellion*. Some of his speeches have been reprinted in the Harleian Miscellany and in the Somers Tracts.

DE WET, CHRISTIAN (1854-), Boer general and politician, was born on the 7th of October 1854 at Leeuwkop, Smithfield district (Orange Free State), and later resided at Dewetsdorp. He served in the first Anglo-Boer War of 1880-81 as a field cornet, and from 1881 to 1896 he lived on his farm, becoming in 1897 member of the Volksraad. He took part in the earlier battles of the Boer War of 1899 in Natal as a commandant and later, as a general, he went to serve under Cronje in the west. His first successful action was the surprise of Sanna's Post near Bloemfontein, which was followed by the victory of Reddersburg a little later. Thereafterward he came to be regarded more and more as the most formidable leader of the Boers in their guerrilla warfare. Sometimes severely handled by the British, sometimes escaping only by the narrowest margin of safety from the columns which attempted to surround him, and falling upon and annihilating isolated British posts, De Wet continued to the end of the war his successful career, striking heavily where he could do so and skillfully evading every attempt to bring him to bay. He took an active part in the peace negotiations of 1902, and at the conclusion of the war he visited Europe with the other Boer generals. While in England the generals sought, unavailingly, a modification of the terms of peace concluded at Pretoria. De Wet wrote an account of his campaigns, an English version of which appeared in November 1902 under the title *Three Years' War*. In November, 1907 he was elected a member of the first parliament of the

Orange River Colony and was appointed minister of agriculture. In 1908-9 he was a delegate to the Closer Union Convention.

DE WETTE, WILHELM MARTIN LEBERRECHT (1780-1849), German theologian, was born on the 12th of January 1780, at Ulla, near Weimar, where his father was pastor. He was sent to the gymnasium at Weimar, then at the height of its literary glory. Here he was much influenced by intercourse with Johann Gottfried Herder, who frequently examined at the school. In 1799 he entered on his theological studies at Jena, his principal teachers being J. J. Griesbach and H. E. G. Paulus, from the latter of whom he derived his tendency to free critical inquiry. Both in methods and in results, however, he occupied an almost solitary position among German theologians. Having taken his doctor's degree, he became *privat-docent* at Jena; in 1807 professor of theology at Heidelberg, where he came under the influence of J. F. Fries (1773-1843); and in 1810 was transferred to a similar chair in the newly founded university of Berlin, where he enjoyed the friendship of Schleiermacher. He was, however, dismissed from Berlin in 1810 on account of his having written a letter of consolation to the mother of Karl Ludwig Sand, the murderer of Kotzebue. A petition in his favour presented by the senate of the university was unsuccessful, and a decree was issued not only depriving him of the chair, but banishing him from the Prussian kingdom. He retired for a time to Weimar, where he occupied his leisure in the preparation of his edition of Luther, and in writing the romance *Theodor oder die Weihe des Zucifers* (Berlin, 1822), in which he describes the education of an evangelical pastor. During this period he made his first essay in preaching, and proved himself to be possessed of very popular gifts. But in 1822 he accepted the chair of theology in the university of Basel, which had been reorganized four years before. Though his appointment had been strongly opposed by the orthodox party, De Wette soon won for himself great influence both in the university and among the people generally. He was admitted a citizen, and became rector of the university, which owed to him much of its recovered strength, particularly in the theological faculty. He died on the 16th of June 1849.

De Wette has been described by Julius Wellhausen as "the epoch-making opener of the historical criticism of the Pentateuch." He prepared the way for the Supplement-theory. But he also made valuable contributions to other branches of theology. He had, moreover, considerable poetic faculty, and wrote a drama in three acts, entitled *Die Entsagung* (Berlin, 1823). He had an intelligent interest in art, and studied ecclesiastical music and architecture. As a Biblical critic he is sometimes classed with the destructive school, but, as Otto Pfeiderer says (*Development of Theology*, p. 102), he "occupied as free a position as the Rationalists with regard to the literal authority of the creeds of the church, but that he sought to give their due value to the religious feelings, which the Rationalists had not done, and, with a more unfettered mind towards history, to maintain the connexion of the present life of the church with the past." His works are marked by exergetical skill, unusual power of condensation and uniform fairness. Accordingly they possess value which is little affected by the progress of criticism.

The most important of his works are:—*Beiträge zur Einleitung in das Alte Testament* (2 vols., 1806-1807); *Kommentar über die Psalmen* (1811), which has passed through several editions, and is still regarded as of high authority; *Lehrbuch der hebräisch-jüdischen Archäologie* (1814); *Über Religion und Theologie* (1815); a work of great importance as showing its author's general theological position; *Lehrbuch der christlichen Dogmatik* (1817-1816); *Lehrbuch der historisch-kritischen Einleitung in die Bibel* (1817); *Christliche Sittenlehre* (1819-1821); *Einleitung in das Neue Testament* (1826); *Religion, ihr Wesen, ihre Erscheinungsform, und ihr Einfluss auf das Leben* (1827); *Das Wesen des christlichen Glaubens* (1846); and *Kurzgefasstes exegetisches Handbuch zum Neuen Testament* (1836-1848).

De Wette also edited Luther's works (5 vols., 1825-1828). See K. R. Hagenbach in *Herzog's Realencyclopädie*; G. C. F. Lucke's *W. M. L. De Wette, zur freundschaftlicher Erinnerung* (1850); and D. Schenkel's *W. M. L. De Wette und die Bedeutung seiner Theologie für unsere Zeit* (1849). Rudolf Stehelin, *De Wette nach seiner theol. Wirksamkeit und Bedeutung* (1880); F. Lichtenberger, *History of German Theology in the Nineteenth Century* (1889); Otto Pfeiderer, *Development of Theology* (1890), pp. 97 ff.; T. K. Cheyne, *Founders of the Old Testament Criticism*, pp. 31 ff.

DEWEY, DAVIS RICH (1858—), American economist and statistician, was born at Burlington, Vermont, U.S.A., on the 7th of April 1858. He was educated at the university of Vermont and at Johns Hopkins University, and afterwards became professor of economics and statistics at the Massachusetts Institute of Technology. He was chairman of the state board on the question of the unemployed (1895), member of the Massachusetts commission on public, charitable and reformatory interests (1897), special expert agent on wages for the 12th census, and member of a state commission (1904) on industrial relations. He wrote an excellent *Syllabus on Political History since 1815* (1887), a *Financial History of the U.S.* (1902), and *National Problems* (1907).

DEWEY, GEORGE (1837—), American naval officer, was born at Montpelier, Vermont, on the 26th of December 1837. He studied at Norwich University, then at Norwich, Vermont, and graduated at the United States Naval Academy in 1858. He was commissioned lieutenant in April 1861, and in the Civil War served on the steamship "Mississippi" (1861-1863) during Farragut's passage of the forts below New Orleans in April 1862, and at Port Hudson in March 1863; took part in the fighting below Donaldsonville, Louisiana, in July 1863; and in 1864-1865 served on the steam-gunboat "Agawam" with the North Atlantic blockading squadron and took part in the attacks on Fort Fisher in December 1864, and January 1865. In March 1865 he became a lieutenant-commander. He was with the European squadron in 1866-1867; was an instructor in the United States Naval Academy in 1868-1869; was in command of the "Naragansett" in 1870-1871 and 1872-1875, being commissioned commander in 1872; was light-house inspector in 1876-1877; and was secretary of the light-house board in 1877-1882. In 1884 he became a captain; in 1889-1893 was chief of the bureau of equipment and recruiting; in 1893-1895 was a member of the light-house board; and in 1895-1897 was president of the board of inspection and survey, being promoted to the rank of commodore in February 1896. In November 1897 he was assigned, at his own request, to sea service, and sent to Asiatic waters. In April 1898, while with his fleet at Hong Kong, he was notified by cable that war had begun between the United States and Spain, and was ordered to "capture or destroy the Spanish fleet" then in Philippine waters. On the 1st of May he overwhelmingly defeated the Spanish fleet under Admiral Montojo in Manila Bay, a victory won without the loss of a man on the American ships (see SPANISH-AMERICAN WAR). Congress, in a joint resolution, tendered its thanks to Commodore Dewey, and to the officers and men under his command, and authorized "the secretary of the navy to present a sword of honor to Commodore George Dewey, and cause to be struck bronze medals commemorating the battle of Manila Bay, and to distribute such medals to the officers and men of the ships of the Asiatic squadron of the United States." He was promoted rear-admiral on the 10th of May 1898. On the 18th of August his squadron assisted in the capture of the city of Manila. After remaining in the Philippines under orders from his government to maintain control, Dewey received the rank of admiral (March 3, 1899)—that title, formerly borne only by Farragut and Porter, having been revived by act of Congress (March 2, 1899),—and returned home, arriving in New York City, where, on the 3rd of October 1899, he received a great ovation. He was a member (1899) of the Schurman Philippine Commission, and in 1899 and 1900 was spoken of as a possible Democratic candidate for the presidency. He acted as president of the Schley court of inquiry in 1901, and submitted a minority report on a few details.

DEWEY, MELVILLE (1851—), American librarian, was born at Adams Center, New York, on the 10th of December 1851. He graduated in 1874 at Amherst College, where he was assistant librarian from 1874 to 1877. In 1877 he removed to Boston, where he founded and became editor of *The Library Journal*, which became an influential factor in the development of libraries in America, and in the reform of their administration. He was also one of the founders of the American Library Association, of which he was secretary from 1876 to 1891, and president in 1891 and 1893. In 1883 he became librarian of Columbia

College, and in the following year founded there the School of Library Economy, the first institution for the instruction of librarians ever organized. This school, which was very successful, was removed to Albany in 1890, where it was re-established as the State Library School under his direction; from 1888 to 1906 he was director of the New York State Library and from 1888 to 1900 was secretary of the University of the State of New York, completely reorganizing the state library, which he made one of the most efficient in America, and establishing the system of state travelling libraries and picture collections. His "Decimal System of Classification" for library cataloguing, first proposed in 1876, is extensively used.

DEWING, THOMAS WILMER (1851—), American figure painter, was born in Boston, Massachusetts, on the 4th of May 1851. He was a pupil of Jules Lefebvre in Paris from 1876 to 1879; was elected a full member of the National Academy of Design in 1888; was a member of the society of Ten American Painters, New York; and received medals at the Paris Exhibition (1889), at Chicago (1893), at Buffalo (1901) and at St Louis (1904). His decorative genre pictures are notable for delicacy and finish. Among his portraits are those of Mrs Stanford White and of his own wife. Mrs Dewing (b. 1855), née Maria Oakey, a figure and flower painter, was a pupil of John La Farge in New York, and of Couture in Paris.

DE WINT, PETER (1784-1840), English landscape painter, of Dutch extraction, son of an English physician, was born at Stone, Staffordshire, on the 21st of January 1784. He studied art in London, and in 1809 entered the Academy schools. In 1812 he became a member of the Society of Painters in Water-colours, where he exhibited largely for many years, as well as at the Academy. He married in 1810 the sister of William Hilton, R.A. He died in London on the 30th of January 1840. De Wint's life was devoted to art; he painted admirably in oils, and he ranks as one of the chief English water-colourists. A number of his pictures are in the National Gallery and the Victoria and Albert Museum.

DE WINTER, JAN WILLEM (1750-1812), Dutch admiral, was born at Kampen, and in 1767 entered the naval service at the age of twelve years. He distinguished himself by his zeal and courage, and at the revolution of 1787 he had reached the rank of lieutenant. The overthrow of the "patriot" party forced him to fly for his safety to France. Here he threw himself heart and soul into the cause of the Revolution, and took part under Dumouriez and Pichegru in the campaigns of 1792 and 1793, and was soon promoted to the rank of brigadier-general. When Pichegru in 1795 overran Holland, De Winter returned with the French army to his native country. The states-general now utilized the experience he had gained as a naval officer by giving him the post of adjunct-general for the reorganization of the Dutch navy. In 1796 he was appointed vice-admiral and commander-in-chief of the fleet. He spared no efforts to strengthen it and improve its condition, and on the 11th of October 1797 he ventured upon an encounter off Camperdown with the British fleet under Admiral Duncan. After an obstinate struggle the Dutch were defeated, and De Winter himself was taken prisoner. He remained in England until December, when he was liberated by exchange. His conduct in the battle of Camperdown was declared by a court-martial to have nobly maintained the honour of the Dutch flag.

From 1798 to 1802 De Winter filled the post of ambassador to the French republic, and was then once more appointed commander of the fleet. He was sent with a strong squadron to the Mediterranean to repress the Tripoli piracies, and negotiated a treaty of peace with the Tripolitan government. He enjoyed the confidence of Louis Bonaparte, when king of Holland, and, after the incorporation of the Netherlands in the French empire, in an equal degree of the emperor Napoleon. By the former he was created marshal and count of Huesen, and given the command of the armed forces both by sea and land. Napoleon gave him the grand cross of the Legion of Honour and appointed him inspector-general of the northern coasts, and in 1811 he placed him at the head of the fleet he had collected at the Texel. Soon afterwards

De Winter was seized with illness and compelled to betake himself to Paris, where he died on the 2nd of June 1812. He had a splendid public funeral and was buried in the Pantheon. His heart was enclosed in an urn and placed in the Nicolaas Kerk at Kampen.

DE WITT, CORNELIUS (1623-1672), brother of John de Witt (q.v.), was born at Dort in 1623. In 1650 he became burgo-master of Dort and member of the states of Holland and West Friesland. He was afterwards appointed to the important post of *swaard* or governor of the land of Putten and bailiff of Beierland. He associated himself closely with his greater brother, the grand pensionary, and supported him throughout his career with great ability and vigour. In 1667 he was the deputy chosen by the states of Holland to accompany Admiral de Ruyter in his famous expedition to Chatham. Cornelius de Witt on this occasion distinguished himself greatly by his coolness and intrepidity. He again accompanied De Ruyter in 1672 and took an honourable part in the great naval fight at Sole Bay against the united English and French fleets. Compelled by illness to leave the fleet, he found on his return to Dort that the Orange party were in the ascendant, and he and his brother were the objects of popular suspicion and hatred. An account of his imprisonment, trial and death, is given below.

DE WITT, JOHN (1625-1672), Dutch statesman, was born at Dort, on the 24th of September 1625. He was a member of one of the old burgher-regent families of his native town. His father, Jacob de Witt, was six times burgo-master of Dort, and for many years sat as a representative of the town in the states of Holland. He was a strenuous adherent of the republican or oligarchical states-right party in opposition to the princes of the house of Orange, who represented the federal principle and had the support of the masses of the people. John was educated at Leiden, and early displayed remarkable talents, more especially in mathematics and jurisprudence. In 1645 he and his elder brother Cornelius visited France, Italy, Switzerland and England, and on his return he took up his residence at the Hague, as an advocate. In 1650 he was appointed pensionary of Dort, an office which made him the leader and spokesman of the town's deputation in the state of Holland. In this same year the states of Holland found themselves engaged in a struggle for provincial supremacy, on the question of the disbanding of troops, with the youthful prince of Orange, William II. William, with the support of the states-general and the army, seized five of the leaders of the states-right party and imprisoned them in Loevestein castle; among these was Jacob de Witt. The sudden death of William, at the moment when he had crushed opposition, led to a reaction. He left only a posthumous child, afterwards William III. of Orange, and the principles advocated by Jacob de Witt triumphed, and the authority of the states of Holland became predominant in the republic.

At this time of constitutional crisis such were the eloquence, sagacity and business talents exhibited by the youthful pensionary of Dort that on the 23rd of July 1653 he was appointed to the office of grand pensionary (*Raadpensionaris*) of Holland at the age of twenty-eight. He was re-elected in 1658, 1663 and 1668, and held office until his death in 1672. During this period of nineteen years the general conduct of public affairs and administration, and especially of foreign affairs, such was the confidence inspired by his talents and industry, was largely placed in his hands. He found in 1653 his country brought to the brink of ruin through the war with England, which had been caused by the keen commercial rivalry of the two maritime states. The Dutch were unprepared, and suffered severely through the loss of their carrying trade, and De Witt resolved to bring about peace as soon as possible. The first demands of Cromwell were impossible, for they aimed at the absorption of the two republics into a single state, but at last in the autumn of 1654 peace was concluded, by which the Dutch made large concessions and agreed to the striking of the flag to English ships in the narrow seas. The treaty included a secret article, which the states-general refused to entertain, but which De Witt succeeded in inducing the states of Holland to accept, by which the provinces of Holland pledged

themselves not to elect a stadtholder or a captain-general of the union. This Act of Seclusion, as it was called, was aimed at the young prince of Orange, whose close relationship to the Stuarts made him an object of suspicion to the Protector. De Witt was personally favourable to this exclusion of William III. from his ancestral dignities, but there is no truth in the suggestion that he prompted the action of Cromwell in this matter.

The policy of De Witt after the peace of 1654 was eminently successful. He restored the finances of the state, and extended its commercial supremacy in the East Indies. In 1658-59 he sustained Denmark against Sweden, and in 1662 concluded an advantageous peace with Portugal. The accession of Charles II. to the English throne led to the rescinding of the Act of Seclusion; nevertheless De Witt steadily refused to allow the prince of Orange to be appointed stadtholder or captain-general. This led to ill-will between the English and Dutch governments, and to a renewal of the old grievances about maritime and commercial rights, and war broke out in 1665. The zeal, industry and courage displayed by the grand pensionary during the course of this fiercely contested naval struggle could scarcely have been surpassed. He himself on more than one occasion went to sea with the fleet, and inspired all with whom he came in contact by the example he set of calmness in danger, energy in action and inflexible strength of will. It was due to his exertions as an organizer and a diplomatist quite as much as to the brilliant seamanship of Admiral de Ruyter, that the terms of the treaty of peace signed at Breda (July 31, 1667), on the principle of *uti possidetis*, were so honourable to the United Provinces. A still greater triumph of diplomatic skill was the conclusion of the Triple Alliance (January 17, 1668) between the Dutch Republic, England and Sweden, which checked the attempt of Louis XIV. to take possession of the Spanish Netherlands in the name of his wife, the infanta Maria Theresa. The check, however, was but temporary, and the French king only bided his time to take vengeance for the rebuff he had suffered. Meanwhile William III. was growing to manhood, and his numerous adherents throughout the country spared no efforts to undermine the authority of De Witt, and secure for the young prince of Orange the dignities and authority of his ancestors.

In 1672 Louis XIV. suddenly declared war, and invaded the United Provinces at the head of a splendid army. Practically no resistance was possible. The unanimous voice of the people called William III. to the head of affairs, and there were violent demonstrations against John de Witt. His brother Cornelius was (July 24) arrested on a charge of conspiring against the prince. On the 4th of August John de Witt resigned the post of grand pensionary that he had held so long and with such distinction. Cornelius was put to the torture, and on the 19th of August he was sentenced to deprivation of his offices and banishment. He was confined in the Gevangenpoort, and his brother came to visit him in the prison. A vast crowd on hearing this collected outside, and finally burst into the prison, seized the two brothers and literally tore them to pieces. Their mangled remains were hung up by the feet to a lamp-post. Thus perished, by the savage act of an infuriated mob, one of the greatest statesmen of his age.

John de Witt married Wendela Bicker, daughter of an influential burgo-master of Amsterdam, in 1655, by whom he had two sons and three daughters.

BIBLIOGRAPHY.—J. Geddes, *History of the Administration of John de Witt*, (vol. i. only, London, 1879); A. Lefèvre-Pontalis, *Jean de Witt, grand pensionnaire de Hollande* (2 vols., Paris, 1884); P. Simons, *Johan de Witt en zijn tijd* (3 vols., Amsterdam, 1832-1842); W. C. Knottenbelt, *Geschiedenis der Staatkunde van J. de Witt* (Amsterdam, 1862); J. de Witt, *Brieven . . . gewisselt tusschen den Heer Johan de Witt . . . ende de geëloogmachten v. d. staedl. d. Vereen. Nederlanden so in Vranckryck, Engeland, Sweden, Denemarck, Poolen, enz. 1652-69* (6 vols., The Hague, 1723-1725); *Brieven . . . 1650-1657 (1658) eerste deel bewerkt den R. Fruin uitgegeven d. C. W. Kernkamp* (Amsterdam, 1906).

DEWLAP (from the O.E. *leppa*, a lapnet, or hanging fold; the first syllable is of doubtful origin and the popular explanation that the word means "the fold which brushes the dew" is not borne out, according to the *New English Dictionary*, by the

equivalent words such as the Danish *doglaeb*, in Scandinavian languages), the loose fold of skin hanging from the neck of cattle, also applied to similar folds in the necks of other animals and fowls, as the dog, turkey, &c. The American practice of branding cattle by making a cut in the neck is known as a "dewlap brand." The skin of the neck in human beings often becomes pendulous with age, and is sometimes referred to humorously by the same name.

DEWSBURY, a market town and municipal and parliamentary borough in the West Riding of Yorkshire, England, on the river Calder, 8 m. S.S.W. of Leeds, on the Great Northern, London & North-Western, and Lancashire & Yorkshire railways. Pop. (1901) 28,060. The parish church of All Saints was for the most part rebuilt in the latter half of the 18th century; the portions still preserved of the original structure are mainly Early English. The chief industries are the making of blankets, carpets, druggets and worsted yarn; and there are iron foundries and machinery works. Coal is worked in the neighbourhood. The parliamentary borough includes the adjacent municipal borough of Batley, and returns one member. The municipal borough, incorporated in 1862, is under a mayor, 6 aldermen and 18 councillors. Area, 4471 acres. Paulinus, first archbishop of York, about the year 627 preached in the district of Dewsbury, where Edwin, king of Northumbria, whom he converted to Christianity, had a royal mansion. At Kirkstall, in the parish, are remains of a Cistercian convent of the 12th century, in an extensive park, where tradition relates that Robin Hood died and was buried.

DEKIPPOS, PUBLIUS HERENNIUS (c. A.D. 210-273), Greek historian, statesman and general, was an hereditary priest of the Eusebian family of the Kerykes, and held the offices of archon basileus and eponymus in Athens. When the Heruli overran Greece and captured Athens (269), Dexippus showed great personal courage and revived the spirit of patriotism among his degenerate fellow-countrymen. A statue was set up in his honour, the base of which, with an inscription recording his services, has been preserved (*Corpus Inscr. Atticarum*, iii. No. 716). It is remarkable that the inscription is silent as to his military achievements. Photius (*cod.* 82) mentions three historical works by Dexippus, of which considerable fragments remain: (1) *Tā per 'Alēxandrou*, an epitome of a similarly named work by Arrian; (2) *Σαυθῶν*, a history of the wars of Rome with the Goths (or Scythians) in the 3rd century; (3) *Χρονική ἱστορία*, a chronological history from the earliest times to the emperor Claudius Gothicus (270), frequently referred to by the writers of the Augustan history. The work was continued by Eunapius of Sardis down to 404. Photius speaks very highly of the style of Dexippus, whom he places on a level with Thucydides, an opinion by no means confirmed by the fragments (C. W. Müller, *F.H.G.* iii. 666-687).

DEXTER, HENRY MARTYN (1821-1890), American clergyman and author, was born in Plympton, Massachusetts, on the 15th of August 1821. He graduated at Yale in 1840 and at the Andover Theological Seminary in 1844; was pastor of a Congregational church in Manchester, New Hampshire, in 1844-1849, and of the Berkeley Street Congregational church, Boston, in 1849-1867; was an editor of the *Congregationalist* in 1851-1866, of the *Congregational Quarterly* in 1859-1866, and of the *Congregationalist*, with which the *Recorder* was merged, from 1867 until his death in New Bedford, Mass., on the 15th of November 1890. He was an authority on the history of Congregationalism and was lecturer on that subject at the Andover Theological Seminary in 1877-1879; he left his fine library on the Puritans in America to Yale University. Among his works are: *Congregationalism, What it is, Whence it is, How it works, Why it is better than any other Form of Church Government, and its consequent Demands* (1865), *The Church Party of the Puritans the Polity of the New Testament* (1870), *As to Roger Williams and His "Banishment" from the Massachusetts Colony* (1876), *Congregationalism of the Last Three Hundred Years, as seen in its Literature* (1880), his most important work, *A Handbook of Congregationalism* (1880), *The True Story of John Smyth, the "Se-Baptist"* (1881), *Common Sense*

as to Woman Suffrage (1885), and many reprints of pamphlets bearing on early church history in New England, especially Baptist controversies. His *The England and Holland of the Pilgrims* was completed by his son, Morton Dexter (b. 1846), and published in 1905.

DEXTER, TIMOTHY (1747-1806), American merchant, remarkable for his eccentricities, was born at Malden, Massachusetts, on the 22nd of February 1747. He acquired considerable wealth by buying up quantities of the depreciated continental currency, which was ultimately redeemed by the Federal government at par. He assumed the title of Lord Dexter and built extraordinary houses at Newburyport, Mass., and Chester, New Hampshire. He maintained a poet laureate and collected inferior pictures, besides erecting in one of his gardens some forty colossal statues carved in wood to represent famous men. A statue of himself was included in the collection, and had for an inscription "I am the first in the East, the first in the West, and the greatest philosopher in the Western World." He wrote a book entitled *Pickle for the Knowing Ones*. It was wholly without punctuation marks, and as this aroused comment, he published a second edition, at the end of which was a page displaying nothing but commas and stops, from which the readers were invited to "peper and solt it as they plesse." He beat his wife for not weeping enough at the rehearsal of his funeral, which he himself carried out in a very elaborate manner. He died at Newburyport on the 26th of October 1806.

DEXTRINE (BRITISH GUM, STARCH GUM, LEXICOUME), (C₆H₁₀O₅)_n, a substance produced from starch by the action of dilute acids, or by roasting it at a temperature between 170° and 240° C. It is manufactured by spraying starch with 2% nitric acid, drying in air, and then heating to about 110°. Different modifications are known, e.g. amylo-dextrine, erythro-dextrine and achroo-dextrine. Its name has reference to its powerful dextro-rotatory action on polarized light. Pure dextrine is an insipid, odourless, white substance; commercial dextrine is sometimes yellowish, and contains burnt or unchanged starch. It dissolves in water and dilute alcohol; by strong alcohol it is precipitated from its solutions as the hydrated compound, C₆H₁₀O₅.H₂O. Diastase converts it eventually into maltose, C₁₂H₂₂O₁₁; and by boiling with dilute acids (sulphuric, hydrochloric, acetic) it is transformed into dextrose, or ordinary glucose, C₆H₁₂O₆. It does not ferment in contact with yeast, and does not reduce Fehling's solution. If heated with strong nitric acid it gives oxalic, and not mucic acid. Dextrine much resembles gum arabic, for which it is generally substituted. It is employed for sizing paper, for stiffening cotton goods, and for thickening colours in calico printing, also in the making of lozenges, adhesive stamps and labels, and surgical bandages.

See Otto Lueger, *Lexikon der gesamten Technik*.

DEY (an adaptation of the Turk. *dây*, a maternal uncle), an honorary title formerly bestowed by the Turks on elderly men, and appropriated by the janissaries as the designation of their commanding officers. In Algeria the deys of the janissaries became in the 17th century rulers of that country (see ALGERIA: *History*). From the middle of the 16th century to the end of the 17th century the ruler of Tunisia was also called dey, a title frequently used during the same period by the sovereigns of Tripoli.

DHAMMAPĀLA, the name of one of the early disciples of the Buddha, and therefore constantly chosen as their name in religion by Buddhist novices on their entering the brotherhood. The most famous of the Bhikshus so named was the great commentator who lived in the latter half of the 5th century A.D. at the Badara Titha Vihāra, near the east coast of India, just a little south of where Madras now stands. It is to him we owe the commentaries on seven of the shorter canonical books, consisting almost entirely of verses, and also the commentary on the Nettī, perhaps the oldest Pāli work outside the canon. Extracts from the latter work, and the whole of three out of the seven others, have been published by the Pāli Text Society. These works show great learning, exegetical skill and sound judgment. But as Dhammapāla confines himself rigidly either to questions of

the meaning of words, or to discussions of the ethical import of his texts, very little can be gathered from his writings of value for the social history of his time. For the right interpretation of the difficult texts on which he comments, they are indispensable. Though in all probability a Tamil by birth, he declares, in the opening lines of those of his works that have been edited, that he followed the tradition of the Great Minister at Anurādhapura in Ceylon, and the works themselves confirm this in every respect. Hsüan Tsang, the famous Chinese pilgrim, tells a quaint story of a Dhammapāla of Kāncchipura (the modern Konjevaram). He was a son of a high official, and betrothed to a daughter of the king, but escaped on the eve of the wedding feast, entered the order, and attained to reverence and distinction. It is most likely that this story, whether legendary or not (and Hsüan Tsang heard the story at Kāncchipura nearly two centuries after the date of Dhammapāla), referred to this author. But it may also refer, as Hsüan Tsang refers it, to another author of the same name. Other unpublished works, besides those mentioned above, have been ascribed to Dhammapāla, but it is very doubtful whether they are really by him.

AUTHORITIES.—T. Watters, *On Yuan Chwang* (ed. Rhys Davids and Bushell, London, 1905), ii. 169, 228; Edmund Hardy in *Zeitschrift der deutschen morgenländischen Gesellschaft* (1898), pp. 97 foll.; Neils (ed. E. Hardy, London, Pāli Text Society, 1902), especially the Introduction, *passim*; *Therī Gāthā Commentary*, *Peta Vāṭṭu Commentary*, and *Vimāna Vāṭṭu Commentary*, all three published by the Pāli Text Society. (T. W. R. D.)

DHANIS, FRANCIS, BARON (1861–1909), Belgian administrator, was born in London in 1861 and passed the first fourteen years of his life at Greenock, where he received his early education. He was the son of a Belgian merchant and of an Irish lady named Maher. The name Dhanis is supposed to be a variation of D'Anvers. Having completed his education at the Ecole Militaire he entered the Belgian army, joining the regiment of grenadiers, in which he rose to the rank of major. As soon as he reached the rank of lieutenant he volunteered for service on the Congo, and in 1887 he went out for a first term. He did so well in founding new stations north of the Congo that, when the government decided to put an end to the Arab domination on the Upper Congo, he was selected to command the chief expedition sent against the slave dealers. The campaign began in April 1892, and it was not brought to a successful conclusion till January 1894. The story of this war has been told in detail by Dr Sydney Hinde, who took part in it, in his book *The Fall of the Congo Arabs*. The principal achievements of the campaign were the captures in succession of the three Arab strongholds at Nyangwe, Kassongo and Kabambari. For his services Dhanis was raised to the rank of baron, and in 1895 was made vice-governor of the Congo State. In 1896 he took command of an expedition to the Upper Nile. His troops, largely composed of the Batetela tribes who had only been recently enlisted, and who had been irritated by the execution of some of their chiefs for indulging their cannibal proclivities, mutinied and murdered many of their white officers. Dhanis found himself confronted with a more formidable adversary than even the Arabs in these well-armed and half-disciplined mercenaries. During two years (1897–1898) he was constantly engaged in a life-and-death struggle with them. Eventually he succeeded in breaking up the several bands formed out of his mutinous soldiers. Although the incidents of the Batetela operations were less striking than those of the Arab war, many students of both think that the Belgian leader displayed the greater ability and fortitude in bringing them to a successful issue. In 1899 Baron Dhanis returned to Belgium with the honorary rank of vice-governor-general. He died on the 14th of November 1909.

DHAR, a native state of India, in the Bhopawar agency, Central India. It includes many Rajput and Bhil feudatories, and has an area of 1775 sq. m. The raja is a Punwar Mahratta. The founder of the present ruling family was Anand Rao Punwar, a descendant of the great Paramara clan of Rajputs who from the 9th to the 13th century, when they were driven out by the Mahomedans, had ruled over Malwa from their capital at Dhar.

Anand Rao received Dhar as a fief from Bajji Rao, the

peshwa, the victory of the Mahrattas thus restoring the sovereign power to the family which seven centuries before had been expelled from this very city and country. Towards the close of the 18th and in the early part of the 19th century, the state was subject to a series of spoliations by Sindia and Holkar, and was only preserved from destruction by the talents and courage of the adoptive mother of the fifth raja. By a treaty of 1819 Dhar passed under British protection, and bound itself to act in subordinate co-operation. The state was confiscated for rebellion in 1857, but in 1860 was restored to Raja Anand Rao Punwar, then a minor, with the exception of the detached district of Bairusia, which was granted to the begum of Bhopal. Anand Rao, who received the personal title Maharaja and the K.C.S.I. in 1877, died in 1898, and was succeeded by Udaji Rao Punwar. In 1901 the population was 142,115. The state includes the ruins of Mandu, or Mandogarh, the Mahomedan capital of Malwa.

The **TOWN OF DHAR** is 33 m. W. of Mhow, 908 ft. above the sea. Pop. (1901) 17,792. It is picturesquely situated among lakes and trees surrounded by barren hills, and possesses, besides its old walls, many interesting buildings, Hindu and Mahomedan, some of them containing records of a great historical importance. The Lat Masjid, or Pillar Mosque, was built by Dilawar Khan in 1405 out of the remains of Jain temples. It derives its name from an iron pillar, supposed to have been originally set up at the beginning of the 13th century in commemoration of a victory, and bearing a later inscription recording the seven days' visit to the town of the emperor Akbar in 1598. The pillar, which was 43 ft. high, is now overthrown and broken. The Kamal Maula is an enclosure containing four tombs, the most notable being that of Shaikh Kamal Maulvi (Kamal-ud-din), a follower of the famous 13th-century Mussulman saint Nizam-ud-din Auliya¹. The mosque known as Raja Bhoj's school was built out of Hindu remains in the 14th or 15th century; its name is derived from the slabs, covered with inscriptions giving rules of Sanskrit grammar, with which it is paved. On a small hill to the north of the town stands the fort, a conspicuous pile of red sandstone, said to have been built by Mahomed ben Tughlak of Delhi in the 14th century. It contains the palace of the raja. Of modern institutions may be mentioned the high school, public library, hospital, and the chapel, school and hospital of the Canadian Presbyterian mission. There is also a government opium depot for the payment of duty, the town being a considerable centre for the trade in opium as well as in grain.

The town, the name of which is usually derived from Dhara Nagari (the city of sword blades), is of great antiquity, and was made the capital of the Paramara chiefs of Malwa by Vairisinha II., who transferred his headquarters hither from Ujjain at the close of the 9th century. During the rule of the Paramara dynasty Dhar was famous throughout India as a centre of culture and learning; but, after suffering various vicissitudes, it was finally conquered by the Mussulmans at the beginning of the 14th century. At the close of the century Dilawar Khan, the builder of the Lat Masjid, who had been appointed governor in 1399, practically established his independence. His son Hoshang Shah being the first Mahomedan king of Malwa. Under this dynasty Dhar was second in importance to the capital Mandu. Subsequently, in the time of Akbar, Dhar fell under the dominion of the Moguls, in whose hands it remained till 1730, when it was conquered by the Mahrattas.

See *Imperial Gazetteer of India* (Oxford, 1908).

DHARAMPUR, a native state of India, in the Surat political agency division of Bombay, with an area of 704 sq. m. The population in 1901 was 100,430, being a decrease of 17% during the decade; the estimated gross revenue is £25,412; and the tribute £600. Its chief is a Sesodia Rajput. The state has been surveyed for land revenue on the Bombay system. It contains one town, Dharampur (pop. in 1901, 63,449), and 272 villages. Only a small part of the state, the climate of which is very unhealthy, is capable of cultivation; the rest is covered with rocky hills, forest and brushwood.

¹ Nizam-ud-din, whose beautiful marble tomb is at Indarpat near Delhi, was, according to some authorities, an assassin of the secret society of Khorasani. By some modern authorities he is supposed to have been the founder of Thuggism, the Thugs having a special reverence for his memory.

DHARMSALA, a hill-station and sanatorium of the Punjab, India, situated on a spur of the Dhaola Dhar, 16 m. N.E. of Kangra town, at an elevation of some 6000 ft. Pop. (1901) 6971. The scenery of Dharmasala is of peculiar grandeur. The spur on which it stands is thickly wooded with oak and other trees; behind it the pine-clad slopes of the mountain tower towards the jagged peaks of the higher range, snow-clad for half the year; while below stretches the luxuriant cultivation of the Kangra valley. In 1855 Dharmasala was made the headquarters of the Kangra district of the Punjab in place of Kangra, and became the centre of a European settlement and cantonment, largely occupied by Gurkha regiments. The station was destroyed by the earthquake of April 1905, in which 1625 persons, including 25 Europeans and 112 of the Gurkha garrison, perished (*Imperial Gazetteer of India*, 1908).

DHARWAR, a town and district of British India, in the southern division of Bombay. The town has a station on the Southern Mahratta railway. The population in 1901 was 31,270. It has several ginning factories and a cotton-mill; two high schools, one maintained by the Government and the other by the Basel German Mission.

The **DISTRICT OF DHARWAR** has an area of 4602 sq. m. In the north and north-east are great plains of black soil, favourable to cotton-growing; in the south and west are successive ranges of low hills, with flat fertile valleys between them. The whole district lies high and has no large rivers.

In 1901 the population was 1,113,208, showing an increase of 6% in the decade. The most influential classes of the community are Brahmans and Lingayats. The Lingayats number 436,968, or 46% of the Hindu population; they worship the symbol of Siva, and males and females both carry this emblem about their person in a silver case. The principal crops are millets, pulse and cotton. The centres of the cotton trade are Hubli and Gadag, junctions on the Southern Mahratta railway, which traverses the district in several directions.

The early history of the territory comprised within the district of Dharwar has been to a certain extent reconstructed from the inscription slabs and memorial stones which abound there. From these it is clear that the country fell in turn under the sway of the various dynasties that ruled in the Deccan, memorials of the Chalukyan dynasty, whether temples or inscriptions, being especially abundant. In the 14th century the district was first overrun by the Mahomedans, after which it was annexed to the newly established Hindu kingdom of Vijayanagar, an official of which named Dhar Rao, according to local tradition, built the fort at Dharwar town in 1403. After the defeat of the king of Vijayanagar at Talikot (1565), Dharwar was for a few years practically independent under its Hindu governor; but in 1573 the fort was captured by the sultan of Bijapur, and Dharwar was annexed to his dominions. In 1685 the fort was taken by the emperor Aurangzeb, and Dharwar, on the break-up of the Mogul empire, fell under the sway of the peshwa of Poona. In 1764 the province was overrun by Hyder Ali of Mysore, who in 1778 captured the fort of Dharwar. This was retaken in 1791 by the Mahrattas. On the final overthrow of the peshwa in 1817, Dharwar was incorporated with the territory of the East India Company.

DHOLPUR, a native state of India, in the Rajputana agency, with an area of 1155 sq. m. It is a crop-producing country, without any special manufactures. All along the bank of the Chambal the country is deeply intersected by ravines; low ranges of hills in the western portion of the state supply inexhaustible quarries of fine-grained and easily-worked red sandstone. In 1901 the population of Dholpur was 270,073, showing a decrease of 3% in the decade. The estimated revenue is £53,000. The state is crossed by the Indian Midland railway from Bhansi to Agra. In recent years it has suffered severely from drought. In 1896-1897 the expenditure on famine relief amounted to £8190.

The town of Dholpur is 34 m. S. of Agra by rail. Pop. (1901) 19,310. The present town, which dates from the 16th century, stands somewhat to the north of the site of the older Hindu town

built, it is supposed, in the 11th century by the Tonwar Rajput Raja Dholan (or Dhawal) Deo, and named after him Dholera or Dhawalpuri. Among the objects of interest in the town may be mentioned the fortified *sarais* built in the reign of Akbar, within which is the fine tomb of Sadik Mahommed Khan (d. 1595), one of his generals. The town, from its position on the railway, is growing in importance as a centre of trade.

Little is known of the early history of the country forming the state of Dholpur. Local tradition affirms that it was ruled by the Tonwar Rajputs, who had their seat at Delhi from the 8th to the 12th century. In 1450 it had a raja of its own; but in 1501 the fort of Dholpur was taken by the Mahomedans under Sikandar Lodi and in 1504 was transferred to a Mussulman governor. In 1527, after a strenuous resistance, the fort was captured by Baber and with the surrounding country passed under the sway of the Moguls, being included by Akbar in the province of Agra. During the disensions which followed the death of Aurangzeb in 1707, Raja Kalyan Singh Bhaduria obtained possession of Dholpur, and his family retained it till 1761, after which it was taken successively by the Jat raja, Suraj Mal of Bharatpur, by Mirza Najaf Khan in 1775, by Sindhia in 1782, and in 1803 by the British. It was restored to Sindhia by the treaty of Sarji Anjangaon, but in consequence of new arrangements was again occupied by the British. Finally, in 1806, the territories of Dholpur, Bari and Rajakhera were handed over to the maharaj rana Kirat Singh, ancestor of the present chiefs of Dholpur, in exchange for his state of Gohad, which was ceded to Sindhia.

The maharaj rana of Dholpur belongs to the clan of Bamraoli Jats, who are believed to have formed a portion of the Indo-Scythian wave of invasion which swept over northern India about A.D. 100. An ancestor of the family appears to have held certain territories at Bamraoli near Agra c. 1195. His descendant in 1505, Singhan Deo, having distinguished himself in an expedition against the freebooters of the Deccan, was rewarded by the sovereignty of the small territory of Gohad, with the title of *rana*. In 1779 the rana of Gohad joined the British forces against Sindhia, under a treaty which stipulated that, at the conclusion of peace between the English and Mahrattas, all the territories then in his possession should be guaranteed to him, and protected from invasion by Sindhia. This protection was subsequently withdrawn, the rana having been guilty of treachery, and in 1783 Sindhia succeeded in recapturing the fortress of Gwalior, and crushed his Jat opponent by seizing the whole of Gohad. In 1804, however, the family were restored to Gohad by the British government; but, owing to the opposition of Sindhia, the rana agreed in 1805 to exchange Gohad for his present territory of Dholpur, which was taken under British protection, the chief binding himself to act in subordinate co-operation with the paramount power, and to refer all disputes with neighbouring princes to the British government. Kirat Singh, the first maharaj rana of Dholpur, was succeeded in 1836 by his son Bhagwant Singh, who showed great loyalty during the Mutiny of 1857, was created a K.C.S.I., and G.C.S.I. in 1866. He was succeeded in 1873 by his grandson Nihal Singh, who received the C.B. and frontier medal for services in the Tirah campaign. He died in 1901, and was succeeded by his eldest son Ram Singh (b. 1883).

See *Imperial Gazetteer of India* (Oxford, 1908) and authorities there given.

DHOW, the name given to a type of vessel used throughout the Arabian Sea. The language to which the word belongs is unknown. According to the *New English Dictionary* the place of origin may be the Persian Gulf, assuming that the word is identical with the *tau* mentioned by Athanasius Nikitin (*India in the 15th Century*, Hakluyt Society, 1858). Though the word is used generally of any craft along the East African coast, it is usually applied to the vessel of about 150 to 200 tons burden with a stem rising with a long slope from the water; dhows generally have one mast with a lateen sail, the yard being of enormous length. Much of the coasting trade of the Red Sea and Persian Gulf is carried on by these vessels. They were the regular vessels employed in the slave trade from the east coast of Africa.

DHRANGADRA, a native state of India, in the Gujarat division of Bombay, situated in the north of the peninsula of Kathiawar. Its area is 1156 sq. m. Pop. (1901) 70,880. The estimated gross revenue is £38,000 and the tribute £3000. A state railway on the metre gauge from Wadhwan to the town of Dhrangadra, a distance of 21 m., was opened for traffic in 1898. Some cotton is grown, although the soil is as a whole poor; the manufactures include salt, metal vessels and stone hand-mills. The chief town, Dhrangadra, has a population (1901) of 14,770.

The chief of Dhrangadra, who bears the title of Raj Sahib, with the predicate of His Highness, is head of the ancient clan of Jhala Rajputs, who are said to have entered Kathiawar from Sind in the 8th century. Raj Sahib Sir Mansinghji Ranmalsinghji (b. 1837), who succeeded his father in 1869, was distinguished for the enlightened character of his administration, especially in the matter of establishing schools and internal communications. He was created a K.C.S.I. in 1877. He died in 1900, and was succeeded by his grandson Ajitsinghji Jaswatsinghji (b. 1872).

DHULEEP SINGH (1837-1893), maharaja of Lahore, was born in February 1837, and was proclaimed maharaja on the 18th of September 1843, under the regency of his mother the rani Jindan, a woman of great capacity and strong will, but extremely inimical to the British. He was acknowledged by Ranjit Singh and recognized by the British government. After six years of peace the Sikhs invaded British territory in 1845, but were defeated in four battles, and terms were imposed upon them at Lahore, the capital of the Punjab. Dhuleep Singh retained his territory, but it was administered to a great extent by the British government in his name. This arrangement increased the regent's dislike of the British, and a fresh outbreak occurred in 1848-49. In spite of the valour of the Sikhs, they were utterly routed at Gujarat, and in March 1849 Dhuleep Singh was deposed, a pension of £40,000 a year being granted to him and his dependants. He became a Christian and elected to live in England. On coming of age he made an arrangement with the British government by which his income was reduced to £25,000 in consideration of advances for the purchase of an estate, and he finally settled at Elvedon in Suffolk. While passing through Alexandria in 1864 he met Miss Bamba Müller, the daughter of a German merchant who had married an Abyssinian. The maharaja had been interested in mission work by Sir John Login, and he met Miss Müller at one of the missionary schools where she was teaching. She became his wife on the 7th of June 1864, and six children were the issue of the marriage. In the year after her death in 1890 the maharaja married at Paris, as his second wife, an English lady, Miss Ada Douglas Wetherill, who survived him. The maharaja was passionately fond of sport, and his shooting parties were celebrated, while he himself became a *persona grata* in English society. The result, however, was financial difficulty, and in 1882 he appealed to the government for assistance, making various claims based upon the alleged possession of private estates in the Punjab, and upon the surrender of the Koh-i-nor diamond to the British Crown. His demand was rejected, whereupon he started for India, after drawing up a proclamation to his former subjects. But as it was deemed inadvisable to allow him to visit the Punjab, he remained for some time as a guest at the residency at Aden, and was allowed to receive some of his relatives to witness his abjuration of Christianity, which actually took place within the residency itself. As the climate began to affect his health, the maharaja at length left Aden and returned to Europe. He stayed for some time in Russia, hoping that his claim against England would be taken up by the Russians; but when that expectation proved futile he proceeded to Paris, where he lived for the rest of his life on the pension allowed him by the Indian government. His death from an attack of apoplexy took place at Paris on the 22nd of October 1893. The maharaja's eldest son, Prince Victor Albert Jay Dhuleep Singh (b. 1866), was educated at Trinity and Downing Colleges, Cambridge. In 1888 he obtained a commission in the 1st Royal Dragoon Guards. In 1888 he married Lady Anne Coventry, youngest daughter of the
 'ry.

(G. F. B.)

DHULIA, a town of British India, administrative headquarters of West Khandesh district in Bombay, on the right bank of the Panjhra river. Pop. (1901) 24,726. Considerable trade is done in cotton and oil-seeds, and weaving of cotton. A railway connects Dhulia with Chalisgaon, on the main line of the Great Indian Peninsula railway.

DIABASE, in petrology, a rock which is a weathered form of dolerite. It was long widely accepted that the pre-Tertiary rocks of this group differed from their Tertiary and Recent representatives in certain essential respects, but this is now admitted to be untenable, and the differences are known to be merely the result of the longer exposure to decomposition, pressure and shearing, which the older rocks have experienced. Their olivine tends to become serpentinized; their augite changes to chlorite and uraltite; their feldspars are clouded by formation of zeolites, calcite, sericite and epidote. The rocks acquire a green colour (from the development of chlorite, uraltite and epidote); hence the older name of "greenstones," which is now little used. Many of them become somewhat schistose from pressure ("greenstone-schists," meta-diabase, &c.). Although the original definition of the group can no longer be justified, the name is so well established in current usage that it can hardly be discarded. The terms diabase and dolerite are employed really to designate distinct facies of the same set of rocks.

The minerals of diabase are the same as those of dolerite, viz. olivine, augite, and plagioclase feldspar, with subordinate quantities of hornblende, biotite, iron oxides and apatite.

There are olivine-diabases and diabases without olivine; quartz-diabases, analcite-diabases (or tescenites) and hornblende diabases (or proterobases). Hypersthene (or bronzite) is characteristic of another group. Many of them are ophitic, especially those which contain olivine, but others are intersertal, like the intersertal dolerites. The last include most quartz-diabases, hypersthene-diabases and the rocks which have been described as tholeiites. Porphyritic structure appears in the diabase-porphyrates, some of which are highly vesicular and contain remains of an abundant fine-grained or partly glassy ground-mass (*diabas-mandelstein*, amygdaloidal diabase). The somewhat ill-defined spilites are regarded by many as modifications of diabase-porphyrite. In the intersertal and porphyritic diabases, fresh or devitrified glassy base is not infrequent. It is especially conspicuous in some tholeiites (hyalo-tholeiites) and in weissenbergites. These rocks consist of augite and plagioclase, with little or no olivine, on a brown, vitreous, intersertal matrix. Devitrified forms of tachylite (sordawilite, &c.) occur at the rapidly chilled margins of dolerite sills and dikes, and fine-grained spotted rocks with large spherulites of grey or greenish feldspar, and branching growths of brownish-green augite (variolites).

To nearly every variety in composition and structure presented by the diabases, a counterpart can be found among the Tertiary dolerites. In the older rocks, however, certain minerals are more common than in the newer. Hornblende, mostly of pale green colours and somewhat fibrous habit, is very frequent in diabase; it is in most cases secondary after pyroxene, and is then known as uraltite; often it forms pseudomorphs which retain the shape of the original augite. Where diabases have been crushed or sheared, hornblende readily develops at the expense of pyroxene, sometimes replacing it completely. In the later stages of alteration the amphibole becomes compact and well crystallized; the rocks consist of green hornblende and plagioclase feldspar, and are then generally known as epidiorites or amphibolites. At the same time a schistose structure is produced. But transition forms are very common, having more or less of the augite remaining, surrounded by newly formed hornblende which at first is rather fibrous and tends to spread outwards through the surrounding feldspar. Chlorite also is abundant both in sheared and unshattered diabases, and with it calcite may make its appearance, or the lime set free from the augite may combine with the titanium of the iron oxide and with silica to form incrustations or borders of sphenes around the original crystals of ilmenite. Epidote is another secondary lime-bearing mineral which results from the decomposition of the soda lime feldspars and the pyroxenes. Many diabases, especially those of the tescenite sub-group, are filled with zeolites.

Diabases are exceedingly abundant among the older rocks of all parts of the globe. Popular names for them are "whinstone," "greenstone," "toadstone," and "trap." They form excellent road-making stones and are much quarried for this purpose, being tough, durable and resistant to wear, so long as they are not extremely decomposed. Many of them are to be preferred to the fresher dolerites as being less brittle. The quality of the Cornish greenstones appears to have been distinctly improved by a smaller amount of recrystallization where they have been heated by contact with intrusive masses of granite.
 (J. S. F.)

DIABETES (from Gr. *diá*, through, and *baíwv*, to pass), a constitutional disease characterized by a habitually excessive discharge of urine. Two forms of this complaint are described, viz. Diabetes Mellitus, or Glycosuria, where the urine is not only increased in quantity, but persistently contains a greater or less amount of sugar, and Diabetes Insipidus, or Polyuria, where the urine is simply increased in quantity, and contains no abnormal ingredient. This latter, however, must be distinguished from the polyuria due to chronic granular kidney, lardaceous disease of the kidney, and also occurring in certain cases of hysteria.

Diabetes mellitus is the disease to which the term is most commonly applied, and is by far the more serious and important ailment. It is one of the diseases due to altered metabolism (see METABOLIC DISEASES). It is markedly hereditary, much more prevalent in towns and especially modern city life than in more primitive rustic communities, and most common among the Jews. The excessive use of sugar as a food is usually considered one cause of the disease, and obesity is supposed to favour its occurrence, but many observers consider that the obesity so often met with among diabetics is due to the same cause as the disease itself. No age is exempt, but it occurs most commonly in the fifth decade of life. It attacks males twice as frequently as females, and fair more frequently than dark people.

The symptoms are usually gradual in their onset, and the patient may suffer for a length of time before he thinks it necessary to apply for medical aid. The first symptoms which attract attention are failure of strength, and emaciation, along with great thirst and an increased amount and frequent passage of urine. From the normal quantity of from 2 to 3 pints in the 24 hours it may be increased to 10, 20 or 30 pints, or even more. It is usually of pale colour, and of thicker consistence than normal urine, possesses a decidedly sweet taste, and is of high specific gravity (1030 to 1050). It frequently gives rise to considerable irritation of the urinary passages.

By simple evaporation crystals of sugar may be obtained from diabetic urine, which also yields the characteristic chemical tests of sugar, while the amount of this substance can be accurately estimated by certain analytical processes. The quantity of sugar passed may vary from a few ounces to two or more pounds per *em*, and it is found to be markedly increased after saccharine or starchy food has been taken. Sugar may also be found in the blood, saliva, tears, and in almost all the excretions of persons suffering from this disease. One of the most distressing symptoms is intense thirst, which the patient is constantly seeking to allay, the quantity of liquid consumed being in general enormous, and there is usually, but not invariably, a voracious appetite. The mouth is always parched, and a faint, sweetish odour may be evolved from the breath. The effect of the disease upon the general health is very marked, and the patient becomes more and more emaciated. He suffers from increasing muscular weakness, the temperature of his body is lowered, and the skin is dry and harsh. There is often a peculiar flush on the face, not limited to the malar eminences, but extending up to the roots of the hair. The teeth are loosened or decay, there is a tendency to bleeding from the gums, while dyspeptic symptoms, constipation and loss of sexual power are common accompaniments. There is in general great mental depression or irritability.

Diabetes as a rule advances comparatively slowly except in the case of young persons, in whom its progress is apt to be rapid. The complications of the disease are many and serious. It may cause impaired vision by weakening the muscles of accommodation, or by lessening the sensitiveness of the retina to light. Also cataract is very common. Skin affections of all kinds may occur and prove very intractable. Boils, carbuncles, ostitis and gangrene are all apt to occur as life advances, though gangrene is much more frequent in men than in women. Diabetics are especially liable to phthisis and pneumonia, and gangrene of the lungs may set in if the patient survives the crisis of the latter disease. Digestive troubles of all kinds, kidney diseases and heart failure due to fatty heart are all of common occurrence. Also patients seem curiously susceptible to the poison of enteric fever, though the attack usually runs a mild

course. The sugar temporarily disappears during the fever. But the most serious complication of all is known as diabetic coma, which is very commonly the final cause of death. The onset is often insidious, but may be indicated by loss of appetite, a rapid fall in the quantity of both urine and sugar, and by either constipation or diarrhoea. More rarely there is most acute abdominal pain. At first the condition is rather that of collapse than true coma, though later the patient is absolutely comatose. The patient suffers from a peculiar kind of dyspnoea, and the breath and skin have a sweet ethereal odour. The condition may last from twenty-four hours to three days, but is almost invariably the precursor of death.

Diabetes is a very fatal form of disease, recovery being exceedingly rare. Over 50% die of coma, another 25% of phthisis or pneumonia, and the remainder of Bright's disease, cerebral hæmorrhage, gangrene, &c. The most favourable cases are those in which the patient is advanced in years, those in which it is associated with obesity or gout, and where the social conditions are favourable. A few cures have been recorded in which the disease supervened after some acute illness. The unfavourable cases are those in which there is a family history of the disease and in which the patient is young. Nevertheless much may be done by appropriate treatment to mitigate the severity of the symptoms and to prolong life.

There are two distinct lines of treatment, that of diet and that of drugs, but each must be modified and determined entirely by the idiosyncrasy of the patient, which varies in this condition between very wide limits. That of diet is of primary importance inasmuch as it has been proved beyond question that certain kinds of food have a powerful influence in aggravating the disease, more particularly those consisting largely of saccharine and starchy matter; and it may be stated generally that the various methods of treatment proposed aim at the elimination as far as possible of these constituents from the diet. Hence it is recommended that such articles as bread, potatoes and all farinaceous foods, turnips, carrots, parsnips and most fruits should be avoided; while animal food and soups, green vegetables, cream, cheese, eggs, butter, and tea and coffee without sugar, may be taken with advantage. As a substitute for ordinary bread, which most persons find it difficult to do without for any length of time, bran bread, gluten bread and almond biscuits. A patient must never pass suddenly from an ordinary to a carbohydrate-free diet. Any such sudden transition is extremely liable to bring on diabetic coma, and the change must be made quite gradually, one form of carbohydrate after another being taken out of the diet, whilst the effect on the quantity of sugar passed is being carefully noted meanwhile. The treatment may be begun by excluding potatoes, sugar and fruit, and only after several days is the bread to be replaced by some diabetic substitute. When the sugar excretion has been reduced to its lowest point, and maintained there for some time, a certain amount of carbohydrate may be cautiously allowed, the consequent effect on the glycosuria being estimated. The best diet can only be worked out experimentally for each individual patient. But in every case, if drowsiness or any symptom suggesting coma supervene, all restrictions must be withdrawn, and carbohydrate freely allowed. The question of alcohol is one which must be largely determined by the previous history of the patient, but a small quantity will help to make up the deficiencies of a diet poor in carbohydrate. Scotch and Irish whisky, and Hollands gin, are usually free from sugar, and some of the light Bordeaux wines contain very little. Fat is beneficial, and can be given as cream, fat of meat and cod-liver oil. Green vegetables are harmless, but the white stalks of cabbages and lettuces and also celery and endive yield sugar. Lævulose can be assimilated up to 1½ ozs. daily without increasing the glycosuria, and hence apples, cooked or raw, are allowable, as the sugar they contain is in this form. The question of milk is somewhat disputed; but it is usual to exclude it from the rigid diet, allowing a certain quantity when the diet is being extended. Thirst is relieved by anything that relieves the polyuria. But hypodermic injections of pilocarpine stimulate the flow of saliva, and thus relieve the dryness of the

mouth. Constipation appears to increase the thirst, and must always be carefully guarded against. The best remedies are the aperient mineral waters.

Numerous medicinal substances have been employed in diabetes, but few of them are worthy of mention as possessed of any efficacy. Opium is often found of great service, its administration being followed by marked amelioration in all the symptoms. Morphia and codeia have a similar action. In the severest cases, however, these drugs appear to be of little or no use, and they certainly increase the constipation. Heroin hydrochloride has been tried in their place, but this seems to have more power over slight than over severe cases. Salicylate of sodium and aspirin are both very beneficial, causing a diminution in the sugar excretion without counterbalancing bad effects.

In *diabetes insipidus* there is constant thirst and an excessive flow of urine, which, however, is not found to contain any abnormal constituent. Its effects upon the system are often similar to those of diabetes mellitus, except that they are much less marked, the disease being in general very slow in its progress. In some cases the health appears to suffer very slightly. It is rarely a direct cause of death, but from its debilitating effects may predispose to serious and fatal complications. It is best treated by tonics and generous diet. Valerian has been found beneficial, the powdered root being given in 5-grain doses.

DIABOLO, a game played with a sort of top in the shape of two cones joined at their apices, which is spun, thrown, and caught by means of a cord strung to two sticks. The idea of the game appears originally to have come from China, where a top (*Kouwen-gen*), made of two hollow pierced cylinders of metal or wood, joined by a rod—and often of immense size,—was made by rotation to hum with a loud noise, and was used by pedlars to attract customers. From China it was introduced by missionaries to Europe; and a form of the game, known as "the devil on two sticks," appears to have been known in England towards the end of the 18th century, and Lord Macartney is credited with improvements in it. But its principal vogue was in France in 1812, where the top was called "le diable." Amusing old prints exist (see *Fry's Magazine*, March and December 1907), depicting examples of the popular craze in France at the time. The *diabole* of those days resembled a globular wooden dumb-bell with a short waist, and the sonorous hum when spinning—the *bruit du diable*—was a pronounced feature. At intervals during the century occasional attempts to revive the game of spinning a top of this sort on a string were made, but it was not till 1906 that the sensation of 1812 began to be repeated. A French engineer, Gustave Phillipart, discovering some old implements of the game, had experimented for some time with new forms of top with a view to bringing it again into popularity; and having devised the double-cone shape, and added a miniature bicycle tire of rubber round the rims of the two ends of the double-cone, with other improvements, he named it "diabolo." The use of celluloid in preference to metal or wood as its material appears to have been due to a suggestion of Mr C. B. Fry, who was consulted by the inventor on the subject. The game of spinning, throwing and catching the diabolo was rapidly elaborated in various directions, both as an exercise of skill in doing tricks, and in "diabolo tennis" and other ways as an athletic pastime. From Paris, Ostend and the chief French seaside resorts, where it became popular in 1906, its vogue spread in 1907 so that in France and England it became the fashionable "rage" among both children and adults.

The mechanics of the diabolo were worked out by Professor C. V. Boys in the *Proc. Phys. Soc.* (London), Nov. 1907.

DIAGONICON, in the Greek Church, the name given to a chamber on the south side of the central apse, where the sacred utensils, vessels, &c., of the church were kept. In the reign of Justin II. (565-574), owing to a change in the liturgy, the diaconicon and prostheses were located in apses at the east end of the aisles. Before that time there was only one apse. In the churches in central Syria of slightly earlier date, the diaconicon is rectangular, the side apses at Kalat-Seman having been added at a later date.

DIADOCHI (Gr. *δαδοχῆαι*, to receive from another), i.e. "Successors," the name given to the Macedonian generals who

fought for the empire of Alexander after his death in 323 B.C. The name includes Antigonos and his son Demetrius Poliorketes, Antipater and his son Cassander, Seleucus, Ptolemy, Eumenes and Lysimachus. The kingdoms into which the Macedonian empire was divided under these rulers are known as Hellenistic. The chief were Asia Minor and Syria under the Seleucid Dynasty (q.v.), Egypt under the Ptolemies (q.v.), Macedonia under the successors of Antigonos Gonatas, Pergamum (q.v.) under the Attalid dynasty. Gradually these kingdoms were merged in the Roman empire. (See MACEDONIAN EMPIRE.)

DIAGONAL (Gr. *διά*, through, *γωνία*, a corner), in geometry, a line joining the intersections of two pairs of sides of a rectilinear figure.

DIAGORAS, of Melos, surnamed the Atheist, poet and sophist, flourished in the second half of the 5th century B.C. Religious in his youth and a writer of hymns and dithyrambs, he became an atheist because a great wrong done to him was left unpunished by the gods. In consequence of his blasphemous speeches, and especially his criticism of the Mysteries, he was condemned to death at Athens, and a price set upon his head (Aristoph. *Clouds*, 830; *Birds*, 1073 and Schol.). He fled to Corinth, where he is said to have died. His work on the Mysteries was called *Φθύραι Λόγια* or *Ἀποσυρηγῶρες*, in which he probably attacked the Phrygian divinities.

DIAGRAM (Gr. *διάγραμμα*, from *διαγράφω*, to mark out by lines, a figure drawn in such a manner that the geometrical relations between the parts of the figure illustrate relations between other objects. They may be classed according to the manner in which they are intended to be used, and also according to the kind of analogy which we recognize between the diagram and the thing represented. The diagrams in mathematical treatises are intended to help the reader to follow the mathematical reasoning. The construction of the figure is defined in words so that even if no figure were drawn the reader could draw one for himself. The diagram is a good one if those features which form the subject of the proposition are clearly represented.

Diagrams are also employed in an entirely different way—namely, for purposes of measurement. The plans and designs drawn by architects and engineers are used to determine the value of certain real magnitudes by measuring certain distances on the diagram. For such purposes it is essential that the drawing be as accurate as possible. We therefore class diagrams as diagrams of illustration, which merely suggest certain relations to the mind of the spectator, and diagrams drawn to scale, from which measurements are intended to be made. There are some diagrams or schemes, however, in which the form of the parts is of no importance, provided their connexions are properly shown. Of this kind are the diagrams of electrical connexions, and those belonging to that department of geometry which treats of the degrees of cyclosis, periphaxy, linkedness and knottedness.

Diagrams purely Graphic and mixed Symbolic and Graphic.—Diagrams may also be classed either as purely graphical diagrams, in which no symbols are employed except letters or other marks to distinguish particular points of the diagrams, and mixed diagrams, in which certain magnitudes are represented, not by the magnitudes of parts of the diagram, but by symbols, such as numbers written on the diagram. Thus in a map the height of places above the level of the sea is often indicated by marking the number of feet above the sea at the corresponding places on the map. There is another method in which a line called a contour line is drawn through all the places in the map whose height above the sea is a certain number of feet, and the number of feet is written at some point or points of this line. By the use of a series of contour lines, the height of a great number of places can be indicated on a map by means of a small number of written symbols. Still this method is not a purely graphical method, but a partly symbolical method of expressing the third dimension of objects on a diagram in two dimensions.

In order to express completely by a purely graphical method the relations of magnitudes involving more than two variables, we must use more than one diagram. Thus in the arts of construction we use plans and elevations and sections through different planes, to specify the form of objects having three

dimensions. In such systems of diagrams we have to indicate that a point in one diagram corresponds to a point in another diagram. This is generally done by marking the corresponding points in the different diagrams with the same letter. If the diagrams are drawn on the same piece of paper we may indicate corresponding points by drawing a line from one to the other, taking care that this line of correspondence is so drawn that it cannot be mistaken for a real line in either diagram. (See *GEOMETRY: Descriptive.*)

In the stereoscopic the two diagrams, by the combined use of which the form of bodies in three dimensions is recognized, are projections of the bodies taken from two points so near each other that, by viewing the two diagrams simultaneously, one with each eye, we identify the corresponding points intuitively. The method in which we simultaneously contemplate two figures, and recognize a correspondence between certain points in the one figure and certain points in the other, is one of the most powerful and fertile methods hitherto known in science. Thus in pure geometry the theories of similar, reciprocal and inverse figures have led to many extensions of the science. It is sometimes spoken of as the method or principle of Duality. (See *GEOMETRY Projective.*)

DIAGRAMS IN MECHANICS

The study of the motion of a material system is much assisted by the use of a series of diagrams representing the configuration, displacement and acceleration of the parts of the system.

Diagram of Configuration.—In considering a material system it is often convenient to suppose that we have a record of its position at any given instant in the form of a diagram of configuration. The position of any particle of the system is defined by drawing a straight line or vector from the origin, or point of reference, to the given particle. The position of the particle with respect to the origin is determined by the magnitude and direction of this vector. If in the diagram we draw from the origin (which need not be the same point of space as the origin for the material system) a vector equal and parallel to the vector which determines the position of the particle, the end of this vector will indicate the position of the particle in the diagram of configuration. If this is done for all the particles we shall have a system of points in the diagram of configuration, each of which corresponds to a particle of the material system, and the relative positions of any pair of these points will be the same as the relative positions of the material particles which correspond to them.

We have hitherto spoken of two origins or points from which the vectors are supposed to be drawn—one for the material system, the other for the diagram. These points, however, and the vectors drawn from them, may now be omitted, so that we have on the one hand the material system and on the other a set of points, each point corresponding to a particle of the system, and the whole representing the configuration of the system at a given instant.

This is called a diagram of configuration.

Diagram of Displacement.—Let us next consider two diagrams of configuration of the same system, corresponding to two different instants. We call the first the initial configuration and the second the final configuration, and the passage from the one configuration to the other we call the displacement of the system. We do not at present consider the length of time during which the displacement was effected, nor the intermediate stages through which it passed, but only the final result—a change of configuration. To study this change we construct a diagram of displacement.

Let A, B, C be the points in the initial diagram of configuration, and A', B', C' be the corresponding points in the final diagram of configuration. From a , the origin of the diagram of displacement, draw a vector aa' equal and parallel to AA' , ab equal and parallel to BB' , or to CC' , and so on. The points a, b, c, \dots will be such that the vector ab indicates the displacement of B relative to A , and so on. The diagram containing the points a, b, c, \dots is therefore called the diagram of displacement.

In constructing the diagram of displacement we have hitherto assumed that we know the absolute displacements of the points of the system. For we are required to draw a line equal and parallel to AA' , which we cannot do unless we know the absolute final position of A with respect to its initial position. In this diagram of displacement there is therefore, besides the points a, b, c, \dots , an origin, o , which represents a point absolutely fixed in space. This is necessary because the two configurations do not exist at the same time; and therefore to express their relative position we require to know a point which remains the same at the beginning and end of the time.

But we may construct the diagram in another way which does not assume a knowledge of absolute displacement or of a point fixed in space. Assuming any point and calling it o , draw oa parallel and equal to BA in the initial configuration, and from a draw ab parallel and equal to $A'B'$ in the final configuration. It is easy to see that the position of the point b relative to a will be the same by this construction as by the former construction, only we must observe that in this

second construction we use only vectors such as $AB, A'B'$, which represent the relative position of points both of which exist simultaneously, instead of vectors such as AA', BB' , which express the position of a point at one instant relative to its position at a former instant, and which therefore cannot be determined by observation, because the two ends of the vector do not exist simultaneously.

It appears therefore that the diagram of displacements, when drawn by the first construction, includes an origin o , which indicates that we have assumed a knowledge of absolute displacements. But no such point occurs in the second construction, because we use such vectors only as we can actually observe. Hence the diagram of displacements without an origin represents neither more nor less than all we can ever know about the displacement of the material system.

Diagram of Velocity.—If the relative velocities of the points of the system are constant, then the diagram of displacement corresponding to an interval of a unit of time between the initial and the final configuration is called a diagram of relative velocity. If the relative velocities are not constant, we suppose another system in which the velocities are equal to the velocities of the given system at the given instant and continue constant for a unit of time. The diagram of displacements for this imaginary system is the required diagram of relative velocities of the actual system at the given instant. It is easy to see that the diagram gives the velocity of any one point relative to any other, but cannot give the absolute velocity of any of them.

Diagram of Acceleration.—By the same process by which we formed the diagram of displacements from the two diagrams of initial and final configuration, we may form a diagram of changes of relative velocity from the two diagrams of initial and final velocities. This diagram may be called that of total accelerations in a finite interval of time. And by the same process by which we deduced the diagram of velocities from that of displacements we may deduce the diagram of rates of acceleration from that of total acceleration.

We have mentioned this system of diagrams in elementary kinematics because they are found to be of use especially when we have to deal with material systems containing a great number of parts, as in the kinetic theory of gases. The diagram of configuration then appears as a region of space swarming with points representing molecules, and the only way in which we can investigate it is by considering the number of such points in unit of volume in different parts of that region, and calling this the density of the gas.

In like manner the diagram of velocities appears as a region containing points equal in number but distributed in a different manner, and the number of points in any given portion of the region expresses the number of molecules whose velocities lie within given limits. We may speak of this as the velocity-density.

Diagrams of Stress.—Graphical methods are peculiarly applicable to statical questions, because the state of the system is constant, so that we do not need to construct a series of diagrams corresponding to the successive states of the system. The most useful of these applications, collectively termed Graphic Statics, relates to the equilibrium of plane framed structures familiarly represented in bridges and roof-trusses. Two diagrams are used, one called the diagram of the frame and the other called the diagram of stress. The structure itself consists of a number of separable pieces or links joined together at their extremities. In practice these joints have friction, or may be made purposely stiff, so that the force acting at the extremity of a piece may not pass exactly through the axis of the joint; but as it is unsafe to make the stability of the structure depend in any degree upon the stiffness of joints, we assume in our calculations that all the joints are perfectly smooth, and therefore that the force acting on the end of any link passes through the axis of the joint.

The axes of the joints of the structure are represented by points in the diagram of the frame. The link which connects two joints in the actual structure may be of any shape, but in the diagram of the frame it is represented by a straight line joining the points representing the two joints. If no force acts on the link except the two forces acting through the centres of the joints, these two forces must be equal and opposite, and their direction must coincide with the straight line joining the centres of the joints. If the force acting on either extremity of the link is directed towards the other extremity, the stress on the link is called pressure and the link is called a "strut." If it is directed away from the other extremity, the stress on the link is called tension and the link is called a "tie." In this case, therefore, the only stress acting in a link is a pressure or a tension in the direction of the straight line which represents it in the diagram of the frame, and all that we have to do is to find the magnitude of this stress. In the actual structure gravity acts on every part of the link, but in the diagram we substitute for the actual weight of the different parts of the link two weights which have the same resultant acting at the extremities of the link.

We may now treat the diagram of the frame as composed of links without weight, but loaded at each joint with a weight made up of portions of the weights of all the links which meet in that joint. If any link has more than two joints we may substitute for it in the diagram an imaginary stiff frame, consisting of links, each of which has only two joints. The diagram of the frame is now reduced to a system of points, certain pairs of which are joined by straight lines, and each point is in general acted on by a weight or other force acting between it and some point external to the system. To complete

the diagram we may represent these external forces as links, that is to say, straight lines joining the points of the frame to points external to the frame. Thus each weight may be represented by a link joining the point of application of the weight with the centre of the earth.

But we can always construct an imaginary frame having its joints in the lines of action of these external forces, and this frame, together with the real frame and the links representing external forces, which join points in the one frame to points in the other frame, make up together a complete self-strained system in equilibrium, consisting of points connected by links acting by pressure or tension. We may in this way reduce any real structure to the case of a system of points with attractive or repulsive forces acting between certain pairs of these points, and keeping them in equilibrium. The direction of each of these forces is sufficiently indicated by that of the line joining the points, so that we have only to determine its magnitude. We might do this by calculation, and then write down on each link the pressure or the tension which acts in it.

We should in this way obtain a mixed diagram in which the stresses are represented graphically as regards direction and position, but symbolically as regards magnitude. But we know that a force may be represented in a purely graphical manner by a straight line in the direction of the force containing as many units of length as there are units of force in the force. The end of this line is marked with an arrow-head to show in which direction the force acts. According to this method each force is drawn in its proper position in the diagram of configuration of the frame. Such a diagram might be useful as a record of the result of calculation of the magnitude of the forces, but it would be of no use in enabling us to test the correctness of the calculation.

But we have a graphical method of testing the equilibrium of any set of forces acting at a point. We draw in series a set of lines parallel and proportional to these forces. If these lines form a closed polygon the forces are in equilibrium. (See MECHANICS.) We might in this way form a series of polygons of forces, one for each joint of the frame. But in so doing we give up the principle of drawing the line representing a force from the point of application of the force, for all the sides of the polygon cannot pass through the same point, as the forces do. We also represent every stress twice over, for it appears as a side of both the polygons corresponding to the two joints between which it acts. But if we can arrange the polygons in such a way that the sides of any two polygons which represent the same stress coincide with each other, we may form a diagram in which every stress is represented in direction and magnitude, though not in position, by a single line which is the common boundary of the two polygons which represent the joints at the extremities of the corresponding piece of the frame.

We have thus obtained a pure diagram of stress in which no attempt is made to represent the configuration of the material system, and in which every force is not only represented in direction and magnitude by a straight line, but the equilibrium of the forces at any joint is manifest by inspection, for we have only to examine whether the corresponding polygon is closed or not.

The relations between the diagram of the frame and the diagram of stress are as follows:—To every link in the frame corresponds a straight line in the diagram of stress which represents in magnitude and direction the stress acting in that link; and to every joint of the frame corresponds a closed polygon in the diagram, and the forces acting at that joint are represented by the sides of the polygon taken in a certain cyclical order, the cyclical order of the sides of the two adjacent polygons being such that their common side is traced in opposite directions in going round the two polygons.

The direction in which any side of a polygon is traced is the direction of the force acting on that joint of the frame which corresponds to the polygon, and due to that link of the frame which corresponds to the side. This determines whether the stress of the link is a pressure or a tension. If we know whether the stress of any one link is a pressure or a tension, this determines the cyclical order of the sides of the two polygons corresponding to the ends of the links, and therefore the cyclical order of all the polygons, and the nature of the stress in every link of the frame.

Reciprocal Diagrams.—When to every point of concurrence of the lines in the diagram of stress corresponds a closed polygon in the skeleton of the frame, the two diagrams are said to be reciprocal.

The first extensions of the method of diagrams of forces to other cases than that of the funicular polygon were given by Rankine in his *Applied Mechanics* (1857). The method was independently applied to a large number of cases by W. P. Taylor, a practical draughtsman in the office of J. B. Cochrane, and by Professor Clerk Maxwell in his lectures in King's College, London. In the *Phil. Mag.* for 1864 the latter pointed out the reciprocal properties of the two diagrams, and in a paper on "Reciprocal Figures, Frames and Diagrams of Forces," *Trans. R.S. Edin.* vol. xvi., 1870, he showed the relation of the method to Airy's function of stress and to other mathematical methods. Professor Fleeming Jenkin has given a number of applications of the method to practice (*Trans. R.S. Edin.* vol. xxv.).

L. Cremona (*La Figura reciproca nella statica grafica*, 1872) deduced the construction of reciprocal figures from the theory of the two components of a wrench as developed by Möbius. Karl Culmann, in his *Graphische Statik* (1st ed. 1864-1866, 2nd ed. 1875), made great use

of diagrams of forces, some of which, however, are not reciprocal. Maurice Levy in his *Statique graphique* (1874) has treated the whole subject in an elementary but copious manner, and R. H. Bow, in his *The Economics of Construction in Relation to Framed Structures* (1873), materially simplified the process of drawing a diagram of stress reciprocal to a given frame acted on by a system of equilibrating external forces.

Instead of lettering the joints of the frame, as is usually done, or the links of the frame, as was the custom of Clerk Maxwell, Bow places a letter in each of the polygonal areas enclosed by the links of the frame, and also in each of the divisions of surrounding space as

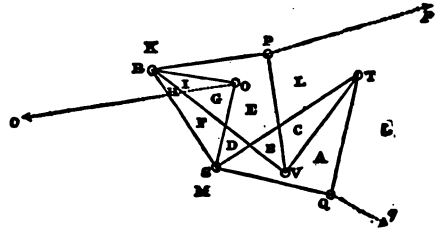

FIG. 1.—Diagram of Configuration.

separated by the lines of action of the external forces. When one link of the frame crosses another, the point of apparent intersection of the links is treated as if it were a real joint, and the stresses of each of the intersecting links are represented twice in the diagram of stress, as the opposite sides of the parallelogram which corresponds to the point of intersection.

This method is followed in the lettering of the diagram of configuration (fig. 1), and the diagram of stress (fig. 2) of the linkwork which Professor Sylvester has called a quadruplane.

In fig. 1 the real joints are distinguished from the places where one link appears to cross another by the little circles O, P, Q, R, S, T, V. The four links RSTV form a "contraparallelogram" in which RS=TV and RV=ST. The triangles ROS, RPV, TQS are similar to each other. A fourth triangle (INV), not drawn in the figure, would complete the quadruplane. The four points O, P, N, Q form a parallelogram whose angle POQ is constant and equal to $\pi - \text{SOR}$. The product of the distances OP and OQ is constant. The linkwork may be fixed at O. If any figure is traced by P, Q will trace the

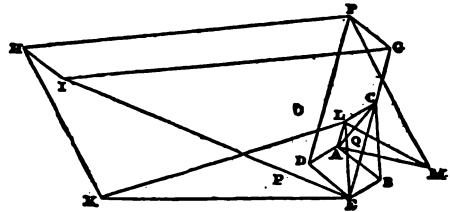

FIG. 2.—Diagram of Stress.

inverse figure, but turned round O through the constant angle POQ. In the diagram forces Pp, Qq are balanced by the force Co at the fixed point. The forces Pp and Qq are necessarily inversely as OP and OQ, and make equal angles with those lines.

Every closed area formed by the links or the external forces in the diagram of configuration is marked by a letter which corresponds to a point of concurrence of lines in the diagram of stress. The stress in the link which is the common boundary of two areas is represented in the diagram of stress by the line joining the points corresponding to those areas. When a link is divided into two or more parts by lines crossing it, the stress in each part is represented by a different line for each part, but as the stress is the same throughout the link these lines are all equal and parallel. Thus in the figure the stress in RV is represented by the four equal and parallel lines HI, FG, DE, and AB. If two areas have no part of their boundary in common the letters corresponding to them in the diagram of stress are not joined by a straight line. If, however, a straight line were drawn between them, it would represent in direction and magnitude the resultant of all the stresses in the links which are cut by any line, straight or curved, joining the two areas. For instance the areas F and C in fig. 1 have no common boundary, and the points F and C in fig. 2 are not joined by a straight line. But every path from the area F to the area C in fig. 1 passes through a series of other areas, and each passage from one area into a contiguous area corresponds to a line drawn in the diagram of stress. Hence the whole path from F

to C in fig. 1 corresponds to a path formed of lines in fig. 2 and extending from F to C, and the resultant of all the stresses in the ink cut by the path is represented by FC in fig. 2.

Many examples of stress diagrams are given in the article on bridges (q.v.).

Automatic Description of Diagrams.

There are many other kinds of diagrams in which the two co-ordinates of a point in a plane are employed to indicate the simultaneous values of two related quantities. If a sheet of paper is made to move, say horizontally, with a constant known velocity, while a tracing point is made to move in a vertical straight line, the height varying as the value of any given physical quantity, the point will trace out a curve on the paper from which the value of that quantity at any given time may be determined. This principle is applied to the automatic registration of phenomena of all kinds, from those of meteorology and terrestrial magnetism to the velocity of cannon-shot, the vibrations of sounding bodies, the motions of animals, voluntary and involuntary, and the currents in electric telegraphs.

In Watt's indicator for steam engines the paper does not move with a constant velocity, but its displacement is proportional to that of the piston of the engine, while that of the tracing point is proportional to the pressure of the steam. Hence the co-ordinates of a point of the curve traced on the diagram represent the volume and the pressure of the steam in the cylinder. The indicator-diagram not only supplies a record of the pressure of the steam at each stage of the stroke of the engine, but indicates the work done by the steam in each stroke by the area enclosed by the curve traced on the diagram. (J. C. M.)

DIAL and DIALLING. Dialling, sometimes called gnomonics, is a branch of applied mathematics which treats of the construction of sun-dials, that is, of those instruments, either fixed or portable, which determine the divisions of the day (Lat. *dies*) by the motion of the shadow of some object on which the sun's rays fall. It must have been one of the earliest applications of a knowledge of the apparent motion of the sun; though for a long time men would probably be satisfied with the division into morning and afternoon as marked by sun-rise, sun-set and the greatest elevation.

History.—The earliest mention of a sun-dial is found in Isaiah xxxviii. 8: "Behold, I will bring again the shadow of the degrees which is gone down in the sun-dial of Ahaz ten degrees backward." The date of this would be about 700 years before the Christian era, but we know nothing of the character or construction of the instrument. The earliest of all sun-dials of which we have any certain knowledge was the hemisphere, or hemisphere, of the Chaldean astronomer Berosus, who probably lived about 300 B.C. It consisted of a hollow hemisphere placed with its rim perfectly horizontal, and having a bead, or globe, fixed in any way at the centre. So long as the sun remained above the horizon the shadow of the bead would fall on the inside of the hemisphere, and the path of the shadow during the day would be approximately a circular arc. This arc, divided into twelve equal parts, determined twelve equal intervals of time for that day. Now, supposing this were done at the time of the solstices and equinoxes, and on as many intermediate days as might be considered sufficient, and then curve lines drawn through the corresponding points of division of the different arcs, the shadow of the bead falling on one of these curve lines would mark a division of time for that day, and thus we should have a sun-dial which would divide each period of daylight into twelve equal parts. These equal parts were called *temporary hours*; and, since the duration of daylight varies from day to day, the temporary hours of one day would differ from those of another; but this inequality would probably be disregarded at that time, and especially in countries where the variation between the longest summer day and the shortest winter day is much less than in our climates.

The dial of Berosus remained in use for centuries. The Arabians, as appears from the work of Albatgenius, still followed the same construction about the year A.D. 900. Four of these dials have in modern times been found in Italy. One, discovered at Pistoia in 1746, is supposed to have belonged to Cicero, who, in one of his letters, says that he had sent a dial of this kind to his son near Tusculum. The second and third were found in 1751—one at Castel-Nuovo and the other at Rignano; and a fourth was found in 1762 at Pompeii. G. H. Martini in his *Abhandlungen von den Sonnenuhren der Alten* (Leipzig, 1777), says that this

dial was made for the latitude of Memphis; it may therefore be the work of Egyptians, perhaps constructed in the school of Alexandria.

Herodotus recorded that the Greeks derived from the Babylonians the use of the gnomon, but the great progress made by the Greeks in geometry enabled them in later times to construct dials of great complexity, some of which remain to us, and are proof not only of extensive knowledge but also of great ingenuity.

Ptolemy's *Almagest* treats of the construction of dials by means of his *analemma*, an instrument which solved a variety of astronomical problems. The constructions given by him were sufficient for regular dials, that is, horizontal dials, or vertical dials facing east, west, north or south, and these are the only ones he treats of. It is certain, however, that the ancients were able to construct declining dials, as is shown by that most interesting monument of ancient gnomonics—the Tower of the Winds at Athens. This is a regular octagon, on the faces of which the eight principal winds are represented, and over them eight different dials—four facing the cardinal points and the other four facing the intermediate directions. The date of the dials is long subsequent to that of the tower; for Vitruvius, who describes the tower in the sixth chapter of his first book, says nothing about the dials, and as he has described all the dials known in his time, we must believe that the dials of the tower did not then exist. The hours are still the temporary hours or, as the Greeks called them, *hectemoria*.

The first sun-dial erected at Rome was in the year 290 B.C., and this Papirius Cursor had taken from the Samnites. A dial which Valerius Messalla had brought from Catania, the latitude of which is five degrees less than that of Rome, was placed in the forum in the year 261 B.C. The first dial actually constructed at Rome was in the year 164 B.C., by order of Q. Marcius Philippus, but as no other Roman has written on gnomonics, this was perhaps the work of a foreign artist. If, too, we remember that the dial found at Pompeii was made for the latitude of Memphis, and consequently less adapted to its position than that of Catania to Rome, we may infer that mathematical knowledge was not cultivated in Italy.

The Arabians were much more successful. They attached great importance to gnomonics, the principles of which they had learned from the Greeks, but they greatly simplified and diversified the Greek constructions. One of their writers, Abu'l Hassan, who lived about the beginning of the 13th century, taught them how to trace dials on cylindrical, conical and other surfaces. He even introduced *equal or equinoctial hours*, but the idea was not supported, and the temporary hours alone continued in use.

Where or when the great and important step already conceived by Abu'l Hassan, and perhaps by others, of reckoning by *equal hours* was generally adopted cannot now be determined. The history of gnomonics from the 13th to the beginning of the 16th century is almost a blank, and during that time the change took place. We can see, however, that the change would necessarily follow the introduction of clocks and other mechanical methods of measuring time; for, however imperfect these were, the hours they marked would be of the same length in summer and in winter, and the discrepancy between these equal hours and the temporary hours of the sun-dial would soon be too important to be overlooked. Now, we know that a balance clock was put up in the palace of Charles V. of France about the year 1370, and we may reasonably suppose that the new sun-dials came into general use during the 14th and 15th centuries.

Among the earliest of the modern writers on gnomonics was Sebastian Münster (q.v.), who published his *Horologigraphia* at Basel in 1531. He gives a number of correct rules, but without demonstrations. Among his inventions was a moon-dial,¹ but this does not admit of much accuracy.

During the 17th century dialling was discussed at great length by many writers on astronomy. Clavius devotes a quarto

¹ In one of the courts of Queens' College, Cambridge, there is an elaborate sun-dial dating from the end of the 17th or beginning of the 18th century, and around it a series of numbers which make it available as a moon-dial when the moon's age is known.

volume of 800 pages entirely to the subject. This was published in 1612, and may be considered to contain all that was known at that time.

In the 18th century clocks and watches began to supersede sun-dials, and these have gradually fallen into disuse except as an additional ornament to a garden, or in remote country districts where the old dial on the church tower still serves as an occasional check on the modern clock by its side. The art of constructing dials may now be looked upon as little more than a mathematical recreation.

General Principles.—The diurnal and the annual motions of the earth are the elementary astronomical facts on which dialling is founded. That the earth turns upon its axis uniformly from west to east in twenty-four hours, and that it is carried round the sun in one year at a nearly uniform rate, is the correct way of expressing these facts. But the effect will be precisely the same, and it will suit our purpose better, and make our explanations easier, if we adopt the ideas of the ancients, of which our senses furnish apparent confirmation, and assume the earth to be fixed. Then, the sun and stars revolve round the earth's axis uniformly from east to west once a day—the sun lagging a little behind the stars, making its day some four minutes longer—so that at the end of the year it finds itself again in the same place, having made a complete revolution of the heavens relatively to the stars from west to east.

The fixed axis about which all these bodies revolve daily is a line through the earth's centre; but the radius of the earth is so small, compared with the enormous distance of the sun, that, if we draw a parallel axis through any point of the earth's surface, we may safely look on that as being the axis of the celestial motions. The error in the case of the sun would not, at its maximum, that is, at 6 A.M. and 6 P.M., exceed half a second of time, and at noon would vanish. An axis so drawn is in the plane of the meridian, and points to the pole, its elevation being equal to the latitude of the place.

The diurnal motion of the stars is strictly uniform, and so would that of the sun be if the daily retardation of about four minutes, spoken of above, were always the same. But this is constantly altering, so that the time, as measured by the sun's motion, and also consequently as measured by a sun-dial, does not move on at a strictly uniform pace. This irregularity, which is slight, would be of little consequence in the ordinary affairs of life, but clocks and watches being mechanical measures of time could not, except by extreme complication, be made to follow this irregularity, even if desirable.

The clock is constructed to mark uniform time in such wise that the length of the clock day shall be the average of all the solar days in the year. Four times a year the clock and the sun-dial agree exactly; but the sun-dial, now going a little slower, now a little faster, will be sometimes behind, sometimes before the clock—the greatest accumulated difference being about sixteen minutes for a few days in November, but on the average much less. The four days on which the two agree are April 15, June 15, September 1 and December 24.

Clock-time is called *mean time*, that marked by the sun-dial is called *apparent time*, and the difference between them is the *equation of time*. It is given in most calendars and almanacs, frequently under the heading "clock slow," "clock fast." When the time by the sun-dial is known, the equation of time will at once enable us to obtain the corresponding clock-time, or vice versa.

Atmospheric refraction introduces another error by altering the apparent position of the sun; but the effect is too small to need consideration in the construction of an instrument which, with the best workmanship, does not after all admit of very great accuracy.

The general principles of dialling may now be readily understood. The problem before us is the following:—A rod, or style, as it is called, being firmly fixed in a direction parallel to the earth's axis, we have to find how and where points or lines of reference must be traced on some fixed surface behind the style, so that when the shadow of the style falls on a certain one of these lines, we may know that at that moment it is solar noon,—that is, that the plane through the style and through the sun then coincides with the meridian; again, that when the shadow reaches the next line of reference, it is 1 o'clock by solar time, or, which comes to the same thing, that the above plane through the style and through the sun has just turned through the twenty-fourth part of a complete revolution; and so on for the subsequent hours,—the hours before noon being indicated in a similar manner. The style and the surface on which these lines are traced together constitute the dial.

The position of an intended sun-dial having been selected—whether on church tower, south front of farmstead or garden wall—the surface must be prepared, if necessary, to receive the hour-lines.

The chief, and in fact the only practical difficulty will be the accurate fixing of the style, for on its accuracy the value of the instrument depends. It must be in the meridian plane, and must make an angle with the horizon equal to the latitude of the place. The latter condition will offer no difficulty, but the exact determination of the meridian plane which passes through the point where the style is fixed to the surface is not so simple. At present we shall assume that the style has been fixed in its true position. The style itself will be

usually a stout metal wire, and when we speak of the shadow cast by the style it must always be understood that the middle line of the thin band of shade is meant.

The point where the style meets the dial is called the centre of the dial. It is the centre from which all the hour-lines radiate.

The position of the XII o'clock line is the most important to determine accurately, since all the others are usually made to depend on this one. We cannot trace it correctly on the dial until the style has been itself accurately fixed in its proper place. When that is done the XII o'clock line will be found by the intersection of the dial surface with the vertical plane which contains the style; and the most simple way of drawing it on the dial will be by suspending a plummet from some point of the style whence it may hang freely, and waiting until the shadows of both style and plumb-line coincide on the dial. This single shadow will be the XII o'clock line.

In one class of dials, namely, all the vertical ones, the XII o'clock line is simply the vertical line from the centre; it can, therefore, at once be traced on the dial face by using a fine plumb-line.

The XII o'clock line being traced, the easiest and most accurate method of tracing the other hour-lines would, at the present day when good watches are common, be by marking where the shadow of the style falls when 1, 2, 3, &c., hours have elapsed since noon, and the next morning by the same means the forenoon hour-lines could be traced; and in the same manner the hours might be subdivided into halves and quarters, or even into minutes.

But formerly, when watches did not exist, the tracing of the I, II, III, &c., o'clock lines was done by calculating the angle which each of these lines would make with the XII o'clock line. Now, except in the simple cases of a horizontal dial or of a vertical dial-facing a cardinal point, this would require long and intricate calculations, or elaborate geometrical constructions, implying considerable mathematical knowledge, but also introducing increased chances of error. The chief source of error would lie in the uncertainty of the data; for the position of the dial-plane would have to be found before the calculations began,—that is, it would be necessary to know exactly by how many degrees it declined from the south towards the east or west, and by how many degrees it inclined from the vertical. The ancients, with the means at their disposal, could obtain these results only very roughly.

Dials received different names according to their position:—

Horizontal dials, when traced on a horizontal plane;
Vertical dials, when on a vertical plane facing one of the cardinal points;

Vertical declining dials, on a vertical plane not facing a cardinal point;

Inclining dials, when traced on planes neither vertical nor horizontal (these were further distinguished as *reclining* when leaning backwards from an observer, *proclining* when leaning forwards);

Equinoctial dials, when the plane is at right angles to the earth's axis, &c. &c.

Dial Construction.—A very correct view of the problem of dial construction may be obtained as follows:—

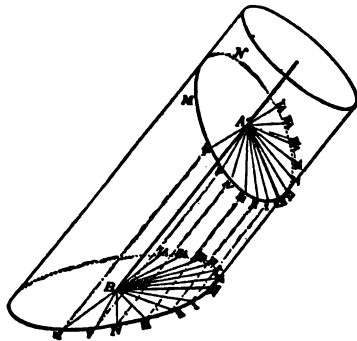

FIG. 1.

Conceive a transparent cylinder (fig. 1) having an axis AB parallel to the axis of the earth. On the surface of the cylinder let equidistant generating lines be traced 15° apart, one of them XII . . . XII being in the meridian plane through AB, and the others I . . . I, II . . . II, &c., following in the order of the sun's motion.

Then the shadow of the line AB will obviously fall on the line XII . . . XII at apparent noon, on the line I . . . I at one hour after noon, on II . . . II at two hours after noon, and so on. If now the cylinder be cut by any plane MN representing the plane on which the dial is to be traced, the shadow of AB will be intercepted by this plane and fall on the lines AXII AI, AII, &c.

The construction of the dial consists in determining the angles made

by AI, AII, &c. with AXII; the line AXII itself, being in the vertical plane through AB, may be supposed known.

For the purposes of actual calculation, perhaps a transparent sphere will, with advantage, replace the cylinder, and we shall here apply it to calculate the angles made by the hour-line with the XII o'clock line in the two cases of a horizontal dial and of a vertical south dial.

Horizontal Dial.—Let PEP (fig. 2), the axis of the supposed transparent sphere, be directed towards the north and south poles of the heavens. Draw the two great circles, HMA, QMA, the former

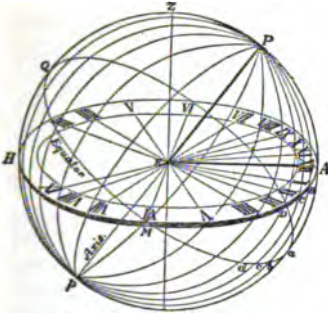

FIG. 2.

horizontal, the other perpendicular to the axis Pp, and therefore coinciding with the plane of the equator. Let EZ be vertical, then the circle QZP will be the meridian, and by its intersection A with the horizontal circle will determine the XII o'clock line EA. Next divide the equatorial circle QMa into 24 equal parts *ab, bc, cd, &c.* . . . of 15° each, beginning from the meridian Pa, and through the various points of division and the poles draw the great circles Pp*ab*, Pp*bc*, &c. . . . These will exactly correspond to the equidistant generating lines on the cylinder in the previous construction, and the shadow of the style will fall on these circles after successive intervals of 1, 2, 3, &c., hours from noon. If they meet the horizontal circle in the points B, C, D, &c., then EB, EC, ED, &c. . . will be the I, II, III, &c., hour-lines required; and the problem of the horizontal dial consists in calculating the angles which these lines make with the XII o'clock line EA, whose position is known. The spherical triangles PAB, PAC, &c., enable us to do this readily. They are all right-angled at A, the side PA is the latitude of the place, and the angles APB, APC, &c., are respectively 15°, 30°, &c., then
 $\tan AB = \tan 15^\circ \sin \text{latitude}$,
 $\tan AC = \tan 30^\circ \sin \text{latitude}$,
 &c. &c.

These determine the sides AB, AC, &c., that is, the angles AEB, AEC, &c., required.
 The I o'clock hour-line EB must make an angle with the meridian EA of 11° 51' on a London dial, of 12° 31' at Edinburgh, of 11° 23' at Paris, 12° 0' at Berlin, 9° 55' at New York and 9° 19' at San Francisco. In the same way may be found the angles made by the other hour-lines.

The calculations of these angles must extend throughout one quadrant from noon to VI o'clock, but need not be carried further, because all the other hour-lines can at once be deduced from these. In the first place the dial is symmetrically divided by the meridian, and therefore two times equidistant from noon will have their hour-lines equidistant from the meridian; thus the XI o'clock line and the I o'clock line must make the same angles with it, the X o'clock line the same as the II o'clock, and so on. And next, the 24 great circles, which were drawn to determine these lines, are in reality only 12; for clearly the great circle which gives I o'clock after midnight, and that which gives I o'clock after noon, are one and the same, and so also for the other hours. Therefore the hour-lines between VI in the evening and VI the next morning are the prolongations of the remaining twelve.

Let us now remove the imaginary sphere with all its circles, and retain only the style EP and the plane HMA with the lines traced on it, and we shall have the horizontal dial.

On the longest day in London the sun rises a little before 4 o'clock, and sets a little after 8 o'clock; there is therefore no necessity for extending a London dial beyond those hours. At Edinburgh the sunsets will be a little longer, while at Hammerfest, which is within the Arctic circle, the whole circuit will be required.

Instead of a wire style it is often more convenient to use a metal plate from one quarter to half an inch in thickness. This plate, which is sometimes in the form of a right-angled triangle, must have an acute angle equal to the latitude of the place, and, when properly fixed in a vertical position on the dial, its two faces must coincide with the meridian plane, and the sloping edges formed by the thickness of the plate must point to the pole and form two parallel styles.

Since there are two styles, there must be two dials, or rather two half dials, because a little consideration will show that, owing to the thickness of the plate, these styles will only one at a time cast a shadow. Thus the eastern edge will give the shadow for all hours before 6 o'clock in the morning. From 6 o'clock until noon the western edge will be used. At noon it will change again to the eastern edge until 6 o'clock in the evening, and finally the western edge for the remaining hours of daylight.

The centres of the two dials will be at the points where the styles meet the dial face; but, in drawing the hour-lines, we must be careful to draw only those lines for which the corresponding style is able to give a shadow as explained above. The dial will thus have the appearance of a single dial plate, and there will be no confusion (see fig. 3).

The line of demarcation between the shadow and the light will be better defined than when a wire style is used; but the indications by this double dial will always be one minute too fast in the morning and one minute too slow in the afternoon. This is owing to the magnitude

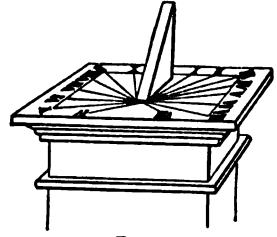

FIG. 3.

of the sun, whose angular breadth is half a degree. The well-defined shadows are given, not by the centre of the sun, as we should require them, but by the forward limb in the morning and by the backward one in the afternoon; and the sun takes just about a minute to advance through a space equal to its half-breadth.

Dials of this description are frequently met with. The dial plate is of metal as well as the vertical piece upon it, and they may be purchased ready for placing on the pedestal,—the dial with all the hour-lines traced on it and the style plate firmly fastened in its proper position, if not even cast in the same piece with the dial plate.

When placing it on the pedestal care must be taken that the dial be perfectly horizontal and accurately oriented. The levelling will be done with a spirit-level, and the orientation will be best effected either in the forenoon or in the afternoon, by turning the dial plate till the time given by the shadow (making the *one* minute correction mentioned above) agrees with a good watch whose error on solar time is known. It is, however, important to bear in mind that a dial, so built up beforehand, will have the angle at the base equal to the latitude of some selected place, such as London, and the hour-lines will be drawn in directions calculated for the same latitude. Such a dial can therefore not be used near Edinburgh or Glasgow, although it would, without appreciable error, be adapted to any place whose latitude did not differ more than 20 or 30 m. from that of London, and it would be safe to employ it in Essex, Kent or Wiltshire.

If a series of such dials were constructed, differing by 30 m. in latitude, then an intending purchaser could select one adapted to a place whose latitude was within 15 m. of his own, and the error of time would never exceed a small fraction of a minute. The following table will enable us to check the accuracy of the hour-lines and of the angle of the style,—all angles on the dial being readily measured with an ordinary protractor. It extends from 50° lat. to 59½° lat., and therefore includes the whole of Great Britain and Ireland:—

LAT.	XL A.M. I. P.M.	X. A.M. II. P.M.	IX. A.M. III. P.M.	VIII. A.M. IV. P.M.	VII. A.M. V. P.M.	VI. A.M. VI. P.M.
50° 0'	11° 36'	23° 51'	37° 27'	53° 0'	70° 43'	90° 0'
50 30	11 41	24 1	37 39	53 12	70 51	90 0
51 0	11 46	24 10	37 51	53 23	70 59	90 0
51 30	11 51	24 19	38 3	53 35	71 6	90 0
52 0	11 55	24 28	38 14	53 46	71 13	90 0
52 30	12 0	24 37	38 25	53 57	71 20	90 0
53 0	12 5	24 45	38 37	54 8	71 27	90 0
53 30	12 9	24 54	38 48	54 19	71 34	90 0
54 0	12 14	25 2	38 58	54 29	71 40	90 0
54 30	12 18	25 10	39 9	54 39	71 47	90 0
55 0	12 23	25 19	39 19	54 49	71 53	90 0
55 30	12 27	25 27	39 30	54 59	71 59	90 0
56 0	12 31	25 35	39 40	55 9	72 5	90 0
56 30	12 36	25 43	39 50	55 18	72 11	90 0
57 0	12 40	25 50	39 59	55 27	72 17	90 0
57 30	12 44	25 58	40 9	55 36	72 22	90 0
58 0	12 48	26 5	40 18	55 45	72 28	90 0
58 30	12 52	26 13	40 27	55 54	72 33	90 0
59 0	12 56	26 20	40 36	56 2	72 39	90 0
59 30	13 0	26 27	45 45	56 11	72 44	90 0

Vertical South Dial.—Let us take again our imaginary transparent sphere QZPA (fig. 4), whose axis PEP is parallel to the earth's axis. Let Z be the zenith, and, consequently, the great circle QZP the

meridian. Through E, the centre of the sphere, draw a vertical plane facing south. This will cut the sphere in the great circle ZMA, which, being vertical, will pass through the zenith, and, facing south, will be at right angles to the meridian. Let QMa be the equatorial circle, obtained by drawing a plane through E at right angles to the axis PEP. The lower portion Ep of the axis will be the style, the vertical line EA in the meridian plane will be the XII o'clock line, and the line EM, which is obviously horizontal, since M is the intersection of two great circles ZM, QM, each at right angles to the vertical plane QZP, will be the VI o'clock line. Now, as in the previous problem, divide the equatorial circle into 24 equal arcs of 15° each, beginning at a, viz. ab, bc, &c.,—each quadrant aM, MQ, &c., containing 6,—then through each point of division and through the

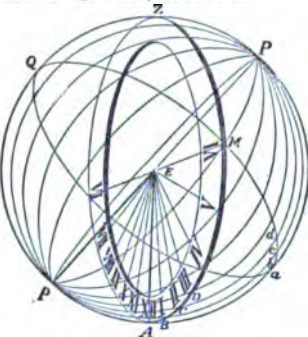

FIG. 4.

axis Pp draw a plane cutting the sphere in 24 equidistant great circles. As the sun revolves round the axis the shadow of the axis will successively fall on these circles at intervals of one hour, and if these circles cross the vertical circle ZMA in the points A, B, C, &c., the shadow of the lower portion Ep of the axis will fall on the lines EA, EB, EC, &c., which will therefore be the required hour-lines on the vertical dial, Ep being the style.

There is no necessity for going beyond the VI o'clock hour-line on each side of noon; for, in the winter months the sun sets earlier than 6 o'clock, and in the summer months it passes behind the plane of the dial before that time, and is no longer available.

It remains to show how the angles AEB, AEC, &c., may be calculated.

The spherical triangles pAB, pAC, &c., will give us a simple rule. These triangles are all right-angled at A, the side pA, equal to ZP, is the co-latitude of the place, that is, the difference between the latitude and 90°; and the successive angles ApB, ApC, &c., are 15°, 30°, &c., respectively. Then

$$\tan AB = \tan 15^\circ \sin \text{co-latitude};$$

$$\begin{aligned} \tan AB &= \tan 15^\circ \cos \text{latitude}, \\ \tan AC &= \tan 30^\circ \cos \text{latitude}, \\ &\text{\&c. \&c.} \end{aligned}$$

and the arcs AB, AC so found are the measure of the angles AEB, AEC, &c., required.

In this case the angles diminish as the latitudes increase, the opposite result to that of the horizontal dial.

Inclining, Reclining, &c., Dials.—We shall not enter into the calculation of these cases. Our imaginary sphere being, as before supposed, constructed with its centre at the centre of the dial, and all the hour-circles traced upon it, the intersection of these hour-circles with the plane of the dial will determine the hour-lines just as in the previous cases; but the triangles will no longer be right-angled, and the simplicity of the calculation will be lost, the chances of error being greatly increased by the difficulty of drawing the dial plane in its true position on the sphere, since that true position will have to be found from observations which can be only roughly performed.

In all these cases, and in cases where the dial surface is not a plane, and the hour-lines, consequently, are not straight lines, the only safe practical way is to mark rapidly on the dial a few points (one is sufficient when the dial face is plane) of the shadow at the moment when a good watch shows that the hour has arrived, and afterwards connect these points with the centre by a continuous line. Of course the style must have been accurately fixed in its true position before we begin.

Equatorial Dial.—The name equatorial dial is given to one whose plane is at right angles to the style, and therefore parallel to the equator. It is the simplest of all dials. A circle (fig. 5) divided into 24 equal arcs is placed at right angles to the style, and hour divisions are marked upon it. Then if care be taken that the style point accurately to the pole, and that the noon division coincide with the meridian plane, the shadow of the style will fall on the other divisions, each at its proper time. The divisions must be marked

on both sides of the dial, because the sun will shine on opposite sides in the summer and in the winter months, changing at each equinox.

To find the Meridian Plane.—We have, so far, assumed the meridian plane to be accurately known; we shall proceed to describe some of the methods by which it may be found.

The mariner's compass may be employed as a first rough approximation. It is well known that the needle of the compass, when free to move horizontally, oscillates upon its pivot and settles in a direction termed the magnetic meridian. This does not coincide with the true north and south line, but the difference between them is generally known with tolerable accuracy, and is called the variation of the compass. The variation differs widely at different parts of the surface of the earth, and is not stationary at any particular place, though the change is slow; and there is even a small daily oscillation which takes place about the mean position, but too small to need notice here (see MAGNETISM, TERRESTRIAL).

With all these elements of uncertainty, it is obvious that the compass can only give a rough approximation to the position of the meridian, but it will serve to fix the style so that only a small further alteration will be necessary when a more perfect determination has been made.

A very simple practical method is the following:—

Place a table (fig. 6), or other plane surface, in such a position that it may receive the sun's rays both in the morning and in the afternoon. Then carefully level the surface by means of a spirit-level. This must be done very accurately, and the table in that position made perfectly secure, so that there be no danger of its shifting during the day.

Next, suspend a plummet SH from a point S, which must be rigidly fixed. The extremity H, where the plummet just meets the surface, should be somewhere near the middle of one end of the table. With H for centre, describe any number of concentric arcs of circles, AB, CD, EF, &c.

A bead P, set in its place by friction, is threaded on the plummet line at some convenient height above H.

Everything being thus prepared, let us follow the shadow of the bead P as it moves along the surface of the table during the day. It will be found to describe

a curve ACE...FDB, approaching the point H as the sun advances towards noon, and receding from it afterwards.

(The curve is a conic section—an hyperbola in these regions.) At the moment when it crosses the arc AB, mark the point A; AP is then the direction of the sun, and, as AH is horizontal, the angle PAH is the altitude of the sun. In the afternoon mark the point B where it crosses

the same arc; then the angle PBH is the altitude. But the right-angled triangles PHA, PHB are obviously equal; and the sun has therefore the same altitudes at those two instants, the one before, the other after noon. It follows that, if the sun has not changed its declination during the interval, the two positions will be symmetrically placed one on each side of the meridian. Therefore, drawing the chord AB, and bisecting it in M, HM will be the meridian line.

Each of the other concentric arcs, CD, EF, &c., will furnish its meridian line. Of course these should all coincide, but if not, the mean of the positions thus found must be taken.

The proviso mentioned above, that the sun has not changed its declination, is scarcely ever realized; but the change is slight, and may be neglected, except perhaps about the time of the equinoxes, at the end of March and at the end of September. Throughout the remainder of the year the change of declination is so slow that we may safely neglect it. The most favourable times are at the end of June and at the end of December, when the sun's declination is almost stationary. If the line HM be produced both ways to the edges of the table, then the two points on the ground vertically below those on the edges may be found by a plummet, and, if permanent marks be made there, the meridian plane, which is the vertical plane passing through these two points, will have its position perfectly secured.

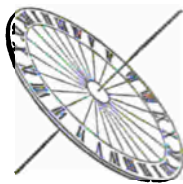

FIG. 5.

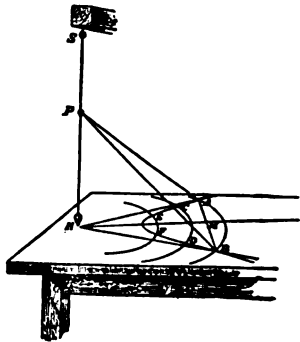

FIG. 6.

To place the Style of a Dial in its True Position.—Before giving any other method of finding the meridian plane, we shall complete the construction of the dial, by showing how the style may now be accurately placed in its true position. The angle which the style makes with a hanging plumb-line, being the co-latitude of the place, is known, and the north and south direction is also roughly given by the mariner's compass. The style may therefore be already adjusted approximately—correctly, indeed, as to its inclination—but probably requiring a little horizontal motion east or west. Suspend a fine plumb-line from some point of the style, then the style will be properly adjusted if, at the very instant of noon, its shadow falls exactly on the plumb-line,—or, which is the same thing, if both shadows coincide on the dial.

This instant of noon will be given very simply, by the meridian plane, whose position we have secured by the two permanent marks on the ground. Stretch a cord from the one mark to the other. This will not generally be horizontal, but the cord will be wholly in the meridian plane, and that is the only necessary condition. Next, suspend a plummet over the mark which is nearer to the sun, and, when the shadow of the plumb-line falls on the stretched cord, it is noon. A signal from the observer there to the observer at the dial enables the latter to adjust the style as directed above.

Other Methods of Finding the Meridian Plane.—We have dwelt at some length on these practical operations because they are simple and tolerably accurate, and because they want neither watch, nor sextant, nor telescope—nothing more, in fact, than the careful observation of shadow lines.

The Pole star, or *Ursæ Minoris*, may also be employed for finding the meridian plane without other apparatus than plumb-lines. This star is now only about $1^{\circ} 14'$ from the pole; if therefore a plumb-line be suspended at a few feet from the observer, and if he shift his position till the star is exactly hidden by the line, then the plane through his eye and the plumb-line will never be far from the meridian plane. Twice in the course of the twenty-four hours the planes would be strictly coincident. This would be when the star crosses the meridian above the pole, and again when it crosses it below. If we wished to employ the method of determining the meridian, the times of the stars crossing would have to be calculated from the data in the *Nautical Almanac*, and a watch would be necessary to know when the instant arrived. The watch need not, however, be very accurate, because the motion of the star is so slow that an error of ten minutes in the time would not give an error of one-eighth of a degree in the azimuth.

The following accidental circumstance enables us to dispense with both calculation and watch. The right ascension of the star γ *Ursæ Majoris*, that star in the tail of the Great Bear which is farthest from the "pointers," happens to differ by a little more than 12 hours from the right ascension of the Pole star. The great circle which joins the two stars passes therefore close to the pole. When the Pole star, at a distance of about $1^{\circ} 14'$ from the pole, is crossing the meridian above the pole, the star γ *Ursæ Majoris*, whose polar distance is about 40° , has not yet reached the meridian below the pole.

When *Ursæ Majoris* reaches the meridian, which will be within half an hour later, the Pole star will have left the meridian; but its slow motion will have carried it only a very little distance away. Now at some instant between these two times—much nearer the latter than the former—the great circle joining the two stars will be exactly vertical; and at this instant, which the observer determines by seeing that the plumb-line hides the two stars simultaneously, neither of the stars is strictly in the meridian; but the deviation from it is so small that it may be neglected, and the plane through the eye and the plumb-line taken for meridian plane.

In all these cases it will be convenient, instead of fixing the plane by means of the eye and one fixed plummet, to have a second plummet at a short distance in front of the eye; this second plummet, being suspended so as to allow of lateral shifting, must be moved so as always to be between the eye and the fixed plummet. The meridian plane will be secured by placing two permanent marks on the ground, one under each plummet.

This method, by means of the two stars, is only available for the upper transit of *Polaris*; for, at the lower transit, the other star γ *Ursæ Majoris* would pass close to or beyond the zenith, and the observation could not be made. Also the stars will not be visible when the upper transit takes place in the daytime, so that one-half of the year is lost to this method.

Neither could it be employed in lower latitudes than 40° N., for there the star would be below the horizon at its lower transit;—we may even say lower than 45° N., for the star must be at least 5° above the horizon before it becomes distinctly visible.

There are other pairs of stars which could be similarly employed, but none so convenient as these two, on account of *Polaris* with its very slow motion being one of the pair.

To place the Style in its True Position without previous Determination of the Meridian Plane.—The various methods given above for finding the meridian plane have for ultimate object the determination of the plane, not on its own account, but as an element for fixing the instant of noon, whereby the style may be properly placed.

We shall dispense, therefore, with all this preliminary work if we determine noon by astronomical observation. For this we shall want a good watch, or pocket chronometer, and a sextant or other instru-

ment for taking altitudes. The local time at any moment may be determined in a variety of ways by observation of the celestial bodies. The simplest and most practically useful methods will be found described and investigated in any work on astronomy.

For our present purpose a single altitude of the sun taken in the forenoon will be most suitable. At some time in the morning, when the sun is high enough to be free from the mists and uncertain refractions of the horizon—but to ensure accuracy, while the rate of increase of the altitude is still tolerably rapid, and, therefore, not later than 10 o'clock—take an altitude of the sun, an assistant, at the same moment, marking the time shown by the watch. The altitude so observed being properly corrected for refraction, parallax, &c., will, together with the latitude of the place, and the sun's declination, taken from the *Nautical Almanac*, enable us to calculate the time. This will be the solar or apparent time, that is, the very time we require. Comparing the time so found with the time shown by the watch, we see at once by how much the watch is fast or slow of solar time; we know, therefore, exactly what time the watch must mark when solar noon arrives, and waiting for that instant we can fix the style in its proper position as explained before.

We can dispense with the sextant and with all calculation and observation if, by means of the pocket chronometer, we bring the time from some observatory where the work is done; and, allowing for the change of longitude, and also for the equation of time, if the time we have brought is clock time, we shall have the exact instant of solar noon as in the previous case.

In former times the fancy of dialists seems to have run riot in devising elaborate surfaces on which the dial was to be traced. Sometimes the shadow was received on a cone, sometimes on a cylinder, or on a sphere, or on a combination of these. A universal dial was constructed of a figure in the shape of a cross; another universal dial showed the hours by a globe and by several gnomons. These universal dials required adjusting before use, and for this a mariner's compass and a spirit-level were necessary. But it would be tedious and useless to enumerate the various forms designed, and, as a rule, the more complex the less accurate.

Another class of useless dials consisted of those with variable centres. They were drawn on fixed horizontal planes, and each day the style had to be shifted to a new position. Instead of hour-lines they had hour-points; and the style, instead of being parallel to the axis of the earth, might make any chosen angle with the horizon. There was no practical advantage in their use, but rather the reverse; and they can only be considered as furnishing material for new mathematical problems.

Portable Dials.—The dials so far described have been fixed dials, for even the fanciful ones to which reference was just now made were to be fixed before using. There were, however, other dials, made generally of a small size, so as to be carried in the pocket; and these, so long as the sun shone, roughly answered the purpose of a watch.

The description of the portable dial has generally been mixed up with that of the fixed dial, as if it had been merely a special case, and the same principle had been the basis of both; whereas there are essential points of difference between them, besides those which are at once apparent.

In the fixed dial the result depends on the *uniform* angular motion of the sun round the fixed style; and a small error in the assumed position of the sun, whether due to the imperfection of the instrument, or to some small neglected correction, has only a trifling effect on the time. This is owing to the angular displacement of the sun being so rapid—a quarter of a degree every minute—that for the ordinary affairs of life greater accuracy is not required, as a displacement of a quarter of a degree, or at any rate of one degree, can be readily seen by nearly every person. But with a portable dial this is no longer the case. The uniform angular motion is not now available, because we have no determined fixed plane to which we may refer it. In the new position, to which the observer has gone, the zenith is the only point of the heavens he can at once practically find; and the basis for the determination of the time is the constantly but *very irregularly* varying zenith distance of the sun.

At sea the observation of the altitude of a celestial body is the only method available for finding local time; but the perfection which has been attained in the construction of the sextant enables the sailor to reckon on an accuracy of seconds. Certain precautions have, however, to be taken. The observations must not be made within a couple of hours of noon, on account of the slow rate of change at that time, nor too near the horizon, on account of the uncertain refractions there; and the same restrictions must be observed in using a portable dial.

To compare roughly the accuracy of the fixed and the portable dials, let us take a mean position in Great Britain, say 54° lat., and a mean declination when the sun is in the equator. It will rise at 6 o'clock, and at noon have an altitude of 36° —that is, the portable dial will indicate an average change of one-tenth of a degree in each minute, or two and a half times slower than the fixed dial. The vertical motion of the sun increases, however, nearer the horizon, but even there it will be only one-eighth of a degree each minute, or half the rate of the fixed dial, which goes on at nearly the same speed throughout the day.

Portable dials are also much more restricted in the range of latitude

for which they are available, and they should not be used more than 4 or 5 m. north or south of the place for which they were constructed.

We shall briefly describe two portable dials which were in actual use.

Dial on a Cylinder.—A hollow cylinder of metal (fig. 7), 4 or 5 in. high, and about an inch in diameter, has a lid which admits of tolerably easy rotation. A hole in the lid receives the style shaped somewhat like a bayonet; and the straight part of the style, which, on account of the two bends, is longer than the lid, projects horizontally out from the cylinder to a distance of 1 or 1½ in. When not in use the style would be taken out and placed inside the cylinder.

A horizontal circle is traced on the cylinder opposite the projecting style, and this circle is divided into 36 approximately equidistant intervals.¹ These intervals represent spaces of time, and to each division is assigned a date, so that each month has three dates marked as follows:—January 10, 20, 31; February 10, 20, 28; March 10, 20, 31; April 10, 20, 30, and so on,—always the 10th, the 20th, and the last day of each month.

Through each point of division a vertical line parallel to the axis of the cylinder is drawn from top to bottom. Now it will be readily understood that if, upon one of these days, the lid be turned, so as to bring the style exactly opposite the date, and if the dial be then placed on a horizontal table so as to receive sunlight, and turned round *bodily* until the shadow of the style falls exactly on the vertical line below it, the shadow will terminate at some definite point of this line, the position of which point will depend on the length of the style—that is, the distance of its end from the surface of the cylinder—and on the altitude of the sun at that instant. Suppose that the observations are continued all day, the cylinder being very gradually turned so that the style may always face the sun, and suppose that marks are made on the vertical line to show the extremity of the shadow at each exact hour from sunrise to sunset—these times being taken from a good fixed sun-dial,—then it is obvious that the next year, on the *same date*, the sun's declination being about the same, and the observer in about the same latitude, the marks made the previous year will serve to tell the time all that day.

What we have said above was merely to make the principle of the instrument clear, for it is evident that this mode of marking, which would require a whole year's sunshine and hourly observation, cannot be the method employed.

The positions of the marks are, in fact, obtained by calculation. Corresponding to a given date, the declination of the sun is taken from the almanac, and this, together with the latitude of the place and the length of the style, will constitute the necessary data for computing the length of the shadow, that is, the distance of the mark below the style for each successive hour.

We have assumed above that the declination of the sun is the same at the same date in different years. This is not quite correct, but, if the dates be taken for the second year after leap year, the results will be sufficiently approximate.

When all the hour-marks have been placed opposite to their respective dates, then a continuous curve, joining the corresponding hour-marks, will serve to find the time for a day intermediate to those set down, the lid being turned till the style occupy a proper position between the two divisions. The horizontality of the surface on which the instrument rests is a very necessary condition, especially in summer, when, the shadow of the style being long, the extreme end will shift rapidly for a small deviation from the vertical, and render the reading uncertain. The dial can also be used by holding it up by a small ring in the top of the lid, and probably the verticality is better ensured in that way.

Portable Dial on a Card.—This neat and very ingenious dial is attributed by Ozanam to a Jesuit Father, De Saint Rigaud, and probably dates from the early part of the 17th century. Ozanam says that it was sometimes called the *capuchin*, from some fancied resemblance to a cowl thrown back.

Construction.—Draw a straight line ACB parallel to the top of the

¹ Strict equality is not necessary, as the observations made are on the vertical line through each division-point, without reference to the others. It is not even requisite that the divisions should go completely and exactly round the cylinder, although they were always so drawn, and both these conditions were insisted upon in the directions for the construction.

card (fig. 8) and another DCE at right angles to it; with C as centre, and any convenient radius CA, describe the semicircle AEB below the horizontal. Divide the whole arc AEB into 12 equal parts at the points *r, s, t*, &c., and through these points draw perpendiculars to the diameter ACB; these lines will be the hour-lines, viz. the line through *r* will be the XI line, the line through *s* the X line, and so on; the hour-line of noon will be the point A itself; by subdivision of the small arcs *Ar, rs, st*, &c., we may draw the hour-lines corresponding to halves and quarters, but this only where it can be done without confusion.

Draw ASD making with AC an angle equal to the latitude of the place, and let it meet EC in D, through which point draw FDG at right angles to AD.

With centre A, and any convenient radius AS, describe an arc of circle RST, and graduate this arc by marking degree divisions on

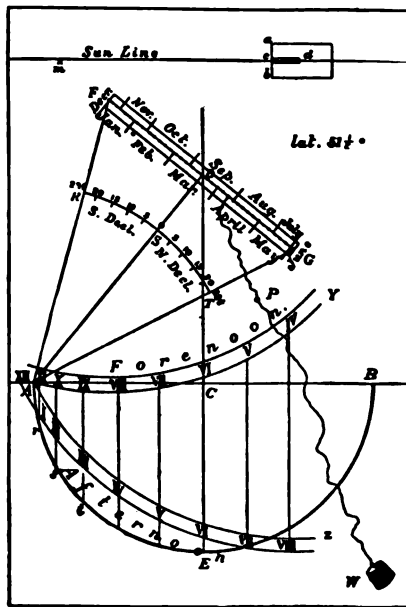

FIG. 8.

it, extending from 0° at S to 23½° on each side at R and T. Next determine the points on the straight line FDG where radii drawn from A to the degree divisions on the arc would cross it, and carefully mark these crossings.

The divisions of RST are to correspond to the sun's declination, south declinations on RS and north declinations on ST. In the other hemisphere of the earth this would be reversed; the north declinations would be on the upper half.

Now, taking a second year after leap year (because the declinations of that year are about the mean of each set of four years), find the days of the month when the sun has these different declinations, and place these dates, or so many of them as can be shown without confusion, opposite the corresponding marks on FDG. Draw the *sun-line* at the top of the card parallel to the line ACB; and, near the extremity, to the right, draw any small figure intended to form, as it were, a door of which *ab* shall be the hinge. Care must be taken that this hinge is exactly at right angles to the *sun-line*. Make a fine open slit *cd* right through the card and extending from the hinge to a short distance on the door,—the centre line of this slit coinciding accurately with the *sun-line*. Now, cut the door completely through the card; except, of course, along the hinge, which, when the card is thick, should be partly cut through at the back, to facilitate the opening. Cut the card right through along the line FDG, and pass a thread carrying a little plummet W and a very small bead F. The bead having sufficient friction with the thread to retain any position when acted on only by its own weight, but sliding easily along the thread when moved by the hand. At the back of the card the thread terminates in a knot to hinder it from being drawn through; or better, because giving more friction and a better hold, it passes through the centre of a small disc of card—a fraction of an inch in diameter—and, by a knot, is made fast at the back of the disc.

To complete the construction,—with the centres F and G,

radii FA and GA, draw the two arcs AY and AZ which will limit the hour-lines; for in an observation the bead will always be found between them. The forenoon and afternoon hours may then be marked as indicated in the figure. The dial does not of itself discriminate between forenoon and afternoon; but extraneous circumstances, as, for instance, whether the sun is rising or falling, will settle that point, except when close to noon, where it will always be uncertain.

To rectify the dial (using the old expression, which means to prepare the dial for an observation),—open the small door, by turning it about its hinge, till it stands well out in front. Next, set the thread in the line FC opposite the day of the month, and stretching it over the point A, slide the bead P along till it exactly coincide with A.

To find the hour of the day,—hold the dial in a vertical position in such a way that its plane may pass through the sun. The verticality is ensured by seeing that the bead rests against the card without pressing. Now gradually tilt the dial (without altering its vertical

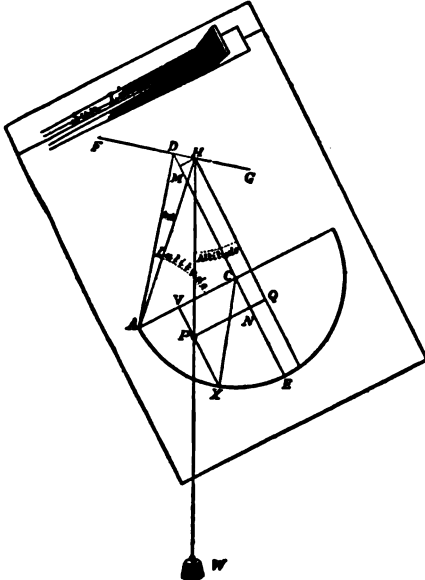

Fig. 9.

plane), until the central line of sunshine, passing through the open slit of the door, just falls along the sun-line. The hour-line against which the bead P then rests indicates the time.

The sun-line drawn above has always, so far as we know, been used as a shadow-line. The upper edge of the rectangular door was the prolongation of the line, and, the door being opened, the dial was gradually tilted until the shadow cast by the upper edge exactly coincided with it. But this shadow tilts the card one-quarter of a degree more than the sun-line, because it is given by that portion of the sun which just appears above the edge, that is, by the upper limb of the sun, which is one-quarter of a degree higher than the centre. Now, even at some distance from noon, the sun will sometimes take a considerable time to rise one-quarter of a degree, and by so much time will the indication of the dial be in error.

The central line of light which comes through the open slit will be free from this error, because it is given by light from the centre of the sun.

The card-dial deserves to be looked upon as something more than a mere toy. Its ingenuity and scientific accuracy give it an educational value which is not to be measured by the roughness of the results obtained.

The theory of this instrument is as follows:—Let H (fig. 9) be the point of suspension of the plummet at the time of observation, so that the angle DAH is the north declination of the sun,—P, the bead, resting against the hour-line VX. Join CX, then the angle ACX is the hour-angle from noon given by the bead, and we have to prove that this hour-angle is the correct one corresponding to a north latitude DAC, a north declination DAH and an altitude equal to the angle which the sun-line, or its parallel AC, makes with the horizontal. The angle AHQ will be equal to the altitude, if HQ be drawn parallel to DC, for the pair of lines HQ, HP will be respectively at right angles to the sun-line and the horizontal.

Draw PQ and HM parallel to AC, and let them meet DCE in M and N respectively.

Let HP and its equal HA be represented by *a*. Then the following values will be readily deduced from the figure:—

$$AD = a \cos \text{ decl.} \quad DH = a \sin \text{ decl.} \quad PQ = a \sin \text{ alt.}$$

$$CX = AC = AD \cos \text{ lat.} = a \cos \text{ decl.} \cos \text{ lat.}$$

$$PN = CV = CX \cos \text{ ACX} = a \cos \text{ decl.} \cos \text{ lat.} \cos \text{ ACX.}$$

$$NQ = MH = DH \sin MDH = a \sin \text{ decl.} \sin \text{ lat.}$$

$$(\therefore \text{ the angle MDH} = \text{DAC} = \text{latitude.})$$

And since $PQ = NQ + PN$, we have, by simple substitution, $a \sin \text{ alt.} = a \sin \text{ decl.} \sin \text{ lat.} + a \cos \text{ decl.} \cos \text{ lat.} \cos \text{ ACX}$; or, dividing by *a* throughout,

$$\sin \text{ alt.} = \sin \text{ decl.} \sin \text{ lat.} + \cos \text{ decl.} \cos \text{ lat.} \cos \text{ ACX} \dots (1)$$

which equation determines the hour-angle ACX shown by the bead. To determine the hour-angle of the sun at the same moment, let fig. 10 represent the celestial sphere, HR the horizon, P the pole, Z the zenith and S the sun.

$$\text{From the spherical triangle PZS, we have}$$

$$\cos ZS = \cos PS \cos ZP + \sin PS \sin ZP \cos ZPS$$

$$\text{but } ZS = \text{zenith distance} = 90^\circ - \text{altitude}$$

$$ZP = 90^\circ - \text{PR} = 90^\circ - \text{latitude}$$

$$PS = \text{polar distance} = 90^\circ - \text{declination,}$$

therefore, by substitution $\sin \text{ alt.} = \sin \text{ decl.} \sin \text{ lat.} + \cos \text{ decl.} \cos \text{ lat.} \cos ZPS \dots (2)$ and ZPS is the hour-angle of the sun.

A comparison of the two formulæ (1) and (2) shows that the hour-angle given by the bead will be the same as that given by the sun, and proves the theoretical accuracy of the card-dial. Just at sun-rise or at sun-set the amount of refraction slightly exceeds half a degree. If, then, a little cross *m* (see fig. 8) be made just below the sun-line, at a distance from it which would subtend half a degree at *r*, the time of sun-set would be found corrected for refraction, if the central line of light were made to fall on *cm*.

LITERATURE.—The following list includes the principal writers on dialling whose works have come down to us, and to these we must refer for descriptions of

the various constructions, some simple and direct, others fanciful and intricate, which have been at different times employed: Ptolemy, *Analemma*, restored by Commandine; Vitruvius, *Architecture*; Sebastian Münster, *Horologigraphia*; Orontius Fineus, *De horologiis solaribus*; Mutio Oddi da Urbino, *Horologi solari*; Dryander, *De horologiorum compositione*; Conrad Gesner, *Pandectas*; Andreas Schöner, *Gnomonica*; F. Commandine, *Horologiorum descriptio*;

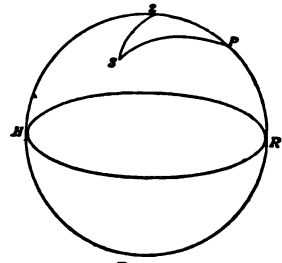

Fig. 10.

Joan. Bapt. Benedictus, *De gnomonum usu*; Georgius Schomberg, *Exegesis fundamentorum gnomonicorum*; Joan. Solomon de Caus, *Horologes solaires*; Joan. Bapt. Trolta, *Praxis horologiorum*; Desargues, *Manière universelle pour poser l'essieu*, &c.; Ath. Kircher, *Ars magna lucis et Umbræ*; Hallum, *Explicatio horologii in hortu regio Lonæini*; Joan. Mark, *Tractatus horologiorum*; Clavius, *Gnomonices de horologiis*. Also among more modern writers, Deschales, Ozanam, Schottus, Wolfius, Picard, Lahire, Walper; in German, Paterson, Michael, Müller; in English, Foster, Wells, Collins, Leadbetter, Jones, Leybourn, Emerson and Ferguson. See also Hans Löschner, *Über Sonnenuhren* (2nd ed., Graz, 1906). (H. G.)

DIALECT (from Gr. διάλεκτος, conversation, manner of speaking, διάλεγομαι, to converse), a particular or characteristic manner of speech, and hence any variety of a language. In its widest sense languages which are branches of a common or parent language may be said to be "dialects" of that language; thus Attic, Ionic, Aeolic and Doric are dialects of Greek, though there may never have at any time been a separate language of which they were variations; so the various Romance languages, Italian, French, Spanish, &c., were dialects of Latin. Again, where there have existed side by side, as in England, various branches of a language, such as the languages of the Angles, the Jutes or the Saxons, and the descendant of one particular language, from many causes, has obtained the predominance, the traces of the other languages remain in the "dialects" of the districts where once the original language prevailed. Thus it may be incorrect, from the historical point of view, to say that "dialect" varieties of a language represent degradations of the standard language. A "literary" accepted language, such as modern English, represents the original language spoken in the Midlands, with accretions

of Norman, French, and later literary and scientific additions from classical and other sources, while the present-day "dialects" preserve, in inflections, pronunciation and particular words, traces of the original variety of the language not incorporated in the standard language of the country. See the various articles on languages (English, French, &c.).

DIALECTIC, or **DIALECTICS** (from Gr. *δῆλωσις*, discourse, debate; δ *δῆλωσις*, sc. *τέχνη*, the art of debate), a logical term, generally used in common parlance in a contemptuous sense for verbal or purely abstract disputation devoid of practical value. According to Aristotle, Zeno of Elea "invented" dialectic, the art of disputation by question and answer, while Plato developed it metaphysically in connexion with his doctrine of "Ideas" as the art of analysing ideas in themselves and in relation to the ultimate idea of the Good (*Repub.* vii.). The special function of the so-called "Socratic dialectic" was to show the inadequacy of popular beliefs. Aristotle himself used "dialectic," as opposed to "science," for that department of mental activity which examines the presuppositions lying at the back of all the particular sciences. Each particular science has its own subject matter and special principles (*ἰδίαι ἀρχαί*) on which the superstructure of its special discoveries is based. The Aristotelian dialectic, however, deals with the universal laws (*κοινὰ ἀρχαί*) of reasoning, which can be applied to the particular arguments of all the sciences. The sciences, for example, all seek to define their own species; dialectic, on the other hand, sets forth the conditions which all definitions must satisfy whatever their subject matter. Again, the sciences all seek to deduce general laws; dialectic investigates the nature of such laws, and the kind and degree of necessity to which they can attain. To this general subject matter Aristotle gives the name "Topics" (*τόποι, loci, communis loci*). "Dialectic" in this sense is the equivalent of "logic." Aristotle also uses the term for the science of probable reasoning as opposed to demonstrative reasoning (*ἀποδεικτικὴ*). The Stoics divided *λογική* (logic) into rhetoric and dialectic, and from their time till the end of the middle ages dialectic was either synonymous with, or a part of, logic.

In modern philosophy the word has received certain special meanings. In Kantian terminology *Dialektik* is the name of that portion of the *Kritik d. reinen Vernunft* in which Kant discusses the impossibility of applying to "things-in-themselves" the principles which are found to govern phenomena. In the system of Hegel the word resumes its original Socratic sense, as the name of that intellectual process whereby the inadequacy of popular conceptions is exposed. Throughout its history, therefore, "dialectic" has been connected with that which is remote from, or alien to, unsystematic thought, with the a priori, or transcendental, rather than with the facts of common experience and material things.

DIALLAGES, an important mineral of the pyroxene group, distinguished by its thin foliated structure and bronzy lustre. The chemical composition is the same as diopside, Ca Mg (SiO₃)₂, but it sometimes contains the molecules (Mg, Fe²⁺) (Al, Fe³⁺); SiO₂ and Na Fe²⁺ (SiO₂)₂ in addition, when it approaches to augite in composition. Diallage is in fact an altered form of these varieties of pyroxene; the particular kind of alteration which they have undergone being known as "schillerization." This, as described by Prof. J. W. Judd, consists in the development of a fine lamellar structure or parting due to secondary twinning and the separation of secondary products along these and other planes of chemical weakness ("solution planes") in the crystal. The secondary products consist of mixtures of various hydrated oxides—opal, gōthite, limonite, &c.—and appear as microscopic inclusions filling or partly filling cavities, which have definite outlines with respect to the enclosing crystal and are known as negative crystals. It is to the reflection and interference of light from these minute inclusions that the peculiar bronzy sheen or "schiller" of the mineral is due. The most pronounced lamination is that parallel to the orthopinacoid; another, less distinct, is parallel to the basal plane, and a third parallel to the plane of symmetry; these planes of secondary parting are in addition to the ordinary prismatic cleavage of all

pyroxenes. Frequently the material is interlaminated with a rhombic pyroxene (bronzeite) or with an amphibole (smaragdite or urallite), the latter being an alteration product of the diallage.

Diallage is usually greyish-green or dark green, sometimes brown, in colour, and has a pearly to metallic lustre or schiller on the laminated surfaces. The hardness is 4, and the specific gravity 3.2 to 3.35. It does not occur in distinct crystals with definite outlines, but only as lamellar masses in deep-seated igneous rocks, principally gabbro, of which it is an essential constituent. It occurs also in some peridotites and serpentines, and rarely in volcanic rocks (basalt) and crystalline schists. Masses of considerable size are found in the coarse-grained gabbros of the Island of Skye, Le Prese near Borno in Valtellina, Lombardy, Prato near Florence, and many other localities.

The name diallage, from *διאלλαγή*, "difference," in allusion to the dissimilar cleavages and planes of fracture, as originally applied by R. J. Haüy in 1801, included other minerals (the orthorhombic pyroxenes hypersthene, bronzeite and bastite, and the smaragdite variety of hornblende) which exhibit the same peculiarities of schiller structure; it is now limited to the monoclinic pyroxenes with this structure. Like the minerals of similar appearance just mentioned, it is sometimes cut and polished for ornamental purposes. (L. J. S.)

DIALOGUE, properly the conversation between two or more persons, reported in writing, a form of literature invented by the Greeks for purposes of rhetorical entertainment and instruction, and scarcely modified since the days of its invention. A dialogue is in reality a little drama without a theatre, and with scarcely any change of scene. It should be illuminated with those qualities which La Fontaine applauded in the dialogue of Plato, namely vivacity, fidelity of tone, and accuracy in the opposition of opinions. It has always been a favourite with those writers who have something to censure or to impart, but who love to stand outside the pulpit, and to encourage others to pursue a train of thought which the author does not seem to do more than indicate. The dialogue is so spontaneous a mode of expressing and noting down the undulations of human thought that it almost escapes analysis. All that is recorded, in any literature, of what pretend to be the actual words spoken by living or imaginary people is of the nature of dialogue. One branch of letters, the drama, is entirely founded upon it. But in its technical sense the word is used to describe what the Greek philosophers invented, and what the noblest of them lifted to the extreme refinement of an art.

The systematic use of dialogue as an independent literary form is commonly supposed to have been introduced by Plato, whose earliest experiment in it is believed to survive in the *Laches*. The Platonic dialogue, however, was founded on the mime, which had been cultivated half a century earlier by the Sicilian poets, Sophron and Epicharmus. The works of these writers, which Plato admired and imitated, are lost, but it is believed that they were little plays, usually with only two performers. The recently discovered mimes of Herodas (Herondas) give us some idea of their scope. Plato further simplified the form, and reduced it to pure argumentative conversation, while leaving intact the amusing element of character-drawing. He must have begun this about the year 405, and by 399 he had brought the dialogue to its highest perfection, especially in the cycle directly inspired by the death of Socrates. All his philosophical writings, except the *Apology*, are cast in this form. As the greatest of all masters of Greek prose style, Plato lifted his favourite instrument, the dialogue, to its highest splendour, and to this day he remains by far its most distinguished proficient. In the 2nd century A.D. Lucian of Samosata achieved a brilliant success with his ironic dialogues "Of the Gods," "Of the Dead," "Of Love" and "Of the Courtesans." In some of them he attacks superstition and philosophical error with the sharpness of his wit; in others he merely paints scenes of modern life. The title of Lucian's most famous collection was borrowed in the 17th century by two French writers of eminence, each of whom prepared *Dialogues des morts*. These were Fontenelle (1683) and Fénelon (1712). In English non-dramatic literature the dialogue had not been extensively

employed until Berkeley used it, in 1713, for his Platonic treatise, *Hylas and Philonous*. Landor's *Imaginary Conversations* (1821-1838) is the most famous example of it in the 19th century, although the dialogues of Sir Arthur Helps claim attention. In Germany, Wieland adopted this form for several important satirical works published between 1780 and 1799. In Spanish literature, the Dialogues of Valdés (1528) and those on Painting (1613) by Vincenzo Carucci, are celebrated. In Italian, collections of dialogues, on the model of Plato, have been composed by Torquato Tasso (1586), by Galileo (1632), by Galiani (1770), by Leopardi (1825), and by a host of lesser writers. In our own day, the French have returned to the original application of dialogue, and the inventions of "Gyp," of Henri Lavedan and of others, in which a mundane anecdote is wittily and maliciously told in conversation, would probably present a close analogy to the lost mimes of the early Sicilian poets, if we could meet with them. This kind of dialogue has been employed in English, and with conspicuous cleverness by Mr Anstey Guthrie, but it does not seem so easily appreciated by English as by French readers. (E.G.)

DIALYSIS (from the Gr. *dialé*, through *λυω*, to loosen), in chemistry, a process invented by Thomas Graham for separating colloidal and crystalline substances. He found that solutions could be divided into two classes according to their action upon a porous diaphragm such as parchment. If a solution, say of salt, be placed in a drum provided with a parchment bottom, termed a "dialyser," and the drum and its contents placed in a larger vessel of water, the salt will pass through the membrane. If the salt solution be replaced by one of glue, gelatin or gum, it will be found that the membrane is impermeable to these solutes. To the first class Graham gave the name "crystalloids," and to the second "colloids." This method is particularly effective in the preparation of silicic acid. By adding hydrochloric acid to a dilute solution of an alkaline silicate, no precipitate will fall and the solution will contain hydrochloric acid, an alkaline chloride, and silicic acid. If the solution be transferred to a dialyser, the hydrochloric acid and alkaline chloride will pass through the parchment, while the silicic acid will be retained.

DIAMAGNETISM. Substances which, like iron, are attracted by the pole of an ordinary magnet are commonly spoken of as magnetic, all others being regarded as non-magnetic. It was noticed by A. C. Becquerel in 1827 that a number of so-called non-magnetic bodies, such as wood and gum lac, were influenced by a very powerful magnet, and he appears to have formed the opinion that the influence was of the same nature as that exerted upon iron, though much feebler, and that all matter was more or less magnetic. Faraday showed in 1845 (*Experimental Researches*, vol. iii.) that while practically all natural substances are indeed acted upon by a sufficiently strong magnetic pole, it is only a comparatively small number that are attracted like iron, the great majority being repelled. Bodies of the latter class were termed by Faraday *diamagnetics*. The strongest diamagnetic substance known is bismuth, its susceptibility being—0.000014, and its permeability 0.9998. The diamagnetic quality of this metal can be detected by means of a good permanent magnet, and its repulsion by a magnetic pole had been more than once ascertained before the date of Faraday's experiments. The metals gold, silver, copper, lead, zinc, antimony and mercury are all diamagnetic; tin, aluminium and platinum are attracted by a very strong pole. (See **MAGNETISM**.)

DIAMANTE, FRA, Italian fresco painter, was born at Prato about 1400. He was a Carmelite friar, a member of the Florentine community of that order, and was the friend and assistant of Filippo Lippi. The Carmelite convent of Prato which he adorned with many works in fresco has been suppressed, and the buildings have been altered to a degree involving the destruction of the paintings. He was the principal assistant of Fra Filippo in the grand frescoes which may still be seen at the east end of the cathedral of Prato. In the midst of the work he was recalled to Florence by his conventual superior, and a minute of proceedings of the commune of Prato is still extant, in which it is determined to petition the metropolitan of Florence to obtain his return to

Prato,—a proof that his share in the work was so important that his recall involved the suspension of it. Subsequently he assisted Fra Filippo in the execution of the frescoes still to be seen in the cathedral of Spoleto, which Fra Diamante completed in 1470 after his master's death in 1469. Fra Filippo left a son ten years old to the care of Diamante, who, having received 200 ducats from the commune of Spoleto, as the balance due for the work done in the cathedral, returned with the child to Florence, and, as Vasari says, bought land for himself with the money, giving but a small portion to the child. The accusation of wrong-doing, however, would depend upon the share of the work executed by Fra Diamante, and the terms of his agreement with Fra Filippo. Fra Diamante must have been nearly seventy when he completed the frescoes at Spoleto, but the exact year of his death is not known.

DIAMANTE, JUAN BAUTISTA (1640?–1684?), Spanish dramatist, was born at Castillo about 1640, entered the army, and began writing for the stage in 1657. He became a knight of Santiago in 1660; the date of his death is unknown, but no reference to him as a living author occurs after 1684. Like many other Spanish dramatists of his time, Diamante is deficient in originality, and his style is riddled with affectations; *La Desgraciada Raquel*, which was long considered to be his best play, is really Mira de Amescua's *Judith de Toledo* under another title; and the earliest of Diamante's surviving pieces, *El Honrador de su padre* (1658), is little more than a free translation of Corneille's *Cid*. Diamante is historically interesting as the introducer of French dramatic methods into Spain.

DIAMANTINA (formerly called *Tejuco*), a mining town of the state of Minas Geraes, Brazil, in the N.E. part of the state, 3710 ft. above sea level. Pop. (1890) 17,980. Diamantina is built partly on a steep hillside overlooking a small tributary of the Rio Jequitinhonha (where diamond-washing was once carried on), and partly on the level plain above. The town is roughly but substantially built, with broad streets and large squares. It is the seat of a bishopric, with an episcopal seminary, and has many churches. Its public buildings are inconspicuous; they include a theatre, military barracks, hospitals, a lunatic asylum and a secondary school. There are several small manufactures, including cotton-weaving, and diamond-cutting is carried on. The surrounding region, lying on the eastern slopes of one of the lateral ranges of the Serra do Espinhaço, is rough and barren, but rich in minerals, principally gold and diamonds. Diamantina is the commercial centre of an extensive region, and has long been noted for its wealth. The date of the discovery of diamonds, upon which its wealth and importance chiefly depend, is uncertain, but the official announcement was made in 1729, and in the following year the mines were declared crown property, with a crown reservation, known as the "forbidden district," 42 leagues in circumference and 8 to 16 leagues in diameter. Gold-mining was forbidden within its limits and diamond-washing was placed under severe restrictions. There are no trustworthy returns of the value of the output, but in 1849 the total was estimated up to that date at 300,000,000 francs (see **DIAMOND**). The present name of the town was assumed (instead of Tejuco) in 1838, when it was made a *cidade*.

DIAMANTINO, a small town of the state of Matto Grosso, Brazil, near the Diamantino river, about 6 m. above its junction with the Paraguay, in 14° 24' 33" S., 56° 8' 30" W. Pop. (1890) of the municipality 2147, mostly Indians. It stands in a broken sterile region 1837 ft. above sea-level and at the foot of the great Matto Grosso plateau. The first mining settlement dates from 1730, when gold was found in the vicinity. On the discovery of diamonds in 1746 the settlement drew a large population and for a time was very prosperous. The mines failed to meet expectations, however, and the population has steadily declined. Ipecacuanha and vanilla beans are now the principal articles of export.

DIAMETER (from the Gr. *dia*, through *μετρον*, measure), in geometry, a line passing through the centre of a circle or conic section and terminated by the curve; the "principal diameters" of the ellipse and hyperbola coincide with the "axes" and are at

right angles; "conjugate diameters" are such that each bisects chords parallel to the other. The diameter of a quadric surface is a line at the extremities of which the tangent planes are parallel. Newton defined the diameter of a curve of any order as the locus of the centres of the mean distances of the points of intersection of a system of parallel chords with the curve; this locus may be shown to be a straight line. The word is also used as a unit of linear measurement of the magnifying power of a lens or microscope.

In architecture, the term is used to express the measure of the lower part of the shaft of a column. It is employed by Vitruvius (iii. 2) to determine the height of a column, which should vary from eight to ten diameters according to the intercolumniation; and it is generally the custom to fix the lower diameter of the shaft by the height required and the Order employed. Thus the diameter of the Roman Doric should be about one-eighth of the height, that of the Ionic one-ninth, and of the Corinthian one-tenth (see ORDER).

DIAMOND, a mineral universally recognized as chief among precious stones; it is the hardest, the most imperishable, and also the most brilliant of minerals.¹ These qualities alone have made it supreme as a jewel since early times, and yet the real brilliancy of the stone is not displayed until it has been faceted by the art of the lapidary (*q.v.*); and this was scarcely developed before the year 1746. The consummate hardness of the diamond, in spite of its high price, has made it most useful for purposes of grinding, polishing and drilling. Numerous attempts have been made to manufacture the diamond by artificial means, and these attempts have a high scientific interest on account of the mystery which surrounds the natural origin of this remarkable mineral. Its physical and chemical properties have been the subject of much study, and have a special interest in view of the extraordinary difference between the physical characters of the diamond and those of graphite (blacklead) or charcoal, with which it is chemically identical, and into which it can be converted by the action of heat or electricity. Again, on account of the great value of the diamond, much of the romance of precious stones has centred round this mineral; and the history of some of the great diamonds of historic times has been traced through many extraordinary vicissitudes.

The name *Adámas*, "the invincible," was probably applied by the Greeks to hard metals, and thence to corundum (emery) and other hard stones. According to Charles William King, the first undoubted application of the name to the diamond is found in Manilius (A.D. 16),—*Sic Adamas, punctum lapidis, pretiosior auro*,—and Pliny (A.D. 100) speaks of the rarity of the stone, "the most valuable of gems, known only to kings." Pliny described six varieties, among which the Indian, having six pointed angles, and also resembling two pyramids (*turbines*, whip-tops) placed base to base, may probably be identified as the ordinary octahedral crystal (fig. 1). The "diamond" (*Yakalom*) in the breastplate of the high priest (Ex. xxxix. 11) was certainly some other stone, for it bore the name of a tribe, and methods of engraving the true diamond cannot have been known so early. The stone can hardly have become familiar to the Romans until introduced from India, where it was probably mined at a very early period. But one or other of the remaining varieties mentioned by Pliny (the Macedonian, the Arabian, the Cyprian, &c.) may be the true diamond, which was in great request for the tool of the gem-engraver. Later Roman authors mentioned various rivers in India as yielding the *Adamas* among their sands. The name *Adamas* became corrupted into the forms *adamant*, *diamant*, *diamond*; but the same word, owing to a medieval misinterpretation which derived it from *adamare* (compare the French word *aimer*), was also applied to the lodestone.

Like all the precious stones, the diamond was credited with many marvellous virtues; among others the power of averting insanity, and of rendering poison harmless; and in the middle

¹ Diamonds are invariably weighed in carats and in $\frac{1}{4}$, $\frac{1}{2}$, $\frac{3}{4}$, $\frac{1}{8}$, $\frac{1}{16}$, $\frac{1}{32}$ of a carat. One (English) carat = 3.17 grains = .2054 gram. One ounce = 15.1 carats. (See CARAT.)

ages it was known as the "pietra della reconciliazione," as the peacemaker between husband and wife.

Scientific Characters.—The majority of minerals are found most commonly in masses which can with difficulty be recognized as aggregates of crystalline grains, and occur comparatively seldom as distinct crystals; but the diamond is almost always found in single crystals, which show no signs of previous attachment to any matrix; the stones were, until the discovery of the South African mines, almost entirely derived from sands or gravels, but owing to the hardness of the mineral it is rarely, if ever, water-worn, and the crystals are often very perfect. The crystals belong to the cubic system, generally assuming the form of the octahedron (fig. 1), but they may, in accordance with the principles of crystallography, also occur in other forms symmetrically derived from the octahedron,—for example, the cube, the 12-faced figure known as the rhombic dodecahedron (fig. 2), or the 48-faced figure known as the hexakis-octahedron (fig. 3), or in combinations of these. The octahedron faces are usually smooth; most of the other faces are rounded (fig. 4). The cube

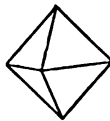

FIG. 1

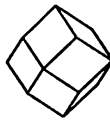

FIG. 2.



FIG. 3.



FIG. 4.

faces are rough with protruding points. The cube is sometimes found in Brazil, but is very rare among the S. African stones; and the dodecahedron is perhaps more common in Brazil than elsewhere.

There is often a furrow running along the edges of the octahedron, or across the edges of the cube, and this indicates that the apparently simple crystal may really consist of eight individuals meeting at the centre; or, what comes to the same thing, of two individuals interpenetrating and projecting through each other. If this be so the form of the diamond is really the tetrahedron (and the various figures derived symmetrically from it) and not the octahedron. Fig. 5 shows how the octahedron with furrowed edge may be constructed from two interpenetrating tetrahedra (shown in dotted lines). If the grooves be left out of account, the large faces which have replaced each tetrahedron corner then make up a figure which has the aspect of a simple octahedron. Such regular interpenetrations are known in crystallography as "twins."

There are also twins of diamond in which two octahedra (fig. 6) are united by contact along a surface parallel to an octahedron face without interpenetration. On account of their resemblance to the twins of the mineral spinel (which crystallizes in octahedra) these are known as "spinel twins." They are generally flattened along the plane of union. The crystals often display triangular markings, either elevations or pits, upon the octahedron faces; the latter are particularly well defined and have the form of equilateral triangles (fig. 7). They are similar to the "etched figures" produced by moistening an octahedron of alum, and have probably been produced, like them, by the action of some solvent. Similar, but somewhat different markings are produced by the combustion of diamond in oxygen, unaccompanied by any rounding of the edges.

Diamond possesses a brilliant "adamantine" lustre, but this tends to be greasy on the surface of the natural stones and gives

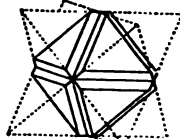

FIG. 5.

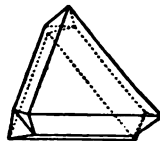

FIG. 6.

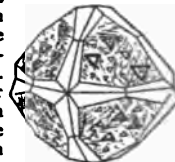

FIG. 7.

the rounded crystals somewhat the appearance of drops of gum. Absolutely colourless stones are not so common as cloudy and faintly coloured specimens; the usual tints are grey, brown, yellow or white; and as rarities, red, green, blue and black stones have been found. The colour can sometimes be removed or changed at a high temperature, but generally returns on cooling. It is therefore more probably due to metallic oxides than to hydrocarbons. Sir William Crookes has, however, changed a pale yellow diamond to a bluish-green colour by keeping it embedded in radium bromide for eleven weeks. The black coloration upon the surface produced by this process, as also by the electric bombardment in a vacuum tube, appears to be due to a conversion of the surface film into graphite. Diamond may break with a conchoidal fracture, but the crystals always cleave readily along planes parallel to the octahedron faces: of this property the diamond cutters avail themselves when reducing the stone to the most convenient form for cutting; a sawing process, has, however, now been introduced, which is preferable to that of cleavage. It is the hardest known substance (though tantalum, or an alloy of tantalum now competes with it) and is chosen as 10 in the mineralogist's scale of hardness; but the difference in hardness between diamond (10) and corundum (9) is really greater than that between corundum (9) and talc (1); there is a difference in the hardness of the different faces; the Borneo stones are also said to be harder than those of Australia, and the Australian harder than the African, but this is by no means certain. The specific gravity ranges from 3.56 to 3.50, generally about 3.52. The coefficient of expansion increases very rapidly above 750°, and diminishes very rapidly at low temperatures; the maximum density is attained about -42° C.

The very high refractive power (index = 2.417 for sodium light) gives the stone its extraordinary brilliancy; for light incident within a diamond at a greater angle than 24½° is reflected back into the stone instead of passing through it; the corresponding angle for glass is 40°. The very high dispersion (index for red light = 2.402, for blue light = 2.460) gives it the wonderful "fire" or display of spectral colours. Certain absorption bands at the blue end of the spectrum are supposed to be due to rare elements such as samarium. Unlike other cubic crystals, diamond experiences a diminution of refractive index with increase of temperature. It is very transparent for Röntgen rays, whereas paste imitations are opaque. It is a good conductor of heat, and therefore feels colder to the touch than glass and imitation stones. The diamond has also a somewhat greasy feel. The specific heat increases rapidly with rising temperature up to 60° C., and then more slowly. Crystals belonging to the cubic system should not be birefringent unless strained; diamond often displays double refraction particularly in the neighbourhood of inclusions, both liquid and solid; this is probably due to strain, and the spontaneous explosion of diamonds has often been observed. Diamond differs from graphite in being a bad conductor of electricity: it becomes positively electrified by friction. The electrical resistance is about that of ordinary glass, and is diminished by one-half during exposure by Röntgen rays; the dielectric constant (16) is greater than that which should correspond to the specific gravity.

The phosphorescence produced by friction has been known since the time of Robert Boyle (1663); the diamond becomes luminous in a dark room after exposure to sunlight or in the presence of radium; and many stones phosphoresce beautifully (generally with a pale green light) when subjected to the electric discharge in a vacuum tube. Some diamonds are more phosphorescent than others, and different faces of a crystal may display different tints. The combustibility of the diamond was predicted by Sir Isaac Newton on account of its high refractive power; it was first established experimentally by the Florentine Academicians in 1694. In oxygen or air diamond burns at about 850°, and only continues to do so if maintained at a high temperature; but in the absence of oxidising agents it may be raised to a much higher temperature. It is, however, infusible at the temperature of the electric arc, but becomes converted superficially into graphite. Experiments on the combustion of

diamond were made by Smithson Tennant (1797) and Sir Humphry Davy (1816), with the object of proving that it is pure carbon; they showed that burnt in oxygen it yields exactly the same amount of carbon dioxide as that produced by burning the same weight of carbon. Still more convincing experiments were made by A. Krause in 1890. Similarly Guyton de Morveau showed that, like charcoal, diamond converts soft iron into steel. Diamond is insoluble in acid and alkalis, but is oxidised on heating with potassium bichromate and sulphuric acid.

Bort (or Boort) is the name given to impure crystals or fragments useless for jewels; it is also applied to the rounded crystalline aggregates, which generally have a grey colour, a rough surface, often a radial structure, and are devoid of good cleavage. They are sometimes spherical ("shot bort"). Carbonado or "black diamond," found in Bahia (also recently in Minas Geraes), is a black material with a minutely crystalline structure somewhat porous, opaque, resembling charcoal in appearance, devoid of cleavage, rather harder than diamond, but of less specific gravity; it sometimes displays a rude cubic crystalline form. The largest specimen found (1895) weighed 3078 carats. Both bort and carbonado seem to be really aggregates of crystallized diamond, but the carbonado is so nearly structureless that it was till recently regarded as an amorphous modification of carbon.

Uses of the Diamond.—The use of the diamond for other purposes than jewelry depends upon its extreme hardness: it has always been the only material used for cutting or engraving the diamond itself. The employment of powdered bort and the lapidary's wheel for faceting diamonds was introduced by L. von Berquen of Bruges in 1476. Diamonds are now employed not only for faceting precious stones, but also for cutting and drilling glass, porcelain, &c.; for fine engraving such as scales; in dentistry for drilling; as a turning tool for electric-light carbons, hard rubber, &c.; and occasionally for finishing accurate turning work such as the axle of a transit instrument. For these tools the stone is actually shaped to the best form: it is now electroplated before being set in its metal mount in order to secure a firm fastening. It is also used for bearings in watches and electric meters. The best glaziers' diamonds are chosen from crystals such that a natural curved edge can be used. For rock drills, and revolving saws for stone cutting, either diamond, bort or carbonado is employed, set in steel tubes, disks or bands. Rock drilling is the most important industrial application; and for this, owing to its freedom from cleavage, the carbonado is more highly prized than diamond; it is broken into fragments about 3 carats in weight; and in 1905 the value of carbonado was no less than from £10 to £14 a carat. It has been found that the "carbons" in drills can safely be subjected to a pressure of over 60 kilograms per square millimetre, and a speed of 25 metres per second. A recent application of the diamond is for wire drawing; a hole tapering towards the centre is drilled through a diamond, and the metal is drawn through this. No other tool is so endurable, or gives such uniform thickness of wire.

Distribution and Mining.—The most important localities for diamonds have been: (1) India, where they were mined from the earliest times till the close of the 19th century; (2) South America, where they have been mined since the middle of the 18th century; and (3) South Africa, to which almost the whole of the diamond-mining industry has been transferred since 1870.

India.—The diamond is here found in ancient sandstones and conglomerates, and in the river gravels and sands derived from them. The sandstones and conglomerates belong to the Vindhyan formation and overlie the old crystalline rocks: the diamantiferous beds are well defined, often not more than 1 ft. in thickness, and contain pebbles of quartzite, jasper, sandstone, slate, &c. The mines fall into five groups situated on the eastern side of the Deccan plateau about the following places (beginning from the south), the first three being in Madras. (1) Chennai near Cuddapah on the river Pennar. (2) Kurnool near Banaganapalle between the rivers Pennar and Kistna. (3) Kollar near Berwada on the river Kistna. (4) Sambalpur on the river Mahanadi in the Central Provinces. (5) Panna near Allahabad, in Bundelkhand. The mining has always been carried on by natives of low caste, and by primitive methods which do not differ much from those described by the French merchant Jean Baptiste Tavernier (1605-1689), who paid a prolonged visit to most

of the mines between 1638 and 1665 as a dealer in precious stones. According to his description shallow pits were sunk, and the gravel excavated was gathered into a walled enclosure where it was crushed and water was poured over it, and it was finally sifted in baskets and sorted by hand. The buying and selling was at that period conducted by young children. In more modern times there has been the same excavation of shallow pits, and slicing, sifting and sorting, by hand labour, the only machinery used being chain pumps made of earthen bowls to remove the water from the deeper pits.

At some of the Indian localities spasmodic mining has been carried on at different periods for centuries, at some the work which had been long abandoned was revived in recent times, at others it has long been abandoned altogether. Many of the large stones of antiquity were probably found in the Kollar group, where Tavernier found 60,000 workers in 1645 (?), the mines having, according to native accounts, been discovered about 100 years previously. Golconda was the fortress and the market for the diamond industry at this group of mines, and so gave its name to them. The old mines have now been completely abandoned, but in 1891 about 1000 carats were being raised annually in the neighbourhood of Hyderabad. The Sambalpur group appear to have been the most ancient mines of all, but they were not worked later than 1850. The Panna group were the most productive during the 19th century. India was no doubt the source of all the large stones of antiquity; a stone of 671 carats was found at Wajra Karur in the Chennur group in 1881, and one of 2101 carats at Hira Khud in 1809. Other Indian localities besides those mentioned above are Simla, in the N.W. Provinces, where a few stones have been found, and a district on the Gouel and the Sunk rivers in Bengal, which V. Ball has identified with the Soumelpour mentioned by Tavernier. The mines of Golconda and Kurnool were described as early as 1677 in the twelfth volume of the *Philosophical Transactions* of the Royal Society. At the present time very few Indian diamonds find their way out of the country, and so far as the world's supply is concerned, Indian mining of diamonds may be considered extinct. The first blow to this industry was the discovery of the Brazilian mines in Minas Geraes and Bahia.

Brazil.—Diamonds were found about 1725 at Tejuco (now Diamantina) in Minas Geraes, and the mining became important about 1740. The chief districts in Minas Geraes are (1) Bagagem on the W. side of the Serra da Mata da Corda; (2) Rio Abaete on the E. side of the same range; these two districts being among the head waters of the Rio de San Francisco and its tributaries; (3) Diamantina, on and about the watershed separating the Rio de San Francisco from the Rio Jequitinhonha; and (4) Grao Mogul, nearly 200 m. to the N.E. of Diamantina on the latter river.

The Rio Abaete district was worked on a considerable scale between 1785 and 1807, but is now abandoned. Diamantina is at present the most important district; it occupies a mountainous plateau, and the diamonds are found both on the plateau and in the river valleys below it. The mountains consist here of an ancient laminated micaceous quartzite, which is in parts a flexible sandstone known as itacolumite, and in parts a conglomerate; it is interbedded with clay-slate, mica-schist, hornblende-schist and haematite-schist, and intersected by veins of quartz. This series is overlain unconformably by a younger quartzite of similar character, and itself rests upon the crystalline schists. The diamond is found under three conditions: (1) in the gravels of the present rivers, embedded in a ferruginous clay-cemented conglomerate known as *cascalho*; (2) in terraces (*gupiarras*) in a similar conglomerate occupying higher levels in the present valleys; (3) in plateau deposits in a coarse surface conglomerate known as *gurgulho*, the diamond and other heavy minerals being embedded in the red clay which cements the larger blocks. Under all these three conditions the diamond is associated with fragments of the rocks of the country and the minerals derived from them, especially quartz, hornstone, jasper, the polymorphous oxide of titanium (rutile, anatase and brookite), oxides and hydrates of iron (magnetite, ilmenite, haematite, limonite), oxide of tin, iron pyrites, tourmaline, garnet, xenotime, monazite, kyanite, diaspore, sphene, topaz, and several phosphates, and also gold. Since the heavy minerals of the *cascalho* in the river beds are more worn than those of the terraces, it is highly probable that they have been derived by the cutting down of the older river gravels represented by the terraces; and since in both deposits the heavy minerals are more abundant near the heads of the valleys in the plateau, it is also highly probable that both have really been derived from the plateau deposit. In the latter, especially at São João da Chapada, the minerals accompanying the diamond are scarcely worn at all; in the terraces and the river beds they are more worn and more abundant; the terraces, therefore, are to be regarded as a first concentration of the plateau material by the old rivers; and the *cascalho* as a second concentration by the modern rivers. The mining is carried on by negroes under the supervision of overseers; the *cascalho* is dug out in the dry season and removed to a higher level, and is afterwards washed out by hand in running water in shallow wooden basins (*bateas*). The terraces can be worked at all seasons, and the material is partly washed out by leading streams on to it. The washing of the plateau material is effected in reservoirs of rain water.

It is difficult to obtain an estimate of the actual production of the Minas Geraes mines, for no official returns have been published, but in recent years it has certainly been rivalled by the yield in Bahia.

The diamond here occurs in river gravels and sands associated with the same minerals as in Minas Geraes; since 1844 the richest mines have been worked in the Serra de Cincora, where the mountains are intersected by the river Paraguassu and its tributaries; it is said that there were as many as 20,000 miners working here in 1845, and it was estimated that 54,000 carats were produced in Bahia in 1858. The earlier workings were in the Serra de Chapada to the N.W. of the mines just mentioned. In 1901 there were about 5000 negroes employed in the Bahia mines; methods were still primitive; the *cascalho* was dug out from the river beds or tunneled out from the valley side, and washed once a week in sluices of running water, where it was turned over with the hoe, and finally washed in wooden basins and picked over by hand; sometimes also the diamantiferous material is scooped out of the bed of the shallow rivers by divers, and by men working under water in caissons. It is almost exclusively in the mines of Bahia, and in particular in the Cincora district, that the valuable carbonado is found. The carbonado and the diamond have been traced to an extensive hard conglomerate which occurs in the middle of the sandstone formation. Diamonds are also mined at Salobro on the river Pardo not far inland from the port of Canavieiras in the S.E. corner of Bahia. The enormous development of the South African mines, which supplied in 1906 about 90% of the world's produce, has thrown into the shade the Brazilian production; but the *Bulletin* for Feb. 1909 of the International Bureau of American Republics gave a very confident account of its future, under improved methods.

South Africa.—The first discovery was made in 1867 by Dr W. G. Atherstone, who identified as diamond a pebble obtained from a child in a farm on the banks of the Orange river and brought by a trader to Grahamstown; it was bought for £500 and displayed in the Paris Exhibition of that year. In 1869 a stone weighing 831 carats was found near the Orange river; this was purchased by the earl of Dudley for £25,000 and became famous as the "Star of South Africa." A rush of prospectors at once took place to the banks of the Orange and Vaal rivers, and resulted in considerable discoveries, so that in 1870 there was a mining camp of no less than 10,000 persons on the "River Diggings." In the River Diggings the mining was carried on in the coarse river gravels, and by the methods of the Brazilian negroes and of gold placer-miners. A diggers' committee limited the size of claims to 30 ft. square, with free access to the river bank; the gravel and sand were washed in cradles provided with screens of perforated metal, and the concentrates were sorted by hand on tables by means of an iron scraper.

But towards the close of 1870 stones were found at Jagersfontein and at Dutoitspan, far from the Vaal river, and led to a second great rush of prospectors, especially to Dutoitspan, and in 1871 to what is now the Kimberley mine in the neighbourhood of the latter. At each of these spots the diamantiferous area was a roughly circular patch of considerable size, and in some occupied the position of one of those depressions or "pans" so frequent in S. Africa. These "dry diggings" were therefore at first supposed to be alluvial in origin like the river gravels; but it was soon discovered that, below the red surface soil and the underlying calcareous deposit, diamonds were also found in a layer of yellowish clay about 50 ft. thick known as "yellow ground." Below this again was a hard bluish-green serpentine rock which was at first supposed to be barren bed-rock; but this also contained the precious stone, and has become famous under the name of "blue ground," as the matrix of the S. African diamonds. The yellow ground is merely decomposed blue ground. In the Kimberley district five of these round patches of blue ground were found within an area little more than 3 m. in diameter; that at Kimberley occupying 10 acres, that at Dutoitspan 23 acres. There were soon 50,000 workers on this field, the canvas camp was replaced by a town of brick and iron surrounded by the wooden huts of the natives, and Kimberley became an important centre.

It was soon found that each mine was in reality a huge vertical funnel or crater descending to an unknown depth, and filled with diamantiferous blue ground. At first each claim was an independent pit 31 ft. square sunk into the blue ground; the diamantiferous rock was hoisted by bucket and windlass, and roadways were left across the pit to provide access to the claims. But the roadways soon fell in, and ultimately haulage from the claims could only be provided by means of a vast system of wire ropes extending from a triple staging of windlasses erected round the entire edge of the mine, which had by this time become a huge open pit; the ropes from the upper windlasses extended to the centre, and those from the lower tier to the sides of the pit; covering the whole mass like a gigantic cobweb. (See Plate II. fig. 12.) The buckets of blue ground were hauled up these ropes by means of horse whims, and in 1875 steam winding engines began to be employed. By this time also improved methods in the treatment of the blue ground were introduced. It was carried off in carts to open spaces, where an exposure of some weeks to the air was found to pulverize the hard rock far more efficiently than the old method of crushing with mallets. The placer-miner's cradle and rocking-trough were replaced by puddling troughs stirred by a revolving comb worked by horse power; reservoirs were constructed for the scanty water-supply, bucket elevators were introduced to carry away the tailings; and the natives were confined in compounds. For these improvements co-operation was necessary; the best claims, which in 1872 had risen from £100 to more than £4000 in value, began to be consolidated, and a Mining Board was introduced.

In a very few years, however, the open pit mining was rendered impossible by the mud rushes, by the falls of the masses of barren rock known as "reef," which were left standing in the mine, and by landslides from the sides, so that in 1883, when the pit had reached a depth of about 400 ft., mining in the Kimberley crater had become almost impossible. By 1889, in the whole group of mines, Kimberley, Dutoitspan, De Beers and Bultfontein, open pit working was practically abandoned. Meanwhile mining below the bottom of the pits by means of shafts and underground tunnels had been commenced; but the full development of modern methods dates from the year 1889 when Cecil Rhodes and Alfred Beit, who had already secured control of the De Beers mine, acquired also the control of the Kimberley mine, and shortly afterwards consolidated the entire group in the hands of the De Beers Company. (See KIMBERLEY.)

The scene of native mining was now transferred from the open pit to underground tunnels; the vast network of wire ropes (Plate II, fig. 12) with their ascending and descending buckets disappeared, and with it the cosmopolitan crowd of busy miners working like ants at the bottom of the pit. In place of all this, the visitor to Kimberley encounters at the edge of the town only a huge crater, silent and apparently deserted, with no visible sign of the great mining operations which are conducted nearly half a mile below the surface. The aspect of the Kimberley pit in 1906 is shown in fig. 13 of Plate II., which may be compared with the section of fig. 8.

In fig. 13, Plate II., the sequence of the basalt, shale and melaphyre is clearly visible on the sides of the pit; and fig. 8 shows how the crater or "pipe" of blue ground has penetrated these rocks and also the underlying quartzite. The workings at De Beers had extended into the still more deeply seated granite in 1906. Figure 9, Plate I., shows the top of the De Beers' crater with basalt overlying the shale. Figure 8 also explains the modern system of mining introduced by Gardner Williams. A vertical shaft is sunk in the vicinity of the mine, and from this horizontal tunnels are driven into the pipe at different levels separated by intervals of 40 ft. Through the blue ground itself on each level a series of parallel tunnels about 120 ft. apart are driven to the opposite side of the pipe, and at right angles to these, and 36 ft. apart, another series of tunnels. When the tunnels reach the side of the mine they are opened upwards and sideways so as to form a large chamber, and the overlying mass of blue ground and debris is allowed to settle down and fill up the gallery. On each level this process is carried somewhat farther back than on the level below (fig. 8); material is thus continually withdrawn from one side of the mine and extracted by means of the rock shaft on the opposite side, while the superincumbent debris is continually sinking, and is allowed to fall deeper on the side farthest from the shaft as the blue ground is withdrawn from beneath it. In 1905 the main shaft had been sunk to a depth of 2600 ft. at the Kimberley mine.

For the extraction and treatment of the blue ground the De Beers Company in its great winding and washing plant employs labour-saving machinery on a gigantic scale. The ground is transferred in trucks to the shaft where it is automatically tipped into skips holding 96 cubic ft. (six truck loads); these are rapidly hoisted to the surface, where their contents are automatically dumped into side-tipping trucks, and these in turn are drawn away in a continual procession by an endless wire rope along the tram lines leading to the vast "distributing floors." These are open tracts upon which the blue ground is spread out and left exposed to sun and rain until it crumbles and disintegrates, the process being hastened by harrowing with steam ploughs; this may require a period of three or six months, or even a year. The stock of blue ground on the floors at one time in 1905 was nearly 4,500,000 loads. The disintegrated ground is then brought back in the trucks and fed through perforated cylinders into the washing pans; the hard blue which has resisted disintegration on the floors, and the lumps which are too big to pass the cylindrical sieves, are crushed before going to the pans. These are shallow cylindrical troughs containing muddy water in which the diamonds and other heavy minerals (concentrates) are swept to the rim by revolving toothed arms, while the lighter stuff escapes near the centre of the pan. The concentrates are then passed over sloping tables (pulps) and shaken to and fro under a stream of water which effects a second concentration of the heaviest material.

Until recently the final separation of the diamond from the concentrates was made by hand picking, but even this has now been replaced by machinery, owing to the remarkable discovery that a greased surface will hold a diamond while allowing the other heavy minerals to pass over it. The concentrates are washed down a sloping table of corrugated iron which is smeared with grease, and it is found that practically all the diamonds adhere to the table, and the other minerals are washed away. At the large and important Premier mine in the Transvaal the Elmore process, used in British Columbia and in Wales for the separation of metallic ores, has been also introduced. In the Elmore process oil is employed to float off the materials which adhere to it, while the other materials remain in the water, the oil being separated from the water by centrifugal action. The other

minerals found in the concentrates are pebbles and fragments of pyrope, zircon, cyanite, chrome-diopside, enstatite, a green pyroxene, mica, ilmenite, magnetite, chromite, hornblende, olivine, barytes, calcite and pyrites.

In all the S. African mines the diamonds are not only crystals of various weights from fractions of a carat to 150 carats, but also occur as microscopic crystals disseminated through the blue ground. In spite of this, however, the average yield in the profitable mines is only from 0.2 carat to 0.6 carat per load of 1600 lb, or on an average about 1½ grs. per ton. The annual output of diamonds from the De Beers mines was valued in 1906 at nearly £5,000,000; the value per carat ranging from about 35s. to 70s.

Pipes similar to those which surround Kimberley have been found in other parts of S. Africa. One of the best known is that of Jagersfontein, which was really the first of the dry diggings (discovered in 1870). This large mine is near Fauresmith and 80 m. to the south of Kimberley. In 1905 the year's production from the Orange River Colony mines was more than 320,000 carats, valued at £938,000. But by far the largest of all the pipes hitherto discovered is the Premier

SECTION OF KIMBERLEY MINE

LOOKING EAST

From Gardner Williams's *Diamond Mines of South Africa*.

FIG. 8.

mine in the Transvaal, about 300 m. to the east of Kimberley. This was discovered in 1902 and occupies an area of about 75 acres. In 1906 it was being worked as a shallow open mine; but the description of the Kimberley methods given above is applicable to the washing plant at that time being introduced into the Premier mine upon a very large scale. Comparatively few of the pipes which have been discovered are at all rich in diamonds, and many are quite barren; some are filled with "hard blue" which even if diamantiferous may be too expensive to work.

The most competent S. African geologists believe all these remarkable pipes to be connected with volcanic outbursts which occurred over the whole of S. Africa during the Cretaceous period (after the deposition of the Stormberg beds), and drilled these enormous craters, through all the later formations. With the true pipes are associated dykes and fissures also filled with diamantiferous blue ground. It is only in the more northerly part of the country that the pipes are filled with blue ground (or "kimberlite"), and that they are diamantiferous; but over a great part of Cape Colony have been discovered what are probably similar pipes filled with agglomerates, breccias and tufts, and some with basic lavas; one, in particular, in the Riversdale Division near the southern coast, being occupied by a melilite-basalt. It is quite clear that the occurrence of the diamond in the S. African pipes is quite different from the occurrences in alluvial deposits which have been described above. The question of the origin of the diamond in S. Africa and elsewhere is discussed below.

The River Diggings on the Vaal river are still worked upon a small scale, but the production from this source is so limited that they are of little account in comparison with the mines in the blue ground. The stones, however, are good; since they differ somewhat from the Kimberley crystals it is probable that they were not derived from the present pipes. Another S. African locality must be mentioned; considerable finds were reported in 1905 and 1906 from gravels at Somabula near Gwelo in Rhodesia where the diamond is associated with chrysoberyl, corundum (both sapphire and ruby), topaz, garnet, ilmenite, staurolite, rutile, with pebbles of quartz, granite,

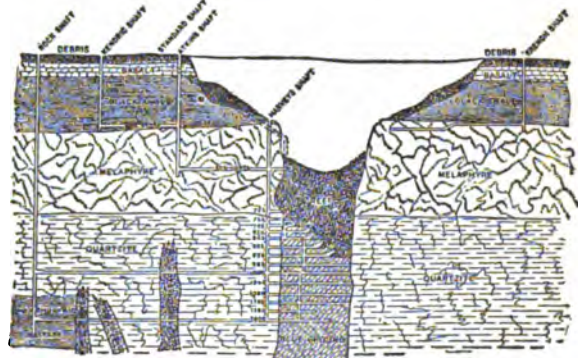
chlorite-schist, &c. Diamond has also been reported from kimberlite "pipes" in Rhodesia.

Other Localities.—In addition to the South American localities mentioned above, small diamonds have also been mined since their discovery in 1890 on the river Mazaruni in British Guiana, and finds have been reported in the gold washings of Dutch Guiana. Borneo has possessed a diamond industry since the island was first settled by the Malays; the references in the works of Garcia de Orta, Linschoten, De Boot, De Laet and others, to Malacca as a locality relate to Borneo. The large Borneo stone, over 360 carats in weight, known as the Matan, is in all probability not a diamond. The chief mines are situated on the river Kapuas in the west and near Bandjarmassin in the south-east of the island, and the alluvial deposits in which they occur are worked by a small number of Chinese and Malays. Australia has yielded diamonds in alluvial deposits near Bathurst (where the first discovery was made in 1851) and Mudgee in New South Wales, and also near Bingara and Inverell in the north of the colony. At Mount Werong a stone weighing 29 carats was found in 1905. At Ruby Hill near Bingara they were found in a breccia filling a volcanic pipe. At Ballina, in New England, diamonds have been found in the sea sand. Other Australian localities are Echunga in South Australia; Beechworth, Arena and Melbourne in Victoria; Freemantle and Nullagine in Western Australia; the Palmer and Gilbert rivers in Queensland. These have been for the most part discovered in alluvial deposits of the gold-fields, and the stones were small. In Tasmania also diamonds have been found in the Corinna goldfields. Europe has produced few diamonds. Humboldt searched for them in the Urals on account of the similarity of the gold and platinum deposits to those of Brazil, and small diamonds were ultimately found (1829) in the gold washings of Bissersk, and later at Ekaterinburg and other spots in the Urals. In Lapland they have been found in the sands of the Pasevig river. Siberia has yielded isolated diamonds from the gold washings of Yenisei. In North America a few small stones have been found in alluvial deposits, mostly auriferous, in Georgia, N. and S. Carolina, Kentucky, Virginia, Tennessee, Wisconsin, California, Oregon and Indiana. A crystal weighing 23½ carats was found in Virginia in 1855, and one of 21½ carats in Wisconsin in 1886. In 1906 a number of small diamonds were discovered in an altered peridotite somewhat resembling the S. African blue ground, at Murfreesboro, Pike county, Arkansas. Considerable interest attaches to the diamonds found in Wisconsin, Michigan and Ohio near the Great Lakes, for they are here found in the terminal moraines of the great glacial sheet which is supposed to have spread southwards from the region of Hudson Bay; several of the druse minerals of the diamantiferous region of Indiana have been identified as probably of Canadian origin; no diamonds have however yet been found in the intervening country of Ontario. A rock similar to the blue ground of Kimberley has been found in the states of Kentucky and New York. The occurrence of diamond in meteorites is described below.

Origin of the Diamond in Nature.—It appears from the foregoing account that at most localities the diamond is found in alluvial deposits probably far from the place where it originated. The minerals associated with it do not afford much clue to the original conditions; they are mostly heavy minerals derived from the neighbouring rocks, in which the diamond itself has not been observed. Among the commonest associates of the diamond are quartz, topaz, tourmaline, rutile, zircon, magnetite, garnet, spinel and other minerals which are common accessory constituents of granite, gneiss and the crystalline schists. Gold (also platinum) is a not infrequent associate, but this may only mean that the sands in which the diamond is found have been searched because they were known to be auriferous; also that both gold and diamond are among the most durable of minerals and may have survived from ancient rocks of which other traces have been lost.

The localities at which the diamond has been supposed to occur in its original matrix are the following:—at Wajra Karur, in the Cuddapah district, India, M. Chaper found diamond with corundum in a decomposed red pegmatite vein in gneiss. At São João da Chapada, in Minas Geraes, diamonds occur in a clay interstratified with the itacolumite, and are accompanied by sharp crystals of rutile and haematite in the neighbourhood of decomposed quartz veins which intersect the itacolumite. It has been suggested that these three minerals were originally formed in the quartz veins. In both these occurrences the evidence is certainly not sufficient to establish the presence of an original matrix. At Inverell in New South Wales a diamond (1906) has been found embedded in a hornblende diabase which is described as a dyke intersecting the granite. Finally there is the remarkable occurrence in the blue ground of the African pipes.

There has been much controversy concerning the nature and origin of the blue ground itself; and even granted that (as is generally believed) the blue ground is a much serpenitized volcanic breccia consisting originally of an olivine-bronzite-biotite rock (the so-called kimberlite), it contains so many rounded and angular fragments of various rocks and minerals that it is difficult to say which of them may have belonged to the original rock, and whether any were formed *in situ*, or were brought up from below as inclusions. Carvill Lewis believed the blue ground to be true eruptive rock, and the carbon to have been derived from the bituminous shales of which it contains fragments. The Kimberley shales, which are penetrated by the De

Beers group of pipes, were, however, certainly not the source of the carbon at the Premier (Transvaal) mine, for at this locality the shales do not exist. The view that the diamond may have crystallized out from solution in its present matrix receives some support from the experiments of W. Luzzi, who found that it can be corroded by the solvent action of fused blue ground; from the experiments of J. Friedländer, who obtained diamond by dissolving graphite in fused olivine; and still more from the experiments of K. von Hasslinger and J. Wolff, who have obtained it by dissolving graphite in a fused mixture of silicates having approximately the composition of the blue ground. E. Cohen, who regarded the pipes as of the nature of a mud volcano, and the blue ground as a kimberlite breccia altered by hydrothermal action, thought that the diamond and accompanying minerals had been brought up from deep-seated crystalline schists. Other authors have sought the origin of the diamond in the action of the hydrated magnesian silicates on hydrocarbons derived from bituminous schists, or in the decomposition of metallic carbides.

Of great scientific interest in this connexion is the discovery of small diamonds in certain meteorites, both stones and irons; for example, in the stone which fell at Novo-Urel in Penza, Russia, in 1886, in a stone found at Carcote in Chile, and in the iron found at Cañon Diablo in Arizona. Graphitic carbon in cubic form (diffronite) has also been found in certain meteoric "irons," for example in those from Magura in Szepes county, Hungary, and Younegin near York in Western Australia. The latter is now generally believed to be altered diamond. The fact that H. Moissan has produced the diamond artificially, by allowing dissolved carbon to crystallize out at a high temperature and pressure from molten iron, coupled with the occurrence in meteoric iron, has led Sir William Crookes and others to conclude that the mineral may have been derived from deep-seated iron containing carbon in solution (see the article GEM, ARTIFICIAL). Adolf Knop suggested that this may have first yielded hydrocarbons by contact with water, and that from these the crystalline diamond has been formed. The meteoric occurrence has even suggested the fanciful notion that all diamonds were originally derived from meteorites. The meteoric iron of Arizona, some of which contains diamond, is actually found in and about a huge crater which is supposed by some to have been formed by an immense meteorite penetrating the earth's crust.

It is, at any rate, established that carbon can crystallize as diamond from solution in iron, and other metals; and it seems that high temperature and pressure and the absence of oxidizing agents are necessary conditions. The presence of sulphur, nickel, &c., in the iron appears to favour the production of the diamond. On the other hand, the occurrence in meteoric stones, and the experiments mentioned above, show that the diamond may also crystallize from a basic magma, capable of yielding some of the metallic oxides and ferro-magnesian silicates; a magma, therefore, which is not devoid of oxygen. This is still more forcibly suggested by the remarkable eclogite boulder found in the blue ground of the Newlands mine, not far from the Vaal river, and described by T. G. Bonney. The boulder is a crystalline rock consisting of pyroxene (chrome-diopside), garnet, and a little olivine, and is studded with diamond crystals; a portion of it is preserved in the British Museum (Natural History). In another eclogite boulder, diamond was found partly embedded in pyrope. Similar boulders have also been found in the blue ground elsewhere. Specimens of pyrope with attached or embedded diamond had previously been found in the blue ground of the De Beers mines. In the Newlands boulder the diamonds have the appearance of being an original constituent of the eclogite. It seems therefore that a holocrystalline pyroxene-garnet rock may be one source of the diamond found in blue ground. On the other hand many tons of the somewhat similar eclogite in the De Beers mine have been crushed and have not yielded diamond. Further, the ilmenite, which is the most characteristic associate of the diamond in blue ground, and other of the accompanying minerals, may have come from basic rocks of a different nature.

The Inverell occurrence may prove to be another example of diamond crystallized from a basic rock.

In both occurrences, however, there is still the possibility that the eclogite or the basalit is not the original matrix, but may have caught up the already formed diamond from some other matrix. Some regard the eclogite boulders as derived from deep-seated crystalline rocks, others as concretions in the blue ground.

None of the inclusions in the diamond gives any clue to its origin: diamond itself has been found as an inclusion, as have also black specks of some carbonaceous materials. Other black specks have been identified as haematite and ilmenite; gold has also been found; other included minerals recorded are rutile, topaz, quartz, pyrites, apophyllite, and green scales of chlorite (?). Some of these are of very doubtful identification; others (e.g. apophyllite and chlorite) may have been introduced along cracks. Some of the fibrous inclusions were identified by H. R. Göppert as vegetable structures and were supposed to point to an organic origin, but this view is no longer held. Liquid inclusions, some of which are certainly carbon dioxide, have also been observed.

Finally, then, both experiment and the natural occurrence in rocks and meteorites suggest that diamond may crystallize not only from iron but also from a basic silicate magma, possibly from various rocks consisting of basic silicates. The blue ground of S. Africa may be

the result of the serpentinisation of several such rocks, and although now both brecciated and serpentinized some of these may have been the original matrix. A circumstance often mentioned in support of this view is the fact that the diamonds in one pipe generally differ somewhat in character from those of another, even though they be near neighbours.

History.—All the famous diamonds of antiquity must have been Indian stones. The first author who described the Indian mines at all fully was the Portuguese, Garcia de Orta (1565), who was physician to the viceroy of Goa. Before that time there were only legendary accounts like that of Sindbad's "Valley of the Diamonds," or the tale of the stones found in the brains of serpents. V. Ball thinks that the former legend originated in the Indian practice of sacrificing cattle to the evil spirits when a new mine is opened; birds of prey would naturally carry off the flesh, and might give rise to the tale of the eagles carrying diamonds adhering to the meat.

The following are some of the most famous diamonds of the world:—

A large stone found in the Golconda mines and said to have weighed 787 carats in the rough, before being cut by a Venetian lapidary, was seen in the treasury of Aurangzeb in 1665 by Tavernier, who estimated its weight after cutting as 280 (?) carats, and described it as a rounded rose-cut-stone, tall on one side. The name *Great Mogul* has been frequently applied to this stone. Tavernier states that it was the famous stone given to Shah Jahan by the emir Jumla. The *Orloff*, stolen by a French soldier from the eye of an idol in a Brahmin temple, stolen again from him by a ship's captain, was bought by Prince Orloff for £90,000, and given to the empress Catharine II. It weighs 194½ carats, is of a somewhat yellow tinge, and is among the Russian crown jewels. The *Koh-i-nor*, which was in 1739 in the possession of Nadir Shah, the Persian conqueror, and in 1813 in that of the raja of Lahore, passed into the hands of the East India Company and was by them presented to Queen Victoria in 1850. It then weighed 185½ carats, but was recut in London by Amsterdam workmen, and now weighs 106½ carats. There has been much discussion concerning the possibility of this stone and the Orloff being both fragments of the Great Mogul. The Mogul Baber in his memoirs (1526) relates how in his conquest of India he captured at Agra the great stone weighing 8 mihkals, or 330 ratis, which may be equivalent to about 187 carats. The Koh-i-nor has been identified by some authors with this stone and by others with the stone seen by Tavernier. Tavernier, however, subsequently described and sketched the diamond which he saw as shaped like a bisected egg, quite different therefore from the Koh-i-nor. Nevil Story Maskelyne has shown reason for believing that the stone which Tavernier saw was really the Koh-i-nor and that it is identical with the great diamond of Baber; and that the 280 carats of Tavernier is a misinterpretation on his part of the Indian weights. He suggests that the other and larger diamond of antiquity which was given to Shah Jahan may be one which is now in the treasury of Teheran, and that this is the true Great Mogul which was confused by Tavernier with the one he saw. (See Ball, Appendix I. to Tavernier's *Travels* (1889); and Maskelyne, *Nature*, 1891, 44, p. 555.)

The *Regent* or *Pitt* diamond is a magnificent stone found in either India or Borneo; it weighed 410 carats and was bought for £30,400 by Pitt, the governor of Madras; it was subsequently, in 1717, bought for £80,000 (or, according to some authorities, £135,000) by the duke of Orleans, regent of France; it was reduced by cutting to 136½ carats; was stolen with the other crown jewels during the Revolution, but was recovered and is still in France. The *Akbar Shah* was originally a stone of 116 carats with Arabic inscriptions engraved upon it; after being cut down to 71 carats it was bought by the galkwar of Baroda for £35,000. The *Nizam*, now in the possession of the nizam of Hyderabad, is supposed to weigh 277 carats; but it is only a portion of a stone which is said to have weighed 440 carats before it was broken. The *Great Table*, a rectangular stone seen by Tavernier in 1642 at Golconda, was found by him to weigh 242½ carats; Maskelyne regards it as identical with the *Darya-i-nur*, which is also a rectangular stone weighing about 186 carats in the possession of

the shah of Persia. Another stone, the *Taj-e-mah*, belonging to the shah, is a pale rose pear-shaped stone and is said to weigh 146 carats.

Other famous Indian diamonds are the following:—The *Sancy*, weighing 53½ carats, which is said to have been successively the property of Charles the Bold, de Sancy, Queen Elizabeth, Henrietta Maria, Cardinal Mazarin, Louis XIV.; to have been stolen with the Pitt during the French Revolution; and subsequently to have been the property of the king of Spain, Prince Demidoff and an Indian prince. The *Nassak*, 78½ carats, the property of the duke of Westminster. The *Empress Eugénie*, 51 carats, the property of the galkwar of Baroda. The *Pigott*, 49 carats (?), which cannot now be traced. The *Pasha*, 40 carats. The *White Saxon*, 48½ carats. The *Star of Este*, 25½ carats.

Coloured Indian diamonds of large size are rare; the most famous are:—a beautiful blue brilliant, 67½ carats, cut from a stone weighing 112½ carats brought to Europe by Tavernier. It was stolen from the French crown jewels with the Regent and was never recovered. The *Hope*, 44½ carats, has the same colour and is probably a portion of the missing stone: it was so-called as forming part of the collection of H. T. Hope bought for £18,000, and was sold again in 1906 (resold 1909). Two other blue diamonds are known, weighing 13½ and 1½ carats, which may also be portions of the French diamond. The *Dresden Green*, one of the Saxon crown jewels, 40 carats, has a fine apple-green colour. The *Florentine*, 133½ carats, one of the Austrian crown jewels, is a very pale yellow.

The most famous Brazilian stones are:—The *Star of the South*, found in 1853, when it weighed 254½ carats and was sold for £40,000; when cut it weighed 125 carats and was bought by the galkwar of Baroda for £80,000. Also a diamond belonging to Mr Dresden, 119 carats before, and 76½ carats after cutting.

Many large stones have been found in South Africa; some are yellow but some are as colourless as the best Indian or Brazilian stones. The most famous are the following:—the *Star of South Africa*, or *Dudley*, mentioned above, 83½ carats rough, 46½ carats cut. The *Stewart*, 288½ carats rough, 120 carats cut. Both these were found in the river diggings. The *Porter Rhodes* from Kimberley, of the finest water, weighed about 150 carats. The *Victoria*, 180 carats, was cut from an octahedron weighing 457½ carats, and was sold to the nizam of Hyderabad for £400,000. The *Tiffany*, a magnificent orange-yellow stone, weighs 125½ carats cut. A yellowish octahedron found at De Beers weighed 428½ carats, and yielded a brilliant of 288½ carats. Some of the finest and largest stones have come from the Jagersfontein mine; one, the *Jubilee*, found in 1895, weighed 640 carats in the rough and 239 carats when cut. Until 1905 the largest known diamond in the world was the *Excelsior*, found in 1803 at Jagersfontein by a native while loading a truck. It weighed 971 carats, and was ultimately cut into ten stones weighing from 68 to 13 carats. But all previous records were surpassed in 1905 by a magnificent stone more than three times the size of any known diamond, which was found in the yellow ground at the newly discovered Premier mine in the Transvaal. This extraordinary diamond weighed 302½ carats (1½ lb) and was clear and water white; the largest of its surfaces appeared to be a cleavage plane, so that it might be only a portion of a much larger stone. It was known as the *Cullinan Diamond*. This stone was purchased by the Transvaal government in 1907 and presented to King Edward VII. It was sent to Amsterdam to be cut, and in 1908 was divided into nine large stones and a number of small brilliants. The four largest stones weigh 516½ carats, 300½ carats, 92 carats and 62 carats respectively. Of these the first and second are the largest brilliants in existence. All the stones are flawless and of the finest quality.

BIBLIOGRAPHY.—Boettius de Boot, *Gemmarum et lapidum historia* (1609); D. Jeffries, *A Treatise on Diamonds and Pearls* (1757); J. Mawe, *Travels in the Interior of Brazil* (1812); *Treatise on Diamonds and Precious Stones* (1813); Pinder, *De adamante* (1829); Murray, *Memoir on the Nature of the Diamond* (1831); C. Zenerer, *De adamante dissertatio* (1850); H. Emanuel, *Diamonds and Precious Stones* (1865); A. Schrauf, *Edelsteinkunde* (1866); N. Jacobs and N. Chatrain, *Monographie des diamants* (1880); V. Ball, *Geology of India* (1891); C. W. King, *The Natural History of Precious Stones*

and Precious Metals (1883); M. E. Boutan; *Le Diamant* (1886); S. M. Burnham, *Precious Stones in Nature, Art and Literature* (1887); F. Groth, *Grundriss der Edelsteinkunde* (1887); A. Liversidge, *The Minerals of New South Wales* (1888); *Tavernier's Travels in India, Minerals*, translated by V. Ball (1889); E. W. Streeter, *The Great Diamonds of the World* (1896); H. C. Lewis, *The Genesis and Matrix of the Diamond* (1897); L. de Launay, *Les Diamants du Cap* (1897); C. Hintze, *Handbuch der Mineralogie* (1898); E. W. Streeter, *Precious Stones and Gems* (6th ed., 1898); Dana, *System of Mineralogy* (1899); Kunz and others, *The Production of Precious Stones* (in annual, *Mineral Resources of the United States*); M. Bauer, *Precious Stones* (trans. L. J. Spencer, 1904); A. W. Rogers, *An Introduction to the Geology of Cape Colony* (1905); Gardner F. Williams, *The Diamond Mines of South Africa* (revised edition, 1906); George F. Kunz, "Diamonds, a study of their occurrence in the United States, with descriptions and comparisons of those from all known localities" (U.S. Geol. Survey, 1909); P. A. Wagner, *Die Diamantführenden Gesteine Südafrikas* (1909).

Among papers in scientific periodicals may be mentioned articles by Adler, Ball, Baumhauser, Beck, Bonjour, Brewster, Chaper, Cohen, Crookes, Daurée, Derby, Des Cloizeaux, Doelter, Dunn, Flight, Friedel, Gorcex, Gurich, Goepfert, Harger, Hudleston, Hussak, Jannettaz, Jeremejew, de Launay, Lewis, Maskelyne, Meunier, Moissan, Molengraaff, Moulle, Rose, Sadebeck, Scheibe, Steizner, Stow. See generally Hintze's *Handbuch der Mineralogie*.

(H. A. M.)

DIAMOND NECKLACE, THE AFFAIR OF THE, a mysterious incident at the court of Louis XVI. of France, which involved the queen Marie Antoinette. The Parisian jewellers Boehmer and Bassenge had spent some years collecting stones for a necklace which they hoped to sell to Madame Du Barry, the favourite of Louis XV., and after his death to Marie Antoinette. In 1778 Louis XVI. proposed to the queen to make her a present of the necklace, which cost 1,600,000 livres. But the queen is said to have refused it, saying that the money would be better spent equipping a man-of-war. According to others, Louis XVI. himself changed his mind. After having vainly tried to place the necklace outside of France, the jewellers attempted again in 1781 to sell it to Marie Antoinette after the birth of the dauphin. It was again refused, but it was evident that the queen regretted not being able to acquire it.

At that time there was a personage at the court whom Marie Antoinette particularly detested. It was the cardinal Louis de Rohan, formerly ambassador at Vienna, whence he had been recalled in 1774, having incurred the queen's displeasure by revealing to the empress Maria Theresa the frivolous actions of her daughter, a disclosure which brought a maternal reprimand, and for having spoken lightly of Maria Theresa in a letter of which Marie Antoinette learned the contents. After his return to France the cardinal was anxious to regain the favour of the queen in order to obtain the position of prime minister. In March 1784 he entered into relations with a certain Jeanne de St Remy de Valois, a descendant of a bastard of Henry II., who after many adventures had married a *soi-disant* comte de Lamotte, and lived on a small pension which the king granted her. This adventuress soon gained the greatest ascendancy over the cardinal, with whom she had intimate relations. She persuaded him that she had been received by the queen and enjoyed her favour; and Rohan resolved to use her to regain the queen's good will. The comtesse de Lamotte assured the cardinal that she was making efforts on his behalf, and soon announced to him that he might send his justification to Marie Antoinette. This was the beginning of a pretended correspondence between Rohan and the queen, the adventuress duly returning replies to Rohan's notes, which she affirmed to come from the queen. The tone of the letters became very warm, and the cardinal, convinced that Marie Antoinette was in love with him, became ardently enamoured of her. He begged the countess to obtain a secret interview for him with the queen, and a meeting took place in August 1784 in a grove in the garden at Versailles between him and a lady whom the cardinal believed to be the queen herself. Rohan offered her a rose, and she promised him that she would forget the past. Later a certain Marie Lejay (renamed by the comtesse "Baronne Gay d'Oliva," the last word being apparently an anagram of Valoi), who resembled Marie Antoinette, stated that she had been engaged to play the role of queen in this comedy. In any case the countess profited by the cardinal's conviction to borrow

from him sums of money destined ostensibly for the queen's works of charity. Enriched by these, the countess was able to take an honourable place in society, and many persons believed her relations with Marie Antoinette, of which she boasted openly and unreservedly, to be genuine. It is still an unsettled question whether she simply mystified people, or whether she was really employed by the queen for some unknown purpose, perhaps to ruin the cardinal. In any case the jewellers believed in the relations of the countess with the queen, and they resolved to use her to sell their necklace. She at first refused their commission, then accepted it. On the 21st of January 1785 she announced that the queen would buy the necklace, but that not wishing to treat directly, she left the affair to a high personage. A little while later Rohan came to negotiate the purchase of the famous necklace for the 1,600,000 livres, payable in instalments. He said that he was authorized by the queen, and showed the jewellers the conditions of the bargain approved in the handwriting of Marie Antoinette. The necklace was given up. Rohan took it to the countess's house, where a man, in whom Rohan believed he recognized a valet of the queen, came to fetch it. Madame de Lamotte had told the cardinal that Marie Antoinette would make him a sign to indicate her thanks, and Rohan believed that she did make him a sign. Whether it was so, or merely chance or illusion, no one knows. But it is certain that the cardinal, convinced that he was acting for the queen, had engaged the jewellers to thank her; that Boehmer and Bassenge, before the sale, in order to be doubly sure, had sent word to the queen of the negotiations in her name; that Marie Antoinette had allowed the bargain to be concluded, and that after she had received a letter of thanks from Boehmer, she had burned it. Meanwhile the "comte de Lamotte" appears to have started at once for London, it is said with the necklace, which he broke up in order to sell the stones.

When the time came to pay, the comtesse de Lamotte presented the cardinal's notes; but these were insufficient, and Boehmer complained to the queen, who told him that she had received no necklace and had never ordered it. She had the story of the negotiations repeated for her. Then followed a *coup de théâtre*. On the 15th of August 1785, Assumption day, when the whole court was awaiting the king and queen in order to go to the chapel, the cardinal de Rohan, who was preparing to officiate, was arrested and taken to the Bastille. He was able, however, to destroy the correspondence exchanged, as he thought, with the queen, and it is not known whether there was any connivance of the officials, who did not prevent this, or not. The comtesse de Lamotte was not arrested until the 18th of August, after having destroyed her papers. The police set to work to find all her accomplices, and arrested the girl Oliva and a certain Reteaux de Villette, a friend of the countess, who confessed that he had written the letters given to Rohan in the queen's name, and had imitated her signature on the conditions of the bargain. The famous charlatan Cagliostro was also arrested, but it was recognized that he had taken no part in the affair. The cardinal de Rohan accepted the parlement of Paris as judges. A sensational trial resulted (May 31, 1786) in the acquittal of the cardinal, of the girl Oliva and of Cagliostro. The comtesse de Lamotte was condemned to be whipped, branded and shut up in the Salpêtrière. Her husband was condemned, in his absence, to the galley for life. Villette was banished.

Public opinion was much excited by this trial. It is generally believed that Marie Antoinette was stainless in the matter, that Rohan was an innocent dupe, and that the Lamottes deceived both for their own ends. People, however, persisted in the belief that the queen had used the countess as an instrument to satisfy her hatred of the cardinal de Rohan. Various circumstances fortified this belief, which contributed to render Marie Antoinette very unpopular—her disappointment at Rohan's acquittal, the fact that he was deprived of his charges and exiled to the abbey of la Chaise-Dieu, and finally the escape of the comtesse de Lamotte from the Salpêtrière, with the connivance, as people believed, of the court. The adventuress, having taken refuge abroad, published *Mémoires* in which she accused the queen. Her



Fig. 9.— De Beers Mine, 1874.



Fig. 10.— Kimberley Mine, 1874.

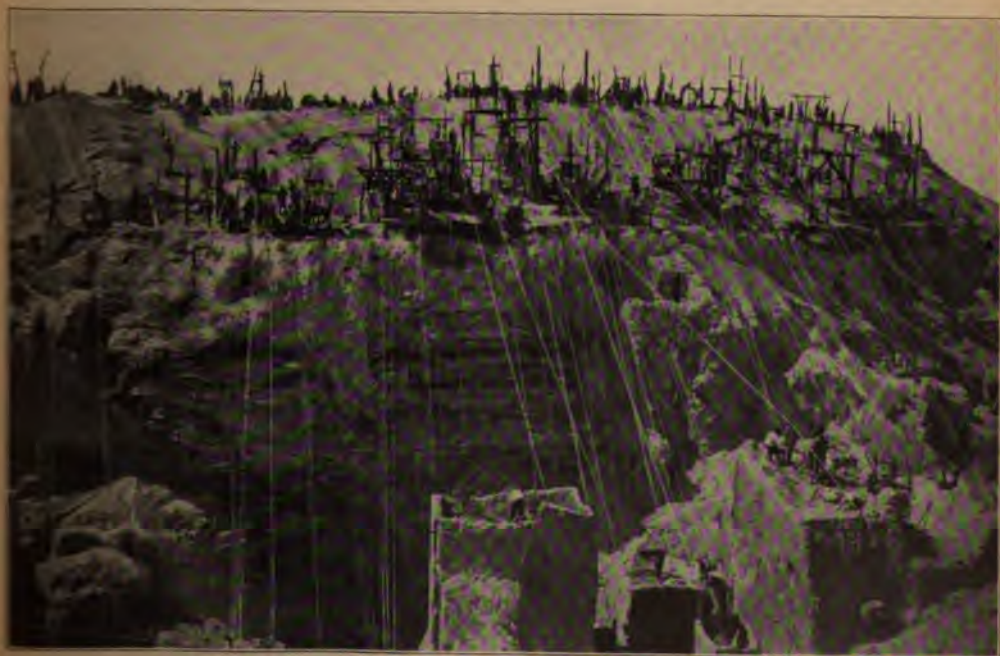

Fig. 11.— De Beers Mine, 1873.
(From photographs by C. Evans.)



Fig. 12.— Kimberley Mine, 1874.



Fig. 13.— Kimberley Mine, 1902.
(From photographs by C. Evans.)

husband also wrote *Mémoires*, and lived until 1831, after having, it is said, received subsidies from Louis XVIII.

See M. Tournoux, *Marie Antoinette devant l'histoire: Essai bibliographique* (2nd ed., Paris, 1901); Émile Campardon, *Marie Antoinette et le procès du collier* (Paris, 1863); P. Audebert, *L'Affaire du collier de la reine, d'après la correspondance inédite du chevalier de Pujol* (Rouen, 1901); F. d'Albini, *Marie Antoinette and the Diamond Necklace from another Point of View* (London, 1900); Funck-Brentano, *L'Affaire du collier* (1903); A. Lang, *Historical Mysteries* (1904). Carlyle's essay on *The Diamond Necklace* (first published in 1837 in *Fraser's Magazine*) is of historical literary interest.

DIANA, in Roman mythology, an old Italian goddess, in later times identified with the Greek Artemis (*q.v.*). That she was originally an independent Italian deity is shown by her name, which is the feminine form of Janus (= Dianus). She is essentially the goddess of the moon and light generally, and presides over wood, plain and water, the chase and war. As the goddess of childbirth, she was known, like Juno, by the name of Lucina, the "bringer of light." As the moon-goddess she was also identified with Hecate, and invoked as "three-formed" in reference to the phases of the moon. Her most celebrated shrine was in a grove at Aricia (whence her title of Nemorensis) near the modern lake of Nemi. Here she was worshipped side by side with a male deity Virbius, a god of the forest and the chase. This Virbius was subsequently identified with Hippolytus, the favourite of Artemis, who was said to have been brought to life by Aesculapius and conducted by Diana to Aricia (Ovid, *Fastii*, iii. 263, vi. 731, *Metam.* xv. 497; Virgil, *Aeneid*, vii. 761). A barbarous custom, perhaps reminiscent of human sacrifice once offered to her, prevailed in connexion with her ritual here; her priest, called *Rex Nemorensis*, who was a runaway slave, was obliged to qualify for office by slaying his predecessor in single combat (Strabo v. p. 239; Suetonius, *Caligula*, 35). This led to the identification of Diana with the Tauric Artemis, whose image was said to have been removed by Orestes to the grove of Aricia (see ARICINI).

After the destruction of Alba Longa this grove was for a long time the united sanctuary of the neighbouring Latin and Rutulian cities, until at last it was extinguished beneath the supremacy of Rome. The festival of the goddess was on the ides (13th) of August, the full moon of the hot season. She was worshipped with torches, her aid was sought by women seeking a happy deliverance in childbirth, and many votive offerings have been found on the site. The worship of Diana was brought to Rome by Latin plebeians, and hence she was regarded as the protectress of the lower classes, and especially of slaves. In accordance with this, her most important temple was that on the Aventine, the chief seat of the plebeians, founded by Servius Tullius, originally as a sanctuary of the Latin league (Dion. Halic. iv. 26). No man was allowed to enter the temple, and on the day of its dedication (August 13) the slaves kept holiday (Plutarch, *Quæst. Rom.* 100). This Diana was identified with the sister of Apollo, and at the secular games she was worshipped simply as Artemis. Another celebrated sanctuary of Diana was that on the slopes of Mount Titata near Capua (where she was worshipped under the name of Titatina), a sanctuary specially favoured by Sulla and Vespasian. As Noctiluca ("giving light by night") she had a sanctuary on the Palatine which was kept illuminated throughout the night (Varro, *L.L.* v. 68). On the Nemi priesthood see J. G. Frazer, *Golden Bough*.

DIANA MONKEY, a West African representative of the guenon monkeys taking its name, *Cercopithecus diana*, from the presence of a white crescent on the forehead; another characteristic feature being the pointed white beard. The general colour of the fur is greyish, with a deep tinge of chestnut from the middle of the back to the root of the tail. Together with *C. neglectus* of East and Central Africa, *C. ignitus* of Liberia, and *C. roloway* of the Gold Coast, the diana represents the special subgenus of guenons known as *Pogonocæbus*. Although the diana monkey is commonly seen in menageries, little is known of its habits in the wild state.

DIANE DE FRANCE (1538-1619), duchess of Montmorency and Angoulême, was the natural daughter of Henry II. of France and a young Piedmontese, Filippe Duc. The constable de

Montmorency went so far as to assert that of all the children of Henry II. Diane was the only one who resembled him. Catherine de' Medici was greatly incensed at this affront, and took her revenge by having the constable disgraced on the death of Henry II. Brantôme is loud in praise of Diane. She was a perfect horse-woman and dancer, played several musical instruments, knew Spanish and Italian, and "estoit très belle de visage et de taille." Legitimated in 1547, she was married in 1553 to Horace Farnese, second son of the duke of Parma, but her husband was killed soon afterwards at the siege of Hesdin. In order to assure his position, the constable de Montmorency wished to marry her to his eldest son, Francis. This was a romantic adventure, for Francis had clandestinely married Mademoiselle de Piennes. The constable dissolved this union, and after lengthy negotiations obtained the dispensation of the pope. On the 3rd of May 1559 Francis married Diane. A wise and moderate woman, Diane undoubtedly helped to make Francis de Montmorency one of the leaders of the party of the *politiques*. Again a widow in 1579, she had some influence at the court of Henry III., and negotiated his reconciliation with Henry of Navarre (1588). She retained her influence in the reign of Henry IV., conveyed the bodies of Catherine de' Medici and Henry III. to St Denis, and died in 1619 at her hôtel of Angoulême.

See Brantôme, ed. by Lalanne, in the *Coll de la société d'histoire de France*, vol. viii. (1875); J. de Thou, *Historia sui temporis* . . . (1733); Mathieu de Morgues, *Oraison funèbre de Diane de France* (Paris, 1619).

DIANE DE POITIERS (1499-1566), duchess of Valentinois, and mistress of Henry II. of France, was the daughter of Jean de Poitiers, seigneur de St Vallier, who came of an old family of Dauphiné. In 1515 she married Louis de Brézé, grand senechal of Normandy, by whom she had two daughters. She became a widow in 1533, but soon replaced her husband by a more illustrious lover, the king's second son, Henry, who became dauphin in 1536. Although he was ten years younger than Diane, she inspired the young prince with a profound passion, which lasted until his death. The accession of Henry II. in 1547 was also the accession of Diane: she was virtual queen, while Henry's lawful wife, Catherine de' Medici, lived in comparative obscurity. The part Diane played, however, must not be exaggerated. More rapacious than ambitious, she concerned herself little with government, but devoted her energies chiefly to augmenting her income, and providing for her family and friends. Henry was the most prodigal of lovers, and gave her all rights over the duchy of Valentinois. Although she showed great tact in her dealings with the queen, Catherine drove her from the court after Henry's death, and forced her to restore the crown jewels and to accept Chaumont in exchange for Chenonceaux. Diane retired to her château at Anet, where she died in 1566.

Several historians relate that she had been the mistress of Francis I. before she became the dauphin's mistress, and that she gave herself to the king in order to obtain the pardon of her father, who had been condemned to death as an accomplice of the constable de Bourbon. This rumour, however, has no serious foundation. Men vied with each other in celebrating Diane's beauty, which, if we may judge from her portraits, has been slightly exaggerated. She was a healthy, vigorous woman, and, by dint of great pains, succeeded in retaining her beauty late into life. It is said that even on the coldest mornings she would wash her face with well water. Diane was a patroness of the arts. She entrusted to Philibert de l'Orme the building of her château at Anet, and it was for her that Jean Goujon executed his masterpiece, the statue of Diane, now in the Louvre.

See G. Guiffrey, *Lettres inédites de Diane de Poitiers* (Paris, 1866) and *Procès criminel de Jehan de Poitiers* (Paris, 1867); Capéfigue, *Diane de Poitiers* (Paris, 1860); Hay, *Madame Dianna de Poitiers* (London, 1900).

DIAPASON (Gr. δᾶ πασῶν, through all), a term in music, originally for an interval of an octave. The Greek is an abbreviation of ἡ δᾶ πασῶν χορδῶν συμφωνία, a consonance through all the tones of the scale. In this sense it is only used now, loosely, for the compass of an instrument or voice, or for a harmonious melody. The name is given to the two

foundation stops of an organ, the open and the stopped diapason (see ORGAN), and to a standard of musical pitch, as in the French *diapason normal* (see PITCH, MUSICAL).

DIAPER (derived through the Fr. from the Gr. *διά*, through, and *διπρος*, white; the derivation from the town of Ypres, "d'Ypres," in Belgium is unhistorical, as diapers were known for centuries before its existence), the name given to a textile fabric, formerly of a rich and costly nature with embroidered ornament, but now of linen or cotton, with a simple woven pattern; and particularly restricted to small napkins. In architecture, the term "diaper" is given to any small pattern of a conventional nature repeated continuously and uniformly over a surface; the designs may be purely geometrical, or based

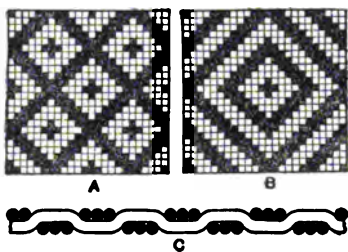

on floral forms, and in early examples were regulated by the process of their textile origin. Subsequently, similar patterns were employed in the middle ages for the surface decoration of stone, as in Westminster Abbey and Bayeux cathedral in the spandrils of the arcades of the choir and nave; also in mural painting, stained glass, incised brasses, encaustic tiles, &c. Probably in most cases the pattern was copied, so far as the general design is concerned, from the tissues and stuffs of Byzantine manufacture, which came over to Europe and were highly prized as ecclesiastical vestments.

In its textile use, the term diaper was originally applied to silk patterns of a geometrical pattern; it is now almost exclusively used for diamond patterns made from linen or cotton yarns. An illustration of two patterns of this nature is shown in the figure. The floats of the warp and the weft are mostly in three; indeed the patterns are made from a base weave which is composed entirely of floats of this number. It will be seen that both designs are formed of what may be termed concentric figures—alternately black and white. Pattern B differs from pattern A only in that more of these concentric figures are used for the complete figure. If pattern B, which shows only one unit, were extended, the effect would be similar to A, except for the size of the unit. In A there are four complete units, and hence the pattern appears more striking. Again, the repeating of B would cause the four corner pieces to join and to form a diamond similar to the one in the centre. The two diamonds in B would then alternate diagonally to left and right. Special names are given to certain kinds of diapers, e.g. "bird's-eye," "pheasant's-eye"; these terms indicate, to a certain extent, the size of the complete diamond in the cloth—the smaller kind taking the name "bird's-eye." The size of the pattern on paper has little connexion with the size of the pattern in the cloth, for it is clearly the number of threads and picks per inch which determine the size of the pattern in the cloth from any given design. Although A is larger than what is usually termed the "bird's-eye" pattern, it is evident that it may be made to appear as such, provided that the cloth is fine enough. These designs, although adapted mostly for cloths such as nursery-diapers, for pinafores, &c., are sometimes used in the production of towels and table-cloths. In the figure, the first pick in A is identical with the first pick in B, and the part C shows how each interweaves with the twenty-four threads.

DIAPHORETICS (from Gr. *διαφορέω*, to carry through), the name given to those remedies which promote perspiration. In health there is constantly taking place an exhalation of watery vapour from the skin, by which not only are many of the effete products of nutrition eliminated, but the body is kept cool. Under exertion or in a heated atmosphere this natural function of the skin is increased, sweating more or less profuse follows, and, evaporation going on rapidly over the whole surface, little or no rise in the temperature of the body takes place. In many forms of disease, such as fevers and inflammatory affections, the

action of the skin is arrested, and the surface of the body feels harsh and dry, while the temperature is greatly elevated. The occurrence of perspiration not unfrequently marks a crisis in such diseases, and is in general regarded as a favourable event. In some chronic diseases, such as diabetes and some cases of Bright's disease, the absence of perspiration is a marked feature; while, on the other hand, in many wasting diseases, such as phthisis, the action of the skin is increased, and copious exhausting sweating occurs. Many means can be used to induce perspiration, among the best known being baths, either in the form of hot vapour or hot water baths, or in that part of the process of the Turkish bath which consists in exposing the body to a dry and hot atmosphere. Such measures, particularly if followed by the drinking of hot liquids and the wrapping of the body in warm clothing, seldom fail to excite copious perspiration. Numerous medicinal substances have the same effect.

DIAPHRAGM (Gr. *διάφραγμα*, a partition). The diaphragm or midriff (Anglo-Saxon, *mid*, middle, *krif*, belly) in human anatomy is a large fibro-muscular partition between the cavities of the thorax and abdomen; it is convex toward the thorax, concave toward the abdomen, and consists of a central tendon and a muscular margin. The *central tendon* (g, fig. 1) is trefoil in shape, its leaflets being right, left and anterior; of these the right is the largest and the left the smallest. The fleshy fibres rise, in front from the back of the xiphoid cartilage of the sternum (d), laterally by six serrations, from the inner surfaces of the lower six ribs, interdigitating with the transversalis, posteriorly from the arcuate ligaments, of which there are five, a pair of external, a pair of internal, and a single median one. The *external arcuate ligament* (h) stretches from the tip of the twelfth rib (b) to the costal process of the first lumbar vertebra in front of the quadratus lumborum muscle (o), the *internal* and *middle* are continuations of the *crura* which rise from the ventro-lateral aspects of the bodies of the lumbar vertebrae, the right (e) coming from three, the left (f) from two. On reaching the level of the twelfth thoracic vertebra each crus spreads out into a fan-shaped mass of fibres, of which the innermost join their fellows from the opposite crus, in front of the aortic opening (k), to form the *middle arcuate*

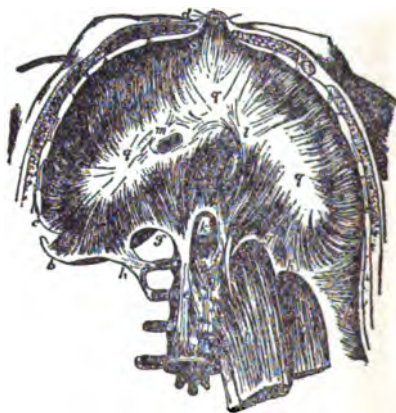

FIG. 1.—Abdominal Surface of the Diaphragm. *ligament*; the outer ones (g) arch in front of the psoas muscle (π) to the tip of the costal process of the first lumbar vertebra to form the *internal arcuate ligament*, while the intermediate ones pass to the central tendon. There are three large openings in the diaphragm; the *aortic* (k) is behind the middle arcuate ligament and transmits the aorta, the *vena azygos major*, and the *thoracic duct*. In the right leaflet is an opening (sometimes called the *hiatus quadratus*) for the inferior vena cava and a branch of the right phrenic nerve (m), while in front and a little to the left of the aortic opening is one for the oesophagus and the two pneumogastric nerves (l), the left being in front and the right behind.

The fleshy fibres on each side of this opening act as a sphincter. Passing between the xiphoid and costal origins in front are the superior epigastric arteries, while the other terminal branches of the internal mammaries, the musculo-phrenics, pass through between two costal origins.

Through the crura pass the splanchnic nerves, and in addition to these the left crus is pierced by the vena asygos minor. The sympathetic nerves usually enter the abdomen behind the internal arcuate ligaments. The phrenic nerves, which are the main supply of the diaphragm, divide before reaching the muscle and pierce it in a number of places to enter its abdominal surface, but some of the lower intercostal nerves assist in the supply. The last thoracic or subcostal nerves pass behind the external arcuate ligament.

For the action of the diaphragm see RESPIRATORY SYSTEM.

Embryology.—The diaphragm is at first developed in the neck region of the embryo, and this accounts for the phrenic nerves, which supply it, rising from the fourth and fifth cervical. From the mesoderm on the caudal side of the pericardium is developed the *septum transversum*, and in this the central tendon is formed. The fleshy portion is developed on each side in two parts, an anterior or sterno-costal which is derived from the longitudinal neck musculature, probably the same layer from which the sternothyroid comes, and a spinal part which is a derivative of the transversalis sheath of the trunk. Between these two parts is at one time a gap, the *spino-costal hiatus*, and this is obliterated by the growth of the pleuro-peritoneal membrane, which may occasionally fail to close and so may form the site of a phrenic hernia. With the growth of the body and the development of the lungs the diaphragm shifts its position until it becomes the septum between the thoracic and abdominal cavities. (See A. Keith, "On the Development of the Diaphragm," *Jour. of Anat. and Phys.* vol. 39.) A. Paterson has recorded cases in which the left half of the diaphragm is wanting (*Proceedings of the Anatomical Society of Gt. Britain*, June 1900; *Jour. of Anat. and Phys.* vol. 34), and occasionally deficiencies are found elsewhere, especially in the sternal portion. For further details see Quain's *Anatomy*, vol. 1 (London, 1908).

Comparative Anatomy.—A complete diaphragm, separating the thorax from the abdominal parts of the coelom, is characteristic of the Mammalia; it usually has the human structure and relations except that below the Anthropoids it is separated from the pericardium by the arygous lobe of the lung. In some Mammals, e.g. Echidna and Phocaena, it is entirely muscular. In the Cetacea it is remarkable for its obliquity; its vertebral attachment is much nearer the tail than its sternal or ventral one; this allows a much larger lung space in the dorsal than in the ventral part of the thorax, and may be concerned with the equipoise of the animal. (Otto Müller, "Untersuchungen über die Veränderung, welche die Respirationsorgane der Säugetiere durch die Anpassung an das Leben im Wasser erlitten haben," *Jen. Zeitschr. f. Naturwiss.*, 1898, p. 93.) In the Ungulata only one crus is found (Windle and Parsons, "Muscles of the Ungulata," *Proc. Zool. Soc.*, 1903, p. 287). Below the Mammalia incomplete partitions between the pleural and peritoneal cavities are found in Chelonians, Crocodiles and Birds, and also in Amphibians (*Xenopus* and *Pipa*). (F. G. P.)

DIARBEK¹ (*Kars Amid* or *Black Amid*; the Roman *Amida*), the chief town of a vilayet of Asiatic Turkey, situated on a basaltic plateau on the right bank of the Tigris, which here flows in a deep open valley. The town is still surrounded by the masonry walls of black basalt which give it the name of *Kars* or *Black Amid*; they are well built and imposing on the west facing the open country, but almost in ruins where they overlook the river. A mass of gardens and orchards cover the slope down to the river on the S.W., but there are no suburbs outside the walls. The houses are rather crowded but only partially fill the walled area. The population numbers 38,000, nearly half being Christian, comprising Turks, Kurds, Arabs, Turkomans, Armenians, Chaldeans, Jacobites and a few Greeks. The streets are 10 ft to 15 ft wide, badly paved and dirty; the houses and shops are low, mostly of stone, and some of stone and mud. The bazaar is a good one, and gold and silver filigree work is made, peculiar in character and design. The cotton industry is declining, but manufacture of silk is increasing. Fruit is good and abundant as the rich volcanic soil is well watered from the town springs. The size of the melons is specially famous. To the south, the walls are some 40 ft. high, faced with large cut stone blocks of very solid construction, with towers and square bastions rising to 500 ft. There are four gates: on the north the Kharput gate, on the west the Rum, on the south the Mardin, and on the

east the Yeni Kapu or new gate. A citadel enclosure stands at the N. E. corner and is now partly in ruins, but the interior space is occupied by the government konak. The summer climate in the confined space within the town is excessively hot and unhealthy. Epidemics of typhus are not unknown, as well as ophthalmia. The Diarbekr boil is like the "Aleppo button," lasting a long time and leaving a deep scar. Winters are frequently severe but do not last long. Snow sometimes lies, and ice is stored for summer use. Scorpions noted for the virulence of their poison abound as well as horse leeches in the tanks. The town is supplied with water both by springs inside the town and by aqueducts from fountains at Ali Pinar and Hamerivat. The principal exports are wool, mohair and copper ore, and imports are cotton and woollen goods, indigo, coffee, sugar, petroleum, &c.

The Great Mosque, Ulu Jami, formerly a Christian church, occupies the site of a Sassanian palace and was built with materials from an older palace, probably that of Tigranes II. The remains consist of the façades of two palaces 400 ft. apart, each formed by a row of Corinthian columns surmounted by an equal number of a Byzantine type. Kufic inscriptions run across the fronts under the entablature. The court of the mosque is entered by a gateway on which lions and other animals are sculptured. The churches of greatest interest are those of SS. Cosmas and Damian (Jacobite) and the church of St James (Greek). In the 10th century Diarbekr was one of the largest and most flourishing cities of Asia, and as a commercial centre it now stands at the meeting-point of several important routes. It is at the head of the navigation of the Tigris, which is traversed down stream by keleks or rafts supported by inflated skins. There is a good road to Aleppo and Alexandretta on the Mediterranean, and to Samsun on the Black Sea by Kharput, Malatia and Sivas. There are also routes to Mosul and Bitlis.

Diarbekr became a Roman colony in A.D. 230 under the name of Amida, and received a Christian bishop in A.D. 325. It was enlarged and strengthened by Constantius II., in whose reign it was taken after a long siege by Shapur (Sapor) II., king of Persia. The historian Ammianus Marcellinus, who took part in the defence, gives a detailed account of it. In the later wars between the Persians and Romans it more than once changed hands. Though ceded by Jovian to the Persians it again became annexed to the Roman empire, and in the reign of Anastasius (A.D. 502) was once more taken by the Persians, when 80,000 of its inhabitants were slain. It was taken c. 638 by the Arabs, and afterwards passed into the hands of the Seljuks and Persians, from whom it was finally captured by Selim I. in 1515; and since that date it has remained under Ottoman rule. About 2 m. below the town is a masonry bridge over the Tigris; the older portion being probably Roman, and the western part, which bears a Kufic inscription, being Arab.

The vilayet of Diarbekr extends south from Palu on the Euphrates to Mardin and Nusibin on the edge of the Mesopotamian plain, and is divided into three sanjaks—Arghana, Diarbekr and Mardin. The headwaters of the main arm of the Tigris have their source in the vilayet.

Cereals, cotton, tobacco, rice and silk are produced, but most of the fertile lands have been abandoned to semi-nomads, who raise large quantities of live stock. The richest portion of the vilayet lies east of the capital in the rolling plains watered by tributaries of the Tigris. An exceptionally rich copper mine exists at Arghana Maden, but it is very imperfectly worked; galena mineral oil and silicious sand are also found.

(C. W. W.; F. R. M.)

DIARRHOEA (from Gr. *diá*, through, *hêw*, flow), an excessive looseness of the bowels, a symptom of irritation which may be due to various causes, or may be associated with some specific disease. The treatment in such latter cases necessarily varies, since the symptom itself may be remedial, but in ordinary cases depends on the removal of the cause of irritation by the use of aperients, various sedatives being also prescribed. In chronic diarrhoea careful attention to the diet is necessary.

¹ From *Diar*, land, and *Bekr* (i.e. Abu Bekr, the caliph).

DIARY, the Lat. *diarium* (from *dies*, a day), the book in which are preserved the daily memoranda regarding events and actions which come under the writer's personal observation, or are related to him by others. The person who keeps this record is called a diarist. It is not necessary that the entries in a diary should be made each day, since every life, however full, must contain absolutely empty intervals. But it is essential that the entry should be made during the course of the day to which it refers. When this has evidently not been done, as in the case of Evelyn's diary, there is nevertheless an effort made to give the memoranda the effect of being so recorded, and in point of fact, even in a case like that of Evelyn, it is probable that what we now read is an enlargement of brief notes jotted down on the day cited. When this is not approximately the case, the diary is a fraud, for its whole value depends on its instantaneous transcript of impressions.

In its primitive form, the diary must always have existed; as soon as writing was invented, men and women must have wished to note down, in some almanac or journal, memoranda respecting their business, their engagements or their adventures. But the literary value of these would be extremely insignificant until the spirit of individualism had crept in, and human beings began to be interesting to other human beings for their own sake. It is not, therefore, until the close of the Renaissance that we find diaries beginning to have literary value, although, as the study of sociology extends, every scrap of genuine and unaffected record of early history possesses an ethical interest. In the 17th century, diaries began to be largely written in England, although in most cases without any idea of even eventual publication. Sir William Dugdale (1605-1686) had certainly no expectation that his slight diary would ever see the light. There is no surviving record of a journal kept by Clarendon, Richard Baxter, Lucy Hutchinson and other autobiographical writers of the middle of the century, but we may take it for granted that they possessed some such record, kept from day to day. Bulstrode Whitelocke (1605-1675), whose *Memoirs of the English Affairs* covers the ground from 1625 to 1660, was a genuine diarist. So was the elder George Fox (1624-1690), who kept not merely "a great journal," but "the little journal books," and whose work was published in 1694. The famous diary of John Evelyn (1620-1706) professes to be the record of seventy years, and, although large tracts of it are covered in a very perfunctory manner, while in others many of the entries have the air of having been written in long after the event, this is a very interesting and amusing work; it was not published until 1818. In spite of all its imperfections there is a great charm about the diary of Evelyn, and it would hold a still higher position in the history of literature than it does if it were not overshadowed by what is unquestionably the most illustrious of the diaries of the world, that of Samuel Pepys (1633-1703). This was begun on the 1st of January 1660 and was carried on until the 29th of May 1669. The extraordinary value of Pepys' diary consists in its fidelity to the portraiture of its author's character. He feigns nothing, conceals nothing, sets nothing down in malice or insincerity. He wrote in a form of shorthand intelligible to no one but himself, and not a phrase betrays the smallest expectation that any eye but his own would ever investigate the pages of his confession. The importance of this wonderful document, in fact, lay unsuspected until 1819, when the Rev. John Smith of Baldock began to decipher the MS. in Magdalene College, Cambridge. It was not until 1825 that Lord Braybrooke published part of what was only fully edited, under the care of Mr Wheatley, in 1893-1896. In the age which succeeded that of Pepys, a diary of extraordinary emotional interest was kept by Swift from 1710 to 1713, and was sent to Ireland in the form of a "Journal to Stella"; it is a surprising amalgam of ambition, affection, wit and freakishness. John Byrom (1692-1763), the Manchester poet, kept a journal, which was published in 1854. The diary of the celebrated dissenting divine, Philip Doddridge (1702-1751), was printed in 1820. Of far greater interest are the admirably composed and vigorously written journals of John Wesley (1703-1791). But the most celebrated work of this kind produced in the latter half of the 18th

century was the diary of Fanny Burney (Madame D'Arbly), published in 1842-1846. It will be perceived that, without exception, these works were posthumously published, and the whole conception of the diary has been that it should be written for the writer alone, or, if for the public, for the public when all prejudice shall have passed away and all passion cooled down. Thus, and thus only, can the diary be written so as to impress upon its eventual readers a sense of its author's perfect sincerity and courage.

Many of the diaries described above were first published in the opening years of the 19th century, and it is unquestionable that the interest which they awakened in the public led to their imitation. Diaries ceased to be rare, but as a rule the specimens which have hitherto appeared have not presented much literary interest. Exception must be made in favour of the journals of two minor politicians, Charles Greville (1794-1865) and Thomas Creevey (1768-1838), whose indiscretions have added much to the gaiety of nations; the papers of the former appeared in 1874-1887, those of the latter in 1903. The diary of Henry Crabb Robinson (1775-1867), printed in 1869, contains excellent biographical material. Tom Moore's journal, published in 1856 by Lord John Russell, disappointed its readers. But it is probable, if we reason by the analogy of the past, that the most curious and original diaries of the 19th century are still unknown to us, and lie jealously guarded under lock and key by the descendants of those who compiled them.

It was natural that the form of the diary should appeal to a people so sensitive to social peculiarities and so keen in the observation of them as the French. A mediæval document of immense value is the diary kept by an anonymous *cure* during the reigns of Charles VI. and Charles VII. This *Journal d'un bourgeois de Paris* was kept from 1409 to 1431, and was continued by another hand down to 1449. The marquis de Dangeau (1638-1720) kept a diary from 1684 till the year of his death; this although dull, and as Saint-Simon said "of an insipidity to make you sick," is an inexhaustible storehouse of facts about the reign of Louis XIV. Saint-Simon's own brilliant memoirs, written from 1691 to 1723, may be considered as a sort of diary. The lawyer, Edmond Barbier (1689-1771), wrote a journal of the anecdotes and little facts which came to his knowledge from 1718 to 1762. The studious care which he took to be correct, and his manifest candour, give a singular value to Barbier's record; his diary was not printed at all until 1847, nor, in its entirety, until 1857: The song-writer, Charles Collé (1709-1783), kept a *journal historique* from 1758 to 1782; it is full of vivacity, but very scandalous and spiteful. It saw the light in 1805, and surprised those to whom Collé, in his lifetime, had seemed the most placid and good-natured of men. Petit de Bachaumont (1690-1770) had access to remarkable sources of information, and his *Mémoires secrets* (a diary the publication of which began in 1762 and was continued after Bachaumont's death, until 1787, by other persons) contains a valuable mass of documents. The marquis d'Argenson (1694-1757) kept a diary, of which a comparatively full text was first published in 1859. In recent times the posthumous publication of the diaries of the Russian artist, Marie Bashkirtseff (1860-1884), produced a great sensation in 1887, and revealed a most remarkable temperament. The brothers Jules and Edmond de Goncourt kept a very minute diary of all that occurred around them in artistic and literary Paris; after the death of Jules, in 1870, this was continued by Edmond, who published the three first volumes in 1888. The publication of this work was continued, and it produced no little scandal. It is excessively ill-natured in parts, but of its vivid picturesqueness, and of its general accuracy as a transcript of conversation, there can be no two opinions. (E. G.)

DIASPORE, a native aluminium hydroxide, $\text{AlO}(\text{OH})$, crystallizing in the orthorhombic system and isomorphous with *göthite* and *manganite*. It occurs sometimes as flattened crystals, but usually as lamellar or scaly masses, the flattened surface being a direction of perfect cleavage on which the lustre is markedly pearly in character. It is colourless or greyish-white, yellowish, sometimes violet in colour, and varies from translucent to

transparent. It may be readily distinguished from other colourless transparent minerals, with a perfect cleavage and pearly lustre—mica, talc, brucite, gypsum—by its greater hardness of 6-7. The specific gravity is 3.4. When heated before the blowpipe it decrepitates violently, breaking up into white pearly scales; it was because of this property that the mineral was named diaspore by R. J. Hatly in 1801, from *diasterpeus*, "to scatter." The mineral occurs as an alteration product of corundum or emery, and is found in granular limestone and other crystalline rocks. Well-developed crystals are found in the emery deposits of the Urals and at Chester, Massachusetts, and in kaolin at Schemnitz in Hungary. If obtainable in large quantity it would be of economic importance as a source of alumina. (L. J. S.)

DIASTYLE (from Gr. *diá*, through, and *στύλος*, column), in architecture, a term used to designate an intercolumniation of three or four diameters.

DIATOMACEAE. For the knowledge we possess of these beautiful plants, so minute as to be undiscernible by our unaided vision, we are indebted to the assistance of the microscope. It was not till towards the close of the 18th century that the first known forms of this group were discovered by O. F. Müller. And so slow was the process of discovery in this field of scientific research that in the course of half a century, when Agardh published his *Systema algarum* in 1824, only forty-nine species included under eight genera had been described. Since that time, however, with modern microscopes and microscopic methods, eminent botanists in all parts of the civilized world have studied these minute plants, with the result that the number of known genera and species has been greatly increased. Over 10,000 species of diatoms have been described, and about 1200 species and numerous varieties occur in the fresh waters and on the coasts of Great Britain and Ireland. Rabenhorst, in the index to his *Flora Europaea algarum* (1864) enumerated about 4000 forms which had up to that time been discovered throughout the continent of Europe.

The diatoms are more commonly known among systematic botanists as the Bacillariaceae, particularly on the continent of Europe, and although such an immense number of very diverse forms are included in it, the group as a whole exhibits a remarkable uniformity of structure. The Bacillariaceae is one of the large groups of Algae, placed by some in close proximity to the

centic; others again are cuneate, as *Podosphenia Lyngbyii* (fig. 3); some few have a sigmoid outline, as *Pleurosigma balticum* (fig. 4); but the prevailing forms are naviculoid, as in the large family Naviculaceae, of which the genus *Navicula* embraces upwards of 1000 species. They vary also in their modes of growth,—some being free-floating, others attached to foreign bodies by simple or branched gelatinous stalks, which in some species are short and thick, while in others they are long and slender. In some genera the forms are simple, while in others the frustules are connected together in ribbon-like filaments, or form, as in other cases, zigzag chains. In some genera the individuals are naked, while in many others they are enclosed in a more or less definite gelatinous investment. The conditions necessary to their growth are moisture and light. Wherever these circumstances coexist, diatomaceous



FIG. 3.—*Podosphenia Lyngbyii*.

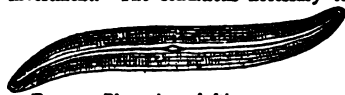

FIG. 4.—*Pleurosigma balticum*.

forms will almost invariably be found. They occur mixed with other organisms on the surface of moist rocks; in streamlets and pools, they form a brownish stratum on the surface of the mud, or cover the stems and leaves of water plants or floating twigs with a furry investment. Marine forms are usually attached to various sea-weeds, and many are found in the stomachs of molluscs, holothurians, ascidians and other denizens of the ocean. The fresh-water forms are specifically distinct from those incidental to salt or brackish water,—fresh-water species, however, are sometimes

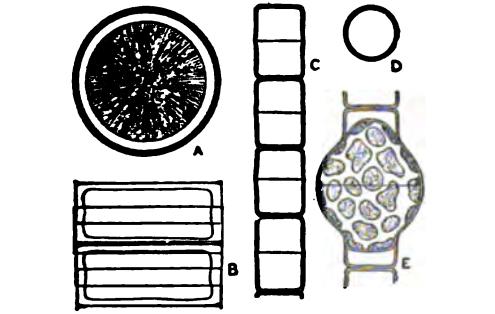

FIG. 1.

A and B, *Melosira arenaria*.
E, showing formation of auxospore.

C-E, *Melosira varians*.

Conjugatae and by others as an order of the Brown Algae (or Phaeophyceae); but their characters are so distinctive and their structure is so uniform as to warrant the separation of the diatoms as a distinct class. The affinities of the group are doubtful.



FIG. 2.—*Synedra Ulna*.

or less disk-shaped, others are oval in outline. Some are linear, as *Synedra Ulna* (fig. 2); others more or less cres-

The diatoms exhibit great variety of form. While some species are circular and more

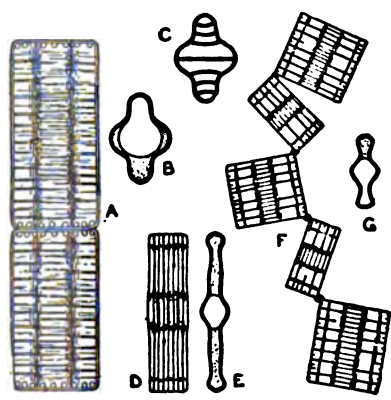

FIG. 5.

A-C, *Tetracyclus lacustris*.
D and E, *Tabellaria fenestrata*.
F and G, *Tabellaria flocculosa*.

carried some distance into the sea by the force of the current, and in tidal rivers marine forms are carried up by the force of the tide. Some notion may be formed of the extreme minuteness of these forms from the fact that one the length of which is $\frac{1}{100}$ th of an inch may be considered as beyond the medium size. Some few, indeed, are much larger, but by far the greater proportion are of very much smaller dimensions.

Diatoms are unicellular plants distinguished from kindred forms by the fact of having their soft vegetative part covered by a siliceous case. Each individual is known as a frustule, and the cell-wall consists of two similar valves nearly parallel to each other, each valve being furnished with a rim (or connecting-band) projecting from it at a right angle.

One of these valves with its rim is slightly smaller than the

other, the smaller fitting into the larger pretty much as a pill-box fits into its cover. This peculiarity of structure affords ample scope for the growth of the protoplasmic cell-contents, for as the latter increase in volume the siliceous valves are pushed out, and their corresponding siliceous rims become broader. The connecting-bands although closely fitting their respective valves are distinct from them, and together the two bands form the girdle.

An individual diatom is usually described from two aspects, one in which the surface of the valve is exposed to view—the valve view, and one in which the girdle side is exposed—the girdle view. The valves are thin and transparent, convex on the outside, and generally ornamented with a variety of sculptured markings. These sculptures often present the aspect of striae across the face of the valve, and the best lenses have shown them to consist of a series of small cavities within the siliceous wall of the cell. The valves of some of the marine genera exhibit a beautiful areolated structure due to the presence of larger chambers within the siliceous cell-wall. Many diatoms possess thickenings of the cell-wall, visible in the valve view, in the centre of the valve and at each extremity. These thickenings are known as the nodules, and they are generally connected by a long median line, the raphe, which is a cleft in the siliceous valve, extending at least some part of its length.

The protoplasmic contents of this siliceous box-like unicell are very similar to the contents of many other algal cells. There is a living protoplasmic layer or primordially utricle, connected either by two broad bands or by a number of anastomosing threads with a central mass of protoplasm in which the nucleus is embedded. The greater part of the cavity of the cell is occupied by one or several fluid vacuoles. The characteristic brown colour of diatoms is due to the presence of chromatophores embedded in the lining layer of protoplasm. In number and form these chromatophores are variable. They contain chlorophyll, but the green colour is masked by the presence of diatomin, a brown pigment which resembles that which occurs in the Brown Algae or Phaeophyceae. The chromatophores contain a variable number of pyrenoids, colourless proteid bodies of a crystalloidal character.

One of the first phenomena which comes under the notice of the observer is the extraordinary power of motion with which the frustules are endowed. Some species move slowly backwards and forwards in pretty much the same line, but in the case of *Bacillaria paradoxa* the motion is very rapid, the frustules darting through the water in a zigzag course. To account for this motion various theories have been suggested, none of which appear to be altogether satisfactory. There is little doubt that the movements are connected with the raphe, and in some diatoms there is much evidence to prove that they are due to an exudation of mucilage.

Classification.—The most natural system of classification of the Bacillarieae is the one put forward by Schütt (1896), and since generally followed by systematists. He separates them into two primary divisions, the 'Centricae' and the 'Pennatae.' The former includes all those diatoms which in the valve view possess a radial symmetry around a central point, and which are destitute of a raphe (or a pseudoraphe). The latter includes those which are zygomorphic or otherwise irregular, and in which the valve view is generally boat-shaped or needle-shaped, with the markings arranged in a sagittal manner on each side of a raphe or pseudoraphe.

Reproduction.—In the Diatomaceae, as well as in the Desmidiaceae, the ordinary mode of increase is by simple cell-division. The cell-contents within the enclosure of the siliceous case separate into two distinct masses. As these two daughter-masses become more and more developed, the valves of the mother-cell are pushed more and more widely apart. A new siliceous valve is secreted by each of the two masses on the side opposite to the original valve, the new valves being situated within the girdle of the original frustule. When this process has been completed the girdle of the mother frustule gives way, and two distinct frustules are formed, the siliceous valves in each of these new frustules being one of the valves of the mother-cell, and a newly formed valve similar and more or less parallel to it.

During the life of the plant this process of self-division is continued with an almost incredible rapidity. On this subject the observation of Professor William Smith, writing in 1853, is worthy of special notice:—"I have been unable to ascertain the time occupied in a single act of self-division, but supposing it to be completed in twenty-four hours we should have, as the progeny of a single frustule, the amazing number of 1,000,000,000 in a single month, a circumstance which will in some degree explain the sudden, or at least rapid, appearance of these organisms in localities where they were a short time previously either unrecognized or sparingly diffused" (*British Diatomaceae*, vol. i. p. 25).

Individual diatoms when once produced by cell-division are incapable of any increase in size owing to the rigidity of their siliceous cell-walls, and since the new valves are always formed within the girdle of the old ones, it would follow that every succeeding generation is reduced in size by the thickness of the girdle. In some diatoms, however, this is not strictly true as daughter-cells are sometimes produced of larger size than the parent-cells. Thus, the reduction in size of the individuals is not always proportionate to the number of cell-divisions.

On the diminution in size having reached a limit in any species, the maximum size is regained by the formation of an auxospore. There are five

known methods of reproduction by auxospores, but it is unnecessary here to enter into details of these methods. Suffice it to say that a normal auxospore is produced by the conjugation of two parent-cells, its distinguishing feature being a rejuvenescence accompanied by a marked increase in size. These auxospores formed without conjugation are parthenogenetic.

Mode of Preparation.—The Diatomaceae are usually gathered in small bottles, and special care should be taken to collect them as free as possible from extraneous matter. A small portion having been examined under the microscope, should the gathering be thought worthy of preservation, some of the material is boiled in acid for the purpose of cleaning it. The acids usually employed are hydrochloric, nitric or sulphuric, according as circumstances require. When the operator considers that by this process all foreign matter has been eliminated, the residuum is put into a precipitating jar of a conical shape, broader at the bottom than at the top, and covered to the brim with filtered or distilled water. When the diatoms have settled in the bottom of the jar, the supernatant fluid is carefully removed by a syringe or some similar instrument, so that the sediment is not disturbed. The jar is again filled with water, and the process repeated till the acid has been completely removed. It is desirable afterwards to boil the sediment for a short time with supercarbonate of soda, the alkali being removed in the same manner as the acid. A small portion may then be placed with a pipette upon a slip of glass, and, when the moisture has been thoroughly evaporated, the film that remains should be covered with dilute Canada balsam, and, a thin glass cover having been gently laid over the balsam, the preparation should be laid aside for a short time to harden, and then is ready for observation.

General Remarks.—Diatoms are most abundant in cold latitudes, having a general preference for cold water. In the pelagic waters of lakes and of the oceans they are often very abundant, and in the cold waters of the Arctic and Antarctic

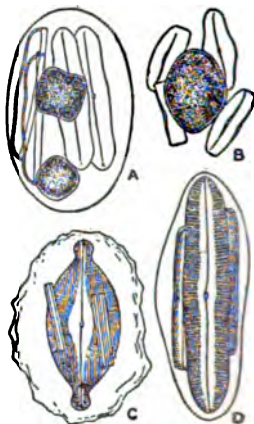

FIG. 6.—Formation of Auxospores.

- A. *Navicula limosa*.
B. *Achnanthes flexella*.
C. *Navicula Amphibiaena*.
D. *Navicula viridis*.

Oceans they exist in prodigious numbers. They thus form a large proportion of both the marine and the fresh-water plankton.

Large numbers of fossil diatoms are known. Not only are these minute plants assisting at the present time in the accumulation of oceanic and lake deposits, but in former ages they have been sufficiently active to give rise to considerable deposits of diatomaceous earths. When the plant has fulfilled its natural course the siliceous covering sinks to the bottom of the water in which it had lived, and there forms part of the sediment. When in the process of ages, as it has often happened, the accumulated sediment has been hardened into solid rock, the siliceous frustules of the diatoms remain unaltered, and, if the rock be disintegrated by natural or artificial means, may be removed from the enveloping matrix and subjected to examination under the microscope. The forms found may from their character help in some degree to illustrate the conditions under which the stratum of rock had been originally deposited. These earths are generally of a white or grey colour. Some of them are hard, but most are soft and friable. Many of them are of economic importance, being used as polishing powders ("Tripoli"), as absorbents for nitroglycerin in the manufacture of dynamite ("Kieselguhr"), as a dentifrice, and more recently they have been used to a large extent in the manufacture of non-conducting and sound-proof materials. Most of these diatomaceous earths are associated with rocks of Tertiary formations, although it is generally regarded that the earliest appearance of diatoms is in the Upper Cretaceous (chalk).

Vast deposits of Diatomaceous earths have been discovered in various parts of the world,—some the deposit of fresh, others of salt water. Of these deposits the most remarkable for extent, as well as for the number and beauty of the species contained in it, is that of Richmond, in Virginia, one of the United States of America. It extends for many miles, and is in some places at least 40 ft. deep. It is a remarkable fact that though the generations of a diatom in the space of a few months far exceed in number the generation of man during the period usually assigned to the existence of the race, the fossil genera and species are in most respects to the most minute details identical with the numerous living representatives of their class.

(E. O'M.; G. S. W.)*

DIAULOS (from Gr. *δι*, double, and *αὔλος*, pipe), in architecture, the peristyle round the great court of the palaestra, described by Vitruvius (v. 11), which measured two stadia (1200 ft.) in length; on the south side this peristyle had two rows of columns, so that in stormy weather the rain might not be driven into the inner part. The word was also used in ancient Greece for a foot-race of twice the usual length.

DIABOLO, FRA (1771–1806), the popular name given to a famous Italian brigand associated with the political revolutions of southern Italy at the time of the French invasion. His real name was Michele Pezza, and he was born of low parentage at Itri; he had committed many murders and robberies in the Terra di Lavoro, but by good luck combined with audacity he always escaped capture, whence his name of Fra Diavolo, popular superstition having invested him with the characters of a monk and a demon, and it seems that at one time he actually was a monk. When the kingdom of Naples was overrun by the French and the Parthenopean Republic established (1799), Cardinal Ruffo, acting on behalf of the Bourbon king Ferdinand IV., who had fled to Sicily, undertook the reconquest of the country, and for this purpose he raised bands of peasants, gail-birds, brigands, &c., under the name of Sanfedisti or *bande della Santa Fede* ("bands of the Holy Faith"). Fra Diavolo was made leader of one of them, and waged untiring war against the French troops, cutting off isolated detachments and murdering stragglers and couriers. Owing to his unrivalled knowledge of the country, he succeeded in interrupting the enemy's communications between Rome and Naples. But although, like his fellow-brigands under Ruffo, he styled himself "the faithful servant and subject of His Sicilian Majesty," wore a military uniform and held military rank, and was even created duke of Cassano, his atrocities were worthy of a bandit chief. On one occasion he threw some of his prisoners,

men, women and children, over a precipice, and on another he had a party of seventy shot. His excesses while at Albano were such that the Neapolitan general Naselli had him arrested and imprisoned in the castle of St Angelo, but he was liberated soon after. When Joseph Bonaparte was made king of Naples, extraordinary tribunals were established to suppress brigandage, and a price was put on Fra Diavolo's head. After spreading terror through Calabria, he crossed over to Sicily, where he concerted further attacks on the French. He returned to the mainland at the head of 200 convicts, and committed further excesses in the Terra di Lavoro; but the French troops were everywhere on the alert to capture him and he had to take refuge in the woods of Lenola. For two months he evaded his pursuers, but at length, hungry and ill, he went in disguise to the village of Baronissi, where he was recognized and arrested, tried by an extraordinary tribunal, condemned to death and shot. In his last moments he cursed both the Bourbons and Admiral Sir Sidney Smith for having induced him to engage in this reckless adventure (1806). Although his cruelty was abominable, he was not altogether without generosity, and by his courage and audacity he acquired a certain romantic popularity. His name has gained a world-wide celebrity as the title of a famous opera by Auber.

The best known account of Fra Diavolo is in Pietro Colletta's *Storia del reame di Napoli* (2nd ed., Florence, 1848); B. Amante's *Fra Diavolo e il suo tempo* (Florence, 1904) is an attempted rehabilitation; but A. Luzio, whose account in *Profilis e bozzetti storici* (Milan, 1906) gives the latest information on the subject, has demolished Amante's arguments. (L. V.)*

DIAZ, NARCISSE VIRGILIO (1808–1876), French painter, was born in Bordeaux of Spanish parents, on the 25th of August 1808. At first a figure-painter who indulged in strong colour, in his later life Diaz became a painter of the forest and a "tone artist" of the first order. He spent much time at Barbizon; and although he is the least exalted of the half-dozen great artists who are usually grouped round that name, he sometimes produced works of the highest quality. At the age of ten Diaz became an orphan, and misfortune dogged his earlier years. His foot was bitten by a reptile in Meudon wood, near Sèvres, where he had been taken to live with some friends of his mother. The bite was badly dressed, and ultimately it cost him his leg. Afterwards his wooden stump became famous. At fifteen he entered the studios at Sèvres, where the decoration of porcelain occupied him; but tiring of the restraint of fixed hours, he took to painting Eastern figures dressed in richly coloured garments. Turks and Oriental scenes attracted him, and many brilliant gems remain of this period. About 1831 Diaz encountered Théodore Rousseau, for whom he entertained a great veneration, although Rousseau was four years his junior; but it was not until ten years later that the remarkable incident took place of Rousseau teaching Diaz to paint trees. At Fontainebleau Diaz found Rousseau painting his wonderful forest pictures, and determined to paint in the same way if possible. Rousseau, then in poor health, worried at home, and embittered against the world, was difficult to approach. Diaz followed him surreptitiously to the forest,—wooden leg not hindering,—and he dodged round after the painter, trying to observe his method of work. After a time Diaz found a way to become friendly with Rousseau, and revealed his anxiety to understand his painting. Rousseau was touched with the passionate words of admiration, and finally taught Diaz all he knew. Diaz exhibited many pictures at the Paris Salon, and was decorated in 1851. During the Franco-German War he went to Brussels. After 1871 he became fashionable, his works gradually rose in the estimation of collectors, and he worked constantly and successfully. In 1876 he caught cold at his son's grave, and on the 18th of November of that year he died at Mentone, whither he had gone to recruit his health. Diaz's finest pictures are his forest scenes and storms, and it is on these, and not on his pretty figures, that his fame is likely to rest. There are several fairly good examples of the master in the Louvre, and three small figure pictures in the Wallace collection, Hertford House. Perhaps the most notable of Diaz's works are "La Fée aux Perles" (1857), in the Louvre; "Sunset in the Forest" (1868); "The Storm,"

and "The Forest of Fontainebleau" (1870) at Leeds. Diaz had no well-known pupils, but Léon Richet followed markedly his methods of tree-painting, and J. F. Millet at one period painted small figures in avowed imitation of Diaz's then popular subjects.

See A. Hustin, *Les Artistes célèbres: Diaz* (Paris); D. Croll Thomson, *The Barbizon School of Painters* (London, 1890); J. W. Mollett, *Diaz* (London, 1890); J. Claretie, *Peintres et sculpteurs contemporains: Diaz* (Paris, 1882); Albert Wolff, *La Capitale de l'art: Narcisse Diaz* (Paris, 1886); Pa. Burty, *Maîtres et disciples: N. Diaz* (Paris, 1877). (D. C. T.)

DIAZ, PORFIRIO (1830-), president of the republic of Mexico (q.v.), was born in the southern state of Oaxaca, on the 15th of September 1830. His father was an innkeeper in the little capital of that province, and died three years after the birth of Porfirio, leaving a family of seven children. The boy, who had Indian blood in his veins, was educated for the Catholic Church, a body having immense influence in the country at that time and ordering and controlling revolutions by the strength of their filled coffers. Arrived at the age of sixteen Porfirio Diaz threw off the authority of the priests. Fired with enthusiasm by stories told by the revolutionary soldiers continually passing through Oaxaca, and hearing about the war with the United States, a year later he determined to set out for Mexico city and join the National Guard. There being no trains, and he being too poor to ride, he walked the greater part of the 250 m., but arrived there too late, as the treaty of Guadalupe-Hidalgo (1848) had been already signed, and Texas finally ceded to the United States. Thus his entering the army was for the time defeated. Thereupon he returned to his native town and began studying law. He took pupils in order to pay his own fees at the Law Institute, and help his mother. At this time he came under the notice and influence of Don Marcos Pérez and Benito Juárez, the first a judge, the second a governor of the state of Oaxaca, and soon to become famous as the deliverer of Mexico from the priesthood (War of Reform). Diaz continued in his native town until 1854, when, refusing to vote for the dictator, Santa Anna, he was stung by a taunt of cowardice, and hastily pushing his way to the voting place, he recorded his vote in favour of Alvarez and the revolutionists. Orders were given for his arrest, but seizing a rifle and mounting a horse he placed himself at the head of a few revolting peasants, and from that moment became one of the leading spirits in that long struggle for reform, known as the War of Reform, which, under the leadership of Juárez, followed the overthrow of Santa Anna. Promotion succeeded promotion, as Diaz led his troops from victory to victory, amid great privations and difficulties. He was made captain (1856), lieutenant-colonel and colonel (1859), brigadier-general (1861), and general of division for the army (1863). Closely following on civil war, political strife, open rebellion and the great War of Reform, came the French invasion of 1862, and the landing of the emperor Maximilian in 1864. From the moment the French disclosed their intentions of settling in Mexico in 1862, Diaz took a prominent part against the foreign invasion. He was twice seriously wounded, imprisoned on three different occasions, had two hairbreadth escapes, and took part in many daring engagements. So important a personage did he become that both Marshal Bazaine and the emperor Maximilian made overtures to him. At the time of Maximilian's death (with which Diaz personally had nothing to do) he was carrying on the siege of Mexico city, which ended in the surrender of the town two days after the emperor was shot at Querétaro between his two leading generals. Diaz at once set to work to pay up arrears due to his soldiers, proclaimed death as the penalty of plunder and theft, and in the few weeks that followed showed his great administrative powers, the officers as well as the rank and file receiving arrears of pay. On the very day that he occupied Mexico city, the great commander of the army of the east, to everyone's surprise, sent in his resignation. He was, indeed, appointed to the command of the second division of the army by President Juárez in his military reorganization, but Diaz, seeing men who had given great and loyal service to the state dismissed from their positions in the government, and disgusted at this course, retired to the little city of Oaxaca; there he lived, helping

in the reorganization of the army but taking no active part in the government until 1871.

On Juárez' death Lerdo succeeded as president, in 1872. His term of office again brought discord, and when it was known that he was attempting to be re-elected in 1876, the storm broke. Diaz came from retirement, took up the leadership against Lerdo, and after desperate struggles and a daring escape finally made a triumphal entry into Mexico city on the 24th of November 1876, as provisional president, quickly followed by the full presidency. His term of office marks a prominent change in the history of Mexico; from that date he at once forged ahead with financial and political reform, the scrupulous settlement of all national debts, the welding together of the peoples and tribes (there are 150 different Indian tribes) of his country, the establishment of railroads and telegraphs, and all this in a land which had been upheaved for a century with revolutions and bloodshed, and which had had fifty-two dictators, presidents and rulers in fifty-nine years. In 1880 Diaz was succeeded by Gonzalez, the former minister of war, for four years (owing to the limit of the presidential office), but in 1884 he was unanimously re-elected. The government having set aside the above-mentioned limitation, Diaz was continually re-elected to the presidency. He married twice and had a son and two daughters. His gifted second wife (Carmelita), very popular in Mexico, was many years younger than himself. King Edward VII. made him an honorary grand commander of the Bath in June 1906, in recognition of his wonderful administration as perpetual president for over a quarter of a century.

See also Mrs Alec Tweedie, *Porfirio Diaz, Seven Times President of Mexico* (1906), and *Mexico as I saw it* (1901); Dr Noll, *From Empire to Republic* (1890); Lieut. Seaton Schroeder, *Fall of Maximilian's Empire* (New York, 1887); R. de Z. Enriquez, *P. Diaz* (1908); and an article by Percy Martin in *Quarterly Review* for October 1909. (E. A. T.)

DIAZ DE NOVAES, BARTHOLOMEU (fl. 1482-1500), Portuguese explorer, discoverer of the Cape of Good Hope, was probably a kinsman of João Diaz, one of the first Portuguese to round Cape Bojador (1434), and of Diniz Diaz, the discoverer of Cape Verde (1445). In 1478 a Bartholomeu Diaz, probably identical with the discoverer, was exempted from certain customary payments on ivory brought from the Guinea coast. In 1481 he commanded one of the vessels sent by King John II. under Diogo d'Azambuja to the Gold Coast. In 1486 he seems to have been a cavalier of the king's household, and superintendent of the royal warehouses; on the 10th of October in this year he received an annuity of 6000 reis from King John for "services to come"; and some time after this (probably about July or August 1487, rather than July 1486, the traditional date) he left Lisbon with three ships to carry on the work of African exploration so greatly advanced by Diogo Cão (1482-1486). Passing Cão's farthest point near Cape Cross (in the modern German South-west Africa and) in 21° 50' S., he erected a pillar on what is now known as Diaz Point, south of Angra Pequena or Lüderitz Bay, in 26° 38' S.; of this fragments still exist. From this point (according to De Barros) Diaz ran thirteen days southwards before strong winds, which freshened to dangerous stormy weather, in a comparatively high southern latitude, considerably south of the Cape. When the storm subsided the Portuguese stood east; and failing, after several days' search, to find land, turned north, and so struck the south coast of Cape Colony at Mossel Bay (Diaz' Bahia dos Vaqueiros), half way between the Cape of Good Hope and Port Elizabeth (February 3, 1488). Thence they coasted eastward, passing Algoa Bay (Diaz' Bahia da Roca), erecting pillars (or perhaps wooden crosses), it is said, on one of the islands in this bay and at or near Cape Padrone farther east; of these no traces remain. The officers and men now began to insist on return, and Diaz could only persuade them to go as far as the estuary of the Great Fish River (Diaz' Rio do Ifante, so named from his colleague, Captain João Ifante). Here, however, half way between Port Elizabeth and East London (and indeed from Cape Padrone), the north-easterly trend of the coast became unmistakable: the way round Africa had been laid open. On his return Diaz perhaps named Cape Agulhas after St Brandon.

while on the southernmost projection of the modern Cape peninsula, whose remarkable highlands (Table Mountain, &c.) doubtless impressed him as the practical termination of the continent, he bestowed, says De Barros, the name of Cape of Storms (*Cabo Tormentoso*) in memory of the storms he had experienced in these far southern waters; this name (in the ordinary tradition) was changed by King John to that of Good Hope (*Cabo da Boa Esperança*). Some excellent authorities, however, make Diaz himself give the Cape its present name. Hard by this "so many ages unknown promontory" the explorer probably erected his last pillar. After touching at the Ilha do Principe (Prince's Island, south-west of the Cameroons) as well as at the Gold Coast, he appeared at Lisbon in December 1488. He had discovered 1260 m. of hitherto unknown coast; and his voyage, taken with the letters soon afterwards received from Pero de Covilhão (who by way of Cairo and Aden had reached Malabar on one side and the "Zanzibar coast" on the other as far south as Sofala, in 1487-1488) was rightly considered to have solved the question of an ocean route round Africa to the Indies and other lands of South and East Asia.

No record has yet been found of any adequate reward for Diaz; on the contrary, when the great Indian expedition was being prepared (for Vasco da Gama's future leadership) Bartolomeu only superintending the building and outfit of the ships; when the fleet sailed in 1497, he only accompanied da Gama to the Cape Verde Islands, and after this was ordered to El Mina on the Gold Coast. On Cabral's voyage of 1500 he was indeed permitted to take part in the discovery of Brazil (April 22), and thence should have helped to guide the fleet to India; but he perished in a great storm off his own Cabo Tormentoso. Like Moses, as Gilvazo says, he was allowed to see the Promised Land, but not to enter in.

See João de Barros, *Asia*, Dec. I. bk. iii. ch. 4.; Duarte Pacheco Pereira, *Esmeraldo de sive orbis*, esp. p. 15, 90, 92, 94 and Raphael Baxos's introduction to the edition of 1892 (Pacheco met Diaz, returning from his great voyage, at the Ilha do Principe); a marginal note, probably by Christopher Columbus himself, on fol. 13 of a copy of Pierre d'Ally's *Imago mundi*, now in the Colombina at Seville (the writer of this note fixes Diaz's return to Lisbon, December 1488, and says he was present at Diaz's interview with the king of Portugal, when the explorer described his voyage and showed his route upon the chart he had kept); a similar but briefer note in a copy of Pope Sixtus II.'s *Historia rerum ubique gestarum*, from the same hand; the *Rescue of Vasco da Gama's First Voyage (Journal of the First Voyage of ... De Gama)*, Hakluyt Soc., ed. E. G. Ravenstein (1898), pp. 9, 11; Ramusio, *Navigazioni* (3rd ed.), vol. i. fol. 124; Castanheda, *Historia*, bk. i. ch. 1; Galvano, *Descobrimentos (Discoveries of the World)*, Hakluyt Soc. (1862), p. 77; E. G. Ravenstein, "Voyages of ... Diaz," in *Geog. Journ.* (London, December 1900), vol. vii. pp. 648-653, an excellent critical summary in the light of the most recent investigations of all the material. The fragments of Diaz's *Journal*, remaining pillar (from Diaz Point) are now partly at the Cape Museum, partly at Lisbon: the latter are photographed in Ravenstein's paper in *Geog. Journ.* (December 1900, p. 642). (C. R. B.)

DIAZO COMPOUNDS, in organic chemistry, compounds of the type $R-N_2-X$ (where $R =$ a hydrocarbon radical, and $X =$ an acid radical or a hydroxyl group). These compounds may be divided into two classes, namely, the true diazo compounds, characterized by the grouping $-N=N-$, and the diazonium compounds, characterized by the grouping $N.N <$.

The diazonium compounds were first discovered by P. Griess (*Ann.*, 1858, 106, pp. 123 et seq.), and may be prepared by the action of nitrous fumes on a well-cooled solution of a salt of a primary amine,



or as is more usually the case (since the diazonium salts themselves are generally used only in aqueous solution) by the addition of a well-cooled solution of potassium or sodium nitrite to a well-cooled dilute acid solution of the primary amine. In order to isolate the anhydrous diazonium salts, the method of E. Knoevenagel (*Ber.*, 1890, 23, p. 2094) may be employed. In this process the amine salt is dissolved in absolute alcohol and diazotized by the addition of amyl nitrite; a crystalline precipitate of the diazonium salt is formed on standing, or on the addition of a small quantity of ether. The diazonium salts are also formed by the action of zinc-dust and acids on the nitrates

of primary amines (R. Mohlau, *Ber.*, 1883, 16, p. 3080), and by the action of hydroxylamine on nitrosobenzenes. They are colourless crystalline solids which turn brown on exposure. They dissolve easily in water, but only to a slight extent in alcohol and ether. They are very unstable, exploding violently when heated or rubbed. *Benzene diazonium nitrate*, $C_6H_5N_2(NO_3)$, crystallizes in long silky needles. The sulphate and chloride are similar, but they are not quite so unstable as the nitrate. The bromide may be prepared by the addition of bromine to an ethereal solution of diazo-amino-benzene (tribromaniline remaining in solution). By the addition of potassium bromide and bromine water to diazonium salts they are converted into a *perbromide*, e.g. $C_6H_5N_2Br_3$, which crystallizes in yellow plates.

The diazonium salts are characterized by their great reactivity and consequently are important reagents in synthetic processes, since by their agency the amino group in a primary amine may be exchanged for other elements or radicals. The chief reactions are as follows:—

1. *Replacement of $-NH_2$ by $-OH$* .—The amine is diazotized and the aqueous solution of the diazonium salt is heated, nitrogen being eliminated and a phenol formed.

2. *Replacement of $-NH_2$ by halogens and by the $-CN$ and $-CNO$ groups*.—The diazonium salt is warmed with an acid solution of the corresponding cuprous salt (T. Sandmeyer, *Ber.*, 1884, 17, p. 2650), or with copper powder (L. Gattermann, *Ber.*, 1890, 23, p. 1218; 1892, 25, p. 1074). In the case of iodine, the substitution is effected by adding a warm solution of potassium iodide to the diazonium solution, no copper or cuprous salt being necessary; whilst for the production of nitriles a solution of potassium cuprous cyanide is used. This reaction (the so-called "Sandmeyer" reaction) has been investigated by A. Hantzsch and J. W. Blagden (*Ber.*, 1900, 33, p. 2544), who consider that three simultaneous reactions occur, namely, the formation of labile double salts which decompose in such a fashion that the radical attached to the copper atom wanders to the aromatic nucleus; a catalytic action, in which nitrogen is eliminated and the acid radical attaches itself to the aromatic nucleus; and finally, the formation of azo compounds.

3. *Replacement of $-NH_2$ by $-NO_2$* .—A well-cooled concentrated solution of potassium mercuric nitrate is added to a cooled solution of benzene diazonium nitrate, when the crystalline salt $2C_6H_5N_2 \cdot NO_3 \cdot Hg(NO_3)_2$ is precipitated. On warming this with copper powder, it gives a quantitative yield of nitrobenzene (A. Hantzsch, *Ber.*, 1900, 33, p. 2551).

4. *Replacement of $-NH_2$ by hydrogens*.—This exchange is brought about, in some cases, by boiling the diazonium salt with alcohol; but I. Remsen and his pupils (*Amer. Chem. Journ.*, 1888, 9, pp. 389 et seq.) have shown that the main product of this reaction is usually a phenolic ether. This reaction has also been investigated by A. Hantzsch and E. Jochem (*Ber.*, 1901, 34, p. 3337), who arrived at the conclusion that the normal decomposition of diazonium salts by alcohols results in the formation of phenolic ethers, but that an increase in the molecular weight of the alcohol, or the accumulation of negative groups in the aromatic nucleus, diminishes the yield of the ether and increases the amount of the hydrocarbon formed. The replacement is more readily brought about by the use of sodium stannite (P. Friedlander, *Ber.*, 1889, 22, p. 587), or by the use of a concentrated solution of hypophosphorous acid (J. Mai, *Ber.*, 1902, 35, p. 162). A. Hantzsch (*Ber.*, 1896, 29, p. 947; 1898, 31, p. 1253) has shown that the chlor- and brom-diazoniumthiocyanates, when dissolved in alcohol containing a trace of hydrochloric acid, become converted into the isomeric thiocyanbenzene diazonium chlorides and bromides. This change only occurs when the halogen atom is in the ortho- or para- position to the $-N_2$ group.

Metallic Diazo Derivatives.—Benzene diazonium chloride is decomposed by silver oxide in aqueous solution with the formation of *benzene diazonium hydroxide*, $C_6H_5N_2(OH)$. This hydroxide, although possessing powerful basic properties, is unstable in the presence of alkalis and neutralizes them, being converted first into the isomeric benzene-diazotie acid, the potassium salt of which is obtained when the diazonium chloride is added to an excess of cold concentrated potash (A. Hantzsch and W. B. Davidson, *Ber.*, 1898, 31, p. 1612). *Potassium benzene diazotate*, $C_6H_5N_2 \cdot OK$, crystallizes in colourless silky needles. The free acid is not known; by the addition of the potassium salt to 50% acetic acid at $-20^\circ C$., the acid anhydride, *benzene diazo oxide*, $(C_6H_5N_2)_2O$, is obtained as a very unstable, yellow, insoluble compound, exploding spontaneously at $0^\circ C$. Strong acids convert it into a diazonium salt, and potash converts it into the diazotate. On the constitution, of these anhydrides see E. Bamberger, *Ber.*, 1896, 29, p. 446, and A. Hantzsch, *Ber.*, 1896, 29, p. 1067; 1898, 31, p. 636. By the addition of the diazonium salts to a hot concentrated solution of a caustic alkali, C. Schraube and C. Schmidt (*Ber.*, 1894, 27, p. 520) obtained an isomer of potassium benzene diazotate. These *iso-diazotates* are formed much more readily when the aromatic nucleus in the diazonium salt contains negative radicals. *Potassium benzene iso-diazotate* resembles the normal salt, but is more stable, and is more highly ionized. Carbon dioxide converts it into *phenyl nitrosamine*, $C_6H_5NH \cdot NO$

(A. Hantzsch). The potassium salt of the iso-diazo hydroxide yields on methylation a nitrogen ether, $R \cdot N(CH_3) \cdot NO$, whilst the silver salt yields an oxygen ether, $R \cdot N \cdot OCH_3$. These results point to the conclusion that the iso-diazo hydroxide is a tautomeric substance. The same oxygen ether is formed by the methylation of the silver salt of the normal diazo hydroxide; this points to the conclusion that the isomeric hydroxides, corresponding with the silver derivatives, have the same structural formulae, namely, $R \cdot N \cdot N \cdot OH$. These oxygen ethers contain the grouping $-N \cdot N-$, since they couple very readily with the phenols in alkaline solution to form azo compounds (q.v.) (E. Bamberger, *Ber.*, 1895, 28, p. 225); they are also explosive.

By oxidizing potassium benzene iso-diazoate with alkaline potassium ferricyanide, E. Bamberger (*Ber.*, 1894, 27, p. 914) obtained the diazoic acids, $R \cdot NH \cdot NO_2$, substances which he had previously prepared by similarly oxidizing the diazonium salts, by dehydrating the nitrates of primary amines with acetic anhydride, and by the action of nitric anhydride on the primary amines. Concentrated acids convert them into the isomeric nitro-amines, the $-NO_2$ group going into the nucleus in the ortho- or para- position to the amine nitrogen; this appears to indicate that the compounds are nitramines. They behave, however, as tautomeric substances, since their alkali salts on methylation give nitrogen ethers, whilst their silver salts yield oxygen ethers:

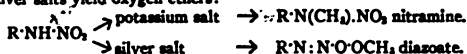

Phenyl nitramine, $C_6H_5NH \cdot NO_2$, is a colourless crystalline solid, which melts at $46^\circ C$. Sodium amalgam in alkaline solution reduces it to phenylhydrazine.

Constitution of the Diazo Compounds.—F. Griess (*Ann.*, 1866, 137, p. 39) considered that the diazo compounds were formed by the addition of complex groupings of the type $C_2H_2N_2$ to the inorganic acids; whilst A. Kekulé (*Zeit. f. Chem.*, 1866, 2, p. 308), on account of their ready condensation to form azo compounds and their easy reduction to hydrazines, assumed that they were substances of the type $R \cdot N \cdot N \cdot Cl$. The constitution of the diazonium group— $N_2^+X^-$, may be inferred from the following facts:—The group $C_6H_5N_2$ behaves in many respects similarly to an alkali metal, and even more so to the ammonium group, since it is capable of forming colourless neutral salts with mineral acids, which in dilute aqueous solution are strongly ionized, but do not show any trace of hydrolytic dissociation (A. Hantzsch, *Ber.*, 1895, 28, p. 1734). Again, the diazonium chlorides combine with platinum as such as $(C_6H_5N_2Cl)_2PtCl_2$, similar gold salts, $C_6H_5N_2Cl \cdot AuCl_3$, are known. Determinations of the electrical conductivity of the diazonium chloride and nitrate also show that the diazonium radical is strictly comparable with other quaternary ammonium ions. For these reasons, one must assume the existence of pentavalent nitrogen in the diazonium salts, in order to account for their basic properties.

The constitution of the isomeric diazo hydroxides has given rise to much discussion. E. Bamberger (*Ber.*, 1895, 28, pp. 444 et seq.) and C. W. Blomstrand (*Ann. prakt. Chem.*, 1896, 53, pp. 169 et seq.) hold that the compounds are structurally different, the normal diazo hydroxide being a diazonium derivative of the type $R \cdot N(N) \cdot OH$. The recent work of A. Hantzsch and his pupils seems to invalidate this view (*Ber.*, 1894, 27, pp. 1702 et seq.; see also A. Hantzsch, *Die Diazoverbindungen*). According to Hantzsch the isomeric diazo hydroxides are structurally identical, and the differences in behaviour are due to stereo-chemical relations, the isomerism being comparable with that of the oximes (q.v.). On such a hypothesis, the relatively unstable normal diazo hydroxides would be the *syn*-compounds, since here the nitrogen atoms would be more easily eliminated, whilst the stable iso-diazo derivatives would be the *anti*-compounds, thus:

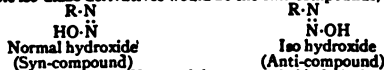

In support of this theory, Hantzsch has succeeded in isolating a series of *syn*- and *anti*-diazo-cyanides and -sulphonates (*Ber.*, 1895, 28, p. 656; 1900, 33, p. 2161; 1901, 34, p. 4166). By diazotizing para-chloroaniline and adding a cold solution of potassium cyanide, a salt (melting at $29^\circ C$) is obtained, which readily loses nitrogen, and forms para-chlorobenzonitrile on the addition of copper powder. By dissolving this diazo-cyanide in alcohol and reprecipitating it by water, it is converted into the isomeric diazo-cyanide (melting at $105-106^\circ C$), which does not yield para-chlorobenzonitrile when treated with copper powder. Similar results have been obtained by using diazotized para-aniline, a *syn*- and an *anti*-compound being formed, as well as a third isomeric cyanide, obtained by evaporating para-methoxybenzenediazonium hydroxide in the presence of an excess of hydrocyanic acid at ordinary temperatures. This salt is a colourless crystalline substance of composition $CH_3O \cdot C_6H_4 \cdot N_2 \cdot CN \cdot HCN \cdot 2H_2O$, and has the properties of a metallic salt; it is very soluble in water and its solution is an electrolyte, whereas the solutions of the *syn*- and *anti*-compounds are not electrolytes. The isolation of these compounds is a powerful argument in favour of the Hantzsch hypothesis which requires the existence of these three different types, whilst the Bamberger-Blomstrand view only accounts for the forma-

tion of two isomeric cyanides, namely, one of the normal diazonium type and one of the iso-diazo-cyanide type.

Benzene diazonium hydroxide, although a strong base, reacts with the alkaline hydroxides to form salts with the evolution of heat, and generally behaves as a weak acid. On mixing dilute solutions of the diazonium hydroxide and the alkali together, it is found that the molecular conductivity of the mixture is much less than the sum of the two electrical conductivities of the solutions separately, from which it follows that a portion of the ions present have changed to the non-ionized condition. This behaviour is explained by considering the non-ionized part of the diazonium hydroxide to exist in solution in a hydrated form, the equation of equilibrium being:

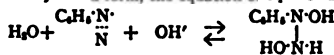

On adding the alkaline hydroxide to the solution, this hydrate is supposed to lose water, yielding the *syn*-diazo hydroxide, which then gives rise to a certain amount of the sodium salt (A. Hantzsch, *Ber.*, 1898, 31, p. 1612).

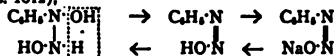

This assumption also shows the relationship of the diazonium hydroxides to other quaternary ammonium compounds, for most of the quaternary ammonium hydroxides (except such as have the nitrogen atom attached to four saturated hydrocarbon radicals) are unstable, and readily pass over into compounds in which the hydroxyl group is no longer attached to the amine nitrogen; thus the *syn*-diazo hydroxides are to be regarded as pseudo-diazonium derivatives. (A. Hantzsch, *Ber.*, 1899, 32, p. 3109; 1900, 33, p. 278.) It is generally accepted that the iso-diazo hydroxides possess the oxime structure $R \cdot N \cdot N \cdot OH$.

Hantzsch explains the characteristic reactions of the diazonium compounds by the assumption that an addition compound is first formed, which breaks down with the elimination of the hydride of the acid radical, and the formation of an unstable *syn*-diazo compound, which, in its turn, decomposes with evolution of nitrogen (*Ber.*, 1897, 30, p. 2548; 1898, 31, p. 2053).

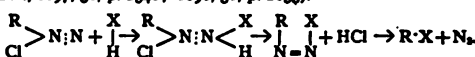

J. Cain (*Jour. Chem. Soc.*, 1907, 91, p. 1049) suggested a quinonoid formula for diazonium salt, which has been combated by Hantzsch (*Ber.*, 1908, 41, pp. 3532 et seq.). G. T. Morgan and F. M. G. Micklethwait (*Jour. Chem. Soc.*, 1908, 93, p. 617; 1909, 95, p. 1319) have pointed out that the salts may possess a dynamic formula, Cain's representing the middle stage, thus:

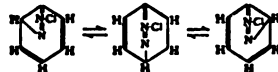

Diazoamines.—The diazoamines, $R \cdot N_2 \cdot NHR$, may be prepared by the action of the primary and secondary amines on the diazonium salts, or by the action of nitrous acid on the free primary amine. In the latter reaction it is assumed that the isodiazohydroxide first formed is immediately attacked by a second molecule of the amine. They are yellow crystalline solids, which do not unite with acids. Nitrous acid converts them, in acid solution, into diazonium salts.



They are readily converted into the isomeric aminazo compounds, either by standing in alcoholic solution, or by warming with a mixture of the parent base and its hydrochloride; the diazo group preferably going into the para-position to the amine group. When the para-position is occupied, the diazo group takes the ortho-position. H. Goldschmidt and R. U. Reinders (*Ber.*, 1896, 29, p. 1369, 1899) have shown that the transformation is a monomolecular reaction, the velocity of transformation in moderately dilute solution being independent of the concentration, but proportional to the amount of the catalyst present (amine hydrochloride) and to the temperature. It has also been shown that when different salts of the amine are used, their catalytic influence varies in amount and is almost proportional to their degree of ionization in aqueous solution. Diazoaminobenzene, $C_6H_5N_2 \cdot NH \cdot C_6H_5$, crystallizes in golden yellow laminae, which melt at $96^\circ C$ and explode at a slightly higher temperature. It is readily soluble in alcohol, ether and benzene. Concentrated hydrochloric acid converts it into chlorobenzene, aniline and nitrogen. Zinc dust and alcoholic acetic acid reduce it to aniline and phenylhydrazine.

Diazoimino compounds. $R \cdot N_2$ may be regarded as derivatives of azoimide (q.v.); they are formed by the action of ammonia on the diazo-perbromides, or by the action of hydroxylamine on the diazonium sulphates (J. Mai, *Ber.*, 1892, 25, p. 372; T. Curtius, *Ber.*, 1893, 26, p. 1271). Diazoazobenzene, $C_6H_5N_2$, is a yellowish oil of a pungent odour. It boils at $59^\circ C$ (12 mm.), and explodes when heated. Concentrated hydrochloric acid decomposes it with formation of

diazamines and elimination of nitrogen, whilst on boiling with sulphuric acid it is converted into aminophenol.

Aliphatic Diazo Compounds.—The esters of the aliphatic aromatic acids may be diazotized in a manner similar to the primary aromatic amines, a fact discovered by T. Curtius (*Ber.*, 1833, 16, p. 239). The first aliphatic diazo compound to be isolated was *diazooacetic ester*, $\text{CH}_3\text{N}_2\text{CO}_2\text{C}_2\text{H}_5$, which is prepared by the action of potassium nitrite on the ethyl ester of glycolyl hydrochloride, $\text{HCl}\cdot\text{N}(\text{CH}_2)_2\text{CO}_2\text{C}_2\text{H}_5 + \text{KNO}_2 = \text{CHN}_2\text{CO}_2\text{C}_2\text{H}_5 + \text{KCl} + 2\text{H}_2\text{O}$. It is a yellowish oil which melts at -24°C .; it boils at $143\text{--}144^\circ\text{C}$.; but cannot be distilled safely as it decomposes violently, giving nitrogen and ethyl fumarate. It explodes in contact with concentrated sulphuric acid. On reduction it yields ammonia and glycolyl (aminoacetic acid). When heated with water it forms ethyl hydroxy-acetate; with alcohol it yields ethyl ethoxyacetate. Halogen acids convert it into monohalogen fatty acids, and the halogens themselves convert it into dihalogen fatty acids. It unites with aldehydes to form esters of ketonic acids, and with aniline yields anilido-acetic acid. It forms an addition product with acrylic ester, which on heating loses nitrogen and leaves trimethylene dicarboxylic ester. Concentrated ammonia converts it into *diazooacetamide*, $\text{CHN}_2\text{CONH}_2$, which crystallizes in golden yellow plates which melt at 114°C . For other reactions see HYDRAZINE. The constitution of the diazo fatty esters is inferred from the fact that the two nitrogen atoms, when split off, are replaced by two monovalent elements or groups, thus leading to the formula $\text{N} \begin{array}{c} \diagup \\ \diagdown \end{array} > \text{CH}\cdot\text{CO}_2\text{C}_2\text{H}_5$, for diazoacetic ester.

Diazooacetic ester, $\text{N}_2\text{C}(\text{CO}_2\text{C}_2\text{H}_5)_2$, is similarly prepared by the action of nitrous acid on the hydrochloride of aspartic ester. It is decomposed by boiling water and yields fumaric ester.

Diazomethane, CH_2N_2 , was first obtained in 1894 by H. v. Pechmann (*Ber.*, 1894, 27, p. 1888; 1895, 28, p. 855). It is prepared by the action of aqueous or alcoholic solutions of the caustic alkalis on the nitroso-acidyl derivatives of methylamine (such, for example, as *nitrosomethyl pyruvate*, $\text{NO}\cdot\text{N}(\text{CH}_3)\cdot\text{CO}_2\text{C}_2\text{H}_5$, which is formed on passing nitrous fumes into an ethereal solution of methyl urethane). E. Bamberger (*Ber.*, 1895, 28, p. 1682) regards it as the anhydride of *iso-diazomethane*, $\text{CH}_2\text{N}_2\text{N}\cdot\text{OH}$, and has prepared it by a method similar to that used for the preparation of *iso-diazobenzene*. By the action of bleaching powder on methylamine hydrochloride, there is obtained a volatile liquid (*methylchloramine*, $\text{CH}_2\text{N}\cdot\text{Cl}$), boiling at $55\text{--}60^\circ\text{C}$.; which explodes violently when heated with water, yielding hydrocyanic acid ($\text{CH}_2\text{NCl}_2 = \text{HCN} + 2\text{HCl}$). Well-dried hydroxylamine hydrochloride is dissolved in methyl alcohol and mixed with sodium methylate; a solution of methylchloramine in absolute ether is then added and an ethereal solution of diazomethane distils over. Diazomethane is a yellow inodorous gas, very poisonous and corrosive. It may be condensed to a liquid, which boils at about 0°C . It is a powerful methylating agent, reacting with water to form methyl alcohol, and converting acetic acid into methylacetate, hydrochloric acid into methyl chloride, hydrocyanic acid into acetonitrile, and phenol into anisol, nitrogen being eliminated in each case. It is reduced by sodium amalgam (in alcoholic solution) to *methylpyridazine*, $\text{C}_4\text{H}_7\text{NH}\cdot\text{NH}_2$. It unites directly with acetylene to form pyrazole (H. v. Pechmann, *Ber.*, 1898, 31, p. 2950) and with fumaric methyl ester to form pyrazolic dicarboxylic ester (F. v. P. 9).

See G. T. Morgan, *B.A. Rep.*, 1902; J. Cain, *Diazo Compounds*, 1908.

DIAZOMATA (Gr. *δίαζωμα*, a girdle), in architecture, the leading places and passages which were carried round the semicircle and separated the upper and lower tiers in a Greek theatre.

DIBDIN, CHARLES (1745–1814), British musician, dramatist, novelist, actor and song-writer, the son of a parish clerk, was born at Southampton on or before the 4th of March 1745, and was the youngest of a family of eighteen. His parents designing him for the church, he was sent to Winchester; but his love of music early diverted his thoughts from the clerical profession. After receiving some instruction from the organist of Winchester cathedral, where he was a chorister from 1756 to 1759, he went to London at the age of fifteen. Here he was placed in a music warehouse in Cheapside, but he soon abandoned this employment to become a singing actor at Covent Garden. On the 21st of May 1752 his first work, an operetta entitled *The Shepherd's Artifice*, with words and music by himself, was produced at this theatre. Other works followed, his reputation being firmly established by the comic to the play of *The Padlock*, produced at Drury Lane under Garrick's management in 1768, the composer himself taking the part of Mungo with conspicuous success. He continued for some years to be connected with Drury Lane, both as composer and as actor, and produced during this period two of his best known works, *The Waterman* (1774) and *The Quaker* (1775). A quarrel with Garrick led to the termination of his engagement. In *The Comic Mirror* he ridiculed prominent contemporary figures through the medium of a puppet show. In 1782 he became joint

manager of the Royal circus, afterwards known as the Surrey theatre. In three years he lost this position owing to a quarrel with his partner. His opera *Liberty Hall*, containing the successful songs "Jock Ratlin," "The Highmettled Racer," and "The Bells of Aberdovey," was produced at Drury Lane theatre on the 8th of February 1785. In 1788 he sailed for the East Indies, but the vessel having put in to Torbay in stress of weather, he changed his mind and returned to London. In a musical variety entertainment called *The Oddities*, he succeeded in winning marked popularity with a number of songs that included "Twas in the good ship 'Rover,'" "Saturday Night at Sea," "I sailed from the Downs in the 'Nancy,'" and the immortal "Tom Bowling," written on the death of his eldest brother, Captain Thomas Dibdin, at whose invitation he had planned his visit to India. A series of monodramatic entertainments which he gave at his theatre, Sans Souci, in Leicester Square, brought his songs, music and recitations more prominently into notice, and permanently established his fame as a lyric poet. It was at these entertainments that he first introduced many of those sea-songs which so powerfully influenced the national spirit. The words breathe the simple loyalty and dauntless courage that are the cardinal virtues of the British sailor, and the music was appropriate and naturally melodious. Their effect in stimulating and ennobling the spirit of the navy during the war with France was so marked as to call for special acknowledgment. In 1803 Dibdin was rewarded by government with a pension of £200 a year, of which he was only for a time deprived under the administration of Lord Grenville. During this period he opened a music shop in the Strand, but the venture was a failure. Dibdin died of paralysis in London on the 25th of July 1814. Besides his *Musical Tour through England* (1788), his *Professional Life*, an autobiography published in 1803, a *History of the Stage* (1795), and several smaller works, he wrote upwards of 1400 songs and about thirty dramatic pieces. He also wrote the following novels:—*The Devil* (1785); *Hannah Hewitt* (1792); *The Younger Brother* (1793). An edition of his songs by G. Hogarth (1843) contains a memoir of his life. His two sons, Charles and Thomas John Dibdin (*q.v.*), whose works are often confused with those of their father, were also popular dramatists in their day.

DIBDIN, THOMAS FROGNALL (1776–1847), English bibliographer, born at Calcutta in 1776, was the son of Thomas Dibdin, the sailor brother of Charles Dibdin. His father and mother both died on the way home to England in 1780, and Thomas was brought up by a maternal uncle. He was educated at St John's College, Oxford, and studied for a time at Lincoln's Inn. After an unsuccessful attempt to obtain practice as a provincial counsel at Worcester, he was ordained a clergyman at the close of 1804, being appointed to a curacy at Kensington. It was not until 1823 that he received the living of Exning in Sussex. Soon afterwards he was appointed by Lord Liverpool to the rectory of St Mary's, Bryanston Square, which he held until his death on the 18th of November 1847. The first of his numerous bibliographical works was his *Introduction to the Knowledge of Editions of the Classics* (1802), which brought him under the notice of the third Earl Spencer, to whom he owed much important aid in his bibliographical pursuits. The rich library at Althorp was thrown open to him; he spent much of his time in it, and in 1814–1815 published his *Bibliotheca Spenceriana*. As the library was not open to the general public, the information given in the *Bibliotheca* was found very useful, but since its author was unable even to read the characters in which the books he described were written, the work was marred by the errors which more or less characterize all his productions. This fault of inaccuracy however was less obtrusive in his series of playful, discursive works in the form of dialogues on his favourite subject, the first of which, *Bibliomania* (1809), was republished with large additions in 1811, and was very popular, passing through numerous editions. To the same class belonged the *Bibliographical Decameron*, a larger work, which appeared in 1817. In 1810 he began the publication of a new and much extended edition of Ames's *Typographical Antiquities*. The first volume was a great success, but the publication was checked by the failure of the fourth volume, and was

never completed. In 1818 Dibdin was commissioned by Earl Spencer to purchase books for him on the continent, an expedition described in his sumptuous *Bibliographical, Antiquarian and Pictorial Tour in France and Germany* (1821). In 1824 he made an ambitious venture in his *Library Companion, or the Young Man's Guide and Old Man's Comfort in the Choice of a Library*, intended to point out the best works in all departments of literature. His culture was not broad enough, however, to render him competent for the task, and the work was severely criticized. For some years Dibdin gave himself up chiefly to religious literature. He returned to bibliography in his *Bibliophobia, or Remarks on the Present Depression in the State of Literature and the Book Trade* (1832), and the same subject furnishes the main interest of his *Reminiscences of a Literary Life* (1836), and his *Bibliographical, Antiquarian and Pictorial Tour in the Northern Counties of England and Scotland* (1838). Dibdin was the originator and vice-president, Lord Spencer being the president, of the Roxburgh Club, founded in 1812,—the first of the numerous book clubs which have done such service to literature.

DIBDIN, THOMAS JOHN (1771-1841), English dramatist and song-writer, son of Charles Dibdin, the song-writer, and of Mrs Davenet, an actress whose real name was Harriet Pitt, was born on the 21st of March 1771. He was apprenticed to his maternal uncle, a London upholsterer, and later to William Rawlins, afterwards sheriff of London. He summoned his second master unsuccessfully for rough treatment; and after a few years of service he ran away to join a company of country players. From 1789 to 1795 he played in all sorts of parts; he acted as scene painter at Liverpool in 1791; and during this period he composed more than 1000 songs. He made his first attempt as a dramatic writer in *Something New*, followed by *The Mad Guardian* in 1795. He returned to London in 1795, having married two years before; and in the winter of 1798-1799 his *Jew and the Doctor* was produced at Covent Garden. From this time he contributed a very large number of comedies, operas, farces, &c., to the public entertainment. Some of these brought immense popularity to the writer and immense profits to the theatres. It is stated that the pantomime of *Mother Goose* (1807) produced more than £30,000 for the management at Covent Garden theatre, and the *High-metled Racer*, adapted as a pantomime from his father's play, £18,000 at Astley's. Dibdin was prompter and pantomime writer at Drury Lane until 1816, when he took the Surrey theatre. This venture proved disastrous and he became bankrupt. After this he was manager of the Haymarket, but without his old success, and his last years were passed in comparative poverty. In 1827 he published two volumes of *Reminiscences*; and at the time of his death he was preparing an edition of his father's sea songs, for which a small sum was allowed him weekly by the lords of the admiralty. Of his own songs "The Oak Table" and "The Snug Little Island" are well-known examples. He died in London on the 16th of September 1841.

DIBRA (Slav. *Debra*), the capital of a sanjak bearing the same name, in the vilayet of Monastir, eastern Albania, Turkey. Pop. (1900) about 15,000. Dibra occupies a valley enclosed by mountains, and watered by the Tsrni Drin and Radika rivers, which meet 3 m. S. It is a fortified city, and the only episcopal see of the Bulgarian exarchate in Albania; most of the inhabitants are Albanians, but there is a strong Bulgarian colony. The local trade is almost entirely agricultural.

DIBRUGARH, a town of British India, in the Lakhimpur district of eastern Bengal and Assam, of which it is the headquarters, situated on the Dibru river about 4 m. above its confluence with the Brahmaputra. Pop. (1901) 11,227. It is the terminus of steamer navigation on the Brahmaputra, and also of a railway running to important coal-mines and petroleum wells, which connects with the Assam-Bengal system. Large quantities of coal and tea are exported. There are a military cantonment, the headquarters of the volunteer corps known as the Assam Valley Light Horse; a government high school, a training school for masters; and an aided school for girls. In 1900 a medical school for the province was established, out of a bequest left

by Brigade-Surgeon J. Berry-White, which is maintained by the government, to train hospital assistants for the tea gardens. The Williamson artisan school is entirely supported by an endowment.

DICÆARCHUS, of Messene in Sicily, Peripatetic philosopher and pupil of Aristotle, historian, and geographer, flourished about 320 B.C. He was a friend of Theophrastus, to whom he dedicated the majority of his works. Of his writings, which comprised treatises on a great variety of subjects, only the titles and a few fragments survive. The most important of them was his *Βίος τῆς Ἑλλάδος* (*Life in Greece*), in which the moral, political and social condition of the people was very fully discussed. In his *Tripoliticos* he described the best form of government as a mixture of monarchy, aristocracy and democracy, and illustrated it by the example of Sparta. Among the philosophical works of Dicæarchus may be mentioned the *Lesbiaci*, a dialogue in three books, in which the author endeavours to prove that the soul is mortal, to which he added a supplement called *Corinthiaci*. He also wrote a *Description of the World* illustrated by maps, in which was probably included his *Measurements of Mountains*. A description of Greece (150 iambics, in C. Müller, *Frag. hist. Græc.* i. 238-243) was formerly attributed to him, but, as the initial letters of the first twenty-three lines show, was really the work of Dionysius, son of Calliphon. Three considerable fragments of a prose description of Greece (Müller, i. 97-110) are now assigned to an unknown author named Heraclides. The *De re publica* of Cicero is supposed to be founded on one of Dicæarchus's works.

The best edition of the fragments is by M. Fuhr (1841), a work of great learning; see also a dissertation by F. G. Osann, *Beiträge zur röm. und griech. Literatur*, ii. pp. 1-117 (1839); Pauly-Wissowa, *Realencyclopædie der klass. Altertumswiss.* v. pt. 1 (1905).

DICE (plural of die, O. Fr. *de*, derived from Lat. *dare*, to give), small cubes of ivory, bone, wood or metal, used in gaming. The six sides of a die are each marked with a different number of incised dots in such a manner that the sum of the dots on any two opposite sides shall be 7. Dice seem always to have been employed, as is the case to-day, for gambling purposes, and they are also used in such games as backgammon. There are many methods of playing, from one to five dice being used, although two or three are the ordinary numbers employed in Great Britain and America. The dice are thrown upon a table or other smooth surface either from the hand or from a receptacle called a dice-box, the latter method having been in common use in Greece, Rome and the Orient in ancient times. Dice-boxes have been made in many shapes and of various materials, such as wood, leather, agate, crystal, metal or paper. Many contain bars within to ensure a proper agitation of the dice, and thus defeat trickery. Some, formerly used in England, were employed with unmarked dice, and allowed the cubes to fall through a kind of funnel upon a board marked off into six equal parts numbered from 1 to 6. It is a remarkable fact, that, wherever dice have been found, whether in the tombs of ancient Egypt, of classic Greece, or of the far East, they differ in no material respect from those in use to-day, the elongated ones with rounded ends found in Roman graves having been, not dice but *kali*, or knucklebones. Eight-sided dice have comparatively lately been introduced in France as aids to children in learning the multiplication table. The teetotum, or spinning die, used in many modern games, was known in ancient times in China and Japan. The increased popularity of the more elaborate forms of gaming has resulted in the decline of dicing. The usual method is to throw three times with three dice. If one or more sixes or fives are thrown the first time they may be reserved, the other throws being made with the dice that are left. The object is to throw three sixes=18 or as near that number as possible, the highest throw winning, or, when drinks are to be paid for, the lowest throw losing. (For other methods of throwing consult the *Encyclopædia of Indoor Games*, by R. F. Foster, 1903.) The most popular form of pure gambling with dice at the present day, particularly with the lower classes in America, is *Craps*, or *Crap-Shooting*, a simple form of *Hazard*, of French origin. Two dice are used. Each player puts up a stake

and the first caster may cover any or all of the bets. He then *shoots*, i.e. throws the dice from his open hand upon the table. If the sum of the dice is 7 or 11 the throw is a *nick*, or *natural*, and the caster wins all stakes. If the throw is either 2, 3 or 12 it is a *crap*, and the caster loses all. If any other number is thrown it is a *point*, and the caster continues until he throws the same number again, in which case he wins, or a 7, in which case he loses. The now practically obsolete game of Hazard was much more complicated than *Craps*. (Consult *The Game of Hazard Investigated*, by George Lowbut.) *Poker dice* are marked with ace, king, queen, jack and ten-spot. Five are used and the object is, in three throws, to make pairs, triplets, full hands or fours and fives of a kind, five aces being the highest hand. Straights do not count. In throwing to decide the payment of drinks the usual method is called *horse and horse*, in which the highest throws retire, leaving the two lowest to decide the loser by the best two in three throws. Should each player win one throw both are said to be *horse and horse*, and the next throw determines the loser. The two last casters may also agree to *sudden death*, i.e. a single throw. *Loaded dice*, i.e. dice weighted slightly on the side of the lowest number, have been used by swindlers from the very earliest times to the present day, a fact proved by countless literary allusions. Modern dice are often rounded at the corners, which are otherwise apt to wear off irregularly.

History.—Dice were probably evolved from knucklebones. The antiquary Thomas Hyde, in his *Symagma*, records his opinion that the game of "odd or even," played with pebbles, is nearly coeval with the creation of man. It is almost impossible to trace clearly the development of dice as distinguished from knucklebones, on account of the confusing of the two games by the ancient writers. It is certain, however, that both were played in times antecedent to those of which we possess any written records. Sophocles, in a fragment, ascribed their invention to Palamedes, a Greek, who taught them to his countrymen during the siege of Troy, and who, according to Pausanias (on Corinth, xx.), made an offering of them on the altar of the temple of Fortune. Herodotus (*Clio*) relates that the Lydians, during a period of famine in the days of King Atys, invented dice, knucklebones and indeed all other games except chess. The fact that dice have been used throughout the Orient from time immemorial, as has been proved by excavations from ancient tombs, seems to point clearly to an Asiatic origin. Dicing is mentioned as an Indian game in the *Rig-veda*. In its primitive form knucklebones was essentially a game of skill, played by women and children, while dice were used for gambling, and it was doubtless the gambling spirit of the age which was responsible for the derivative form of knucklebones, in which four sides of the bones received different values, which were then counted, like dice. Gambling with three, sometimes two, dice (*alpha*) was a very popular form of amusement in Greece, especially with the upper classes, and was an almost invariable accompaniment to the symposium, or drinking banquet. The dice were cast from conical beakers, and the highest throw was three sixes, called *Aphrodite*, while the lowest, three aces, was called the *dog*. Both in Greece and Rome different modes of counting were in vogue. Roman dice were called *tesserae* from the Greek word for four, indicative of the four sides. The Romans were passionate gamblers, especially in the luxurious days of the Empire, and dicing was a favourite form, though it was forbidden except during the *Saturnalia*. The emperor Augustus wrote in a letter to Suetonius concerning a game that he had played with his friends: "Whoever threw a *dog* or a six paid a *denarius* to the bank for every die, and whoever threw a *Venus* (the highest) won everything." In the houses of the rich the dice-beakers were of carved ivory and the dice of crystal inlaid with gold. Mark Antony wasted his time at Alexandria with dicing, while, according to Suetonius, the emperors Augustus, Nero and Claudius were passionately fond of it, the last named having written a book on the game. Caligula notoriously cheated at the game; Domitian played it, and Commodus set apart special rooms in his palace for it. The emperor Verus, adopted son of Antonine, is known to have thrown dice whole nights together. Fashionable society

followed the lead of its emperors, and, in spite of the severity of the laws, fortunes were squandered at the dicing-table. Horace derided the youth of the period, who wasted his time amid the dangers of dicing instead of taming his charger and giving himself up to the hardships of the chase. Throwing dice for money was the cause of many special laws in Rome, according to one of which no suit could be brought by a person who allowed gambling in his house, even if he had been cheated or assaulted. Professional gamblers were common, and some of their loaded dice are preserved in museums. The common public-houses were the resorts of gamblers, and a fresco is extant showing two quarrelling dicers being ejected by the indignant host. Virgil, in the *Copa* generally ascribed to him, characterizes the spirit of that age in verse, which has been Englished as follows:—

"What ho! Bring dice and good wine!
Who cares for the morrow?
Live, — so calls grinning Death—
Live, for I come to you soon!"

That the barbarians were also given to gaming, whether or not they learned it from their Roman conquerors, is proved by Tacitus, who states that the Germans were passionately fond of dicing, so much so, indeed, that, having lost everything, they would even stake their personal liberty. Centuries later, during the middle ages, dicing became the favourite pastime of the knights, and both dicing schools (*scholae dectorum*) and guilds of dicers existed. After the downfall of feudalism the famous German mercenaries called *lands-knechts* established a reputation as the most notorious dicing gamblers of their time. Many of the dice of the period were curiously carved in the images of men and beasts. In France both knights and ladies were given to dicing, which repeated legislation, including interdictions on the part of St Louis in 1254 and 1256, did not abolish. In Japan, China, Korea, India and other Asiatic countries dice have always been popular and are so still.

See Foster's *Encyclopædia of Indoor Games* (1903); Raymond's *Illustrated Knobbevier* (Oranienburg, 1888); *Les Jeux des Anciens*, by L. Becq de Fouquières (Paris, 1869); *Das Knöchelspiel der Alten*, by Bolle (Wismar, 1886); *Die Spiele der Griechen und Römer*, by W. Richter (Leipzig, 1887); Raymond's *Alle und neue Würfelspiele; Chinese Games with Dice*, by Stewart Culin (Philadelphia, 1889); *Korean Games*, by Stewart Culin (Philadelphia, 1895).

DICETO, RALPH DE (d. c. 1202), dean of St Paul's, London, and chronicler, is first mentioned in 1152, when he received the archdeaconry of Middlesex. He was probably born between 1120 and 1130; of his parentage and nationality we know nothing. The common statement that he derived his surname from Diss in Norfolk is a mere conjecture; Dicetum may equally well be a Latinized form of Dissai, or Dicy, or Dizy, place-names which are found in Maine, Picardy, Burgundy and Champagne. In 1152 Diceto was already a master of arts; presumably he had studied at Paris. His reputation for learning and integrity stood high; he was regarded with respect and favour by Arnulf of Lisieux and Gilbert Foliot of Hereford (afterwards of London), two of the most eminent bishops of their time. Quite naturally, the archdeacon took in the Becket question the same side as his friends. Although his narrative is colourless, and although he was one of those who showed some sympathy for Becket at the council of Northampton (1164), the correspondence of Diceto shows that he regarded the archbishop's conduct as ill-considered, and that he gave advice to those whom Becket regarded as his chief enemies. Diceto was selected, in 1166, as the envoy of the English bishops when they protested against the excommunications launched by Becket. But, apart from this episode, which he characteristically omits to record, he remained in the background. The natural impartiality of his intellect was accentuated by a certain timidity, which is apparent in his writings no less than in his life. About 1180 he became dean of St Paul's. In this office he distinguished himself by careful management of the estates, by restoring the discipline of the chapter, and by building at his own expense a deanery-house. A scholar and a man of considerable erudition, he showed a strong preference for historical studies; and about the time when he was preferred to the deanery he began to collect materials for the history of

own times. His friendships with Richard Fitz Nigel, who succeeded Foliot in the see of London, with William Longchamp, the chancellor of Richard I., and with Walter of Coutances, the archbishop of Rouen, gave him excellent opportunities of collecting information. His two chief works, the *Abbreviationes Chroniconum* and the *Ymagines Historiarum*, cover the history of the world from the birth of Christ to the year 1202. The former, which ends in 1147, is a work of learning and industry, but almost entirely based upon extant sources. The latter, beginning as a compilation from Robert de Monte and the letters of Foliot, becomes an original authority about 1172, and a contemporary record about 1181. In precision and fulness of detail the *Ymagines* are inferior to the chronicles of the so-called Benedict and of Hoveden. Though an annalist, Dicoeto is careless in his chronology; and the documents which he incorporates, while often important, are selected on no principle. He has little sense of style; but displays considerable insight when he ventures to discuss a political situation. For this reason, and on account of the details with which they supplement the more important chronicles of the period, the *Ymagines* are a valuable though a secondary source.

See W. Stubbs' edition of the *Historical Works of Dicoeto* (Rolls ed. 1876, 2 vols.), and especially the introduction. The second volume contains minor works which are the barest compendia of facts taken from well-known sources. Dicoeto's fragmentary Domesday of the caputal estates has been edited by Archdeacon Hale in *The Domesday of St Paul's*, pp. 109 ff. (Camden Society, 1858).

DICEY, EDWARD (1832—), English writer, son of T. E. Dicey of Claybrook Hall, Leicestershire, was born in 1832. Educated at Trinity College, Cambridge, where he took mathematical and classical honours, he became an active journalist, contributing largely to the principal reviews. He was called to the bar in 1875, became a bencher of Gray's Inn in 1896, and was treasurer in 1903-1904. He was connected with the *Daily Telegraph* as leader writer and then as special correspondent, and after a short spell in 1870 as editor of the *Daily News* he became editor of the *Observer*, a position which he held until 1889. Of his many books on foreign affairs perhaps the most important are his *England and Egypt* (1884), *Bulgaria, the Peasant State* (1895), *The Story of the Khedivate* (1902), and *The Egypt of the Future* (1907). He was created C.B. in 1886.

His brother **ALBERT VENN DICEY** (b. 1835), English jurist, was educated at Balliol College, Oxford, where he took a first class in the classical schools in 1858. He was called to the bar at the Inner Temple in 1863. He held fellowships successively at Balliol, Trinity and All Souls', and from 1882 to 1909 was Vinerian professor of law. He became Q.C. in 1890. His chief works are the *Introduction to the Study of the Law of the Constitution* (1885, 6th ed. 1902), which ranks as a standard work on the subject; *England's Case against Home Rule* (1886); *A Digest of the Law of England with Reference to the Conflict of Laws* (1896), and *Lectures on the Relation between Law and Public Opinion in England during the 19th century* (1905).

DICHOTOMY (Gr. *di*, apart, *rhizō*, to cut), literally a cutting asunder, the technical term for a form of logical division, consisting in the separation of a genus into two species, one of which has and the other has not, a certain quality or attribute. Thus men may be thus divided into white men, and men who are not white; each of these may be subdivided similarly. On the principle of contradiction this division is both exhaustive and exclusive; there can be no overlapping, and no members of the original genus or the lower groups are omitted. This method of classification, though formally accurate, has slight value in the exact sciences, partly because at every step one of the two groups is merely negatively characterized and therefore incapable of real subdivision; it is useful, however, in setting forth clearly the gradual descent from the most inclusive genus (*summmum genus*) through species to the lowest class (*infima species*), which is divisible only into individual persons or things. (See further **DIVISION**.) In astronomy the term is used for the aspect of the moon or of a planet when apparently half illuminated, so that its disk has the form of a semicircle.

DICK, ROBERT (1811-1866), Scottish geologist and botanist, was born at Tullibody, in Clackmannanshire, in January 1811. His father was an officer of excise. At the age of thirteen, after receiving a good elementary education at the parish school, Robert Dick was apprenticed to a baker, and served for three years. In these early days he became interested in wild flowers—he made a collection of plants and gradually acquired some knowledge of their names from an old encyclopaedia. When his time was out he left Tullibody and gained employment as a journeyman baker at Leith, Glasgow and Greenock. Meanwhile his father, who in 1826 had been removed to Thurso, as supervisor of excise, advised his son to set up a baker's shop in that town. Thither Robert Dick went in 1830, he started in business as a baker and worked laboriously until he died on the 24th of December 1866. Throughout this period he zealously devoted himself to studying and collecting the plants, mollusca and insects of a wide area of Caithness, and his attention was directed soon after he settled in Thurso to the rocks and fossils. In 1835 he first found remains of fossil fishes; but it was not till some years later that his interest became greatly stirred. Then he obtained a copy of Hugh Miller's *Old Red Sandstone* (published in 1841), and he began systematically to collect with hammer and chisel the fossils from the Caithness flags. In 1845 he found remains of *Holoptychius* and forwarded specimens to Hugh Miller, and he continued to send the best of his fossil fishes to that geologist, and to others after the death of Miller. In this way he largely contributed to the progress of geological knowledge, although he himself published nothing and was ever averse from publicity. His herbarium, which consisted of about 300 folios of mosses, ferns and flowering plants "almost unique in its completeness," is now stored, with many of his fossils, in the museum at Thurso. Dick had a hard struggle for existence, especially through competition during his late years, when he was reduced almost to beggary: but of this few, if any, of his friends were aware until it was too late. A monument erected in the new cemetery at Thurso testifies to the respect which his life-work created, when the merits of this enthusiastic naturalist came to be appreciated.

See *Robert Dick, Baker of Thurso, Geologist and Botanist*, by Samuel Smiles (1878).

DICK, THOMAS (1774-1857), Scottish writer on astronomy, was born at Dundee on the 24th of November 1774. The appearance of a brilliant meteor inspired him, when in his ninth year, with a passion for astronomy; and at the age of sixteen he forsook the loom, and supported himself by teaching. In 1794 he entered the university of Edinburgh, and set up a school on the termination of his course; then, in 1801, took out a licence to preach, and officiated for some years as probationer in the United Presbyterian church. From about 1807 to 1817 he taught in the secession school at Methven in Perthshire, and during the ensuing decade in that of Perth, where he composed his first substantive book, *The Christian Philosopher* (1823, 8th ed. 1842). Its success determined his vocation as an author; he built himself, in 1827, a cottage at Broughty Ferry, near Dundee, and devoted himself wholly to literary and scientific pursuits. They proved, however, owing to his unpractical turn of mind, but slightly remunerative, and he was in 1847 relieved from actual poverty by a crown pension of £50 a year, eked out by a local subscription. He died on the 29th of July 1857. His best-known works are: *Celestial Scenery* (1837), *The Sidereal Heavens* (1840), and *The Practical Astronomer* (1845), in which is contained (p. 204) a remarkable forecast of the powers and uses of celestial photography. Written with competent knowledge, and in an agreeable style, they obtained deserved and widespread popularity.

See *R. Chambers's Eminent Scotsmen* (ed. 1868); *Monthly Notices Roy. Astr. Society*, xviii. 98; *Athenaeum* (1857), p. 1008.

(A. M. C.)

DICKENS, CHARLES JOHN HUFFAM (1812-1870), English novelist, was born on the 7th of February 1812 at a house in the Mile End Terrace, Commercial Road, Landport (Portsea)—a house which was opened as a Dickens Museum on 22nd July 1904. His father John Dickens (d. 1851), a clerk in the navy-pay office

on a salary of £80 a year, and stationed for the time being at Portsmouth, had married in 1809 Elizabeth, daughter of Thomas Barrow, and she bore him a family of eight children, Charles being the second. In the winter of 1814 the family moved from Portsea in the snow, as he remembered, to London, and lodged for a time near the Middlesex hospital. The country of the novelist's childhood, however, was the kingdom of Kent, where the family was established in proximity to the dockyard at Chatham from 1816 to 1821. He looked upon himself in later years as a man of Kent, and his capital abode as that in Ordnance Terrace, or 18 St Mary's Place, Chatham, amid surroundings classified in Mr Pickwick's notes as "appearing" to be soldiers, sailors, Jews, chalk, shrimps, officers and dockyard men. He fell into a family the general tendency of which was to go down in the world, during one of its easier periods (John Dickens was now fifth clerk on £50 a year), and he always regarded himself as belonging by right to a comfortable, genteel, lower middle-class stratum of society. His mother taught him to read; to his father he appeared very early in the light of a young prodigy, and by him Charles was made to sit on a tall chair and warble popular ballads, or even to tell stories and anecdotes for the benefit of fellow-clerks in the office. John Dickens, however, had a small collection of books which were kept in a little room upstairs that led out of Charles's own, and in this attic the boy found his true literary instructors in *Roderick Random*, *Peregrine Pickle*, *Humphrey Clinker*, *Tom Jones*, *The Vicar of Wakefield*, *Don Quixote*, *Gil Blas* and *Robinson Crusoe*. The story of how he played at the characters in these books and sustained his idea of *Roderick Random* for a month at a stretch is picturesquely told in *David Copperfield*. Here as well as in his first and last books and in what many regard as his best, *Great Expectations*, Dickens returns with unabated fondness and mastery to the surroundings of his childhood. From seven to nine years he was at a school kept in Clover Lane, Chatham, by a Baptist minister named William Giles, who gave him Goldsmith's *Bes* as a keepsake when the call to Somerset House necessitated the removal of the family from Rochester to a shabby house in Bayham Street, Camden Town. At the very moment when a consciousness of capacity was beginning to plump his youthful ambitions, the whole flattering dream vanished and left not a rack behind. Happiness and Chatham had been left behind together, and Charles was about to enter a school far sterner and also far more instructive than that in Clover Lane. The family income had been first decreased and then mortgaged; the creditors of the "prodigal father" would not give him time; John Dickens was consigned to the Marshalsea; Mrs Dickens started an "Educational Establishment" as a forlorn hope in Upper Gower Street; and Charles, who had helped his mother with the children, blacked the boots, carried things to the pawnshop and done other menial work, was now sent out to earn his own living as a young hand in a blacking warehouse, at Old Hungerford Stairs, on a salary of six shillings a week. He tied, trimmed and labelled blacking pots for over a year, dining off a saveloy and a slice of pudding, consorting with two very rough boys, Bob Fagin and Pol Green, and sleeping in an attic in Little College Street, Camden Town, in the house of Mrs Roylance (Pipchin), while on Sunday he spent the day with his parents in their comfortable prison, where they had the services of a "marchioness" imported from the Chatham workhouse.

Already consumed by ambition, proud, sensitive and on his dignity to an extent not uncommon among boys of talent, he felt his position keenly, and in later years worked himself up into a passion of self-pity in connexion with the "degradation" and "humiliation" of this episode. The two years of childish hardship which ate like iron into his soul were obviously of supreme importance in the growth of the novelist. Recollections of the streets and the prison and its purlieus supplied him with a store of literary material upon which he drew through all the years of his best activity. And the bitterness of such an experience was not prolonged sufficiently to become sour. From 1824 to 1826, having been rescued by a family quarrel and by a windfall in the shape of a legacy to his father, from the warehouse, he spent two

years at an academy known as Wellington House, at the corner of Granby Street and the Hampstead Road (the lighter traits of which are reproduced in Salem House), and was there known as a merry and rather mischievous boy. Fortunately he learned nothing there to compromise the results of previous instruction. His father had now emerged from the Marshalsea and was seeking employment as a parliamentary reporter. A Gray's Inn solicitor with whom he had had dealings was attracted by the bright, clever look of Charles, and took him into his office as a boy at a salary of thirteen and sixpence (rising to fifteen shillings) a week. He remained in Mr Blackmore's office from May 1827 to November 1828, but he had lost none of his eager thirst for distinction, and spent all his spare time mastering Gurney's shorthand and reading early and late at the British Museum. A more industrious apprentice in the lower grades of the literary profession has never been known, and the consciousness of opportunities used to the most splendid advantage can hardly have been absent from the man who was shortly to take his place at the head of it as if to the manner born. Lowten and Guppy, and Swiveller had been observed from this office lad's stool; he was now greatly to widen his area of study as a reporter in Doctors' Commons and various police courts, including Bow Street, working all day at law and much of the night at shorthand. Some one asked John Dickens, during the first eager period of curiosity as to the man behind "Pickwick," where his son Charles was educated. "Well really," said the prodigal father, "he may be said—haw—haw—to have educated himself." He was one of the most rapid and accurate reporters in London when, at nineteen years of age, in 1831, he realized his immediate ambition and "entered the gallery" as parliamentary reporter to the *True Sun*. Later he was reporter to the *Mirror of Parliament* and then to the *Morning Chronicle*. Several of his earliest letters are concerned with his exploits as a reporter, and allude to the experiences he had, travelling fifteen miles an hour and being upset in almost every description of known vehicle in various parts of Britain between 1831 and 1836. The family was now living in Bentwick Street, Manchester Square, but John Dickens was still no infrequent inmate of the sponging-houses. With all the accessories of these places of entertainment his son had grown to be excessively familiar. Writing about 1832 to his school friend Tom Mitton, Dickens tells him that his father has been arrested at the suit of a wine firm, and begs him go over to Cursitor Street and see what can be done. On another occasion of a paternal disappearance he observes: "I own that his absence does not give me any great uneasiness, knowing how apt he is to get out of the way when anything goes wrong." In yet another letter he asks for a loan of four shillings.

In the meanwhile, however, he had commenced author in a more creative sense by penning some sketches of contemporary London life, such as he had attempted in his school days in imitation of the sketches published in the *London* and other magazines of that day. The first of these appeared in the December number of the *Old Monthly Magazine* for 1833. By the following August, when the signature "Boz" was first given, five of these sketches had appeared. By the end of 1834 we find him settled in rooms in Furnival's Inn, and a little later his salary on the *Morning Chronicle* was raised, owing to the intervention of one of its chiefs, George Hogarth, the father of (in addition to six sons) eight charming daughters, to one of whom, Catherine, Charles was engaged to be married before the year was out. Clearly as his career now seemed designated, he was at this time or a little before it coquetting very seriously with the stage; but circumstances were rapidly to determine another stage in his career. A year before Queen Victoria's accession appeared in two volumes *Sketches by Boz, Illustrative of Everyday Life and Everyday People*. The book came from a prentice hand, but like the little tract on the Puritan abuse of the Sabbath entitled "Sunday under three Heads" which appeared a few months later, it contains in germ all, or almost all, the future Dickens. Glance at the headings of the pages. Here we have the Beadle and all connected with him, London streets, theatres, shows, the pawnshop, Doctors' Commons, Christmas, Newgate, coaching, the

river. Here comes a satirical picture of parliament, fun made of cheap snobbery, a rap on the knuckles of sectarianism. And what could be more prophetic than the title of the opening chapter—*Our Parish?* With the *Parish*—a large one indeed—Dickens to the end concerned himself; he began with a rapid survey of his whole field, hinting at all he might accomplish, indicating the limits he was not to pass. This year was to be still more momentous to Dickens, for, on the 2nd of April 1836, he was married to George Hogarth's eldest daughter Catherine. He seems to have fallen in love with the daughters collectively, and, judging by subsequent events, it has been suggested that perhaps he married the wrong one. His wife's sister Mary was the romance of his early married life, and another sister, Georgina, was the dearest friend of his last ten years.

A few days before the marriage, just two months after the appearance of the *Sketches*, the first part of *The Posthumous Papers of the Pickwick Club* was announced. One of the chief vogues of the day was the issue of humorous, sporting or anecdotal novels in parts, with plates, and some of the best talent of the day, represented by Ainsworth, Bulwer, Marryat, Maxwell, Egan, Hook and Surtees, had been pressed into this kind of enterprise. The publishers of the day had not been slow to perceive Dickens's aptitude for this species of "letterpress." A member of the firm of Chapman & Hall called upon him at Furnival's Inn in December 1835 with a proposal that he should write about a Nimrod Club of amateur sportsmen, foredoomed to perpetual ignominies, while the comic illustrations were to be etched by Seymour, a well-known rival of Cruikshank (the illustrator of *Boz*). The offer was too tempting for Dickens to refuse, but he changed the idea from a club of Cockney sportsmen to that of a club of eccentric peripatetics, on the sensible grounds, first that sporting sketches were stale, and, secondly, that he knew nothing worth speaking of about sport. The first seven pictures appeared with the signature of Seymour and the letterpress of Dickens. Before the eighth picture appeared Seymour had blown his brains out. After a brief interval of Buss, Dickens obtained the services of Hablot K. Browne, known to all as "Phiz." Author and illustrator were as well suited to one another and to the common creation of a unique thing as Gilbert and Sullivan. Having early got rid of the sporting element, Dickens found himself at once. The subject exactly suited his knowledge, his skill in arranging incidents—nay, his very limitations too. No modern book is so incalculable. We commence laughing heartily at Fickwick and his troupe. The laugh becomes kindlier. We are led on through a tangle of adventure, never dreaming what is before us. The landscape changes: Pickwick becomes the symbol of kind-heartedness, simplicity and innocent levity. Suddenly in the Fleet Prison a deeper note is struck. The medley of human relationships, the loneliness, the mystery and sadness of human destinies are fathomed. The tragedy of human life is revealed to us amid its most farcical elements. The droll and laughable figure of the hero is transfigured by the kindness of human sympathy into a beneficent and bespectacled angel in shorts and gaiters. By defying accepted rules, Dickens had transcended the limited sphere hitherto allotted to his art: he had produced a book to be enshrined henceforth in the inmost hearts of all sorts and conditions of his countrymen, and had definitely enlarged the boundaries of English humour and English fiction. As for Mr Pickwick, he is a fairy like Puck or Santa Claus, while his creator is "the last of the mythologists and perhaps the greatest."

When *The Pickwick Papers* appeared in book form at the close of 1837 Dickens's popular reputation was made. From the appearance of Sam Weller in part v. the universal hunger for the monthly parts had risen to a furor. The book was promptly translated into French and German. The author had received little assistance from press or critics, he had no influential connexions. His class of subjects was such as to "expose him at the outset to the fatal objections of vulgarity," yet in less than six months from the appearance of the first number, as the *Quarterly Review* almost ruefully admits, the whole reading world was talking about the Pickwickians. The names of Winkle, Wardle, Weller, Jingle, Snodgrass, Dodson & Fogg, were as familiar as

household words. Pickwick chintzes figured in the linendrapers' windows, and Pickwick cigars in every tobacconist's; Weller corduroys became the stock-in-trade of every breeches-maker; Boz cabs might be seen rattling through the streets, and the portrait of the author of *Pelham* and *Crickton* was scraped down to make way for that of the new popular favourite on the omnibuses. A new and original genius had suddenly sprung up, there was no denying it, even though, as the *Quarterly* concluded, "it required no gift of prophecy to foretell his fate—he has risen like a rocket and he will come down like the stick." It would have needed a very emphatic gift of prophecy indeed to foretell that Dickens's reputation would have gone on rising until at the present day (after one sharp fall, which reached an extreme about 1887) it stands higher than it has ever stood before.

Dickens's assumption of the literary purple was as amazing as anything else about him. Accepting the homage of the luminaries of the literary, artistic and polite worlds as if it had been his natural due, he arranges for the settlement of his family, decrees, like another Edmund Kean, that his son is to go to Eton, carries on the most complicated negotiations with his publishers and editors, presides and orates with incomparable force at innumerable banquets, public and private, arranges elaborate villas in the country, at the seaside, in France or in Italy, arbitrates in public on every topic, political, ethical, artistic, social or literary, entertains and legislates for an increasingly large domestic circle, both juvenile and adult, rules himself and his time-table with a rod of iron. In his letter-writing alone, Dickens did a life's literary work. Nowadays no one thinks of writing such letters; that is to say, letters of such length and detail, for the quality is Dickens's own. He evidently enjoyed this use of the pen. Page after page of Forster's *Life* (750 pages in the *Letters* edited by his daughter and sister-in-law) is occupied with transcription from private correspondence, and never a line of this but is thoroughly worthy of print and preservation. If he makes a tour in any part of the British Isles, he writes a full description of all he sees, of everything that happens, and writes it with such gusto, such mirth, such strokes of fine picturing, as appear in no other private letters ever given to the public. Naturally buoyant in all circumstances, a holiday gave him the exhilaration of a school-boy. See how he writes from Cornwall, when on a trip with two or three friends, in 1843. "Heavens! if you could have seen the necks of bottles, distracting in their immense variety of shape, peering out of the carriage pockets! If you could have witnessed the deep devotion of the post-boys, the maniac glee of the waiters! If you could have followed us into the earthy old churches we visited, and into the strange caverns on the gloomy seashore, and down into the depths of mines, and up to the tops of giddy heights, where the unspeakably green water was roaring, I don't know how many hundred feet below. . . . I never laughed in my life as I did on this journey. It would have done you good to hear me. I was choking and gasping and bursting the buckles off the back of my stock, all the way. And Stanfield"—the painter—"got into such apoplectic entanglements that we were obliged to beat him on the back with portmanteaus before we could recover him."

The animation of Dickens's look would attract the attention of any one, anywhere. His figure was not that of an Adonis, but his brightness made him the centre and pivot of every society he was in. The keenness and vivacity of his eye combined with his inordinate appetite for life to give the unique quality to all that he wrote. His instrument is that of the direct, sinewy English of Smollett, combined with much of the humorous grace of Goldsmith (his two favourite authors), but modernized to a certain extent under the influence of Washington Irving, Sydney Smith, Jeffrey, Lamb, and other writers of the *London Magazine*. He taught himself to speak French and Italian, but he could have read little in any language. His ideas were those of the inchoate and insular liberalism of the 'thirties. His unique force in literature he was to owe to no supreme artistic or intellectual quality, but almost entirely to his inordinate gift of observation, his sympathy with the humble, his power over the emotions and his incomparable endowment of unalloyed human fun. To

contemporaries he was not so much a man as an institution, at the very mention of whose name faces were puckered with grins or wreathed in smiles. To many his work was a revelation, the revelation of a new world and one far better than their own. And his influence went further than this in the direction of revolution or revival. It gave what were then universally referred to as "the lower orders" a new sense of self-respect, a new feeling of citizenship. Like the defiance of another Luther, or the Declaration of a new Independence, it emitted a fresh ray of hope across the firmament. He did for the whole English-speaking race what Burns had done for Scotland—he gave it a new conceit of itself. He knew what a people wanted and he told what he knew. He could do this better than anybody else because his mind was theirs. He shared many of their "great useless virtues," among which generosity ranks before justice, and sympathy before truth, even though, true to his middle-class vein, he exalts piety, chastity and honesty in a manner somewhat alien to the mind of the low-bred man. This is what makes Dickens such a demigod and his public success such a marvel, and this also is why any exclusively literary criticism of his work is bound to be so inadequate. It should also help us to make the necessary allowances for the man. Dickens, even the Dickens of legend that we know, is far from perfect. The Dickens of reality to which Time may furnish a nearer approximation is far less perfect. But when we consider the corroding influence of adulation, and the intoxication of unbridled success, we cannot but wonder at the relatively high level of moderation and self-control that Dickens almost invariably observed. Mr G. K. Chesterton remarks suggestively that Dickens had all his life the faults of the little boy who is kept up too late at night. He is overwrought by happiness to the verge of exasperation, and yet as a matter of fact he does keep on the right side of the breaking point. The specific and curative in his case was the work in which he took such anxious pride, and such unmitigated delight. He revelled in punctual and regular work; at his desk he was often in the highest spirits. Behold how he pictured himself, one day at Broadstairs, where he was writing *Chuzzlewit*. "In a bay-window in a one-pair sits, from nine o'clock to one, a gentleman with rather long hair and no neckcloth, who writes and grins, as if he thought he was very funny indeed. At one he disappears, presently emerges from a bathing machine, and may be seen, a kind of salmon-colour porpoise, splashing about in the ocean. After that, he may be viewed in another bay-window on the ground-floor eating a strong lunch; and after that, walking a dozen miles or so, or lying on his back on the sand reading a book. Nobody bothers him, unless they know he is disposed to be talked to, and I am told he is very comfortable indeed. He's as brown as a berry, and they do say he is as good as a small fortune to the innkeeper, who sells beer and cold punch." Here is the secret of such work as that of Dickens; it is done with delight—done (in a sense) easily, done with the mechanism of mind and body in splendid order. Even so did Scott write; though more rapidly and with less conscious care: his chapter finished before the world had got up to breakfast. Later, Dickens produced novels less excellent with much more of mental strain. The effects of age could not have shown themselves so soon, but for the unfortunate loss of energy involved in his non-literary labours.

While the public were still rejoicing in the first sprightly findings of the "new humour," the humorist set to work desperately on the grim scenes of *Oliver Twist*, the story of a parish orphan, the nucleus of which had already seen the light in his *Sketches*. The early scenes are of a harrowing reality, despite the germ of forced pathos which the observant reader may detect in the pitiful parting between Oliver and little Dick; but what will strike every reader at once in this book is the directness and power of the English style, so nervous and unadorned: from its unmistakable clearness and vigour Dickens was to travel far as time went on. But the full effect of the old simplicity is felt in such masterpieces of description as the drive of Oliver and Skes to Chertsey, the condemned-cell ecstasy of Fagin, or the unforgettable first encounter between Oliver and the Artful

Dodger. Before November 1837 had ended, Charles Dickens entered on an engagement to write a successor to *Pickwick* on similar lines of publication. *Oliver Twist* was then in mid-career; a *Life of Grimaldi* and *Barnaby Rudge* were already covenanted for. Dickens forged ahead with the new tale of *Nicholas Nickleby* and was justified by the results, for its sale far surpassed even that of *Pickwick*. As a conception it is one of his weakest. An unmistakably 18th-century character pervades it. Some of the vignettes are among the most piquant and besetting ever written. Large parts of it are totally unobserved conventional melodrama; but the Portsmouth Theatre and Dotheboys Hall and Mrs Nickleby (based to some extent, it is thought, upon Miss Bates in *Emma*, but also upon the author's Mamma) live for ever as Dickens conceived them in the pages of *Nicholas Nickleby*.

Having got rid of *Nicholas Nickleby* and resigned his editorship of *Bentley's Miscellany*, in which *Oliver Twist* originally appeared, Dickens conceived the idea of a weekly periodical to be issued as *Master Humphrey's Clock*, to comprise short stories, essays and miscellaneous papers, after the model of Addison's *Spectator*. To make the weekly numbers "go," he introduced Mr Pickwick, Sam Weller and his father in friendly intercourse. But the public requisitioned "a story," and in No. 4 he had to brace himself up to give them one. Thus was commenced *The Old Curiosity Shop*, which was continued with slight interruptions, and followed by *Barnaby Rudge*. For the first time we find Dickens obsessed by a highly complicated plot. The tonality achieved in *The Old Curiosity Shop* surpassed anything he had attempted in this difficult vein, while the rich humour of Dick Swiveller and the Marchioness, and the vivid portraiture of the wandering Bohemians, attain the very highest level of Dickensian drollery; but in the lamentable tale of Little Nell (though Landor and Jeffrey thought the character-drawing of this infant comparable with that of Cordelia), it is generally admitted that he committed an indecent assault upon the emotions by exhibiting a veritable monster of piety and long-suffering in a child of tender years. In *Barnaby Rudge* he was manifestly affected by the influence of Scott, whose achievements he always regarded with a touching veneration. The plot, again, is of the utmost complexity, and Edgar Allan Poe (who predicted the conclusion) must be one of the few persons who ever really mastered it. But few of Dickens's books are written in a more admirable style.

Master Humphrey's Clock concluded, Dickens started in 1842 on his first visit to America—an episode hitherto without parallel in English literary history, for he was received everywhere with popular acclamation as the representative of a grand triumph of the English language and imagination, without regard to distinctions of nationality. He offended the American public grievously by a few words of frank description and a few quotations of the advertisement columns of American papers illustrating the essential barbarity of the old slave system (*American Notes*). Dickens was soon pining for home—no English writer is more essentially and insularly English in inspiration and aspiration than he is. He still brooded over the perverseness of America on the copyright question, and in his next book he took the opportunity of uttering a few of his impressions about the objectionable sides of American democracy, the result being that "all Yankee-doodle-dom blazed up like one universal soda bottle," as Carlyle said. *Martin Chuzzlewit* (1843-1844) is important as closing his great character period. His *stee originale*, as the French would say, was by this time to a considerable extent exhausted, and he had to depend more upon artistic elaboration, upon satires, upon *lours de force* of description, upon romantic and ingenious contrivances. But all these resources combined proved unequal to his powers as an original observer of popular types, until he reinforced himself by autobiographic reminiscence, as in *David Copperfield* and *Great Expectations*, the two great books remaining to his later career.

After these two masterpieces and the three wonderful books with which he made his début, we are inclined to rank *Chuzzlewit*. Nothing in Dickens is more admirably seen and presented than *Dodgers*, a bit of London particular cut out with a knife. Mr

Pecksniff and Mrs Gamp, Betsy Prig and "Mrs Harris" have passed into the national language and life. The coach journey, the windy autumn night, the stealthy trail of Jonas, the undertone of tragedy in the Charity and Mery and Chuffey episodes suggest a blending of imaginative vision and physical penetration hardly seen elsewhere. Two things are specially notable about this novel—the exceptional care taken over it (as shown by the interlineations in the MS.) and the caprice or nonchalance of the purchasing public, its sales being far lower than those of any of its monthly predecessors.

At the close of 1843, to pay outstanding debts of his now lavish housekeeping, he wrote that pioneer of Christmas numbers, that national benefit as Thackeray called it, *A Christmas Carol*. It failed to realize his pecuniary anticipations, and Dickens resolved upon a drastic policy of retrenchment and reform. He would save expense by living abroad and would punish his publishers by withdrawing his custom from them, at least for a time. Like everything else upon which he ever determined, this resolution was carried out with the greatest possible precision and despatch. In June 1844 he set out for Marseilles with his now rapidly increasing family (the journey cost him £200). In a villa on the outskirts of Genoa he wrote *The Chimes*, which, during a brief excursion to London before Christmas, he read to a select circle of friends (the germ of his subsequent lecture-audiences, including Forster, Carlyle, Stanfield, Dyce, Macdise and Jerrold. He was again in London in 1845, enjoying his favourite diversion of private theatricals; and in January 1846 he experimented briefly as the editor of a London morning paper—the *Daily News*. By early spring he was back at Lausanne, writing his customary vivid letters to his friends, craving as usual for London streets, commencing *Dombey and Son*, and walking his fourteen miles daily. The success of *Dombey and Son* completely rehabilitated the master's finances, enabled him to return to England, send his son to Eton and to begin to save money. Artistically it is less satisfactory; it contains some of Dickens's prime cruces, such as Cuttle, Bunsby, Toots, Blimber, Pipchin, Mrs MacStinger and young Blier; it contains also that masterpiece of sentimentality which trembles upon the borderland of the sublime and the ridiculous, the death of Paul Dombey ("that sweet Paul," as Jeffrey, the "critic laureate," called him), and some grievous and unquestionable blemishes. As a narrative, moreover, it tails off into a highly complicated and exacting plot. It was followed by a long rest at Broadstairs before Dickens returned to the native home of his genius, and early in 1849 "began to prepare for *David Copperfield*."

"Of all my books," Dickens wrote, "I like this the best; like many fond parents I have my favourite child, and his name is *David Copperfield*." In some respects it stands to Dickens in something of the same relation in which the contemporary *Pendennis* stands to Thackeray. As in that book, too, the earlier portions are the best. They gained in intensity by the autobiographical form into which they are thrown; as Thackeray observed, there was no writing against such power. The tragedy of Emily and the character of Rosa Dartle are stagey and unreal; Uriah Heep is bad art; Agnes, again, is far less convincing as a consolation than Dickens would have us believe; but these are more than compensated by the wonderful realization of early boyhood in the book, by the picture of Mr Creakle's school, the Peggottys, the inimitable Mr Micawber, Betsy Trotwood and that monument of selfish misery, Mrs Gummidge.

At the end of March 1850 commenced the new twopenny weekly called *Household Words*, which Dickens planned to form a direct means of communication between himself and his readers, and as a means of collecting around him and encouraging the talents of the younger generation. No one was better qualified than he for this work, whether we consider his complete freedom from literary jealousy or his magical gift of inspiring young authors. Following the somewhat dreary and incoherent *Bleak House of 1852*, *Hard Times* (1854)—an anti-Manchester School tract, which Ruskin regarded as Dickens's best work—was the first long story written for *Household Words*. About this time Dickens made his final home at Gad's Hill, near Rochester,

and put the finishing touch to another long novel published upon the old plan, *Little Dorrit* (1855-1857). In spite of the exquisite comedy of the master of the Marshalsea and the final tragedy of the central figure, *Little Dorrit* is sadly deficient in the old vitality, the humour is often a mock reality, and the repetition of comic catch-words and overstrung similes and metaphors is such as to affect the reader with nervous irritation. The plot and characters ruin each other in this amorphous production. The *Tale of Two Cities*, commenced in *All the Year Round* (the successor of *Household Words*) in 1859, is much better (the main characters are powerful, the story genuinely tragic, and the atmosphere lurid; but enormous labour was everywhere expended upon the construction of stylistic ornament.

The *Tale of Two Cities* was followed by two finer efforts at atmospheric delineation, the best things he ever did of this kind: *Great Expectations* (1861), over which there broods the mournful impression of the foggy marshes of the Lower Thames; and *Our Mutual Friend* (1864-1865), in which the ooze and mud and slime of Rotherhithe, its boatmen and loafers, are made to pervade the whole book with cumulative effect. The general effect produced by the stories is, however, very different. In the first case, the foreground was supplied by autobiographical material of the most vivid interest, and the lucidity of the creative impulse impelled him to write upon this occasion with the old simplicity, though with an added power. Nothing therefore, in the whole range of Dickens surpassed the early chapters of *Great Expectations* in perfection of technique or in mastery of all the resources of the novelist's art. To have created Abel Magwitch alone is to be a god indeed, says Mr Swinburne, among the creators of deathless men. Pumblechook is actually better and drooler and truer to imaginative life than Pecksniff; Joe Gargery is worthy to have been praised and loved at once by Fielding and by Sterne: Mr Jaggers and his clients, Mr Wemmick and his parent and his bride, are such figures as Shakespeare, when dropping out of poetry, might have created, if his lot had been cast in a later century. "Can as much be said," Mr Swinburne boldly asks, "for the creatures of any other man or god?"

In November 1867 Dickens made a second expedition to America, leaving all the writing that he was ever to complete behind him. He was to make a round sum of money, enough to free him from all embarrassments, by a long series of exhausting readings, commencing at the Tremont Temple, Boston, on the 2nd of December. The strain of Dickens's ordinary life was so tense and so continuous that it is, perhaps, rash to assume that he broke down eventually under this particular stress; for other reasons, however, his persistence in these readings, subsequent to his return, was strongly deprecated by his literary friends, led by the arbitrary and relentless Forster. It is a long testimony to Dickens's self-restraint, even in his most capricious and despotic moments, that he never broke the cord of obligation which bound him to his literary mentor, though sparring matches between them were latterly of frequent occurrence. His farewell reading was given on the 15th of March 1870, at St James's Hall. He then vanished from "those garish lights," as he called them, "for evermore." Of the three brief months that remained to him, his last book, *The Mystery of Edwin Drood*, was the chief occupation. It hardly promised to become a masterpiece (Longfellow's opinion) as did Thackeray's *Denis Duval*, but contained much fine descriptive technique, grouped round a scene of which Dickens had an unrivalled sympathetic knowledge.

In March and April 1870 Dickens, as was his wont, was mixing in the best society; he dined with the prince at Lord Houghton's and was twice at court, once at a long deferred private interview with the queen, who had given him a presentation copy of her *Leaves from a Journal of our Life in the Highlands* with the inscription "From one of the humblest of authors to one of the greatest"; and who now begged him on his persistent refusal of any other title to accept the nominal distinction of a privy councillor. He took for four months the Milner Gibsons' house at 5 Hyde Park Place, opposite the Marble Arch, where he gave a brilliant reception on the 7th of April. His last public appearance was made at the Royal Academy banquet early in May.

He returned to his regular methodical routine of work at Gad's Hill on the 30th of May, and one of the last instalments he wrote of *Edwin Drood* contained an ominous speculation as to the next two people to die at Cloisterham: "Curious to make a guess at the two, or say at one of the two." Two letters bearing the well-known superscription "Gad's Hill Place, Higham by Rochester, Kent" are dated the 8th of June, and, on the same Thursday, after a long spell of writing in the Châlet where he habitually wrote, he collapsed suddenly at dinner. Startled by the sudden change in the colour and expression of his face, his sister-in-law (Miss Hogarth) asked him if he was ill; he said "Yes, very ill," but added that he would finish dinner and go on afterwards to London. "Come and lie down," she entreated; "Yes, on the ground," he said, very distinctly; these were the last words he spoke, and he died from her arms and fell upon the floor. He died at 6-10 P.M. on Friday, the 9th of June, and was buried privately in Poets' Corner, Westminster Abbey, in the early morning of the 14th of June. One of the most appealing memorials was the drawing by his "new illustrator" Luke Fildes in the *Graphic* of "The Empty Chair; Gad's Hill: ninth of June, 1870." "Statesmen, men of science, philanthropists, the acknowledged benefactors of their race, might pass away, and yet not leave the void which will be caused by the death of Charles Dickens" (*The Times*). In his will he enjoined his friends to erect no monument in his honour, and directed his name and dates only to be inscribed on his tomb, adding this proud provision, "I rest my claim to the remembrance of my country on my published works."

Dickens had no artistic ideals worth speaking about. The sympathy of his readers was the one thing he cared about and, like Cobbett, he went straight for it through the avenue of the emotions. In personality, intensity and range of creative genius he can hardly be said to have any modern rival. His creations live, move and have their being about us constantly, like those of Homer, Virgil, Chaucer, Rabelais, Cervantes, Shakespeare, Ben Jonson, Molière and Sir Walter Scott. As to the books themselves, the backgrounds on which these mighty figures are projected, they are manifestly too vast, too chaotic and too unequal ever to become classics. Like most of the novels constructed upon the unrefined model of Smollett and Fielding, those of Dickens are enormous stock-pots into which the author casts every kind of autobiographical experience, emotion, pleasantry, anecdote, adage or apophthegm. The fusion is necessarily very incomplete and the hotch-potch is bound to fall to pieces with time. Dickens's plots, it must be admitted, are strangely unintelligible, the repetitions and stylistic decorations of his work exceed all bounds, the form is unmanageable and insignificant. The diffuseness of the English novel, in short, and its extravagant didacticism cannot fail to be most prejudicial to its perpetuation. In these circumstances there is very little fiction that will stand concentration and condensation so well as that of Dickens.

For these reasons among others our interest in Dickens's novels as integers has diminished and is diminishing. But, on the other hand, our interest and pride in him as a man and as a representative author of his age and nation has been steadily augmented and is still mounting. Much of the old criticism of his work, that it was not up to a sufficiently high level of art, scholarship or grandeur, that as an author he is given to caricature, redundancy and a shameless subservience to popular caprice, must now be discarded as irrelevant.

As regards formal excellence it is plain that Dickens labours under the double disadvantage of writing in the least disciplined of all literary genres in the most lawless literary milieu of the modern world, that of Victorian England. In spite of these defects, which are those of masters such as Rabelais, Hugo and Tolstoy, the work of Dickens is more and more instinctively felt to be true, original and ennobling. It is already beginning to undergo a process of automatic sifting, segregation and crystallization, at the conclusion of which it will probably occupy a larger segment in the literary consciousness of the English-spoken race than ever before.

Portraits of Dickens, from the gay and alert "Boz" of Samuel Lawrence, and the self-conscious, rather foppish portrait by

Maclise which served as frontispiece to *Nicholas Nickleby*, to the sketch of him as Bobadil by C. R. Leslie, the Drummond and Ary Scheffer portraits of middle age and the haggard and drawn representations of him from photographs after his shattering experiences as a public entertainer from 1856 (the year of his separation from his wife) onwards, are reproduced in Kitton, in Forster and Gissing and in the other biographies. Sketches are also given in most of the books of his successive dwelling places at Ordnance Terrace and 18 St Mary's Place, Chatham; Bayham Street, Camden Town; 15 Furnival's Inn; 48 Doughty Street; 1 Devonshire Terrace, Regent's Park; Tavistock House, Tavistock Square; and Gad's Hill Place. The manuscripts of all the novels, with the exception of the *Tale of Two Cities* and *Edwin Drood*, were given to Forster, and are now preserved in the Dyce and Forster Museum at South Kensington. The work of Dickens was a prize for which publishers naturally contended both before and after his death. The first collective edition of his works was begun in April 1847, and their number is now very great. The most complete is still that of Messrs Chapman & Hall, the original publishers of *Pickwick*; others of special interest are the Harrap edition, originally edited by F. G. Kitton; Macmillan's edition with original illustrations and introduction by Charles Dickens the younger; and the edition in the World's Classics with introductions by G. K. Chesterton. Of the translations the best known is that done into French by Lorain, Pichot and others, with B. H. Gausseron's excellent *Pages Choisies* (1903).

BIBLIOGRAPHY.—During his lifetime Dickens's biographer was clearly indicated in his guide, philosopher and friend, John Forster, who had known the novelist intimately since the days of his first triumph with *Pickwick*, who had constituted himself a veritable encyclopaedia of information about Dickens, and had clung to his subject (in spite of many rebuffs which his peremptory temper found it hard to digest) as tightly as ever Boswell had enveloped Johnson. Two volumes of Forster's *Life of Charles Dickens* appeared in 1872 and a third in 1874. He relied much on Dickens's letters to himself and produced what must always remain the authoritative work. The first two volumes are put together with much art, the portrait as a whole has been regarded as truthful, and the immediate success was extraordinary. In the opinion of Carlyle, Forster's book was not unworthy to be named after that of Boswell. A useful abridgment was carried out in 1903 by the novelist George Gissing. Gissing also wrote *Charles Dickens: A Critical Study* (1898), which ranks with G. K. Chesterton's *Charles Dickens* (1906) as a commentary inspired by deep insight and adorned by great literary talent upon the genius of the master-novelist. The names of other lives, sketches, articles and estimates of Dickens and his works would occupy a large volume in the mere enumeration. See R. H. Shepherd, *The Bibliography of Dickens* (1880); James Cooke's *Bibliography of the Writings of Charles Dickens* (1879); *Dickensiana*, by F. G. Kitton (1886); and *Bibliography* by J. P. Anderson, appended to Sir F. T. Marzials's *Life of Charles Dickens* (1887). Among the earlier sketches may be specially cited the lives by J. C. Hotten and G. A. Sala (1870), the Anecdote-Biography edited by the American R. H. Stoddard (1874), Dr A. W. Ward in the English Men of Letters Series (1878), that by Sir Leslie Stephen in the *Dictionary of National Biography*, and that by Professor Minto in the eighth edition of the *Encyclopaedia Britannica*. The letters were first issued in two volumes edited by his daughter and sister-in-law in 1880. For Dickens's connexion with Kent the following books are especially valuable:—Robert Langton's *Childhood and Youth of Charles Dickens* (1883); Langton's *Dickens and Rochester* (1880); Thomas Frost's *In Kent with Charles Dickens* (1880); F. G. Kitton's *The Dickens Country* (1905); H. S. Ward's *The Real Dickens Land* (1904); R. Allbut's *Rambles in Dickens Land* (1899 and 1903). For Dickens's reading, tour see C. Dolby's *Charles Dickens as I knew him* (1884); J. A. Fields's *In and Out of Doors with Charles Dickens* (1876); Charles Kent's *Dickens as a Reader* (1872). And for other aspects of his life see M. Dickens's *My Father as I recall him* (1897); P. H. Fitzgerald's *Life of C. Dickens as revealed in his Writings* (1905), and Bosland (1895); F. G. Kitton's *Charles Dickens, his Life, Writings and Personality* a useful compendium (1902); T. E. Pemberton's *Charles Dickens and the Stage*, and *Dickens's London* (1876); F. Mitoum's *Dickens's London* (1904); Kitton's *Dickens and his Illustrators*; W. Teignmouth Shore's *Charles Dickens and his Friends* (1904 and 1909); B. W. Matz, *Story of Dickens's Life and Work* (1904), and review of solutions to *Edwin Drood* in *The Bookman* for March 1908; the recollections of Edmund Yates, Trollope, James Payn, Lehmann, R. H. Horne, Lockwood and many others. The *Dickensian*, a magazine devoted to Dickensian subjects, was started in 1905; it is the organ of the Dickens Fellowship, and in a sense of the Box Club. A *Dickens Dictionary* (by G. A. Pierce) appeared in 1872 and 1878; another (by A. J. Philip) in 1909; and a *Dickens Concordance* by Mary Williams in 1907. (T. Sw.)

DICKINSON, ANNA ELIZABETH (1842—), American author and lecturer, was born, of Quaker parentage, at Philadelphia, Pennsylvania, on the 28th of October 1842. She was educated at the Friends' Free School in Philadelphia, and was for a time a teacher. In 1861 she obtained a clerkship in the United States mint, but was removed for criticizing General McClellan at a public meeting. She had gradually become widely known as an eloquent and persuasive public speaker, one of the first of her sex to mount the platform to discuss the burning questions of the hour. Before the Civil War she lectured on anti-slavery topics, during the war she toured the country on behalf of the Sanitary Commission, and also lectured on reconstruction, temperance and woman's rights. She wrote several plays, including *The Crown of Thorns* (1876); *Mary Tudor* (1878), in which she appeared in the title rôle; *Aurelian* (1878); and *An American Girl* (1880), successfully acted by Fanny Davenport. She also published a novel, *Which Answer?* (1868); *A Paying Investment, a Plea for Education* (1876); and *A Ragged Register of People, Places and Opinions* (1879).

DICKINSON, JOHN (1732-1808), American statesman and pamphleteer, was born in Talbot county, Maryland, on the 8th of November 1732. He removed with his father to Kent county, Delaware, in 1740, studied under private tutors, read law, and in 1753 entered the Middle Temple, London. Returning to America in 1757, he began the practice of law in Philadelphia, was speaker of the Delaware assembly in 1760, and was a member of the Pennsylvania assembly in 1762-1765 and again in 1770-1776.¹ He represented Pennsylvania in the Stamp Act Congress (1765) and in the Continental Congress from 1774 to 1776, when he was defeated owing to his opposition to the Declaration of Independence. He then retired to Delaware, served for a time as private and later as brigadier-general in the state militia, and was again a member of the Continental Congress (from Delaware) in 1779-1780. He was president of the executive council, or chief executive officer, of Delaware in 1781-1782, and of Pennsylvania in 1782-1785, and was a delegate from Delaware to the Annapolis convention of 1786 and the Federal Constitutional convention of 1787. Dickinson has aptly been called the "Penman of the Revolution." No other writer of the day presented arguments so numerous, so timely and so popular. He drafted the "Declaration of Rights" of the Stamp Act Congress, the "Petition to the King" and the "Address to the Inhabitants of Quebec" of the Congress of 1774, and the second "Petition to the King" and the "Articles of Confederation" of the second Congress. Most influential of all, however, were *The Letters of a Farmer in Pennsylvania*, written in 1767-1768 in condemnation of the Townshend Acts of 1767, in which he rejected speculative natural rights theories and appealed to the common sense of the people through simple legal arguments. By opposing the Declaration of Independence, he lost his popularity and was never able entirely to regain it. As the representative of a small state, he championed the principle of state equality in the constitutional convention, but was one of the first to advocate the compromise, which was finally adopted, providing for equal representation, in one house and proportional representation in the other. He was probably influenced by Delaware prejudice against Pennsylvania when he drafted the clause which forbids the creation of a new state by the junction of two or more states or parts of states without the consent of the states concerned as well as of congress. After the adjournment of the convention he defended its work in a series of letters signed "Fabius," which will bear comparison with the best of the Federalist productions. It was largely through his influence that Delaware and Pennsylvania were the first two states to ratify the Constitution. Dickinson's interests were not exclusively political. He helped to found Dickinson College (named in his honour) at Carlisle, Pennsylvania, in 1783, was the first president of its board of

¹Being under the same proprietor and the same governor, Pennsylvania and Delaware were so closely connected before the Revolution that there was an interchange of public men.

²The "Declaration of the United Colonies of North America . . ." setting forth the Causes and the Necessity of their Taking up Arms" (often erroneously attributed to Thomas Jefferson).

trustees, and was for many years its chief benefactor. He died on the 14th of February 1808 and was buried in the Friends' burial ground in Wilmington, Del.

See C. J. Stillé, *Life and Times of John Dickinson*, and P. L. Ford (editor), *The Writings of John Dickinson*, in vols. xiii. and xiv. respectively of the *Memoirs of the Historical Society of Pennsylvania* (Philadelphia, 1891 and 1895).

DICKSON, SIR ALEXANDER (1777-1840), British artilleryist, entered the Royal Military Academy in 1793, passing out as second lieutenant in the Royal Artillery in the following year. As a subaltern he saw service in Minorca in 1798 and at Malta in 1800. As a captain he took part in the unfortunate Montevideo Expedition of 1806-07, and in 1809 he accompanied Howorth to the Peninsular War as brigade-major of the artillery. He soon obtained a command in the Portuguese artillery, and as a lieutenant-colonel of the Portuguese service took part in the various battles of 1810-11. At the two sieges of Budazoz, Ciudad Rodrigo, the Salamanca forts and Burgos, he was entrusted by Wellington (who had the highest opinion of him) with most of the detailed artillery work, and at Salamanca battle he commanded the reserve artillery. In the end he became commander of the whole of the artillery of the allied army, and though still only a substantive captain in the British service he had under his orders some 8000 men. At Vitoria, the Pyrenees battles and Toulouse he directed the movements of the artillery engaged, and at the end of the war received handsome presents from the officers who had served under him, many of whom were his seniors in the army list. He was at the disastrous affair of New Orleans, but returned to Europe in time for the Waterloo campaign. He was present at Quatre Bras and Waterloo on the artillery staff of Wellington's army, and subsequently commanded the British battering train at the sieges of the French fortresses left behind the advancing allies. For the rest of his life he was on home service, principally as a staff officer of artillery. He died, a major-general and G.C.B., in 1840. A memorial was erected at Woolwich in 1847. Dickson was one of the earliest fellows of the Royal Geographical Society.

His diaries kept in the Peninsula were the main source of information used in Duncan's *History of the Royal Artillery*.

DICKSON, SIR JAMES ROBERT (1832-1901), Australian statesman, was born in Plymouth on the 30th of November 1832. He was brought up in Glasgow, receiving his education at the high school, and became a clerk in the City of Glasgow Bank. In 1854 he emigrated to Victoria, but after some years spent in that colony and in New South Wales, he settled in 1862 in Queensland, where he was connected with many important business enterprises, among them the Royal Bank of Queensland. He entered the Queensland House of Assembly in 1872, and became minister of works (1876), treasurer (1876-1879, and 1883-1887), acting premier (1884), but resigned in 1887 on the question of taxing land. In 1889 he retired from business, and spent three years in Europe before resuming political life. He fought for the introduction of Polynesian labour on the Queensland sugar plantations at the general election of 1892, and was elected to the House of Assembly in that year and again at the elections of 1893 and 1896. He became secretary for railways in 1897, minister for home affairs in 1898, represented Queensland in the federal council of Australia in 1896 and at the postal conference at Hobart in 1898, and in 1898 became premier. His energies were now devoted to the formation of an Australian commonwealth. He secured the reference of the question to a plebiscite, the result of which justified his anticipations. He resigned the premiership in November 1899, but in the ministry of Robert Philp, formed in the next month, he was reappointed to the offices of chief secretary and vice-president of the executive council which he had combined with the office of premier. He represented Queensland in 1900 at the conference held in London to consider the question of Australian unity, and on his return was appointed minister of defence in the first government of the Australian Commonwealth. He did not long survive the accomplishment of his political aims, dying at Sydney on the 10th of January 1901, in the midst of the festivities attending the inauguration of the new state.

DICOTYLEDONS, in botany, the larger of the two great classes of angiosperms, embracing most of the common flower-bearing plants. The name expresses the most universal character of the class, the importance of which was first noticed by John Ray, namely, the presence of a pair of seed-leaves or cotyledons, in the plantlet or embryo contained in the seed. The embryo is generally surrounded by a larger or smaller amount of foodstuff (endosperm) which serves to nourish it in its development to form a seedling when the seed germinates; frequently, however, as in pea or bean and their allies, the whole of the nourishment for future use is stored up in the cotyledons themselves, which then become thick and fleshy. In germination of the seed the root of the embryo (radicle) grows out to get a holdfast for the plant; this is generally followed by the growth of the short stem immediately above the root, the so-called "hypocotyl," which carries up the cotyledons above the ground, where they spread to the light and become the first green leaves of the plant. Protected between the cotyledons and terminating the axis of the plant is the first stem-bud (the plumule of the embryo), by the further growth and development of which the aerial portion of the plant, consisting of stem, leaves and branches, is formed, while the development of the radicle forms the root-system. The size and manner of growth of the adult plant show a great variety, from the small herb lasting for one season only, to the forest tree living for centuries. The arrangement of the conducting tissue in the stem is characteristic; a transverse section of the very young stem shows a number of distinct conducting strands—vascular bundles—arranged in a ring round the pith; these soon become united to form a closed ring of bast and wood, separated by a layer of formative tissue (cambium). In perennials the stem shows a regular increase in thickness each year by the addition of a new ring of wood outside the old one—for details of structure see PLANTS: *Anatomy*. A similar growth occurs in the root. This increase in the diameter of stem and root is correlated with the increase in leaf-area each season, due to the continued production of new leaf-bearing branches. A characteristic of the class is afforded by the complicated network formed by the leaf-veins,—well seen in a skeleton leaf, from which the soft parts have been removed by maceration. The parts of the flower are most frequently arranged in fives, or multiples of fives; for instance, a common arrangement is as follows,—five sepals, succeeded by five petals, ten stamens in two sets of five, and five or fewer carpels; an arrangement in fours is less frequent, while the arrangement in threes, so common in monocotyledons, is rare in dicotyledons. In some orders the parts are numerous, chiefly in the case of the stamens and the carpels, as in the buttercup and other members of the order Ranunculaceae. There is a very wide range in the general structure and arrangement of the parts of the flower, associated with the means for ensuring the transference of pollen; in the simplest cases the flower consists only of a few stamens or carpels, with no enveloping sepals or petals, as in the willow, while in the more elaborate type each series is represented, the whole forming a complicated structure closely correlated with the size, form and habits of the pollinating agent (see FLOWER). The characters of the fruit and seed and the means for ensuring the dispersal of the seeds are also very varied (see FRUIT).

DICTATOR (from the Lat. *dicere*, frequentative of *dicere*, to speak). In modern usage this term is loosely used for a personal ruler enjoying extraordinary and extra-constitutional power. The etymological sense of one who "dictates"—i.e. one whose word (*dictum*) is law (from which that of one who "dictates," i.e. speaks for some writer to record, is to be distinguished)—has been assisted by the historical use of the term, in ancient times, for an extraordinary magistrate in the Roman commonwealth. It is unknown precisely how the Roman word came into use, though an explanation of the earlier official title, *magister populi*, throws some light on the subject. That designation may mean "head of the (infantry) host" as opposed to his subordinate, the *magister equitum*, who was "head of the cavalry." If this explanation be accepted, emphasis was thus laid in early times on the military aspect of the dictatorship, and in fact the office seems to

have been instituted for the purpose of meeting a military crisis such as might have proved too serious for the annual consuls with their divided command. Later constitutional theory held that the repression of civil discord was also one of the motives for the institution of a dictatorship. Such is the view expressed by Cicero in the *De legibus* (iii. 3, 9) and by the emperor Claudius in his extant *Oratio* (i. 28). This function of the office, although it may not have been contemplated at first, is attested by the internal history of Rome. In the crisis of the agitation that gathered round the Licinian laws (367 B.C.) a dictator was appointed, and in 314 B.C. we have the notice of a dictator created for purposes of criminal jurisdiction (*quaestionibus exercendis*). The dictator appointed to meet the dangers of war, sedition or crime was technically described as "the administrative dictator" (*rei gerundae causa*). Minor, or merely formal, needs of the state might lead to the creation of other types of this office. Thus we find dictators destined to hold the elections, to make out the list of the senate, to celebrate games, to establish festivals, and to drive the nail into the temple of Jupiter—an act of natural magic which was believed to avert pestilence. These dictators appointed for minor purposes were expected to retire from office as soon as their function was completed. The "administrative dictator" held office for at least six months.

The powers of a dictator were a temporary revival of those of the kings; but there were some limitations to his authority. He was never concerned with civil jurisdiction, and was dependent on the senate for supplies of money. His military authority was confined to Italy; and his power of life and death over the citizens was at an early period limited by law. It was probably the *lex Valeria* of 300 B.C. that made him subject to the right of criminal appeal (*provocatio*) within the limits of the city. But during his tenure of power all the magistracies of the people were regarded as his subordinates; and it was even held that the right of assistance (*auxilium*), furnished by the tribunes of the plebs to members of the citizen body, should not be effectively exercised when the state was under this type of martial law. The dictator was nominated by one of the consuls. But here as elsewhere the senate asserted its authority over the magistracies, and the view was finally held that the senate should not only suggest the need of nomination but also the name of the nominee. After the nomination, the imperium of the dictator was confirmed by a *lex curiata* (see COMITIA). To emphasize the superiority of this imperium over that of the consuls, the dictator might be preceded by twenty-four lictors, not by the usual twelve; and, at least in the earlier period of the office, these lictors bore the axes, the symbols of life and death, within the city walls.

Tradition represents the dictatorship as having a life of three centuries in the history of the Roman state. The first dictator is said to have been created in 501 B.C.; the last of the "administrative" dictators belongs to the year 216 B.C. It was an office that was incompatible both with the growing spirit of constitutionalism and with the greater security of the city; and the epoch of the Second Punic War was marked by experiments with the office, such as the election of Q. Fabius Maximus by the people, and the co-dictatorship of M. Minucius with Fabius, which heralded its disuse (see PUNIC WARS). The emergency office of the early and middle Republic has few points of contact, except those of the extraordinary position and almost unfettered authority of its holder, with the dictatorship as revised by Sulla and by Caesar. Sulla's dictatorship was the form taken by a provisional government. He was created "for the establishment of the Republic." It is less certain whether the dictatorships held by Caesar were of a consciously provisional character. Since the office represented the only supreme *Imperium* in Rome, it was the natural resort of the founder of a monarchy (see SULLA and CAESAR). Ostensibly to prevent its further use for such a purpose, M. Antonius in 44 B.C. carried a law abolishing the dictatorship as a part of the constitution.

BIBLIOGRAPHY.—Mommson, *Römisches Staatsrecht*, ii. 141 foll. (3rd ed., Leipzig, 1887); Herzog, *Geschichte und System der römischen Staatsverfassung*, i. 718 foll. (Leipzig, 1884); Pauly-Wissowa, *Realencyclopädie*, v. 370 foll. (new edition, Stuttgart, 1893, &c.);

Lange, *Römische Alterthümer*, i. 542 foll. (Berlin, 1856, &c.); Daremberg-Saglio, *Dictionnaire des antiquités grecques et romaines*, ii. 161 foll. (1875, &c.); Haverfield, "The Abolition of the Dictatorship," in *Classical Review*, iii. 77.

DICTIONARY. In its proper and most usual meaning a dictionary is a book containing a collection of the words of a language, dialect or subject, arranged alphabetically or in some other definite order, and with explanations in the same or some other language. When the words are few in number, being only a small part of those belonging to the subject, or when they are given without explanation, or some only are explained, or the explanations are partial, the work is called a *vocabulary*; and when there is merely a list of explanations of the technical words and expressions in some particular subject, a *glossary*. An alphabetical arrangement of the words of some book or author with references to the places where they occur is called an *index (q.v.)*. When under each word the phrases containing it are added to the references, the work is called a *concordance*. Sometimes, however, these names are given to true dictionaries; thus the great Italian dictionary of the *Accademia della Crusca*, in six volumes folio, is called *Vocabolario*, and Ernesti's dictionary to Cicero is called *Index*. When the words are arranged according to a definite system of classification under heads and subdivisions, according to their nature or their meaning, the book is usually called a *classified vocabulary*; but when sufficient explanations are given it is often accepted as a dictionary, like the *Onomasticum* of Julius Pollux, or the native dictionaries of Sanskrit, Manchu and many other languages.

Dictionaries were originally books of reference explaining the words of a language or of some part of it. As the names of things, as well as those of persons and places, are words, and often require explanation even more than other classes of words, they were necessarily included in dictionaries, and often to a very great extent. In time, books were devoted to them alone, and were limited to special subjects, and these have so multiplied, that dictionaries of things now rival in number and variety those of words or of languages, while they often far surpass them in bulk. There are dictionaries of biography and history, real and fictitious, general and special, relating to men of all countries, characters and professions; the English *Dictionary of National Biography* (see *BIOGRAPHY*) is a great instance of one form of these; dictionaries of bibliography, relating to all books, or to those of some particular kind or country; dictionaries of geography (sometimes called *gazetteers*) of the whole world, of particular countries, or of small districts, of towns and of villages, of castles, monasteries and other buildings. There are dictionaries of philosophy; of the Bible; of mathematics; of natural history, zoology, botany; of birds, trees, plants and flowers; of chemistry, geology and mineralogy; of architecture, painting and music; of medicine, surgery, anatomy, pathology and physiology; of diplomacy; of law, canon, civil, statutory and criminal; of political and social sciences; of agriculture, rural economy and gardening; of commerce, navigation, horsemanship and the military arts; of mechanics, machines and the manual arts. There are dictionaries of antiquities, of chronology, of dates, of genealogy, of heraldry, of diplomats, of abbreviations, of useful receipts, of monograms, of adulterations and of very many other subjects. These works are separately referred to in the bibliographies attached to the articles on the separate subjects. And lastly, there are dictionaries of the arts and sciences, and their comprehensive offspring, *encyclopaedias (q.v.)*, which include in themselves every branch of knowledge. Neither under the heading of *dictionary* nor under that of *encyclopaedia* do we propose to include a mention of every work of its class, but many of these will be referred to in the separate articles on the subjects to which they pertain. And in this article we confine ourselves to an account of those dictionaries which are primarily word-books. This is practically the most convenient distinction from the subject-book or encyclopaedia; though the two characters are often combined in one work. Thus the *Century Dictionary* has encyclopaedic features, while the present edition of the *Encyclopaedia Britannica*, restoring its

earlier tradition but carrying out the idea more systematically, also embodies dictionary features.

Dictionarium is a word of low or modern Latinity;¹ *dictio*, from which it was formed, was used in medieval Latin to mean a word. *Lexicon* is a corresponding word of Greek origin, meaning a book of or for words—a dictionary. A *glossary* is properly a collection of unusual or foreign words requiring explanation. It is the name frequently given to English dictionaries of dialects, which the Germans usually call *idioticon*, and the Italians *vocabolario*. *Wörterbuch*, a book of words, was first used among the Germans, according to Grimm, by Kramer (1719), imitated from the Dutch *woordenboek*. From the Germans the Swedes and Danes adopted *ordbok*, *ordbog*. The Icelandic *ordabók*, like the German, contains the genitive plural. The Slavonic nations use *словар*, *словник*, and the southern Slavs *ryetshnik*, from *слово*, *ryetsh*, a word, formed, like dictionary and lexicon, without composition. Many other names have been given to dictionaries, as *thesaurus*, *Sprachschatz*, *cornucopia*, *gazophylacium*, *comprehensorium*, *catholicon*, to indicate their completeness; *manipulus predicantium*, *promptorium puerorum*, *liber memorialis*, *hortus vocabulorum*, *ionis* (a violet bed), *alveary* (a beehive), *kammos* (the sea), *haft kulzum* (the seven seas), *tsze tien* (a standard of character), *onomasi-con*, *nomenclator*, *bibliotheca*, *elucidario*, *Mundart-sammlung*, *clavis*, *scala*, *pharetra*.² *La Crusca* from the great Italian dictionary, and *Calepino* (in Spanish and Italian) from the Latin dictionary of Calepino.

The tendency of great dictionaries is to unite in themselves all the peculiar features of special dictionaries. A large dictionary is most useful when a word is to be thoroughly studied, or when there is difficulty in making out the meaning of a word or phrase. Special dictionaries are more useful for special purposes; for instance, synonyms are best studied in a dictionary of synonyms. And small dictionaries are more convenient for frequent use, as in translating from an unfamiliar language, for words may be found more quickly, and they present the words and their meanings in a concentrated and compact form, instead of being scattered over a large space, and separated by other matter. Dictionaries of several languages, called *polyglots*, are of different kinds. Some are polyglot in the vocabulary, but not in the explanation, like Johnson's dictionary of Persian and Arabic explained in English; some in the interpretation, but not in the vocabulary or explanation, like *Colepini octoglotton*, a Latin dictionary of Latin, with the meanings in seven languages. Many great dictionaries are now polyglot in this sense. Some are polyglot in the vocabulary and interpretation, but are explained in one language, like Jall's *Glossaire nautique*, a glossary of sea terms in many languages, giving the equivalents of each word in the other languages, but the explanation in French. Pauthier's *Annamese Dictionary* is polyglot in a peculiar way. It gives the Chinese characters with their pronunciation in Chinese and Annamese. Special dictionaries are of many kinds. There are technical dictionaries of etymology, foreign words, dialects, secret languages, slang, neology, barbarous words, faults of expression, choice words, prosody, pronunciation, spelling, orators, poets, law, music, proper names, particular authors, nouns, verbs, participles, particles, double forms, difficulties and many others. Fick's dictionary (Göttingen, 1868, 8vo; 1874-1876, 8vo, 4 vols.) is a remarkable attempt to ascertain the common language of the Indo-European nations before each of their great separations. In the second edition of his *Etymologische Forschungen* (Lemgo and Detmoldt, 1859-1873, 8vo, 7217 pages) Pott gives a comparative lexicon of Indo-European roots, 2226 in number, occupying 5140 pages.

¹ Joannes de Garlandia (John Garland; fl. 1200-1250) gives the following explanation in his *Dictionarius*, which is a *classified vocabulary*:—"Dictionarius dicitur libellus iste a dictionibus magis necessariis, quas tenet quilibet scolaris, non tantum in scrinio de lignis factis, sed in cordis armorio firmiter retinere." This has been supposed to be the first use of the word.

² An excellent dictionary of quotations, perhaps the first of the kind; a large folio volume printed in Strassburg about 1475 is entitled "Pharetra auctoritates et dicta doctorum, philoophorum, et poetarum continens."

At no time was progress in the making of general dictionaries so rapid as during the second half of the 19th century. It is to be seen in three things: in the perfecting of the theory of what *Method*: a general dictionary should be; in the elaboration of methods of collecting and editing lexicographic materials; and in the magnitude and improved quality of the work which has been accomplished or planned. Each of these can best be illustrated from English lexicography, in which the process of development has in all directions been carried farthest. The advance that has been made in theory began with a radical change of opinion with regard to the chief end of the general dictionary of a language. The older view of the matter was that the lexicographer should furnish a standard of usage—should register only those words which are, or at some period of the language have been, "good" from a literary point of view, with their "proper" senses and uses, or should at least furnish the means of determining what these are. In other words, his chief duty was conceived to be to sift and refine, to decide authoritatively questions with regard to good usage, and thus to fix the language as completely as might be possible within the limits determined by the literary taste of his time. Thus the *Accademia della Crusca*, founded near the close of the 16th century, was established for the purpose of purifying in this way the Italian tongue, and in 1612 the *Vocabolario degli Accademici della Crusca*, long the standard of that language, was published. The *Académie Française*, the first edition of whose dictionary appeared in 1604, had a similar origin. In England the idea of constructing a dictionary upon this principle arose during the second quarter of the 18th century. It was imagined by men of letters—among them Alexander Pope—that the English language had then attained such perfection that further improvement was hardly possible, and it was feared that if it were not fixed by lexicographic authority deterioration would soon begin. Since there was no English "Academy," it was necessary that the task should fall to some one whose judgment would command respect, and the man who undertook it was Samuel Johnson. His dictionary, the first edition of which, in two folio volumes, appeared in 1755, was in many respects admirable, but it was inadequate even as a standard of the then existing literary usage. Johnson himself did not long entertain the belief that the natural development of a language can be arrested in that or in any other way. His work was, however, generally accepted as a final authority, and the ideas upon which it was founded dominated English lexicography for more than a century. The first effective protest in England against the supremacy of this literary view was made by Dean (later Archbishop) Trench, in a paper on "Some Deficiencies in Existing English Dictionaries" read before the Philological Society in 1857. "A dictionary," he said, "according to that idea of it which seems to me alone capable of being logically maintained, is an *inventory of the language*; much more, but this primarily. . . . It is no task of the maker of it to select the *good words* of the language. . . . The business which he has undertaken is to collect and arrange *all words*, whether good or bad, whether they commend themselves to his judgment or otherwise. . . . *He is an historian of [the language], not a critic.*" That is, for the literary view of the chief end of the general dictionary should be substituted the philological or scientific. In Germany this substitution had already been effected by Jacob and Wilhelm Grimm in their dictionary of the German language, the first volume of which appeared in 1854. In brief, then, the modern view is that the general dictionary of a language should be a record of all the words—current or obsolete—of that language, with all their meanings and uses, but should not attempt to be, except secondarily or indirectly, a guide to "good" usage. A "standard" dictionary has, in fact, been recognized to be an impossibility, if not an absurdity.

This theoretical requirement must, of course, be modified considerably in practice. The date at which a modern language is to be regarded by the lexicographer as "beginning" must, as a rule, be somewhat arbitrarily chosen; while considerable portions of its earlier vocabulary cannot be recovered because of the incompleteness of the literary record. Moreover, not even

the most complete dictionary can include all the words which the records—earlier and later—actually contain. Many words, that is to say, which are found in the literature of a language cannot be regarded as, for lexicographic purposes, belonging to that language; while many more may or may not be held to belong to it, according to the judgment—almost the whim—of the individual lexicographer. This is especially true of the English tongue. "That vast aggregate of words and phrases which constitutes the vocabulary of English-speaking men presents, to the mind that endeavours to grasp it as a definite whole, the aspect of one of those nebulous masses familiar to the astronomer, in which a clear and unmistakable nucleus shades off on all sides, through zones of decreasing brightness, to a dim marginal film that seems to end nowhere, but to lose itself imperceptibly in the surrounding darkness" (Dr J. A. H. Murray, *Oxford Dict. General Explanations*, p. xvii). This "marginal film" of words with more or less doubtful claims to recognition includes thousands of the terms of the natural sciences (the New-Latin classificatory names of zoology and botany, names of chemical compounds and of minerals, and the like); half-naturalized foreign words; dialectal words; slang terms; trade name (many of which have passed or are passing into common use) proper names and many more. Many of these even the most complete dictionary should exclude; others it should include; but where the line shall be drawn will always remain a vexed question.

Another important principle upon which Trench insisted, and which also expresses a requirement of modern scientific philology, is that the dictionary shall be not merely a record, but also an *historical* record of words and their uses. From the literary point of view the most important thing is present usage. To that alone the idea of a "standard" has any application. Dictionaries of the older type, therefore, usually make the common, or "proper" or "root" meaning of a word the starting point of its definition, and arrange its other senses in a logical or accidental order commonly ignoring the historical order in which the various meanings arose. Still less do they attempt to give data from which the vocabulary of the language at any previous period may be determined. The philologist, however, for whom the growth, or progressive alteration, of a language is a fact of central importance, regards no record of a language as complete which does not exhibit this growth in its successive stages. He desires to know when and where each word, and each form and sense of it, are first found in the language; if the word or sense is obsolete, when it died; and any other fact that throws light upon its history. He requires, accordingly, of the lexicographer that, having ascertained these data, he shall make them the foundation of his exposition—in particular, of the division and arrangement of his definitions, that sense being placed first which appeared first in order of time. In other words, each article in the dictionary should furnish an orderly biography of the word of which it treats, each word and sense being so dated that the exact time of its appearance and the duration of its use may as nearly as possible be determined. This, in principle, is the method of the new lexicography. In practice it is subject to limitations similar to those of the vocabulary mentioned above. Incompleteness of the early record is here an even greater obstacle; and there are many words whose history is, for one reason or another, so unimportant that to treat it elaborately would be a waste of labour and space.

The adoption of the historical principle involves a further noteworthy modification of older methods, namely, an important extension of the use of quotations. To Dr Johnson belongs the credit of showing how useful, when properly chosen, they may be, not only in corroborating the lexicographer's statements, but also in revealing special shades of meaning or variations of use which his definitions cannot well express. No part of Johnson's work is more valuable than this. This idea was more fully developed and applied by Dr Charles Richardson, whose *New Dictionary of the English Language* . . . *Illustrated by Quotations from the Best Authors* (1835-1836) still remains a most valuable collection of literary illustrations. Lexicographers, however, have, with

few exceptions, until a recent date, employed quotations chiefly for the ends just mentioned—as instances of use or as illustrations of correct usage—with scarcely any recognition of their value as historical evidence; and they have taken them almost exclusively from the works of the "best" authors. But since all the data upon which conclusions with regard to the history of a word can be based must be collected from the literature of the language, it is evident that, in so far as the lexicographer is required to furnish evidence for an historical inference, a quotation is the best form in which he can give it. In fact, extracts, properly selected and grouped, are generally sufficient to show the entire meaning and biography of a word without the aid of elaborate definitions. The latter simply save the reader the trouble of drawing the proper conclusions for himself. A further rule of the new lexicography, accordingly, is that quotations should be used, primarily, as historical evidence, and that the history of words and meanings should be exhibited by means of them. The earliest instance of use that can be found, and (if the word or sense is obsolete) the latest, are as a rule to be given; while in the case of an important word or sense, instances taken from successive periods of its currency also should be cited. Moreover, a quotation which contains an important bit of historical evidence must be used, whether its source is "good," from the literary point of view, or not—whether it is a classic of the language or from a daily newspaper; though where choice is possible, preference should, of course, be given to quotations extracted from the works of the best writers. This rule does not do away with the illustrative use of quotations, which is still recognized as highly important, but it subordinates it to their historical use. It is necessary to add that it implies that the extracts must be given exactly, and in the original spelling and capitalization, accurately dated, and furnished with a precise reference to author, book, volume, page and edition; for insistence upon these requirements—which are obviously important, whatever the use of the quotation may be—is one of the most noteworthy of modern innovations. Johnson usually gave simply the author's name, and often quoted from memory and inaccurately; and many of his successors to this day have followed—altogether or to some extent—his example.

The chief difficulty in the way of this use of quotations—after the difficulty of collection—is that of finding space for them in a dictionary of reasonable size. Preference must be given to those which are essential, the number of those which are cited merely on methodical grounds being made as small as possible. It is hardly necessary to add that the negative evidence furnished by quotations is generally of little value; one can seldom, that is, be certain that the lexicographer has actually found the earliest or the latest use, or that the word or sense has not been current during some intermediate period from which he has no quotations.

Lastly, a much more important place in the scheme of the ideal dictionary is now assigned to the *etymology* of words. This may be attributed, in part, to the recent rapid development of etymology as a science, and to the greater abundance of trustworthy data; but it is chiefly due to the fact that from the historical point of view the connexion between that section of the biography of a word which lies within the language—subsequent, that is, to the time when the language may, for lexicographical purposes, be assumed to have begun, or to the time when the word was adopted or invented—and its antecedent history, has become more vital and interesting. Etymology, in other words, is essentially the history of the *form* of a word up to the time when it became a part of the language, and is, in a measure, an extension of the history of the development of the word in the language. Moreover, it is the only means by which the exact relations of allied words can be ascertained, and the separation of words of the same form but of diverse origin (homonyms) can be effected, and is thus, for the dictionary, the foundation of all *family history* and correct *genealogy*. In fact, the attention that has been paid to these two points in the best recent lexicography is one of its distinguishing and most important characteristics. Related to the etymology of words are the changes in their form which may have occurred while they have been in use as parts of the language

—modifications of their pronunciation, corruptions by popular etymology or false associations, and the like. The facts with regard to these things which the wide research necessitated by the historical method furnishes abundantly to the modern lexicographer are often among the most novel and interesting of his acquisitions.

It should be added that even approximate conformity to the theoretical requirements of modern lexicography as above outlined is possible only under conditions similar to those under which the Oxford *New English Dictionary* was undertaken (see below). The labour demanded is too vast, and the necessary bulk of the dictionary too great. When, however, a language is recorded in one such dictionary, those of smaller size and more modest pretensions can rest upon it as an authority and conform to it as a model so far as their special limitations permit.

The ideal thus developed is primarily that of the general dictionary of the purely philological type, but it applies also to the encyclopaedic dictionary. In so far as the latter is strictly lexicographic—deals with words as words, and not with the things they denote—it should be made after the model of the former, and is defective to the extent in which it deviates from it. The addition of encyclopaedic matter to the philological in no way affects the general principles involved. It may, however, for practical reasons, modify their application in various ways. For example, the number of obsolete and dialectal words included may be much diminished and the number of scientific terms (for instance, new Latin botanical and zoological names) be increased; and the relative amount of space devoted to etymologies and quotations may be lessened. In general, since books of this kind are designed to serve more or less as works of general reference, the making of them must be governed by considerations of practical utility which the compilers of a purely philological dictionary are not obliged to regard. The encyclopaedic type itself, although it has often been criticized as hybrid—as a mixture of two things which should be kept distinct—is entirely defensible. Between the dictionary and the encyclopaedia the dividing line cannot sharply be drawn. There are words the meaning of which cannot be explained fully without some description of things, and, on the other hand, the description of things and processes often involves the definition of names. To the combination of the two objection cannot justly be made, so long as it is effected in a way—with a selection of material—that leaves the dictionary essentially a dictionary and not an encyclopaedia. Moreover, the large vocabulary of the general dictionary makes it possible to present certain kinds of encyclopaedic matter with a degree of fulness and a convenience of arrangement which are possible in no single work of any other class. In fact, it may be said that if the encyclopaedic dictionary did not exist it would have to be invented; that its justification is its indispensableness. Not the least of its advantages is that it makes legitimate the use of diagrams and pictorial illustrations, which, if properly selected and executed, are often valuable aids to definition.

On its practical side the advance in lexicography has consisted in the elaboration of methods long in use rather than in the invention of new ones. The only way to collect the data upon which the vocabulary, the definitions and the history are to be based is, of course, to search for them in the written monuments of the language, as all lexicographers who have not merely borrowed from their predecessors have done. But the wider scope and special aims of the new lexicography demand that the investigation shall be vastly more comprehensive, systematic and precise. It is necessary, in brief, that, as far as may be possible, the literature (of all kinds) of every period of the language shall be examined systematically, in order that all the words, and senses and forms of words, which have existed during any period may be found, and that enough excerpts (carefully verified, credited and dated) to cover all the essential facts shall be made. The books, pamphlets, journals, newspapers, and so on which must thus be searched will be numbered by thousands, and the quotations selected may (as in the case of the Oxford *New English Dictionary*) be counted by millions. This task is beyond the powers of any one man, even though he be a Johnson, or a Littré or a Grimm, and it is now

assigned to a corps of readers whose number is limited only by the ability of the editor to obtain such assistance. The modern method of editing the material thus accumulated—the actual work of compilation—also is characterized by the application of the principle of the division of labour. Johnson boasted that his dictionary was written with but little assistance from the learned, and the same was in large measure true of that of Littré. Such attempts on the part of one man to write practically the whole of a general dictionary are no longer possible, not merely because of the vast labour and philological research necessitated by modern aims, but more especially because the immense development of the vocabulary of the special sciences renders indispensable the assistance, in the work of definition, of persons who are expert in those sciences. The tendency, accordingly, has been to enlarge greatly the editorial staff of the dictionary, scores of sub-editors and contributors being now employed where a dozen or fewer were formerly deemed sufficient. In other words, the making of a "complete" dictionary has become a co-operative enterprise, to the success of which workers in all the fields of literature and science contribute.

The most complete exemplification of these principles and methods is the Oxford *New English Dictionary*, on historical principles, founded mainly on materials collected by the *Philological Society*. This monumental work originated in the suggestion of Trench that an attempt should be made, under the direction of the Philological Society, to complete the vocabulary of existing dictionaries and to supply the historical information which they lacked. The suggestion was adopted, considerable material was collected, and Mr Herbert Coleridge was appointed general editor. He died in 1861, and was succeeded by Dr F. J. Furnivall. Little, however, was done, beyond the collection of quotations—about 2,000,000 of which were gathered—until in 1878 the expense of printing and publishing the proposed dictionary was assumed by the Delegates of the University Press, and the editorship was entrusted to Dr (afterwards Sir) J. A. H. Murray. As the historical point of beginning, the middle of the 12th century was selected, all words that were obsolete at that date being excluded, though the history of words that were current both before and after that date is given in its entirety; and it was decided that the search for quotations—which, according to the original design, was to cover the entire literature down to the beginning of the 16th century and as much of the subsequent literature (especially the works of the more important writers and works on special subjects) as might be possible—should be made more thorough. More than 800 readers, in all parts of the world, offered their aid, and when the preface to the first volume appeared in 1888, the editor was able to announce that the readers had increased to 1300, and that 3,500,000 of quotations, taken from the writings of more than 5000 authors, had already been amassed. The whole work was planned to be completed in ten large volumes, each issued first in smaller parts. The first part was issued in 1884, and by the beginning of 1910 the first part of the letter S had been reached.

The historical method of exposition, particularly by quotations, is applied in the *New English Dictionary*, if not in all cases with entire success, yet, on the whole, with a regularity and a precision which leave little to be desired. A minor fault is that excerpts from second or third rate authors have occasionally been used where better ones from writers of the first class either must have been at hand or could have been found. As was said above, the literary quality of the question is highly important even in historical lexicography, and should not be neglected unnecessarily. Other special features of the book are the completeness with which variations of pronunciation and orthography (with dates) are given; the fulness and scientific excellence of the etymologies, which abound in new information and corrections of old errors; the phonetic precision with which the present (British) pronunciation is indicated; and the elaborate subdivision of meanings. The definitions as a whole are marked by a high degree of accuracy, though in a certain number of cases not explicable by the date of the volumes) the lists of meanings are not so good as one would expect, as compared (say) with

the *Century Dictionary*. Work of such magnitude and quality is possible, practically, only when the editor of the dictionary can command not merely the aid of a very large number of scholars and men of science, but their gratuitous aid. In this the *New English Dictionary* has been singularly fortunate. The conditions under which it originated, and its aim, have interested scholars everywhere, and led them to contribute to the perfecting of it their knowledge and time. The long list of names of such helpers in Sir J. A. H. Murray's preface is in curious contrast with their absence from Dr Johnson's and the few which are given in that of Littré. The editor's principal assistants were Dr Henry Bradley and Dr W. A. Craigie. Of the dictionary as a whole it may be said that it is one of the greatest achievements, whether in literature or science, of modern English scholarship and research.

The *New English Dictionary* furnishes for the first time data from which the extent of the English word-store at any given period, and the direction and rapidity of its growth, can fairly be estimated. For this purpose the materials furnished by the older dictionaries are quite insufficient, on account of their incompleteness and unhistorical character. For example 100 pages of the *New English Dictionary* (from the letter H) contain 1002 words, of which, as the dated quotations show, 585 were current in 1750 (though some, of course, were very rare, some dialectal, and so on), 191 were obsolete at that date, and 226 have since come into use. But of the more than 700 words—current or obsolete—which Johnson might thus have recorded, he actually did record only about 300. Later dictionaries give more of them, but they in no way show their status at the date in question. It is worth noting that the figures given seem to indicate that not very many more words have been added to the vocabulary of the language during the past 150 years than had been lost by 1750. The pages selected, however, contain comparatively few recent scientific terms. A broader comparison would probably show that the gain has been more than twice as great as the loss.

In the *Deutsches Wörterbuch* of Jacob and Wilhelm Grimm the scientific spirit, as was said above, first found expression in general lexicography. The desirability of a complete inventory and investigation of German words was recognized by Leibnitz and by various 18th-century scholars, but the plan and methods of the Grimms were the direct product of the then new scientific philology. Their design, in brief, was to give an exhaustive account of the words of the literary language (New High German) from about the end of the 15th century, including their earlier etymological and later history, with references to important dialectal words and forms; and to illustrate their use and history abundantly by quotations. The first volume appeared in 1854. Jacob Grimm (died 1863) edited the first, second (with his brother, who died in 1859), third and a part of the fourth volumes; the others have been edited by various distinguished scholars. The scope and methods of this dictionary have been broadened somewhat as the work has advanced. In general it may be said that it differs from the *New English Dictionary* chiefly in its omission of pronunciations and other pedagogic matter; its irregular treatment of dates; its much less systematic and less lucid statement of etymologies; its less systematic and less fruitful use of quotations; and its less convenient and less intelligible arrangement of material and typography.

These general principles lie also at the foundation of the scholarly *Dictionnaire de la langue française* of E. Littré, though they are there carried out less systematically and less completely. In the arrangement of the definitions the first place is given to the most primitive meaning of the word instead of to the most common one, as in the dictionary of the Academy; but the other meanings follow in an order that is often logical rather than historical. Quotations also are frequently used merely as literary illustrations, or are entirely omitted; in the special paragraphs on the history of words before the 16th century, however, they are put to a strictly historical use. This dictionary—perhaps the greatest ever compiled by one man—was published 1863–1872. (Supplement, 1878.)

The *Thesaurus Linguae Latinae*, prepared under the auspices of the German Academies of Berlin, Göttingen, Leipzig, Munich and Vienna, is a notable application of the principles and practical co-operative method of modern lexicography to the classical tongues. The plan of the work is to collect quotations which shall register, with its full context, every word (except

the most familiar particles) in the text of each Latin author down to the middle of the 2nd century A.D., and to extract all important passages from all writers of the following centuries down to the 7th; and upon these materials to found a complete historical dictionary of the Latin language. The work of collecting quotations was begun in 1894, and the first part of the first volume has been published.

In the making of all these great dictionaries (except, of course, the last) the needs of the general public as well as those of scholars have been kept in view. But the type to which the general dictionary designed for popular use has tended more and more to conform is the *encyclopaedic*. This combination of lexicon and encyclopaedia is exhibited in an extreme—and theoretically objectionable—form in the *Grand dictionnaire universel du XIX^e siècle* of Pierre Larousse. Besides common words and their definitions, it contains a great many proper names, with a correspondingly large number of biographical, geographical, historical and other articles, the connexion of which with the strictly lexicographical part is purely mechanical. Its utility, which—notwithstanding its many defects—is very great, makes it, however, a model in many respects. Fifteen volumes were published (1866–1876), and supplements were brought out later (1878–1890). The *Nouveau Larousse illustré* started publication in 1901, and was completed in 1904 (7 vols.). This is not an abridgment or a fresh edition of the *Grand Dictionnaire* of Pierre Larousse, but a new and distinct publication.

The most notable work of this class, in English, is the *Century Dictionary*, an American product, edited by Professor W. D. Whitney, and published 1889–1891 in six volumes, containing 7046 pages (large quarto). It conforms to the philological mode in giving with great fulness the older as well as the present vocabulary of the language, and in the completeness of its etymologies; but it does not attempt to give the full history of every word within the language. Among its other more noteworthy characteristics are the inclusion of a great number of modern scientific and technical words, and the abundance of its quotations. The quotations are for the most part provided with references, but they are not dated. Even when compared with the much larger *New English Dictionary*, the *Century's* great merit is the excellent enumeration of meanings, and the accuracy of its explanations; in this respect it is often better and fuller than the *New English*. In the application of the encyclopaedic method this dictionary is conservative, excluding, with a few exceptions, proper names, and restricting, for the most part, the encyclopaedic matter to descriptive and other details which may legitimately be added to the definitions. Its pictorial illustrations are very numerous and well executed. In the manner of its compilation it is a good example of modern co-operative dictionary-making, being the joint product of a large number of specialists. Next to the *New English Dictionary* it is the most complete and scholarly of English lexicons.

Bibliography.—The following list of dictionaries (from the 9th edition of this work, with occasional corrections) is given for its historical interest, but in recent years dictionary-making has been so abundant that no attempt is made to be completely inclusive of later works; the various articles on languages may be consulted for these. The list is arranged geographically by families of languages, or by regions. In each group the order, when not alphabetical, is usually from north to south, extinct languages generally coming first, and dialects being placed under their language. Dictionaries forming parts of other works, such as travels, histories, transactions, periodicals, reading-books, &c., are generally excluded. The system here adopted was chosen as on the whole the one best calculated to keep together dictionaries naturally associated. The languages to be considered are too many for an alphabetical arrangement, which ignores all relations both natural and geographical, and too few to require a strict classification by affinities, by which the European languages, which for many reasons should be kept together, would be dispersed. Under either system, Arabic, Persian and Turkish, whose dictionaries are so closely connected, would be widely separated. A wholly geographical arrangement would be in-

convenient, especially in Europe. Any system, however, which attempts to arrange in a consecutive series the great network of languages by which the whole world is enclosed, must be open to some objections; and the arrangement adopted in this list has produced some anomalies and dispersions which might cause inconvenience if not pointed out. The old Italic languages are placed under Latin, all dialects of France under French (but Provençal as a distinct language), and Wallachian among Romanic languages. Low German and its dialects are not separated from High German. Basque is placed after Celtic; Albanian, Gipsy and Turkish at the end of Europe, the last being thus separated from its dialects and congeners in Northern and Central Asia, among which are placed the Kazan dialect of Tatar, Samoyed and Ostiak. Accadian is placed after Assyrian among the Semitic languages, and Maltese as a dialect of Arabic; while the Ethiopic is among African languages as it seemed undesirable to separate it from the other Abyssinian languages, or these from their neighbours to the north and south. Circassian and Ossetic are joined to the first group of Aryan languages lying to the north-west of Persia, and containing Armenian, Georgian and Kurd. The following is the order of the groups, some of the more important languages, that is, of those best provided with dictionaries, standing alone:—

EUROPE: Greek, Latin, French, Romance, Teutonic (Scandinavian and German), Celtic, Basque, Baltic, Slavonic, Ugrian, Gipsy, Albanian.

ASIA: Semitic, Armenian, Persian, Sanskrit, Indian, Indo-Chinese, Malay Archipelago, Philippines, Chinese, Japanese, Northern and Central Asia.

AFRICA: Egypt and Abyssinia, Eastern Africa, Southern, Western, Central, Berber.

AUSTRALIA AND POLYNESIA.

AMERICA: North, Central (with Mexico), South.

EUROPE

Greek.—Athenaeus quotes 35 writers of works, known or supposed to be dictionaries, for, as they are all lost, it is often difficult to decide on their nature. Of these, Anticleides, who lived after the reign of Alexander the Great, wrote Ἑξήγησις, which seems to have been a sort of dictionary, perhaps explaining the words and phrases occurring in ancient stories. Zenodotus, the first superintendent of the great library of Alexandria, who lived in the reigns of Ptolemy I. and Ptolemy II., wrote Γλῶσσα, and also Ἄλφειος ἱερικός, a dictionary of barbarous or foreign phrases. Aristophanes of Byzantium, son of Apelles the painter, who lived in the reigns of Ptolemy II. and Ptolemy III., and had the supreme management of the Alexandrian library, wrote a number of works, as Ἀριστεύει Ἄλφειος, ἀνασώσατο Ἰνδοῦ, which, from the titles, should be dictionaries, but a fragment of his Ἄλφειος printed by Boissonade in his edition of Herodian (London, 1869, 8vo, pp. 181–189), is not alphabetical. Artemidorus, a pupil of Aristophanes, wrote a dictionary of technical terms used in cookery. Nicander Colophonius, hereditary priest of Apollo Clarius, born at Claros, near Colophon in Ionia, in reputation for 50 years, from 181 to 135, wrote Γλῶσσα in at least three books. Parthenius, a pupil of the Alexandrian grammarian Dionysius (who lived in the 1st century before Christ), wrote on choice words used by historians. Didymus, called χαλκιδεύσιος, who, according to Athenaeus, wrote 3500 books, and, according to Seneca, 4000, wrote lexicons of the tragic poets (of which book 28 is quoted), of the comic poets, of ambiguous words and of corrupt expressions. Glossaries of Attic words were written by Crates, Philemon, Philetas and Theodorus; of Cretan, by Hermon or Hermonax; of Phrygian, by Neoptolemus; of Rhodian, by Moschus; of Italian, by Diodorus of Tarsus; of foreign words, by Silenus; of synonyms, by Simeristus; of cookery, by Heraclion; and of drinking vessels, by Apollodorus of Cyrene. According to Suidas, the most ancient Greek lexicographer was Apollonius the sophist, son of Archibius. According to the common opinion, he lived in the time of Augustus at Alexandria. He composed a lexicon of words used by Homer, Ἄλφειος Ὀμηρικῆς, a very valuable and useful work, though much interpolated, edited by Villoison, from a MS. of the 10th century, Paris, 1773, 4to, 2 vols.; and by Tollius, Leiden, 1788, 8vo; ed. Bekker, Berlin, 1833, 8vo. Erotian or Herodian, physician to Nero, wrote a lexicon on Hippocrates, arranged in alphabetical order, probably by some copyist. Chron Klein calls it "homo sciolus." It was first published in Greek in H. Stephani *Dictionarium Medicum*, Paris, 1854, 8vo; ed. Klein, Lipsiae, 1865, 8vo, with additional fragments. Timaeus the sophist, who, according to Ruhnkens, lived in the 3rd century, wrote a very short lexicon to Plato, which, though much interpolated, is of great value, 1st ed. Ruhnkens, Leiden, 1754; ed. locupletior, Lugd. Bat. 1789, 8vo. Aelius Moeris, called the Atticist, lived about 190

A.D., and wrote an Attic lexicon, 1st ed. Hudson, Oxf. 1712, Bekker, 1833. Julius Pollux (*Ἰουλιανὸς Πόλυδεύτης*) of Naucratis, in Egypt, died, aged fifty-eight, in the reign of Commodus (180-192), who made him professor of rhetoric at Athens. He wrote, besides other lost works, as *Onomasticon* in ten books, being a classed vocabulary, intended to supply all the words required by each subject with the usage of the best authors. It is of the greatest value for the knowledge both of language and of antiquities. First printed by Aldus, Venice, 1500, fol.; often afterwards; ed. Lederlinus and Hemsterhuis, Amst. 1706, 2 vols.; Dindorf, 1824, 5 vols., Bethe (1900 f.). Harporacration of Alexandria, probably of the 2nd century, wrote a lexicon on the ten Attic orators, first printed by Aldus, Ven. 1503, fol.; ed. Dindorf, Oxfor. 1833, 8vo, 2 vols. from 14 MSS. Orion, a grammarian of Thebes, in Egypt, who lived between 390 and 460, wrote an etymological dictionary, printed by Sturz, Leipzig, 1820, 4to. Helladius a priest of Jupiter at Alexandria, when the heathen temples there were destroyed by Theophilus in 389 or 391 escaped to Constantinople, where he was living in 408. He wrote an alphabetical lexicon, now lost, chiefly of prose, called by Photius the largest (*ὑπολαβητικόν*) which he knew. Ammonius, professor of grammar at Alexandria, and priest of the Egyptian ape, fled to Constantinople with Helladius, and wrote a dictionary of words similar in sound but different in meaning, which has been often printed in Greek lexicons, as Aldus, 1497, Stephanus, and separately by Valckenae, Lugd. Bat. 1739, 4to, 2 vols., and by others. Zenodotus wrote on the cries of animals, printed in Valckenae's *Ammonius*; with this may be compared the work of Vincentio Caralucci, *Lexicon vocum quae brutis animalibus occurrunt*, Perugia, 1779, 12mo. Hesychius of Alexandria wrote a lexicon, important for the knowledge of the language and literature, containing many dialectic and local expressions and quotations from other authors, 1st ed. Aldus, Ven. 1514, fol.; the best is Alberti and Rubles, Lugd. Bat. 1746-1766, fol. 2 vols.; collated with the MS. in St Mark's library, Venice, the only MS. existing, by Niels Iversen Schow, Leipzig, 1792, 8vo; ed. Schmidt, Jena, 1867, 8vo. The foundation of this lexicon is supposed to have been that of Pamphilus, an Alexandrian grammarian, quoted by Athenaeus, which, according to Suidas, was in 95 books from E to Q; A to Δ had been compiled by Zopirion. Photius, consecrated patriarch of Constantinople, 25th December 857, living in 886, left a lexicon, partly extant, and printed with Zonaras, Lips. 1808, 4to, 3 vols., being vol. iii.; ed. Naber, Leizae, 1864-1865, 8vo, 2 vols. The most celebrated of the Greek glossaries is that of Suidas, of whom nothing is known. He probably lived in the 10th century. His lexicon is an alphabetical dictionary of words including the names of persons and places—a compilation of extracts from Greek writers, grammarians, scholiasts and lexicographers, very carelessly and unequally executed. It was first printed by Demetrius Chalcondylas, Milan, 1499, fol.; the best edition, Bernhardy, Halle, 1853, 4to, 2 vols. John Zonaras, a celebrated Byzantine historian and theologian, who lived in the 12th century, compiled a lexicon, first printed by Tittmann, Lips. 1808, 4to, 2 vols. An anonymous Greek glossary, entitled *Ἐτυμολογικὸν βιβλίον*, *Etymologicum magnum*, has been frequently printed. The first edition is by Musurus, Venetia, 1499, fol.; the best by Gaisford, Oxon. 1848, fol. It contains many grammatical remarks by famous authorities, many passages of authors, and mythological and historical notices. The MSS. vary so much that they look like the works of different authors. To Eudocia Augusta of Makrembolia, wife of the emperor Constantine XI. and Romanus IV. (1059 to 1071), was ascribed a dictionary of history and mythology, *ἱστορικὸν βιβλίον* (bed of violets), first printed by D'Anse de Villoisson, *Ancienta Graeca*, Venetia, 1781, 4to, vol. i. pp. 1-442. It was supposed to have been of much value before it was published. Thomas, Magister Officiorum under Andronicus Palaeologus, afterward called as a monk Theodulus, wrote *Ἐτυμολογικὸν Ἄρτιον*, printed by Calligres, Romae, 1517, 8vo: Papias, *Vocabularium*, Mediolani, 1476, fol.; Craston, an Italian Carmelite monk of Piacenza, compiled a Greek and Latin lexicon, edited by Bonus Accursius, printed at Milan, 1478, fol.; Aldus, Venetia, 1497, fol.; Guarino, born about 1450 at Favara, near Casarino, who called himself both Phavorinus and Camers, published his *Thesaurus* in 1504. These three lexicons were frequently reprinted. Estienne, *Thesaurus*, Genevae, 1572, fol., 4 vols.; ed. Vaip, Lond. 1816-1826, 6 vols. fol.; Paris, 1831-1865, 9 vols. fol., 9902 pages; *Kubura*, the ark, was intended to give the whole language, ancient and modern, but vol. i., Constantinople, 1819, fol., 763 pages, A to Z, only appeared, as the publication was put an end to by the events of 1821. ENGLISH.—Jones, London, 1823, 8vo. Dunbar, Edin. 3rd ed. 1850, 4to. Liddell and Scott, 8th ed. Oxford, 1897, 4to. FRENCH.—Alexandre, 12th ed. Paris, 1863, 8vo. 1869-1871, 2 vols. Cassan, ed. 1872, 8vo. ITALIAN.—Camini, Torino, 1865, 8vo, 972 pages; Müller, ed. 1871, 8vo. SPANISH.—*Diccionario manual, por los padres Escolapios*, Madrid, 1859, 8vo. GERMAN.—Pawow, 5th ed. Leipzig, 1841-1857, 4to; Jacobitz and Seiler, 4th ed. 1856, 8vo; Bauer, ed. 1859, 8vo; Pape, Braunschweig, 1870-1874, 8vo, 4 vols. FRENCH. *Etymologisches Wörterbuch der griechischen Sprache*, new edition, 1906. Herwerden, *Lexicon Graecum supplementum et ablatum*, 1902. DIALLECTS.—Alic: Moeris, ed. Pierson, Lugd. Bat. 1779, 8vo. Attic Orators: Reiske, Oxon. 1828, 8vo, 2 vols. Doric: Paris, Francofol. 1605, 8vo. Ionic: Id. ib. 1603, 8vo; 1817; 1825. PAPHLAGIAN.—Morell, Etoriae, 1762, 4to; ed. Malby, Lond. 1830, 4to; Boam, Lond. 1850, 8vo. RHETORIC.—Ernesti, Lips. 1795, 8vo.

MUSIC.—Drieberg, Berlin, 1855. ETYMOLOGY.—Curtius, Leipzig, 1858-1862; Lancelot, Paris, 1863, 8vo. SYNONYMS.—Peucer, Dresden, 1766, 8vo; Paniel, Paris, 1847, 8vo. PROVER NAMES.—Pape, ed. Sengenbuch, 1866, 8vo, 969 pages. VERBS.—Veitch, 2nd ed. Oxf. 1866. TERMINATIONS.—Hoozeveen, Cantab. 1810, 4to; Pape, Berlin, 1836, 8vo. PARTICULAR AUTHORS.—*Aeschylus*: Wellauer, 2 vols. Lips. 1830-1831, 8vo. *Aristophanes*: Carvelia, Oxonii, 1822, 8vo. *Demosthenes*: Reiske, Lips. 1775, 8vo. *Euripides*: Beck, Cantab. 1829, 8vo. *Herodotus*: Schweighäuser, Strasburg, 1824, 8vo, 2 vols. *Herodotus*: Orsoria, Neapol. 1791, 8vo. *Homers*: Apollonius Sophista, ed. Tollius, Lugd. Bat., 1788, 8vo; Schaufelberger, Zürich, 1761-1768, 8vo, 8 vols.; Crusius, Hanover, 1836, 8vo; Wittich, London, 1843, 8vo; Döderlein, Erlangen, 8vo, 3 vols.; Eberling, Lipsiae, 1875, 8vo; Autenrieth, Leipzig, 1873, 8vo; London, 1877, 8vo. *Isocrates*: Mitchell, Oxon. 1828, 8vo. *Pindar*: Portus, Hanov. 1606, 8vo. *Plato*: Timaeus, ed. Koch, Lips. 1828, 8vo; Mitchell, Oxon. 1832, 8vo; Ast, Lips. 1835-1838, 8vo, 3 vols. *Plutarch*: Wytttenbach, Lips. 1835, 8vo, 2 vols. *Sophocles*: Ellendt, Regiomonti, 1834-1835, 8vo ed.; Genthe, Berlin, 1872, 8vo. *Thucydides*: Bétant, Geneva, 1843-1847, 8vo, 2 vols. *Xenophons*: Sturtz, Lips. 1801-1804, 8vo, 4 vols.; Cannesin (Anabasis Gr.-Finnish), Hel-sinrissa, 1868, 8vo; Sauppe, Lipsiae, 1860, 8vo. *Sepuagint*: Hutter, Noribergae, 1598, 4to; Biel, Hagae, 1779-1780, 8vo. *New Testament*: Lithocorum, Colon. 1552, 8vo; Parkhurst, ed. Major, London, 1845, 8vo; Schleuser (juxta ed. Lips. quartam), Glasguae, 1824, 4to. Medieval and Modern Greek.—Meursius, Lugd. Bat. 1614, 4to; Cripoulos, Stendalae, 1787, 8vo; Portus, Par. 1635, 4to; Dru Camer, Paris, 1682, fol., 2 vols.; Ludg. 1688, fol. ENGLISH.—*Polymera*, Hermapolita, 1854, 8vo; Socinocles, Cambr. Mass. 1860-1887; Contopoulos, Athina, 1867, 8vo; Smyrna, 1868-1870, 8vo, 2 parts, 1042 pages. FRENCH.—Skarlatos, Athina, 1852, 4to; Byzantium, ed. 1856, 8vo, 2 vols.; Varvati, 4th ed. ib. 1860, 8vo. ITALIAN.—Germano, Romae, 1622, 8vo; Somavera, Parigi, 1709, fol., 2 vols.; Pericles, Hermapolita, 1857, 8vo. GERMAN.—Schmidt, Lips. 1825-1827, 12mo, 2 vols.; Petraris, Leipz. 1807. POLYGLOTS.—Konias (Russian and Fr.), Moscow, 1811, 4to; Schmidt (Fr.-Ger.), Leipzig, 1837-1840, 12mo, 3 vols.; Theocarpoulas de Patras (Fr.-Eng.), Munich, 1840, 12mo. Latin.—Johannes de Janus, *Catholicon* or *Summa*, finished in 1286, printed Moguntiae 1460, fol.; Venice, 1487; and about 20 editions before 1500; Johannes, *Comprehensorium*, Valentia, 1475, fol.; Nestor Dionysius, *Onomasticon*, Milan, 1477, fol.; Stephanus, Paris, 1531, fol., 2 vols.; Gesner, Lips. 1749, fol., 4 vols.; Forcellini, Patavii, 1771, fol., 4 vols. POLYGLOT.—Caepinus, Reggio, 1502, fol. (Aldus printed 16 editions, with the Greek equivalents of the Latin words; Venetia, 1575, fol., added Italian, French and Spanish; Basileae, 1590, fol., in 11 languages; several editions, from 1609, are called Octolinguae; many of the latter 2 vol. editions were edited by John Faccioliati); Verantius (Ital., Germ., Dalmatian, Hungarian), Venetia, 1595, 4to; Loderzecker (Ital., Germ., Dalm., Hungar., Bohem., Polish), Prague, 1605, 4to. ENGLISH.—*Promptorium parvulorum*, compiled in 1440 by Galfridus Grammaticus, a Dominican monk of Lynn Episcopi, in Norfolk, was printed by Fynson, 1499; 8 editions, 1508-1528, ed. Way, Camden Society, 1843-1865, 3 vols. 4to; *Methula grammatica*, probably by the same author, MS. written 1483; printed as *Ortus vocabulorum*, by Wynkyn de Worde, 1500; 13 editions 1509-1527; Sir Thomas Elyot, London, 1538, fol.; and ed. 1543; *Bibliotheca Bistulae*, ed. Cooper, ib. 1545, fol.; Hulster, *Abecedarium*, London, 1552, fol.; *Dictionary*, ib. 1574, fol.; Cooper, London, 1565, fol.; 4th edition, 1584, fol.; Baret, *Alvearie*, ib. 1579, 2 vols.; 1580, fol.; Fleming, ib. 1583, fol.; *Ainsworth*, London, 1736, 4to; ed. Morell, London, 1796, 4to, 2 vols.; ed. Beaton and Ellis, ib. 1860, 8vo; Scheller, translated by Riddle, Oxford, 1835, fol.; Smith, London, 1855, 8vo; 1870; Lewis and Short, Oxford, 1879. ENG.-LATIN.—Levins, *Manipulus puerorum*, Lond. 1570, 4to; Riddle, ed. 1838, 8vo; Smith, ed. 1855, 8vo. FRENCH.—*Catholicon parvum*, Geneva, 1487; Estienne, *Dictionnaire*, Paris, 1539, fol. 675 pages; enlarged 1549; ed. Huggins, Lond. 1572; Id. *Dictionarium Latino-Gallicum*, Lutetiae, 1546, fol.; Paris, 1552; 1560; Id., *Dictionarium puerorum*, Paris, 1542, 4to; *Les Mots français*, Paris, 1544, 4to; the copy in the British Museum has the autograph of Queen Catherine Parr; Thierry (Fr.-Lat.), Paris, 1564, fol.; Danet, Ad usum Delphini, Paris, 1700, 4to, 2 vols.; and frequently; Quicherat, 9th ed. Paris, 1857, 8vo; Theil, 3rd ed. Paris, 1863, 8vo; Freund, ed. 1835-1865, 4to, 3 vols. GERMAN.—Joh. Melber, of Gerolzhofen, *Vocabularium praedicatorium*, of which 26 editions are described by Hain (*Repertorium*, No. 11,022, &c.), 15 undated, 7 dated 1480-1495, 4to, and 3 after 1500; *Vocabularium gemma gemmarum*, Antwerp, 1484, 4to; 1487; 12 editions, 1505-1518; Herman Torentinus, *Elucidarius carminum*, Daventri, 1501, 4to; 2 editions, 1504-1536; Binnart, Ant. 1649, 8vo; Id., *Biglotten*, ib. 1661; 4th ed. 1688; Faber, ed. Gesner, Hagae Com. 1735, fol., 2 vols.; Hederick, Lips. 1766, 8vo, 2 vols.; Ingerslev, Braunschweig, 1835-1835, 8vo, 2 vols.; *Thesaurus linguae Latinae*, Leipzig, 1900; Walde, *Latinsches etymologisches Wörterbuch*, 1906. ITALIAN.—Seebur (Sicilian translation of Lebriz), Venet. 1525, 8vo; Venuti, 1589, 8vo; Galeisni, Vinez 1605, 8vo; Bazzarini and Bellini, Torino, 1864, 4to, 2 vols. 3100 pages. SPANISH.—Salamancae, 1494, fol.; Antonio de Lebriz, Norrisisim, Compluti, 1520, fol., 2 vols.; Sanchez de la Balzasta, Salamanca, 1587, 4to; Valbuena, Madrid, 1826, fol. PORTUGUESE.—

Bluteau, Liabon, 1712-1728, fol., 10 vols.: Fonseca, *ib.* 1771, fol.: Ferreira, Paris, 1834, 4to; 1852. ROMANSCHE.—*Promptorium de voci vulgaris*, Valgrüni, 1565, 4to. VLACH.—Divalitu, Bucuresci, 1852, 8vo. SWEDISH.—*Vocabula*, Roetock, 1574, 8vo; Stockholm, 1579; Lindblom, Upsala, 1790, 4to. DUTCH.—Binnart, Antw. 1649, 8vo; Scheller, Lugd. Bat. 1799, 4to, 2 vols. FLEMISH.—Paludanus, Gandavi, 1544, 4to. POLISH.—Macinius, Königsberg, 1564, fol.: Garaszynski, Brealau, 1823, 8vo, 2 vols. BOHEMIAN.—Johannes Arzenius, Pilsnae, 1511, 4to; Reschel, Olmucii, 1560-1562, 4to, 2 vols.: Cnapius, Cracovia, 1661, fol., 3 vols. ILLYRIAN.—Bellostenez, Zagrab, 1740, 4to; Jambresch (also Germ. and Hungar.), Zagrab, 1742, 4to. SERBIAN.—Swoitlik, Budae, 1721, 8vo. HUNGARIAN.—Molnar, Frankf. a. M. 1645, 8vo; Paris-Papal, Leutschen, 1708, 8vo; 1767. FINNISH.—Rothenen, Helsinki, 1864, 8vo. PORTIC.—*Epiletorum et synonymorum thesaurus*, Paris, 1662, 8vo, attributed to Chatillon; reprinted by Paul Aler, a German Jesuit, as *Gradus ad Parnassum*, Paris, 1687, 8vo; many subsequent editions: *Schirach*, Hal. 1768, 8vo; Noel, Paris, 1810, 8vo; 1826: Quicherat, Paris, 1852, 8vo; Young, London, 1856, 8vo. EROTIC.—Rambach, Stuttgart, 1826, 8vo. RETHROLOG.—Ernesti, Lips. 1797, 8vo. CIVIL LAW.—Dirksen, Berlin, 1837, 4to. SYNONYMUS.—Hill, Edinb. 1809, 4to; Döderlein, Lips. 1826-1828, 8vo, 6 vols. ETYMOLOGY.—Dane, Paris, 1677, 8vo; Vossius, Neap. 1762, fol., 2 vols.: Salmon, London, 1796, 8vo, 2 vols.: Nagel, Berlin, 1869, 8vo; Latin roots, with their French and English derivatives, explained in German: Zehetmayr, Vindobonae, 1873, 8vo; Vanček, Leipz. 1874, 8vo. BARBAROUS.—Marchellus, Mediol. 1753, 4to; Krebs, Frankf. a. M. 1834, 8vo; 1837. PARTICULAR AUTHORS.—Caesar: Crusius, Hanov. 1878, 8vo. Cicero: Nizzoli, Brescia, 1535, fol.; ed. Faccioliati, Patavii, 1734, fol.; London, 1820, 8vo, 3 vols.: Ernesti, Lips. 1739, 8vo; Halle, 1831. Cornelius Nepos: Schmieder, Halle, 1798, 8vo; 1816: Billerbeck, Hanover, 1825, 8vo. Curtius Rufus: Crusius, Hanov. 1844, 8vo. Horace: Ernesti, Berlin, 1802-1804, 8vo, 3 vols.: Döring, Leipz. 1829, 8vo. Justin: Meinecke, Lemgo, 1793, 8vo; 2nd ed. 1818. Livy: Ernesti, Lips. 1784, 8vo; ed. Schäfer, 1804. Ovid: Gierig, Leipz. 1811; (Metamorphoses) Meinecke, 2nd ed., Lemgo, 1825, 8vo; Billerbeck (Do.), Hanover, 1831, 8vo. Phaedrus: Oertel, Nürnberg, 1798, 8vo; Hörstel, Leipz. 1803, 8vo; Billerbeck, Hanover, 1828, 8vo. Plautus: Paraeus, Frankf. 1614, 8vo. Pliny: Denso, Rostock, 1766, 8vo. Pliny, jun.: Wensch, Wittenberg, 1837-1839, 4to. Quintilian: Bonnellus, Leipz. 1834, 8vo. Sallust: Schneider, Leipz. 1834, 8vo; Crusius, Hanover, 1840, 8vo. Tacitus: Böttcher, Berlin, 1830, 8vo. Valerius Paternulus: Koch, Leipz. 1857, 8vo. Virgil: Clavis, London, 1742, 8vo; Braunhard, Coburg, 1834, 8vo. Vitruvius: Rode, Leipz. 1679, 4to, 2 vols.: Orsini, Perugia, 1801, 8vo.

OLD ITALIAN LANGUAGES.—Fabretti, Torini, 1858, 4to. Umbrian: Huschke, Leipz. 1860, 8vo. Oscan and Sabellian: Id. Elberteld, 1866, 8vo.

MIDDLEV LATIN.—Du Cange, *Glossarium*, Paris, 1733-1736, fol., 6 vols.; Carpentier, Suppl. Paris, 1766, fol., 4 vols.; ed. Adelung, Halae, 1772-1784, 8vo, 6 vols.; ed. Henschel, Paris, 1840-1850, 4to, 7 vols. (vol. vii. contains a glossary of Old French): Brinckmeier, Gotha, 1850-1863, 8vo, 2 vols.: Hildebrand (*Glossarium voc. ic.*), Götting, 1854, 4to; Diefenbach, *Glossarium*, Frankf. 1857, 4to. *Id. Gloss. novum*, *ib.* 1867, 4to. ECCLESIASTICAL.—Magri, Messina, 1644, 4to; 8th ed. Venezia, 1732; Latin translation, *Magri Hieroglossicon*, Romae, 1677, fol.; 6th ed. Bologna, 1765, 4to, 2 vols.

Romance Languages.

Romance Languages generally.—Dies, Bonn, 1853, 8vo; 2nd ed. *ib.* 1861-1862, 8vo, 2 vols.; 3rd ed. *ib.* 1869-1870, 8vo, 2 vols.; transl. by Donkin, 1864, 8vo.

French.—Ranconet, *Thesaur*, ed. Nicot, Paris, 1606, fol.; *ib.* 1618, 4to; Richelet, Genève, 1680, fol., 2 vols.; ed. Gattel, Paris, 1840, 8vo, 2 vols.

The French Academy, after five years' consideration, began their dictionary, on the 7th of February 1639, by examining the letter A, which took them nine months to go through. The word Académie was for some time omitted by oversight. They decided, on the 8th of March 1638, not to cite authorities, and they have since always claimed the right of making their own examples. Olivier justifies them by saying that for eighty years all the best writers belonged to their body, and they could not be expected to cite each other. Their design was to raise the language to its last perfection, and to open a road to reach the highest eloquence. Antoine Furetière, one of their members, compiled a dictionary which he says cost him forty years' labour for ten hours a day, and the manuscript filled fifteen chests. He gave words of all kinds, especially technical, names of persons and places, and phrases. As a specimen, he published his *Essai*, Paris, 1684, 4to; Amst. 1685, 12mo. The Academy charged him with using the materials they had prepared for their dictionary, and expelled him, on the 22nd of January 1685, for plagiarism. He died on the 14th of May 1688, in the midst of the consequent controversy and law suit. His complete work was published, with a preface by Bayle, La Haye and Rotterdam, 1690, fol., 3 vols.; again edited by Basnage de Beauval, 1701; La Haye, 1707, fol., 4 vols. From the edition of 1701 the very popular so-called *Dictionnaire de Trevoux*, Trevoux, 1704, fol., 2 vols., was made by the Jesuits, who excluded everything that seemed to favour the Calvinism of Basnage. The last of its many

editions is Paris, 1771, fol., 8 vols. The Academy's dictionary was first printed Paris, 1694, fol., 2 vols. They began the revision in 1700; second edition 1718, fol., 2 vols.; 3rd, 1740, fol., 2 vols.; 6th, 1835, 2 vols. 4to, reprinted 1855; Supplément, by F. Raymond, 1836, 4to; Complément, 1842, 4to, reprinted 1856; *Dictionnaire historique*, Paris, 1858-1865, 4to, 2 parts (A to Actu), 795 pages, published by the Academy; Dochez, Paris, 1859, 4to; Bescherelle, *ib.* 1844, 4to, 2 vols.; 5th ed. Paris, 1857, 4to, 2 vols.; 1865; 1887; Landais, Paris, 1835; 12th ed. *ib.* 1854, 4to, 2 vols.: Littre, Paris, 1863-1873, 4to, 4 vols. 7118 pages: Supplément, Paris, 1877, 4to; Godefroy (with dialects from 9th to 15th cent.), Paris, 1881-1895, and *Complément*: Hatzfeld, Darmesteter, and Thomas, Paris, 1880-1900; Larive and Fleury, (*mots et choses, illustré*), Paris, 1884-1891. ENGLISH.—Palgrave, *Lesclaircissement de la langue francoise*, London, 1530, 4to, 2 parts; 1852: Hollyband, London, 1533, 4to; Cotgrave, *ib.* 1611, fol.; Boyer, La Haye, 1702, 4to, 2 vols.; 37th ed. Paris, 1851, 8vo, 2 vols.; Fleming and Tibbins, Paris, 1846-1849, 4to, 2 vols.; *ib.* 1854, 4to, 2 vols.; *ib.* 1870-1872, 4to, 2 vols.; Tarver, London, 1853-1854, 8vo, 2 vols.; 1867-1872; Bellows, Gloucester, 1873, 16mo; *ib.* 1876. IDEOLOGICAL or ANALOGICAL.—Robertson, Paris, 1859, 8vo; Boissière, Paris, 1862, 8vo. ETYMOLOGY.—Lébon, Paris, 1571, 8vo; Ménage, *ib.* 1650, 4to. Pougens projected a *Trésor des termes*, his extracts for which filling nearly 100 volumes folio, are in the library of the Institut. He published a specimen, Paris, 1819, 4to. After his death, *Archéologie française*, Paris, 1821, 8vo, 2 vols., was compiled from his MSS., which were much used by Littre: Scheler, Bruxelles, 1862, 8vo; 1873; Brachet, 2nd ed. Paris, 1870, 12mo; English trans. Kitchin, Ozf. 1866, 8vo. GREEK WORDS.—Trippault, Orleans, 1580, 8vo; Morin, Paris, 1809, 8vo. GERMAN WORDS.—Atzler, Cöthen, 1867, 8vo. ORIENTAL WORDS.—Pihan, Paris, 1847, 8vo; 1866; Devic, *ib.* 1876, 8vo. NEOLOGY.—Desfontaines, 3rd ed. Amst. 1728, 12mo; Mercier, Paris, 1801, 8vo, 2 vols.: Richard, *ib.* 1842, 8vo; 2nd ed. 1845. PORTIC.—*Dict. des rimes (by La Noue)*, Genève, 1596, 8vo; Coligny, 1624, 8vo; Carpentier, *Le Gradus françois*, Paris, 1825, 8vo, 2 vols. EROTIC.—De Landes, Bruxelles, 1861, 12mo. ORATORY.—Demandre and Fontenai, Paris, 1802, 8vo; Planché, *ib.* 1819-1820, 8vo, 3 vols. PRONUNCIATION.—Féline, *ib.* 1857, 8vo. DOUBLE FORMS.—Brachet, *ib.* 1871, 8vo. EPITHETS.—Daire, *ib.* 1817, 8vo. VERBS.—Bescherelle, *ib.* 1855, 8vo, 2 vols.; 3rd ed. 1858. PARTICIPLES.—Id., *ib.* 1861, 12mo. DIFFICULTIES.—Boiste, London, 1828, 12mo; Laveaux, Paris, 1872, 8vo, 843 pages. SYNONYMUS.—Boinville, Paris, 1826, 8vo; Lafaye, *ib.* 1858, 8vo; 1861; 1860; Guizot, *ib.* 1809, 8vo; 6th ed. 1863; 1873. HOMONYMUS.—Zlatogorski (Germ., Russian, Eng.), Leipzig, 1862, 8vo, 664 pages. IMITATIVE WORDS.—Nodier, *Onomatopées*, *ib.* 1826, 8vo. TECHNOLOGY.—D'Hautel, *ib.* 1808, 8vo, 2 vols.: Desgranges, *ib.* 1821, 8vo; Tolhausen (Fr., Eng., Germ.), Leipz. 1873, 8vo, 3 vols. FAULTS OF EXPRESSION.—Roland, Gap, 1823, 8vo; Blondin, Paris, 1823, 8vo. PARTICULAR AUTHORS.—Cornette: Godefroy, *ib.* 1862, 8vo, 2 vols.; Marty-Laveaux, *ib.* 1868, 8vo, 2 vols. *Le Fossaire*: Lorin, *ib.* 1852, 8vo. Malherbe: Regnier, *ib.* 1868, 8vo. Malzère: Genin, *ib.* 1846, 8vo. Marty-Laveaux, *ib.* 8vo. Racine: Marty-Laveaux, *ib.* 1873, 8vo, 2 vols. *Mots de Sénèque*: Somme, *ib.* 1867, 8vo, 2 vols. OLD FRENCH.—La Curne de St. Palaye prepared a dictionary, of which he only published *Projet d'un glossaire*, Paris, 1756, 4to. His MSS. in many volumes are in the National Library, and were much used by Littre. They were printed by L. Favre, and fasciculi 21-30 (tom. liii.), Niort, 4to, 484 pages, were published in February 1877. Lacombe (vieux langage), Paris, 1766, 4 vols. 4to; Kelham (Norman and Old French), London, 1779, 8vo; Roquefort (langue romane), Paris, 1808, 8vo; Supplément, *ib.* 1820, 8vo; Pougens, *Archéologie*, *ib.* 1821, 8vo, 2 vols.; Burguy, Berlin, 1851-1856, 8vo, 3 vols. Laborde (*Notice des tmaux . . . du Louvre*, part ii.), Paris, 1853, 8vo, 564 pages. 1. Gachet (rhymed chronicles), Bruxelles, 1859, 4to; Le Héricier (Norman, English and French), Paris, 1862, 3 vols. 8vo; Hippeau (12th and 13th centuries), Paris, 1875, 8vo. DIALECTS.—Jaubert (central), Paris, 1856-1857, 8vo, 2 vols.: Baumgarten (north and centre), Coblenz, 1870, 8vo. Azais, *Idiomes romans du midi*, Montpellier, 1877. Auvergnais: François, Metz, 1773, 8vo. Auvergne: Mege, Riom, 1861, 12mo. Bearn: Lespi, Pau, 1858, 8vo. Bascaire: Bonnet (Bouguier), Nismes, 1840, 8vo. Pays de Bray: Decorde, Neufchâtel, 1852, 8vo. Burgundy: Mignard, Dijon, 1870, 8vo. Pays de Castres: Couzint, Castres, 1850, 4to. Dauphiné: Champollion-Figeac, Paris, 1809, 8vo. Jussu, Valence, 1835, 8vo; Paris, 1840, 4to. Dep. of Doubs: Tissot (Patois des Fourg, arr. de Pontarlier) Besançon, 1865, 8vo. Forez: Gras, Paris, 1864, 8vo; Neolas, Lyon, 1865, 8vo. Franche Comté: Maisonfort, 2nd ed. Besançon, 1753, 8vo. Gascony: Desgrais (Gasonismes corrigés), Toulouse, 1766, 8vo; 1769; 1812, 12mo, 2 vols.; 1825, 8vo, 2 vols. Dep. of Gers: Cenac-Montaut, Paris, 1863, 8vo. Geneva: Humbert, Genève, 1820, 8vo. Languedoc: Odde, Tolose, 1578, 8vo; Doujat, Toulouse, 1638, 8vo. De S. Jauvages: Nismes, 1756, 2 vols.; 1785; Alais, 1820; Azais, Béziers, 1876, &c., 8vo; Hombres, Alais, 1872, 4to; Thomas (*Greek words*) Montpellier, 1843, 4to. Liège: Fortz, Liège, 1866, 8vo, vol. i. 455 pages. Lille: Vermease, Lille, 1861, 12mo; Debutre du Buc, *ib.* 1867, 8vo. Limousin: Bérone, ed. Vialle (Corrèze), Tulle, 1823, 4to

1 This volume was issued with a new title-page as *Glossaire du moyen âge*, Paris, 1872.

Lymonis, Fores, Beaujolais: Onofrio, Lyon, 1864, 8vo. Hous
Maria: R. Jaoul de M. Jontesson, Paris, 1877, 1859, 503 pages.
Maria: Andrews, Nice, 1871, 12mo. Dep. de la Meuse: Cordier,
Paris, 1853, 8vo. Normans: Edelstand and Alfred Duméril, Caen,
1840, 8vo. Doubs: ib. 1857, 8vo. Le Héricher (Philologie top-
ographique), Caen, 1863, 4to. Id. (Éléments scandinaves), Avranches,
1861, 12mo. Metzivar (Guernsey), London, 1870, 8vo: Vansier
(arrond de Pont Audemer), Rouen, 1861, 8vo: Debillou (Vallée
d'Yves), Le Havre, 1875. Picardy: Corblet, Amiens, 1851, 8vo.
Peiron, Saiznove, Auzis: Favre, Niort, 1867, 8vo. Poitou:
Beauchef-Filleau, Paris, 1864, 8vo: Levrier, Niort, 1867, 8vo:
Lahane, Poitiers, 1868, 8vo. Saintonge: Boucherie, Angoulême,
1865, 8vo: Jouain, Royan, 1867, 8vo. Saony: Pont (Terrazou de
la Tarantaise), Chambéry, 1869, 8vo. La Suisse Romande: Bridel,
Lausanne, 1866, 8vo. Dep. of Tarn: Gary, Castre, 1845, 8vo. Dep.
of Vendaise: Barjavel, Carpentras, 1849, 8vo. Walloon (Ronchi):
Cambesier, Liège, 1877, 8vo: Grandpagnage, ib. 1845-1850, 8vo.
2 vols.: Chavée, Paris, 1857, 18mo: Vermeuse, Doudi, 1867, 8vo.
Sigart (Montvill), Bruxelles, 1870, 8vo. SLANG.—Oudin, Curiosités
Françaises, Paris, 1640, 8vo: Baudouin de Saumaise (Précieuses,
Langue de Ruelles); Paris, 1660, 12mo: ed. Livet, ib. 1856: Le
Roux, Dict. Comique, Amst. 1788, and 6 other editions: Carême
Prenant (i.e. Taumaisel), (argot réforme), Paris, 1829, 8vo: Larchey
(excentricités du langage), Paris, 1860, 12mo: 5th ed. 1865:
Delvan (langue verte, Parisian), Paris, 1867, 8vo: Larchey, Paris,
1873, 4to, 236 pages.
Provençal.—Pallas, Avignon, 1723, 4to: Bastero, *La Crusca Pro-*
vençale, Rôma, 1724, fol. vol. 1. only: Raynouard, Paris, 1836-1844,
 8vo, 6 vols.: Garcia, Draguinagan, 1841, 8vo, 2 vols.: Honorat,
 Digne, 1846-1849, 4to, 4 vols. 107,201 words: Id., *Vocab. fr. prov.*,
 ib. 1848, 12mo, 1174 pages.
 Spanish.—Covarrubias Orozco, Madrid, 1611, fol. ib. 1673-1674,
 fol. 2 vols.: Academia Española, Madrid, 1727-1739, fol. 6 vols.: 8th
 ed. 1837: Caballero, Madrid, 1849, fol.: 8th ed. ib. 1860, 4to, 2 vols.:
 Cuesta, ib. 1872, fol. 2 vols.: Campano, Paris, 1876, 18mo, 1018 pages.
 Spanish, 1886-1894: Monlau, 1881; Zerola, Toro y Gomes, and Izaa,
 1895; Serrano (encyclopaedic) 1876-1881. ENGLISH.—Percivall,
 London, 1591, 4to: Pineda, London, 1740, fol.: Connelly and
 Higgins, Madrid, 1797-1798, 4to, 4 vols.: Neuman and Baretti, 9th ed.
 London, 1831, 8vo, 2 vols.: 1874. FRENCH.—Oudin, Paris, 1607, 4to,
 1660: Gattel, Lyon, 1803, 4to, 2 vols.: Dominguez, Madrid, 1846,
 6vo, 6 vols.: Blanc, Paris, 1862, 8vo, 2 vols. GERMAN.—Wagener,
 Hamb. 1801-1805, 8vo, 4 vols.: Seckendorp, ib. 1823, 8vo, 3 vols.:
 Francoson, 3rd ed. Leipzig, 1862, 8vo, 2 vols. ITALIAN.—Franciosini,
 Venezia, 1735, 8vo, 2 vols.; Cormon and Manni, Leon, 1843, 16mo,
 2 vols.: Romero, Madrid, 1844, 4to. SYNONYMS.—*Dictionario de*
Sinonimos, Paris, 1853, 4to. ETYMOLOGY.—Aldrete, Madrid, 1682,
 2 vols.: Monlau y Roca, ib. 1856, 12mo; Barcia, 1881-1883. ARABIC
 WORDS.—Hammer Purgstall, Wien, 1855, 8vo: Dozy and Engel-
 caen, 2d ed. Leiden, 1869, 8vo. ANCIENT.—Sanchez, Paris, 1842,
 8vo. RHYMING.—Garcia de Rengifo (consonancias) Salmantica,
 1592, 4to: 1876. DON QUIXOTE.—Beneke (German), Leipzig, 1800,
 16mo: 4th ed. Berlin, 1841, 16mo. DIALECTS.—*Arganese*: Peratta,
 Zaragoza, 1836, 8vo: Borno, ib. 1859, 4to. *Catalan*: Rocha de
 Girona (Latin), Barcelona, 1561, fol.: *Dictionari Catala* (Lat. Fr.
 Span.), Barcelona, 1642, 8vo: Lacavalleria (Cat.-Lat.), ib. 1666, fol.:
 Ewre, ed. Bellveiga, &c. (Catal.-Sp. Lat.), Barcelona, 1805-1835,
 fol. 3 vols.: Saura (Cat.-Span.), ib. 1841, 16mo; and 2nd (Span.-Cat.),
 ib. 1854; 3rd ed. (Ed.) ib. 1862, 8vo: Labernia, ib. 1844-1848, 8vo, 2
 vols. 1864. *Gallegas*: Rodriguez, Coruña, 1863, 4to: Gouveira y Piñol,
 Madrid, 1877, 8vo. *Majorca*: Figuera, Palma, 1840, 4to: Amengual,
 2d ed. 1845, 4to. *Minorca*: *Dictionario*, Madrid, 1848, 8vo. *Valencian*:
 Pinyanov, Valentia, 1569: Roa, Valencia, 1764, 8vo: Fuster, ib.
 1876, 8vo: Lamacra, 2nd ed. ib. 1842, 16mo. *Cuba*: *Glossary of*
Crest Words, London, 1840, 8vo: Pichardo, 1836; 2nd ed. Havana,
 1849, 8vo: 3rd ed. ib. 1862, 8vo; Madrid, 1860, 4to.
 Portuguese.—Lima, Lisbon, 1783, 4to: Moraes da Silva, ib.
 1789, 4to, 2 vols.: 6th ed. 1858: Academia real das Ciencias, ib.
 1793, tom. i., ccvii, and 544 pages (A to Azurrar); Faria, ib. 1849,
 4to, 2 vols.: 3rd ed. ib. 1850-1857, fol. 2 vols. 2220 pages. ENGLISH.—
 Veyta, London, 1773, 2 vols. 4to: Lacerda, Lisboa, 1866-1871, 4to,
 2 vols. FRENCH.—Marquez, Lisboa, 1766-1761, fol. 2 vols.: Roquette,
 Paris, 1841, 8vo, 2 vols.; 4th ed. 1860: Marques, Lisabonne, 1875,
 6vo, 2 vols.: Souza Pinto, Paris, 1877, 32mo, 1024 pages. GERMAN.—
 Wagner, Leipzig, 1811-1812, 8vo, 2 vols.: Wollheim, ib. 1844, 12mo,
 2 vols.: Bouche, Hamburg, 1858, 8vo, 2 vols. 1660 pages. ITALIAN.—
 Costa e Sá, Lisboa, 1773-1774, fol. 2 vols. 1652 pages: Prefumo,
 Lisboa, 1853, 8vo, 1162 pages. ANCIENT.—Joachim de Sancta Rosa
 de Viterbo, ib. 1798, fol. 2 vols.: 1824, 8vo. ARABIC WORDS.—Souza,
 ib. 1799, 4to; 2nd ed. by S. Antonio Moura, ib. 1830, 224 pages.
ORIENTAL AND AFRICAN WORDS, NOT ARABIC.—Saô Luiz, ib. 1837,
 4to, 173 pages. FRENCH WORDS.—Id., ib. 1837, 4to; 2nd ed. Rio de
 Janeiro, 1835, 8vo. SYNONYMS.—Id., ib. 1821, 4to; 2nd ed. ib.
 1823-1828, 8vo. Fonseca, Paris, 1833, 8vo, 1590, 18mo, 863 pages.
 SYNONYMS.—De Couto, Lisboa, 1842, fol. PORTIC.—Luzitano (i.e.
 Fr.), ib. 1765, 8vo, 2 vols.; 3rd ed. ib. 1820, 4to, 2 vols. RHYMING.—
Comto Genevivo, Lisboa, 1765, 4to. NAVAL.—Tiberghien, Rio de
 Janeiro, 1870, 8vo. CEYLON-PORTUGUESE.—Fox, Colombo, 1819,
 6vo: Callaway, ib. 1823, 8vo.

fabrica del mundo, Vinesia, 1548; fol.: Porcàchi, Venetia, 1588, fol.:
Accademici della Crusca: Vocabulario, Venez. 1612, fol.; 4th ed.
 Firenze, 1729-1738, fol. 6 vols.: Costa and Cardinali, Bologna, 1819-
 1826, 4to, 7 vols.: Tommaseo and Bellini, Torino, 1861, &c., 4to, 4
 vols.: Fetrocchi, 1884-1891. ENGLISH.—Thomson, London, 1598, 4to:
 Florio, London, 1598, 4to, 1611: Baretti, London, 1770, 8vo:
 1854, 8vo, 2 vols.: Petronj and Davenport, Londra, 1828, 8vo, 3 vols.:
 Grassi, Leipz. 1854, 12mo: Millhouse, Lond., 1868, 8vo, 2 vols. 1248
 pages. FRENCH.—Alberti, Paris, 1771, 4to, 2 vols.: Milan, 1862:
 Barberi, Paris, 1838, 4to, 2 vols.: Renzi, Paris, 1850, 8vo. GERMAN.—
Libro utilissimo, Venetia, 1599, 4to: Valentini, Leipzig, 1834-1836,
 4to, 4 vols. ETYMOLOGY.—Menage, Geneva, 1685, fol.: Bolla, Vienna,
 1852, 4to. PROVENCAL WORDS.—Nannucci, Firenze, 1840, 8vo.
 SYNONYMS.—Rabbi, Venezia, 1774, 4to; 10th ed. 1817: Tommaseo,
 Firenze, 1839-1840, 4to, 2 vols.: Milano, 1856, 8vo; 1867. VERBS.—
 Mastrofino, Roma, 1814, 4to, 2 vols. SELECT WORDS AND PHRASES.—
 Redi, Brescia, 1769, 8vo. INCORRECT WORDS AND PHRASES.—
 Molassi, Parma, 1830-1841, 8vo, 854 pages. SUPPOSED GALLICISMS.—
 Viani, Firenze, 1858-1860, 8vo, 2 vols. ADDITIONS TO THE DICTION-
 ARIES.—Gherardini, Milano, 1819-1821, 8vo, 2 vols.; ib. 1852-1857,
 8vo, 6 vols. RHYMING.—Falco, Napoli, 1535, 4to: Ruscelli, Venetia,
 1563, 8vo; 1827: Stigliani, Roma, 1658, 8vo: Rosasco, Padova,
 1763, 4to: Palermo, 1840, 8vo. TECHNICAL.—Bonaviva-Aquilino,
 Mil. 1819-1821, 8vo, 5 vols.; 2nd ed. 1829-1831, 4to, 2 vols.: Vogtberg
 (Germ.), Wein, 1831, 8vo. PARTICULAR AUTHORS.—Boccaccio:
 Alano, *Le ricchezze della lingua volgare*, Vinegia, 1543, fol. *Dante*:
 Blanc, Leipzig, 1852, 8vo; Firenze, 1859, 8vo. DIALECTS.—
Bergamo: Gasparini, Mediol. 1595; Zappetini, Bergamo, 1859, 8vo.
Tiraboschi (anc. and mod.), Turin, 1873, 8vo. *Bologna*: Bumaldi,
 Bologna, 1660, 12mo: Ferrari, ib. 1820, 8vo; 1838, 4to. *Brescia*:
 Gardani, Brescia, 1759, 8vo: Melchiori, ib. 1817-1820, 8vo: *Vocabu-*
larsetto, ib. 1872, 4to.—*Como*: Monti, Milano, 1845, 8vo: *Friuli*:
 Manini, Ferrara, 1805, 8vo: Azzi, ib. 1857, 8vo: *Friuli*: Scala,
 Pordenone, 1870, 8vo. *Genoa*: Casaccia, Gen. 1842-1851, 8vo; 1873,
 &c.: Paganini, ib. 1857, 8vo. *Lombardy*: Margharini, Tuderia,
 1870, 8vo. *Mantua*: Cherubini, Milano, 1827, 4to. *Milan*: Varon,
 ib. 1606, 8vo: Cherubini, ib. 1814, 8vo, 2 vols.; 1841-1844, 8vo,
 4 vols.; 1851-1861, 8vo, 5 vols.: Banfi, ib. 1857, 8vo: 1870, 8vo.
Modena: Galvani, Modena, 1868, 8vo. *Naples*: Galiani, Napoli,
 1789, 12mo, 2 vols. *Parma*: Peschieri, Parma, 1828-1831, 8vo, 3
 vols. 1840; Malespina, ib. 1856, 8vo, 2 vols. *Paria*: *Dizionario dom-*
estico panese, Pavia, 1829, 8vo: Gambini, ib. 1850, 4to, 346 pages.
Piacenza: Nicollì, Piacenza, 1832: Foresti, ib. 1837-1838, 8vo, 2 pts.
Piedmont: Pino, Torino, 1784, 4to: Capello (Fr.), Turin, 1844, 8vo,
 2 pts.: Zalli (Ital. Lat. Fr.), Carmagnola, 1815, 8vo, 2 vols.: Sant'
 Albino, Torino, 1860, 4to. *Reggio*: *Vocabulario Reggiano*, 1832.
Romagna: Morri, Fienza, 1840. *Rome*: *Raccolto di voci Romane e*
Marchiani, Oaimo, 1769, 8vo. *Roveretano and Tremino*: Azzolini,
 Venezia, 1856, 8vo. *Sardinia*: Porru, Casteddu, 1832, fol.: Spano,
 Cagliari, 1851-1852, fol. 3 vols. *Sicily*: Bono (It. Lat.), Palermo,
 1751-1754, 4to, 3 vols.: 1783-1785, 4to, 5 vols.: Pasqualino, ib. 1785-
 1795, 4to, 5 vols.: Mortillaro, ib. 1853, 4to, 956 pages: Biundi, ib. 1857,
 12mo, 578 pages: Traina, ib. 1870, 8vo. *Siena*: Barbagli, Siena,
 1602, 4to. *Taranto*: Vincentis, Taranto, 1872, 8vo. *Turin*:
 Somis di Chariv, Torino, 1843, 8vo. *Tuscany*: Luna, Napoli, 1536,
 4to: Politi, Roma, 1604, 8vo: Venezia, 1615; 1628; 1665; Paolo,
 ib. 1740, 4to. *Vasconia*: Callet, Lausane, 1822, 12mo. *Venetian*:
 Patriarchi (*Venetiano e padovano*), Padova, 1755, 4to; 1796, 1821:
 Boerio, Venezia, 1829, 4to; 1858-1859; 1861. *Veneto*: Angeli,
 Verona, 1821, 8vo. *Vicenza*: Conti, Vicenza, 1871, 8vo. LINGUA
 FRANCA.—*Dictionnaire de la langue Franque, ou Petit Muresque*,
 Marseille, 1830, 16mo, 107 pages. SLANG.—Sabbio (lingua Zerga),
 Venetia, 1556, 8vo; 1575: *Trattato degli bianti*, Pisa, 1828, 8vo.

TEUTONIC: (1) Scandinavian.

Icelandic.—LATIN.—Andreae, Havnia, 1683, 8vo: Halderon
 (Lat. Danish), ib. 1814, 4to, 2 vols. ENGLISH.—Cleasby-Vigfusson,
 Oxford, 1874, 4to. GERMAN.—Dieterich, Stockholm, 1844, 8vo:
 Möbius, Leipzig, 1866, 8vo. DANISH.—Jonsson, Kjöbenhavn, 1863,
 8vo. NORWEGIAN.—Kraft, Christiania, 1863, 8vo: Fritzer,
 Kristiania, 1867, 8vo. PORTIC.—Egilsson (Latin), Hafniae, 1860,
 8vo; 1864.
 Swedish.—Kindblad, Stockholm, 1840, 4to: Almqvist, Örebro,
 1842-1844, 8vo: Dalin, Öradog. Stockholm, 1850-1853, 8vo, 2 vols.
 1668 pages: 1867, &c. 4to (vol. i. ii., A to Fjermare, 928 pages):
 id., *Handoräbög*, ib. 1868, 12mo, 804 pages: Svenska Academiens
 Stockholm, 1870, 4to (A) pp. 187. LATIN.—Stjernhielm, Holm,
 1643, 4to: Verelius, Upsala, 1691, 8vo: Ihre (Voco-Gothicum),

Italian.—Accargi, *Vocabulario*, Cento, 1543, 4to: Alunno, *La*

Upsala, 1769, fol. 2 vols. ENGLISH.—Serenius, Nyköping, 1757, 4to: Branson, Upsala, 1784, 4to: Widgren, Stockholm, 1788, 4to; Brisman, Upsala, 1801, 4to; 3rd ed. 1815, 2 vols.: Deleen Örebro, 1829, 8vo: Granberg, ed. 1832, 12mo: Nilssen, Widmark, &c., Stockholm, 1875, 8vo. FRENCH.—Möller, Stockholm, 1745, 4to: Björkengren, ed. 1795, 2 vols.: Nordfors, ed. 1805, 8vo, 2 vols.: 2nd ed. Örebro, 1827, 12mo: West, Stockh. 1807, 8vo: Dalin, ed. 1842—1843, 4to, 2 vols.; 1872. GERMAN.—Dähner, Holmia, 1746, 4to: Heinrich, Christiansund, 1814, 4to, 2 vols.; 4th ed. Örebro, 1841, 12mo: Helms, Leipzig, 1858, 8vo; 1872. DANISH.—Hast, Kjöbenhavn, 1799, 4to: Welander, Stockholm, 1844, 8vo: Dalin, ed. 1860, 16mo: Kaper, Kjöbenhavn, 1876, 16mo. ETYMOLOGY.—Tamm, Upsala, 1874, &c., 8vo (A and B), 200 pages. FOREIGN WORDS.—Sahlstedt, Wästerås, 1769, 8vo: Anderson (20,000), Stockholm, 1857, 16mo: Tullberg, ed. 1868, 8vo: Ekbohm, ed. 1870, 12mo: Dalin, ed. 1870, &c., 8vo. SYNONYMS.—Id., ed. 1870, 12mo. NAVAL.—Ramsten, ed. 1866, 8vo. TECHNICAL.—Jungberg, ed. 1873, 8vo. DIALECTS.—Ihre, Upsala, 1766, 4to: Riets, Lund, 1862—1867, 4to, 850 pages. *Bokusid: Idiocion Bokusianse*, Götabor, 1776, 4to. *Dalecarlia: Arborelius*, Upsala, 1813, 4to. *Göthland: Hof (Sven)*, Stockholm, 1772, 8vo: Råaf (Vdre), Örebro, 1859, 8vo. *Holland: Möller*, Lund, 158, 8vo. *Helsingland: Lenström*, ed. 1841, 8vo: *Forminnessällskap, Hudikswall*, 1870, 8vo. NORWEGIAN.—Jensen, Kjöbenhavn, 1646, 8vo: Pontoppidan, Bergen, 1749, 8vo: Hanson (German), Christiania, 1840, 8vo: Aasen, ed. 1873, 8vo, 992 pages. DANISH.—Aphelen, Kopenh. 1764, 4to, 2 vols.; 1775, 4to, 3 vols.: Molbech, Kjöbenhavn, 1833, 8vo, 2 vols.: ed. 1859, 2 vols.: Videnskabernes Selskab, ed. 1793—1805, Kalkar. ENGLISH.—Berthelson (Eng. Dan.), 1754, 4to: Wolff, London, 1779, 4to. Bay, ed. 1807, 8vo, 2 vols.; 1824, 8vo: Hornbeck, ed. 1863, 8vo: Ferral and Repp, ed. 1814, 16mo; 1873, 8vo: Rosing, Copenhagen, 1869, 8vo: Ancker, ed. 1874, 8vo. FRENCH.—Aphelen, ed. 1754, 8vo: Id., ed. 1759, 4to, 2 vols.; 2nd ed. 1772—1777, vol. I. GERMAN.—Id., ed. 1764, 4to, 2 vols.: Grönberg, 2nd ed. Kopenh. 1836—1839, 12mo, 2 vols.: 1851, Helms, Leipzig, 1858, 8vo. SYNONYMS.—Müller, Kjöbenhavn, 1853, 8vo. FOREIGN WORDS.—Hansen, Christiania, 1842, 12mo. NAVAL.—Wilsøet, Copenhagen, 1830, 8vo: Fisker (French), Kjöbenhavn, 1839, 8vo. OLD DANISH.—Molbech, ed. 1857—1868, 8vo, 2 vols. DIALECTS.—Id., ed. 1841, 8vo. *Bornholm: Adler*, ed. 1856, 8vo. *South Jutland: Kok*, 1867, 8vo. SLANG.—Kristiansen (Gadesproget), ed. 1866, 8vo, p. 452.

(2) *Germanic.*

Teutonic.—COMPARATIVE.—Meidinger, Frankf. a. M. 1833, 8vo, 2nd ed. 1836, 8vo. Gothic.—Junius, Dortrecht, 1665, 4to: 1671; 1684, Diefenbach (comparative), Frankf. a. M. 1846—1851, 2 vols. 8vo: Schulze, Magdeburg, 1848, 4to: 1867, 8vo: Skeat, London, 1868, 4to: Balg (*Comparative Glossary*), Magvike, Wisconsin, 1887—1889. UPHILAS (editions with dictionaries).—Castilionaeus, Mediol, 1829, 4to: Gabelantz and Löbe, Altenburg, 1836—1843, 4to, 2 vols.: Gaugenig, Passau, 1848, 8vo: Stamm, Paderborn, 1857: Stamm and Heyne, ed. 1866, 8vo. Anglo-Saxon.—LATIN.—Somner (Lat. Eng.), Oxonii, 1659, fol. 2 vols.: Benson, ed. 1701, 8vo: Lye (A.-S. and Gothic), London, 1772, fol. 2 vols.: Ettmüller, Quedlinburg, 1851, 8vo. 836 pages. ENGLISH.—Bosworth, London, 1838, 8vo, 721 pages: Id. (*Compendious*), 1848, 278 pages. Corson (A.-S. and Early English), New York, 1871, 8vo, 587 pages: Toller (based on Bosworth), Oxford, 1882—1898. GERMAN.—Bouterweck, Gütersloh, 1850, 8vo, 418 pages: Grein (Poets), Göttingen, 1861—1863, 8vo, 2 vols.: Leo, Halle, 1872, 8vo. English.—Cockeram, London, 1623, 8vo: 9th ed. 1650: Blount, ed. 1656, 8vo: Phillips, *The new World of Words*, London, 1658, fol.: Bailey, London, 1721, 8vo; 2nd ed. ed. 1736, fol. 24th ed. ed. 1782, 4to: Johnson, ed. 1755, fol. 3 vols.: ed. Latham, ed. 1866—1874, 4to, 4 vols. (2 in 4 parts): Barclay, London, 1774, 4to: ed. Woodward, ed. 1848: Sheridan, ed. 1800, 4to, 2 vols.: Webster, New York, 1828, 4to, 2 vols.: London, 1832, 4to, 2 vols.: ed. Goodrich and Porter, 1865, 4to: Richardson, ed. 1836, 4to, 2 vols.: Supplement, 1856: Ogilvie, *Imperial Dictionary*, Glasgow, 1850—1855, 8vo, 3 vols. (the new edition of Ogilvie by Charles Annandale, 4 vols., 1882, was an encyclopaedic dictionary, which served to some extent as the foundation of the *Century Dictionary*): Boag, Do., Edinburgh, 1852—1853, 8vo, 2 vols.: Craik, ed. 1856, 8vo: Worcester, Boston, 1863, 4to: Stormouth and Bayne, 1885; Murray and Bradley, *The Oxford English Dictionary*, 1884—; Whitney, *The Century Dict.*, New York, 1889—1891; Porter, *Webster's Internal. Dict.*, Springfield, Massachusetts, 1890; Funk, *Standard Dict.*, New York, 1894; Hunter, *The Encyclopaed. Dict.*, 1879—1888. ETYMOLOGY.—Skinner, Londini, 1671, fol.: Junius, Oxonii, 1743, fol.: Wedgewood, London, 1859—1865, 3 vols.; ed. 1872, 8vo. Skeat, Oxford, 1881; Fennell (Anglicized words), Camb. 1892. PRONOUNCING.—Walker, London, 1774, 4to: by Smart, and ed. 1846, 8vo. PRONOUNCING IN GERMAN.—Hauser, Frankf. 1793, 8vo; 3rd ed. 1807: Winkelmann, Berlin, 1818, 8vo: Voigtmann, Coburg, 1835, 8vo: Albert, Leipzig, 1859, 8vo: Bassler, ed. 1840, 16mo. ANALYTICAL.—Booth, Bath, 1836, 4to: Roget, *Thesaurus*, London, 1852, 8vo; 6th ed. 1857; Boston, 1874. SYNONYMS.—Fiozzi, London, 1794, 8vo, 2 vols.: L. [abartel], Paris,

1803, 8vo, 2 vols.: Crabb, London, 1823, 8vo; 11th ed. 1859: C. J. Smith, ed. 1871, 8vo, 610 pages. REDUPLICATED WORDS.—Wheatley, ed. 1866, 8vo. SUBNAMÉS.—Arthur, New York, 1857, 12mo, about 2600 names: Lower, ed. 1860, 4to. PARTICLES.—Le Febvre de Villebrune, Paris, 1774, 8vo. RHYMING.—Levins, *Manipulus Puerorum*, London, 1570, 4to; ed. Wheatley, ed. 1867, 8vo: Walker, London, 1775, 8vo; 1865, 8vo. SHAKESPEARE.—Nares, Berlin, 1822, 4to; ed. Halliwell and Wright, London, 1859, 8vo: Schmidt, Berlin, 1874. OLD ENGLISH.—Spelman, London [1656], fol. (A to I only); 1664 (completed); 1687 (best ed.); Coleridge (1250—1300), ed. 1859, 8vo: Stratmann (Early Eng.), Krefeld, 1867, 8vo; 2nd ed. 1873, 4to: Bradley (new edition of Stratmann), Oxford, 1891: Matzner and Bieling, Berlin, 1878—OLD AND PROVINCIAL.—Halliwell, London, 1844—1846, 8vo; 2nd ed. ed. 1850, 2 vols.: 6th ed. 1904: Wright, ed. 1857, 8vo, 2 vols.; 1862. DIALECTS.—Ray, ed. 1674, 12mo: Grise, ed. 1787, 8vo; 1790: Holloway, Lewes, 1840, 8vo; Wright, *Eng. Dialect Dict.*, London, 1898—1905, 28 vols. *Scottish*: Jameson, Edin. 1806, 4to, 2 vols.: Supplement, 1826, 2 vols.; abridged by Johnstone, ed. 1846, 8vo: Brown, Edin. 1845, 8vo: Motherby (German), Königsberg, 1826—1828, 8vo: (Shetland and Orkney), Edmonston, London, 1866, 8vo: (Banffshire), Gregor, ed. 1866, 8vo. *North Country*: Brockett, London, 1839, 8vo, 2 vols. *Berkshire*: [Lousley] ed. 1852, 8vo, *Cheshire*: Wilbraham, ed. 1817, 4to; 1836, 12mo: Leigh, Chester, 1877, 8vo. *Cumberland: Glossary*, ed. 1851, 12mo: Dickenson, Whitehaven, 1854, 12mo; Supplement, 1867: Ferguson (Scandinavian Words), London, 1856, 8vo. *Derlyshire*: Hooson (mining), Wrexham, 1747, 8vo: Sleight, London, 1865, 8vo. *Dorset*: Barnes, Berlin, 1863, 8vo. *Durham*: [Dinsdale] (Teedale), London, 1830, 12mo. *Gloucestershire*: Huntley (Cotswold), ed. 1868, 8vo. *Herefordshire*: [Sir George Cornwall Lewis], London, 1830, 12mo. *Lancashire*: Nodal and Milner, Manchester Literary Club, 1875, 8vo, Morris (Furness), London, 1869, 8vo: R. B. Peacock (Lonsdale, North and South of the Sands), ed. 1869, 8vo. *Leicestershire*: B. Evans, ed. 1848, 8vo. *Lincsashire*: Brogden, ed. 1866, 12mo: Peacock (Manley & Corringham), ed. 1877, 8vo. *Northfolk and Suffolk*: Forby, London, 1830, 8vo, 2 vols. *Northamptonshire*: Sternberg, ed. 1851, 8vo: Miss Anne E. Baker, ed. 1866, 8vo, 2 vols. 868 pages. *Somersetshire*: Jennings, ed. 1860, 8vo: W. P. Williams and W. A. Jones, Taunton, 1873, 8vo. *Suffolk*: Moor, Woodbridge, 1823, 12mo: Bowditch (Surnames), Boston, U.S., 1851, 8vo; 1858; 3rd ed. London, 1861, 8vo, 784 pages. *Sussex*: Cooper, Brighton, 1836, 8vo: Parish, Farncombe, 1875, 8vo. *Wiltshire*: Akerman, London, 1842, 12mo. *Yorkshire (North and East)*, Toone, ed. 1832, 8vo: (Craven), Carr, 2nd ed. London, 1828, 8vo, 2 vols.: (Swaledale), Harland, ed. 1873, 8vo: (Cleveland), Atkinson, ed. 1868, 4to, 653 pages: (Whitby) [F. K. Robinson], ed. 1876, 8vo: (Mid-Yorkshire and Lower Niddersdale), C. Clough Robinson, ed. 1876, 8vo: (Leeds), Id., ed. 1861, 12mo: (Wakefield), Banks, ed. 1865, 16mo: (Hallamshire), Hunter, London, 1829, 8vo. *Ireland*: (Forth and Bargo, Co. Wexford), Poole, London, 1867, 8vo. *America*: Pickering, Boston, 1816, 8vo: Bartlett, New York, 1848, 8vo; 3rd ed. Boston, 1860, 8vo; Dutch transl: by Keijzer, Gorinchen, 1854, 12mo: Germ. transl. by Köhler, Leipz. 1868, 8vo. Elwyn, Philadelphia, 1850, 8vo. *Negro English*: Kingos, St Croix, 1770, 8vo: Focke (Dutch), Leiden, 1855, 8vo: Wulschlaeger, Löbau, 1856, 8vo, 350 pages. SLANG.—Grose, London, 1785, 8vo; 1796: Hotten, ed. 1864, 8vo; 1866: Farmer & Henley (7 vols., 1890—1904). FRISIC.—Wassenbergh, Leeuwarden, 1802, 8vo: Franeker, 1806, 8vo: Outzen, Kopenh. 1837, 4to: Hiettema (Dutch), Leeuwarden, 1832, 8vo; 1874, 8vo, 607 pages: Winkler (Nederdeutsch en Friesch Dialectikon), G. Gravenhage, 1874, 8vo, 2 vols. 1025 pages. OLD FRISIC.—Warda (Germ.), Aurich, 1786, 8vo: Richtfhof, Göttingen, 1840, 4to. NORTH FRISIC.—Bendson (Germ.), Leiden, 1860, 8vo: Johansen (Föhriinger und Amrumer Mundart), Kiel, 1862, 8vo. EAST FRISIC.—Stürenburg, Aurich, 1857, 8vo. HOLLIGLAND.—Oelrichs, s. l. 1836, 16mo. Dutch.—Kok, 2nd ed. Amst. 1785—1798, 8vo, 38 vols.: Weiland, Amst. 1790—1811, 8vo, 11 vols.: Harrebomée, Utrecht, 1857, 4to; 1862—1870, 8vo, 3 vols.: De Vries and Te Winkel, Gravenh. 1864, &c., 4to (new ed. 1882—); Dale, ed. 4th ed. 1898. ENGLISH.—Hexham, ed. Manley, Rotterdam, 1675—1678, 4to: Holtrop, Dortrecht, 1823—1824, 8vo, 2 vols.: Bomhoff, Nimeguen, 1859, 8vo, 2 vols. 2232 pages: Jaeger, Gouda, 1862, 16mo: Calisch, Kiel, 1871, &c., 8vo. FRENCH.—Halma, Amst. 1710, 4to; 4th ed. 1761: Marin, ed. 1793, 4to, 2 vols.: Winkelman, ed. 1793, 4to, 2 vols.: Mook, Zutphen, 1824—1825, 8vo, 4 vols.; Gouda, 1857, 8vo, 2 vols. 2818 pages: Kramers, ed. 1859—1862, 2 vols. 16mo. GERMAN.—Kramer, Nürnberg, 1719, fol.: 1759, 4to, 2 vols.; ed. Titius, 1784, Weiland, Haag, 1812, 8vo: Terwen, Amst. 1844, 8vo. ETYMOLOGY.—Franck, 1884—1892. ORIENTAL WORDS.—Dozy, s. Gravenhage, 1867, 8vo. GENDERS OF NOUNS.—Bilderdijk, Amst. 1822, 8vo, 2 vols. SPELLING.—Id., s. Gravenhage, 1829, 8vo. FREQUENTATIVES.—De Jager, Gouda, 1875, 8vo, vol. 1. Old Dutch.—De Vries, Suniger, 1865, 8vo. MIDDLE DUTCH.—De Vries, s. Gravenhage, 1864, &c., 4to. Verwijs and Verdam, ed. 1885. Flemish.—Kilian, Antw. 1511, 8vo; ed. Hasselt, Utrecht, 1777, 4to, 2 vols. FRENCH.—Berlemont, Anvers, 1511, 4to: Meunier, ed. 1557, 8vo: Rouxel and Halma, Amst. 1708, 4to; 6th ed. 1821: Van de Velde and Slectcx, Brux. 1848—1851, 8vo, 2440 pages: Id.

1860, 8vo, 2 vols. **ANCIENT NAMES OF PLACES.**—Grandgagnage (East Belgium), Bruxelles, 1850, 8vo.
German.—Josua Pictorius (Maaler), *Die teutsch Sprach*, Tiguri, 1601, 8vo; Stieler, Nürnberg, 1691, 4to; Adelung, Leipzig, 1774-1786, 4to, 5 vols.; 1793-1818, 5 vols.; Campe, Braunschweig, 1807-1811, 4to, 5 vols.; Grimm, Leipzig, 1854, &c., 4to; Sanders, ib. 1860-1865, 4to, 3 vols. 1845: Dielenbach and Wülcker (High and Low German, to supplement Grimm), Frankfurt, M., 1874, 1885, 8vo.; Kluge, Strassburg, 1883; Heine, Leipzig, 1890-1895; Weigand, Gießen, 1873. **ENGLISH.**—Adelung, 1783-1796, 8vo, 3 vols.; Hilpert, Karlsruhe, 1828-1829, 8vo, 2 vols.; 1845-1846, 4to, 2 vols.; Flügel, Leipzig, 1830, 8vo, 2 vols.; London, 1857, 8vo.; Leipzig, 1870: Müller, Cöthen, 1867, 8vo, 2 vols. **FRENCH.**—Laveaux, Strassburg, 1812, 4to; Mozin, Stuttgart, 1811-1812, 4to, 4 vols.; 1842-1846, 8vo, 4 vols., 3rd ed. 1850-1851, 8vo.; Schuster, Strassb., 1859, 8vo.; Daniel, Paris, 1877, 16mo. **OLD HIGH GERMAN.**—Haltaeus, Lipsiæ, 1758, fol. 2 vols.; Graff, Berlin, 1834-1846, 4to, 7 vols.; Brückmeier, Götta, 1850-1863, 4to, 2 vols.; Kehren (from Latin records), Nordhausen, 1863, 8vo. Schade, Halle, 1873-1882. **MIDDLE HIGH GERMAN.**—Zemann, Quedlinburg, 1838, 8vo.; Benecke, Müller and Zarncke, Leipzig, 1854-1866, 8vo, 3 vols.; Lexer, Leipzig, 1870, 8vo. **MIDDLE LOW GERMAN.**—Schiller and Lubben, Bremen, 1872, &c., 8vo, in progress. **Low German.**—Vollberg, Zerbst, 1806, 8vo.; Kosegarten, Griefswald, 1839, 4to.; 1856, &c., 4to. **ETYMOLOGY.**—Heimgang, Hanov. 1620, 8vo.; Wachter, Lipsiæ, 1737, fol. 2 vols.; Kündl, Salzburg, 1815-1830, 8vo, 7 vols.; Heyse, Magdeburg, 1843-1849, 8vo, 3 vols.; Kehren, Wiesbaden, 1847-1852, 2 vols. **SYNONYMS.**—Eberhard, Maas, and Grüber, 4th ed. Leipzig, 1852-1863, 8vo, 4 vols.; Aue (Engl.), Edinb. 1836, 8vo.; Eberhard, lithed. Berlin, 1854, 12mo.; Sanders, Hamburg, 1872, 8vo, 743 pages. **FOREIGN WORDS.**—Campe, Braunschweig, 1813, 4to.; Heyse, *Fremdwörterbuch*, Hannover, 1848, 8vo. **NAMES.**—Pott, Leipzig, 1853, 8vo.; Michaelis (Tafelnamen), Berlin, 1856, 8vo.; Forstemann (Old Germ.) Nordhausen, 1856-1859, 4to, 2 vols. 1573 pages, 12,000 names; Steub (Oberdeutschen), München, 1871, 8vo. **LUTHER.**—Dietz, Leipzig, 1669-1872, 8vo, 2 vols. **DIALECTS.**—Popowitsch, Wien, 1780, 8vo.; Faid, Berlin, 1788, 8vo.; Klein, Frankf., 1792, 8vo, 2 vols.; Kalt-schmidt, Nördlingen, 1851, 4to.; 1854, 5th ed. 1865. *Aix-la-Chapelle*, Müller and Weitz, Aachen, 1836, 12mo. *Appenzell*: Tobler, Zürich, 1837, 8vo. *Austria*: Höfer, Linz, 1815, 8vo.; Castelli, Wien, 1847, 12mo.; Scheuchstül (mining), ib. 1856, 8vo. *Bavaria*: Zauper, München, 1789, 8vo.; Deling, ib. 1820, 2 vols.; Schmeller, Stuttg. 1827-1837, 8vo, 4 vols.; 2nd ed. München, 1872, 4to, vol. 1, 1799 pages. *Berlin*: Trachsel, Berlin, 1873, 8vo. *Bremen*: Bremisch Deutsch Gesellschaft, Bremen, 167-1771, 1869, 8vo, 6 vols. *Öberich* (anc. statutes), Frankf. a. M., 1767, 8vo. *Carinthia*: Ueberleider, Klagenfurt, 1862, 8vo.; Lexe, Leipzig, 1862, 8vo. *Cleves*: De Schueren, *Teutonia*, Colon, 1477, fol.; Leiden, 1804, 4to. *Galizien*: Schambach, Hannover, 1838, 8vo. *Hamburg*: Richey, Hamb. 1873, 4to.; 1755, 8vo. *Henneberg*: Reinwald, Berlin and Steirn, 1793, 1801, 8vo, 2 vols.; Brückner, Meiningen, 1843, 4to. *Hesse*: Vilmor, Marburg, 1868, 8vo, 488 pages. *Holstein*: Schutz Hamb. 1800, 8vo, 8 vols. *Hungary*: Schoer, Wien, 1858, 12mo. 2 parts. *Upper Lusatia*: Anton, Görlitz, 1825-1839, 13 parts. *Luzemburg*: Gangler, Lux. 1847, 8vo, 406 pages. *Mecklenburg* and *Westen Pomerania*: M., Leipzig, 1876, 8vo, 114 pages. *Nassau*: Kehreia, Weilburg, 1860, 8vo. *Osnabrück*: Strodttmann, Leipz. 1756, 8vo. *Pomerania* and *Rügen*: Dähnert, Stralsund, 1781, 4to. *Posen*: Bernd, Bonn, 1820, 8vo. *Prussia*: Bock, Königsb., 1759, 8vo.; Hennig, ib. 1785, 8vo. *Saxony*: Schmeller (from Heland, &c.), Stuttg. 1840, 4to. *Silesia*: Berndt, Stendal, 1787, 8vo. *Swabia*: Schmid, Berlin, 1795, 8vo.; Stuttg. 1831, 8vo. *Switzerland*: Sailer, Aarau, 1807-1813, 8vo, 2 vols. *Thuringia*: Keller, Jena, 1819, 8vo. *Transylvania*: Schuller, Prag, 1865, 8vo. *Tirol*: Schopf, Innsbruck, 1866, 8vo. *Venetian Alps*: Schmeller, Wien, 1854, 8vo. *Vienna*: Hugel, ib. 1873, 8vo. **HUNTING.**—*Westerwald*: Schmidt, Hadamar, 1800, 8vo.; Kehren, Wiesbaden, 1871, 12mo. **NASC.**—*Gauser Sprache*: Schott, Erlangen, 1821, 8vo.; Grolmann, Gessen, 1822, 8vo.; Train, Meissen, 1833, 8vo.; Anton, 2nd ed. Magdeburg, 1843, 8vo.; 1859: Avé-Lallemant, *Das Deutsche Geschlecht*, Leipzig, 1858-1862, 8vo, vol. iv. pp. 515-628. *Student Sprach*: Vollmann (Burschicoses), Ragaz, 1846, 16mo, 562 pages.

Celtic.

Celtic generally.—Lloyd, *Archæologia Britannica*, Oxford, 1797, folio; Bullet, Besançon, 1754-1860, fol. 2 vols.
Irish.—Cormac, bishop of Cashel, born 831, slain in battle 903, wrote a Glossary, *Sanas Cormaic*, printed by Dr Whitley Stokes, London, 1862, 8vo, with another, finished in 1609, by O'Davoren, a schoolmaster at Burren Castle, Co. Clare; O'Clery, Lovanii, 1643, 8vo.; Mac Curtin (Eng.-Irish), Paris, 1732, 4to.; O'Brien, ib. 1768, 8vo.; Duhan, 1832, 8vo.; O'Reilly, 1817, 4to.; 1821; ed. O'Donovan, 2d. 1864, 4to, 725 pages; Foley (Eng.-Irish), ib. 1855, 8vo.; Concellan ib. 1863, 8vo.
Gaelic.—MacDonald, Edin. 1741, 8vo.; Shaw, London, 1780, 8vo.; Allan, Edin. 1804, 4to.; Armstrong, London, 1825, 8vo.; Highland Society, ib. 1828, 4to, 2 vols.; Macleod and Dewar, Glasgow, 1853, 8vo.
Manx.—Cregeen, Douglas, 1835, 8vo.; Kelly, ib. 1866, 8vo, 2 vols.

Welsh.—LATIN.—Davies, London, 1632, fol.; Boxhornius, Amstelodami, 1644, 4to. **ENGLISH.**—Salesbury, London, 1547, 4to; 1551: Richards, Bristol, 1759, 8vo.; Owen (W.), London, 1793-1794, 8vo, 2 vols.; 1803, 4to, 3 vols.; Walters, ib. 1794, 4to.; Owen-Pughe, Denbigh, 1832, 8vo.; 3rd ed. Fryse, ib. 1866, 8vo.; D. S. Evans (Eng.-Welsh), ib. 1852-1853, 8vo.; 1887.

Cornish.—Pryce, *Archæologia*, Sherborne, 1770, 4to.; Williams, Llandoverly, 1862-1865, 4to. **NAMES.**—Bannister, (20,000), Truro, 1869-1871, 8vo.

Breton.—Legadeuc, *Le Catholicon breton*, finished 1464, printed at Lantrequier, 1490, fol. 210 pages; 1501, 4to.; L'Orient, 1868, 8vo.; Quicquer de Roskoff, Morlaix, 1633, 8vo.; Rostrene, Rennes, 1732, 4to, 978 pages; ed. Jolivet, Guingamp, 1834, 8vo, 2 vols.; l'A. [Armerie], Leyde, 1744, 8vo.; La Haye, 1756: Lepelletier, Paris, 1752, fol.; Legonidec, Angouleme, 1821, 8vo.; St Briec, 1647-1850, 4to, 924 pages. **DIALECT OF LÉON.**—Troude (Fr.-Bre.), Rest, 1870, 8vo.; Id. (Bre.-Fr.), ib. 1876, 8vo, 845 pages. **DIOCESE OF VANNES.**—Armerie, Leyde, 1774, 8vo.

Basque.

Basque.—Larramendi, St Sebastian, 1745, fol. 2 vols.; ed. Zuazua, ib. 1854, fol.; Chaho, Bayonne, 1856, 4to, 1867; Fabre, ib. 1870, 8vo.; Van Eys, Paris, 1873, 8vo.; Eguren, Madrid, 1877.

Baltic.

Lithuanian.—Szyrwid, 3rd ed., Vilnae, 1643, 8vo.; 5th ed. 1713: Schleicher, Prag, 1856-1857, 8vo, 2 vols.; Kurmin, Wilno, 1858, 8vo.; Kurschat, Halle, 1870, &c., 8vo.

Lettic.—Mancius, Riga, 1638, 4to.; Elvera, ib. 1748, 8vo.; Lange, Mitau, 1777, 4to.; Sjögren, Petersburg, 1861, 4to.; Ulmann, ed. Bielenstein, Riga, 1872, &c., 8vo.

Prussian.—Bock, Königsberg, 1759, 8vo.; Hennig, ib. 1785, 8vo.; Nesselmann, Berlin, 1873, 8vo.; Pierson, ib. 1875, 8vo.

Slavonic.

Slavonic generally.—Franta-Sumavski (Russ. Bulg. Old Slav. Boh. Polish), Praga, 1857, 8vo.; Miklosich, Wien, 1866.

Old Slavonic.—Berunda, Kiev, 1627, 8vo.; Kuteinsk, 1653, 4to.; Polycarpi (Slav. Greek, Latin), Mosq., 1704, 4to.; Alexyeev, St Petersburg, 1773, 8vo.; 4th ed. ib. 1817-1819, 8vo, 5 vols.; Russian Imp. Academy, ib. 1847, 4to, 4 vols.; Miklosich, Vindobonæ, 1850; 4to.; 1862-1865, 8vo.; Mikhailovskii, St Petersburg, 1875, 8vo.; Charkovski, Warschau, 1873, 8vo.

Russian.—Russian Academy, St Petersburg, 1789-1794, 4to, 6 vols.; 1806-1822, ib. 1860, 8vo, 3 vols.; Dahl, Moskva, 1862-1866, fol. 4 vols.; d. ib. 1873, &c., 4to.; 3rd edition, 1903, &c. **FRENCH-GERM.-ENG.**—Reiff, ib. 1852-1854, 4to. **GERMAN, LATIN.**—Holtherhof, Moskva, 1778, 8vo, 2 vols.; 3rd ed. 1853-1855, 8vo, 2 vols.; Weismann, ib. 1731, 4to.; 1782, and frequently. **RUSSIAN, GERMAN.**—Nordstedt, ib. 1780-1782, 4to, 2 vols.; Heym, Moskva, 1796-1805, 4to, 4 vols.; Boock-Arkoss, and Frey, Leipzig, 1871, &c., 8vo. **ENGLISH.**—Nordstedt, London, 1780, 4to.; Grammatin and Parenogo, Moskva, 1808-1817, 4to, 4 vols. **FRENCH.**—Tatischeff, 2nd ed. St Petersburg, 1798, 8vo, 2 vols.; Moskva, 1816, 4to, 2 vols.; Reiff, St Petersburg, 1835-1836, 8vo, 2 vols.; Makaroff, ib. 1872, 8vo, 2 vols. 1110 pages; 1873-1874, 12mo, 2 vols. **GERMAN.**—Pawlowiki, Riga, 1850, 8vo.; Lenström, Mitau, 1871, 8vo. **SWEDISH.**—Geitlin, Helsingfors, 1833, 12mo.; Meurmann, ib. 1846, 8vo. **POLISH.**—Jakubowicz, Warszawa, 1825-1828, 8vo, 2 vols.; Amazewicz, ib. 1866, 8vo.; Salezjgier, ib. 1867, 8vo. **TECHNICAL.**—Grakov (Germ.), St Petersburg, 1872, 8vo. **NAVAL.**—Butakov, ib. 1837. **DIALECTS.**—*North-west Russia*: Gorbachevski (old language, in Russian), Vilna, 1874, 8vo, 418 pages. *White Russia*: Noovitch (Russian), St Petersburg, 1870, 4to, 760 pages. *Red Russia*: Patritzkii (German), Lémberg, 1867, 8vo, 2 vols. 842 pages. *Ukraine*: Piskanov (Russian), Odessa, 1873, 4to, 156 pages.

Polish.—Linde (explained in Lat. Germ. and 13 Slav dialects), Warszawa, 1807-1814, 4to, 6 vols. 4574 pages. **ENGLISH.**—[Ryka-czewski], *Complete Dictionary*, Berlin, 1849-1851, 8vo, 2 vols. Ryka-czewski, Berlin, 1866, 16mo, 1161 pages. **FRENCH AND GERMAN.**—Troc, Leipz. 1742-1764, 8vo, 4 vols.; 4th ed. ib. 1806-1822, 4to, 4 vols.; Bandtke, Breslau, 1806, 8vo, 2 vols.; 1833-1839, 8vo. **FRENCH.**—Schmidt, Leipzig, 1870, 16mo. **RUSSIAN AND GERMAN.**—Schmidt (J. A. E.), Breslau, 1834, 8vo. **GERMAN.**—Mrongovius, Königsberg, 1765; 1835, 4to.; 1837: Troianski, Berlin, 1835-1838, 8vo, 2 vols.; Boock-Arkossi, Leipzig, 1864-1868, 8vo, 2 vols.; Jordan, ib. 1866, 8vo. **ITALIAN.**—Plazowski, Warszawa, 1860, 8vo, 2 vols. 730 pages. **RUSSIAN.**—Potocki, Lipak, 1873, &c., 12mo.

Wendish.—Marthall, Budissen, 1721, 8vo.; Bose, Gümna, 1840, 8vo.; Pfuhl, w. Budzinsje, 1866, 8vo, 1210 pages. **UPPER LUSATIAN.**—Pfuhl and Jordan, Leipz. 1844, 8vo. **LOWER LUSATIAN.**—Zwahr, Spremberg, 1847, 8vo.

Czech.—Rohn (Germ. Lat.), Prag, 1780, 4to, 4 vols.; Dobrowski and Hanka, ib. 1802-1821, 4to, 2 vols. **LAT. GERM. HUNGAR.**—Lungmann, Prage, 1835-1839, 4to, 531 pages. **HUNGAR.**—Tham, Prag, 1805-1807, 8vo, 2 vols.; Sumavski, ib. 1844-1846, 8vo, 2 vols.; Konecny, ib. 1855, 18mo, 2 vols.; Rank (Germ. Boh.), ib. 1860, 16mo, 775 pages. **TECHNICAL.**—Spatny, ib. 1864, 8vo.; Kheil (names of goods, Germ. Boh.), ib. 1864, 8vo, 432 pages. **HUNTING.**—Spatny, ib. 1870, 8vo, 137 pages.

South Slavic.—Richter and Ballman, Wien, 1839—1840, 8vo, 2 vols. **SERBIAN.**—Karajić (Germ. Lat.), *ib.* 1818, 8vo; 1852: Lavrovski (Russian), St Petersburg, 1870, 8vo, 814 pages. **BOSNIAN.**—Micalia, Laureti, 1649, 8vo. **SLOVAK.**—Bernolak (Lat. Germ. Hung.), Budaë, 1825—1827, 8vo, 6 vols.: Loos (Hung. and Germ.), Pest, 1869, &c., 3 vols. **SLOVENE.**—Gutschmann, Klagenfurt, 1789, 4to; Relkovich, Wien, 1796, 4to, 2 vols.: Murko, Grätz, 1838, 8vo, 2 vols.: Janetzki, Klagenfurt, 1851, 12mo. **DALMATIAN.**—Ardelio della Bella, Venezia, 1728, 8vo; 2nd ed. Ragusa, 1785, 4to; Stulli, *ib.* 1801—1810, 4to, 2 vols. **CROATIAN.**—Habdelski, Grätz, 1670, 8vo; Sulek, Agram, 1854—1860, 8vo, 2 vols. 1716 pages. **CARINTHIAN.**—Lezer, Leipzig, 1862, 8vo. **OLD SERBIAN.**—Danitzky (Serbian), Belgrad, 1864, 8vo, 3 vols. **Bulgarian.**—Daniel (Romain, Albanian, Rumanian, and Bulgarian), Moschopolis, 1770; Venice, 1802, 4to. **ENGLISH.**—Morse and Vassiliev, Constantinople, 1860, 8vo. **RUSSIAN.**—Borogoff, Vienna, 1872, &c., 8vo.

Ugrian.

Ugrian, Comparative.—Donner, Helsingfors, 1874, 8vo, in progress: Budenz (Ugrian-Magyar), Budapest, 1873—1875, 8vo. **Lappish.**—*Manuale*, Holmiaë, 1648, 8vo; Fjellström, *ib.* 1738, 8vo; Leem and Sandberg, Havn. 1768—1781, 4to, 2 parts: Lindahl and Oehring, Holm. 1780, 8vo. **NORTH LAPPISH.**—Stockfleht, Christiania, 1852, 8vo. **Finnish.**—Juselius, Holmiaë, 1745, 4to, 567 pages: Renvall, Aboë, 1826, 4to, 2 vols.: Europæus, Helsingiaä, 1852—1853, 16mo, 2 vols. 742 pages: Lunin, Derpt, 1853, 8vo; Eürin, Vaasaus, 1860, 8vo; Ahlman, *ib.* 1864, 8vo; Wiedemann, St Petersburg, 1869, 4to; Godenhjelm (Germ.), Helsingfors, 1871; Lönnrot, Helsingiaä, 1874. **NAVAL.**—Stjerncreutz, *ib.* 1863, 8vo. **Esthonian.**—Hupel, Mitau, 1818, 8vo, 832 pages: Körber, Dorpat, 1860, 8vo; Wiedemann, St Petersburg, 1869, 4to, 1002 pages: Aminoff (Esth.-Finnish), Helsingiaä, 1869, 8vo; Meves (Russian), Riga, 1876, 12mo. **Permian.**—Rogord (Russian), St Petersburg, 1869, 8vo, 430 pages. **Votjak.**—Wiedemann, Reval, 1847, 8vo; Ahlquist, Helsingfors, 1856, 4to. **Cheremissa.**—Budenz, Pest, 1866, 8vo. **Ersä-Mordvine.**—Wiedemann, St Petersburg, 1865, 4to. **MOKSHA-MORDVINE.**—Ahlquist, *ib.* 1862, 8vo. **Hungary.**—Szabo, Kassan, 1792, 8vo; Guczor and Fogarazi (Hung. Academy), Pesth, 1862, 8vo, in progress. **ENGLISH.**—Dallos, Pesth, 1860, 8vo. **FRENCH.**—Kiss, *ib.* 1844, 12mo, 2 vols.: Karady, Leipz, 1848, 12mo; Mole, Pest, 1865, 8vo, 2 vols. **GERMAN.**—Schuster, Wien, 1838, 8vo; Bloch, Pesth, 1857, 4to, 2 vols.: Ballagi, *ib.* 1857, 8vo; 6th ed. 1905, 8vo, 2 vols.: Loos, *ib.* 1870, 8vo, 914 pages. **ETYMOLOGICAL.**—Dankovsky (Lat.-Germ.), Pressburg, 1853, 8vo; Kresznicas (under roots, in Hung.), Budán, 1831—1832, 4to, 2 vols.: Podhorsky (from Chinese roots, in Germ.), Budapest, 1877, 8vo. **NEW WORDS.**—Kunoss, Pesth, 1836, 8vo; 1844.

Turkish.—**ARAB.**—Pérs.—Esad Effendi, Constantinople, 1802, fol. **ROMAIC.**—Alexandrië, Vienna, 1812, 4to. **POLYGLOTTS.**—Pianzola (Ital. Grec. volgare, e Turca), Padova, 1799, 4to; Ciackiak (Ital. Armeno, Turco), Venice, 1804, 4to; 2nd ed. 1829: Azarian (Ellenico, Ital. Arm. Turco), Vienna, 1848, 8vo; Mechitarist Congregation (Ital. Francesc. Arm. Turco), *ib.* 1846, 8vo. **LATIN.**—Mesgnien-Meninski, Viennæ, 1680, fol. 3 vols.; ed. Jenisch and Klez, *ib.* 1780—1802, fol. 4 vols. **ENGLISH.**—Sauerwein, London, 1855, 12mo; Redhouse, *ib.* 1856, 8vo, 1176 pages: Id. Eng. Turkish, *ib.* 860, 8vo. **FRENCH.**—Kieffer and Bianchi (Turk.-Fr.), Paris, 1835—1837, 2 vols. 2118 pages: Bianchi (Fr.-Turk.) Paris, 1843—1846, 8vo, 2 vols. 2287 pages; 1850, 8vo, 2 vols.: Mallouf, *ib.* 1863—1867, 8vo, 2 vols. **FRENCH AND GERMAN.**—Zenker (Arab. Pers.), Leipz, 1862—1876, 4to, 2 vols. 982 pages. **GERMAN.**—Korabinsky, Pressburg, 1788, 8vo; Vambéry, Constantinople, 1858, 8vo. **ITALIAN.**—Molina, Roma, 1641, 8vo; Masais, Firenze, 1677, 8vo; Cindyrky, Milano, 1832—1834, 4to, 2 vols. **RUSSIAN.**—Budagov (Comparative lexicon of the Turkish-Tartar dialects), St Petersburg, 1869, 8vo, 2 vols.

Gipsy.—Bischoff, Ilmenau, 1827, 8vo; Truxillo, Madrid, 1844, 8vo; Jimenes, Sevilla, 1846, 16mo; Baudrimont, Bordeaux, 1862, 8vo; Vaillant, Paris, 1868, 8vo; Paspatis, Constantinople, 1870, 4to; Borrow, *Romany Lavo Lid*, London, 1874, 8vo; Smart and Crofton, London, 1875, 8vo.

Albanian.—Blanchus, Romæ, 1635, 8vo; Kaballioti (Romain, Wallach. Alb.), Venice, 1770, 8vo; Xylander, Frankfurt a. M. 1835, 8vo; Hahn, Jena, 1854, 4to; Rossi da Montalto, Roma, 1866, 8vo.

ASIA

Semitic.—**POLYGLOTTS.**—Thurneissius, Berolini, 1585, fol.; Thorndike, London, 1635, fol.; Schindler, Pentaglotton, Frankf, ad M. 1653, fol.; Hottinger, Heptaglotton, *ib.* 1661, fol.; Castellus, London, 1669, fol. 2 vols. (Hebrew, Chaldaic, Syriac, Samaritan, Aethiopic and Arabic in one alphabet; Persian separately). It occupied him for seventeen years, during which he worked sixteen to eighteen hours a day): Otho, Frankf. a. M. 1702, 4to (the same languages with Rabbinical).

Hebrew.—About 875, Zemah, head of the school of Pumbeditha, wrote a Talmudical dictionary of words and things, arranged in alphabetical order, which is lost. About 880, Jehudah ben 'Alan, of Tiberias, and Jehudah ibn Koreish, of Tahurt, in Morocco wrote Hebrew dictionaries. Saadia ben Joseph (born 902, died 942), of Fayum, in Upper Egypt, wrote *1789*, probably a Hebrew-Arabic dictionary. Menabem ben Jacob Ibn Saruq (born 910, died about 970), of Tortosa and Cordova, wrote a copious Hebrew dictionary, first printed by Herschell F. Filipowski, Edinburgh, 1855, 8vo, from five MSS. David ben Abraham, of Fäs, wrote, in Arabic, a large Hebrew dictionary, the MS. of which, a quarto of 313 leaves on cotton paper, was found about 1830 by A. Firkowitz, of Eupatoria, in the cellar of a Quarante synagogue in Jerusalem. The age of this work cannot be ascertained. About 1080, Ali ben Sulaiman wrote a dictionary in Arabic, on the plan of that of David ben Abraham. The MS. of 429 leaves belongs to Firkowitz. Haja ben Sherira, the famous teacher of the Academy of Pumbeditha, wrote a Hebrew dictionary in Arabic, called *al Hâbi* (The Gathering), arranged alphabetically in the order of the last radical letter. This dictionary is lost, as well as that of the Spaniard Isaac ben Saul, of Lucena. Iona ibn Ganah, of Cordova, born about 985, wrote a Hebrew dictionary in Arabic called *Kitâb al Asul* (Book of Roots). This, as well as a Hebrew translation by Samuel ibn Tabôn, is extant in MS., and was used by Gesenius in his *Thesaurus*. Rabbi David ben Joseph Kimhi died soon after 1232. His lexicon of roots, called *sew*, was printed at Naples 1490, fol.; Constantinople, 1513, fol.; Naples, 1491, 8vo; Venice, 1552; Berolini, 1838, 4to. *Tishbi* (The Tishbite), by Elijah ben Asher, the Levite, so called because it contained 712 roots, was printed at Inny 1541, 8vo and 4to, and often afterwards. **LATIN.**—Münster, Basileæ, 1523, 8vo; 5 editions to 1564: Zamora, Compluti, 1526, fol.; Pellicanus, Argentorati, 1540, fol.; Reuchlin, Basil, 1556, fol.; Avenarius, Wittebergæ, 1568, fol.; auctus, 1589; Pagnini, Lugd. Bat. 1575, fol.; 1577: Geneva, 1614; Buxtorf, Basil, 1607, 8vo; 1615, and many other editions: Frey (Lat.-Eng.), 2nd ed. London, 1815, 8vo; Gesenius, *Thesaurus*, Leipz, 1829—1858, 4to, 3 vols. **ENGLISH.**—Bale, London, 1767, 4to; Parkhurst, *ib.* 1792, 4to; Lee, *ib.* 1840, 8vo; Gesenius, translated by Robinson, *ib.* 1844, 8vo; by Tregelles, *ib.* 1846, 4to; Fuerst, 4th ed. transl. by Davidson, *ib.* 1866, 8vo; 1871, 8vo, 1547 pages. **FRENCH.**—Leigh, Amst. 1703, 4to; Claire, Paris, 1830, 8vo; 1843. **GERMAN.**—Gesenius, Leipz, 1810—1812, 8vo, 2 vols.; Fuerst, *ib.* 1842, 16mo; *ib.* 1876, 8vo, 2 vols. **ITALIAN.**—Modena, Venetia, 1612, 4to; 1640; Coen, Reggio, 1811, 8vo; Fontana, Venezia, 1824, 8vo. **DUTCH.**—Wattman, Rotterdam, 1859, &c., 8vo. **HUNGARIAN.**—Ehrentheil (Pentateuch), Pest, 1868, 8vo. **ROMAIC.**—Loundes, Melitè, 1845, 8vo, 987 pages.

Rabbinical and Chaldaic.—Nathan ben Yehiel of Rome wrote in the beginning of the 12th century a Talmudic dictionary, *Arach*, printed 1480 (?), s. l., fol.; Pesaro, 1517, fol.; Venice, 1531; and often: Isaiab ben Loeb, Berlin, wrote a supplement to *Arach*, vol. i. Breslau, 1830, 8vo; vol. ii. (7 to n), Wien, 1859, 8vo; Münster, Basil, 1527, 4to, 1530, fol.; Elijah ben Asher, the Levite; transl. by Fagius, Isnaë, 1541, fol.; Venet. 1560; David ben Isaac de Poma, *Zamâh David*, Venet. 1587, fol.; Buxtorf, Basileæ, 1639, fol.; ed. Fischer, Leipz. 1866—1875, 4to; Otho, Geneva, 1675, 8vo; Altona, 1757, 8vo; Zanolini, Pataui, 1747, 8vo; Hornheim, Halle, 1807, 8vo; Landau, Prag, 1819—1824, 8vo, 5 vols.; Dessauer, Erlangen, 1838, 8vo; Nork (i. e. Korn), Grizma, 1842, 4to; Schönhaak, Warschau, 1858, 8vo, 2 vols. **TARGUMS.**—Levy, Leipz, 1866—68, 4to, 2 vols.; 1875; Id. (Eng.), London, 1869, 8vo, 2 vols. **TALMUD.**—Löwy (in Heb.), Wien, 1863, 8vo; Levy, Leipz, 1876, &c., 4to. **PRAYER-BOOK.**—Hecht, Kreuznach, 1860, 8vo; Nathan, Berlin, 1854, 12mo. **SYNONYMS.**—Pantavitiuss, Lodevae, 1640, fol. **FOREIGN WORDS.**—Rabeini, Lemberg, 1857, 8vo, &c. **JEWISH-GERMAN.**—Callenberg, Halle, 1736, 8vo; Volldeding, Hamburg, 1808, 8vo; Stern, München, 1833, 8vo, 2 vols.; Theile, Berlin, 1842—1843, 8vo, 2 vols.; Avé-Lallemant, *Das deutsche Gannethum*, Leipz, 1858, 8vo, 4 vols.: vol. iv. pp. 321—812.

Phœnician.—M. A. Levy, Breslau, 1864, 8vo. **Samaritan.**—Crinesius, Altdorphi, 1613, 4to; Morini, Parisiis, 1657, 12mo; Hilligerus, Wittebergæ, 1679, 4to; Cellarius, Cizæ, 1682, 4to; Frankol. 1705; Uhlmann, Leipsicæ, 1837, 8vo; Nicholls, London, 1859, 8vo.

Assyrian.—Norris, London, 1868, 8vo, 3 vols. **PROPER NAMES.**—Menapi, Paris, 1861, 8vo.

Arcadian.—Lenormant, Paris, 1875, 8vo.

Syriac.—Joshua ben Ali, a physician, who lived about 885, made a Syro-Arabic lexicon, of which there is a MS. in the Vatican. Hoffmann printed this lexicon from Alif to Mim, from a Gotha MS. Kiel, 1874, 4to. Joshua bar Bahlul, living 963, wrote another, great part of which Castellus put into his lexicon. His MS. is now at Cambridge, and, with those at Florence and Oxford, was used by Bernstein. Elias bar Shinaya, born 975, metropolitan of Nisibis, 1009, wrote a Syriac and Arabic lexicon, entitled *Kitâb êl Tarjuman fî Taalem Loghat es Sairân* (Book called the Interpreter for teaching the Language of the Syrians), of which there is a MS. in the British Museum. It was translated into Latin by Thomas à Novaria, a Minorite friar, edited by Germanus, and published at Rome by Obicinus, 1636, 8vo. It is a classified vocabulary, divided in 30 chapters, each containing several sections. Crinesius, Wittebergæ.

1612, 4to; Buxford, Basileæ, 1622, 4to; Ferrarius, Romæ, 1622, 4to; Trost, Cöthenis Anhaltor, 1643, 4to; Cutbir, Hamburgi, 1667, 8vo; Schaaf, Lugd. Bat. 1708, 4to; Zanolini, Patavii, 1742, 4to; Castellus, ed. Michaelis, Göttingen, 1788, 4to, 2 vols.; Bernstein, Berlin, 1807, &c. fol.; Smith (Robt. Paine), Dean of Canterbury, Osmun, 1868, &c. fol. 1-3 contain 538 pages; Zingerle, Romæ, 1873, 8vo, 148 pages.

Arabic.—The native lexicons are very many, voluminous and copious. In the preface to his great Arabic-English lexicon, Lane describes 53, the most remarkable of which are—the *Ain*, so called from the letter which begins its alphabet, commonly ascribed to al Khafî (who died before A. H. 175 [A. D. 791], aged seventy-four); the *Sihah* of Jahubîr (died 398 [1003]); the *Mohkam* of Ibn Sidah the Andalusian, who was blind, and died A. H. 458 [A. D. 1066], aged about sixty; the *Asas* of Zamakhsharî (born 407 [1075], died 538 [1144]), "a most excellent repertory of choice words and phrases"; the *Lisân* of 'Arab of Ibn Mukarram (born 630 [1232], died 711 [1311]); Lane's copy is in 28 vols. 4to; the *Kamus* (The Sea) of Fairuzabadi (born 729 [1328], died 816 [1413]); the *Taj el 'Arus*, by Murtaदा E Zebadi (born A. D. 1732, died 1791)—the copy made for Lane is in 24 vols. thick 4to. The *Sihah* was printed Hardevrici Getorum, 1774, 4to; Bulak, 1865, fol. 2 vols.; *Kamus*, Calcutta, 1817, fol. 2 vols.; Bombay, 1855, fol. 920 pages; *Sirr el Lagal*, by Farîsh esh Shidiac, Tunis, fol. 609 pages; *Muhit ul Muhit*, by Beitrus Al Bustani Beirut, 1867-1870, 2 vols. 4to, 2358 pages (abridged as *Kaz Al Muhit*, 1867-1869, 2 vols. 8vo, 2352 pages), is excellent for spoken Arabic. **Persian.**—The *Surah*, by Jumal, Calcutta, 1812-1815, 2 vols. 4to; *Samaksharî Lexicon*, ed. Wetstein, Leipzig, 1845, 4to; 1850; *Muntakhal ul Lughat*, Calcutta, 1808; 18; 1830; Lucknow, 1845; Bombay, 1862, 8vo; 2 vols.; *Muntaha l'Arabî*, 4 vols. fol. 1840; *Shams ul Lughat*, Bombay, 1860, fol. 2 vols. 509 pages.

TURKISH.—*Aksharî Kabir*, Constantinople, 1827, fol. 2 vols. 4to; 1816, fol. vols.; translated by Açan Effendi, Bulak, fol. 3 vols.; El *Sihah*, translated by Al Vani, Constantinople, 1728, fol. 2 vols. 1755-1756; Scutari, 1802, fol. 2 vols. **LATIN.**—Raphelengius, Leiden, 1613, fol.; Giggeus, Mediolani, 1632, fol. 4 vols.; Golius Lugd. Bat. 1653, fol. (the best before Lane's); Jahn, Vindobonæ, 1802, 8vo; Freytag, Halle, 1830-1838, 4 vols. 4to; abridged, 1837, 4to. **ENGLISH.**—Catalogue (Arab.-Eng. and Eng.-Arab.), London, 1858, 8vo, 2 vols.; 2nd ed. 1873, 8vo; Lane, London, 1863-1893 (edited after Lane's death, from 1876, by his grandnephew, Stanley Lane-Poole). The Arabic title is *Medd el Kamous*, meaning either the Flow of the Sea, or The Extension of the Kamus. It was undertaken in 1842, at the suggestion and at the cost of the 6th duke of Northumberland, then Lord Prudhoe, by Mr Lane, who returned to Egypt for the purpose, and lived in Cairo for seven years to study, and obtain copies of, the great MS. lexicons in the libraries of the mosques, few of which had ever been seen by a European, and which were so quickly disappearing through decay, carelessness and theft, that the means of composing such a work would not long have existed). Newman (modern), 1872, 8vo, 2 vols. 856 pages. **FRENCH.**—Ruyf (Fr.-Ar.), Paris, 1802, 4to; Bochtor (do.), Paris, 1828, 4to, 1 vol.; 2nd ed. 1850; Roland de Busay (Argens, Fr.-Ar.), Alger, 1835, 16mo; Id., 1836, 8vo; 1839; Bergiers (Fr.-vulg. Ar.), Syria and Egypt, Udsala, 1844, 4to; Farhat (Germano-vev. par Richard ed. Dahlab), Maron, 1849, 4to; Gerberton kasurî Paris, 1849, 8vo, 2 vols.; 1851-1856; 1860, 2 vols. 3032 pages; Marci (vulgar dialects of Africa), Paris, 1830; 1835, 8vo; 1837; enlarged, 1850, 8vo; Paulmier (Algeria), 2nd ed. Paris, 1860, 8vo, 931 pages; 1877; Bernard (Egypt), Lyon, 1864, 8mo; Cuhe, Beirut, 1862, 8vo; 1867; Nar Bey (A. Calla), 2nd ed. Paris, 1872, 12mo, 1042 pages; Charbonneau (written language), Paris, 1876, 2 vols. 8vo; Id. (Fr.-Ar.), Paris, 1872, 8vo; Beausier (Algiers, Tunis, legal, epistolary), Alger, 1871, 4to, 764 pages; 1873. **GERMAN.**—Seyfarth (Algeria), Grimma, 1849, 16mo; Wolff (Mod. Ar.), Leipzig, 1867, 8vo; Wahrmond (do.), Gießen, 1870-1875, 8vo, 4 vols. **ITALIAN.**—Germano, Roma, 1636, 8vo; (Ar. Lat. It.), Romæ, 1639, fol.; *Dizionario*, Bulak, 1824, 4to; Schiaparelli, Firenze, 1871, 4to, 641 pages. **SPANISH.**—Alcala, Grenada, 1505, 4to; Cafes, Madrid, 1787, fol. 3 vols. **SUFI TECHNICAL TERMS.**—Abd Errahin, ed. Sprenger, Calcutta, 1845, 8vo. **TECHNICAL TERMS OF THE MUSSELLIN SCIENCES.**—Abd al Hagg and Gholam Kadir, Calcutta, 1853-1862, 4to, 1593 pages. **MEDICAL TERMS.**—Pharaon and Bertherand, Paris, 1860, 12mo. **MATERIA MEDICA.**—Muhammad Abd Allah Sherazi, *Ufias Ushriyeh*, translated by Gladwin (Eng. Pers. Hindi), Calcutta, 1793, 4to, 1441 words. **NOMS DES VÉTÈMENTS.**—Dozy, Amst. 1845, 8vo. **WÖRTER IN ENTGEGENSETZTEN BEDEUTUNGEN.**—Redalob, Göttingen, 1873, 8vo. **KORAN.**—Willmet (also in *Harrius et vitam Timur*), Lugd. Bat. 1784, 4to; Amst. 1790; *Fingel, Concordantia*, Leipzig, 1842, 4to; Fenrice, *Dictionary and Glossary*, London, 1873, 4to. **EL TABRIZI'S LOGIC.**—Mir Abulreth (French), Bulak, 1842, 8vo. **MALTESE.**—Vassali, Romæ, 1796, 4to; Falson (Malt. Ital. Eng.), Malta, s.v. 8vo; Vella, Livorno, 1843, 8vo.

ARMENIAN.—Mechitar, Venice, 1769-1769, 4to, 2 vols.; Avedichian, Sirmédian and Aucher (Aulerian), 1836-1837, 4to, 2 vols.; Acher, 1846, 4to. **POLYLOGOT.**—Villa (Arm.-vulg. littéralis, Lat. Italcæ et Gallicæ), Romæ, 1780. **GREEK AND LATIN.**—Lazarists, Venice, 1836-1837, 4to, 2 vols. 2217 pages. **LATIN.**—Rivola, Medicolæ, 1621, fol.; Nierszesovicz, Romæ, 1695, 4to; Villotte, 1817, 4to;

fol.; Mechitar, Venetiae, 1747-1763, 4to, 2 vols. **ENGLISH.**—Aucher, Venice, 1821-1825, 4to, 2 vols. **FRENCH.**—Aucher, Venise, 1812-1817, 8vo, 2 vols.; (Fr.-Arm. Turc.), 1840, 4to; Eminian, Vienna, 1853, 4to; Calla, Paris, 1861, 8vo, 1016 pages; 1872. **ITALIAN.**—Ciackiak, Venezia, 1837, 4to. **RUSSIAN.**—Khudobashev [Khutapashian], Moskva, 1838, 8vo, 2 vols.; Russ. Arm.—Adamdarov, 1821, 8vo; Popov, 1841, 8vo, 2 vols. **MODERN WORDS.**—Riggs, Smyrna, 1847, 8vo.

Georgian.—Paolini (Ital.), Roma, 1629, 4to; Klaproth (Fr.), Paris, 1827, 8vo; Tahubinov (Russian, French), St Petersburg, 1840, 4to; 1846, 8vo, 2 vols. 1187 pages. **Circassian.**—Loewe, London, 1854, 8vo. **Ossetic.**—Sjörgren, St Petersburg, 1844, 4to. **Kurd.**—Garzoni, Roma, 1787, 8vo; Lerch (German), St Petersburg, 1857, 8vo; Id. (Russian), 1856-1858, 8vo.

Persian.—*Burhani Qatib*, arranged by J. Roebuck, Calcutta, 1818, 4to; *Burhan i Kati*, Bulak, 1836, fol.; Muhammed Kazim, Tabriz, 1844, fol.; *Hafiz Kulum* (The Seven Seas), by Ghazi ed din Haidar, King of Oude, Lucknow, 1822, fol. 7 vols. **ARABIC.**—*Shams ul Lughat*, Calcutta, 1806, 4to, 2 vols. **TURKISH.**—Ibrahim Effendi, *Farhangi Shu'uri*, 1872, fol. 2 vols. 22,530 words, and 22,450 poetical quotations; *Burhan Kati*, by Ibn Kalif, translated by Ahmed Asin Aintabi, 1879, fol.; Bulak, 1836, fol.; Hayret Effendi, 1826, 8vo. **ARMENIAN.**—Douzean, Constantinople, 1826, fol. **BENGALI.**—Jay Gopal, Serampore, 1818, 8vo. **LATIN.**—Vullers (Zend appendix), Bonnae ad Rhen, 1855-1868, 4to, 2 vols. 2544 pages; Supplement of Roots, 1867, 142 pages. **ENGLISH.**—Gladwin, Maida in Bengal, 1780, 4to; Calcutta, 1797; Kirkpatrick, London, 1785, 4to; Moises, Newcastle, 1794, 4to; Rousseau, London, 1802, 8vo; 1830; Richardson (Arab. and Pers.), 1870-1800, fol. 2 vols.; ed. Willms, 1806-1810, 4to, 2 vols.; ed Johnson, 1829, 4to; Ramdhen Ser, Calcutta, 1829, 8vo; 1831; Tucker (Eng.-Pers.), London, 1850, 4to; Johnson (Pers. and Arab.), 1852, 4to; Palmer, 1876, 8vo, 726 pages. **FRENCH.**—Hadjeri (Pers. Arab. and Turkish), Moscou, 1841, 4to, 3 vols. 2764 pages; Bergé, Leipzig, 1860, 12mo. **GERMAN.**—Richardson, translated by Wahl as *Orientalische Bibliothek*, Lemg, 1788-1792, 8vo, 3 vols. **ITALIAN.**—Angelus a S. Joseph [i.e. Labrosse] (Ital. Lat. Fr.), Amst. 1684, fol.

Old Persian.—(Cuneiform). Benfey (German), Leipzig, 1847, 8vo; Spiegel (id.), 1862, 8vo; Kossovich (Latin), Petropoli, 1872, 8vo. **Zend.**—Justi, Leipzig, 1864, 4to; Vullers, Persian Lexicon, Appendix; Lagarde, Leipzig, 1868, 8vo. **Pahlavi.**—*An old Pahlavi and Pasend Glossary*, translated by Destur Hoahengi Jamaspji, ed. Haug, London, 1867, 8vo; 1870, 8vo; West, Bombay, 1874, 8vo.

INDIAN TERMS.—*The Indian Vocabulary*, London, 1788, 16mo; Gladwin, Calcutta, 1797, 4to; Roberts, London, 1800, 8vo; Rousseau, 1802, 8vo; Roebuck (naval), 1813, 12mo; C. P. Brown, *Zilah Dict.*, Madras, 1852, 8vo; Robinson (Bengal Courts), Calcutta, 1854, 8vo; 1860; Wilson, London, 1855, 4to; Fallon, Calcutta, 1858, 8vo.

Sanskrit.—Amarasimha (lived before A.D. 1000). *Amarakosha* Calcutta, 1807, 8vo; 1834, 4to; Bombay, 1860, 4to; Lucknow, 1863, 4to; Madras, 1870, 8vo, in Grantha characters; Cottayam, 1873, 8vo, in Malayalm characters; Benares, 1867, fol. with *Amarasimha's commentary* by Mâheshvara; Rajah Radhakanta Deva, *Sabdakalpadruma*, Calcutta, 1811-1837, 4to, 8 vols. 8730 pages; 2nd ed. 1874, &c.; Bhattacharya, *Sabdastoma Mahanidhi*, Calcutta, 1869-1870, 8vo, parts i.-vii. 528 pages; *Abhidhanaratnamala*, by Halayudha, ed. Aufrecht, London, 1861, 8vo; *Vachaspathya*, by Taranatha Tarinavachaspathi, Calcutta, 1873, &c., 4to (parts i.-vii., 1680 pages). **BENGALI.**—*Sabdarsindhu*, Calcutta, 1808; *Amarakosa*, translated by Ramodoyu Bidjalunker, Calcutta, 1831, 4to; Mathurana Tarkaratna, *Sabdastandarhisindhu*, Calcutta, 1863, 4to. **MARATHI.**—Ananta Sastri Talekar, Poona, 1853, 8vo, 495 pages; Madhava Chandra, Bombay, 1870, 4to, 695 pages. **TELUGU.**—*Amarakosha*, Madras, 1861, ed. Kala, with *Gurubala prabodhika*, a commentary, 1861, 4to; with the same, 1875, 4to, 516 pages; with *Amarapadarjajita* (Sana. and Tel.), by Vavilla Masavani Sastri, 1862, 4to; 1863, 8vo; 3rd ed. by Jagannohana Tarkalankara and Khetramohana, 1872, &c., parts i.-iv. 600 pages; Suria Pracasâ Row, *Sarva-Sabda-Sambodhini*, 1875, 4to, 1064 pages. **TIBETAN AND MONGOL.**—Schiefer, *Buddhistische Trilogie*, St Petersburg, 1859, fol., the *Ypnyalti* or *Mahavyapatti* from the *Tanjaur*, vol. 123 of the Sutra. **LATIN.**—Paulinus a Sancto Bartholomeo, Amarasimha, sectio i. de coelo, Romæ, 1798, 4to; Bopp, Berlin, 1828-1830, 4to; 2nd ed. 1840-1844; 3rd, 1866, 4to. **ENGLISH.**—*Amarakosha*, trans. by Colebrooke, Serampore, 1808, 4to; 1845, 8vo; Rousseau, London, 1812, 4to; Wilson, Calcutta, 1819, 4to; 2nd ed. 1832; ed. Goldstickler, Berlin, 1862, &c., folio, to be in 20 parts; Yates, Calcutta, 1846, 4to; Benfey, London, 1865, 8vo; Ram Jagan, Benares, 1871, 8vo, 713 pages; Williams, Oxford, 1872, 4to. **ENGLISH-SANSKRIT.**—Williams, London, 1851, 4to. **FRENCH.**—Amarakosha, transl. by Loiseleur Deslongchamps, Paris, 1839-1845, 8vo, 2 vols. 796 pages; Burnouf and Roth, Nancy, 1863-1864, 8vo. **GERMAN.**—Böhtlingk and Roth, St Petersburg, 1853, &c., 4to, 7 vols. to 1875. **ITALIAN.**—Gubernatis, Torino, 1856, &c., 8vo, unfinished, 2 parts. **RUSSIAN.**—Kossovich, St Petersburg, 1859,

8vo. **Roots**.—Wilkins, London, 1815, 4to; Rosen, Berlin, 1827, 8vo; Westergaard, Bonnae, 1840-1841, 8vo; Vishnu Parasurama Sastri Pandita (Sams. and Marathi), Bombay, 1865, 8vo; Taranatha Tarkavachaspati, *Dhatupadara*, Calcutta, 1869, 8vo; Leupol, Paris, 1870, 8vo. **SYNONYMS**.—*Abhidhanacintamani*, by Hemachandra, ed. Colebrooke, Calcutta, 1807, 8vo; translated by Böhrling and Rieu (German), St Petersburg, 1847, 8vo. **HOMONYMS**.—*Medinikara*, *Medinikoshka*, Benares, 1865, 4to; Calcutta, 1869, 8vo; *ib.* 1872, 8vo. **DERIVATIVES**.—Hirochand and Rooji Rangit, *Dhatumanjari*, Bombay, 1865, 8vo. **TECHNICAL TERMS OF THE NYĀYA PHILOSOPHY**.—*Nyāyakośa*, by Bhimacharya Jhalakikar (Sanskrit), Bombay, 1875, 8vo, 183 pages. **RIG VEDA**.—Grassmann, Leipzig, 1873-1875, 8vo.

Bengali.—Manoel, Lisboa, 1743, 8vo; Foster, Calcutta, 1799-1802, 4to, 2 vols. 893 pages: Carey, Serampore, 1815-1825, 4to, 2 vols.; ed. Marshman, *ib.* 1827-1828, 8vo, 2 vols.; 3rd ed. *ib.* 1864-1867, 8vo; abridged by Marshman, *ib.* 1865, 8vo; *ib.* 1871, 8vo, 2 vols. 936 pages: Morton, Calcutta, 1828, 8vo; Houghton, London, 1833, 4to; *Adeia*, *Shabdabudhi*, Calcutta, 1854, 604 pages. **ENGLISH**.—*Ra Comul Sen*, *ib.* 1834, 4to, 2 vols.; London, 1835, 4to; D'Rosario, Calcutta, 1837, 8vo; *Adeia*, *Abhidan*, Calcutta, 1854, 761 pages. **ENGLISH LATIN**.—Ramkisen Sen, *ib.* 1821, 4to. **ENG-BENG**. AND **MANIPURI**.—[Gordon], Calcutta, 1837, 8vo.

Canarese.—Reve, Madras, 1824-1832, 4to, 2 vols.; ed. Sanderson, Bangalore, 1858, 8vo, 1040 pages; abridged by the same, 1858, 8vo, 276 pages: *Dictionary Canarese*, Bengalori, 1855, 8vo; *School Dictionary*, Mangalore, 1876, 575 pages.

Dardic Languages.—Leitner (Astori, Ghilghiti, Chilasi, and dialects of Shina, viz. Arnyia, Khajunia and Kalasha), Lahore, 1868, 4to. **Guzarati**.—(English) Mirza Mohammed Causim, Bombay, 1846, 4to; Shapurji Edalji, *ib.* 1868, 8vo, 896 pages; *Karandas Mulji*, *ib.* 1868, 8vo, 643 pages.

Hindi.—Rousseau, London, 1812, 4to; Adam, Calcutta, 1829, 8vo; Thompson, *ib.* 1846, 8vo; J. D. Bate, London, 1876, 8vo, 809 pages. **ENGLISH**.—Adam, Calcutta, 1833, 8vo. **ENGLISH, URDU AND HINDI**.—Mathuraprasada Mirza, Benares, 1865, 8vo, 1345 pages.

Hindustani.—Ferguson, London, 1773, 4to; Gilchrist, Calcutta, 1800, 8vo; ed. Hunter, Edinb. 1810; Lond. 1825; Taylor, Calcutta, 1808, 4to, 2 vols.; Gladwin (Persian and Hind.), Calcutta, 1809, 8vo, 2 vols.; Shakespeare, London, 1817, 4to; 1820; 1834; 1849; Forbes, London, 1847, 8vo; 1857; Bertrand (French), Paris, 1858, 8vo; Brice, London, 1864, 12mo; Fallon, Banaras, 1876, &c., to be in about 25 parts and 1200 pages. **ENGLISH**.—Gilchrist, 1787-1780, 4to, 2 parts; Thompson, Serampore, 1838, 8vo.

Kashmiri.—Ermlich, London, 1872, 12mo.

Khasia.—Roberta, Calcutta, 1875, 12mo.

Malayalam.—Fabricius and Breithaupt, Weperg, 1779, 4to; Bailey, Cottayam, 1846, 8vo; Gundert, Mangalore, 1871, 8vo, 1171 pages.

Marathi.—Carey, Serampore, 1810, 8vo; Kennedy, Bombay, 1824, fol.; Jugunnath Shastri Kramavant, Bombay, 1829-1831, 4to, 3 vols.; Molesworth, *ib.* 1831, 4to; 2nd ed. 1847, 4to; ed. Candy, Bombay, 1857, 4to, 957 pages; abridged by Baba Padmanji, *ib.* 1863, 8vo; 2nd ed. (abridged), London, 1876, 8vo, 644 pages. **ENGLISH**.—Molesworth, Bombay, 1847, 4to.

Oriya.—Mohunpersad Takoor, Serampore, 1811, 8vo; Sutton, Cuttack, 1841-1848, 8vo, 3 vols. 856 pages.

Pali.—Clough, Colombo, 1824, 8vo; Moggallana Thero (a Sinhalese priest of the 12th century), *Abhidhanappika* (Pali, Eng. Sinhalese), ed. Waskeuwu Subhetti, Colombo, 1865, 8vo; Childers, London, 1872-1875, 8vo, 658 pages. **Roots**.—Silavansa, *Dhatsmanjusa* (Pali Sing. and Eng.), Colombo, 1872, 8vo.

Prakrit.—Delius, *Kadices*, Bonnae ad Rh., 1839, 8vo. **Punjabi**.—Starkey, 1850, 8vo; Lodianna Mission, **Lodianna**, 1854-1860, 444 pages.

Pushtu or Afghan.—Dorn, St Pétersb. 1845, 4to; Raverty, London, 1860, 4to; 2nd ed. *ib.* 1867, 4to; Bellew, 1867, 8vo.

Sindhi.—Eastwick, Bombay, 1843, fol. 73 pages: Stack, *ib.* 1855, 8vo, 2 vols.

Sinhalese.—Clough, Colombo, 1821-1830, 8vo, 2 vols.; Callaway (Eng., Portuguese and Sinhalese), *ib.* 1818, 8vo; *Id.*, *School Dictionary*, *ib.* 1821, 8vo; Bridgenell (Sinh. Eng.), *ib.* 1847, 18mo; Nicholson (Eng.-Sinh.), 1864, 32mo, 646 pages.

Tamil.—Provenza (Portug.), Ambalacoe, 1679, 8vo; *Sadir Aguardi*, written by Beschi in 1732, Madras, 1827, fol.; Pondicherry, 1875, 8vo; Bin (French), Paris, 1834, 8vo; Rottler, Madras, 1834-1841, 4to, 4 vols.; Jaffna Book Society (Tamil), Jaffna, 1842, 8vo, about 58,500 words; Knight and Spaulding (Eng. Tam.), *ib.* 1844, 8vo; *Dictionary*, *ib.* 1852, 4to; Pope, 2nd ed. *ib.* 1859, 8vo; Winlow, Madras, 1862, 4to, 992 pages, 67,452 words.

Telugu.—Campbell, Madras, 1821, 4to; C. P. Brown, Madras (Eng.-Tel.), 1852, 8vo, 1429 pages; *Id.* (Tel.-Eng.), *ib.* 1852, 8vo, 1319 pages. **MIXED TELUGU**.—*Id.*, *ib.* 1854, 8vo.

Thugree.—Sleeman, Calcutta, 1830, 8vo, 860 Ramasi words.

Indo-Chinese Languages.—Leyden, *Comparative Vocabulary of Barma, Malaya and Thai*, Serampore, 1810, 8vo. **Annamese**: Rhodes (Portug. and Lat.), Romae, 1651, 4to; Pigneaux and Taberd, Fredericangori, 1838, 4to; Legrand de la Liraye, Paris, 1874, 8vo; Pauthier (Chin. Ann.-Fr. Lat.), Paris, 1867, &c., 8vo. **Assamese**: Mrs Cutler, Saipur, 1840, 12 mo; Bronson, London, 1876, 8vo, 617

pages. **Burmese**: Hough (Eng.-Burm.), Serampore, 1825, Moulmain, 1845, 8vo, 2 vols. 955 pages; Judson, Calcutta, 1826, 8vo; (Eng. Burm.), Moulmain, 1849, 4to; (Burm. Eng.), *ib.* 1852, 8vo; 2nd ed., Rangoon, 1866, 8vo, 2 vols. 968 pages; Lane, Calcutta, 1841, 4to. **Cambodian**: Amyonier (Fr.-Camb.), Saigon, 1874, 4to; *Id.* (Camb.-Fr.), *ib.* 1875, fol. **Karen**: Sau-kaui Too (Karen), Tavoy, 1847, 12mo, 4 vols.; Mason, Tavoy, 1840, 4to. **Sgaw-Karen**: Wade, *ib.* 1849, 8vo. **Siamese (Thai)**: Pallegoix (Lat. French, Eng.), Paris, 1854, 4to; *Dictionary Latinum Thai*, Bangkok, 1850, 4to, 498 pages.

Malay.—LATIN.—Haex, Romae, 1631, 4to; Batavia, 1707. **DUTCH**.—Houtmann (Malay and Malagasy), Amst. 1603, 4to; 1673; 1680; 1687; 1703; Batavia, 1707; Wiltena and Dankcaerts, Gravenhage, 1623, 4to; Amst. 1650; 1677; Batavia, 1708, 4to; Heurnius, Amst. 1640, 4to; Gueynier, Batavia, 1677, 4to; 1708; Loder, *ib.* 1707-1708, 4to; Van der Worm, *ib.* 1708, 4to; Koorda van Eysinga (Low), *ib.* 1824-1825, 8vo, 2 vols.; 12th ed. 's Gravenhage, 1863, 8vo; *Id.* (Hof. Volts en Lagen Taal), *ib.* 1865, 8vo; Dissel-ood, Lucardic (High Malay), Leiden, 1860, 12mo; Pijnappel, Amst. 1863, 8vo; Badings, Schoonhoven, 1873, 8vo. **ENGLISH**.—Houtmann (Malay and Malagasy), translated by A. Spaulding, London, 1614, 4to; Bowrey, *ib.* 1701, 4to; Howison, *ib.* 1801, 4to; Marsden, *ib.* 1812, 4to; Thomson, Malacca, 1820, 8vo; 1827; Crawford, London, 1851, 8vo, 2 vols. **FRENCH**.—Boze, Paris, 1825, 16mo; Elout (Dutch-Malay and French-Malay), Harlem, 1826, 4to; Bougourd, Le Havre, 1856, 8vo; Richard, Paris, 1873, 8vo, 2 vols.; Favre, Vienna, 1875, 8vo, 2 vols.

Malay Archipelago.—*Batak*: Van der Tuuk, Amsterdam, 1861, 8vo, 564 pages. **Bugis**: Mathes, Gravenh. 1874, 8vo, 1188 pages; Thomsen (Eng.-Bugis and Malay), Singapore, 1833, 8vo. **Dyak**: Hardehand (German), Amst. 1859, 8vo, 646 pages. **Javanese**: Serenport Domis, Samarang, 1827, 4to, 2 vols.; Koorda van Eysinga, Kampen, 1834-1835, 8vo, 2 vols.; Gericke, Amst. 1847, 8vo; ed. Taco Koorda, *ib.* 1871, &c. parts i.-v., 880 pages; Jansz and Klinkert, Samarang, 1851, 8vo; 1865; Favre (French), Vienne, 1870, 8vo. **Macassar**: Matthes, Amst. 1859, 8vo, 951 pages. **Sunda**: De Wilde (Dutch, Malay and Sunda), Amsterdam, 1841, 8vo; Rig (Eng.), Batavia, 1862, 4to, 573 pages. **Formosa**: Harpart (Favorling dialect, written about 1650), Parrattann, 1840, 12mo.

Philippines.—*Bicol*: Marcos, Sampaloc, 1754, fol. *Bisaya*: Sanchez; Manila, 1711, fol.; Bergaño, *ib.* 1735, fol.; Noceda, *ib.* 1841; Mentrida (also Hiliguna and Haraya) *ib.* 1637, 4to; 1841, fol. 827 pages; Felix de la Encarnacion, *ib.* 1851, 4to, 2 vols. 1217 pages. *Itacac*: Bugarini, *ib.* 1854, 4to; *Itacaca*, Carro, *ib.* 1849, fol. *Pampanga*: Bergaño, *ib.* 1732, fol. *Tagala*: Santos, Toyabak, 1703, fol.; *ib.* 1835, 4to, 857 pages; Noceda and San Lucar, Manila, 1754, fol.; 1832.

Chinese.—Native Dictionaries are very numerous. Many are very copious and voluminous, and have passed through many editions. *Suo wen*, by Hsi Shin, is a collection of the ancient characters, about 10,000 in number, arranged under 54 radicals, published 150 B.C., usually in 12 vols.: *Yu pien*, by Ku Ye Wang, published A.D. 530, arranged under 542 radicals, is the basis of the Chinese Japanese Dictionaries used in Japan: *Ping tsen iou pien*, Peking, 1726, 8vo, 130 vols.; *Pai wen yin fu* (Thesaurus of Literary Phrases), 1711, 131 vols. 8vo, prepared by 66 doctors of the Han lin Academy in seven years. It contains 10,362 characters, and countless combinations of two, three or four characters, forming compound words and idioms, with numerous and copious quotations. According to Williams (*On the word Shin*, p. 79), an English translation would fill 140 volumes octavo of 1000 pages each. *Kanghsi tse tien* (Kanghi's Standard or Canon of the Character), the dictionary of Kanghi, the first emperor of the present dynasty, was composed by 30 members of the Han lin, and published in 1716, 40 vols. 4to, with a preface by the emperor. It contains 49,030 characters, arranged under the 213 radicals. It is generally in 12 vols., and is universally used in China, being the standard authority among native scholars for the readings as well as the meanings of characters. **LATIN**.—Du Guignes (French), Paris, 1813, fol.; Klapproth, Supplement, 1810; ed. Bazil (Latn), Hong-Kong, 1853, 4to; Gonçalves (Lat.-Chin.), Macao, 1841, fol.; Callery, *Systema phoneticum*, Macao, 1841, 8vo; Schott, *Vocabularium*, Berlin, 1844, 4to. **ENGLISH**.—Raper, London, 1807, fol. 4 vols.; Morrison, Macao, 1815-1823, 4to, 3 parts in 6 vols.; Medhurst, Batavia, 1842-1843, 8vo, 2 vols.; Thom, Canton, 1843, 8vo; Lobecheid, Hong-Kong, 1871, 4to; Williams, Shanghai, 1874, 4to. **ENG. CHINESE**.—Morrison, part iii.; Williams, Macao, 1844, 8vo; Medhurst, Shanghai, 1847-1848, 8vo, 2 vols.; Hung Maou, *Tung yung fan hwa* (Common words of the Red-haired Foreigners), 1850, 8vo. Doolittle, Foochow, 1872, 4to, vol. i., 550 pages. **FRENCH**.—Callery, *Dict. encyclopédique*, Macao and Paris, 1845 (radicals 1-20 only); M. A. H., 1876, 8vo, autographié, 1730 pages. **FRENCH-CHIN.**—Perny (Fr.-Latin, Spoken Mandarin), Paris, 1869, 4to; Appendice, 1770; Lemaire and Ciguél, Shanghai, 1874, 16mo. **PORTUGUESE**.—Gonçalves (Port.-Chin.), Macao, 1830, 8vo, 2 vols.; *Id.* (Chin.-Port.), *ib.* 1833, 8vo. **IDIOMS**.—Giles, Shanghai, 1873, 4to. **PHRASES**.—Yaou Pei-chen, *Luy yik*, 1742-1765, 8vo; 55 vols.; Teen Ta-hin, *Shing Iyue*, 1853, 8vo, 4 vols. **CLASSICAL EXPRESSIONS**.—Keang Yang and 30 others, *Sze Shoo Ien Lin*, 1795, 8vo, 30 vols. **ELEGANT EXPRESSIONS**.—Chang ting yuh, *Pien Iyue Ien Lin*, 1722,

8vo, 64 vols. PHRASES OF THREE WORDS.—Julien (Latin), Paris, 1848, 8vo. PORTUGAL.—*Pes waa shu yun*, 1800, 8vo, 5 vols. PROPER NAMES.—F. Porter Smith (China, Japan, Corea, Annam, &c., Chinese, Eng.), Shanghai, 1870, 8vo. TOPOGRAPHY.—Williams, Canton, 1824, 8vo. NAMES OF TOWNS.—Biot, Paris, 1842, 8vo. ANCIENT CHARACTERS.—Foo Lwantsang, *Luh shoo fun luy*, 1800, 8vo, 12 vols. SEAL CHARACTER.—Heu Shin, *Shoo waa*, ed. Seu Heura, 1827, 8vo, 12 vols. RUNNING HAND.—St. Aulaire and Greenovert (Square Characters, Running Hand; Running, Square), Amst. 1861, 4to, 117 pages. TECHNICAL TERMS (in Buddhist translations from Sanskrit)—Yuen Ying, *Yih tsee hing pin e*, 1848, 8vo. DIALECTS.—Amsy: Douglas, London, 1873, 4to, 632 pages. Macrowan, Hong-Kong, 1869, 8vo. Canton: Yu Heo-poo and Wan He-shih, *Keang hoo chih tsh fun yun tso yun ho tsieh*, Canton, 1772, 8vo, 4 vols.; 1803, 8vo, 4 vols.; Fuh-shan, 1833, 8vo, 4 vols.; Morrison, Macao, 1828, 8vo; Wan ke shih, Canton, 1856, 8vo; Williams (tonic, Eng.-Chinese), Canton, 1856, 8vo; Chalmers, Hong-Kong, 1850, 12mo; 3rd ed. 1873, 8vo. *Changchow in Fuhkeen*: Seay Sew-lin, *Ya tsh tsang shik woo yin*, 1818, 8vo, 8 vols.; 1820. *Foo-chow*: Teich (a Japanese general) and Lin Peih shan, *Pa yin ho ting*, ed. Tsai Gaa, 1841, 8vo; Maclay and Baldwin, Foochow, 1870, 8vo, 1123 pages. *Hok-been*: Medhurst, Macao, 1832, 4to; Peking, Serat. Shanghai, 1871, 8vo.

Corean.—CHINESE, COREAN AND JAPANESE.—*Chom Seen Wo Kwo tsu mei*, translated by Medhurst, Batavia, 1835, 8vo. RUSSIAN.—Puzillo, St Petersburg, 1874, 12mo, 746 pages. Japanese.—*Sio Ken Zi Ko* (Examination of Words and Characters), 1608, 8vo, 10 vols.; *Wa Kan Wou Se Ki Sio Gen Zi Ko*, lithographed by Siebold, Lugd. Bat., 1835, fol. JAP.-CHINESE.—*Fogo hiki sei yo na*. CHINESE-JAP.—*Kanghi Tse Tein*, 30 vols., 12mo; *Zi rin glose* les. DUTCH DICTIONARIES PRINTED BY JAPANESE.—*Zi rin glose* les. DUTCH EN HOLLANDSCH WOORDBOEK, by the interpreter, B. Sadayok, 1810; Missamoto Masataka, Prince of Nakata (Jap. Chinese-Dutch), 5 vols. 4to, printed at Nakata by his servants; *Jedo-Halma* (Dutch-Jap.), Jedo, 4to, 20 vols.; *Nederlandsche taal*, Dutch Chinese, for the use of interpreters. LATIN AND PORTUGUESE.—Calcepinus, *Dictionarium*, Amacusa, 1595, 4to. LATIN.—Collado, *Compendium*, Romae, 1632, 4to; *Lexicon*, Romae, 1870, 4to, from Calcepinus. ENGLISH.—Medhurst, Batavia, 1830, 8vo; Hepburn, Shanghai, 1867, 8vo; 1872. ENG.-JAP.—Hori Tokuoyok, Yedo, 1862, 8vo; 2nd ed. Yeddo, 1866, 8vo; Satow and Ishibashi Masataka (spoken language), London, 1876, 8vo. FRENCH.—Rosny (Jap. Fr. Eng.), Paris, 1857, 4to, vol. 1.; Pages, Paris, 1869, 4to, translated from Calcepinus. FR.-JAP.—Soutcovey, Paris, 1864, 8vo. FR. ENG. JAP.—Mermet de Cachon, Paris, 1866, 8vo, unfinished. GERMAN.—Pflumier (Jap.-Ger., Eng.), Wien, 1851, 4to, unfinished. SPANISH.—*Vocabulario del Japon*, Manila, 1630, 4to, translated from the next. PORTUGUESE.—*Vocabulario da Lingua de Japam*, Nagasaki, 1603, 2d. RUSSIAN.—Goshkevich, St Petersburg, 1857, 8vo, 487 pages. CHINESE CHARACTERS WITH JAPANESE PRONUNCIATION.—Rosny, Paris, 1867, 8vo. CHINESE AND JAPANESE NAMES OF PLANTS.—Hoffmann, Leyde, 1864, 8vo.

Aino.—Pflumier, Wien, 1854, 4to. Northern and Central Asia.—*Burial*: Castrén, St Petersburg, 1857, 8vo. *Calmuck*: Zwick, Villingen, 1853, 4to; Smirnov, Kazan, 1857, 12mo; Jügel, *Siddhi Kur*, Leipzig, 1866, 8vo. *Chusars*: Clercy of the school of the Kazan Eparchy, Kazan, 1836, 8vo, 2481 pages; Lylak (Russ.-Chuv. French), Odessa, 1846, 8vo, 244 pages; Zlotinski, Kazan, 1875, 8vo, 287 pages. *Jagalsi*: Mir Ali Shir, Amulka, ed. Vámbéry, with Hungarian translation, Pesth, 1862, 8vo; Vámbéry, Leipzig, 1867, 8vo; Pavet de Courteille, Paris, 1870, 8vo. *Kubak and Korogus*: Castrén, St Petersburg, 1857, 8vo. *Manchu*: *Yuchi tung ting ling*, *man hian* (Manchu Chinese), 1771, 4to, 6 vols.; *Se it ksh ksh man hian* (Manchu-Mongol, Tibetan, Chinese) 10 vols., 4to, the Chinese pronunciation represented in Manchu; *Saw koh fun les* (Manchu-Chinese, Mongol), 1792, 8vo, 12 vols.—all three dated vocabularies; Langlé (French), Paris, 1789-1790, 4to, 3 vols.; Gabelentz (German), Leipzig, 1864, 8vo; Zakharov (Russian), St Petersburg, 1875, 8vo, 1235 pages; *Mongol*: I. J. Schmidt (German, Russian), St Petersburg, 1835, 4to; Schergin, Kazan, 1841, 8vo; Kowalevski, Kazan, 1844-1849, 4to, 3 vols. 2703 pages. *Ostiak*: Castrén, St Petersburg, 1858, 8vo. *Samoyed*: Castrén, St Petersburg, 1855, 8vo, 308 pages. *Tartar*: Giganov (Tobolsk), St Petersburg, 1804, 4to; (Russ.-Tartar), ib. 1840, 4to; Troyanski (Karan), Kazan, 1835-1855, 4to. *Tibetan*: *Minggi djamlo* (Tibet-Mongol); *Bodshi dshi neper laame*: *Ked shi schand scharan mongoli jigé* (Manchu-Mongol-Tibetan-Chinese), Kanghi's Dictionary with the Tibetan added in the reign of Khian lung (1736-1795); Csoma de Körös (Eng.), Calcutta, 1834, 4to; I. J. Schmidt (German), St Petersburg, 1841, 4to; Id. (Russian), ib. 1843, 4to; Jaeschke (Eng.), London, 1870, 8vo, 160 pages; Id. (Germ.), Gnadau, 1871, 658 pages; (Bhotanta), Schwetzer, Serampore, 1826, 4to. *Tungusian*: Castrén, St Petersburg, 1846, 8vo, 632 pages. *Uigur*: Vámbéry, Iánspruck, 1870, 4to. *Uzbé*: Böhtlingk, ib. 1854, 4to, 2 vols. *Yenisei Ostiak*: Castrén, ib. 1849, 8vo.

AFRICA

Egyptian.—Young (enchorial), London, 1830-1831, 8vo; Sharpe, London, 1837, 4to; Birch, London, 1838, 4to; Champollion (died March 4, 1832), *Dictionnaire Egyptien*, Paris, 1841, 4to; Brugsch,

Hieroglyphisch-Deutsches Wörterbuch, Leipzig, 1867-1868, 4to, 4 vols.; 1775 pages, nearly 4700 words, arranged according to the hieroglyphic alphabet of 28 letters; Pierret, *Vocabulaire hiérog.*, Paris, 1875, 8vo, containing also names of persons and places; Birch, in vol. v. pp. 337-580 of Bunsen's *Egypt's Place*, 2nd ed. London, 1867, &c. 8vo, 5010 words. PROPER NAMES.—Brugsch, Berlin, 1851, 8vo, 726 names; Parthey, ib. 1864, 8vo, about 1500 names; Lieblein, Christiania, 1871, 8vo, about 3200 from hieroglyphic texts. BOOK OF THE DEAD.—Id., Paris, 1875, 12mo.

Coptic.—Veyssiére de la Croze, Oxon. 1775, 8vo; Rossi, Romae, 1807, 4to; Tattam, Oxon. 1855, 8vo; Peyron, 1835, 4to (the standard); Parthey, Berolini, 1844, 8vo.

Ethiopic.—Wemmer, Romae, 1638, 4to; Ludolf, London, 1661, 4to; Francof. ad M., 1699, fol.; Dillmann (Tigré appendix), Leipzig, 1863-1865, 4to, 828 pages.

Amharic.—Ludolphus, Franc. ad Maenum, 1698, fol.; Isenberg, London, 1841, 4to, 442 pages. *Tigré*: Munzinger, Leipzig, 1865, 8vo; Beurmann, ib. 1868, 8vo.

East Coast.—*Dankali*: Isenberg, London, 1840, 12mo. *Galla*: Krapf, London, 1842, 8vo; Tutschek, München, 1844, 8vo. *Engutuk loigob*: Erhardt, Ludwigsberg, 1857, 8vo. *Kisuuahli*: *Vocabulary of the Soakhi*, Cambridge, U.S. 1845, 8vo; Steere, London, 1870, 8vo, about 5800 words. *Kisuuahli, Kisika, Kikamba, Kipokono, Kikisan, Kigalla*: Krapf, Tubingen, 1850, 8vo.

Malagasy.—Houtmann (Malaysche en Madagask Talen), Amst. 1603, 2nd ed. Mattheyz, ib. 1680, 8vo; Huet de Froberville, Isle de France, fol. 2 vols.; Flacourt, Paris, 1668, 8vo; Challand (Southern), Isle de France, 1773, 4to; Freeman and Johns, London, 1835, 8vo, 2 vols.; Dalmont (Malgache, Salalave, ed. Betsimara), 1842, 8vo; Kessler, London, 1870, 8vo.

Southern Africa.—*Bleek, The Languages of Mosambique*, London, 1856, 8vo. *Kaffre*: Bennie, Lovedale, 1826, 16mo; Ayliffe, Graham's Town, 1846, 12mo; Appleyard, 1850, 8vo; Bleek, Bonn, 1853, 4to, 646 pages. *Zulu-Kaffre*: Perrin (Kaffre-Eng.), London, 1855, 24mo, 172 pages; Id. (Eng.-Kaffre), Pietermaritzburg, 1855, 24mo, 227 pages; Id. (Eng.-Zulu), ib. 1865, 12mo, 226 pages; Dohne, Cape Town, 1857, 8vo, 428 pages; Colozen, Pietermaritzburg, 1861, 8vo, 560 pages, about 8000 words. *Hottentot*: Bleek, Cape Town, 1857, 4to, 261 pages. *Namaqua*: Tindall, ib. 1852, 8vo; *Vocabulary*, Barmen, 1854, 8vo; Hahn, Leipzig, 1870, 12mo. *Sechuanu*: Casalis, Paris, 1841, 8vo. *Herero*: Hahn, Berlin, 1857, 8vo, 207 pages, 4300 words.

Western Africa.—*Akra or Ga*: Zimmermann, Stuttgart, 1858, 8vo, 690 pages. *Ashantee*: Christaller (also Akra), Basel, 1874, 8vo, 299 pages. *Bullom*: Nylander, London, 1814, 12mo. *Burda or Angola*: Connetatim, Lisboa, 1804, 4to, 722 pages. *Dualla Grammatical Elements*, &c., Cameroons, 1855, 8vo. *Efik or Old Calabar*: Waddell, Old Calabar, 1846, 16mo, 126 pages; Edinb. 1849, 8vo, 95 pages. *Eyo*: Raban, London, 1830-1831, 12mo, 2 parts. *Grebo*: *Vocabulary*, Cape Palmas, 1837, 8vo; *Dictionary*, ib. 1839, 8vo, 119 pages. *Ifo*: Schlegel, Stuttgart, 1857, 8vo. *Mpongwe*: De Lorme (Frang.-Pongoué), Paris, 1876, 12mo, 354 pages. *Oyi*: Riis, Basel, 1854, 8vo, 284 pages. *Sherbro*: Schön, s. a. e. 1. 8vo, written in 1830, 42 pages. *Susu*: Brunton, Edinburgh, 1802, 8vo, 145 pages. *Veri*: Koelle, London, 1854, 8vo, 266 pages. *Wolof and Bambara*: Dard, Paris, 1825, 8vo. *Wolof*: Roger, ib. 1829, 8vo; *Missionnaires de S. Esprit*, Dakar, 1855, &c. 16mo. *Faidherbe* (French-Wolof, Poula and Soninke), St Louis, Senegambila, 1860, 12mo. *Yoruba*: Crowther, London, 1843, 8vo; 1852, 298 pages; Vidal, ib. 1852, 8vo; Bowen, Washington, 1858, 4to.

Central Africa.—Barth, *Vocabularies*, Gotha, 1862-1866, 4to. *Eari*: Mitterreutzner, Brixen, 1867, 8vo; Reinisch, Vienna, 1874, 8vo. *Dinka*: Mitterreutzner, Brixen, 1866, 8vo. *Hausa*: Schön (Eng.), London, 1843, 8vo.

Berber.—Venture de Paradis, Paris, 1844, 8vo; Brosselard, ib. 1844, 8vo; Delaporte, ib. 1844, 4to, by order of the Minister of War; Creusart, Franc.-Kabye (Zouaoua), Alger, 1873, 8vo. *Siwahk*: Minutoli, Berlin, 1827, 4to.

AUSTRALIA AND POLYNESIA

Australia.—*New South Wales*: Threlkeld (Lake Macquarie Language), Sydney, 1834, 8vo. *Victoria*: Bunce, Melbourne, 1856, 12mo, about 2200 words. *South Australia*: Williams, South Australia, 1839, 8vo; Teichelmann and Schürmann, Adelaide, 1840, 8vo; Meyer, ib. 1843, 8vo. *Murray River*: Moorhouse, ib. 1846, 8vo. *Parnkalla*: Schürmann, Adelaide, 1844, 8vo. *Woolner District*: *Vocabulary*, ib. 1869, 12mo. *Western Australia*: Sir George Grey, Perth, 1839, 4to; London, 1840, 8vo; Moore, ib. 1843; Brady, Roma, 1845, 24mo, 8vo, 187 pages. *Tasmania*: Millegan, Tasmania, 1857.

Polynesian.—*Hale, Grammars and Vocabularies of all the Polynesian Languages*, Philadelphia, 1846, 4to. *Marquesas*, *Sandwich Cambric*: Moschke, Paris, 1843, 8vo. *Havation*: Andrews, *Vocabulary*, Lahainaluna, 1636, 8vo; Id., *Dictionary*, Honolulu, 1865, 8vo, 575 pages, about 15,500 words. *Marquesas*: Pierquin, de Gembloux, Bourges, 1843, 8vo; Buschmann, Berlin, 1843, 8vo. *Samoan*: *Dictionary*, Samoa, 1862, 8vo. *Tahitian*: *A Tahitian and English Dictionary*, Tahiti, 1851, 8vo, 314 pages. *Tonga*: Rabone, Vavau, 1845, 8vo. *Fijian*: Hazlewood (Fiji-Eng.), Vewa, 1850,

12mo: Id. (Eng.-Fijij), *ib.* 1852, 12mo: Id., London, 1872, 8vo. *Maori*: Kendall, 1820, 12mo: Williams, Pahl, 1844, 8vo; 3rd ed. London, 1871, 8vo: Taylor, Auckland, 1870, 12mo.

AMERICA

North America.—*Eskimo*: Washington, London, 1850, 8vo: Petitot (Mackenzie and Anderson Rivers), Paris, 1876, 4to. *Kinai*: Radloff, St Petersburg, 1874, 4to. *Greenland*: Egede (Gr. Dan. Lat., 3 parts), Hafn, 1750, 8vo; 1760, Fabricius, Kjöbenhavn, 1804, 4to. *Hudson's Bay Indians*: Bowrey, London, 1701, fol. *Abnaki*: Rasles, Cambridge, U.S., 1833, 4to. *Chippewa*: Baraga, Cincinnati, 1853, 12mo, 622 pages: Petitot, Paris, 1876, 4to, 455 pages. *Massachusetts of White-Cotton*, Cambridge, U.S., 1829, 8vo. *Onondaga*: Shea (French-Onon), from a MS. (of 17th century), London, 1860, 4to, 109 pages. *Dacota*: Riggs, New York, 1851, 4to, 424 pages: Williamson (Eng. Dac.), Santos Agency, Nebraska, 12mo, 139 pages. *Mohawk*: Bruyas, New York, 1863, 8vo. *Hidatsa* (*Minnetarees, Gros Ventres of the Missouri*): Matthews, *ib.* 1874, 8vo. *Choclaw*: Byington, *ib.* 1852, 16mo. *Clallam and Lummi*: Gibbs, *ib.* 1863, 8vo. *Yakama*: Pandosy, translated by Gibbs and Shea, *ib.* 1862, 8vo. *Chinook*: Gibbs, New York, 1863, 4to. *Chinook Jargon, the trade language of Oregon*: Id., *ib.* 1863, 8vo. *Tatche or Telamé*: Sitjar, *ib.* 1841, 8vo.

Mexico and Central America.—*Tepehuan*: Rinaldini, Mexico, 1743, 4to. *Cora*: Ortega, Mexico, 1732, 4to. *Tarahumara*: Steffel, Brünn, 1791, 8vo. *Olomi*: Carochi, Mexico, 1645, 4to: Neve y Molina, *ib.* 1767, 8vo: Yepes, *ib.* 1826, 4to: Piccolomini, Roma, 1841, 8vo. *Mexican or Asteq*: Molina, Mexico, 1555, 4to; 1571, fol. 2 vols.: Arenas, *ib.* 1583; 1611, 8vo; 1683; 1725; 1793, 12mo: Biondelli, Milan, 1869, fol. *Mexican, Totonacan, and Huastecan*: Olmos, Mexico, 1555-1560, 4to, 2 vols. *Huastecan*: Tapia Zenteno, *ib.* 1767, 4to, 128 pages. *Opata or Teguisima*: Lombardo, *ib.* 1702, 4to. *Tarasca*: Gilberti, *ib.* 1559, 4to: Lagunas, *ib.* 1574, 8vo. *Mixtecan*: Alvarado, Mexico, 1593, 4to. *Zapoteca*: Cordova, *ib.* 1578, 4to. *Maya*: Beltran de Santa Rosa Maria, *ib.* 1746, 4to: Merida de Yucatan, 1859, 4to, 250 pages: Brassier de Bourbonnais, Paris, 1874, 8vo, 745 pages. *Quiché*: Id. (also Cakchiquel and Trutuhil dialects), *ib.* 1862, 8vo.

South America.—*Chilcha*: Uricoechea, Paris, 1871, 8vo. *Chayma*: Tauste, Madrid, 1680, 4to: Yanguas, Burgos, 1683, 4to. *Carib*: Raymond, Auxerre, 1665-1666, 8vo. *Galibi*: D[.]e[.], L[.], S[.], [.]auvage], Paris, 1763, 8vo. *Tupji*: Costa Rubim, Rio de Janeiro, 1853, 8vo: Silva Guimarães, Bahia, 1854, 8vo: Diaz, Lipsia, 1858, 16mo. *Guaraní*: Ruiz de Montoya, Madrid, 1639, 4to; 1640; 1722, 4to: ed. Platzmann, Leipzig, 1876, 8vo. *8vo.*, to be in 4 vols, 1850 pages. *Moxa*: Marban, Lima, 1701, 8vo. *Lule*: Machoni de Corderia, Madrid, 1732, 12mo. *Quichua*: Santo Thomas, Ciudad de los Reyes, 1586, 8vo: Torres Rubio, Sevilla, 1603, 8vo: Lima; 1609, 8vo; ed. Figueroa, Lima, 1754, 8vo; Holguin, Ciudad de los Reyes, 1668, 8vo: Tschudi, Wien, 1853, 8vo, 2 vols.: Markham, London, 1864, 8vo: Lopez, *Las Races Arjennes de Perou*, Paris, 1871, 8vo, comparative vocabulary, pp. 345-421. *Aymara*: Bertoni, Chicuyto, 1612, 4to, 2 vols. *Chileno*: Valdivia (also Allentiac and Milcoacayac), Lima, 1607, 8vo: Febres, *ib.* 1765, 12mo; ed. Hernandez y Caluza, Santiago, 1846, 8vo, 2 vols. *Tsonacan* (Patagonian): Schmid, Bristol, 1860, 12mo.

The above article incorporates the salient features of the 9th-edition article by the Rev. Ponsosny A. Lyons, and the 10th-edition article by Benjamin E. Smith.

DICTYOGENS (Gr. *δίκτυον*, a net, and the termination *-γενής*, produced), a botanical name proposed by John Lindley for a class including certain families of Monocotyledons which have net-veined leaves. The class was not generally recognized.

DICTYS CRETENSIS, of Cnossus in Crete, the supposed companion of Idomeneus during the Trojan War, and author of a diary of its events. The MS. of this work, written in Phoenician characters, was said to have been found in his tomb (enclosed in a leaden box) at the time of an earthquake during the reign of Nero, by whose order it was translated into Greek. In the 4th century A.D. a certain Lucius Septimius brought out *Dictys Cretensis Ephemeris belli Trojani*, which professed to be a Latin translation of the Greek version. Scholars were not agreed whether any Greek original really existed; but all doubt on the point was removed by the discovery of a fragment in Greek amongst the papyri found by B. P. Grenfell and A. S. Hunt in 1905-1906. Possibly the Latin Ephemeris was the work of Septimius himself. Its chief interest lies in the fact that (together with Dares Phrygius's *De excidio Trojæ*) it was the source from which the Homeric legends were introduced into the romantic literature of the middle ages.

Best edition by F. Meister (1873), with short but useful introduction and index of Latinity; see also G. Korting, *Diktys und Dares*

(1874), with concise bibliography; H. Dunger, *Die Sage vom trojanischen Kriege in den Bearbeitungen des Mittelalters und ihren antiken Quellen* (1869, with a literary genealogical table); E. Collilieux, *Étude sur Dictys de Crète et Dares de Phrygie* (1887), with bibliography; W. Greif, "Die mittelalterlichen Bearbeitungen der Trojanerage," in E. M. Stengel's *Ausgaben und Abhandlungen aus dem Gebiete der romanischen Philologie*, No. 61 (1886, esp. sections 82, 83, 168-172); F. Colagrosso, "Ditte Cretese" in *Atti della Accademia di Archeologia* (Naples, 1897, vol. 18, pt. ii. 2); F. Noack, "Der griechische Dictys," in *Philologus*, supp. vi. 403 ff.; N. E. Griffin, *Dares and Dictys, Introduction to the Study of the Medieval Versions of the Story of Troy* (1907).

DICUIL (fl. 825), Irish monastic scholar, grammarian and geographer. He was the author of the *De mensura orbis terræ*, finished in 825, which contains the earliest clear notice of a European discovery of and settlement in Iceland and the most definite Western reference to the old freshwater canal between the Nile and the Red Sea, finally blocked up in 767. In 795 (February 1-August 1) Irish hermits had visited Iceland; on their return they reported the marvel of the perpetual day at midsummer in "Thule," where there was then "no darkness to hinder one from doing what one would." These hermits also navigated the sea north of Iceland on their first arrival, and found it ice-free for one day's sail, after which they came to the ice-wall. Relics of this, and perhaps of other Irish religious settlements, were found by the permanent Scandinavian colonists of Iceland in the 9th century. Of the old Egyptian freshwater canal Dicuill learnt from one "brother Fidelis," probably another Irish monk, who, on his way to Jerusalem, sailed along the "Nile" into the Red Sea—passing on his way the "Barns of Joseph" or Pyramids of Giza, which are well described. Dicuill's knowledge of the islands north and west of Britain is evidently intimate; his references to Irish exploration and colonization, and to (more recent) Scandinavian devastation of the same, as far as the Faeroes, are noteworthy, like his notice of the elephant sent by Harun al-Rashid (in 801) to Charles the Great, the most curious item in a political and diplomatic intercourse of high importance. Dicuill's reading was wide; he quotes from, or refers to, thirty Greek and Latin writers, including the classical Homer, Hecataeus, Herodotus, Thucydides, Virgil, Pliny and King Juba, the sub-classical Solinus, the patristic St Isidore and Orosius, and his contemporary the Irish poet Sedulius;—in particular, he professes to utilize the alleged surveys of the Roman world executed by order of Julius Caesar, Augustus and Theodosius (whether Theodosius the Great or Theodosius II. is uncertain). He probably did not know Greek; his references to Greek authors do not imply this. Though certainly Irish by birth, it has been conjectured (from his references to Sedulius and the caliph's elephant) that he was in later life in an Irish monastery in the Frankish empire. Letronne inclines to identify him with Dicuill or Dichull, abbot of Pahlacht, born about 760.

There are seven chief MSS. of the *De mensura* (Dicuill's tract on grammar is lost); of these the earliest and best are (1) Paris, National Library, Lat. 4806; (2) Dresden, Regius D. 182; both are of the 10th century. Three editions exist: (1) C. A. Walckenaer's, Paris, 1807; (2) A. Letronne's, Paris, 1814, best as to commentary; (3) G. Parthey's, Berlin, 1870, best as to text. See also C. R. Beazley, *Dawn of Modern Geography* (London, 1897), i. 317-327, 522-523, 529; T. Wright, *Biographia Britannica literaria, Anglo-Saxon Period* (London, 1842), pp. 372-376.

DIDACHĒ, THE, or Teaching of the (twelve) Apostles,—the most important of the recent recoveries in the region of early Christian literature (see APOCRYPHAL LITERATURE). It was previously known by name from lists of canonical and extra-canonical books compiled by Eusebius and other writers. Moreover, it had come to be suspected by several scholars that a lost book, variously entitled *The Two Ways* or *The Judgment of Peter*, had been freely used in a number of works, of which mention must presently be made. In 1882 a critical reconstruction of this book was made by Adam Krawtzycki with marvellous accuracy, as was shown when in the very next year the Greek bishop and metropolitan, Philotheus Bryennius, published *The Teaching of the Twelve Apostles* from the same manuscript from

which he had previously published the complete form of the *Epistle of Clement*.¹

The *Didaché*, as we now have it in the Greek, falls into two marked divisions: (a) a book of moral precepts, opening with the words, "There are two ways"; (b) a manual of church ordinances, linked on to the foregoing by the words, "Having first said all these things, baptize, &c." Each of these must be considered separately before we approach the question of the locality and date of the whole book in its present form.

1. *The Two Ways*.—The author of the complete work, as we now have it, has modified the original *Two Ways* by inserting near the beginning a considerable section containing, among other matter, passages from the Sermon on the Mount, in which the language of St Matthew's Gospel is blended with that of St Luke's. He has also added at the close a few sentences, beginning, "If thou canst not bear (the whole yoke of the Lord), bear what thou canst" (vi. 2); and among minor changes he has introduced, in dealing with confession, reference to "the church" (iv. 14). No part of this matter is to be found in the following documents, which present us in varying degrees of accuracy with *The Two Ways*: (i) the *Epistle of Barnabas*, chaps. xix., xx. (in which the order of the book has been much broken up, and a good deal has been omitted); (ii) the *Ecclesiastical Canons of the Holy Apostles*, usually called the *Apostolic Church Order*, a book which presents a parallel to the *Teaching*, in so far as it consists first of a form of *The Two Ways*, and secondly of a number of church ordinances (here, however, as in the Syriac *Didascalia*, which gives about the same amount of *The Two Ways*, various sections are ascribed to individual apostles, e.g. "John said, There are two ways," &c.); (iii) a discourse of the Egyptian monk Schnudi (d. 451), preserved in Arabic (see Iselin, *Texte u. Unters.*, 1895); (iv) a Latin version, of which a fragment was published by O. von Gebhardt in 1884, and the whole by J. Schlecht in 1900. When by the aid of this evidence *The Two Ways* is restored to us free of glosses, it has the appearance of being a Jewish manual which has been carried over into the use of the Christian church. This is of course only a probable inference; there is no prototype extant in Jewish literature, and, comparing the moral (non-doctrinal) instruction for Christian catechumens in *Hermas*, *Shepherd* (*Mand.* i.-ix.), no real need to assume one. There was a danger of admitting Gentile converts to the church on too easy moral terms; hence the need of such insistence on the ideal as in *The Two Ways* and the *Mandates*. The recent recovery of the Latin version is of singular interest, as showing that, even without the distinctively Christian additions and interpolations which our full form of the *Teaching* presents, it was circulating under the title *Doctrina apostolorum*.²

2. The second part of our *Teaching* might be called a church directory. It consists of precepts relating to church life, which are couched in the second person plural; whereas *The Two Ways* uses throughout the second person singular. It appears to be a composite work. First (vii. 1-xi. 2) is a short sacramental manual intended for the use of local elders or presbyters, though such are not named, for they were not yet a distinctive order or clergy. This section was probably added to *The Two Ways* before the addition of the remainder. It orders baptism in the threefold name, making a distinction as to waters which has Jewish parallels, and permitting a threefold pouring on the head, if sufficient water for immersion cannot be had. It prescribes a fast before baptism for the baptizer as well as the candidate. Fasts are to be kept on Wednesday and Friday, not Monday and Thursday, which are the fast days of "the hypocrites," i.e. by a perversion of the Lord's words, the Jews. "Neither pray ye as

the hypocrites; but as the Lord commanded in His Gospel." Then follows the Lord's Prayer, almost exactly as in St Matthew, with a brief doxology—"for Thine is the power and the glory for ever." This is to be said three times a day. Next come three eucharistic prayers, the language of which is clearly marked off from that of the rest of the book, and shows parallels with the diction of St John's Gospel. They are probably founded on Jewish thanksgivings, and it is of interest to note that a portion of them is prescribed as a grace before meat in (pseudo-) Athanasius' *De virginitate*. A trace of them is found in one of the liturgical prayers of Serapion, bishop of Thmuis, in Egypt, but they have left little mark on the liturgies of the church. As in Ignatius and other early writers, the eucharist, a real meal (x. 1) of a family character, is regarded as producing immortality (cf. "spiritual food and drink and eternal life"). None are to partake of it save those who have been "baptized in the name of the Lord" (an expression which is of interest in a document which prescribes the threefold formula). The prophets are not to be confined to these forms, but may "give thanks as much as they will." This appears to show that a prophet, if present, would naturally preside over the eucharist. The next section (xi. 3-xiii.) deals with the ministry of spiritual gifts as exercised by apostles, prophets and teachers. An apostle is to be "received as the Lord"; but he must follow the Gospel precepts, stay but one or two days, and take no money, but only bread enough for a day's journey. Here we have that wider use of the term "apostle" to which Lightfoot had already drawn attention. A prophet, on the contrary, may settle if he chooses, and in that case he is to receive tithes and first-fruits; "for they are your high priests." If he be once approved as a true prophet, his words and acts are not to be criticized; for this is the sin that shall not be forgiven. Next comes a section (xiv., xv.) reflecting a somewhat later development concerning fixed services and ministry; the desire for a stated service, and the need of regular provision for it, is leading to a new order of things. The eucharist is to be celebrated every Lord's Day, and preceded by confession of sins, "that your sacrifice may be pure . . . for this is that sacrifice which was spoken of by the Lord. In every place and time to offer unto Me a pure sacrifice. Appoint therefore unto yourselves bishops and deacons, worthy of the Lord, men meek and uncovetous, and true and approved; for they also minister unto you the ministration of the prophets and teachers: Therefore despise them not; for they are your honoured ones, together with the prophets and teachers." This is an arrangement recommended by one who has tried it, and he reassures the old-fashioned believer who clings to the less formal régime (and whose protest was voiced in the Montanist movement), that there will be no spiritual loss under the new system. The book closes (chap. xvi.) with exhortations to steadfastness in the last days, and to the coming of the "world-deceiver" or Antichrist, which will precede the coming of the Lord. This section is perhaps the actual utterance of a Christian prophet, and may be of earlier origin than the two preceding sections.

3. It will now be clear that indications of the locality and date of our present *Teaching* must be sought for only in the second part, and in the Christian interpolations in the first part. We have no ground for thinking that the second part ever existed independently as a separate book. The whole work was in the hands of the writer of the seventh book of the *Apostolic Constitutions*, who embodies almost every sentence of it, interspersing it with passages of Scripture, and modifying the precepts of the second part to suit a later (4th-century) stage of church development; this writer was also the interpolator of the Epistles of Ignatius, and belonged to the Syrian Church. Whether the second part was known to the writer of the *Apostolic Church Order* is not clear, as his only quotation of it comes from one of the eucharistic prayers. The allusions of early writers seem to point to Egypt, but their references are mostly to the first part, so that we must be careful how we argue from them as to the provenance of the book as a whole. Against Egypt has been urged the allusion in one of the eucharistic prayers to "corn upon the mountains." This is found in the Prayer-book of Serapion

¹ The MS. was found in the Library of the Jerusalem Monastery of the Most Holy Sepulchre, in Phanar, the Greek quarter of Constantinople. It is a small octavo volume of 120 parchment leaves, written throughout by Leo, "notary and sinner," who finished his task on the 11th of June 1156. Besides *The Didaché* and the Epistles of Clement it contains several spurious Ignatian epistles.

² The word *teche* had no place in the original title and was inserted when the original *Didaché* or *Teaching* (e.g. *The Two Ways*) was combined with the church manual which mentions apostles outside of the twelve. It may be noted that the division of the *Didaché* into chapters is due to Bryennius, that into verses to A. Harnack.

(c. 350) but omitted in a later Egyptian prayer; the form as we have it in *The Didaché* may have passed into Egypt with the authority of tradition which was afterwards weakened. The anti-Jewish tone of the second part suggests the neighbourhood of Jews, from whom the Christians were to be sharply distinguished. Either Egypt or Syria would satisfy this condition, and in favour of Syria is the fact that the presbyterate there was to a late date regarded as a rank rather than an office. If we can connect the injunctions (vi. 3) concerning (abstinence from certain) food and that which is offered to idols with the old trouble that arose at Antioch (Acts xv. 1) and was legislated for by the Jerusalem council, we have additional support for the Syrian claim. But all that we can safely say as to locality is that the community here represented seems to have been isolated, and out of touch with the larger centres of Christian life.

This last consideration helps us in discussing the question of date. For such an isolated community may have preserved primitive customs for some time after they had generally disappeared. Certainly the stage of development is an early one, as is shown, e.g., by the prominence of prophets, and the need that was felt for the vindication of the position of the bishops and deacons (there is no mention at all of presbyters); moreover, there is no reference to a canon of Scripture (though the written Gospel is expressly mentioned) or to a creed. On the other hand the "apostles" of the second part are obviously not "the twelve apostles" of the title; and the prophets seem in some instances to have proved unworthy of their high position. The ministry of enthusiasm which they represent is about to give way to the ministry of office, a transition which is reflected in the New Testament in the 3rd Epistle of John. Three of the Gospels have clearly been for some time in circulation; St Matthew's is used several times, and there are phrases which occur only in St Luke's, while St John's Gospel lies behind the eucharistic prayers which the writer has embodied in his work. There are no indications of any form of doctrinal heresy as needing rebuke; the warnings against false teaching are quite general. While the first part must be dated before the Epistle of Barnabas, i.e. before A.D. 90, it seems wisest not to place the complete work much earlier than A.D. 120, and there are passages which may well be later.

A large literature has sprung up round *The Didaché* since 1884. Harnack's edition in *Texte u. Unters.* vol. ii. (1884) is indispensable to the student; and his discussions in *Alchrisil. Literatur* and *Chronologie* give clear summaries of his work. Other editions of the text are those of F. X. Funk, *Patres Apostolici*, vol. i. (Tübingen, 1901); H. Lietzmann (Bonn, 1903; with Latin version). Dr J. E. Odgers has published an English translation with introduction and notes (London, 1906). Dr C. Taylor in 1886 drew attention to some important parallels in Jewish literature; his edition contains an English translation. Dr Rendel Harris published in 1887 a complete facsimile, and gathered a great store of patristic illustration. Text and translation will also be found in Lightfoot's *Apostolic Fathers* (ed. min.) The fullest critical treatment in English is by Dr Vernon Bartlet in the extra volume of Hastings's *Dictionary of the Bible*; the most complete commentary on the text is by P. Drews in Hennecke's *Handbuch zu den N.T. Apocryphen* (1904). Other references to the literature may be found by consulting Harnack's *Alchrisil. Literatur*.

DIDACTIC POETRY, that form of verse the aim of which is, less to excite the hearer by passion or move him by pathos, than to instruct his mind and improve his morals. The Greek word *διδασκαλίας* signifies a teacher, from the verb *διδάσκω*, and poetry of the class under discussion approaches us with the arts and graces of a schoolmaster. At no time was it found convenient to combine lyrical verse with instruction, and therefore from the beginning of literature the didactic poets have chosen a form approaching the epical. Modern criticism, which discourages the epic, and is increasingly anxious to limit the word "poetry" to lyric, is inclined to exclude the term "didactic poetry" from our nomenclature, as a phrase absurd in itself. It is indeed more than probable that didactic verse is hopelessly obsolete. Definite information is now to be found in a thousand shapes, directly and boldly presented in clear and technical prose. No farmer, however elegant, will any longer choose to study agriculture in hexameters, or even in Tusser's shuffling metre. The sciences and the professions will not waste their time on

methods of instruction which must, from their very nature, be artless, inexact and vague. But in the morning of the world, those who taught with authority might well believe that verse was the proper, nay, the only serious vehicle of their instruction. What they knew was extremely limited, and in its nature it was simple and straightforward; it had little technical subtlety; it constantly lapsed into the fabulous and the conjectural. Not only could what early sages knew, or guessed, about astronomy and medicine and geography be conveniently put into rolling verse, but, in the absence of all written books, this was the easiest way in which information could be made attractive to the ear and be retained by the memory.

In the prehistoric dawn of Greek civilization there appear to have been three classes of poetry, to which the literature of Europe looks back as to its triple fountain-head. There were romantic epics, dealing with the adventures of gods and heroes; these Homer represents. There were mystic chants and religious odes, purely lyrical in character, of which the best Orphic Hymns must have been the type. And lastly there was a great body of verse occupied entirely with increasing the knowledge of citizens in useful branches of art and observation; these were the beginnings of didactic poetry, and we class them together under the dim name of Hesiod. It is impossible to date these earliest didactic poems, which nevertheless set the fashion of form which has been preserved ever since. The *Works and Days*, which passes as the direct masterpiece of Hesiod (q.v.), is the type of all the poetry which has had education as its aim. Hesiod is supposed to have been a tiller of the ground in a Boeotian village, who determined to enrich his neighbours' minds by putting his own ripe stores of useful information into sonorous metre. Historically examined, the legend of Hesiod becomes a shadow, but the substance of the poems attributed to him remains. The genuine parts of the *Works and Days*, which Professor Gilbert Murray has called "a slow, lowly, simple poem," deal with rules for agriculture. The *Theogony* is an annotated catalogue of the gods. Other poems attributed to Hesiod, but now lost, were on astronomy, on auguries by birds, on the character of the physical world; still others seem to have been genealogies of famous women. All this mass of Boeotian verse was composed for educational purposes, in an age when even preposterous information was better than no knowledge at all. In slightly later times, as the Greek nation became better supplied with intellectual appliances, the stream of didactic poetry flowed more and more closely in one, and that a theological, channel. The great poem of Parmenides *On Nature* and those of Empedocles exist only in fragments, but enough remains to show that these poets carried on the didactic method in mythology. Cleostratus of Tenedos wrote an astronomical poem in the 6th century, and Periander a medical one in the 4th, but didactic poetry did not flourish again in Greece until the 3rd century, when Aratus, in the Alexandrian age, wrote his famous *Phenomena*, a poem about things seen in the heavens. Other later Greek didactic poets were Nicander, and perhaps Euphorion.

It was from the hands of these Alexandrian writers that the genius of didactic poetry passed over to Rome, since, although it is possible that some of the lost works of the early republic, and in particular those of Ennius, may have possessed an educational character, the first and by far the greatest didactic Latin poet known to us is Lucretius. A highly finished translation by Cicero into Latin hexameters of the principal works of Aratus is believed to have drawn the attention of Lucretius to this school of Greek poetry, and it was not without reference to the Greeks, although in a more archaic and far purer taste, that he composed, in the 1st century before Christ, his magnificent *De rerum natura*. By universal consent, this is the noblest didactic poem in the literature of the world. It was intended to instruct mankind in the interpretation and in the working of the system of philosophy revealed by Epicurus, which at that time was exciting the sympathetic attention of all classes of Roman society. What gave the poem of Lucretius its extraordinary interest, and what has prolonged and even increased its vitality, was the imaginative and illustrative insight of the author, piercing and lighting up the

recesses of human experience. On a lower intellectual level, but of a still greater technical excellence, was the *Georgics* of Virgil, a poem on the processes of agriculture, published about 30 B.C. The brilliant execution of this famous work has justly made it the type and unapproachable standard of all poetry which desires to impart useful information in the guise of exquisite literature. Himself once a farmer on the banks of the Mincio, Virgil, at the apex of his genius, set himself in his Campanian villa to recall whatever had been essential in the agricultural life of his boyish home, and the result, in spite of the arduous of the subject, was what J. W. Mackail has called "the most splendid literary production of the Empire." In the rest of surviving Latin didactic poetry, the influence and the imitation of Virgil and Lucretius are manifest. Manilius, turning again to Alexandria, produced a fine *Astronomica* towards the close of the reign of Augustus. Columella, regretting that Virgil had omitted to sing of gardens, composed a smooth poem on horticulture. Natural philosophy inspired Lucilius junior, of whom a didactic poem on Etna survives. Long afterwards, under Diocletian, a poet of Carthage, Nemesianus, wrote in the manner of Virgil the *Cynegetica*, a poem on hunting with dogs, which has had numerous imitations in later European literatures. These are the most important specimens of didactic poetry which ancient Rome has handed down to us.

In Anglo-Saxon and early English poetic literature, and especially in the religious part of it, an element of didacticism is not to be overlooked. But it would be difficult to say that anything of importance was written in verse with the sole purpose of imparting information, until we reach the 16th century. Some of the later medieval allegories are didactic or nothing. The first poem, however, which we can in any reasonable way compare with the classic works of which we have been speaking is the *Hundredth Pointes of Good Husbandrie*, published in 1557 by Thomas Tusser; these humble Georgics aimed at a practical description of the whole art of English farming. Throughout the early part of the 17th century, when our national poetry was in its most vivid and brilliant condition, the last thing a poet thought of doing was the setting down of scientific facts in rhyme. We come across, however, one or two writers who were as didactic as the age would permit them to be, Samuel Daniel with his philosophy, Fulke Greville, Lord Brooke with his "treatises" of war and monarchy. After the Restoration, as the lyrical element rapidly died out of English poetry, there was more and more room left for educational rhetoric in verse. The poems about prosody, founded upon Horace, and signed by John Sheffield, 3rd earl of Mulgrave (1648-1721), and Lord Roscommon, were among the earliest purely didactic verse-studies in English. John Philips deserves a certain pre-eminence, as his poem called *Cyder*, in 1706, set the fashion which lasted all down the 18th century, of writing precisely in verse about definite branches of industry or employment. None of the greater poets of the age of Anne quite succumbed to the practice, but there is a very distinct flavour of the purely didactic about a great deal of the verse of Pope and Gay. In such productions as Gilbert West's (1703-1756) *Education*, Dyer's *Fleece*, and Somerville's *Chase*, we see technical information put forward as the central aim of the poet. Instead of a passionate pleasure, or at least an uplifted enthusiasm, being the poet's object, he frankly admits that, first and foremost, he has some facts about wool or dogs or schoolmasters which he wishes to bring home to his readers, and that, secondly, he consents to use verse, as brilliantly as he can, for the purpose of gilding the pill and attracting an unwilling attention. As we descend the 18th century, these works become more and more numerous, and more dry, especially when opposed by the descriptive and rural poets of the school of Thomson, the poet of *The Seasons*. But Thomson himself wrote a huge poem of *Liberty* (1732), for which we have no name if we must not call it didactic. Even Gray began, though he failed to finish, a work of this class, on *The Alliance of Education and Government*. These poems were discredited by the publication of *The Sugar-Cane* (1764), a long verse-treatise about the cultivation of sugar by negroes in the West Indies, by James Grainger (1721-1766), but,

though liable to ridicule, such versified treatises continued to appear. Whether so great a writer as Cowper is to be counted among the didactic poets is a question on which readers of *The Task* may be divided; this poem belongs rather to the class of descriptive poetry, but a strong didactic tendency is visible in parts of it. Perhaps the latest frankly educational poem which enjoyed a great popularity was *The Course of Time* by Robert Pollok (1798-1827), in which a system of Calvinistic divinity is laid down with severity and in the pomp of blank verse. This kind of literature had already been exposed, and discouraged, by the teaching of Wordsworth, who had insisted on the imperative necessity of charging all poetry with imagination and passion. Oddly enough, *The Excursion* of Wordsworth himself is perhaps the most didactic poem of the 19th century, but it must be acknowledged that his influence, in this direction, was saner than his practice. Since the days of Coleridge and Shelley it has been almost impossible to conceive a poet of any value composing in verse a work written with the purpose of inculcating useful information.

The history of didactic poetry in France repeats, in great measure, but in drearier language, that of England. Boileau, like Pope, but with a more definite purpose as a teacher, offered instruction in his *Art poétique* and in his *Epistles*. But his doctrine was always literary, not purely educational. At the beginning of the 18th century, the younger Racine (1692-1763) wrote sermons in verse, and at the close of it the Abbé Delille (1738-1813) tried to imitate Virgil in poems about horticulture. Between these two there lies a vast mass of verse written for the indulgence of intellect rather than at the dictates of the heart; wherever this aims at increasing knowledge, it at once becomes basely and flatly didactic. There is nothing in French literature of the transitional class that deserves mention beside *The Task* or *The Excursion*.

During the century which preceded the Romantic revival of poetry in Germany, didactic verse was cultivated in that country on the lines of imitation of the French, but with a greater dryness and on a lower level of utility. Modern German literature began with Martin Opitz (1597-1639) and the Sillesian School, who were in their essence rhetorical and educational, and who gave their tone to German verse. Albrecht von Haller (1708-1777) brought a very considerable intellectual force to bear on his huge poems, *The Origin of Evil*, which was theological, and *The Alps* (1720), botanical and topographical. Johann Peter Uz (1720-1796) wrote a *Theodicee*, which was very popular, and not without dignity. Johann Jacob Dusch (1725-1787) undertook to put *The Sciences* into the eight books of a great didactic poem. Tiedge (1752-1840) was the last of the school; in a once-famous *Urania*, he sang of God and Immortality and Liberty. These German pieces were the most unswervingly didactic that any modern European literature has produced. There was hardly the pretence of introducing into them descriptions of natural beauty, as the English poets did, or of grace and wit like the French. The German poets simply poured into a lumbering mould of verse as much solid information and direct instruction as the form would hold.

Didactic poetry has, in modern times, been antipathetic to the spirit of the Latin peoples, and neither Italian nor Spanish literature has produced a really notable work in this class. An examination of the poems, ancient and modern, which have been mentioned above, will show that from primitive times there have been two classes of poetic work to which the epithet didactic has been given. It is desirable to distinguish these a little more exactly. One is the pure instrument of teaching, the poetry which desires to impart all that it knows about the growing of cabbages or the prevention of disasters at sea, the revolution of the planets or the blessings of inoculation. This is didactic poetry proper, and this, it is almost certain, became irrevocably obsolete at the close of the 18th century. No future Virgil will give the world a second *Georgics*. But there is another species which it is very improbable that criticism has entirely dislodged; that is the poetry which combines, with philosophical instruction, an impetus of imaginative movement, and a certain definite cultivation

of fire and beauty. In hands so noble as those of Lucretius and Goethe this species of didactic poetry has enriched the world with durable masterpieces, and, although the circle of readers which will endure scientific disquisition in the bonds of verse grows narrower and narrower, it is probable that the great poet who is also a great thinker will now and again insist on being heard. In Sully-Prudhomme France has possessed an eminent writer whose methods are directly instructive, and both *La Justice* (1878) and *Le Bonheur* (1888) are typically didactic poems. Perhaps future historians may name these as the latest of their class. (E. G.)

DIDEROT, DENIS (1713-1784), French man of letters and encyclopaedist, was born at Langres on the 5th of October 1713. He was educated by the Jesuits, like most of those who afterwards became the bitterest enemies of Catholicism; and, when his education was at an end, he vexed his brave and worthy father's heart by turning away from respectable callings, like law or medicine, and throwing himself into the vagabond life of a bookseller's hack in Paris. An imprudent marriage (1743) did not better his position. His wife, Anne Toinette Champion, was a devout Catholic, but her piety did not restrain a narrow and fretful temper, and Diderot's domestic life was irregular and unhappy. He sought consolation for chagrins at home in attachments abroad, first with a Madame Puisieux, a fifth-rate female scribbler, and then with Sophie Voland, to whom he was constant for the rest of her life. His letters to her are among the most graphic of all the pictures that we have of the daily life of the philosophic circle in Paris. An interesting contrast may be made between the Bohemianism of the famous English literary set who supped at the Turk's Head with the Tory Johnson and the Conservative Burke for their oracles, and the Bohemianism of the French set who about the same time dined once a week at the baron D'Holbach's, to listen to the wild sallies and the inspiring declamations of Diderot. For Diderot was not a great writer; he stands out as a fertile, suggestive and daring thinker, and a prodigious and most eloquent talker.

Diderot's earliest writings were of as little importance as Goldsmith's *Enquiry into the State of Politic Learning* or Burke's *Abridgement of English History*. He earned 100 crowns by translating Stanyan's *History of Greece* (1743); with two colleagues he produced a translation of James's *Dictionary of Medicine* (1746-1748) and about the same date he published a free rendering of Shaftesbury's *Inquiry Concerning Virtue and Merit* (1745), with some original notes of his own. With strange and characteristic versatility, he turned from ethical speculation to the composition of a volume of stories, the *Bijoux indiscrets* (1748), gross without liveliness, and impure without wit. In later years he repented of this shameless work, just as Boccaccio is said in the day of his grey hairs to have thought of the sprightliness of the *Decameron* with strong remorse. From tales Diderot went back to the more congenial region of philosophy. Between the morning of Good Friday and the evening of Easter Monday he wrote the *Pensées philosophiques* (1746), and he presently added to this a short complementary essay on the sufficiency of natural religion. The gist of these performances is to press the ordinary rationalistic objections to a supernatural revelation; but though Diderot did not at this time pass out into the wilderness beyond natural religion, yet there are signs that he accepted that less as a positive doctrine, resting on grounds of its own, than as a convenient point of attack against Christianity. In 1747 he wrote the *Promenade du sceptique*, a rather poor allegory—pointing first to the extravagances of Catholicism; second, to the vanity of the pleasures of that world which is the rival of the church; and third, to the desperate and unfathomable uncertainty of the philosophy which professes to be so high above both church and world.

Diderot's next piece was what first introduced him to the world as an original thinker, his famous *Lettre sur les aveugles* (1749). The immediate object of this short but pithy writing was to show the dependence of men's ideas on their five senses. It considers the case of the intellect deprived of the aid of one of the senses; and in a second piece, published afterwards, Diderot considered

the case of a similar deprivation in the deaf and dumb. The *Lettre sur les sourds et muets*, however, is substantially a digressive examination of some points in aesthetics. The philosophic significance of the two essays is in the advance they make towards the principle of Relativity. But what interested the militant philosophers of that day was an episodic application of the principle of relativity to the master-conception of God. What makes the *Lettre sur les aveugles* interesting is its presentation, in a distinct though undigested form, of the modern theory of variability, and of survival by superior adaptation. It is worth noticing, too, as an illustration of the comprehensive freedom with which Diderot felt his way round any subject that he approached, that in this theoretic essay he suggests the possibility of teaching the blind to read through the sense of touch. If the *Lettre sur les aveugles* introduced Diderot into the worshipful company of the philosophers, it also introduced him to the penalties of philosophy. His speculation was too hardy for the authorities, and he was thrown into the prison of Vincennes. Here he remained for three months; then he was released, to enter upon the gigantic undertaking of his life.

The bookseller Lebreton had applied to him with a project for the publication of a translation into French of Ephraim Chambers's *Cyclopaedia*, undertaken in the first instance by an Englishman, John Mills, and a German, Gottfried Sellius (for particulars see *ENCYCLOPAEDIA*). Diderot accepted the proposal, but in his busy and pregnant intelligence the scheme became transformed. Instead of a mere reproduction of Chambers, he persuaded the bookseller to enter upon a new work, which should collect under one roof all the active writers, all the new ideas, all the new knowledge, that were then moving the cultivated class to its depths, but still were comparatively ineffectual by reason of their dispersion. His enthusiasm infected the publishers; they collected a sufficient capital for a vaster enterprise than they had at first planned; D'Alembert was persuaded to become Diderot's colleague; the requisite permission was procured from the government; in 1750 an elaborate prospectus announced the project to a delighted public; and in 1751 the first volume was given to the world. The last of the letterpress was issued in 1765, but it was 1772 before the subscribers received the final volumes of the plates. These twenty years were to Diderot years not merely of incessant drudgery, but of harassing persecution, of sufferings from the cabals of enemies, and of injury from the desertion of friends. The ecclesiastical party detested the *Encyclopaedia*, in which they saw a rising stronghold for their philosophic enemies. By 1757 they could endure the sight no longer. The subscribers had grown from 2000 to 4000, and this was a right measure of the growth of the work in popular influence and power. To any one who turns over the pages of these redoubtable volumes now, it seems surprising that their doctrines should have stirred such portentous alarm. There is no atheism, no overt attack on any of the cardinal mysteries of the faith, no direct denunciation even of the notorious abuses of the church. Yet we feel that the atmosphere of the book may well have been displeasing to authorities who had not yet learnt to encounter the modern spirit on equal terms. The *Encyclopaedia* takes for granted the justice of religious tolerance and speculative freedom. It asserts in distinct tones the democratic doctrine that it is the common people in a nation whose lot ought to be the main concern of the nation's government. From beginning to end it is one unbroken process of exaltation of scientific knowledge on the one hand, and pacific industry on the other. All these things were odious to the old governing classes of France; their spirit was absolutist, ecclesiastical and military. Perhaps the most alarming thought of all was the current belief that the *Encyclopaedia* was the work of an organized band of conspirators against society, and that a pestilent doctrine was now made truly formidable by the confederation of its preachers into an open league. When the seventh volume appeared, it contained an article on "Geneva" written by D'Alembert. The writer contrived a panegyric on the pastors of Geneva, of which every word was a stinging reproach to the abbés and prelates of Versailles. At the same moment Helvétius's book *L'Esprit*,

appeared, and gave a still more profound and, let us add, a more reasonable shock to the ecclesiastical party. Authority could brook no more, and in 1759 the *Encyclopaedia* was formally suppressed.

The decree, however, did not arrest the continuance of the work. The connivance of the authorities at the breach of their own official orders was common in those times of distracted government. The work went on, but with its difficulties increased by the necessity of being clandestine. And a worse thing than troublesome interference by the police now befell Diderot. D'Alembert, wearied of shifts and indignities, withdrew from the enterprise. Other powerful colleagues, Turgot among them, declined to contribute further to a book which had acquired an evil fame. Diderot was left to bring the task to an end as he best could. For seven years he laboured like a slave at the oar. He wrote several hundred articles, some of them very slight, but many of them most laborious, comprehensive and ample. He wore out his eyesight in correcting proofs, and he wearied his soul in bringing the manuscript of less competent contributors into decent shape. He spent his days in the workshops, mastering the processes of manufactures, and his nights in reproducing on paper what he had learnt during the day. And he was incessantly harassed all the time by alarms of a descent from the police. At the last moment, when his immense work was just drawing to an end, he encountered one last and crowning mortification: he discovered that the bookseller, fearing the displeasure of the government, had struck out from the proof sheets, after they had left Diderot's hands, all passages that he chose to think too hardy. The monument to which Diderot had given the labour of twenty long and oppressive years was irreparably mutilated and defaced. It is calculated that the average annual salary received by Diderot for his share in the *Encyclopaedia* was about £120 sterling. "And then to think," said Voltaire, "that an army contractor makes £800 in a day!"

Although the *Encyclopaedia* was Diderot's monumental work, he is the author of a shower of dispersed pieces that sowed nearly every field of intellectual interest with new and fruitful ideas. We find no masterpiece, but only thoughts for masterpieces; no creation, but a criticism with the quality to inspire and direct creation. He wrote plays—*Le Fils naturel* (1757) and *Le Père de famille* (1758)—and they are very insipid performances in the sentimental vein. But he accompanied them by essays on dramatic poetry, including especially the *Paradoxe sur le comédien*, in which he announced the principles of a new drama,—the serious, domestic, bourgeois drama of real life, in opposition to the stilted conventions of the classic French stage. It was Diderot's lessons and example that gave a decisive bias to the dramatic taste of Lessing, whose plays, and his *Hamburgische Dramaturgie* (1768), mark so important an epoch in the history of the modern theatre. In the pictorial art, Diderot's criticisms are no-less rich, fertile and wide in their ideas. His article on "Beauty" in the *Encyclopaedia* shows that he had mastered and passed beyond the metaphysical theories on the subject, and the *Essai sur la peinture* was justly described by Goethe, who thought it worth translating, as "a magnificent work, which speaks even more helpfully to the poet than to the painter, though to the painter too it is as a blazing torch." Diderot's most intimate friend was Grimm, one of the conspicuous figures of the philosophic body. Grimm wrote news-letters to various high personages in Germany, reporting what was going on in the world of art and literature in Paris, then without a rival as the capital of the intellectual activity of Europe. Diderot helped his friend at one time and another between 1759 and 1770, by writing for him an account of the annual exhibitions of paintings. These *Salons* are among the most readable of all pieces of art criticism. They have a freshness, a reality, a life, which take their readers into a different world from the dry and conceited pedantries of the ordinary virtuoso. As has been said by Sainte-Beuve, they initiated the French into a new sentiment, and introduced people to the mystery and purport of colour by ideas. "Before Diderot," Madame Necker said, "I had never seen anything in pictures except dull and lifeless colours; it was his imagination that gave

them relief and life, and it is almost a new sense for which I am indebted to his genius."

Greuze was Diderot's favourite among contemporary artists, and it is easy to see why. Greuze's most characteristic pictures were the rendering in colour of the same sentiment of domestic virtue and the pathos of common life, which Diderot attempted with inferior success to represent upon the stage. For Diderot was above all things interested in the life of men,—not the abstract life of the race, but the incidents of individual character, the fortunes of a particular family, the relations of real and concrete motives in this or that special case. He delighted with the enthusiasm of a born casuist in curious puzzles of right and wrong, and in devising a conflict between the generalities of ethics and the conditions of an ingeniously contrived practical dilemma. Mostly his interest expressed itself in didactic and sympathetic form; in two, however, of the most remarkable of all his pieces, it is not sympathetic, but ironical. *Jacques le fataliste* (written in 1773, but not published until 1796) is in manner an imitation of *Tristram Shandy* and *The Sentimental Journey*. Few modern readers will find in it any true diversion. In spite of some excellent criticisms dispersed here and there, and in spite of one or two stories that are not without a certain effective realism, it must as a whole be pronounced savourless, forced, and as leaving unmoved those springs of laughter and of tears which are the common fountain of humour. *Le Neveu de Rameau* is a far superior performance. If there were any inevitable compulsion to name a masterpiece for Diderot, one must select this singular "farce-tragedy." Its intention has been matter of dispute; whether it was designed to be merely a satire on contemporary manners, or a reduction of the theory of self-interest to an absurdity, or the application of an ironical clincher to the ethics of ordinary convention, or a mere setting for a discussion about music, or a vigorous dramatic sketch of a parasite and a human original. There is no dispute as to its curious literary flavour, its mixed qualities of pungency, bitterness, pity and, in places, unflinching shamelessness. Goethe's translation (1805) was the first introduction of *Le Neveu de Rameau* to the European public. After executing it, he gave back the original French manuscript to Schiller, from whom he had it. No authentic French copy of it appeared until the writer had been nearly forty years in his grave (1833).

It would take several pages merely to contain the list of Diderot's miscellaneous pieces, from an infinitely graceful trifle like the *Regrets sur ma vieille robe de chambre* up to *Le Rêve de D'Alembert*, where he plunges into the depths of the controversy as to the ultimate constitution of matter and the meaning of life. It is a mistake to set down Diderot for a coherent and systematic materialist. We ought to look upon him "as a philosopher in whom all the contradictions of the time struggle with one another" (Rosenkranz). That is to say, he is critical and not dogmatic. There is no unity in Diderot, as there was in Voltaire or in Rousseau. Just as in cases of conduct he loves to make new ethical assumptions and argue them out as a professional sophist might have done, so in the speculative problems as to the organization of matter, the origin of life, the compatibility between physiological machinery and free will, he takes a certain standpoint, and follows it out more or less digressively to its consequences. He seizes a hypothesis and works it to its end, and this made him the inspirer in others of materialist doctrines which they held more definitely than he did. Just as Diderot could not attain to the concentration, the positiveness, the finality of aim needed for a masterpiece of literature, so he could not attain to those qualities in the way of dogma and system. Yet he drew at last to the conclusions of materialism, and contributed many of its most declamatory pages to the *Système de la nature* of his friend D'Holbach,—the very Bible of atheism, as some one styled it. All that he saw, if we reduce his opinions to formulae, was motion in space: "attraction and repulsion, the only truth." If matter produces life by spontaneous generation, and if man has no alternative but to obey the compulsion of nature, what remains for God to do?

In proportion as these conclusions deepened in him, the more

did Diderot turn for the hope of the race to virtue; in other words, to such a regulation of conduct and motive as shall make us tender, pitiful, simple, contented. Hence his one great literary passion, his enthusiasm for Richardson, the English novelist. Hence, also, his deepening aversion for the political system of France, which makes the realization of a natural and contented domestic life so hard. Diderot had almost as much to say against society as even Rousseau himself. The difference between them was that Rousseau was a fervent theist. The atheism of the Holbachians, as he called Diderot's group, was intolerable to him; and this feeling, aided by certain private perversities of humour, led to a breach of what had once been an intimate friendship between Rousseau and Diderot (1757). Diderot was still alive when Rousseau's *Confessions* appeared, and he was so exasperated by Rousseau's stories about Grimm, then and always Diderot's intimate, that in 1782 he transformed a life of Seneca, that he had written four years earlier, into an *Essai sur les règnes de Claude et de Néron* (1778-1782), which is much less an account of Seneca than a vindication of Diderot and Grimm, and is one of the most rambling and inept productions in literature. As for the merits of the old quarrel between Rousseau and Diderot, we may agree with the latter, that too many sensible people would be in the wrong if Jean Jacques was in the right.

Varied and incessant as was Diderot's mental activity, it was not of a kind to bring him riches. He secured none of the posts that were occasionally given to needy men of letters; he could not even obtain that bare official recognition of merit which was implied by being chosen a member of the Academy. The time came for him to provide a dower for his daughter, and he saw no other alternative than to sell his library. When the empress Catherine of Russia heard of his straits, she commissioned an agent in Paris to buy the library at a price equal to about £1000 of English money, and then handsomely requested the philosopher to retain the books in Paris until she required them, and to constitute himself her librarian, with a yearly salary. In 1773 Diderot started on an expedition to thank his imperial benefactress in person, and he passed some months at St Petersburg. The empress received him cordially. The strange pair passed their afternoons in disputes on a thousand points of high philosophy, and they debated with a vivacity and freedom not usual in courts. "Fi, donc," said Catherine one day, when Diderot hinted that he argued with her at a disadvantage, "is there any difference among men?" Diderot returned home in 1774. Ten years remained to him, and he spent them in the industrious acquisition of new knowledge, in the composition of a host of fragmentary pieces, some of them mentioned above, and in luminous declamations with his friends. All accounts agree that Diderot was seen at his best in conversation. "He who only knows Diderot in his writings," says Marmontel, "does not know him at all. When he grew animated in talk, and allowed his thoughts to flow in all their abundance, then he became truly ravishing. In his writings he had not the art of ensemble; the first operation which orders and places everything was too slow and too painful to him." Diderot himself was conscious of the want of literary merit in his pieces. In truth he set no high value on what he had done. It is doubtful whether he was ever alive to the waste that circumstance and temperament together made of an intelligence from which, if it had been free to work systematically, the world of thought had so much to hope. He was one of those simple, disinterested and intellectually sterling workers to whom their own personality is as nothing in presence of the vast subjects that engage the thoughts of their lives. He wrote what he found to write, and left the piece, as Carlyle has said, "on the waste of accident, with an ostrich-like indifference." When he heard one day that a collected edition of his works was in the press at Amsterdam, he greeted the news with "peals of laughter," so well did he know the haste and the little heed with which those works had been dashed off.

Diderot died on the 30th of July 1784, six years after Voltaire and Rousseau, one year after his old colleague D'Alembert, and five years before D'Holbach, his host and intimate for a lifetime. Notwithstanding Diderot's peals of laughter at the thought, an

elaborate and exhaustive collection of his writings in twenty stout volumes, edited by MM. Assézat and Tourneux, was completed in 1875-1877.

AUTHORITIES.—Studies on Diderot by Scherer (1880); by E. Faguet (1890); by Sainte-Beuve in the *Causeries du lundi*; by F. Brunetière in the *Études critiques*, 2nd series, and may be consulted. In English, Diderot has been the subject of a biography by John Morley [Viscount Morley of Blackburn] (1878). See also Karl Rosenkranz, *Diderot's Leben und Werke* (1866). For a discussion of the authenticity of the posthumous works of Diderot see R. Dominic in the *Revue des deux mondes* (October 15, 1902). (J. Mo.)

DIDIUS SALVIUS JULIANUS, MARCUS, Roman emperor for two months (March 28-June 2) during the year A.D. 193. He was the grandson of the famous jurist Salvius Julianus (under Hadrian and the Antonines), and the son of a distinguished general, who might have ascended the throne after the death of Antoninus Pius, had not his loyalty to the ruling house prevented him. Didius filled several civil and military offices with distinguished success, but subsequently abandoned himself to dissipation. On the death of Pertinax, the praetorian guards offered the throne to the highest bidder. Flavius Sulpicianus, the father-in-law of Pertinax and praefect of the city, had already made an offer; Didius, urged on by the members of his family, his freedmen and parasites, hurried to the praetorian camp to contend for the prize. He and Sulpicianus bid against each other, and finally the throne was knocked down to Didius. The senate and nobles professed their loyalty; but the people made no attempt to conceal their indignation at this insult to the state, and the armies of Britain, Syria and Illyricum broke out into open revolt. Septimius Severus, the commander of the Pannonian legions, was declared emperor and hastened by forced marches to Italy. Didius, abandoned by the praetorians, was condemned and executed by order of the senate, which at once acknowledged Severus.

AUTHORITIES.—Dio Cassius lxxiii. 11-17, who was actually in Rome at the time; Aelius Spartianus, *Didius Julianus*; Julius Capitolinus, *Pertinax*; Herodian ii.; Aurelius Victor, *De Caesaribus*, 19; Zosimus i. 7; Gibbon, *Decline and Fall*, chap. 5.

DIDO, or ELISSA, the reputed founder of Carthage (q.v.), in Africa, daughter of the Tyrian king Metten (Mutto, Methres, Belus), wife of Acerbas (more correctly Sicharbas; Sycharas in Virgil), a priest of Hercules. Her husband having been slain by her brother Pygmalion, Dido fled to Cyprus, and thence to the coast of Africa, where she purchased from a local chieftain Iarbas a piece of land on which she built Carthage. The city soon began to prosper and Iarbas sought Dido's hand in marriage, threatening her with war in case of refusal. To escape from him, Dido constructed a funeral pile, on which she stabbed herself before the people (Justin xviii. 4-7). Virgil, in defiance of the usually accepted chronology, makes Dido a contemporary of Aeneas, with whom she fell in love after his landing in Africa, and attributes her suicide to her abandonment by him at the command of Jupiter (*Aeneid*, iv.). Dido was worshipped at Carthage as a divinity under the name of Caelestis, the Roman counterpart of Tanit, the tutelary goddess of Carthage. According to Timaeus, the oldest authority for the story, her name was Theiosso, in Phoenician Helissa, and she was called Dido from her wanderings, Dido being the Phoenician equivalent of *πλατὴν* (*Etymologicum Magnum*, s.v.); some modern scholars, however, translate the name by "beloved." Timaeus makes no mention of Aeneas, who seems to have been introduced by Naevius in his *Bellum Poenicum*, followed by Ennius in his *Annales*.

For the variations of the legend in earlier and later Latin authors, see O. Rossbach in Pauly-Wissowa's *Realencyclopädie*, v. pt. 1 (1905); O. Meltzer's *Geschichte der Karthager*, i. (1879), and his article in Roscher's *Lexikon der Mythologie*.

DIDON, HENRI (1840-1900), French Dominican, was born at Trouvet, Isère, on the 17th of March 1840. He joined the Dominicans, under the influence of Lacordaire, in 1858, and completed his theological studies at the Minerva convent at Rome. The influence of Lacordaire was shown in the zeal displayed by Didon in favour of a reconciliation between philosophy and science. In 1871 his fame had so much grown that he was chosen to deliver the funeral oration over the murdered archbishop of Paris, Monseigneur G. Darboy. He also delivered some

discourses at the church of St Jean de Beauvais in Paris on the relations between science and religion; but his utterances, especially on the question of divorce, were deemed suspicious by his superiors, and his intimacy with Claude Bernard the physiologist was disapproved. He was interdicted from preaching and sent into retirement at the convent of Corbara in Corsica. After eighteen months he emerged, and travelled in Germany, publishing an interesting work upon that country, entitled *Les Allemands* (English translation by R. Ledos de Beaufort, London, 1884). On his return to France in 1800 he produced his best known work, *Jésus-Christ* (2 vols., Paris), for which he had qualified himself by travel in the Holy Land. In the same year he became director of the Collège Albert-le-Grand at Arcueil, and founded three auxiliary institutions, École Lacordaire, École Laplace and École St Dominique. He wrote, in addition, several works on educational questions, and augmented his fame as an eloquent preacher by discourses preached during Lent and Advent. He died at Toulouse on the 13th of March 1900.

See the biographies by J. de Romano (1891), and A. de Coulanges (Paris, 1900); and especially the work of Stanislas Reynaud, entitled *Le Père Didot, sa vie et son œuvre* (Paris, 1904).

DIDOT, the name of a family of learned French printers and publishers. **FRANÇOIS DIDOT** (1689-1757), founder of the family, was born at Paris. He began business as a bookseller and printer in 1713, and among his undertakings was a collection of the travels of his friend the Abbé Prévost, in twenty volumes (1747). It was remarkable for its typographical perfection, and was adorned with many engravings and maps. **FRANÇOIS AMBROISE DIDOT** (1730-1804), son of François, made important improvements in type-founding, and was the first to attempt printing on vellum paper. Among the works which he published was the famous collection of French classics prepared by order of Louis XVI. for the education of the Dauphin, and the folio edition of *L'Art de vérifier les dates*. **PIERRE FRANÇOIS DIDOT** (1732-1795), his brother, devoted much attention to the art of type-founding and to paper-making. Among the works which issued from his press was an edition in folio of the *Imitatio Christi* (1788). **HENRI DIDOT** (1765-1852), son of Pierre François, is celebrated for his "microscopic" editions of various standard works, for which he engraved the type when nearly seventy years of age. He was also the engraver of the *assignats* issued by the Constituent and Legislative Assemblies and the Convention. **DIDOT SAINT-LÉGER**, second son of Pierre François, was the inventor of the paper-making machine known in England as the Didot machine. **PIERRE DIDOT** (1760-1853), eldest son of François Ambroise, is celebrated as the publisher of the beautiful "Louvre" editions of Virgil, Horace and Racine. The Racine, in three volumes folio, was pronounced in 1801 to be "the most perfect typographical production of all ages." **FIRMIN DIDOT** (1764-1836), his brother, second son of François Ambroise, sustained the reputation of the family both as printer and type-founder. He revived (if he did not invent—a distinction which in order of time belongs to William Ged) the process of stereotyping, and coined its name, and he first used the process in his edition of *Callet's Tables of Logarithms* (1795), in which he secured an accuracy till then unattainable. He published stereotyped editions of French, English and Italian classics at a very low price. He was the author of two tragedies—*La Reine de Portugal* and *La Mort d'Annibal*; and he wrote metrical translations from Virgil, Tyrtæus and Theocritus. **AMBROISE FIRMIN DIDOT** (1790-1876) was his eldest son. After receiving a classical education, he spent three years in Greece and in the East; and on the retirement of his father in 1827 he undertook, in conjunction with his brother Hyacinthe, the direction of the publishing business. Their greatest undertaking was a new edition of the *Thesaurus Græcæ linguæ* of Henri Estienne, under the editorial care of the brothers Dindorf and M. Hase (9 vols., 1855-1859). Among the numerous important works published by the brothers, the 200 volumes forming the *Bibliothèque des auteurs grecs*, *Bibliothèque latine*, and *Bibliothèque française* deserve special mention. Ambroise Firmin Didot was the first to propose (1823) a subscription in favour of the Greeks, then in insurrection

against Turkish tyranny. Besides a translation of Thucydides (1833), he wrote the articles "Estienne" in the *Nouvelle Biographie générale*, and "Typographie" in the *Encyc. mod.*, as well as *Observations sur l'orthographe française* (1867), &c. In 1875 he published a very learned and elaborate monograph on Aldus Manutius. His collection of MSS., the richest in France, was said to have been worth, at the time of his death, not less than 2,000,000 francs.

DIDRON, ADOLPHE NAPOLÉON (1806-1867), French archaeologist, was born at Hautvillers, in the department of Marne, on the 13th of March 1806. At first a student of law, he began in 1830, by the advice of Victor Hugo, a study of the Christian archaeology of the middle ages. After visiting and examining the principal churches, first of Normandy, then of central and southern France, he was on his return appointed by Guizot secretary to the Historical Committee of Arts and Monuments (1835); and in the following years he delivered several courses of lectures on Christian iconography at the Bibliothèque Royale. In 1839 he visited Greece for the purpose of examining the art of the Eastern Church, both in its buildings and its manuscripts. In 1844 he originated the *Annales archéologiques*, a periodical devoted to his favourite subject, which he edited until his death. In 1845 he established at Paris a special archaeological library, and at the same time a manufactory of painted glass. In the same year he was admitted to the Legion of Honour. His most important work is the *Iconographie chrétienne*, of which, however, the first portion only, *Histoire de Dieu* (1843), was published. It was translated into English by E. J. Millington. Among his other works may be mentioned the *Manuel d'iconographie chrétienne grecque et latine* (1845), the *Iconographie des chapiteaux du palais ducal de Venise* (1857), and the *Manuel des objets de bronze et d'orfèvrerie* (1859). He died on the 13th of November 1867.

DIDYMI, or **DIDYMA** (mod. *Hieronta*), an ancient sanctuary of Apollo in Asia Minor situated in the territory of Miletus, from which it was distant about 10 m. S. and on the promontory Poseideion. It was sometimes called *Branchidae* from the name of its priestly caste which claimed descent from Branchus, a youth beloved by Apollo. As the seat of a famous oracle, the original temple attracted offerings from Pharaoh Necho (in whose army there was a contingent of Milesian mercenaries), and the Lydian Croesus, and was plundered by Darius of Persia. Xerxes finally sacked and burnt it (481 B.C.) and exiled the Branchidae to the far north-east of his empire. This exile was believed to be voluntary, the priests having betrayed their treasures to the Persian; and on this belief Alexander the Great acted 150 years later, when, finding the descendants of the Branchidae established in a city beyond the Oxus, he ordered them to be exterminated for the sin of their fathers (328). The celebrated cult-statue of Apollo by Canachus, familiar to us from reproductions on Milesian coins, was also carried to Persia, there to remain till restored by Seleucus I. in 295, and the oracle ceased to speak for a century and a half. The Milesians were not able to undertake the rebuilding till about 332 B.C., when the oracle revived at the bidding of Alexander. The work proved too costly, and despite a special effort made by the Asian province nearly 400 years later, at the bidding of the emperor Caligula, the structure was never quite finished: but even as it was, Strabo ranked the Didymeum the greatest of Greek temples and Pliny placed it among the four most splendid and second only to the Artemisium at Ephesus. In point of fact it was a little smaller than the Samian Heraeum and the temple of Cybele at Sardis, and almost exactly the same size as the Artemisium. The area covered by the platform measures roughly 360×160 ft.

When Cyriac of Ancona visited the spot in 1446, it seems that the temple was still standing in great part, although the *cella* had been converted into a fortress by the Byzantines: but when the next European visitor, the Englishman Dr Pickering, arrived in 1673, it had collapsed. It is conjectured that the cause was the great earthquake of 1493. The Society of Dilettanti sent two expeditions to explore the ruins, the first in 1764 under Richard Chandler, the second in 1812 under Sir Wm. Gell; and the French

"Rothschild Expedition" of 1873 under MM. O. Rayet and A. Thomas sent a certain amount of architectural sculpture to the Louvre. But no excavation was attempted till MM. E. Pontremoli and B. Haussoullier were sent out by the French Schools of Rome and Athens in 1895. They cleared the western façade and the *prodromos*, and discovered inscriptions giving information about other parts which they left right buried. Finally the site was purchased by, and the French rights were ceded to, Dr Th. Wiegand, the German explorer of Miletus, who in 1905 began a thorough clearance of what is incomparably the finest temple ruin in Asia Minor.

The temple was a decastyle peripteral structure of the Ionic order, standing on seven steps and possessing double rows of outer columns 60 ft. high, twenty-one in each row on the flanks. It is remarkable not only for its great size, but (*inter alia*) for (1) the rich ornament of its column bases, which show great variety of design; (2) its various developments of the Ionic capital, e.g. heads of gods, probably of Pergamene art, spring from the "eyes" of the volutes with bulls' heads between them; (3) the massive building two storeys high at least, which served below for *prodromos*, and above for a dispensary of oracles (*χρησμογράφια* mentioned in the inscriptions) and a treasury; two flights of stairs called "labyrinths" in the inscriptions, led up to these chambers; (4) the pylon and staircase at the west; (5) the frieze of Medusa heads and foliage. Two outer columns are still erect on the north-east flank, carrying their entablature, and one of the inner order stands on the south-west. The fact that the temple was never finished is evident from the state in which some bases still remain at the west. There were probably no pedimental sculptures. A sacred way led from the temple to the sea at Panormus, which was flanked with rows of archaic statues, ten of which were excavated and sent to the British Museum in 1858 by C. T. Newton. Fragments of architectural monuments, which once adorned this road, have also been found. Modern Hieronta is a large and growing Greek village, the only settlement within a radius of several miles. Its harbour is Kovella, distant about 2½ m., and on the N. of the promontory.

See Dilettanti Society, *Ionian Antiquities*, ii. (1821); C. T. Newton, *Hist. of Discoveries, &c.* (1862) and *Travels in the Levant*, ii. (1865); O. Rayet and A. Thomas, *Milet et le Golfe Latmique* (1877); E. Pontremoli and B. Haussoullier, *Didymos* (1904). (D. G. H.)

DIDYMIUM (from the Gr. *δίδυμος*, twin), the name given to the supposed element isolated by C. G. Mosander in cerite (1839-1841). In 1879, however, Lecoq de Boisbaudran showed that Mosander's "didymium" contained samarium; while the residual "didymium," after removal of samarium, was split by Auer v. Welsbach (*Monats. f. Chemie*, 1885, 6, 477) into two components (known respectively as neodymium and praseodymium) by repeated fractional crystallization of the double nitrate of ammonium and didymium in nitric acid. Neodymium (Nd) forms the chief portion of the old "didymium." Its salts are reddish violet in colour, and give a characteristic absorption spectrum. It forms oxides of composition Nd₂O₃ and Nd₄O₇, the latter being obtained by ignition of the nitrate (B. Brauner). The atomic weight of neodymium is 143.6 (B. Brauner, *Proc. Chem. Soc.*, 1897-1898, p. 70). Praseodymium (Pr) forms oxides of composition Pr₂O₃, Pr₄O₇, and Hf₂O₇ (B. Brauner), and Pr₂O₅. The peroxide, Pr₂O₇, forms a dark brown powder, and is obtained by ignition of the oxalate or nitrate. The sesquioxide, Pr₂O₃, is obtained as a greenish white mass by the reduction of the peroxide. The salts of praseodymium are green in colour, and give a characteristic spark spectrum. The atomic weight of praseodymium is 140.5.

DIDYMUS (?309-?394), surnamed "the Blind," ecclesiastical writer of Alexandria, was born about the year 309. Although he became blind at the age of four, before he had learned to read; he succeeded in mastering the whole circle of the sciences then known; and on entering the service of the Church he was placed at the head of the Catechetical school in Alexandria, where he lived and worked till almost the close of the century. Among his pupils were Jerome and Rufinus. He was a loyal follower of

Origen, though stoutly opposed to Arian and Macedonian teaching. Such of his writings as survive show a remarkable knowledge of scripture, and have distinct value as theological literature. Among them are the *De Trinitate*, *De Spiritu Sancto* (Jerome's Latin translation), *Adversus Manichaeos*, and notes and expositions of various books, especially the Psalms and the Catholic Epistles.

See Migne, *Patrol. Graec.* xxxix.; O. Bardenhewer, *Patrologie*, pp. 290-293 (Freiburg, 1894).

DIDYMUS CHALCENTERUS (c. 63 B.C.—A.D. 10), Greek scholar and grammarian, flourished in the time of Cicero and Augustus. His surname (Gr. *Χαλκέντερος*, brazen-bowelled) came from his indefatigable industry; he was said to have written so many books (more than 3500) that he was unable to recollect their names (*βιβλιολόγος*). He lived and taught in Alexandria and Rome, where he became the friend of Varro. He is chiefly important as having introduced Alexandrian learning to the Romans. He was a follower of the school of Aristarchus, upon whose recension of Homer he wrote a treatise, fragments of which have been preserved in the Venetian Scholia. He also wrote commentaries on many other Greek poets and prose authors. In his work on the lyric poets he treated of the various classes of poetry and their chief representatives, and his lists of words and phrases (used in tragedy and comedy and by orators and historians), of words of doubtful meaning, and of corrupt expressions, furnished the later grammarians with valuable material. His activity extended to all kinds of subjects: grammar (orthography, inflexions), proverbs, wonderful stories, the law-tablets (*δίκαια*) of Solon, stones, and different kinds of wood. His polemic against Cicero's *De republica* (Ammianus Marcellinus xxii. 16) provoked a reply from Suetonius. In spite of his stupendous industry, Didymus was little more than a compiler, of little critical judgment and doubtful accuracy, but he deserves recognition for having incorporated in his numerous writings the works of earlier critics and commentators.

See M. W. Schmidt, *De Didymo Chalcentero* (1853) and *Didymi Chalcenteri fragmenta* (1854); also F. Susenmilh, *Geschichte der griech. Literatur in der Alexandrinerzeit*, ii. (1891); J. E. Sandys, *History of Classical Scholarship*, i. (1906).

DIE, a town of south-eastern France, capital of an arrondissement in the department of Drôme, 43 m. E.S.E. of Valence on the Paris-Lyon railway. Pop. (1906) 3090. The town is situated in a plain enclosed by mountains on the right bank of the Drôme below its confluence with the Meyrosse, which supplies power to some of the industries. The most interesting structures of Die are the old cathedral, with a porch of the 11th century supported on granite columns from an ancient temple of Cybele; and the Porte St Marcel, a Roman gateway flanked by massive towers. The Roman remains also include the ruins of aqueducts and altars. Die is the seat of a sub-prefect, and of a tribunal of first instance. The manufactures are silk, furniture, cloth, lime and cement, and there are flour and saw mills. Trade is in timber, especially walnut, and in white wine known as *clairette de Die*. The mulberry is largely grown for the rearing of silkworms. Under the Romans, Die (*Dea Augusta Vocontiorum*) was an important colony. It was formerly the seat of a bishopric, united to that of Valence from 1276 to 1687 and suppressed in 1790. Previous to the revocation of the edict of Nantes in 1685 it had a Calvinistic university.

DIE (Fr. *dé*, from Lat. *datum*, given), a word used in various senses, for a small cube of ivory, &c. (see DICE), for the engraved stamps used in coining money, &c., and various mechanical appliances in engineering. In architecture a "die" is the term used for the square base of a column, and it is applied also to the vertical face of a pedestal or podium.

The fabrics known as "dice" take their name from the rectangular form of the figure. The original figures would probably be perfectly square, but to-day the same principle of weaving is applied, and the name dice is given to all figures of rectangular form. The different effects in the adjacent squares or rectangles are due to precisely the same reasons as those explained in connexion with the ground and the figure of damasks. The same weaves are used in both damasks and dices, but simpler

weaves are generally employed for the commoner classes of the latter. The effect is, in every case, obtained by what are technically called warp and weft float weaves.

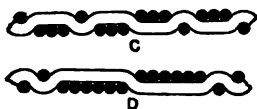
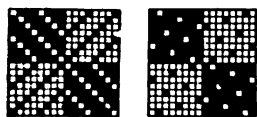

The illustration B shows the two double damask weaves arranged to form a dice pattern, while A shows a similar pattern made from two four-thread twill weaves. C and D represent respectively the disposition of the threads in A and B with the first pick, and the solid marks represent the floats of warp. The four squares, which are almost as pronounced in the cloth as those of a chess-board, may be made of any size by repeating each weave for the amount

of surface required. It is only in the finest cloths that the double damask weaves B are used for dice patterns, the single damask weaves and the twill weaves being employed to a greater extent. This class of pattern is largely employed for the production of table-cloths of lower and medium qualities. The term damask is also often applied to cloths of this character, and especially so when the figure is formed by rectangles of different sizes.

DIEBITSCH, HANS KARL FRIEDRICH ANTON, count von Diebitch and Narden, called by the Russians Ivan Ivanovich, Count Diebich-Zabalkanski (1785-1831), Russian field-marshal, was born in Silesia on the 13th of May 1785. He was educated at the Berlin cadet school, but by the desire of his father, a Prussian officer who had passed into the service of Russia, he also did the same in 1801. He served in the campaign of 1805, and was wounded at Austerlitz, fought at Eylau and Friedland, and after Friedland was promoted captain. During the next five years of peace he devoted himself to the study of military science, engaging once more in active service in the War of 1812. He distinguished himself very greatly in Wittgenstein's campaign, and in particular at Polotzk (October 18 and 19), after which combat he was raised to the rank of major-general. In the latter part of the campaign he served against the Prussian contingent of General Yorck (von Wartenburg), with whom, through Clausewitz, he negotiated the celebrated convention of Taurroggen, serving thereafter with Yorck in the early part of the War of Liberation. After the battle of Lützen he served in Silesia and took part in negotiating the secret treaty of Reichenbach. Having distinguished himself at the battles of Dresden and Leipzig he was promoted lieutenant-general. At the crisis of the campaign of 1814 he strongly urged the march of the allies on Paris; and after their entry the emperor Alexander conferred on him the order of St Alexander Nevsky. In 1815 he attended the congress of Vienna, and was afterwards made adjutant-general to the emperor, with whom, as also with his successor Nicholas, he had great influence. By Nicholas he was created baron, and later count. In 1820 he had become chief of the general staff, and in 1825 he assisted in suppressing the St Petersburg *émigré*. His greatest exploits were in the Russo-Turkish War of 1828-1829, which, after a period of doubtful contest, was decided by Diebitsch's brilliant campaign of Adrianople; this won him the rank of field-marshal and the honorary title of Zabalkanski to commemorate his crossing of the Balkans. In 1830 he was appointed to command the great army destined to suppress the insurrection in Poland. He won the terrible battle of Gróchow on the 25th of February, and was again victorious at Ostrolenka on the 26th of May, but soon afterwards he died of cholera (or by his own hand) at Klecksewo near Pultusk, on the 10th of June 1831.

See Belmont (Schlümberg), *Graf Diebitsch* (Dresden, 1830); Schärer, *Der Tod des Grafen Diebitsch* (Berlin, 1832); Bantych-Kamenskii, *Biographies of Russian Field-M Marshals* (in Russian, St Petersburg, 1841).

DIEDENHOFEN (Fr. *Thionsville*), a fortified town of Germany, in Alsace-Lorraine, dist. Lorraine, on the Mosel, 22 m. N. from Metz by rail. Pop. (1905) 6047. It is a railway junction of

some consequence, with cultivation of vines, fruit and vegetables, brewing, tanning, &c. Diedenhofen is an ancient Frank town (Theudonevilla, Totonisvilla), in which imperial diets were held in the 8th century; was captured by Condé in 1643 and fortified by Vauban; capitulated to the Prussians, after a severe bombardment, on the 25th of November 1870.

DIEKIRCH, a small town in the grand duchy of Luxemburg, charmingly situated on the banks of the Sûre. Pop. (1905) 3705. Its name is said to be derived from Dide or Dido, granddaughter of Odin and niece of Thor. The mountain at the foot of which the town lies, now called Herrenberg, was formerly known as Thorenberg, or Thor's mountain. On the summit of this rock rises a perennial stream which flows down into the town under the name of Bellenflesschen. Diekirch was an important Roman station, and in the 14th century John of Luxemburg, the blind king of Bohemia, fortified it, surrounding the place with a castellated wall and a ditch supplied by the stream mentioned. It remained more or less fortified until the beginning of the 19th century when the French during their occupation levelled the old walls, and substituted the avenues of trees that now encircle the town. Diekirch is the administrative centre of one of the three provincial divisions of the grand duchy. It is visited during the summer by many thousand tourists and travellers from Holland, Belgium and Germany.

DIELECTRIC, in electricity, a non-conductor of electricity; it is the same as insulator. The "dielectric constant" of a medium is its specific inductive capacity, and on the electromagnetic theory of light it equals the square of its refractive index for light of infinite wavelength (see ELECTROSTATICS; MAGNETO-OPTICS).

DIELMANN, FREDERICK (1847-), American portrait and figure painter, was born at Hanover, Germany, on the 25th of December 1847. He was taken to the United States in early childhood; studied under Diez at the Royal Academy at Munich; was first an illustrator, and became a distinguished draughtsman and painter of genre pictures. His mural decorations and mosaic panels for the Congressional library, Washington, are notable. He was elected in 1899 president of the National Academy of Design.

DIEMEN, ANTHONY VAN (1593-1645), Dutch admiral and governor-general of the East Indian settlements, was born at Kulenburg in 1593. He was educated in commerce, and on entering the service of the East India Company speedily attained high rank. In 1631 he led a Dutch fleet from the Indies to Holland, and in 1636 he was raised to the governor-generalship. He came into conflict with the Portuguese, and took their possessions in Ceylon and Malacca from them. He greatly extended the commercial relationships of the Dutch, opening up trade with Tong-king, China and Japan. As an administrator also he showed ability, and the foundation of a Latin school and several churches in Batavia is to be ascribed to him. Exploring expeditions were sent to Australia under his auspices in 1636 and 1642, and Abel Tasman named after him (Van Diemen's Land) the island now called Tasmania. Van Diemen died at Batavia on the 19th of April 1645.

DIEPENBECK, ABRAHAM VAN (1599-1675), Flemish painter, was born at Herzogenbusch, and studied painting at Antwerp, where he became one of Rubens's "hundred pupils." But he was not one of the cleverest of Rubens's followers, and he succeeded, at the best, in imitating the style and aping the peculiarities of his master. We see this in his earliest pictures—a portrait dated 1629 in the Munich Pinakothek, and a "Distribution of Alms" of the same period in the same collection. Yet even at this time there were moments when Diepenbeck probably fancied that he might take another path. A solitary copperplate executed with his own hand in 1630 represents a peasant sitting under a tree holding the bridle of an ass, and this is a minute and finished specimen of the engraver's art which shows that the master might at one time have hoped to rival the animal draughtsmen who flourished in the schools of Holland. However, large commissions now poured in upon him; he was asked for altarpieces, subject-pieces and pagan allegories. He was tempted to try the profession of a glass-painter, and at last he gave up every

other occupation for the lucrative business of a draughtsman and designer for engravings. Most of Diepenbeck's important canvases are in continental galleries. The best are the "Marriage of St Catherine" at Berlin and "Mary with Angels Weeping over the Dead Body of Christ" in the Belvedere at Vienna, the first a very fair specimen of the artist's skill, the second a picture of more energy and feeling than might be expected from one who knew more of the outer form than of the spirit of Rubens. Then we have the fine "Entombment" at Brunswick, and "St Francis Adoring the Sacrament" at the museum at Brussels, "Cecilia and her Nymphs Flying from the Presence and Pursuit of Porsenna" in two examples at Berlin and Paris, and "Neptune and Amphitrite" at Dresden. In all these compositions the drawing and execution are after the fashion of Rubens, though inferior to Rubens in harmony of tone and force of contrasted light and shade. Occasionally a tendency may be observed to imitate the style of Vandyck, for whom, in respect of pictures, Diepenbeck in his lifetime was frequently taken. But Diepenbeck spent much less of his leisure on canvases than on glass-painting. Though he failed to master the secrets of gorgeous tinting, which were lost, apparently for ever in the 16th century, he was constantly employed during the best years of his life in that branch of his profession. In 1635 he finished forty scenes from the life of St Francis of Paula in the church of the Minimés at Antwerp. In 1644 he received payment for four windows in St Jacques of Antwerp, two of which are still preserved, and represent Virgins to whom Christ appears after the Resurrection. The windows ascribed to him at St Gudule of Brussels were executed from the cartoons of Theodore van Thulden. On the occasion of his matriculation at Antwerp in 1638-1639, Diepenbeck was registered in the guild of St Luke as a glass-painter. He resigned his membership in the Artist Club of the Violette in 1542, apparently because he felt hurt by a valuation then made of drawings furnished for copperplates to the engraver Pieter de Jode. The earliest record of his residence at Antwerp is that of his election to the brotherhood (Sodalität) "of the Bachelors" in 1634. It is probable that before this time he had visited Rome and London, as noted in the work of Houbraken. In 1636 he was made a burgher of Antwerp. He married twice, in 1637 and 1652. He died in December 1675, and was buried at St Jacques of Antwerp.

DIEPPE, a seaport of northern France, capital of an arrondissement in the department of Seine-Inférieure, on the English Channel, 38 m. N. of Rouen, and 105 m. N.W. of Paris by the Western railway. Pop. (1906) 22,120. It is situated at the mouth of the river Arques in a valley bordered on each side by steep white cliffs. The main part of the town lies to the west, and the fishing suburb of Le Pollet to the east of the river and harbour. The sea-front of Dieppe, which in summer attracts large numbers of visitors, consists of a pebbly beach backed by a handsome marine promenade. Dieppe has a modern aspect; its streets are wide and its houses, in most cases, are built of brick. Two squares side by side and immediately to the west of the outer harbour form the nucleus of the town, the Place Nationale, overlooked by the statue of Admiral A. Duquesne, and the Place St Jacques, named after the beautiful Gothic church which stands in its centre. The Grande Rue, the busiest and handsomest street, leads westward from the Place Nationale. The church of St Jacques was founded in the 13th century, but consists in large measure of later workmanship and was in some portions restored in the 19th century. The castle, overlooking the beach from the summit of the western cliff, was erected in 1435. The church of Notre-Dame de Bon Secours on the opposite cliff, and the church of St Remy, of the 16th and 17th centuries, are other noteworthy buildings. A well-equipped casino stands at the west end of the sea-front. The public institutions include the sub-prefecture, tribunals of first instance and commerce, a chamber of commerce, a communal college and a school of navigation.

Dieppe has one of the safest and deepest harbours on the English Channel. A curved passage cut in the bed of the Arques and protected by an eastern and a western jetty gives access to the outer harbour, which communicates at the east end by a lock-gate with the Bassin Duquesne and the Bassin Bérigny, and at

the west end by the New Channel, with an inner tidal harbour and two other basins. Vessels drawing 20 ft. can enter the new docks at neap tide. A dry-dock and a gridiron are included among the repairing facilities of the port. The harbour railway station is on the north-west quay of the outer harbour alongside which the steamers from Newhaven lie. The distance of Dieppe from Newhaven, with which there has long been daily communication, is 64 m. The imports include silk and cotton goods, thread, oil seeds, timber, coal and mineral oil; leading exports are wine, silk, woollen and cotton fabrics, vegetables and fruit and flint-pebbles. The average annual value of imports for the five years 1901-1905 was £4,916,000 (£4,301,000 for the years 1896-1900); the exports were valued at £9,206,000 (£7,023,000 for years 1896-1900). The industries comprise shipbuilding, cotton-spinning, steam-sawing, the manufacture of machinery, porcelain, briquettes, lace, and articles in ivory and bone, the production of which dates from the 15th century. There is also a tobacco factory of some importance. The fishermen of Le Pollet, to whom tradition ascribes a Venetian origin, are among the main providers of the Parisian market. The sea-bathing attracts many visitors in the summer. Two miles to the north-east of the town is the ancient camp known as the Cité de Limes, which perhaps furnished the nucleus of the population of Dieppe.

It is suggested on the authority of its name, that Dieppe owed its origin to a band of Norman adventurers, who found its "diep" or inlet suitable for their ships, but it was unimportant till the latter half of the 12th century. Its first castle was probably built in 1188 by Henry II. of England, and it was counted a place of some consideration when Philip Augustus attacked it in 1195. By Richard I. of England it was bestowed in 1197 on the archbishop of Rouen in return for certain territory in the neighbourhood of the episcopal city. In 1339 it was plundered by the English, but it soon recovered from the blow, and in spite of the opposition of the lords of Hantot managed to surround itself with fortifications. Its commercial activity was already great, and it is believed that its seamen visited the coast of Guinea in 1339, and founded there a Petit Dieppe in 1365. The town was occupied by the English from 1420 to 1435. A siege undertaken in 1442 by John Talbot, first earl of Shrewsbury, was raised by the dauphin, afterwards Louis XI., and the day of the deliverance continued for centuries to be celebrated by a great procession and miracle plays. In the beginning of the 16th century Jean Parmentier, a native of the town, made voyages to Brazil and Sumatra; and a little later his merchant prince, Jacques Ango, was able to blockade the Portuguese fleet in the Tagus. Francis I. began improvements which were continued under his successor. Its inhabitants in great number embraced the reformed religion; and they were among the first to acknowledge Henry IV., who fought one of his great battles at the neighbouring village of Arques. Few of the cities of France suffered more from the revocation of the edict of Nantes in 1685; and this blow was followed in 1694 by a terrible bombardment on the part of the English and Dutch. The town was rebuilt after the peace of Ryswick, but the decrease of its population and the deterioration of its port prevented the restoration of its commercial prosperity. During the 19th century it made rapid advances, partly owing to Marie Caroline, duchess of Berry, who brought it into fashion as a watering-place; and also because the establishment of railway communication with Paris gave an impetus to its trade. During the Franco-German War the town was occupied by the Germans from December 1870 till July 1871.

See L. Vitet, *Histoire de Dieppe* (Paris, 1844); D. Asseline, *Les Antiquités et chroniques de la ville de Dieppe*, a 17th-century account published at Paris in 1874.

DIERX, LÉON (1838-), French poet, was born in the island of Réunion in 1838. He came to Paris to study at the Central School of Arts and Manufactures, and subsequently settled there, taking up a post in the education office. He became a disciple of Leconte de Lisle and one of the most distinguished of the Parnassians. In the death of Stéphane Mallarmé in 1898 he was acclaimed "prince of poets" by "les jeunes." His works include: *Poèmes et poésies* (1864);

Lèvres closes (1867); *Paroles d'un vaincu* (1871); *La Rencontre*, a dramatic scene (1875) and *Les Amants* (1879): His *Poésies complètes* (1872) were crowned by the French Academy. A complete edition of his works was published in 2 vols., 1894-1896.

DIES, CHRISTOPH ALBERT (1755-1822), German painter, was born at Hanover, and learned the rudiments of art in his native place. For one year he studied in the academy of Düsseldorf, and then he started at the age of twenty with thirty ducats in his pocket for Rome. There he lived a frugal life till 1796. Copying pictures, chiefly by Salvator Rosa, for a livelihood, his taste led him to draw and paint from nature in Tivoli, Albano and other picturesque places in the vicinity of Rome. Naples, the birthplace of his favourite master, he visited more than once for the same reasons. In this way he became a bold executant in water-colours and in oil, though he failed to acquire any originality of his own. Lord Bristol, who encouraged him as a copyist, predicted that he would be a second Salvator Rosa. But Dies was not of the wood which makes original artists. Besides other disqualifications, he had necessities which forced him to give up the great career of an independent painter. David, then composing his *Horatii* at Rome, wished to take him to Paris. But Dies had reasons for not accepting the offer. He was courting a young Roman whom he subsequently married. Meanwhile he had made the acquaintance of Volpato, for whom he executed numerous drawings, and this no doubt suggested the plan, which he afterwards carried out, of publishing, in partnership with Méchan, Reinhardt and Frauenholz, the series of plates known as the *Collection de vues pittoresques de l'Italie*, published in seventy-two sheets at Nuremberg in 1799. With so many irons in the fire Dies naturally lost the power of concentration. Other causes combined to affect his talent. In 1787 he swallowed by mistake three-quarters of an ounce of sugar of lead. His recovery from this poison was slow and incomplete. He settled at Vienna, and lived there on the produce of his brush as a landscape painter, and on that of his pencil or graver as a draughtsman and etcher. But instead of getting better, his condition became worse, and he even lost the use of one of his hands. In this condition he turned from painting to music, and spent his leisure hours in the pleasures of authorship. He did not long survive, dying at Vienna in 1822, after long years of chronic suffering. From two pictures now in the Belvedere gallery, and from numerous engraved drawings from the neighbourhood of Tivoli, we gather that Dies was never destined to rise above a respectable mediocrity. He followed Salvator Rosa's example in imitating the manner of Claude Lorraine. But Salvator adapted the style of Claude, whilst Dies did no more than copy it.

DIEST, a small town in the province of Brabant, Belgium, situated on the Demer at its junction with the Bever. Pop. (1904) 8383. It lies about half-way between Hasselt and Louvain, and is still one of the five fortified places in Belgium. It contains many breweries, and is famous for the excellence of its beer.

DIESTERWEG, FRIEDRICH ADOLF WILHELM (1790-1866), German educationist, was born at Siegen on the 29th of October 1790. Educated at Herborn and Tübingen universities, he took to the profession of teaching in 1811. In 1820 he was appointed director of the new school at Mörs, where he put in practice the methods of Pestalozzi. In 1832 he was summoned to Berlin to direct the new state-schools seminary in that city. Here he proved himself a strong supporter of unsectarian religious teaching. In 1846 he established the Pestalozzi institution at Pankow, and the Pestalozzi societies for the support of teachers' widows and orphans. In 1850 he retired on a pension, but continued vigorously to advocate his educational views. In 1858 he was elected to the chamber of deputies as member for the city of Berlin, and voted with the Liberal opposition. He died in Berlin on the 7th of July 1866. Diesterweg was a voluminous writer on educational subjects, and was the author of various school text-books.

DIET, a term used in two senses, (1) food or the regulation of feeding (see **DIETARY** and **DIETETICS**), (2) an assembly or council (*Fr. diète; It. dieta; Low Lat. diaeta; Ger. Tag*).

We are here concerned only with this second sense. In modern usage, though in Scotland the term is still sometimes applied to any assembly or session, it is practically confined to the sense of an assembly of estates or of national or federal representatives. The origin of the word in this connotation is somewhat complicated. It is undoubtedly ultimately derived from the Greek *diata* (Lat. *dieta*), which meant "mode of life" and thence "prescribed mode of life," the English "diet" or "regimen." This was connected with the verb *diastân*, in the sense of "to rule," "to regulate"; compare the office of *diastrophês* at Athens, and *dietales*, "umpire," in Late Latin. In both Greek and Latin, too, the word meant "a room," from which the transition to "a place of assembly" and so to "an assembly" would be easy. In the latter sense the word, however, actually occurs only in Low Latin, Du Cange (*Glossarium, s.v.*) deriving it from the late sense of "meal" or "feast," the Germans being accustomed to combine their political assemblies with feasting. It is clear, too, that the word *dieta* early became confused with Lat. *diēs*, "day" (*Ger. Tag*), "especially a set day, a day appointed for public business; whence, by extension, meeting for business, an assembly" (Skeat). Instances of this confusion are given by Du Cange, e.g. *dieta* for *dieta*, "a day's journey" (also an obsolete sense of "diet" in English), and *dieta* for "the ordinary course of the church," i.e. "the daily office," which suggests the original sense of *dieta* as "a prescribed mode of life."

The word "diet" is now used in English for the *Reichstag*, "imperial diet" of the old Holy Roman Empire; for the *Bundestag*, "federal diet," of the former Germanic confederation; sometimes for the *Reichstag* of the modern German empire; for the *Landtag*, "territorial diets" of the constituent states of the German and Austrian empires; as well as for the former or existing federal or national assemblies of Switzerland, Hungary, Poland, &c. Although, however, the word is still sometimes used of all the above, the tendency is to confine it, so far as contemporary assemblies are concerned, to those of subordinate importance. Thus "parliament" is often used of the German *Reichstag* or of the Russian Landtag, while the *Landtag*, e.g. of Styria, would always be rendered "diet." In what follows we confine ourselves to the diet of the Holy Roman Empire and its relation to its successors in modern Germany.

The origin of the diet, or deliberative assembly, of the Holy Roman Empire must be sought in the *placitum* of the Frankish empire. This represented the tribal assembly of the Franks, meeting (originally in March, but after 755 in May, whence it is called the *Campus Martii*) partly for a military review on the eve of the summer campaign, partly for deliberation on important matters of politics and justice. By the side of this larger assembly, however, which contained in theory, if not in practice, the whole body of Franks available for war, there had developed, even before Carolingian times, a smaller body composed of the magnates of the Empire, both lay and ecclesiastical. The germ of this smaller body is to be found in the episcopal synods, which, enforced by the attendance of lay magnates, came to be used by the king for the settlement of national affairs. Under the Carolingians it was usual to combine the assembly of magnates with the *generalis conventus* of the "field of May," and it was in this inner assembly, rather than in the general body (whose approval was merely formal, and confined to matters momentous enough to be referred to a general vote), that the centre of power really lay. It is from the assembly of magnates that the diet of medieval Germany springs. The general assembly became meaningless and unnecessary, as the feudal army gradually superseded the old levy *en masse*, in which each freeman had been liable to service; and after the close of the 10th century it no longer existed.

The imperial diet (*Reichstag*) of the middle ages might sometimes contain representatives of Italy, the *regnum Italicum*; but it was practically always confined to the magnates of Germany, the *regnum Teutonicum*. Upon occasion a summons to the diet might be sent even to the knights, but the regular members were the princes (*Fürsten*), both lay and ecclesiastical. In the 13th

century the seven electors began to disengage themselves from the prince as a separate element, and the Golden Bull (1356) made their separation complete; from the 14th century onwards the nobles (both counts and other lords) are regarded as regular members; while after 1250 the imperial and episcopal towns (often appear through their representatives. By the 14th century, therefore, the originally homogeneous diet of princes is already, at any rate practically if not yet in legal form, divided into three colleges—the electors, the princes and nobles, and the representatives of the towns (though, as we shall see, the latter can hardly be reckoned as regular members until the century of the Reformation). Under the Hohenstaufen it is still the rule that every member of the diet must attend personally, or lose his vote; at a later date the principle of representation by proxy, which eventually made the diet into a mere congress of envoys, was introduced. By the end of the 13th century the vote of the majority had come to be regarded as decisive; but in accordance with the strong sense of social distinctions which marks German history, the quality as well as the quantity of votes was weighed, and if the most powerful of the princes were agreed, the opinion of the lesser magnates was not consulted. The powers of the medieval diet extended to matters like legislation, the decision upon expeditions (especially the *expeditio Romana*), taxation and changes in the constitution of the principalities or the Empire. The election of the king, which was originally regarded as one of the powers of the diet, had passed to the electors by the middle of the 13th century.

A new era in the history of the diet begins with the Reformation. The division of the diet into three colleges becomes definite and precise; the right of the electors, for instance, to constitute a separate college is explicitly recognized as a matter of established custom in 1544. The representatives of the towns now become regular members. In the 15th century they had only attended when special business, such as imperial reform or taxation, fell under discussion; in 1500, however, they were recognized as a separate and regular estate, though it was not until 1648 that they were recognized as equal to the other estates of the diet. The estate of the towns, or college of municipal representatives, was divided into two benches, the Rhenish and the Swabian. The estate of the princes and counts, which stood midway between the electors and the towns, also attained, in the years that followed the Reformation, its final organization. The vote of the great princes ceased to be personal, and began to be territorial. This had two results. The division of a single territory among the different sons of a family no longer, as of old, multiplied the voting power of the family; while in the opposite case, the union of various territories in the hands of a single person no longer meant the extinction of several votes, since the new owner was now allowed to give a vote for each of his territories. The position of the counts and other lords, who joined with the princes in forming the middle estate, was finally fixed by the middle of the 17th century. While each of the princes enjoyed an individual vote, the counts and other lords were arranged in groups, each of which voted as a whole, though the whole of its vote (*Kuriatstimme*) only counted as equal to the vote of a single prince (*Virilstimme*). There were six of these groups; but as the votes of the whole college of princes and counts (at any rate in the 18th century) numbered 100, they could exercise but little weight.

The last era in the history of the diet may be said to open with the treaty of Westphalia (1648). The treaty acknowledged that Germany was no longer a unitary state, but a loose confederation of sovereign princes; and the diet accordingly ceased to bear the character of a national assembly, and became a mere congress of envoys. The "last diet" which issued a regular recess (*Reichsabschied*—the term applied to the acts of the diet, as formally compiled and enunciated at its dissolution) was that of Regensburg in 1654. The next diet, which met at Regensburg in 1663, never issued a recess, and was never dissolved; it continued in permanent session, as it were, till the dissolution of the Empire in 1806. This result was achieved by the process of turning the diet from an assembly of principals into a congress of envoys.

The emperor was represented by two *commissarii*; the electors, princes and towns were similarly represented by their accredited agents. Some legislation was occasionally done by this body; a *conclusum imperii* (so called in distinction from the old *recessus imperii* of the period before 1663) might slowly (very slowly—for the agents, imperfectly instructed, had constantly to refer matters back to their principals) be achieved; but it rested with the various princes to promulgate and enforce the *conclusum* in their territories, and they were sufficiently occupied in issuing and enforcing their own decrees. In practice the diet had nothing to do; and its members occupied themselves in "wrangling about chairs"—that is to say, in unending disputes about degrees and precedences.

In the Germanic Confederation, which occupies the interval between the death of the Holy Roman Empire and the formation of the North German Confederation (1815-1866), a diet (*Bundesstag*) existed, which was modelled on the old diet of the 18th century. It was a standing congress of envoys at Frankfurt-on-Main. Austria presided in the diet, which, in the earlier years of its history, served, under the influence of Metternich, as an organ for the suppression of Liberal opinion. In the North German Confederation (1867-1870) a new departure was made, which has been followed in the constitution of the present German empire. Two bodies were instituted—a *Bundesrat*, which resembles the old diet in being a congress of envoys sent by the sovereigns of the different states of the confederation, and a *Reichstag*, which bears the name of the old diet, but differs entirely in composition. The new Reichstag is a popular representative assembly, based on wide suffrage and elected by ballot; and, above all, it is an assembly representing, not the several states, but the whole Empire, which is divided for this purpose into electoral districts. Both as a popular assembly, and as an assembly which represents the whole of a united Germany, the new Reichstag goes back, one may almost say, beyond the diet even of the middle ages, to the days of the old Teutonic folk-moot.

See R. Schröder, *Lehrbuch der deutschen Rechtsgeschichte* (1902), pp. 149, 508, 820, 880. Schröder gives a bibliography of monographs bearing on the history of the medieval diet. (E. Br.)

DIETARY, in a general sense, a system or course of diet, in the sense of food; more particularly, such an allowance and regulation of food as that supplied to workhouses, the army and navy, prisons, &c. Lowest in the scale of such dietaries comes what is termed "bare existence" diet, administered to certain classes of the community who have a claim on their fellow-countrymen that their lives and health shall be preserved *in statu quo*, but nothing further. This applies particularly to the members of a temporarily famine-stricken community. Before the days of prison reform, too, the dietary scale of many prisons was to a certain extent penal, in that the food supplied to prisoners was barely sufficient for existence. Nowadays more humane principles apply; there is no longer the obvious injustice of applying the same scale of quantity and quality to all prisoners under varying circumstances of constitution and surroundings, and whether serving long or short periods of imprisonment.

The system of dietary in force in the local and convict prisons of England and Wales is that recommended by the Home Office on the advice of a departmental committee. As to the local prison dietary, its application is based on (1) the principle of variation of diet with length of sentence; (2) the system of progressive dietary; (3) the distinction between hard labour diets and non-hard labour diets; (4) the differentiation of diet according to age and sex. There are three classes of diet, classes A, B and C. Class A diet is given to prisoners undergoing not more than seven days' imprisonment. The food is good and wholesome, but sufficiently plain and unattractive, so as not to offer temptation to the loafer or mendicant. It is given in quantity sufficient to maintain health and strength during the single week. Prisoners sentenced to more than seven days and not more than fourteen days are given class A diet for the first seven days and class B for the remainder of the sentence. In most of the local prisons in England and Wales prisoners sentenced to hard labour received hard labour diet, although quite 60% were unable to perform the hardest forms of prison labour either through physical defect, age or infirmity. The departmental committee of 1899 in their report recommended that no distinction should be made between hard labour and non-hard labour diets. Class A diet is as follows:—Breakfast, Bread, 8 oz. daily (6 oz. for women and juveniles) with 1 pint of gruel. Juveniles (males and females under

sixteen years of age) get, in addition, $\frac{1}{2}$ pint of milk. Dinner, 8 oz. of bread daily, with 1 pint of porridge on three days of the week, 8 oz. of potatoes (representing the vegetable element) on two other days,

Class B diet, which is also given to (1) prisoners on remand or awaiting trial, (2) offenders of the 1st division who do not maintain themselves, (3) offenders of the 2nd division and (4) debtors, is as shown in Table I.

Class C diet is class B amplified, and is given to those prisoners serving sentences of three months and over.

The dietary of convict prisons, in which prisoners are all under long sentence, is divided into a diet for convicts employed at hard labour and a diet for convicts employed at sedentary, indoor and light labour. It will be found set forth in the Blue-book mentioned above. The sparest of all prison diets is called "punishment diet," and is administered for offences against the internal discipline of the prison. It is limited to a period of three days. It consists of 1 lb of bread and as much water as the prisoner chooses to drink.

In French prisons the dietary is nearly two pounds weight of bread, with two meals of thin soup (breakfast and dinner) made from potatoes, beans or other vegetables, and on two days a week made from meat. In France the canteen system is in vogue, additional food, such as sausages, cheese, fruit, &c., may be obtained by the prisoner, according to the wages he receives for his labours. The dietary of Austrian prisons is $\frac{1}{2}$ lb of bread daily, a dinner of soup on four days of the week, and of meat on the other three days, with a supper of soup or vegetable stew. Additional food can be purchased by the prisoner out of his earnings.

These dietaries may be taken as more or less typical of the ordinary prison fare in most civilized countries, though in some countries it may err on the side of severity, as in Sweden, prisoners being given only two meals a day, one at mid-day and one at seven P.M., porridge or gruel being the principal element in both meals. On the other hand, the prison dietaries of many of the United States prisons go to the other extreme, fresh fish, green vegetables, even coffee and fruit, figuring in the dietary.

Another class of dietary is that given to paupers. In England, until 1900, almost every individual workhouse had its own special dietary, with the consequence that many erred on the side of scantiness and unsuitability, while others were too lavish. By an order of the Local Government Board of that year, acting on a report of a committee, all inmates of workhouses, with the exception of the sick, children under three years of age, and certain other special cases, are dieted in accordance with certain dietary tables as framed and settled by the board. The order contained a great number of different rations, it being left to the discretion of the guardians as to the final settlement of the tables. For adult inmates the dietary tables are for each sex respectively, two in number, one termed "plain diet" and the other "infirm diet." All male inmates certified as healthy able-bodied persons receive plain diet only. All inmates, however, in workhouses are kept employed according to their capacity and ability, and this is taken into consideration in giving allowances of food. For instance, for work with sustained exertion, such as stone-breaking, digging, &c., more food is given than for work without sustained exertion, such as wood-chopping, weaving or sewing. Table II. shows an example of a workhouse dietary.

In the casual wards of workhouses the dietary is plainer, consisting of 8 oz. of bread, or 6 oz. of bread and one pint of gruel or broth for breakfast; the same for supper; for dinner 8 oz. of bread and $1\frac{1}{2}$ oz. of cheese or 6 oz. of bread and one pint of soup. The American poor law system is based broadly on that of England, and the methods of relief are much the same. Each state, however, makes its own regulations, and there is considerable diversity in workhouse dietaries in consequence. The German system of poor relief is more methodical than those of England and America. The really deserving are treated

TABLE I.

		Men.	Women.	Juveniles.
Breakfast.	Daily:—			
	Bread	8 oz.	6 oz.	6 oz.
	Gruel	1 pt.	1 pt.	$\frac{1}{2}$ pt.
Dinner.	Sunday:—			
	Bread	6 oz.	6 oz.	
	Potatoes . . .	8 "	8 "	
	Cooked meat, pre- served by heat	4 "	3 "	
	Monday:—			
	Bread	6 oz.	6 oz.	
	Potatoes . . .	8 "	8 "	
	Beans	10 "	8 "	
	Fat bacon . . .	2 "	1 "	
	Tuesday:—			
	Bread	6 oz.	6 oz.	
	Potatoes . . .	8 "	8 "	
	Soup	1 pt.	1 pt.	
	Wednesday:—			
	Bread	6 oz.	6 oz.	
	Potatoes . . .	8 "	8 "	
	Suet pudding .	10 "	8 "	
	Thursday:—			
	Bread	6 oz.	6 oz.	
	Potatoes . . .	8 "	8 "	
	Cooked beef, without bone	4 "	3 "	
	Friday:—			
	Bread	6 oz.	6 oz.	
	Potatoes . . .	8 "	8 "	
Soup	1 pt.	1 pt.		
Saturday:—				
Bread	6 oz.	6 oz.		
Potatoes . . .	8 "	8 "		
Suet pudding .	10 "	8 "		
Supper.	Daily:—			
	Bread	8 oz.	6 oz.	6 oz.
	Porridge . . .	1 pt.		
	Gruel		1 pt.	
Cocoa				

and 8 oz. of suet pudding (representing the fatty element) on the other two days. Supper, the breakfast fare repeated.

TABLE II.

	Breakfast.		Dinner.									Supper.						
	Bread.	Porridge.	Bread.	Beef.	Vegetables.	Barley Soup.	Pork.	Beans.	Fish.	Cheese.	Broth.	Irish stew.	Bread.	Butter.	Tea.	Gruel.	Broth.	Cheese.
Sunday . . .	8 oz.	0 pt.	4 oz.	4 $\frac{1}{2}$	12	12	0 oz.	0 oz.	0 oz.	0 pt.	0 pt.	0 pt.	8 oz.	0 oz.	1 pt.	1 pt.	0 pt.	0 oz.
Monday . . .	4	1 $\frac{1}{2}$	6	1 $\frac{1}{2}$	6	1 $\frac{1}{2}$
Tuesday . . .	4	1 $\frac{1}{2}$	4 $\frac{1}{2}$	12	6	1 $\frac{1}{2}$
Wednesday . . .	4	1 $\frac{1}{2}$	4	..	12	10	6	1 $\frac{1}{2}$
Thursday . . .	4	1 $\frac{1}{2}$	4	4 $\frac{1}{2}$	12	8	1	2
Friday . . .	4	1 $\frac{1}{2}$	8	3	1	6	1 $\frac{1}{2}$
Saturday . . .	4	1 $\frac{1}{2}$	6	1	6	1 $\frac{1}{2}$

* On Sundays 1 pint of tea and 2 $\frac{1}{2}$ oz. of butter are given instead of porridge

with more commiseration, and a larger amount of outdoor relief is given than in England. There is no casual ward, tramps and beggars being liable to penal treatment, but there are "relief stations," somewhat corresponding to casual wards, where destitute persons tramping from one place to another can obtain food and lodging in return for work done.

In the British navy certain staple articles of diet are supplied to the men to the value approximately of 6d. per diem—the standard government ration—and, in addition, a messing allowance of 4d. per diem, which may either be expended on luxuries in the canteen, or in taking up government provisions on board ship, in addition to the standard ration. The standard ration as recommended in 1907 by a committee appointed to inquire into the question of victualling in the navy is as follows:—

Service Afloat.

- 1 lb bread (or $\frac{2}{3}$ lb bread and $\frac{1}{3}$ lb trade flour).
- $\frac{1}{2}$ lb fresh meat.
- 1 lb fresh vegetables.
- $\frac{1}{2}$ pint spirit.
- 4 oz. sugar.
- $\frac{1}{2}$ oz. tea (or 1 oz. coffee for every $\frac{1}{2}$ oz. tea).
- $\frac{1}{2}$ oz. ordinary or soluble chocolate (or 1 oz. coffee).
- $\frac{1}{2}$ oz. condensed milk.
- 1 oz. jam or marmalade.
- 4 oz. preserved meat on one day of the week in harbour, or on two days at sea.

Mustard, pepper, vinegar, and salt as required.

Substitute for soft bread when the latter is not available—

$\frac{1}{2}$ lb biscuit (new type) or 1 lb flour.

Substitutes for fresh meat when the latter is not available:—

(1) Salt pork day:—

- $\frac{1}{2}$ lb salt pork.
- $\frac{1}{2}$ lb split peas.
- Celery seed, $\frac{1}{2}$ oz. to every 8 lb of split peas put into the coppers.
- $\frac{1}{2}$ lb potatoes (or 1 oz. compressed vegetables).

On alternate days.

(2) Preserved meat day:—

- 6 oz. preserved meat.
- 8 oz. trade flour.
- $\frac{1}{2}$ oz. refined suet or 4 oz. rice.
- 2 oz. raisins
- $\frac{1}{2}$ lb potatoes (or 1 oz. compressed vegetables).

On shore establishments and depot ships $\frac{1}{2}$ pt. fresh milk is issued in lieu of the $\frac{1}{2}$ oz. of condensed milk.

In the United States navy there is more liberality and variety of diet the approximate daily cost of the rations supplied being 7s. 3d. per head. In the American mercantile marine, too, according to the scale sanctioned by act of Congress (December 21, 1898) for American ships, the seaman is better off than in the British merchant service. The scale is shown in Table III.

TABLE III.

Weekly Scale.	Articles.	Weekly Scale.	Articles.
3 $\frac{1}{2}$ lb	Biscuits.	$\frac{1}{2}$ oz.	Tea.
3 "	Salt beef.	21 "	Sugar.
3 "	" pork.	1 $\frac{1}{2}$ lb	Molasses.
1 $\frac{1}{2}$ "	Flour.	9 oz.	Fruits, dried.
2 "	Meats, preserved.	$\frac{1}{2}$ pt.	Pickles.
10 $\frac{1}{2}$ "	Bread, fresh (8 lb flour in lieu).	1 "	Vinegar.
4 "	Fish, dried.	8 oz.	Corn Meal.
7 "	Potatoes or yams.	12 "	Onions.
1 "	Tomatoes, preserved.	7 "	Lard.
1 "	Peas.	7 "	Butter.
1 "	Calavanas.	$\frac{1}{2}$ "	Mustard.
1 "	Rice.	$\frac{1}{2}$ "	Pepper.
5 oz.	Coffee, green.	$\frac{1}{2}$ "	Salt.

In the British mercantile marine there is no scale of provisions prescribed by the Board of Trade; there is, however, a traditional scale very generally adopted, having the sanction of custom only and seldom adhered to. The following dietary scale for steerage passengers, laid down in the 12th schedule of the Merchant Shipping Act 1894, is of interest. See Table IV.

Certain substitutions may be made in this scale at the option of the master of any emigrant ship, provided that the substituted articles are set forth in the contract tickets of the steerage passengers.

In the British army the soldier is fed partly by a system of co-operation. He gets a free ration from government of 1 lb of bread and $\frac{1}{2}$ lb of meat; in addition there is a messing allowance of 3d. per man per day. He is able to supplement his food by purchases from the canteen. Much depends on the individual management in each

regiment as to the satisfactory expenditure of the messing allowance. In some regiments an allowance is made from the canteen funds towards messing in addition to that granted by the government. The ordinary field ration of the British soldier is 1 $\frac{1}{2}$ lb of bread or 1 lb of biscuit; 1 lb of fresh, salt or preserved meat; $\frac{1}{2}$ oz. of coffee; $\frac{1}{2}$ oz. of tea; 2 oz. of sugar; $\frac{1}{2}$ oz. of salt, $\frac{1}{2}$ oz. of pepper; the whole weighing something over 2 lb 3 oz. This cannot be looked on as a fixed ration, as it varies in different campaigns, according to the country into which the troops may be sent. The Prussian soldier during peace gets weekly from his canteen 11 lb 1 oz. of rye bread and not quite 2 $\frac{1}{2}$ lb of meat. This is obviously insufficient, but under

TABLE IV.—Weekly, per *Statute Adult.*

	Scale A.	Scale B.
	For voyages not exceeding 84 days for sailing ships or 50 days for steamships.	For voyages exceeding 84 days for sailing ships or 50 days for steamships.
	lb oz.	lb oz.
Bread or biscuit, not inferior to navy biscuit	3 8	3 8
Wheaten flour	1 0	2 0
Oatmeal	1 8	1 0
Rice	1 8	0 8
Peas	1 8	1 8
Beef	1 4	1 4
Pork	1 0	1 0
Butter	0 4
Potatoes	2 0	2 0
Sugar	1 0	1 0
Tea	0 2	0 2
Salt	0 2	0 2
Pepper (white or black), ground	0 0 $\frac{1}{2}$	0 0 $\frac{1}{2}$
Vinegar	1 gill	1 gill
Preserved meat	0 0
Suet	0 6
Raisins	0 8
Lime juice	0 6

the conscription system it is reckoned that he will be able to make up the deficiency out of his own private means, or obtain charitable contributions from his friends. In the French infantry of the line each man during peace gets weekly 15 lb of bread, 3 $\frac{1}{2}$ lb of meat, 2 $\frac{1}{2}$ lb of haricot beans or other vegetables, with salt and pepper, and 1 $\frac{1}{2}$ oz. of brandy.

An Austrian under the same circumstances receives 13-9 lb of bread, $\frac{1}{2}$ lb of flour and 3-3 lb of meat.

The Russian conscript is allowed weekly:—

- Black bread 7 lb.
- Meat 7 lb.
- Kvass (beer) 7-7 quarts.
- Sour cabbage 24 gills = 122 $\frac{1}{2}$ oz.
- Barley 24 gills = 122 $\frac{1}{2}$ oz.
- Salts 10 $\frac{1}{2}$ oz.
- Horse-radish 28 grains.
- Pepper 28 grains.
- Vinegar 51 gills = 26 $\frac{1}{2}$ oz.

DIETETICS, the science of diet, i.e. the food and nutrition of man in health and disease (see NUTRITION). This article deals mainly with that part of the subject which has to do with the composition and nutritive values of foods and their adaptation to the use of people in health. The principal topics considered are: (1) Food and its functions; (2) Metabolism of matter and energy; (3) Composition of food materials; (4) Digestibility of food; (5) Fuel value of food; (6) Food consumption; (7) Quantities of nutrients needed; (8) Hygienic economy of food; (9) Pecuniary economy of food.

1. *Food and its Functions.*—For practical purposes, food may be defined as that which, when taken into the body, may be utilized for the formation and repair of body tissue, and the production of energy. More specifically, food meets the requirements of the body in several ways. It is used for the formation of the tissues and fluids of the body, and for the restoration of losses of substance due to bodily activity. The potential energy of the food is converted into heat or muscular work or other forms of energy. In being thus utilized, food protects body substance or previously acquired nutritive material from consumption. When the amount

of food taken into the body is in excess of immediate needs, the surplus may be stored for future consumption.

Ordinary food materials, such as meat, fish, eggs, vegetables, &c., consist of inedible materials, or *refuse*, e.g. bone of meat and fish, shell of eggs, rind and seed of vegetables; and *edible material*, as flesh of meat and fish, white and yolk of eggs, wheat flour, &c. The edible material is by no means a simple substance, but consists of *water*, and some or all of the compounds variously designated as food stuffs, proximate principles, nutritive ingredients or nutrients, which are classified as *proteins*, *fats*, *carbohydrates* and *mineral matters*. These have various functions in the nourishment of the body.

The *refuse* commonly contains compounds similar to those in the food from which it is derived, but since it cannot be eaten, it is usually considered as a non-nutrient. It is of importance chiefly in a consideration of the pecuniary economy of food. *Water* is also considered as a non-nutrient, because although it is a constituent of all the tissues and fluids of the body, the body may obtain the water it needs from that drunk; hence, that contained in the food materials is of no special significance as a nutrient.

Mineral matters, such as sulphates, chlorides, phosphates and carbonates of sodium, potassium, calcium, &c., are found in different combinations and quantities in most food materials. These are used by the body in the formation of the various tissues, especially the skeletal and protective tissues, in digestion, and in metabolic processes within the body. They yield little or no energy, unless perhaps the very small amount involved in their chemical transformation.

Protein¹ is a term used to designate the whole group of nitrogenous compounds of food except the nitrogenous fats. It includes the albuminoids, as albumin of egg-white, and of blood serum, myosin of meat (muscle), casein of milk, globulin of blood and of egg yolk, fibrin of blood, gluten of flour; the gelatinoids, as gelatin and allied substances of connective tissue, collagen of tendon, ossein of bone and the so-called extractives (e.g. creatin) of meats; and the amids (e.g. asparagin) and allied compounds of vegetables and fruits.

The albuminoids and gelatinoids, classed together as proteids, are the most important constituents of food, because they alone can supply the nitrogenous material necessary for the formation of the body tissues. For this purpose, the albuminoids are most valuable. Both groups of compounds, however, supply the body with energy, and the gelatinoids in being thus utilized protect the albuminoids from consumption for this purpose. When their supply in the food is in excess of the needs of the body, the surplus proteids may be converted into body fat and stored.

The so-called extractives, which are the principal constituents of meat extract, beef tea and the like, act principally as stimulants and appetizers. It has been believed that they serve neither to build tissue nor to yield energy, but recent investigations² indicate that creatin may be metabolized in the body.

The *fats* of food include both the animal fats and the vegetable oils. The *carbohydrates* include such compounds as starches, sugars and the fibre of plants or cellulose, though the latter has but little value as food for man. The more important function of both these classes of nutrients is to supply energy to the body to meet its requirements above that which it may obtain from the proteids. It is not improbable that the atoms of their molecules as well as those from the proteids are built up into the protoplasmic substance of the tissues. In this sense, these nutrients may be considered as being utilized also for the formation of tissue; but they are rather the accessory ingredients, whereas the proteids are the essential ingredients for this purpose. The fats in the food in excess of the body requirements may be stored as body fat, and the surplus carbohydrates may also be converted into fat and stored.

¹ The terms applied by different writers to these nitrogenous compounds are conflicting. For instance, the term "proteid" is sometimes used as protein is here used, and sometimes to designate the group here called albuminoids. The classification and terminology here followed are those tentatively recommended by the Association of American Agricultural Colleges and Experiment Stations.

² *Polin, Festschrift für Olaf Hammarsten*, iii. (Upsala, 1906).

To a certain extent, then, the nutrients of the food may substitute each other. All may be incorporated into the protoplasmic structure of body tissue, though only the proteids can supply the essential nitrogenous ingredients; and apart from the portion of the proteid material that is indispensable for this purpose, all the nutrients are used as a source of energy. If the supply of energy in the food is not sufficient, the body will use its own proteid and fat for this purpose. The gelatinoids, fats and carbohydrates in being utilized for energy protect the body proteids from consumption. The fat stored in the body from the excess of food is a reserve of energy material, on which the body may draw when the quantity of energy in the food is insufficient for its immediate needs.

What compounds are especially concerned in intellectual activity is not known. The belief that fish is especially rich in phosphorus and valuable as a brain food has no foundation in observed fact.

2. *Metabolism of Matter and Energy*.—The processes of nutrition thus consist largely of the transformation of food into body material and the conversion of the potential energy of both food and body material into the kinetic energy of heat and muscular work and other forms of energy. These various processes are generally designated by the term metabolism. The metabolism of matter in the body is governed largely by the needs of the body for energy. The science of nutrition, of which the present subject forms a part, is based on the principle that the transformations of matter and energy in the body occur in accordance with the laws of the conservation of matter and of energy. That the body can neither create nor destroy matter has long been universally accepted. It would seem that the transformation of energy must likewise be governed by the law of the conservation of energy; indeed there is every reason a priori to believe that it must; but the experimental difficulties in the way of absolute demonstration of the principle are considerable. For such demonstration it is necessary to prove that the income and expenditure of energy are equal. Apparatus and methods of inquiry devised in recent years, however, afford means for a comparison of the amounts of both matter and energy received and expended by the body, and from the results obtained in a large amount of such research, it seems probable that the law obtains in the living organism in general.

The first attempt at such demonstration was made by M. Rubner³ in 1894, experimenting with dogs doing no external muscular work. The income of energy (as heat) was computed, but the heat eliminated was measured. In the average of eight experiments continuing forty-five days, the two quantities agreed within 0.47%, thus demonstrating what it was desired to prove—that the heat given off by the body came solely from the oxidation of food within it. Results in accordance with these were reported by Studenski⁴ in 1897, and by Laulanie⁵ in 1898.

The most extensive and complete data yet available on the subject have been obtained by W. O. Atwater, F. G. Benedict and associates⁶ in experiments with men in the respiration calorimeter, in which a subject may remain for several consecutive days and nights. These experiments involve actual weighing and analyses of the food and drink, and of the gaseous, liquid and solid excretory products; determinations of potential energy (heat of oxidation) of the oxidizable material received and given off by the body (including estimation of the energy of the material gained or lost by the body); and measurements of the amounts of energy expended as heat and as external muscular work. By October 1906 eighty-eight experiments with fifteen different subjects had been completed. The separate experiments continued from two to thirteen days, making a total of over 270 days.

³ *Ztschr. Biol.* 30, 73.

⁴ In Russian. Cited in United States Department of Agriculture, Office of Experiment Stations, Bul. No. 45, *A Digest of Metabolism Experiments*, by W. O. Atwater and C. F. Langworthy.

⁵ *Arch. physiol. norm. et path.* (1894) 4.

⁶ U.S. Department of Agriculture, Office of Experiment Stations, Bulletins Nos. 63, 69, 109, 136, 175. For a description of the respiration calorimeter here mentioned see also publication No. 42 of the Carnegie Institution of Washington.

In some cases the subjects were at rest; in others they performed varying amounts of external muscular work on an apparatus by means of which the amount of work done was measured. In some cases they fasted, and in others they received

body. The variations for individual days, and in the average for individual experiments as well, were in some cases appreciable, amounting to as much as 6%, which is not strange in view of the uncertainties in physiological experimenting; but in the average

TABLE I.—Percentage Composition of some Common Food Materials.

Food Material.	Refuse.	Water.	Protein.	Fat.	Carbo- hydrates.	Mineral Matter.	Fuel Value per lb.
	%	%	%	%	%	%	Calories.
Beef, fresh (medium fat)—							
Chuck	16.3	52.6	15.5	15.0	..	0.8	910
Loin	13.3	52.5	16.1	17.5	..	0.9	1025
Ribs	20.8	43.8	13.9	21.2	..	0.7	1135
Round	7.2	60.7	19.0	12.8	..	1.0	890
Shoulder	16.4	56.8	16.4	9.8	..	0.9	715
Beef, dried and smoked	4.7	53.7	26.4	6.9	..	8.9	790
Veal—							
Leg	14.2	60.1	15.5	7.9	..	0.9	625
Loin	16.5	57.6	16.6	9.0	..	0.9	685
Breast	21.3	52.0	15.4	11.0	..	0.8	745
Mutton—							
Leg	18.4	51.2	15.1	14.7	..	0.8	890
Loin	16.0	42.0	13.5	28.3	..	0.7	1415
Flank	9.9	39.0	13.8	36.9	..	0.6	1770
Pork—							
Loin	19.7	41.8	13.4	24.2	..	0.8	1245
Ham, fresh	10.7	48.0	13.5	25.9	..	0.8	1320
Ham, smoked and salted	13.6	34.8	14.2	33.4	..	4.2	1635
Fat, salt	..	7.9	1.9	86.2	..	3.9	3555
Bacon	7.7	17.4	9.1	62.2	..	4.1	2715
Lard, refined	100.0	4100
Chicken	25.9	47.1	13.7	12.3	..	0.7	765
Turkey	22.7	42.4	16.1	18.4	..	0.8	1060
Goose	17.6	38.5	13.4	29.8	..	0.7	1475
Eggs	11.2	65.5	13.1	9.3	..	0.9	635
Cod, fresh	29.9	58.5	11.1	0.2	..	0.8	220
Cod, salted	24.9	40.2	16.0	0.4	..	18.5	325
Mackerel, fresh	44.7	40.4	10.2	4.2	..	0.7	370
Herring, smoked	..	19.2	20.5	8.8	..	7.4	755
Salmon, tinned	..	63.5	21.8	12.1	..	2.6	915
Oysters, shelled	..	88.3	6.0	1.3	3.3	1.1	225
Butter	..	11.0	1.0	85.0	..	3.8	3410
Cheese	..	34.2	25.9	33.7	2.4	3.8	1885
Milk, whole	..	87.0	3.3	4.0	5.0	0.7	310
Milk, skimmed	..	90.5	3.4	0.3	5.1	0.7	165
Oatmeal	..	7.7	16.7	7.3	66.2	2.1	1800
Corn (maize) meal	..	12.5	9.2	1.9	75.4	1.0	1635
Rye flour	..	12.0	6.8	0.9	78.7	0.7	1650
Buckwheat flour	..	13.6	6.4	1.2	77.9	0.9	1605
Rice	..	12.3	8.0	0.3	79.0	0.4	1620
Wheat flour, white	..	12.0	11.4	1.0	75.1	0.5	1635
Wheat flour, graham	..	11.3	13.3	2.2	71.4	1.8	1645
Wheat, breakfast food	..	9.6	12.1	1.8	75.2	1.3	1680
Wheat bread, white	..	35.3	9.2	1.3	53.1	1.1	1200
Wheat bread, graham	..	35.7	8.9	1.8	52.1	1.5	1195
Rye bread	..	35.7	9.0	0.6	53.2	1.5	1170
Biscuit (crackers)	..	6.8	9.7	12.1	69.7	1.7	1925
Macaroni	..	10.3	13.4	0.9	74.1	1.3	1645
Sugar	100.0	..	1750
Starch (corn starch)	90.0	..	1680
Beans, dried	..	12.6	22.5	1.8	59.6	3.5	1520
Peas, dried	..	9.5	24.6	1.0	62.0	2.9	1565
Beets	20.0	70.0	1.3	0.1	7.7	0.9	160
Cabbage	15.0	77.7	1.4	0.2	4.8	0.9	115
Squash	50.0	44.2	0.7	0.2	4.5	0.4	100
Potatoes	20.0	62.6	1.8	0.1	14.7	0.8	295
Sweet potatoes	20.0	55.2	1.4	0.6	21.9	0.9	440
Tomatoes	..	94.3	0.9	0.4	3.9	0.5	100
Apples	25.0	63.3	0.3	0.3	10.8	0.3	190
Bananas	35.0	48.9	0.8	0.4	14.3	0.6	260
Grapes	25.0	58.0	1.0	1.2	14.4	0.4	295
Oranges	27.0	63.4	0.6	0.1	8.5	0.4	150
Strawberries	5.0	85.9	0.9	0.6	7.0	0.6	150
Almonds	45.0	2.7	11.5	30.2	9.5	1.1	1515
Brazil nuts	49.6	2.6	8.6	33.7	3.5	2.0	1485
Chestnuts	16.0	37.8	3.2	4.5	35.4	1.1	915
Walnuts	58.1	1.0	6.9	26.6	6.8	0.6	1250

diets generally not far from sufficient to maintain nitrogen, and usually carbon, equilibrium in the body. In these experiments the amount of energy expended by the body as heat and as external muscular work measured in terms of heat agreed on the average very closely with the amount of heat that would be produced by the oxidation of all the matter metabolized in the

of all the experiments the energy of the expenditure was above 99.9% of the energy of the income,—an agreement within one part in 1000. While these results do not absolutely prove the application of the law of the conservation of energy in the human body, they certainly approximate very closely to such demonstration. It is of course possible that energy may have given off

from the body in other forms than heat and external muscular work. It is conceivable, for example, that intellectual activity may involve the transformation of physical energy, and that the energy involved may be eliminated in some form now unknown. But if the body did give off energy which was not measured in these experiments, the quantity must have been extremely small. It seems fair to infer from the results obtained that the metabolism of energy in the body occurred in conformity with the law of the conservation of energy.

3. *Composition of Food Materials.*—The composition of food is determined by chemical analyses, the results of which are conventionally expressed in terms of the nutritive ingredients previously described. As a result of an enormous amount of such investigation in recent years, the kinds and proportions of nutrients in our common sorts of food are well known. Average

TABLE II.—Coefficients of Digestibility (or Availability) of Nutrients in Different Classes of Food Materials.

Kind of Food.	Protein.	Fat.	Carbo- hydrates.	Kind of Food.	Protein.	Fat.	Carbo- hydrates.
	%	%	%		%	%	%
Meats	98	98	..	Corn meal	80	..	99
Fish	96	97	..	Wheat meals without bran	83	..	93
Poultry	96	97	..	Wheat meals with bran	75	..	92
Eggs	97	98	..	White bread	88	..	98
Dairy products	97	96	98	Entire wheat bread	82	..	94
Total animal food of mixed diet	97	97	98	Graham bread	76	..	90
Potatoes	73	..	98	Rice	76	86	91
Beets, carrots, &c.	72	..	97	Fruits and nuts	80	..	96
Cabbage, lettuce, &c.	83	Sugars and starches	98
Legumes	78	90	95	Total vegetable food of mixed diet	85	90	97
Oatmeal	78	90	97	Total food of mixed diet	92	95	97

values for percentage composition of some ordinary food materials are shown in Table I. (Table I. also includes figures for fuel value.)

It will be observed that different kinds of food materials vary widely in their proportions of nutrients. In general the animal foods contain the most protein and fats, and vegetable foods are rich in carbohydrates. The chief nutrient of lean meat and fish is protein; but in medium fat meats the proportion of fat is as large as that of protein, and in the fatter meats it is larger. Cheese is rich in both protein and fat. Among the vegetable foods, dried beans and peas are especially rich in protein. The proportion in oatmeal is also fairly large, in wheat it is moderate, and in maize meal and rice it is rather small. Oats contain more oil than any of the common cereals, but in none of them is the proportion especially large. The most abundant nutrient in all the cereals is starch, which comprises from two-thirds to three-fourths or more of their total nutritive substance. Cotton-seed is rich in edible oil, and so are olives. Some of the nuts contain fairly large proportions of both protein and fat. The nutrient of potatoes is starch, present in fair proportion. Fruits contain considerable carbohydrates, chiefly sugar. Green vegetables are not of much account as sources of any of the nutrients or energy.

Similar food materials from different sources may also differ considerably in composition. This is especially true of meats. Thus, the leaner portions from a fat animal may contain nearly as much fat as the fatter portions from a lean animal. The data here presented are largely those for American food products, but the available analyses of English food materials indicate that the latter differ but little from the former in composition. The analyses of meats produced in Europe imply that they commonly contain somewhat less fat and more water, and often more protein, than American meats. The meats of English production compare with the American more than with the European meats. Similar vegetable foods from the different countries do not differ so much in composition.

4. *Digestibility or Availability of Food Materials.*—The value of any food material for nutriment depends not merely upon the kinds and amounts of nutrients it contains, but also upon the ease and convenience with which the nutrients may be digested, and especially upon the proportion of the nutrients that will be

actually digested and absorbed. Thus, two foods may contain equal amounts of the same nutrient, but the one most easily digested will really be of most value to the body, because less effort is necessary to utilize it. Considerable study of this factor is being made, and much valuable information is accumulating, but it is of more especial importance in cases of disordered digestion.

The digestibility of food in the sense of thoroughness of digestion, however, is of particular importance in the present discussion. Only that portion of the food that is digested and absorbed is available to the body for the building of tissue and the production of energy. Not all the food eaten is thus actually digested; undigested material is excreted in the faeces. The thoroughness of digestion is determined experimentally by weighing and analysing the food eaten and the faeces pertaining

to it. The difference between the corresponding ingredients of the two is commonly considered to represent the amounts of the ingredients digested. Expressed in percentages, these are called coefficients of digestibility. See Table II.

Such a method is not strictly accurate, because the faeces do not consist entirely of undigested food but contain in addition to this the so-called metabolic products, which include the residuum of digestive juices not reabsorbed, fragments of intestinal epithelium, &c. Since there is as yet no satisfactory method of separating these constituents of the excreta, the actual digestibility of the food is not determined. It has been suggested that since these materials must originally come from food, they represent, when expressed in terms of food ingredients, the cost of digestion; hence that the values determined as above explained represent the portion of food available to the body for the building of tissue and the yielding of energy, and what is commonly designated as digestibility should be called availability. Other writers retain the term "digestibility," but express the results as "apparent digestibility," until more knowledge regarding the metabolic products of the excreta is available and the actual digestibility may be ascertained.

Experimental inquiry of this nature has been very active in recent years, especially in Europe, the United States and Japan; and the results of considerably over 1000 digestion experiments with single foods or combinations of food materials are available. These were mostly with men, but some were with women and with children. The larger part of these have been taken into account in the following estimations of the digestibility of the nutrients in different classes of food materials. The figures here shown are subject to revision as experimental data accumulate. They are not to be taken as exact measures of the digestibility (or availability) of every kind of food in each given class, but they probably represent fairly well the average digestibility of the classes of food materials as ordinarily utilized in the mixed diet.

5. *Fuel Value of Food.*—The potential energy of food is commonly measured as the amount of heat evolved when the food is completely oxidized. In the laboratory this is determined by burning the food in oxygen in a calorimeter. The results, which are known as the heat of combustion of the food, are

expressed in calories, one calory being the amount of heat necessary to raise the temperature of one kilogram of water one degree centigrade. But it is to be observed that this unit is

TABLE III.—Estimates of Heats of Combustion and of Fuel Value of Nutrients in Ordinary Mixed Diet.

Nutrients.	Heat of Combustion.	Fuel Value.
	Calories.	Calories.
One gram of protein . . .	5.65	4.05
One gram of fats . . .	9.40	8.93
One gram of carbohydrates . . .	4.15	4.03

employed simply from convenience, and without implication as to what extent the energy of food is converted into heat in the body. The unit employed in the measurement of some other

greater than that which the body will actually derive from it. In the first place, as previously shown, part of the food will not be digested and absorbed. In the second place, the nitrogenous compounds absorbed are not completely oxidized in the body, the residuum being excreted in the urine as urea and other bodies that are capable of further oxidation in the calorimeter. The total heat of combustion of the food eaten must therefore be diminished by the heat of combustion of the oxidizable material rejected by the body, to find what amount of energy is actually available to the organism for the production of work and heat. The amount thus determined is commonly known as the fuel value of food.

Rubner's¹ commonly quoted estimates for the fuel value of the nutrients of mixed diet are,—for protein and carbohydrates 4.1, and for fats 9.3 calories per gram. According to the method of deduction, however, these factors were more applicable to digested than to total nutrients. Atwater² and associates have deduced,

TABLE IV.—Quantities of Available Nutrients and Energy in Daily Food Consumption of Persons in Different Circumstances.

	Number of Studies.	Nutrients and Energy per Man per Day.			
		Protein.	Fat.	Carbo-hydrates.	Fuel Value.
<i>Persons with Active Work.</i>					
English royal engineers	1	132	79	612	3835
Prussian machinists	1	129	107	657	4265
Swedish mechanics	5	174	105	693	4590
Bavarian lumbermen	3	120	277	702	6015
American lumbermen	5	155	327	804	6745
Japanese rice cleaner	1	103	11	917	4415
Japanese jiarikahaw runner	1	137	22	1010	5050
Chinese farm labourers in California	1	132	90	621	3980
American athletes	19	178	192	525	4740
American working-men's families	13	156	226	694	5650
<i>Persons with Ordinary Work.</i>					
Bavarian mechanics	11	112	32	553	3060
Bavarian farm labourers	5	126	52	526	3200
Russian peasants	1	119	31	571	3155
Prussian prisoners	1	117	28	620	3320
Swedish mechanics	6	123	75	507	3325
American working-men's families	69	103	135	426	3480
<i>Persons with Light Work.</i>					
American artisans' families	21	93	107	358	2880
English tailors (prisoners)	1	121	37	509	2970
German shoemakers	1	99	73	367	2629
Japanese prisoners	1	43	6	444	2110
<i>Professional and Business Men.</i>					
Japanese professional men	13	75	15	408	2190
Japanese students	8	85	18	537	2800
Japanese military cadets	11	98	20	611	3185
German physicians	2	121	90	317	2685
Swedish medical students	5	117	108	291	2725
Danish physicians	1	124	133	242	2790
American professional and business men and students	51	98	125	411	3285
<i>Persons with Little or no Exercise.</i>					
Prussian prisoners	2	90	27	427	2400
Japanese prisoners	1	36	6	360	1725
Inmates of home for aged—Germany	1	85	43	322	2097
Inmates of hospitals for insane—America	49	80	86	353	2590
<i>Persons in Destitute Circumstances.</i>					
Prussian working people	13	63	43	372	2215
Italian mechanics	5	70	36	384	2225
American working-men's families	11	69	75	263	2085

form of energy might be used instead, as, for example, the foot-ton, which represents the amount of energy necessary to raise one ton through one foot.

The amount of energy which a given quantity of food will produce on complete oxidation outside the body, however, is

from data much more extensive than those available to Rubner, factors for total nutrients somewhat lower than these, as shown

¹ *Ztschr. Biol.* 21 (1885), p. 377.

² *Connecticut (Storrs) Agricultural Experiment Station Report* (1899), 73.

in Table III. These estimates seem to represent the best average factors at present available, but are subject to revision as knowledge is extended.

The heats of combustion of all the fats in an ordinary mixed diet would average about 9.40 calories per gram, but as only 95% of the fat would be available to the body, the fuel value per gram would be $(9.40 \times 0.95) = 8.93$ calories. Similarly, the average heat of combustion of carbohydrates of the diet would be about 4.15 calories per gram, and as 97% of the total quantity is available to the body, the fuel value per gram would be 4.03. (It is commonly assumed that the resorbed fats and carbohydrates are completely oxidized in the body.) The heats of combustion of all the kinds of protein in the diet would average about 5.65 calories per gram. Since about 92% of the total protein would be available to the body, the potential energy of the available protein would be equivalent to $(5.65 \times 0.92) = 5.20$ calories; but as the available protein is not completely oxidized allowance must be made for the potential energy of the incompletely oxidized residue. This is estimated as equivalent to 1.15 calories for the 0.92 gram of available protein; hence, the fuel value of the total protein is $(5.20 - 1.15) = 4.05$ calories per gram. Nutrients of the same class, but from different food materials, vary both in digestibility and in heat of combustion, and hence in fuel value. These factors are therefore not so applicable to the nutrients of the separate articles in a diet as to those of the diet as a whole.

6. *Food Consumption.*—Much information regarding the food consumption of people in various circumstances in different parts of the world has accumulated during the past twenty years, as a result of studies of actual dietaries in England, Germany, Italy, Russia, Sweden and elsewhere in Europe, in Japan and other oriental countries, and especially in the United States. These studies commonly consist in ascertaining the kinds, amounts and composition of the different food materials consumed by a group of persons during a given period and the number of meals taken by each member of the group, and computing the quantities of the different nutrients in the food on the basis of one man for one day. When the members of the group are of different age, sex, occupation, &c., account must be taken of the effect of these factors on consumption in estimating the value "per man." Men as a rule eat more than women under similar conditions, women more than children, and persons at active work more than those at sedentary occupation. The navy, for example, who is constantly using up more nutritive material or body tissue to supply the energy required for his muscular work needs more protein and energy in his food than a bookkeeper who sits at his desk all day.

In making allowance for these differences, the various individuals are commonly compared with a man at moderately active muscular work, who is taken as unity. A man at hard muscular work is reckoned as 1.2 times such an individual; a man with light muscular work or a boy 15-16 years old, .9; a man at sedentary occupation, woman at moderately active muscular work, boy 13-14 or girl 15-16 years old, .8; woman at light work, boy 12 or girl 13-14 years old, .7; boy 10-11 or girl 10-12 years old, .6; child 6-9 years old, .5; child 2-5 years old, .4; child under 2 years, .3. These factors are by no means absolute or final, but are based in part upon experimental data and in part upon arbitrary assumption.

The total number of dietary studies on record is very large, but not all of them are complete enough to furnish reliable data. Upwards of 1000 are sufficiently accurate to be included in statistical averages of food consumed by people in different circumstances, nearly half of which have been made in the United States in the past decade. The number of persons in the individual studies has ranged from one to several hundred. Some typical results are shown in Table IV.

7. *Quantities of Nutrients needed.*—For the proper nourishment of the body, the important problem is how much protein, fats and carbohydrates, or more simply, what amounts of protein and potential energy are needed under varying circumstances, to build and repair muscular and other tissues and to supply

energy for muscular work, heat and other forms of energy. The answer to the problem is sought in the data obtained in dietary studies with considerable numbers of people, and in metabolism experiments with individuals in which the income and expenditure of the body are measured. From the information thus derived, different investigators have proposed so-called dietary standards, such as are shown in the table below, but unfortunately the experimental data are still insufficient for entirely trustworthy figures of this sort; hence the term "standard" as here used is misleading. The figures given are not to be considered as exact and final as that would suggest; they are merely tentative estimates of the average daily amounts of nutrients and energy required. (It is to be especially noted that these are available nutrients and fuel value rather than total nutrients and energy.) Some of the values proposed by other investigators are slightly larger than these, and others are decidedly smaller, but these are the ones that have hitherto been most commonly accepted in Europe and America.

TABLE V.—Standards for Dietaries. Available Nutrients and Energy per Man per Day.

	Protein.	Fat.	Carbo- hydrates.	Fuel Value.
<i>Voit's Standards.</i>	Grams. ¹	Grams.	Grams.	Calories.
Man at hard work	133	95	437	3270
Man at moderate work	109	53	485	2965
<i>Atwater's Standards.</i>				
Man at very hard muscular work	161	.. ²	.. ³	5500
Man at hard muscular work	138	4150
Man at moderately active muscular work	115	3400
Man at light to moderate muscular work	103	3050
Man at "sedentary" or woman at moderately active work	92	2700
Woman at light muscular work, or man without muscular exercise	83	2450

8. *Hygienic Economy of Food.*—For people in good health, there are two important rules to be observed in the regulation of the diet. One is to choose the foods that "agree" with them, and to avoid those which they cannot digest and assimilate without harm; and the other is to use such sorts and quantities of foods as will supply the kinds and amounts of nutrients needed by the body and yet to avoid burdening it with superfluous material to be disposed of at the cost of health and strength.

As for the first-mentioned rule, it is practically impossible to give information that may be of more than general application. There are people who, because of some individual peculiarity, cannot use foods which for people in general are wholesome and nutritious. Some persons cannot endure milk, others suffer if they eat eggs, others have to eschew certain kinds of meat, or are made uncomfortable by fruit; but such cases are exceptions. Very little is known regarding the cause of these conditions. It is possible that in the metabolic processes to which the ingredients of the food are subjected in the body, or even during digestion before the substances are actually taken into the body, compounds may be formed that are in one way or another injurious. Whatever the cause may be, it is literally true in this sense that "what is one man's meat is another man's poison," and each must learn for himself what foods "agree" with him and what ones do not. But for the great majority of people in health,

¹ One ounce equals 28.35 grams.

² As the chief function of both fats and carbohydrates is to furnish energy, their exact proportion in the diet is of small account. The amount of either may vary largely according to taste, available supply, or other condition, as long as the total amount of both is sufficient, together with the protein to furnish the required energy.

suitable combinations of the ordinary sorts of wholesome food materials make a healthful diet. On the other hand, some foods are of particular value at times, aside from their use for nourishment. Fruits and green vegetables often benefit people greatly, not as nutriment merely, for they may have very little actual nutritive material, but because of fruit or vegetable acids or

other substances which they contain, and which sometimes serve a most useful purpose.

The proper observance of the second rule mentioned requires information regarding the demands of the body for food under different circumstances. To supply this information is one purpose of the effort to determine the so-called dietary standards

TABLE VI.—Amounts of Nutrients and Energy Furnished for One Shilling in Food Materials at Ordinary Prices.

Food Materials as Purchased.	Prices per lb.	One Shilling will buy				Fuel Value.
		Total Food Materials.	Available Nutrients.			
			Protein.	Fat.	Carbo-hydrates.	
	a. d.	lb.	lb.	lb.	lb.	Calories.
Beef, round	0 10 0 8½ 0 5	1-20 1-41 2-40	·22 ·26 ·44	·14 ·17 ·29	1,155 1,235 2,105
Beef, sirloin	0 10 0 9 0 8 0 5	1-20 1-33 1-50 2-40	·19 ·21	·20 ·22	1,225 1,360
Beef, rib	0 9 0 7½ 0 4½	1-33 1-60 2-67	·19	·19	1,200
Mutton, leg	0 9 0 5	1-33 2-40	·20 ·37	·20 ·35	1,245 2,245
Pork, spare-rib	0 9 0 7	1-33 1-71	·17 ·22	·31 ·39	1,645 2,110
Pork, salt, fat	0 7 0 5	1-71 2-40	·03 ·04	1-40 1-97	6,025 8,460
Pork, smoked ham	0 8 0 4½	1-50 2-67	·20 ·36	·48 ·85	2,435 4,330
Fresh cod	0 4 0 3	3-00 4-00	·34 ·45	·01 ·01	710 945
Salt cod	0 3½ 0 10	3-43 1-20	·54 ·07	·07 ·01	.. ·04	1,370 275
Milk, whole, 4d. a qt.	0 2	6-00	·19	·23	·30	1,915
" 3d. a qt.	0 1½	8-00	·26	·30	·40	2,550
" 2d. a qt.	0 1	12-00	·38	·46	·60	3,825
Milk, skimmed, 2d. a qt.	0 1	12-00	·40	·03	·61	2,085
Butter	1 6 1 3 1 0	·67 ·80 1-00	·01 ·01 ·01	·54 ·64 ·81	2,320 2,770 3,460
Margarine	0 4	3-00	..	2-37	..	10,080
Eggs, 2s. a dozen	1 4	·75	·10	·07	..	475
" 1½s. a dozen	1 0	1-00	·13	·09	..	635
" 1s. a dozen	0 8	1-50	·19	·13	..	950
Cheese	0 8 0 7 0 5	1-50 1-71 2-40	·38 ·43 ·60	·48 ·55 ·77	·04 ·04 ·06	2,865 3,265 4,585
Wheat bread	0 1½	10-67	·76	·13	5-57	12,421
Wheat flour	0 1½ 0 1½	7-64 8-16	·67 ·72	·07 ·07	5-63 6-01	12,110 12,935
Oatmeal	0 1½ 0 1½	8-39 8-16	1-11 1-08	·54 ·53	5-54 5-39	14,835 14,430
Rice	0 1½	6-86	·45	·02	5-27	10,795
Potatoes	0 0½ 0 0½	18-00 24-00	·25 ·34	·02 ·02	2-70 3-60	5,605 7,470
Beans	0 2	6-00	1-05	·10	3-47	8,960
Sugar	1 ½	6-86	6-86	12,760

mentioned above. It should be observed, however, that these are generally more applicable to the proper feeding of a group or class of people as a whole than for particular individuals in this class. The needs of individuals will vary largely from the average in accordance with the activity and individuality. Moreover, it is neither necessary nor desirable for the individual to follow any standard exactly from day to day. It is requisite only that the average supply shall be sufficient to meet the demands of the body during a given period.

The cooking of food and other modes of preparing it for consumption have much to do with its nutritive value. Many materials which, owing to their mechanical condition or to some other cause, are not particularly desirable food materials in their natural state, are quite nutritious when cooked or otherwise prepared for consumption. It is also a matter of common experience that well-cooked food is wholesome and appetizing, whereas the same material poorly prepared is unpalatable. There are three chief purposes of cooking; the first is to change the mechanical condition of the food. Heating changes the structure of many food materials very materially, so that they may be more easily chewed and brought into a condition in which the digestive juices can act upon them more freely, and in this way probably influencing the ease and thoroughness of digestion. The second is to make the food more appetizing by improving the appearance or flavour or both. Food which is attractive to the eye and pleasing to the palate quickens the flow of saliva and other digestive juices and thus aids digestion. The third is to kill, by heat, disease germs, parasites or other dangerous organisms that may be contained in food. This is often a very important matter and applies to both animal and vegetable foods. Scrupulous neatness should always be observed in storing, handling and serving food. If ever cleanliness is desirable it must be in the things we eat, and every care should be taken to ensure it for the sake of health as well as of decency. Cleanliness in this connexion means not only absence of visible dirt, but freedom from undesirable bacteria and other minute organisms and from worms and other parasites. If food, raw or cooked, is kept in dirty places, peddled from dirty carts, prepared in dirty rooms and in dirty dishes, or exposed to foul air, disease germs and other offensive and dangerous substances may easily enter it.

9. *Pecuniary Economy of Food*.—Statistics of economy and of cost of living in Great Britain, Germany and the United States show that at least half, and commonly more, of the income of wage-earners and other people in moderate circumstances is expended for subsistence. The relatively large cost of food, and the important influence of diet upon health and strength, make a more widespread understanding of the subject of dietetics very desirable. The maxim that "the best is the cheapest" does not apply to food. The "best" food, in the sense of that which is the finest in appearance and flavour and which is sold at the highest price, is not generally the most economical.

The price of food is not regulated largely by its value for nutriment. Its agreeableness to the palate or to the buyer's fancy is a large factor in determining the current demand and market price. There is no more nutriment in an ounce of protein or fat from the tender-loin of beef than from the round or shoulder. The protein of animal food has, however, some advantage over that of vegetable foods in that it is more thoroughly, and perhaps more easily, digested, for which reason it would be economical to pay somewhat more for the same quantity of nutritive material in the animal food. Furthermore, animal foods such as meats, fish and the like, gratify the palate as most vegetable foods do not. For persons in good health, foods in which the nutrients are the most expensive are like costly articles of adornment. People who can well afford them may be justified in buying them, but they are not economical. The most economical food is that which is at the same time most healthful and cheapest.

The variations in the cost of the actual nutriment in different food materials may be illustrated by comparison of the amounts of nutrients obtained for a given sum in the materials as bought at ordinary market prices. This is done in Table VI., which shows the amounts of available nutrients contained in the quan-

ties of different food materials that may be purchased for one shilling at prices common in England.

When proper attention is given to the needs of the body for food and the relation between cost and nutritive value of food materials, it will be found that with care in the purchase and skill in the preparation of food, considerable control may be had over the expensiveness of a palatable, nutritious and healthful diet.

AUTHORITIES.—COMPOSITION OF FOODS.—König, *Chemie der menschlichen Nahrungs- und Genussmittel*; Atwater and Bryant, "Composition of American Food Materials," Bull. 23, Office of Experiment Stations, U.S. Department of Agriculture. **NUTRITION AND DIETETICS.**—Armsby, *Principles of Animal Nutrition*; Lusk, *The Science of Nutrition*; Burney Yeo, *Food in Health and Disease*; Munk and Uffelmann, *Die Ernährung des gesunden und kranken Menschen*; Von Leyden, *Ernährungstherapie und Diätetik*; Dujardin-Beaumetz, *Hygiène alimentaire*; Hutchison, *Food and Dietetics*; R. H. Chittenden, *Physiological Economy in Nutrition* (1904), *Nutrition of Man* (1907); Atwater, "Chemistry and Economy of Food," Bull. 21, Office of Experiment Stations, U.S. Department of Agriculture. See also other Bulletins of the same office on composition of food, results of dietary studies, metabolism experiments, &c., in the United States. **GENERAL METABOLISM.**—Voit, *Physiologie des allgemeinen Stoffwechsels und der Ernährung*; Hermann, *Handbuch der Physiologie*, Bd. vi.; Von Noorden, *Pathologie des Stoffwechsels*; Schäfer, *Text-Book of Physiology*, vol. i.; Atwater and Langworthy, "Digest of Metabolism Experiments," Bull. 45, Office of Experiment Stations, U.S. Department of Agriculture. (W. O. A.; R. D. M.)

DIETRICH, CHRISTIAN WILHELM ERNST (1712-1774), German painter, was born at Weimar, where he was brought up early to the profession of art by his father Johann George, then painter of miniatures to the court of the duke. Having been sent to Dresden to perfect himself under the care of Alexander Thiele, he had the good fortune to finish in two hours, at the age of eighteen, a picture which attracted the attention of the king of Saxony. Augustus II. was so pleased with Dietrich's readiness of hand that he gave him means to study abroad, and visit in succession the chief cities of Italy and the Netherlands. There he learnt to copy and to imitate masters of the previous century with a versatility truly surprising. Winckelmann, to whom he had been recommended, did not hesitate to call him the Raphael of landscape. Yet in this branch of his practice he merely imitated Salvator Rosa and Everdingen. He was more successful in aping the style of Rembrandt, and numerous examples of this habit may be found in the galleries of St Petersburg, Vienna and Dresden. At Dresden, indeed, there are pictures acknowledged to be his, bearing the fictitious dates of 1636 and 1638, and the name of Rembrandt. Among Dietrich's cleverest reproductions we may account that of Ostade's manner in the "Itinerant Singers" at the National Gallery. His skill in catching the character of the later masters of Holland is shown in candle-light scenes, such as the "Squirrel and the Peep-Show" at St Petersburg, where we are easily reminded of Godfried Schalcken. Dietrich tried every branch of art except portraits, painting Italian and Dutch views alternately with Scripture scenes and still life. In 1741 he was appointed court painter to Augustus III. at Dresden, with an annual salary of 400 thalers (£60), conditional on the production of four cabinet pictures a year. This condition, no doubt, accounts for the presence of fifty-two of the master's panels and canvases in one of the rooms at the Dresden museum. Dietrich, though popular and probably the busiest artist of his time, never produced anything of his own; and his imitations are necessarily inferior to the originals which he affected to copy. His best work is certainly that which he gave to engravings. A collection of these at the British Museum, produced on the general lines of earlier men, such as Ostade and Rembrandt, reveal both spirit and skill. Dietrich, after his return from the Peninsula, generally signed himself "Dietercij," and with this signature most of his extant pictures are inscribed. He died at Dresden, after he had successively filled the important appointments of director of the school of painting at the Meissen porcelain factory and professor of the Dresden academy of arts.

DIETRICH OF BERN, the name given in German popular poetry to Theodoric the Great. The legendary history of Dietrich differs so widely from the life of Theodoric that it has been suggested that the two were originally unconnected. Medieval

chroniclers, however, repeatedly asserted the identity of Dietrich and Theodoric, although the more critical noted the anachronisms involved in making Ermanaric (d. 376) and Attila (d. 453) contemporary with Theodoric (b. 455). That the legend is based on vague historical reminiscences is proved by the retention of the names of Theodoric (Thiuda-reiks, Dietrich) and his father Theudemir (Dietmar), by Dietrich's connexion with Bern (Verona) and Raben (Ravenna). Something of the Gothic king's character descended to Dietrich, familiarly called the Berner, the favourite of German medieval saga heroes, although his story did not leave the same mark on later German literature as did that of the Nibelungs. The cycle of songs connected with his name in South Germany is partially preserved in the *Heldenbuch* (q.v.) in *Dietrich's Flucht*, the *Rabenschlacht* and *Alpharts Tod*; but it was reserved for an Icelandic author, writing in Norway in the 13th century, to compile, with many romantic additions, a consecutive account of Dietrich. In this Norse prose redaction, known as the *Vikina Saga*, or more correctly the *Thidrekssaga*, is incorporated much extraneous matter from the Nibelungen and Wayland legends, in fact practically the whole of south German heroic tradition.

There are traces of a form of the Dietrich legend in which he was represented as starting out from Byzantium, in accordance with historical tradition, for his conquest of Italy. But this early disappeared, and was superseded by the existing legend, in which, perhaps by an "epic fusion" with his father Theudemir, he was associated with Attila, and then by an easy transition with Ermanaric. Dietrich was driven from his kingdom of Bern by his uncle Ermanaric. After years of exile at the court of Attila he returned with a Hunnish army to Italy, and defeated Ermanaric in the Rabenschlacht, or battle of Ravenna. Attila's two sons, with Dietrich's brother, fell in the fight, and Dietrich returned to Attila's court to answer for the death of the young princes. This very improbable renunciation of the advantages of his victory suggests that in the original version of the story the Rabenschlacht was a defeat. In the poem of *Ermenrichs Tod* he is represented as slaying Ermanaric, as in fact Theodoric slew Odoacer. "Otacher" replaces Ermanaric as his adversary in the *Hildebrandslied*, which relates how thirty years after the earlier attempt he reconquered his Lombard kingdom. Dietrich's long residence at Attila's court represents the youth and early manhood of Theodoric spent at the imperial court and fighting in the Balkan peninsula, and, in accordance with epic custom, the period of exile was adorned with war-like exploits, with fights with dragons and giants, most of which had no essential connexion with the cycle. The romantic poems of *König Laurin*, *Sigenot*, *Eckenlied* and *Virginal* are based largely on local traditions originally independent of Dietrich. The court of Attila (Etzel) was a ready bridge to the Nibelungen legend. In the final catastrophe he was at length compelled, after steadily holding aloof from the combat, to avenge the slaughter of his Amelungs by the Burgundians, and delivered Hagen bound into the hands of Kriemhild. The flame breath which anger induced from him shows the influence of pure myth, but the tales of his demonic origin and of his being carried off by the devil in the shape of a black horse may safely be put down to the clerical hostility to Theodoric's Arianism.

Generally speaking, Dietrich of Bern was the wise and just monarch as opposed to Ermanaric, the typical tyrant of Germanic legend. He was invariably represented as slow of provocation and a friend of peace, but once roused to battle not even Siegfried could withstand his onslaught. But probably Dietrich's fight with Siegfried in Kriemhild's rose garden at Worms is a late addition to the Rosengarten myth. The chief heroes of the Dietrich cycle are his tutor and companion in arms, Hildebrand (see HILDEBRAND, LAY OF), with his nephews the Wolfings Alphart and Wolhart; Wittich, who renounced his allegiance to Dietrich and slew the sons of Attila; Heime and Biterolf.

The contents of the poems dealing with the Dietrich cycle are summarized by Uhland in *Schriften zur Geschichte der Dichtung und Sage* (Stuttgart, 1873). The *Thidrekssaga* (ed. C. Unger, Christiania, 1853) is translated into German by F. H. v. der Hagen in *Altdenksagen und altnordische Heldensagen* (vols. i. and ii. 3rd ed., Breslau, 1872).

A summary of it forms the concluding chapter of T. Hodgkin's *Theodoric the Goth* (1891). The variations in the Dietrich legend in the Latin historians, in Old and Middle High German literature, and in the northern saga, can be studied in W. Grimm's *Deutsche Heldensage* (2nd ed., Berlin, 1867). There is a good account in English in F. E. Sandbach's *Heroic Saga-cycle of Dietrich of Bern* (1906), forming No. 15 of Alfred Nutt's *Popular Studies in Mythology*, and another in M. Bentinek Smith's translation of Dr O. L. Jiriczek's *Deutsche Heldensage* (*Northern Legends*, London, 1902). For modern German authorities and commentators see B. Symons, "Deutsche Heldensage" in H. Paul's *Grd. d. german. Phil.* (Strassburg, new ed., 1905); also Goedeke, *Geschichte der deutschen Dichtung* (i. 241-246).

DIEZ, FRIEDRICH CHRISTIAN (1794-1876), German philologist, was born at Giessen, in Hesse-Darmstadt, on the 15th of March 1794. He was educated first at the gymnasium and then at the university of his native town. There he studied classics under Friedrich Gottlieb Welcker (1784-1868) who had just returned from a two years' residence in Italy to fill the chair of archaeology and Greek literature. It was Welcker who kindled in him a love of Italian poetry, and thus gave the first bent to his genius. In 1813 he joined the Hesse corps as a volunteer and served in the French campaign. Next year he returned to his books, and this short taste of military service was the only break in a long and uneventful life of literary labours. By his parents' desire he applied himself for a short time to law, but a visit to Goethe in 1818 gave a new direction to his studies, and determined his future career. Goethe had been reading Raynoudar's *Selections from the Romance Poets*, and advised the young scholar to explore the rich mine of Provençal literature which the French savant had opened up. This advice was eagerly followed, and henceforth Diez devoted himself to Romance literature. He thus became the founder of Romance philology. After supporting himself for some years by private teaching, he removed in 1822 to Bonn, where he held the position of privat-docent. In 1823 he published his first work, *An Introduction to Romance Poetry*; in the following year appeared *The Poetry of the Troubadours*, and in 1829 *The Lives and Works of the Troubadours*. In 1830 he was called to the chair of modern literature. The rest of his life was mainly occupied with the composition of the two great works on which his fame rests, the *Grammar of the Romance Languages* (1836-1844), and the *Lexicon of the Romance Languages—Italian, Spanish and French* (1853); in these two works Diez did for the Romance group of languages what Jacob Grimm did for the Teutonic family. He died at Bonn on the 29th of May 1876.

The earliest French philologists, such as Perion and Henri Estienne, had sought to discover the origin of French in Greek and even in Hebrew. For more than a century Ménage's *Etymological Dictionary* held the field without a rival. Considering the time at which it was written (1650), it was a meritorious work, but philology was then in the empirical stage, and many of Ménage's derivations (such as that of "rat" from the Latin "mus," or of "haricot" from "faba") have since become bywords among philologists. A great advance was made by Raynoudar, who by his critical editions of the works of the Troubadours, published in the first years of the 19th century, laid the foundations on which Diez afterwards built. The difference between Diez's method and that of his predecessors is well stated by him in the preface to his dictionary. In sum it is the difference between science and guess-work. The scientific method is to follow implicitly the discovered principles and rules of phonology, and not to swerve a foot's breadth from them unless plain, actual exceptions shall justify it; to follow the genius of the language, and by cross-questioning to elicit its secrets; to gauge each letter and estimate the value which attaches to it in each position; and lastly to possess the true philosophic spirit which is prepared to welcome any new fact, though it may modify or upset the most cherished theory. Such is the historical method which Diez pursues in his grammar and dictionary. To collect and arrange facts is, as he tells us, the sole secret of his success, and he adds in other words the famous apophthegm of Newton, "hypotheses non fingo." The introduction to the grammar consists of two parts—the first discusses the Latin, Greek and Teutonic elements common to the Romance languages; the second treats of the six dialects separately, their origin and the elements peculiar to each. The grammar itself is divided into four books, on phonology, on flexion, on the formation of words by composition and derivation, and on syntax.

His dictionary is divided into two parts. The first contains words common to two at least of the three principal groups of Romance:—Italian, Spanish and Portuguese, and Provençal and French. The Italian, as nearest the original, is placed at the head of each article.

The second part treats of words peculiar to one group. There is no separate glossary of Wallachian.

Of the introduction to the grammar there is an English translation by C. B. Cayley. The dictionary has been published in a remodelled form for English readers by T. C. Donkin.

DIEZ, a town of Germany, in the Prussian province of Hesse-Nassau, romantically situated in the deep valley of the Lahn, here crossed by an old bridge, 30 m. E. from Coblenz on the railway to Wetzlar. Pop. 4500. It is overlooked by a former castle of the counts of Nassau-Dillenburg, now a prison. Close by, on an eminence above the river, lies the castle of Oranienstein, formerly a Benedictine nunnery and now a cadet school, with beautiful gardens. There are a Roman Catholic and two Evangelical churches. The new part of the town is well built and contains numerous pretty villa residences. In addition to extensive iron-works there are sawmills and tanneries. In the vicinity are Fachingen, celebrated for its mineral waters, and the majestic castle of Schaumburg belonging to the prince of Waldeck-Pyrmont.

DIFFERENCES, CALCULUS OF (*Theory of Finite Differences*), that branch of mathematics which deals with the successive differences of the terms of a series.

1. The most important of the cases to which mathematical methods can be applied are those in which the terms of the series are the values, taken at stated intervals (regular or irregular), of a continuously varying quantity. In these cases the formulæ of finite differences enable certain quantities, whose exact value depends on the law of variation (*i.e.* the law which governs the relative magnitude of these terms) to be calculated, often with great accuracy, from the given terms of the series, without explicit reference to the law of variation itself. The methods used may be extended to cases where the series is a double series (series of double entry), *i.e.* where the value of each term depends on the values of a pair of other quantities.

2. The *first differences* of a series are obtained by subtracting from each term the term immediately preceding it. If these are treated as terms of a new series, the first differences of this series are the *second differences* of the original series; and so on. The successive differences are also called *differences of the first, second, . . . order*. The differences of successive orders are most conveniently arranged in successive columns of a table thus:—

Term.	1st Diff.	2nd Diff.	3rd Diff.	4th Diff.
<i>a</i>	<i>b-a</i>	<i>c-2b+a</i>	<i>d-3c+3b-a</i>	<i>e-4d+6c-4b+a</i>
<i>b</i>	<i>c-b</i>	<i>d-2c+b</i>	<i>e-3d+3c-b</i>	
<i>c</i>	<i>d-c</i>	<i>e-2d+c</i>		
<i>d</i>	<i>e-d</i>			

Algebra of Differences and Sums.

3. The formal relations between the terms of the series and the differences may be seen by comparing the arrangements (A) and (B) in fig. 1. In (A) the various terms and differences are the same as in §2, but placed differently. In

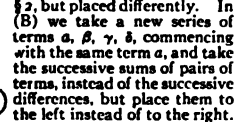
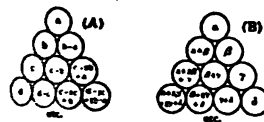

FIG. 1.

in (A), reading downwards to the right, and the successive terms in (B), reading downwards to the left, consist each of a series of terms whose coefficients follow the binomial law; *i.e.* the coefficients in *b-a*, *c-2b+a*, *d-3c+3b-a*, . . . and in *a+2b+γ*, *a+3b+3γ+δ*, . . . are respectively the same as $\gamma-x$, $(\gamma-x)^2$, $(\gamma-x)^3$, . . . and in *x+y*, $(x+y)^2$, $(x+y)^3$, . . . In the second place, it will be seen that the relations between the various terms in (A) are identical with the relations between the similarly placed terms in (B); *e.g.* *b+γ* is the difference of *a+2b+γ* and *a+b*, just as *c-b* is the difference of *c* and *b*; and *d-c* is the sum of *c-b* and *d-2c+b*, just as *b+3γ+δ* is the sum of *b+γ* and *γ+δ*. Hence if we take *β*, *γ*, *δ*, . . . of (B) as being the same as *b-a*, *c-2b+a*, *d-3c+3b-a*, . . . of (A), all corresponding terms in the two diagrams will be the same.

Thus we obtain the two principal formulæ connecting terms and differences. If we provisionally describe *b-a*, *c-2b+a*, . . . as the

first, second, . . . differences of the particular term *a* (§ 7), then (i.) the *n*th difference of *a* is

$$l-nk+\dots+(-1)^n \frac{n \cdot n-1}{1 \cdot 2} c+(-1)^{n+1} nb+(-1)^n a,$$

where *l*, *k*, . . . are the (*n*+1)th, *n*th, . . . terms of the series *a*, *b*, *c*, . . . the coefficients being those of the terms in the expansion of $(y-x)^n$; and (ii.) the (*n*+1)th term of the series, *i.e.* the *n*th term after *a*, is

$$a+n\beta+\frac{n \cdot n-1}{1 \cdot 2} \gamma+\dots$$

where *β*, *γ*, . . . are the first, second, . . . differences of *a*; the coefficients being those of the terms in the expansion of $(x+y)^n$.

4. Now suppose we treat the terms *a*, *b*, *c*, . . . as being themselves the first differences of another series. Then, if the first term of this series is *N*, the subsequent terms are *N+a*, *N+a+b*, *N+a+b+c*, . . .; *i.e.* the difference between the (*n*+1)th term and the first term is the sum of the first *n* terms of the original series. The term *N*, in the diagram (A), will come above and to the left of *a*; and we see, by (ii.) of § 3, that the sum of the first *n* terms of the original series is

$$(N+na+\frac{n \cdot n-1}{1 \cdot 2} \beta+\dots)-N=na+\frac{n \cdot n-1}{1 \cdot 2} \beta+\frac{n \cdot n-1 \cdot n-2}{1 \cdot 2 \cdot 3} \gamma+\dots$$

5. As an example, take the arithmetical series *a*, *a+p*, *a+2p*, . . . The first differences are *p*, *p*, *p*, . . . and the differences of any higher order are zero. Hence, by (ii.) of § 3, the (*n*+1)th term is *a+np*, and, by § 4, the sum of the first *n* terms is $na+\frac{1}{2}n(n-1)p=\frac{1}{2}n(2a+(n-1)p)$.

6. As another example, take the series 1, 2, 3, . . . The first, second and third differences of the first term are 7, 12 and 6; and it may be shown (§ 14 (i)) that all differences of a higher order are zero. Hence the sum of the first *n* terms is

$$n+7 \frac{n \cdot n-1}{1 \cdot 2} +12 \frac{n \cdot n-1 \cdot n-2}{1 \cdot 2 \cdot 3} +6 \frac{n \cdot n-1 \cdot n-2 \cdot n-3}{1 \cdot 2 \cdot 3 \cdot 4}$$

7. In § 3 we have described *b-a*, *c-2b+a*, . . . as the first, second, . . . differences of *a*. This ascription of the differences to particular terms of the series is quite arbitrary. If we read the differences in the table of § 2 upwards to the right instead of downwards to the right, we might describe *e-d*, *e-2d+c*, . . . as the first, second, . . . differences of *e*. On the other hand, the term of greatest weight in *c-2b+a*, *i.e.* the term which has the numerically greatest coefficient, is *b*, and therefore *c-2b+a* might properly be regarded as the second difference of *b*; and similarly *e-4d+6c-4b+a* might be regarded as the fourth difference of *c*. These three methods of regarding the differences lead to three different systems of notation, which are described in §§ 9, 10 and 11.

Notation of Differences and Sums.

8. It is convenient to denote the terms *a*, *b*, *c*, . . . of the series by $u_0, u_1, u_2, u_3, \dots$. If we merely have the terms of the series, u_n may be regarded as meaning the (*n*+1)th term. Usually, however, the terms are the values of a quantity *x*, which is a function of another quantity *x*, and the values of *x*, to which *a*, *b*, *c*, . . . correspond, proceed by a constant difference *h*. If x_0 and u_0 are a pair of corresponding values of *x* and u , and if any other value x_2+mh of *x* and the corresponding value *u* are denoted by x_m and u_m , then the terms of the series will be $\dots u_{-2}, u_{-1}, u_0, u_1, u_2, \dots$, corresponding to values of *x* denoted by $\dots x_{-2}, x_{-1}, x_0, x_1, x_2, \dots$

9. In the *advancing-difference notation* $u_{n+1}-u_n$ is denoted by Δu_n . The differences $\Delta u_0, \Delta u_1, \Delta u_2, \dots$ may then be regarded as values of a function Δu corresponding to values of *x* proceeding by constant difference *h*; and therefore $\Delta u_{n+1}-\Delta u_n$ is denoted by $\Delta^2 u_n$, or, more briefly, $\Delta^2 u$; and so on. Hence the table of differences in § 2, with the corresponding values of *x* and *u* placed opposite each other in the ordinary manner of mathematical tables, becomes

<i>x</i>	<i>u</i>	1st Diff.	2nd Diff.	3rd Diff.	4th Diff.
.
.
.
x_{n-3}	u_{n-3}	Δu_{n-3}	$\Delta^2 u_{n-3}$	$\Delta^3 u_{n-3}$	$\Delta^4 u_{n-3}$
x_{n-1}	u_{n-1}	Δu_{n-1}	$\Delta^2 u_{n-1}$	$\Delta^3 u_{n-1}$	$\Delta^4 u_{n-1}$
x_n	u_n	Δu_n	$\Delta^2 u_n$	$\Delta^3 u_n$	$\Delta^4 u_n$
x_{n+1}	u_{n+1}	Δu_{n+1}	$\Delta^2 u_{n+1}$	$\Delta^3 u_{n+1}$	$\Delta^4 u_{n+1}$
x_{n+3}	u_{n+3}	Δu_{n+3}	$\Delta^2 u_{n+3}$	$\Delta^3 u_{n+3}$	$\Delta^4 u_{n+3}$
.
.

The terms of the series of which $u_{n-1}, u_n, u_{n+1}, \dots$ are the first differences are denoted by Σu , with proper suffixes, so

that this series is . . . $Z_{n-1}, Z_n, Z_{n+1}, \dots$. The suffixes are chosen so that we may have $\Delta Z_n = u_n$, whatever π may be; and therefore (§ 4) Z_n may be regarded as being the sum of the terms of the series up to and including u_{n-1} . Thus if we write $Z_{n-1} = C + u_{n-2}$, where C is any constant, we shall have

$$Z_n = Z_{n-1} + \Delta Z_{n-1} = C + u_{n-1} + u_n,$$

$$Z_{n+1} = C + u_{n-1} + u_n + u_{n+1},$$

and so on. This is true whatever C may be, so that the knowledge of . . . u_{n-1}, u_n, \dots gives us no knowledge of the exact value of Z_n ; in other words, C is an arbitrary constant, the value of which must be supposed to be the same throughout any operations in which we are concerned with values of Z_n corresponding to different suffixes.

There is another symbol E , used in conjunction with u to denote the next term in the series. Thus $E u_n$ means u_{n+1} , so that $E u_n = u_n + \Delta u_n$.

10. Corresponding to the advancing-difference notation there is a *receding-difference* notation, in which $u_{n+1} - u_n$ is regarded as a difference of u_{n+1} , and may be denoted by $\Delta^{-1} u_{n+1}$, and similarly $u_{n+1} - 2u_n + u_{n-1}$ may be denoted by $\Delta^{-2} u_{n+1}$. This notation is only required for certain special purposes, and the usage is not settled (§ 19 (ii)).

11. The *central-difference* notation depends on treating $u_{n+1} - 2u_n + u_{n-1}$ as the second difference of u_n , and therefore as corresponding to the value x_n ; but there is no settled system of notation. The following seems to be the most convenient. Since u_n is a function of x_n , and the second difference $u_{n+1} - 2u_n + u_{n-1}$ is a function of x_{n+1} , the first difference $u_{n+1} - u_n$ must be regarded as a function of x_{n+1} , i.e. of $\frac{1}{2}(x_n + x_{n+1})$. We therefore write $u_{n+1} - u_n = \delta u_{n+1}$, and each difference in the table in § 9 will have the same suffix as the value of x in the same horizontal line; or, if the difference is of an odd order, its suffix will be the means of those of the two nearest values of x . This is shown in the table below.

In this notation, instead of using the symbol E , we use a symbol μ to denote the mean of two consecutive values of u , or of two consecutive differences of the same order, the suffixes being assigned on the same principle as in the case of the differences. Thus

$$\mu u_{n+1} = \frac{1}{2}(u_n + u_{n+1}), \mu \delta u_n = \frac{1}{2}(\delta u_{n-1} + \delta u_{n+1}), \&c.$$

If we take the means of the differences of odd order immediately above and below the horizontal line through any value of x , these means, with the differences of even order in that line, constitute the *central differences* of the corresponding value of x . Thus the table of central differences is as follows, the values obtained as means being placed in brackets to distinguish them from the actual differences:—

x	u	1st Diff.	2nd Diff.	3rd Diff.	4th Diff.
.
.
x_{n-2}	u_{n-2}	$(\mu \delta u_{n-2})$	$\delta^2 u_{n-2}$	$(\mu \delta^3 u_{n-2})$	$\delta^4 u_{n-2}$. . .
.	.	δu_{n-1}	.	$\delta^3 u_{n-1}$.
x_{n-1}	u_{n-1}	$(\mu \delta u_{n-1})$	$\delta^2 u_{n-1}$	$(\mu \delta^3 u_{n-1})$	$\delta^4 u_{n-1}$. . .
.	.	δu_n	.	$\delta^3 u_n$.
x_n	u_n	$(\mu \delta u_n)$	$\delta^2 u_n$	$(\mu \delta^3 u_n)$	$\delta^4 u_n$. . .
.	.	δu_{n+1}	.	$\delta^3 u_{n+1}$.
x_{n+1}	u_{n+1}	$(\mu \delta u_{n+1})$	$\delta^2 u_{n+1}$	$(\mu \delta^3 u_{n+1})$	$\delta^4 u_{n+1}$. . .
.	.	δu_{n+2}	.	$\delta^3 u_{n+2}$.
x_{n+2}	u_{n+2}	$(\mu \delta u_{n+2})$	$\delta^2 u_{n+2}$	$(\mu \delta^3 u_{n+2})$	$\delta^4 u_{n+2}$. . .
.
.

Similarly, by taking the means of consecutive values of u and also of consecutive differences of even order, we should get a series of terms and differences central to the intervals x_{n-2} to x_{n-1} , x_{n-1} to x_n , . . .

The terms of the series of which the values of u are the first differences are denoted by σu , with suffixes on the same principle; the suffixes being chosen so that $\delta \sigma u_n$ shall be equal to u_n . Thus, if

$$\sigma u_{n-1} = C + u_{n-2},$$

then

$$\sigma u_{n-1} = C + u_{n-2} + u_{n-1}, \sigma u_{n+1} = C + u_{n-1} + u_n + u_{n+1}, \&c.,$$

and also

$$\mu \sigma u_{n-1} = C + u_{n-2} + \frac{1}{2} u_{n-1}, \mu \sigma u_n = C + u_{n-2} + u_{n-1} + \frac{1}{2} u_n, \&c.,$$

C being an arbitrary constant which must remain the same throughout any series of operations.

Operators and Symbolic Methods.

12. There are two further stages in the use of the symbols $\Delta, Z, \delta, \sigma, \&c.$, which are not essential for elementary treatment but lead to powerful methods of deduction.

(i.) Instead of treating Δu as a function of x , so that Δu_x means $(\Delta u)_x$, we may regard Δ as denoting an *operation* performed on u , and take Δu_x as meaning Δu_x . This applies to the other symbols

$E, \delta, \&c.$, whether taken simply or in combination. Thus $\Delta E u_x$ means that we first replace u_x by u_{x+1} , and then replace this by $u_{x+1} - u_x$.

(ii.) The operations Δ, E, δ , and μ , whether performed separately or in combination, or in combination also with numerical multipliers and with the operation of differentiation denoted by D ($\frac{d}{dx}$), follow the ordinary rules of algebra: e.g. $\Delta(u_x + v_x) = \Delta u_x + \Delta v_x$, $\Delta \Delta u_x = \Delta^2 u_x$, &c. Hence the symbols can be separated from the functions on which the operations are performed, and treated as if they were algebraical quantities. For instance, we have

$$E u_x = u_{x+1} = u_x + \Delta u_x = 1 \cdot u_x + \Delta u_x,$$

so that we may write $E = 1 + \Delta$, or $\Delta = E - 1$. The first of these is nothing more than a statement, in concise form, that if we take two quantities, subtract the first from the second, and add the result to the first, we get the second. This seems almost a truism. But, if we deduce $E^{-1} = (1 + \Delta)^{-1}$, $\Delta^{-1} = (E - 1)^{-1}$, and expand by the binomial theorem and then operate on u_x , we get the general formulæ

$$u_x = u_0 + \Delta u_0 + \frac{1}{2} \Delta^2 u_0 + \dots + \Delta^n u_0,$$

$$\Delta^{-1} u_x = u_x - \mu u_{x-1} + \frac{1}{2} \mu^2 u_{x-2} + \dots + (-1)^n u_{x-n},$$

which are identical with the formulæ in (ii.) and (i.) of § 3.

(iii.) What has been said under (ii.) applies, with certain reservations, to the operations Z and σ , and to the operation which represents integration. The latter is sometimes denoted by D^{-1} ; and, since $\Delta u_x = u_x - \mu u_{x-1}$, and $\delta \sigma u_x = u_x$, we might similarly replace Z and σ by Δ^{-1} and δ^{-1} . These symbols can be combined with $\Delta, E, \&c.$ according to the ordinary laws of algebra, provided that proper account is taken of the arbitrary constants introduced by the operations $D^{-1}, \Delta^{-1}, \delta^{-1}$.

Applications to Algebraical Series.

13. *Summation of Series.*—If u_r denotes the $(r+1)$ th term of a series, and if σ_r is a function of r such that $\Delta \sigma_r = u_r$, for all integral values of r , then the sum of the terms $u_0, u_1, u_2, \dots, u_n$ is $\sigma_{n+1} - \sigma_0$. Thus the sum of a number of terms of a series may often be found by inspection, in the same kind of way that an integral is found.

14. *Rational Integral Functions.*—(i.) If u_x is a rational integral function of r of degree p , then Δu_x is a rational integral function of r of degree $p-1$.

(ii.) A particular case is that of a *factorial*, i.e. a product of the form $(r-a+1)(r-a+2) \dots (r+b)$, each factor exceeding the preceding factor by 1. We have

$$\Delta (r+a+1)(r+a+2) \dots (r+b) = (b-a)(r+a+2) \dots (r+b),$$

whence, changing a into $a-1$,

$$Z(r+a+1)(r+a+2) \dots (r+b) = \text{const.} + (r+a)(r+a+1) \dots (r+b)/(b-a+1).$$

A similar method can be applied to the series whose $(r+1)$ th term is of the form $1/(r+a+1)(r+a+2) \dots (r+b)$.

(iii.) Any rational integral function can be converted into the sum of a number of factorials; and thus the sum of a series of which such a function is the general term can be found. For example, it may be shown in this way that the sum of the p th powers of the first n natural numbers is a rational integral function of n of degree $p+1$, the coefficient of n^{p+1} being $1/(p+1)$.

15. *Difference-equations.*—The summation of the series . . . $+u_{n-1} + u_n + u_{n+1}$ is a solution of the *difference-equation* $\Delta u_x = u_{x+1}$, which may also be written $(E-1)u_x = u_{x+1}$. This is a simple form of difference-equation. There are several forms which have been investigated; a simple form, more general than the above, is the *linear equation with constant coefficients*—

$$p_0 u_n + a_1 u_{n-1} + a_2 u_{n-2} + \dots + a_n u_0 = N,$$

where a_1, a_2, \dots, a_n are constants, and N is a given function of n . This may be written

$$(E^n + a_1 E^{n-1} + \dots + a_n) u_n = N$$

or

$$(E - p_1)(E - p_2) \dots (E - p_n) u_n = N.$$

The solution, if p_1, p_2, \dots, p_n are all different, is $u_n = C_1 p_1^n + C_2 p_2^n + \dots + C_n p_n^n + V_n$, where C_1, C_2, \dots, C_n are constants, and $u_n = V_n$ is any one solution of the equation. The method of finding a value for V_n depends on the form of N . Certain modifications are required when two or more of the p 's are equal.

It should be observed, in all cases of this kind, that, in describing C_1, C_2 as "constants," it is meant that the value of any one, as C_1 , is the same for all values of n occurring in the series. A "constant" may, however, be a periodic function of n .

Applications to Continuous Functions.

16. The cases of greatest practical importance are those in which u is a continuous function of x . The terms u_0, u_1, \dots of the series then represent the successive values of u corresponding to $x = x_0, x_1, \dots$. The important applications of the theory in these cases are to (i.) relations between differences and differential coefficients. (ii.)

interpolation, or the determination of intermediate values of u , and (iii) relations between sums and integrals.

17. Starting from any pair of values u_0 and u_1 , we may suppose the interval h from x_0 to x_1 to be divided into q equal portions. If we suppose the corresponding values of u to be obtained, and their differences taken, the successive advancing differences of u_0 being denoted by $\delta u_0, \delta^2 u_0, \dots$, we have (§ 3 (ii))

$$u_1 = u_0 + q\delta u_0 + \frac{q \cdot q - 1}{1 \cdot 2} \delta^2 u_0 + \dots$$

When q is made indefinitely great, this (writing $f(x)$ for u) becomes Taylor's Theorem (INFINITESIMAL CALCULUS)

$$f(x+h) = f(x) + hf'(x) + \frac{h^2}{2} f''(x) + \dots$$

which, expressed in terms of operators, is

$$E = 1 + hD + \frac{h^2}{1 \cdot 2} D^2 + \frac{h^3}{1 \cdot 2 \cdot 3} D^3 + \dots = e^{hD}$$

This gives the relation between Δ and D . Also we have

$$u_1 = u_0 + 2q\delta u_0 + \frac{2q \cdot 2q - 1}{1 \cdot 2} \delta^2 u_0 + \dots$$

$$u_2 = u_0 + 3q^2 \delta u_0 + \frac{3q \cdot 3q - 1}{1 \cdot 2} \delta^2 u_0 + \dots$$

and, if p is any integer,

$$u_{p+1} = u_0 + p\delta u_0 + \frac{p \cdot p - 1}{1 \cdot 2} \delta^2 u_0 + \dots$$

From these equations u_n could be expressed in terms of $u_0, \delta u_0, \delta^2 u_0, \dots$: this is a particular case of interpolation ($q.n.$).

18. Differences and Differential Coefficients.—The various formulae are most quickly obtained by symbolical methods; i.e. by dealing with the operators Δ, E, D, \dots as if they were algebraical quantities. Thus the relation $E = e^{hD}$ (§ 17) gives

$$hD = \log_e(1 + \Delta) = \Delta - \frac{1}{2}\Delta^2 + \frac{1}{3}\Delta^3 - \dots$$

or $h \left(\frac{du}{dx} \right)_0 = \Delta u_0 - \frac{1}{2}\Delta^2 u_0 + \frac{1}{3}\Delta^3 u_0 - \dots$

The formulae connecting central differences with differential coefficients are based on the relations $\mu = \cosh \frac{1}{2}hD = \frac{1}{2}(e^{\frac{1}{2}hD} + e^{-\frac{1}{2}hD})$, $\delta = 2 \sinh \frac{1}{2}hD = e^{\frac{1}{2}hD} - e^{-\frac{1}{2}hD}$, and may be grouped as follows:—

$$\left. \begin{aligned} u_0 &= u_0 \\ \mu^2 u_0 &= (h^2 D^2 + \frac{1}{2} h^4 D^4 + \frac{1}{24} h^6 D^6 + \dots) u_0 \\ \delta^2 u_0 &= (h^2 D^2 + \frac{1}{3} h^4 D^4 + \frac{1}{6} h^6 D^6 + \dots) u_0 \\ \mu^4 u_0 &= (h^4 D^4 + \frac{1}{2} h^6 D^6 + \dots) u_0 \\ \delta^4 u_0 &= (h^4 D^4 + \frac{1}{3} h^6 D^6 + \dots) u_0 \end{aligned} \right\}$$

$$\left. \begin{aligned} \mu u_1 &= (1 + \frac{1}{2} h^2 D^2 + \frac{1}{24} h^4 D^4 + \frac{1}{720} h^6 D^6 + \dots) u_1 \\ \delta u_1 &= (h + \frac{1}{6} h^3 D^2 + \frac{1}{120} h^5 D^4 + \dots) u_1 \\ \mu^3 u_1 &= (h^2 D^2 + \frac{1}{3} h^4 D^4 + \frac{1}{6} h^6 D^6 + \dots) u_1 \\ \delta^3 u_1 &= (h^3 D^3 + \frac{1}{2} h^5 D^5 + \dots) u_1 \end{aligned} \right\}$$

$$\left. \begin{aligned} \mu u_2 &= u_2 \\ h^2 D^2 u_2 &= (\delta^2 - \frac{1}{2} \delta^4 \mu^2 + \frac{1}{24} \delta^6 \mu^4 - \dots) u_2 \\ h^4 D^4 u_2 &= (\delta^4 - \frac{1}{3} \delta^6 \mu^2 + \frac{1}{6} \delta^8 \mu^4 - \dots) u_2 \\ h^6 D^6 u_2 &= (\delta^6 - \frac{1}{2} \delta^8 \mu^2 + \dots) u_2 \end{aligned} \right\}$$

$$\left. \begin{aligned} \mu u_3 &= (\mu - \frac{1}{2} \delta^2 \mu^3 + \frac{1}{24} \delta^4 \mu^5 - \frac{1}{720} \delta^6 \mu^7 + \dots) u_3 \\ h^2 D^2 u_3 &= (\delta^2 - \frac{1}{6} \delta^4 \mu^2 + \frac{1}{120} \delta^6 \mu^4 - \dots) u_3 \\ h^4 D^4 u_3 &= (\delta^4 - \frac{1}{3} \delta^6 \mu^2 + \frac{1}{6} \delta^8 \mu^4 - \dots) u_3 \\ h^6 D^6 u_3 &= (\delta^6 - \frac{1}{2} \delta^8 \mu^2 + \dots) u_3 \end{aligned} \right\}$$

When u is a rational integral function of x , each of the above series is a terminating series. In other cases the series will be an infinite one, and may be divergent; but it may be used for purposes of approximation up to a certain point, and there will be a "remainder," the limits of whose magnitude will be determinate.

19. Sums and Integrals.—The relation between a sum and an integral is usually expressed by the Euler-Maclaurin formula. The principle of this formula is that, if u_n and u_{n+1} are ordinates of a curve, distant h from one another, then for a first approximation to the area of the curve between u_n and u_{n+1} we have $\frac{1}{2}h(u_n + u_{n+1})$

and the difference between this and the true value of the area can be expressed as the difference of two expressions, one of which is a function of x_{n+1} and the other is the same function of x_{n+1} . Denoting these by $\phi(x_n)$ and $\phi(x_{n+1})$, we have

$$\int_{x_n}^{x_{n+1}} u dx = \frac{1}{2}h(u_n + u_{n+1}) + \phi(x_{n+1}) - \phi(x_n)$$

Adding a series of similar expressions, we find

$$\int_{x_0}^{x_n} u dx = h \left\{ \frac{1}{2}u_0 + u_1 + u_2 + \dots + u_{n-1} + \frac{1}{2}u_n \right\} + \phi(x_n) - \phi(x_0)$$

The function $\phi(x)$ can be expressed in terms either of differential coefficients of u or of advancing or central differences; thus there are three formulae.

(i.) The Euler-Maclaurin formula, properly so called, (due independently to Euler and Maclaurin) is

$$\int_{x_0}^{x_n} u dx = h \mu u_0 - \frac{1}{2} h^2 \frac{d^2 u_0}{dx^2} + \frac{1}{6} h^3 \frac{d^3 u_0}{dx^3} - \frac{1}{30} h^5 \frac{d^5 u_0}{dx^5} + \dots = h \mu u_0 - \frac{B_2}{2!} h^2 \frac{d^2 u_0}{dx^2} + \frac{B_4}{4!} h^4 \frac{d^4 u_0}{dx^4} - \frac{B_6}{6!} h^6 \frac{d^6 u_0}{dx^6} + \dots$$

where B_1, B_2, B_3, \dots are Bernoulli's numbers.

(ii.) If we express differential coefficients in terms of advancing differences, we get a theorem which is due to Laplace:—

$$\frac{1}{h} \int_{x_0}^{x_n} u dx = \mu \sigma(u_n - u_0) - \frac{1}{2} \delta(u_n - \Delta u_n) + \frac{1}{6} \delta^2(u_n - \Delta^2 u_n) - \frac{1}{24} \delta^3(u_n - \Delta^3 u_n) + \dots$$

For practical calculations this may more conveniently be written

$$\frac{1}{h} \int_{x_0}^{x_n} u dx = \mu \sigma(u_n - u_0) + \frac{1}{2} \delta(u_n - \frac{1}{2} \Delta u_n + \frac{1}{6} \Delta^2 u_n - \dots) + \frac{1}{24} \delta^2(u_n - \frac{1}{2} \Delta^2 u_n + \frac{1}{6} \Delta^3 u_n - \dots)$$

where accented differences denote that the values of u are read backwards from u_n ; i.e. $\Delta' u_n$ denotes $u_{n-1} - u_n$, not (as in § 10) $u_n - u_{n-1}$.

(iii.) Expressed in terms of central differences this becomes

$$\frac{1}{h} \int_{x_0}^{x_n} u dx = \mu \sigma(u_n - u_0) - \frac{1}{24} \delta^2 u_n + \frac{1}{720} \delta^4 u_n - \frac{1}{30240} \delta^6 u_n + \dots = \mu(\sigma - \frac{1}{24} \delta^2 + \frac{1}{720} \delta^4 - \frac{1}{30240} \delta^6 + \dots)(u_n - u_0)$$

(iv.) There are various forms of these formulae, due to taking $h u_{n+1}$ as the first approximation to the area of the curve between u_n and u_{n+1} ; the formulae involve the sum $u_1 + u_2 + \dots + u_{n-1}$ or $(u_n - u_0)$ (see MENSURATION).

20. The formulae in the last section can be obtained by symbolical methods from the relation

$$\frac{1}{h} \int u dx = \frac{1}{h} D^{-1} u = \frac{1}{hD} u$$

Thus for central differences, if we write $\theta = \frac{1}{2}hD$, we have $\mu = \cosh \theta$, $\delta = 2 \sinh \theta$, $\sigma = \delta^{-1}$, and the result in (iii.) corresponds to the formula

$$\sinh \theta = \theta \cosh \theta \left(1 + \frac{1}{6} \sinh^2 \theta - \frac{1}{120} \sinh^4 \theta + \frac{1}{5040} \sinh^6 \theta - \dots \right)$$

REFERENCES.—There is no recent English work on the theory of finite differences as a whole. G. Boole's *Finite Differences* (1st ed., 1860, 2nd ed., edited by J. F. Moulton, 1872) is a comprehensive treatise, in which symbolical methods are employed very early. A. A. Markoff's *Differenzrechnung* (German trans., 1896) contains general formulae. (Both these works ignore central differences.) *Encycl. der math. Wiss.* vol. i. pt. 2, pp. 919-935, may also be consulted. An elementary treatment of the subject will be found in many text-books, e.g. G. Chrystal's *Algebra* (pt. 2, ch. xxxi.), A. W. Sunderland, *Notes on Finite Differences* (1895), is intended for actual students. Various central-difference formulae with references are given in *Proc. Lond. Math. Soc.* xxxi. pp. 440-488. For other references see INTERPOLATION. (W. F. SH.)

DIFFERENTIAL EQUATION, in mathematics, a relation between one or more functions and their differential coefficients. The subject is treated here in two parts: (i) an elementary introduction dealing with the more commonly recognized types of differential equations which can be solved by rule; and (ii) the general theory.

Part I.—Elementary Introduction.

Of equations involving only one independent variable, x (known as ordinary differential equations), and one dependent variable, y , and containing only the first differential coefficient dy/dx (and therefore said to be of the first order), the simplest form is that reducible to the type

$$dy/dx = f(x)/F(y),$$

leading to the result $\int F(y)dy - \int f(x)dx = A$, where A is an arbitrary constant; this result is said to solve the differential equation, the problem of evaluating the integrals belonging to the integral calculus.

Another simple form is

$$dy/dx + yP = Q,$$

where P, Q are functions of x only; this is known as the linear equation, since it contains y and dy/dx only to the first degree. If $fPdx = u$, we clearly have

$$\frac{d}{dx}(ye^{xP}) = e^{xP}(dy/dx + Py) = e^{xP}Q,$$

so that $y = e^{-xP}(\int e^{xP}Qdx + A)$ solves the equation, and is the only possible solution, A being an arbitrary constant. The rule for the solution of the linear equation is thus to multiply the equation by e^x , where $u = \int Pdx$.

A third simple and important form is that denoted by

$$y = px + f(p),$$

where p is an abbreviation for dy/dx ; this is known as Clairaut's form. By differentiation in regard to x it gives

$$p = p + x \frac{dp}{dx} + f'(p) \frac{dp}{dx}$$

where

$$f'(p) = \frac{d}{dp}f(p);$$

thus, either (i) $\frac{dp}{dx} = 0$, that is, p is constant on the curve satisfying the differential equation, which curve is thus any one of the straight lines $y = cx + f(c)$, where c is an arbitrary constant, or else, (ii) $x + f'(p) = 0$; if this latter hypothesis is taken, and p be eliminated between $x + f'(p) = 0$ and $y = px + f(p)$, a relation connecting x and y , not containing an arbitrary constant, will be found, which obviously represents the envelope of the straight lines $y = cx + f(c)$.

In general if a differential equation $\phi(x, y, dy/dx) = 0$ be satisfied by any one of the curves $F(x, y, c) = 0$, where c is an arbitrary constant, it is clear that the envelope of these curves, when existent, must also satisfy the differential equation; for this equation prescribes a relation connecting only the co-ordinates x, y and the differential coefficient dy/dx , and these three quantities are the same at any point of the envelope for the envelope and for the particular curve of the family which there touches the envelope. The relation expressing the equation of the envelope is called a singular solution of the differential equation, meaning an isolated solution, as not being one of a family of curves depending upon an arbitrary parameter.

An extended form of Clairaut's equation expressed by

$$y = xF(p) + f(p)$$

may be similarly solved by first differentiating in regard to p , when it reduces to a linear equation of which x is the dependent and p the independent variable; from the integral of this linear equation, and the original differential equation, the quantity p is then to be eliminated.

Other types of solvable differential equations of the first order are (1)

$$Mdy/dx = N,$$

where M, N are homogeneous polynomials in x and y , of the same order; by putting $v = y/x$ and eliminating y , the equation becomes of the first type considered above, in v and x . An equation $(aB \pm bA)$

$$(ax + by + c)dy/dx = Ax + By + C$$

may be reduced to this rule by first putting $x + h, y + k$ for x and y , and determining h, k so that $ah + bk + c = 0, Aa + Bb + C = 0$.

(2) An equation in which y does not explicitly occur,

$$f(x, dy/dx) = 0,$$

may, theoretically, be reduced to the type $dy/dx = F(x)$; similarly an equation $F(y, dy/dx) = 0$.

(3) An equation

$$f(dy/dx, x, y) = 0,$$

which is an integral polynomial in dy/dx , may, theoretically, be solved for dy/dx , as an algebraic equation; to any root $dy/dx = F_1(x, y)$ corresponds, suppose, a solution $\phi_1(x, y, c) = 0$, where c is an arbitrary constant; the product equation $\phi_1(x, y, c)\phi_2(x, y, c) \dots = 0$, consisting of as many factors as there were values of dy/dx , is effectively as general as if we wrote $\phi_1(x, y, c_1)\phi_2(x, y, c_2) \dots = 0$; for, to evaluate the first form, we must necessarily consider the factors separately, and nothing is then gained by the multiple notation for the various arbitrary constants. The equation $\phi_1(x, y, c_1)\phi_2(x, y, c_2) \dots = 0$ is thus the solution of the given differential equation.

In all these cases there is, except for cases of singular solutions, one and only one arbitrary constant in the most general solution of the differential equation; that this must necessarily be so we may take as obvious, the differential equation being supposed to arise by elimination of this constant from the equation expressing its solution and the equation obtainable from this by differentiation in regard to x .

A further type of differential equation of the first order, of the form

$$dy/dx = A + By + Cy^2$$

in which A, B, C are functions of x , will be briefly considered below under differential equations of the second order.

When we pass to ordinary differential equations of the second order, that is, those expressing a relation between $x, y, dy/dx$ and d^2y/dx^2 ,

the number of types for which the solution can be found by a known procedure is very considerably reduced. Consider the general linear equation

$$P_2 \frac{d^2y}{dx^2} + P_1 \frac{dy}{dx} + Q_2 y = R,$$

where P, Q, R are functions of x only. There is no method always effective; the main general result for such a linear equation is that if any particular function of x , say y_1 , can be discovered, for which

$$\frac{d^2y_1}{dx^2} + P_1 \frac{dy_1}{dx} + Q_2 y_1 = 0,$$

then the substitution $y = y_1 v$ in the original equation, with R on the right side, reduces this to a linear equation of the first order with the dependent variable dv/dx . In fact, if $y = y_1 v$ we have

$$\frac{d^2y}{dx^2} = y_1 \frac{d^2v}{dx^2} + 2 \frac{dy_1}{dx} \frac{dv}{dx} + v \frac{d^2y_1}{dx^2},$$

and thus

$$\frac{d^2y}{dx^2} + P_1 \frac{dy}{dx} + Q_2 y = y_1 \frac{d^2v}{dx^2} + (2 \frac{dy_1}{dx} + P_1 y_1) \frac{dv}{dx} + (\frac{d^2y_1}{dx^2} + P_1 \frac{dy_1}{dx} + Q_2 y_1) v;$$

if then

$$\frac{d^2y_1}{dx^2} + P_1 \frac{dy_1}{dx} + Q_2 y_1 = 0,$$

and s denote dv/dx , the original differential equation becomes

$$y_1 \frac{ds}{dx} + (2 \frac{dy_1}{dx} + P_1 y_1) s = R.$$

From this equation s can be found by the rule given above for the linear equation of the first order, and will involve one arbitrary constant; thence $y = y_1 v = y_1 \int s dx + A y_1$, where A is another arbitrary constant, will be the general solution of the original equation, and, as was to be expected, involves two arbitrary constants.

The case of most frequent occurrence is that in which the coefficients P, Q are constants; we consider this case in some detail. If θ be a root of the quadratic equation $\theta^2 + P\theta + Q = 0$, it can be at once seen that a particular integral of the differential equation with zero on the right side is $y_1 = e^{-\theta x}$. Supposing first the roots of the quadratic equation to be different, and ϕ to be the other root, so that $\phi + \theta = -P$, the auxiliary differential equation for s , referred to above, becomes $\frac{ds}{dx} + (\theta - \phi) s = R e^{-\theta x}$, which leads to $ss^{(\theta-\phi)} = B + \int R e^{-\theta x} dx$,

where B is an arbitrary constant, and hence to

$$y = A e^{-\theta x} + e^{-\phi x} \int B e^{(\theta-\phi)x} dx + e^{-\phi x} \int R e^{-\theta x} dx dx,$$

or say to $y = A e^{-\theta x} + C e^{-\phi x} + U$, where A, C are arbitrary constants and U is a function of x , not present at all when $R = 0$. If the quadratic equation $\theta^2 + P\theta + Q = 0$ has equal roots, so that $2\theta = -P$, the auxiliary equation in s becomes $ds/dx = R e^{-\theta x}$, giving $s = B + \int R e^{-\theta x} dx$, where B is an arbitrary constant, and hence

$$y = (A + Bx) e^{-\theta x} + \int \int R e^{-\theta x} dx dx,$$

or, say, $y = (A + Bx) e^{-\theta x} + U$, where A, B are arbitrary constants, and U is a function of x , not present at all when $R = 0$. The portion $A e^{-\theta x} + B e^{-\theta x}$ or $(A + Bx) e^{-\theta x}$ of the solution, which is known as the complementary function, can clearly be written down at once by inspection of the given differential equation. The remaining portion U may, by taking the constants in the complementary function properly, be replaced by any particular solution whatever of the differential equation

$$\frac{d^2y}{dx^2} + P_1 \frac{dy}{dx} + Q_2 y = R;$$

for if u be any particular solution, this has a form

$$u = A_0 e^{\theta_0 x} + B_0 e^{\phi_0 x} + U,$$

or a form

$$u = (A_0 + B_0 x) e^{\theta_0 x} + U;$$

thus the general solution can be written

$$(A - A_0) e^{\theta_0 x} + (B - B_0) e^{\phi_0 x} + u, \text{ or } (A - A_0 + (B - B_0)x) e^{\theta_0 x} + u,$$

where $A - A_0, B - B_0$, like A, B, are arbitrary constants. A similar result holds for a linear differential equation of any order, say

$$\frac{d^2y}{dx^2} + P_1 \frac{d^{n-1}y}{dx^{n-1}} + \dots + P_n y = R,$$

where P_1, P_2, \dots, P_n are constants, and R is a function of x . If we form the algebraic equation $\theta^n + P_1 \theta^{n-1} + \dots + P_n = 0$, and all the roots of this equation be different, say they are $\theta_1, \theta_2, \dots, \theta_n$, the general solution of the differential equation is

$$y = A_1 e^{\theta_1 x} + A_2 e^{\theta_2 x} + \dots + A_n e^{\theta_n x} + u,$$

where A_1, A_2, \dots, A_n are arbitrary constants, and u is any

particular solution whatever; but if there be one root θ_1 repeated r times, the terms $A_1 e^{\theta_1 x} + \dots + A_r e^{\theta_1 x}$ must be replaced by $(A_1 + A_2 x + \dots + A_r x^{r-1}) e^{\theta_1 x}$ where A_1, \dots, A_r are arbitrary constants; the remaining terms in the complementary function will similarly need alteration of form if there be other repeated roots.

To complete the solution of the differential equation we need some method of determining a particular integral u ; we explain a procedure which is effective for this purpose in the cases in which R is a sum of terms of the form $e^{ax} \phi(x)$, where $\phi(x)$ is an integral polynomial in x ; this includes cases in which R contains terms of the form $\cos bx \cdot \phi(x)$ or $\sin bx \cdot \phi(x)$. Denote d/dx by D ; it is clear that if u be any function of x , $D(e^{ax}u) = e^{ax}Du + ae^{ax}u$, or say, $D(e^{ax}u) = e^{ax}(D+a)u$; hence $D^2(e^{ax}u)$, i.e. $\frac{d^2}{dx^2}(e^{ax}u)$, being equal to $D(e^{ax}u)$, where $v = (D+a)u$, is equal to $e^{ax}(D+a)v$, that is to $e^{ax}(D+a)^2u$. In this way we find $D^n(e^{ax}u) = e^{ax}(D+a)^n u$, where n is any positive integer. Hence if $\psi(D)$ be any polynomial in D with constant coefficients, $\psi(D)(e^{ax}u) = e^{ax}\psi(D+a)u$. Next, denoting $\int u dx$ by

$D^{-1}u$, and any solution of the differential equation $\frac{d^2 u}{dx^2} + a_1 \frac{du}{dx} + a_2 u = s$ by $u = (D+a)^{-2} s$, we have $D(e^{ax}(D+a)^{-2} u) = D(e^{ax}u) = e^{ax}(D+a)u = e^{ax}u$, so that we may write $D^{-1}(e^{ax}u) = e^{ax}(D+a)^{-1}u$, where the meaning is that one value of the left side is equal to one value of the right side; from this, the expression $D^{-2}(e^{ax}u)$, which means $D^{-1}[D^{-1}(e^{ax}u)]$, is equal to $D^{-1}(e^{ax}u)$ and hence to $e^{ax}(D+a)^{-1}u$, which we write $e^{ax}(D+a)^{-1}u$; proceeding thus we obtain

$$D^{-n}(e^{ax}u) = e^{ax}(D+a)^{-n}u,$$

where n is any positive integer, and the meaning, as before, is that one value of the first expression is equal to one value of the second. More generally, if $\psi(D)$ be any polynomial in D with constant coefficients, and we agree to denote by $\psi(D)^{-1}u$ any solution s of the

differential equation $\psi(D)s = u$, we have, if $\theta = \frac{1}{\psi(D+a)}$, the identity $\psi(D)(e^{ax}u) = e^{ax}\psi(D+a)u = e^{ax}u$, which we write in the form

$$\psi(D)^{-1}(e^{ax}u) = e^{ax}\psi(D+a)^{-1}u.$$

This gives us the first step in the method we are explaining, namely that a solution of the differential equation $\psi(D)y = e^{ax}u + e^{bx}v + \dots$ where u, v, \dots are any functions of x , is any function denoted by the expression

$$e^{ax}\psi(D+a)^{-1}u + e^{bx}\psi(D+b)^{-1}v + \dots$$

It is now to be shown how to obtain one value of $\psi(D+a)^{-1}u$, when u is a polynomial in x , namely one solution of the differential equation $\psi(D+a)s = u$. Let the highest power of x entering in u be x^m ; if t were a variable quantity, the rational fraction in t , $\frac{1}{\psi(t+a)}$, by first writing it as a sum of partial fractions, or otherwise, could be identically $K_0 + K_1 t^{-1} + \dots + K_r t^{-r} + H + H_1 t + \dots + H_m t^m + f^{(l)}(t)/\psi(t+a)$, where $f(t)$ is a polynomial in t ; this shows that there exists an identity of the form

$$1 = f(t+a)(K_0 t^{-1} + \dots + K_r t^{-r} + H + H_1 t + \dots + H_m t^m) + \phi(t) f^{(l)},$$

and hence an identity

$$u = \psi(D+a)(K_0 D^{-1} + \dots + K_r D^{-r} + H + H_1 D + \dots + H_m D^m)u + \phi(D)D^{-l}u;$$

in this, since u contains no power of x higher than x^m , the second term on the right may be omitted. We thus reach the conclusion that a solution of the differential equation $\psi(D+a)s = u$ is given by

$$s = (K_0 D^{-1} + \dots + K_r D^{-r} + H + H_1 D + \dots + H_m D^m)u,$$

of which the operator on the right is obtained simply by expanding $1/\psi(D+a)$ in ascending powers of D , as if D were a numerical quantity, the expansion being carried as far as the highest power of D which, operating upon u , does not give zero. In this form every term in s is capable of immediate calculation.

Example.—For the equation

$$\frac{d^2 y}{dx^2} + 2 \frac{dy}{dx} + y = x^2 \cos x \text{ or } (D^2 + 1)^2 y = x^2 \cos x,$$

the roots of the associated algebraic equation $(\theta^2 + 1)^2 = 0$ are $\theta = \pm i$, each repeated; the complementary function is thus

$$(A + Bx)e^{ix} + (C + Dx)e^{-ix},$$

where A, B, C, D are arbitrary constants; this is the same as

$$(H + Kx) \cos x + (M + Nx) \sin x,$$

where H, K, M, N are arbitrary constants. To obtain a particular integral we must find a value of $(1 + D^2)^{-2} x^2 \cos x$; this is the real

part of $(1 + D^2)^{-2} e^{ix} x^2$ and hence of $e^{ix} [1 + (D+i)^2]^{-2} x^2$

$$\text{or } \frac{e^{ix} x^2 D(1 - \frac{1}{2} D)^{-2}}{-\frac{1}{2} e^{ix} D^{-2} (1 + iD - \frac{1}{2} D^2 - \frac{1}{2} D^2 + \frac{1}{2} D^2 + \frac{1}{2} D^2 \dots) x^2,$$

$$\text{or } -\frac{1}{2} e^{ix} (x^2 + \frac{1}{2} x^2 - \frac{1}{2} x^2 - \frac{1}{2} x^2 + \frac{1}{2} x^2 + \frac{1}{2} x^2);$$

the real part of this is

$$-\frac{1}{2} (x^2 x^2 - \frac{1}{2} x^2 + \frac{1}{2} x^2) \cos x + \frac{1}{2} (\frac{1}{2} x^2 - \frac{1}{2} x^2 + \frac{1}{2} x^2) \sin x.$$

This expression added to the complementary function found above gives the complete integral; and no generality is lost by omitting from the particular integral the terms $-\frac{1}{2} x^2 \cos x + \frac{1}{2} x^2 \sin x$, which are of the types of terms already occurring in the complementary function.

The symbolical method which has been explained has wider applications than that to which we have, for simplicity of explanation, restricted it. For example, if $\psi(x)$ be any function of x , and a_1, a_2, \dots, a_n be different constants, and $\{(t+a_1)(t+a_2)\dots(t+a_n)\}^{-1}$ when expressed in partial fractions be written $Z_m(t+a_m)^{-1}$, a particular integral of the differential equation $\psi(D)(D+a_1)(D+a_2)\dots(D+a_n)y = \psi(x)$ is given by

$$y = Z_m(D+a_m)^{-1} \psi(x) = Z_m(D+a_m)^{-1} e^{-a_m x} e^{a_m x} \psi(x) =$$

$$Z_m e^{-a_m x} D^{-1} (e^{a_m x} \psi(x)) = Z_m e^{-a_m x} \int e^{a_m x} \psi(x) dx.$$

The particular integral is thus expressed as a sum of n integrals.

A linear differential equation of which the left side has the form

$$x \frac{d^2 y}{dx^2} + P_1 x \frac{dy}{dx} + P_2 y = Q,$$

where P_1, \dots, P_n are constants, can be reduced to the case considered above. Writing $x = e^t$ we have the identity

$$x \frac{d^2 y}{dx^2} = \theta(\theta-1)(\theta-2)\dots(\theta-n+1) y, \text{ where } \theta = d/dt.$$

When the linear differential equation, which we take to be of the second order, has variable coefficients, though there is no general rule for obtaining a solution in finite terms, there are some results which it is of advantage to have in mind. We have seen that if one solution of the equation obtained by putting the right side zero, say y_1 , be known, the equation can be solved. If y_2 be another solution of

$$\frac{d^2 y}{dx^2} + P \frac{dy}{dx} + Qy = 0,$$

there being no relation of the form $\mu y_1 + \nu y_2 = k$, where m, n, k are constants, it is easy to see that

$$\frac{d}{dx} (y_1' y_2 - y_2' y_1) = P (y_1' y_2 - y_2' y_1),$$

so that we have $y_1' y_2 - y_2' y_1 = A \exp. \left(\int P dx \right)$,

where A is a suitably chosen constant, and $\exp. s$ denotes e^s . In terms of the two solutions y_1, y_2 of the differential equation having zero on the right side, the general solution of the equation with $R = \phi(x)$ on the right side can at once be verified to be $A y_1 + B y_2 + y_1 u - y_2 v$, where u, v respectively denote the integrals

$$u = \int y_2 \phi(x) (y_1' y_2 - y_2' y_1)^{-1} dx, \quad v = \int y_1 \phi(x) (y_1' y_2 - y_2' y_1)^{-1} dx.$$

The equation

$$\frac{d^2 y}{dx^2} + P \frac{dy}{dx} + Qy = 0,$$

by writing $y = v \exp. \left(-\frac{1}{2} \int P dx \right)$, is at once seen to be reduced to

$$\frac{d^2 v}{dx^2} + Iv = 0, \text{ where } I = Q - \frac{1}{4} P^2 - \frac{1}{2} P'. \text{ If } \eta = -\frac{1}{2} \frac{dy}{dx}, \text{ the equation}$$

$\frac{d^2 v}{dx^2} + Iv = 0$ becomes $\frac{d^2 \eta}{dx^2} = 1 + \eta^2$, a non-linear equation of the first order.

More generally the equation

$$\frac{d^2 \eta}{dx^2} = A + B\eta + C\eta^2,$$

where A, B, C are functions of x , is, by the substitution

$$\eta = -\frac{1}{C} \frac{dy}{dx}$$

reduced to the linear equation

$$\frac{d^2 y}{dx^2} - \left(B + \frac{1}{C} \frac{dC}{dx} \right) \frac{dy}{dx} + ACy = 0.$$

The equation

$$\frac{d^2 \eta}{dx^2} = A + B\eta + C\eta^2,$$

known as Riccati's equation, is transformed into an equation of the same form by a substitution of the form $\eta = (aY + b)/(cY + d)$, where a, b, c, d are any functions of x , and this fact may be utilized to obtain a solution when A, B, C have special forms; in particular if any particular solution of the equation be known, say η_0 , the

substitution $\eta = \eta_0 - 1/Y$ enables us at once to obtain the general solution; for instance, when

$$2B = \frac{d}{dx} \log \left(\frac{A}{C} \right),$$

a particular solution is $\eta_0 = \sqrt{-(A/C)}$. This is a case of the remark, often useful in practice, that the linear equation

$$\phi(x) \frac{d^2 y}{dx^2} + \frac{d\phi}{dx} \frac{dy}{dx} + \mu y = 0,$$

where μ is a constant, is reducible to a standard form by taking a new independent variable $s = \int dx \{\phi(x)\}^{-1}$.

We pass to other types of equations of which the solution can be obtained by rule. We may have cases in which there are two dependent variables, x and y , and one independent variable t , the differential coefficients dx/dt , dy/dt being given as functions of x , y and t . Of such equations a simple case is expressed by the pair

$$\frac{dx}{dt} = ax + by + c, \quad \frac{dy}{dt} = a'x + b'y + c',$$

wherein the coefficients a, b, c, a', b', c' , are constants. To integrate these, form with the constant λ the differential coefficient of $s = x + \lambda y$, that is $ds/dt = (a + \lambda a')x + (b + \lambda b')y + c + \lambda c'$, the quantity λ being so chosen that $b + \lambda b' = \lambda(a + \lambda a')$, so that we have $ds/dt = (a + \lambda a')s + c + \lambda c'$; this last equation is at once integrable in the form $s(a + \lambda a')t + c + \lambda c' = A e^{(a + \lambda a')t}$, where A is an arbitrary constant. In general, the condition $b + \lambda b' = \lambda(a + \lambda a')$ is satisfied by two different values of λ , say λ_1, λ_2 ; the solutions corresponding to these give the values of $x + \lambda_1 y$ and $x + \lambda_2 y$, from which x and y can be found as functions of t , involving two arbitrary constants. If, however, the two roots of the quadratic equation for λ are equal, that is, if $(a - b')^2 + 4a'b = 0$, the method described gives only one equation, expressing $x + \lambda y$ in terms of t ; by means of this equation y can be eliminated from $dx/dt = ax + by + c$, leading to an equation of the form $dx/dt = Px + Q + R e^{(a + \lambda a')t}$, where P, Q, R are constants. The integration of this gives x , and thence y can be found.

A similar process is applicable when we have three or more dependent variables whose differential coefficients in regard to the single independent variables are given as linear functions of the dependent variables with constant coefficients.

Another method of solution of the equations

$$dx/dt = ax + by + c, \quad dy/dt = a'x + b'y + c',$$

consists in differentiating the first equation, thereby obtaining

$$\frac{d^2 x}{dt^2} = a \frac{dx}{dt} + b \frac{dy}{dt};$$

from the two given equations, by elimination of y , we can express dy/dt as a linear function of x and dx/dt ; we can thus form an equation of the shape $d^2 x/dt^2 = P + Qx + R dx/dt$, where P, Q, R are constants; this can be integrated by methods previously explained, and the integral, involving two arbitrary constants, gives, by the equation $dx/dt = ax + by + c$, the corresponding value of y . Conversely it should be noticed that any single linear differential equation

$$\frac{dx}{dt} = u + vx + \frac{dx}{dt},$$

where u, v, w are functions of t , by writing y for dx/dt , is equivalent with the two equations $dx/dt = y$, $dy/dt = u + vx + wy$. In fact a similar reduction is possible for any system of differential equations with one independent variable.

Equations occur to be integrated of the form

$$Xdx + Ydy + Zds = 0,$$

where X, Y, Z are functions of x, y, s . We consider only the case in which there exists an equation $\phi(x, y, s) = C$ whose differential

$$\frac{\partial \phi}{\partial x} dx + \frac{\partial \phi}{\partial y} dy + \frac{\partial \phi}{\partial s} ds = 0$$

is equivalent with the given differential equation; that is, μ being a proper function of x, y, s , we assume that there exist equations

$$\frac{\partial \phi}{\partial x} = \mu X, \quad \frac{\partial \phi}{\partial y} = \mu Y, \quad \frac{\partial \phi}{\partial s} = \mu Z;$$

these equations require

$$\frac{\partial}{\partial s} (\mu Y) = \frac{\partial}{\partial y} (\mu Z), \quad \text{etc.},$$

and hence

$$X \left(\frac{\partial Z}{\partial y} - \frac{\partial Y}{\partial s} \right) + Y \left(\frac{\partial X}{\partial s} - \frac{\partial Z}{\partial x} \right) + Z \left(\frac{\partial Y}{\partial x} - \frac{\partial X}{\partial y} \right) = 0;$$

conversely it can be proved that this is sufficient in order that μ may exist to render $\mu(Xdx + Ydy + Zds)$ a perfect differential; in particular it may be satisfied in virtue of the three equations such as

$$\frac{\partial Z}{\partial y} - \frac{\partial Y}{\partial s} = 0,$$

in which case we may take $\mu = 1$. Assuming the condition in

its general form, take in the given differential equation a plane section of the surface $\phi = C$ parallel to the plane s , viz. put s constant, and consider the resulting differential equation in the two variables x, y , namely $Xdx + Ydy = 0$; let $\psi(x, y, s) = \text{constant}$, be its integral, the constant s entering, as a rule, in ψ because it enters in X and Y . Now differentiate the relation $\psi(x, y, s) = f(s)$, where f is a function to be determined, so obtaining

$$\frac{\partial \psi}{\partial x} dx + \frac{\partial \psi}{\partial y} dy + \left(\frac{\partial \psi}{\partial s} - \frac{df}{ds} \right) ds = 0;$$

there exists a function σ of x, y, s such that

$$\frac{\partial \psi}{\partial x} = \sigma X, \quad \frac{\partial \psi}{\partial y} = \sigma Y,$$

because $\psi = \text{constant}$, is the integral of $Xdx + Ydy = 0$; we desire to prove that f can be chosen so that also, in virtue of $\psi(x, y, s) = f(s)$, we have

$$\frac{\partial \psi}{\partial s} - \frac{df}{ds} = \sigma Z, \quad \text{namely } \frac{df}{ds} = \frac{\partial \psi}{\partial s} - \sigma Z;$$

if this can be proved the relation $\psi(x, y, s) = f(s) = \text{constant}$, will be the integral of the given differential equation. To prove this it is enough to show that, in virtue of $\psi(x, y, s) = f(s)$, the function $\frac{\partial \psi}{\partial s} - \sigma Z$ can be expressed in terms of s only. Now in consequence of the originally assumed relations,

$$\frac{\partial \psi}{\partial x} = \mu X, \quad \frac{\partial \psi}{\partial y} = \mu Y, \quad \frac{\partial \psi}{\partial s} = \mu Z,$$

we have

$$\frac{\partial \psi}{\partial x} / \frac{\partial \psi}{\partial x} = \frac{\sigma}{\mu} = \frac{\partial \psi}{\partial s} / \frac{\partial \psi}{\partial s},$$

and hence

$$\frac{\partial \psi}{\partial x} \frac{\partial \psi}{\partial y} - \frac{\partial \psi}{\partial y} \frac{\partial \psi}{\partial x} = 0;$$

this shows that, as functions of x and y , ψ is a function of ϕ (see the note at the end of part i. of this article, on Jacobian determinants), so that we may write $\psi = F(\phi, \phi)$, from which

$$\frac{\sigma}{\mu} = \frac{\partial F}{\partial \phi}; \quad \text{then } \frac{\partial \psi}{\partial s} = \frac{\partial F}{\partial s} + \frac{\partial F}{\partial \phi} \frac{\partial \phi}{\partial s} = \frac{\partial F}{\partial s} + \mu Z = \frac{\partial F}{\partial s} + \sigma Z \quad \text{or} \quad \frac{\partial \psi}{\partial s} - \sigma Z = \frac{\partial F}{\partial s};$$

in virtue of $\psi(x, y, s) = f(s) = F(\phi, \phi)$, the function ϕ can be written in terms of s only, thus $\partial F/\partial s$ can be written in terms of s only, and what we required to prove is proved.

Consider lastly a simple type of differential equation containing two independent variables, say x and y , and one dependent variable s , namely the equation

$$P \frac{ds}{dx} + Q \frac{ds}{dy} = R,$$

where P, Q, R are functions of x, y, s . This is known as Lagrange's linear partial differential equation of the first order. To integrate this, consider first the ordinary differential equations $ds/dx = F/R$, $dy/dx = Q/R$, and suppose that two functions u, v of x, y, s can be determined, independent of one another, such that the equations $u = a, v = b$, where a, b are arbitrary constants, lead to these ordinary differential equations, namely such that

$$P \frac{du}{dx} + Q \frac{du}{dy} + R \frac{du}{ds} = 0 \quad \text{and} \quad P \frac{dv}{dx} + Q \frac{dv}{dy} + R \frac{dv}{ds} = 0.$$

Then if $F(x, y, s) = 0$ be a relation satisfying the original differential equations, this relation giving rise to

$$\frac{\partial F}{\partial x} + \frac{\partial F}{\partial s} \frac{\partial s}{\partial x} = 0 \quad \text{and} \quad \frac{\partial F}{\partial y} + \frac{\partial F}{\partial s} \frac{\partial s}{\partial y} = 0, \quad \text{we have } P \frac{\partial F}{\partial x} + Q \frac{\partial F}{\partial y} + R \frac{\partial F}{\partial s} = 0.$$

It follows that the determinant of three rows and columns vanishes whose first row consists of the three quantities $\partial F/\partial x, \partial F/\partial y, \partial F/\partial s$, whose second row consists of the three quantities $\partial u/\partial x, \partial u/\partial y, \partial u/\partial s$, whose third row consists similarly of the partial derivatives of v . The vanishing of this so-called Jacobian determinant is known to imply that F is expressible as a function of u and v , unless these are themselves functionally related, which is contrary to hypothesis (see the note below on Jacobian determinants). Conversely, any relation $\phi(u, v) = 0$ can easily be proved, in virtue of the equations satisfied by u and v , to lead to

$$P \frac{d\phi}{dx} + Q \frac{d\phi}{dy} = R.$$

The solution of this partial equation is thus reduced to the solution of the two ordinary differential equations expressed by $dx/P = dy/Q = ds/R$. In regard to this problem one remark may be made which is often of use in practice: when one equation $u = a$ has been found to satisfy the differential equations, we may utilize this to obtain the second equation $v = b$; for instance, we may, by means of $u = a$, eliminate s —when then from the resulting equations in x and y a relation $v = b$ has been found containing x, y and a , the substitution $s = u$ will give a relation involving x, y, s .

Note on Jacobian Determinants.—The fact assumed above that the vanishing of the Jacobian determinant whose elements are the partial derivatives of three functions F, u, v , of three variables x, y, s ,

involves that there exists a functional relation connecting the three functions F, u, v , may be proved somewhat roughly as follows.—

The corresponding theorem is true for any number of variables. Consider first the case of two functions p, q , of two variables x, y . The function p , not being constant, must contain one of the variables, say x ; we can then suppose x expressed in terms of y and the function p ; thus the function q can be expressed in terms of y and the function p , say $q = Q(p, y)$. This is clear enough in the simplest cases which arise, when the functions are rational. Hence we have

$$\frac{\partial q}{\partial x} = \frac{\partial Q}{\partial p} \frac{\partial p}{\partial x} \text{ and } \frac{\partial q}{\partial y} = \frac{\partial Q}{\partial p} \frac{\partial p}{\partial y} + \frac{\partial Q}{\partial y};$$

these give

$$\frac{\partial p \partial q}{\partial x \partial y} - \frac{\partial p \partial q}{\partial y \partial x} = \frac{\partial p \partial Q}{\partial x \partial y};$$

by hypothesis $\partial p/\partial x$ is not identically zero; therefore if the Jacobian determinant of p and q in regard to x and y is zero identically, so is $\partial Q/\partial y$, or Q does not contain y , so that q is expressible as a function of p only. Conversely, such an expression can be seen at once to make the Jacobian of p and q vanish identically.

Passing now to the case of three variables, suppose that the Jacobian determinant of the three functions F, u, v in regard to x, y, z is identically zero. We prove that if u, v are not themselves functionally connected, F is expressible as a function of u and v . Suppose first that the minors of the elements of $\partial F/\partial x, \partial F/\partial y, \partial F/\partial z$ in the determinant are all identically zero, namely the three determinants such as

$$\frac{\partial u \partial v}{\partial y \partial z} - \frac{\partial u \partial v}{\partial z \partial y};$$

then by the case of two variables considered above there exist three functional relations $\psi_1(u, v, x) = 0, \psi_2(u, v, y) = 0, \psi_3(u, v, z) = 0$, of which the first, for example, follows from the vanishing of

$$\frac{\partial u \partial v}{\partial y \partial z} - \frac{\partial u \partial v}{\partial z \partial y};$$

We cannot assume that x is absent from ψ_1 , or y from ψ_2 , or z from ψ_3 ; but conversely we cannot simultaneously have x entering in ψ_1 , and y in ψ_2 , and z in ψ_3 , or else by elimination of u and v from the three equations $\psi_1 = 0, \psi_2 = 0, \psi_3 = 0$, we should find a necessary relation connecting the three independent quantities x, y, z ; which is absurd. Thus when the three minors of $\partial F/\partial x, \partial F/\partial y, \partial F/\partial z$ in the Jacobian determinant are all zero, there exists a functional relation connecting u and v only. Suppose no such relation to exist; we can then suppose, for example, that

$$\frac{\partial u \partial v}{\partial y \partial z} - \frac{\partial u \partial v}{\partial z \partial y}$$

is not zero. Then from the equations $u(x, y, z) = u, v(x, y, z) = v$ we can express y and z in terms of u, v , and x (the attempt to do this could only fail by leading to a relation connecting u, v and x , and the existence of such a relation would involve that the determinant

$$\frac{\partial u \partial v}{\partial y \partial z} - \frac{\partial u \partial v}{\partial z \partial y}$$

was zero), and so write F in the form $F(x, y, z) = \Phi(u, v, x)$. We then have

$$\frac{\partial F}{\partial x} = \frac{\partial \Phi}{\partial u} \frac{\partial u}{\partial x} + \frac{\partial \Phi}{\partial v} \frac{\partial v}{\partial x} + \frac{\partial \Phi}{\partial x}, \quad \frac{\partial F}{\partial y} = \frac{\partial \Phi}{\partial u} \frac{\partial u}{\partial y} + \frac{\partial \Phi}{\partial v} \frac{\partial v}{\partial y} + \frac{\partial \Phi}{\partial y}, \quad \frac{\partial F}{\partial z} = \frac{\partial \Phi}{\partial u} \frac{\partial u}{\partial z} + \frac{\partial \Phi}{\partial v} \frac{\partial v}{\partial z} + \frac{\partial \Phi}{\partial z};$$

thereby the Jacobian determinant of F, u, v is reduced to

$$\frac{\partial \Phi}{\partial x} \left(\frac{\partial u \partial v}{\partial y \partial z} - \frac{\partial u \partial v}{\partial z \partial y} \right);$$

by hypothesis the second factor of this does not vanish identically; hence $\partial \Phi/\partial x = 0$ identically, and Φ does not contain x ; that F is expressible in terms of u, v only; as was to be proved.

Part II.—General Theory.

Differential equations arise in the expression of the relations between quantities by the elimination of details, either unknown or regarded as unessential to the formulation of the relations in question. They give rise, therefore, to the two closely connected problems of determining what arrangement of details is consistent with them, and of developing, apart from these details, the general properties expressed by them. Very roughly, two methods of study can be distinguished, with the names Transformation-theories, Function-theories; the former is concerned with the reduction of the algebraical relations to the fewest and simplest forms, eventually with the hope of obtaining explicit expressions of the dependent variables in terms of the independent variables; the latter is concerned with the determination of the general descriptive relations among the quantities which are involved by the differential equations, with as little use of algebraical calculations as may be possible. Under the former heading we may, with the assumption of a few theorems belonging to the latter,

arrange the theory of partial differential equations and Pfaff's problem, with their geometrical interpretations, as at present developed, and the applications of Lie's theory of transformation-groups to partial and to ordinary equations; under the latter, the study of linear differential equations in the manner initiated by Riemann, the applications of discontinuous groups, the theory of the singularities of integrals, and the study of potential equations with existence-theorems arising therefrom. In order to be clear we shall enter into some detail in regard to partial differential equations of the first order, both those which are linear in any number of variables and those not linear in two independent variables, and also in regard to the function-theory of linear differential equations of the second order. Space renders impossible anything further than the briefest account of many other matters; in particular, the theories of partial equations of higher than the first order, the function-theory of the singularities of ordinary equations not linear and the applications to differential geometry, are taken account of only in the bibliography. It is believed that on the whole the article will be more useful to the reader than if explanations of method had been further curtailed to include more facts.

When we speak of a function without qualification, it is to be understood that in the immediate neighbourhood of a particular set x_0, y_0, \dots of values of the independent variables x, y, \dots of the function, at whatever point of the range of values for x, y, \dots under consideration x_0, y_0, \dots may be chosen, the function can be expressed as a series of positive integral powers of the differences $x - x_0, y - y_0, \dots$, convergent when these are sufficiently small (see FUNCTION: Functions of Complex Variables). Without this condition, which we express by saying that the function is developable about x_0, y_0, \dots , many results provisionally stated in the transformation theories would be unmeaning or incorrect. If, then, we have a set of k functions, f_1, \dots, f_n of n independent variables x_1, \dots, x_n , we say that they are independent when $n \geq k$ and not every determinant of k rows and columns vanishes of the matrix of k rows and n columns whose r -th row has the constituents $df_1/dx_1, \dots, df_r/dx_n$; the justification being in the theorem, which we assume, that if the determinant involving, for instance, the first k columns be not zero for $x_1 = x_1^0, \dots, x_n = x_n^0$, and the functions be developable about this point, then from the equations $f_1 = c_1, \dots, f_k = c_k$ we can express x_1, \dots, x_k by convergent power series in the differences $x_{k+1} - x_{k+1}^0, \dots, x_n - x_n^0$, and so regard x_1, \dots, x_k as functions of the remaining variables. This we often express by saying that the equations $f_1 = c_1, \dots, f_k = c_k$ can be solved for x_1, \dots, x_k . The explanation is given as a type of explanation often understood in what follows.

We may conveniently begin by stating the theorem: If each of the n functions ϕ_1, \dots, ϕ_n of the $(n+1)$ variables x_1, \dots, x_{n+1} be developable about the values x_1^0, \dots, x_{n+1}^0 , the n differential equations of the form $dx_i/dt = \phi_i(x_1, \dots, x_{n+1})$ are satisfied by convergent power series

$$x_i = x_i^0 + (t - t^0)A_{i1} + (t - t^0)^2 A_{i2} + \dots$$

reducing respectively to x_1^0, \dots, x_n^0 when $t = t^0$; and the only functions satisfying the equations and reducing respectively to x_1^0, \dots, x_n^0 when $t = t^0$, are those determined by continuation of these series. If the result of solving these n equations for x_1^0, \dots, x_n^0 be written in the form $\omega_1(x_1, \dots, x_{n+1}) = x_1^0, \dots, \omega_n(x_1, \dots, x_{n+1}) = x_n^0$, it is at once evident that the differential equation

$$df/dt + \phi_1 df/dx_1 + \dots + \phi_n df/dx_n = 0$$

possesses n integrals, namely, the functions $\omega_1, \dots, \omega_n$, which are developable about the values $(x_1^0, \dots, x_{n+1}^0)$, and reduce respectively to x_1^0, \dots, x_n^0 when $t = t^0$. And in fact it has no other integrals so reducing. Thus this equation also possesses a unique integral reducing when $t = t^0$ to an arbitrary function $\psi(x_1, \dots, x_{n+1})$; this integral being $\psi(\omega_1, \dots, \omega_n)$. Conversely the existence of these principal integrals $\omega_1, \dots, \omega_n$ of the partial equation establishes the existence of the specified solutions of the ordinary equations $dx_i/dt = \phi_i$. The following sketch of the proof of the existence of these principal integrals for the case $n = 2$ will show the character of more general investigations. Put x for $x - x^0$, &c., and consider the equation $a(xy)df/dx + b(xy)df/dy = df/dt$, wherein the functions a, b are developable about $x = 0, y = 0, t = 0$; say

$$a(xy) = a_0 + a_1x + a_2xy + \dots, \quad b(xy) = b_0 + b_1x + b_2xy + \dots$$

so that

$$ad/dx + bd/dy = a_0 + b_1x + b_2xy + \dots$$

where $\delta = a_0 dx + b_1 dy$. In order that

$$f = p_0 + p_1x + p_2xy + \dots$$

Ordinary equations of the first order.

Single homogeneous partial equation of the first order.

wherein p_1, p_2, \dots are power series in x, y , should satisfy the equation, it is necessary, as we find by equating like terms, that

Proof and in general $p_{r+1} = a_r p_r + b_1 b_2 p_{r-1} + \dots + b_k p_1$ where $(\frac{d}{dx})^r (f-r) = \dots + b_k p_1$

wherein each coefficient in the expansion of either A or B is real and positive, and not less than the absolute value of the corresponding coefficient in the expansion of a or b. In the second equation let us substitute a series

wherein the coefficients in P_r are real and positive, and each not less than the absolute value of the corresponding coefficient in p_r ; then putting $\Delta_r = A_r d/dx + B_r d/dy$ we obtain necessary equations of the same form as before, namely,

and in general $P_{r+1} = \Delta_r P_r + \gamma_1 \Delta_r P_{r-1} + \dots + \Delta_r P_1$. These give for every coefficient in P_{r+1} an integral aggregate with real positive coefficients of the coefficients in P_r, P_{r-1}, \dots, P_1 and the coefficients in A and B; and they are the same aggregates as would be given by the previously obtained equations for the corresponding coefficients in p_{r+1} in terms of the coefficients in p_r, p_{r-1}, \dots, p_1 and the coefficients in a and b. Hence as the coefficients in P_r and also in A, B are real and positive, it follows that the values obtained in succession for the coefficients in P_1, P_2, \dots are real and positive; and further, taking account of the fact that the absolute value of a sum of terms is not greater than the sum of the absolute values of the terms, it follows, for each value of r , that every coefficient in p_{r+1} is, in absolute value, not greater than the corresponding coefficient in P_{r+1} . Thus if the series for P be convergent, the series for p will also be; and we are thus reduced to (1), specifying functions A, B with real positive coefficients, each in absolute value not less than the corresponding coefficient in a, b; (2) proving that the equation

possesses an integral $P_r = a_r P_{r-1} + b_1 P_{r-2} + \dots$ in which the coefficients in P are real and positive, and each not less than the absolute value of the corresponding coefficient in p_r . If a, b be developable for x, y both in absolute value less than r and for t less in absolute value than R, and for such values a, b be both less in absolute value than the real positive constant M, it is not difficult to verify that we may take $A = B = M \left(1 - \frac{x+y}{R}\right)^{-1} \left(1 - \frac{t}{R}\right)^{-1}$, and obtain

$$F = r - (r-x-y) \left[1 - \frac{4MR}{r} \left(1 - \frac{x+y}{R}\right)^{-1} \log \left(1 - \frac{t}{R}\right)^{-1} \right]^{\frac{1}{2}}$$

and that this solves the problem when x, y, t are sufficiently small for the two cases $p_x = x, p_y = y$. One obvious application of the general theorem is to the proof of the existence of an integral of an ordinary linear differential equation given by the n equations $y_1 dx = \gamma_1, y_2 dx = \gamma_2, \dots$

but in fact any simultaneous system of ordinary equations is reducible to a system of the form

Suppose we have k homogeneous linear partial equations of the first order in n independent variables, the general equation being $a_1 d/dx_1 + \dots + a_n d/dx_n = 0$, where $\sigma = 1, \dots, k$, and that

we desire to know whether the equations have common solutions, and if so, how many. It is to be understood that the equations are linearly independent, which implies that $k \leq n$ and not every determinant of k rows and columns is identically zero in the matrix in which the i-th element of the σ -th row is $a_{\sigma i} (\sigma = 1, \dots, n, \sigma = 1, \dots, k)$. Denoting the left side of the σ -th equation by P_{σ} , it is clear that every common solution of the two equations $P_{\sigma} f = 0, P_{\sigma'} f = 0$ is also a solution of the equation $P_{\sigma} (P_{\sigma'} f) - P_{\sigma'} (P_{\sigma} f) = 0$. We immediately find, however, that this is also a linear equation, namely, $2H d/dx_1 = 0$, where $H_{\sigma} = P_{\sigma} a_{\sigma 1} - P_{\sigma'} a_{\sigma 1}$, and if it be not already contained among the given equations, or be linearly deducible from them, it may be added to them, as not introducing any additional limitation of the possibility of their having common solutions. Proceeding thus with every pair of the original equations, and then with every pair of the possibly augmented system so obtained, and so on continually, we shall arrive at a system of equations, linearly independent of each other and therefore not more than n in number, such that the combination, in the way described, of every pair of them, leads to an equation which is linearly deducible from them. If the number of this so-called complete system is n, the equations give $d/dx_1 = 0, \dots, d/dx_n = 0$, leading to the negatory result f = a constant. Suppose, then, the number of this system to be r, < n; suppose, further, that from the matrix of the coefficients a determinant of r rows and columns not vanishing identically is that formed by the coefficients of the differential coefficients of f in regard to x_1, \dots, x_r ; also that the coefficients are all developable about the values $x_1 = x_1^0, \dots, x_n = x_n^0$, and that for these values the determinant just spoken of is not zero. Then the main theorem is that the complete system of r equations, and therefore the originally given set of k equations,

have in common n-r solutions, say $\omega_{n-1}, \dots, \omega_1$, which reduce respectively to x_{r+1}, \dots, x_n when in them for x_1, \dots, x_r are respectively put x_1^0, \dots, x_r^0 ; so that also the equations have in common a solution reducing when $x_1 = x_1^0, \dots, x_r = x_r^0$ to an arbitrary function $\psi(x_{r+1}, \dots, x_n)$ which is developable about x_{r+1}^0, \dots, x_n^0 , namely, this common solution is $\psi(\omega_{n-1}, \dots, \omega_1)$. It is seen at once that this result is a generalization of the theorem for $r=1$, and its proof is conveniently given by induction from that case. It can be verified without difficulty (1) that if from the r equations of the complete system we form r independent linear aggregates, with coefficients not necessarily constants, the new system is also a complete system; (2) that if in place of the independent variables x_1, \dots, x_n we introduce any other variables which are independent functions of the former, the new equations also form a complete system. It is convenient, then, from the complete system of r equations to form r new equations by solving separately for $d/dx_1, \dots, d/dx_r$; suppose the general equation of the new system to be

$Q_{\sigma} f = d/dx_1 + c_{\sigma 1} d/dx_2 + \dots + c_{\sigma n} d/dx_n = 0 (\sigma = 1, \dots, r)$. Then it is easily obvious that the equation $Q_{\sigma} f = 0$ contains only the differential coefficients of f in regard to x_{r+1}, \dots, x_n ; as it is at most a linear function of $Q_1 f, \dots, Q_r f$, it must be identically zero. So reduced the system is called a Jacobian system. Of this system $Q_{\sigma} f = 0$ has n-1 principal solutions reducing respectively to x_2, \dots, x_n when

$$x_1 = x_1^0,$$

and its form shows that these the first r-1 are exactly x_2, \dots, x_n . Let these n-1 functions together with x_1 be introduced as n new independent variables in all the r equations. Since the first equation is satisfied by n-1 of the new independent variables, it will contain no differential coefficients in regard to them, and will reduce therefore simply to $d/dx_1 = 0$, expressing that any common solution of the r equations is a function only of the n-1 remaining variables. Thereby the investigation of the common solutions is reduced to the same problem for r-1 equations in n-1 variables. Proceeding thus, we reach at length one equation in n-r+1 variables, from which, by retracing the analysis, the proposition stated is seen to follow.

The analogy with the case of one equation is, however, still closer. With the coefficients $c_{\sigma j}$ of the equations $Q_{\sigma} f = 0$ in transposed array ($\sigma = 1, \dots, r, j = r+1, \dots, n$) we can put down the (n-r) equations, $dx_1 = c_{1j} dx_j, \dots, dx_r = c_{rj} dx_j$, equivalent to the r(n-r) equations $dx_j/dx_{\sigma} = c_{\sigma j}$. That consistent with them we may be able to regard x_{r+1}, \dots, x_n as arational functions of x_1, \dots, x_r , these being regarded as independent variables, it is clearly necessary that when we differentiate $c_{\sigma j}$ in regard to x_{σ} on this hypothesis the result should be the same as when we differentiate $c_{\sigma j}$ in regard to x_{σ} on this hypothesis. The differential coefficient of a function f of x_1, \dots, x_n on this hypothesis, in regard to x_{σ} , is, however,

$$d/dx_{\sigma} + c_{\sigma n+1} d/dx_{n+1} + \dots + c_{\sigma n} d/dx_n$$

namely, is $Q_{\sigma} f$. Thus the consistency of the n-r total equations requires the conditions $Q_{\sigma} c_{\sigma j} = Q_{\sigma'} c_{\sigma j} = 0$, which are, however, verified in virtue of $Q_{\sigma} (Q_{\sigma'} f) = Q_{\sigma'} (Q_{\sigma} f) = 0$. And it can in fact be easily verified that $\omega_1, \dots, \omega_{n-1}$ be the principal solutions of the Jacobian system, $Q_{\sigma} f = 0$, reducing respectively to x_{r+1}, \dots, x_n when $x_1 = x_1^0, \dots, x_r = x_r^0$, and the equations $\omega_{n-1} = x_{n-1}^0, \dots, \omega_1 = x_1^0$ be solved for x_{r+1}, \dots, x_n and give $x_j = \psi_j(x_1, \dots, x_r, x_1^0, \dots, x_r^0)$, these values solve the total equations and reduce respectively to x_{r+1}^0, \dots, x_n^0 when $x_1 = x_1^0, \dots, x_r = x_r^0$. And the total equations have no other solutions with these initial values. Conversely, the existence of these solutions of the total equations can be deduced a priori and the theory of the Jacobian system based upon them. The theory of such total equations, in general, finds its natural place under the heading Pfaffian Expressions, below.

A practical method of reducing the solution of the r equations of a Jacobian system to that of a single equation in n-r+1 variables may be explained in connexion with a geometrical interpretation which will perhaps be clearer in a particular case, say n=3, r=2. There is then only one total equation, say $dx = adx + bdy$; if we do not take account of the condition of integrability, which is in this case $da/dy + bda/dx = db/dx + adb/dx$, this equation may be regarded as defining through an arbitrary point (x_0, y_0, z_0) of three-dimensional space (about which a, b are developable) a plane, namely, $z - z_0 = a(x - x_0) + b(y - y_0)$, and therefore, through this arbitrary point ∞^2 directions, namely, all those in the plane. If now there be a surface $z = \psi(x, y)$, satisfying $dx = adx + bdy$ and passing through (x_0, y_0, z_0) , this plane will touch the surface, and the operations of passing along the surface from (x_0, y_0, z_0) to

$$(x_1 + dx_1, y_1, z_1 + dz_1)$$

and then to $(x_2 + dx_2, y_2 + dy_2, z_2 + dz_2)$, ought to lead to the same value of dz_1 as do the operations of passing along the surface from (x_0, y_0, z_0) to $(x_0, y_0 + dy_0, z_0 + dz_0)$, and then to

$$(x_1 + dx_1, y_1 + dy_1, z_1 + dz_1),$$

namely, dz_1 ought to be equal to $d^2 z_1$. But we find

$$d^2 z_1 = a dx_1 + b dy_1 + dx_1 dy_1 + a dx_2 dy_2 + b dy_2 dx_2 + a dx_2 dy_2 + b dy_2 dx_2 + a dx_2 dy_2 + b dy_2 dx_2$$

and so at once reach the condition of integrability. If now we put

Jacobian systems.

System of total differential equations.

Geometrical interpretation and solution.

$x = x_0 + t, y = y_0 + mt$, and regard m as constant, we shall in fact be considering the section of the surface by a fixed plane $y - y_0 = m(x - x_0)$; along this section $ds = dt(a + bm)$; if we then integrate the equation $ds/dt = a + bm$, where a, b are expressed as functions of m and t , with m kept constant, finding the solution which reduces to x_0 for $t = 0$, and in the result again replace m by $(y - y_0)/(x - x_0)$, we shall have the surface in question. In the general case the equations

$$ds_1/dt = c_1 + m_1 ds_2 + \dots + m_{n-1} ds_{n-1}$$

Mayer's similarly determine through an arbitrary point x_0^1, \dots, x_0^n a planar manifold of r dimensions in space of n dimensions, and when the conditions of integrability are satisfied, then every direction in this manifold through this point is tangent to the manifold of r dimensions, expressed by $\phi_{r+1} = x_0^{r+1}, \dots, \phi_n = x_0^n$, which satisfies the equations and passes through this point. If we put $x_1 - x_0 = t, x_2 - x_0 = mt, \dots, x_r - x_0 = m_r t$, and regard m_1, \dots, m_r as fixed, the $(n-r)$ total equations take the form $ds_i/dt = c_i + m_1 ds_1 + \dots + m_r ds_r$, and their integration is equivalent to that of the single partial equation

$$df/dt + \sum_{i=1}^r (c_{i1} + m_1 c_{i2} + \dots + m_{r-1} c_{ir}) df/dx_i = 0$$

in the $n-r+1$ variables t, x_{r+1}, \dots, x_n . Determining the solutions $\Omega_{r+1}, \dots, \Omega_n$ which reduce to respectively x_{r+1}, \dots, x_n when $t = 0$, and substituting $t = x_1 - x_0, m_1 = (x_2 - x_0)/(x_1 - x_0), \dots, m_r = (x_r - x_0)/(x_1 - x_0)$, we obtain the solutions of the original system of partial equations previously denoted by $\phi_{r+1}, \dots, \phi_n$. It is to be remarked, however, that the presence of the fixed parameters m_1, \dots, m_r in the single integration may frequently render it more difficult than if they were assigned numerical quantities.

We have above considered the integration of an equation $ds = adx + bdy$ on the hypothesis that the condition

$$da/dy + bda/dx = db/dx + adb/dx$$

is natural to inquire what relations among x, y, z , if any, are implied by, or are consistent with, a differential relation $adx + bdy + czdz = 0$, when a, b, c are unrestricted functions of x, y, z . This problem leads to the consideration of the so-called Pfaffian Expression $adx + bdy + czdz$. It can be shown (1) if each of the quantities $db/dx - dc/dy, d^2c/dx^2 - da/dx, da/dy - db/dx$, which we shall denote respectively by w_{12}, w_{13}, w_{23} , be identically zero, the expression is the differential of a function of x, y, z , equal to dI say; (2) that if the quantity $aw_{12} + bw_{13} + cw_{23}$ is identically zero, the expression is of the form dI, I, c , etc. can be made a perfect differential by multiplication by the factor $1/I, c$, etc. in general the expression is of the form $dI + I, c$. Consider the matrix of four rows and three columns in which the elements of the first row are a, b, c , and the elements of the $(r+1)$ -th row, for $r = 1, 2, 3$, are the quantities w_{12}, w_{13}, w_{23} , where $w_{11} = w_{22} = w_{33} = 0$. Then it is easily seen that the cases (1), (2), (3) above correspond respectively to the cases when (1) every determinant of this matrix of two rows and columns is zero, (2) every determinant of three rows and columns is zero, (3) when no condition is assumed. This result can be generalized as follows: if a_1, \dots, a_n are any functions of x_1, \dots, x_n , the so-called Pfaffian expression $a_1 dx_1 + \dots + a_n dx_n$ can be reduced to one or other of the two forms

$$u_1 dx_1 + \dots + u_r dx_r, \quad dI + u_1 dx_1 + \dots + u_{n-r} dx_{n-r}$$

wherein $I, u_1, \dots, u_r, \dots, u_{n-r}$ are independent functions of x_1, \dots, x_n , and k is such that in these two cases respectively $2k$ or $2k-1$ is the rank of a certain matrix of $n+1$ rows and n columns, that is, the greatest number of rows and columns in a non-vanishing determinant of the matrix; the matrix is that whose first row is constituted by the quantities a_1, \dots, a_n , whose s -th element in the $(r+1)$ -th row is the quantity $da_s/dx_1 - da_1/dx_s$. The proof of such a reduced form can be obtained from the two results: (1) if I be any given function of the $2m$ independent variables $x_1, \dots, x_m, I_1, \dots, I_m$, the expression $dI + u_1 dx_1 + \dots + u_m dx_m$ can be put into the form $w^1 dI_1 + \dots + w^m dI_m$. (2) If the quantities $w^1, \dots, w^m, I_1, \dots, I_m$ be connected by a relation, the expression $w^1 dI_1 + \dots + w^m dI_m$ can be put into the form $w^1 dI_1 + \dots + w^{m-1} dI_{m-1}$; and if the relation connecting $w^1, \dots, w^m, I_1, \dots, I_m$ be homogeneous in w^1, \dots, w^m , then I can be taken to be zero. These two results are deductions from the theory of contact transformations (see below), and their demonstration requires, beside elementary algebraical considerations, only the theory of complete systems of linear homogeneous partial differential equations of the first order. When the existence of the reduced form of the Pfaffian expression containing only independent quantities is thus once assured, the identification of the number k with that defined by the specified matrix may, with some difficulty, be made a posteriori.

In all cases of a single Pfaffian equation we are thus led to consider what is implied by a relation $dx - u_1 dy_1 - \dots - u_m dy_m = 0$, in which

Single linear Pfaffian equation. $u_1, \dots, u_m, I_1, \dots, I_m$ are, except for this equation, independent variables. This is to be satisfied in virtue of one or several relations connecting the variables; these must involve relations connecting I_1, I_2, \dots, I_m only, and in one of these m at least I must actually enter. We can then suppose that in one actual system of relations in virtue of which the Pfaffian equation is satisfied, all the relations connecting I_1, \dots, I_m only are given by

$$I = \psi(I_{r+1}, \dots, I_m), \quad I_1 = \psi_1(I_{r+1}, \dots, I_m), \quad \dots, \quad I_r = \psi_r(I_{r+1}, \dots, I_m);$$

so that the equation

$$dx - u_1 dy_1 - \dots - u_m dy_m - u_{r+1} d\psi - \dots - u_{r+m} dI_m = 0$$

is identically true in regard to $u_1, \dots, u_m, I_{r+1}, \dots, I_m$; equating to zero the coefficients of the differentials of these variables, we thus obtain $m-r$ relations of the form

$$d\psi/dI_1 - u_1 d\psi_1/dI_1 - \dots - u_{r+m} dI_m/dI_1 = 0;$$

these $m-r$ relations, with the previous $s+1$ relations, constitute a set of $m+1$ relations connecting the $2m+1$ variables in virtue of which the Pfaffian equation is satisfied independently of the form of the functions $\psi, \psi_1, \dots, \psi_r$. There is clearly such a set for each of the values $s = 0, s = 1, \dots, s = m-1, s = m$. And for any value of s there may exist relations additional to the specified $m+1$ relations, provided they do not involve any relation connecting I_1, I_2, \dots, I_m only, and are consistent with the $m-r$ relations connecting u_1, \dots, u_m . It is now evident that, essentially, the integration of a Pfaffian equation

$$a_1 dx_1 + \dots + a_n dx_n = 0,$$

wherein a_1, \dots, a_n are functions of x_1, \dots, x_n , is effected by the processes necessary to bring it to its reduced form, involving only independent variables. And it is easy to see that if we suppose this reduction to be carried out in all possible ways, there is no need to distinguish the classes of integrals corresponding to the various values of s ; for it can be verified without difficulty that by putting $I' = I - u_1 I_1 - \dots - u_m I_m, I'_1 = u_1, \dots, I'_m = u_m, u'_1 = -I_1, \dots, u'_m = -I_m, I'_{r+1} = I_{r+1}, \dots, I'_m = I_m, u'_1 = u_1, \dots, u'_m = u_m$, the reduced equation becomes changed to $dI' - u'_1 dI'_1 - \dots - u'_m dI'_m = 0$, and the general relations changed to

$$I' = \psi(I'_{r+1}, \dots, I'_m) - I'_1 \psi_1(I'_{r+1}, \dots, I'_m) - \dots - I'_r \psi_r(I'_{r+1}, \dots, I'_m) = \phi,$$

say, together with $u'_1 = d\phi/dI'_1, \dots, u'_m = d\phi/dI'_m$, which contain only one relation connecting the variables I', I'_1, \dots, I'_m only. This method for a single Pfaffian equation can, strictly speaking, be generalized to a simultaneous system of $(n-r)$ Pfaffian equations $dx_1 = c_1 dx_2 + \dots + c_r dx_r$, only in the case already treated, *Simultaneous Pfaffian equations.* when this system is satisfied by regarding x_{r+1}, \dots, x_n as suitable functions of the independent variables x_1, \dots, x_r ; in that case the integral manifolds are of r dimensions.

When these are non-existent, there may be integral manifolds of higher dimensions; for if $d\phi = \phi_1 dx_1 + \dots + \phi_r dx_r + \phi_{r+1}(c_1 dx_2 + \dots + c_r dx_r) + \phi_{r+2}(\dots) + \dots$ be identically zero, then $\phi + c_{r+1} \phi_{r+1} + \dots + c_{r+m} \phi_m = 0$, or ϕ satisfies the r partial differential equations previously associated with the total equations; when these are not a complete system, but included in a complete system of $r-m$ equations, having therefore $n-r-m$ independent integrals, the total equations are satisfied over a manifold of $r+m$ dimensions (see E. v. Weber, *Math. Annal.* iv. (1901), p. 386).

It seems desirable to add here certain results, largely of algebraic character, which naturally arise in connexion with the theory of contact transformations. For any two functions of the $2m$ independent variables $x_1, \dots, x_m, p_1, \dots, p_m$ we denote by (ϕ, ψ) the sum of the m terms such as $\frac{d\phi}{dx_1} \frac{d\psi}{dp_1} - \frac{d\psi}{dx_1} \frac{d\phi}{dp_1}$. For two functions of the $(2n+1)$ independent variables $x, x_1, \dots, x_n, p_1, \dots, p_n$ we denote by (ϕ, ψ) the sum of the n terms such as

$$\frac{d\phi}{dp_1} \left(\frac{d\psi}{dx_1} + p_1 \frac{d\psi}{dx_1} \right) - \frac{d\psi}{dp_1} \left(\frac{d\phi}{dx_1} + p_1 \frac{d\phi}{dx_1} \right).$$

It can at once be verified that for any three functions $(f, \psi, \chi) + (\phi, \psi, \chi) + (\psi, \chi, \phi) = 0$. Then, if $X_1, \dots, X_n, P_1, \dots, P_n$ be such functions of $x_1, \dots, x_n, p_1, \dots, p_n$ that $P_1 dx_1 + \dots + P_n dx_n$ is identically equal to $p_1 dx_1 + \dots + p_n dx_n$ it can be shown by elementary algebra, after equating coefficients of independent differentials, (1) that the functions X_1, \dots, X_n are independent functions of the $2n$ variables $x_1, \dots, x_n, p_1, \dots, p_n$, so that the equations $x'_i = X_i, p'_i = P_i$ can be solved for $x_1, \dots, x_n, p_1, \dots, p_n$ and represent therefore a transformation, which we call a homogeneous contact transformation; (2) that the X_1, \dots, X_n are homogeneous functions of p_1, \dots, p_n of zero dimensions the P_1, \dots, P_n are homogeneous functions of p_1, \dots, p_n of dimension one, and the $n(n-1)$ relations $(X_i, X_j) = 0$ are verified. So also are the n^2 relations $(P_i, X_j) = 1, (P_i, X_i) = 0, (P_i, P_j) = 0$. Conversely, if X_1, \dots, X_n are independent functions, each homogeneous of zero dimension in p_1, \dots, p_n satisfying the $\frac{1}{2}n(n-1)$ relations $(X_i, X_j) = 0$, then P_1, \dots, P_n can be uniquely determined, by solving linear algebraic equations, such that $P_1 dx_1 + \dots + P_n dx_n = p_1 dx_1 + \dots + p_n dx_n$. If now we put $n+1$ for n , put z for x_{n+1} , Z for X_{n+1} , Q_i for $-P_i/P_{n+1}$, for $i = 1, \dots, n$, put q_i for $-p_i/p_{n+1}$ and σ for q_{n+1}/Q_{n+1} , and then finally write $P_1, \dots, P_n, p_1, \dots, p_n$ for $Q_1, \dots, Q_n, q_1, \dots, q_n$, we obtain the following results: If $ZX_1, \dots, X_n, P_1, \dots, P_n$ be functions of $x, x_1, \dots, x_n, p_1, \dots, p_n$, such that the expression $dZ - P_1 dx_1 - \dots - P_n dx_n$ is identically equal to $\sigma(dz - p_1 dx_1 - \dots - p_n dx_n)$, and σ not zero, then (1) the functions $Z, X_1, \dots, X_n, P_1, \dots, P_n$ are independent functions of $x, x_1, \dots, x_n, p_1, \dots, p_n$, so that the equations $x' = X, z' = Z, p'_i = P_i$ can be solved for $(x, x_1, \dots, x_n, p_1, \dots, p_n)$ and determine a transformation which we call a (non-homogeneous) contact transformation; (2) the Z, X_1, \dots, X_n verify the $\frac{1}{2}n(n+1)$

identities $[ZX_i]=0, [X_iX_j]=0$. And the further identities

$$[P_iX_i]=\sigma, [P_iX_j]=0, [P_iZ]=\sigma P_i, [P_iP_j]=0, \\ [Z\sigma]=\frac{dZ}{ds}-\sigma^2, [X_i\sigma]=\sigma \frac{dX_i}{ds}, [P_i\sigma]=\sigma \frac{dP_i}{ds}$$

are also verified. Conversely, if Z, X_1, \dots, X_n are independent functions satisfying the identities $[ZX_i]=0, [X_iX_j]=0$, then σ , other than zero, and P_1, \dots, P_n can be uniquely determined, by solution of algebraic equations, such that

$$dZ - P_1 dX_1 - \dots - P_n dX_n = (\delta s - p dx_1 - \dots - p_n dx_n)$$

Finally, there is a particular case of great importance arising when $\sigma=1$, which gives the results: (1) If $U, X_1, \dots, X_n, P_1, \dots, P_n$ be $n+1$ functions of the $2n$ independent variables $x_1, \dots, x_n, p_1, \dots, p_n$, satisfying the identity

$$dU + P_1 dx_1 + \dots + P_n dX_n = p_1 dx_1 + \dots + p_n dx_n,$$

then the $2n$ functions $P_1, \dots, P_n, X_1, \dots, X_n$ are independent, and when X_i, \dots, X_n, U satisfy these $\frac{1}{2}(n+1)$ conditions, then P_1, \dots, P_n can be found, by solution of linear algebraic equations, to render true the identity $dU + P_1 dX_1 + \dots + P_n dX_n = p_1 dx_1 + \dots + p_n dx_n$; (2) If X_1, \dots, X_n are independent functions of $x_1, \dots, x_n, p_1, \dots, p_n$, such that $(X_i X_j)=0$, then U can be found by a quadrature, such that $(X_i U)=\delta X_i$;

and when X_i, \dots, X_n, U satisfy these $\frac{1}{2}(n+1)$ conditions, then P_1, \dots, P_n can be found, by solution of linear algebraic equations, to render true the identity $dU + P_1 dX_1 + \dots + P_n dX_n = p_1 dx_1 + \dots + p_n dx_n$; (3) Functions $X_1, \dots, X_n, P_1, \dots, P_n$ can be found to satisfy this differential identity when U is an arbitrary given function of $x_1, \dots, x_n, p_1, \dots, p_n$; but this requires integrations. In order to see what integrations, it is only necessary to verify the statement that if U be an arbitrary given function of $x_1, \dots, x_n, p_1, \dots, p_n$, and, for $r < n, X_1, \dots, X_r$ be independent functions of these variables, such that $(X_r U)=\delta X_r, (X_r X_s)=0$, for $p, s=1, \dots, r$, then the $r+1$ homogeneous linear partial differential equations of the first order $(Uf)+\delta f=0, (X_r f)=0$, form a complete system. It will be seen that the assumptions above made for the reduction of Pfaffian expressions follow from the results here enunciated for contact transformations.

We pass on now to consider the solution of any partial differential equation of the first order; we attempt to explain

Partial differential equation of the first order.

certain ideas relatively to a single equation with any number of independent variables (in particular, an ordinary equation of the first order with one independent variable) by speaking of a single equation with two independent variables x, y , and one dependent variable z . It will be seen that we are naturally led to consider systems of such simultaneous equations, which we consider below. The central discovery of the transformation theory of the solution of an equation $F(x, y, z, ds/dx, ds/dy)=0$ is that its solution can always be reduced to the solution of partial equations which are linear. For this, however, we must regard $ds/dx, ds/dy$, during the process of integration, not as the differential coefficients of a function s in regard to x and y , but as variables independent of x, y, z , the too great indefiniteness that might thus appear to be introduced being provided for in another way. We notice that if $z=\psi(x, y)$ be a solution of the differential equation, then $ds=dxd\psi/dx+dxd\psi/dy$; thus if we denote the equation by $F(x, y, z, p, q)=0$, and prescribe the condition $ds=px+qdy$ for every solution, any solution such as $z=\psi(x, y)$ will necessarily be associated with the equations $p=ds/dx, q=ds/dy$, and s will satisfy the equation in its original form. We have previously seen (under Pfaffian Expressions) that if five variables x, y, z, p, q , otherwise independent, be subject to $ds-px-qdy=0$, they must in fact be subject to at least three mutual relations. If we associate with a point (x, y, z) the plane

$$Z-s=p(X-x)+q(Y-y)$$

passing through it, where X, Y, Z are current co-ordinates, and call this association a surface-element; and if two consecutive elements of which the point $(x+dx, y+dy, z+dz)$ of one lies on the plane of the other, for which, that is, the condition $ds=px+qdy$ is satisfied, be said to be connected, and an infinity of connected elements following one another continuously be called a connectivity, then our statement is that a connectivity consists of not more than ∞^2 elements, the whole number of elements (x, y, z, p, q) that are possible being called ∞^4 . The solution of an equation $F(x, y, z, ds/dx, ds/dy)=0$ is then to be understood to mean finding in all possible ways, from the ∞^4 elements (x, y, z, p, q) which satisfy $F(x, y, z, p, q)=0$ a set of ∞^2 elements forming a connectivity; or, more analytically, finding in all possible ways two

relations $G=0, H=0$ connecting x, y, z, p, q and independent of $F=0$, so that the three relations together may involve

$$ds=px+qdy.$$

Such a set of three relations may, for example, be of the form $z=\psi(x, y), p=d\psi/dx, q=d\psi/dy$; but it may also, as another case, involve two relations $z=\psi(y), x=\psi_1(y)$ connecting x, y, z , the third relation being

$$\psi'(y)=p\psi_1'(y)+q.$$

the connectivity consisting in that case, geometrically, of a curve in space taken with ∞^2 of its tangent planes; or, finally, a connectivity is constituted by a fixed point and all the planes passing through that point. This generalized view of the meaning of a solution of $F=0$ is of advantage, moreover, in view of anomalies otherwise arising from special forms of the equation itself. For instance, we may include the case, some-
Meaning of a solution of the equation.

times arising when the equation to be solved is obtained by transformation from another equation, in which F does not contain either p or q . Then the equation has ∞^2 solutions, each consisting of an arbitrary point of the surface $F=0$ and all the ∞^2 planes passing through this point; it also has ∞^2 solutions, each consisting of a curve drawn on the surface $F=0$ and all the tangent planes of this curve, the whole consisting of ∞^2 elements; finally, it has also an isolated (or singular) solution consisting of the points of the surface, each associated with the tangent plane of the surface thereat, also ∞^2 elements in all. Or again, a linear equation $F=Pp+Qq-R=0$, wherein P, Q, R are functions of x, y, z only, has ∞^2 solutions, each consisting of one of the curves defined by

$$dx/P=dy/Q=ds/R$$

taken with all the tangent planes of this curve; and the same equation has ∞^2 solutions, each consisting of the points of a surface containing ∞^1 of these curves and the tangent planes of this surface. And for the case of n variables there is similarly the possibility of $n+1$ kinds of solution of an equation $F(x_1, \dots, x_n, z, p_1, \dots, p_n)=0$; these can, however, by a simple contact transformation be reduced to one kind, in which there is only one relation $z'=\psi(x_1, \dots, x_n)$ connecting the new variables x_1, \dots, x_n, z' (see under Pfaffian Expressions); just as in the case of the solution

$z=\psi(y), x=\psi_1(y), \psi'(y)=p\psi_1'(y)+q$ of the equation $Pp+Qq=R$ the transformation $z'=z-px, z'=p, p'=-x, y'=y, q'=q$ gives the solution

$$z'=\psi(y')+x\psi_1'(y'), p'=ds'/dx', q'=ds'/dy'$$

of the transformed equation. These explanations take no account of the possibility of p and q being infinite; this can be dealt with by writing $p=-u/w, q=-v/w$, and considering homogeneous equations in u, v, w , with $udx+vdy+wdz=0$ as the differential relation necessary for a connectivity; in practice we use the ideas associated with such a procedure more often without the appropriate notation.

In utilizing these general notions we shall first consider the theory of characteristic chains, initiated by Cauchy, which shows well the nature of the relations implied by the given differential equation; the alternative ways of carrying out the necessary integrations are suggested by considering the method of Jacobi and Mayer, while a good summary is obtained by the formulation in terms of a Pfaffian expression.

Order of the ideas.

Consider a solution of $F=0$ expressed by the three independent equations $F=0, G=0, H=0$. If it be a solution in which there is more than one relation connecting x, y, z , let new variables x', y', z', p', q' be introduced, as before explained under Pfaffian Expressions, in which s' is of the form

$$s'=s'-p_1x_1-\dots-p_nx_n(s=1 \text{ or } 2),$$

so that the solution becomes of a form $z'=\psi(x', y')$, $p'=d\psi/dx', q'=d\psi/dy'$, which then will identically satisfy the transformed equations $F'=0, G'=0, H'=0$. The equation $F'=0$, if x', y', z' be regarded as fixed, states that the plane $Z-s'=p'(X-x')+q'(Y-y')$ is tangent to a certain cone whose vertex is (x', y', z') , the consecutive point $(x'+dx', y'+dy', z'+dz')$ of the generator of contact being such that

$$dx' \frac{dF'}{dp'}=dy' \frac{dF'}{dq'}=ds' \left(p' \frac{dF'}{dp'}+q' \frac{dF'}{dq'} \right)$$

Passing in this direction on the surface $z'=\psi(x', y')$ the tangent

plane of the surface at this consecutive point is $(p'+dp', q'+dq')$, where, since $F'(x, y, \psi, d\psi/dx, d\psi/dy) = 0$ is identical, we have $dx'(dF'/dx + p'dF'/dx' + q'dF'/dy') = 0$. Thus the equations, which we shall call the characteristic equations,

$$dx' \left| \frac{dF'}{dp'} - dy' \left| \frac{dF'}{dq'} - dx' \right| \left(p' \frac{dF'}{dp'} + q' \frac{dF'}{dq'} \right) - dp' \left| \left(-\frac{dF'}{dp'} - p' \frac{dF'}{dx'} \right) - dq' \left| \left(-\frac{dF'}{dq'} - q' \frac{dF'}{dy'} \right) \right. \right.$$

are satisfied along a connectivity of ω^1 elements consisting of a curve on $s' = \psi(x, y)$ and the tangent planes of the surface along this curve. The equation $F' = 0$, when p, q are fixed, represents a curve in the plane $Z - s' = p'(X - x) + q'(Y - y)$ passing through (x, y, s') ; if $(x' + dx', y' + dy', s' + ds')$ be a consecutive point of this curve, we find at once

$$dx' \left(\frac{dF'}{dx'} + p' \frac{dF'}{dx} \right) + dy' \left(\frac{dF'}{dy'} + q' \frac{dF'}{dy} \right) = 0;$$

thus the equations above give $dx'dp' + dy'dq' = 0$, or the tangent line of the plane curve, is, on the surface $s' = \psi(x, y)$, in a direction conjugate to that of the generator of the cone. Putting each of the fractions in the characteristic equations equal to 0, the equations enable us, starting from an arbitrary element x, y, s, p, q, α , about which all the quantities $F', dF'/dx', \&c.$, occurring in the denominators, are developable, to define, from the differential equation $F' = 0$ alone, a connectivity of ω^1 elements, which we call a *characteristic chain*; and it is remarkable that when we transform again to the original variables (x, y, s, p, q) , the form of the differential equations for the chain is unaltered, so that they can be written down at once from the equation $F = 0$. Thus we have proved that the characteristic chain starting from any ordinary element of any integral of this equation $F = 0$ consists only of elements belonging to this integral. For instance, if the equation do not contain p, q , the characteristic chain, starting from an arbitrary plane through an arbitrary point of the surface $F = 0$, consists of a pencil of planes whose axis is a tangent line of the surface $F = 0$. Or if $F = 0$ be of the form $Pp + Qq = R$, the chain consists of a curve satisfying $dx/P + dy/Q = dz/R$ and a single infinity of tangent planes of this curve, determined by the tangent plane chosen at the initial point. In all cases there are ω^2 characteristic chains, whose aggregate may therefore be expected to exhaust the ω^4 elements satisfying $F = 0$.

Consider, in fact, a single infinity of connected elements each satisfying $F = 0$, say a chain connectivity T , consisting of elements specified by x, y, s, p, q , which we suppose expressed as functions of a parameter u , so that

as we know, but also $U = dx/ds - p dx/du - q dy/du$ is also zero. For

$$\frac{dU}{dt} = \frac{d}{dt} \left(\frac{dx}{ds} - p \frac{dx}{du} - q \frac{dy}{du} \right) = \frac{dp}{ds} \frac{dx}{ds} - \frac{dp}{ds} \frac{dx}{du} + \frac{dq}{ds} \frac{dy}{ds} - \frac{dq}{ds} \frac{dy}{du},$$

which is equal to

$$\frac{dp}{ds} \frac{dx}{ds} + \frac{dq}{ds} \left(\frac{dx}{ds} + p \frac{dx}{du} \right) + \frac{dq}{ds} \frac{dy}{ds} + \frac{dq}{ds} \left(\frac{dy}{ds} + q \frac{dy}{du} \right) = -\frac{dF}{ds} U.$$

As $\frac{dF}{ds}$ is a developable function of t , this giving

$$U = U_0 e^{\int \frac{dF}{ds} dt};$$

shows that U is everywhere zero. Thus integrals of $F = 0$ are obtainable by considering the aggregate of characteristic chains issuing from arbitrary chain connectivities T satisfying $F = 0$; and such connectivities T are, it is seen at once, determinable without integration. Conversely, as such a chain connectivity T can be taken out from the elements of any given integral all possible integrals are obtainable in this way. For instance, an arbitrary curve in space, given by $x = \theta(u), y = \phi(u), z = \psi(u)$, determines by the two equations $F(x, y, z, p, q) = 0, \psi'(u) = p\theta'(u) + q\phi'(u)$, such a chain connectivity T , through which then passes a perfectly definite integral of the equation $F = 0$. By taking ω^2 initial chain connectivities T , as for instance by taking the curves $x = 0, y = \phi, z = \psi$ to be the ω^2 curves upon an arbitrary surface, we thus obtain ω^2 integrals, and so ω^4 elements satisfying $F = 0$. In general, if functions G, H , independent of F , be obtained, such that the equations $F = 0, G = b, H = c$ represent an integral for all values of the constants b, c , these equations are said to constitute a *complete*

integral. Then ω^4 elements satisfying $F = 0$ are known, and in fact every other form of integral can be obtained without further integrations.

In the foregoing discussion of the differential equations of a characteristic chain, the denominators $dF/dp, \dots$ may be supposed to be modified in form by means of $F = 0$ in any way conducive to a simple integration. In the immediately following explanation of ideas, however, we consider indifferently all equations $F = \text{constant}$; when a function of x, y, s, p, q is said to be zero, it is meant that this is so identically, not in virtue of $F = 0$; in other words, we consider the integration of $F = a$, where a is an arbitrary constant. In the theory of linear partial equations we have seen that the integration of the equations of the characteristic chains, from which, as has just been seen, that of the equation $F = a$ follows at once, would be involved in completely integrating

the single linear homogeneous partial differential equation of the first order $[F] = 0$ where the notation is that explained above under *Contact Transformations*. One obvious integral is $f = F$. Putting $F = a$, where a is arbitrary, and eliminating one of the independent variables, we can reduce this equation $[F] = 0$ to one in our variables; and soon, calling, then, the determination of a single integral of a single homogeneous partial differential equation of the first order in s independent variables, an *operation of order n-1*, the characteristic chains, and therefore the most general integral of $F = a$, can be obtained by successive operations of orders 3, 2, 1. If, however, an integral of $F = a$ be represented by $F = a, G = b, H = c$, where b and c are arbitrary constants, the expression of the fact that a characteristic chain of $F = a$ satisfies $dG = 0$, gives $[FG] = 0$; similarly, $[FH] = 0$ and $[GH] = 0$, these three relations being identically true. Conversely, suppose that an integral G , independent of F , has been obtained of the equation $[F] = 0$, which is an operation of order three. Then it follows from

the identity $[f\psi\psi] + [\psi\psi\psi] + [\psi\psi\psi] = \frac{d}{ds}[\psi\psi] + \frac{d}{ds}[\psi] + \frac{d}{ds}[\psi]$ before remarked, by putting $\psi = F, \psi = G$, and then $[F] = A(f), [G] = B(f)$, that $AB(f) - BA(f) = \frac{d}{ds}B(f) - \frac{d}{ds}A(f)$, so that the two linear equations

$[F] = 0, [G] = 0$ form a complete system; as two integrals F, G are known, they have a common integral H , independent of F, G , determinable by an operation of order one only. The three functions F, G, H thus identically satisfy the relations $[FG] = [GH] = [FH] = 0$. The ω^3 elements satisfying $F = a, G = b, H = c$, wherein a, b, c are assigned constants, can then be seen to constitute an integral of $F = a$. For the conditions that a characteristic chain of $G = b$ issuing from an element satisfying $F = a, G = b, H = c$ should consist only of elements satisfying these three equations are simply $[FG] = 0, [GH] = 0$. Thus, starting from an arbitrary element of $F = a, G = b, H = c$, we can single out a connectivity of elements of $(F = a, G = b, H = c)$ forming a characteristic chain of $G = b$; then the aggregate of the characteristic chains of $F = a$ issuing from the elements of this characteristic chain of $G = b$ will be a connectivity consisting only of elements of

$$(F = a, G = b, H = c),$$

and will therefore constitute an integral of $F = a$; further, it will include all elements of $(F = a, G = b, H = c)$. This result follows also from a theorem given under *Contact Transformations*, which shows, moreover, that though the characteristic chains of $F = a$ are not determined by the three equations $F = a, G = b, H = c$, no further integration is now necessary to find them. By this theorem, since identically $[FG] = [GH] = [FH] = 0$, we can find, by the solution of linear algebraic equations only, a non-vanishing function ϵ and two functions A, C , such that

$$dC - CAdF - CdH = a(ds - pds - qdy);$$

thus all the elements satisfying $F = a, G = b, H = c$, satisfy $ds = pds + qdy$ and constitute a connectivity, which is therefore an integral of $F = a$. While, further, from the associated theorems, F, G, H, A, C are independent functions and $[FC] = 0$. Thus C may be taken to be the remaining integral independent of G, H , of the equation $[F] = 0$, whereby the characteristic chains are entirely determined. When we consider the particular equation $F = 0$, neglecting the case when neither p nor q enters, and supposing p to eliminate it from all other equations. Then instead of the equation $[F] = 0$, we have, if $F = 0$ give $p = \psi(x, y, s, q)$, the equation

$$qf - \left(\frac{dx}{ds} + p \frac{dx}{ds} \right) + \frac{dq}{ds} \left(\frac{dx}{ds} + p \frac{dx}{ds} \right) - \left(\frac{dy}{ds} + q \frac{dy}{ds} \right) \frac{df}{dq} = 0,$$

moreover obtainable by omitting the term in df/dp in $[p\psi, f] = 0$. Let x, y, s, q , be values about which the coefficients in this equation are developable, and let ξ, η, ω be the principal solutions reducing respectively to x, y and q when $x = x_0$. Then the equations $p = \psi, f = x_0, \eta = y_0, \omega = q_0$ represent a characteristic chain issuing from the element $x_0, y_0, s_0, \psi_0, q_0$; we have seen that the aggregate of such chains issuing from the elements of an arbitrary chain satisfying

$$ds - pds - qdy = 0$$

constitute an integral of the equation $p = \psi$. Let this arbitrary

Operations necessary for integration of $F = a$.

The single equation $F = 0$ and Pfaff's formulae.

chain be taken so that x_1 is constant; then the condition for initial values is only

$$dx_2 - q dy_1 = 0,$$

and the elements of the integral constituted by the characteristic chains issuing therefrom satisfy

$$dt - u d\eta = 0.$$

Hence this equation involves $ds - v dx - q dy = 0$, or we have

$$ds - v dx - q dy = \sigma(dt - u d\eta),$$

where σ is not zero. Conversely, the integration of $\rho = \psi$, is, essentially, the problem of writing the expression $ds - v dx - q dy$ in the form $\sigma(dt - u d\eta)$, as must be possible (from what was said under Pfaffian Expressions).

To integrate a system of simultaneous equations of the first order $X_1 = a_1, \dots, X_n = a_n$ in n independent variables x_1, \dots, x_n , and one dependent variable s , we write ρ_i for ds/dx_i , &c., and attempt to find $n+1-r$ further functions Z_1, X_{r+1}, \dots, X_n , such that the equations $Z = a, X_i = a_i (i=1, \dots, n)$ involve $ds - \rho_1 dx_1 - \dots - \rho_n dx_n = 0$. By an argument already given, the common integral, if existent, must be satisfied by the equations of the characteristic chains of any one equation $X_i = a_i$; thus each of the expressions $[X_i, X_j]$ must vanish in virtue of the equations expressing the integral, and we may without loss of generality assume that each of the corresponding $r(r-1)$ expressions formed from the r given differential equations vanishes in virtue of these equations. The determination of the remaining $n+1-r$ functions may, as before, be made to depend on characteristic chains, which in this case, however, are manifolds of r dimensions obtained by integrating the equations $[X_i, f] = 0, \dots, [X_j, f] = 0$; or having obtained one integral of this system other than X_1, \dots, X_n , say X_{r+1} , we may consider the system $[X_i, f] = 0, \dots, [X_{r+1}, f] = 0$, for which, again, we have a choice; and at any stage we may use Mayer's method and reduce the simultaneous linear equations to one equation involving parameters; while if at any stage of the process we find some but not all of the integrals of the simultaneous system, they can be used to simplify the remaining work; this can only be clearly explained in connexion with the theory of so-called function groups for which we have no space. One result arising is that the simultaneous system $\rho_1 = \phi_1, \dots, \rho_n = \phi_n$, wherein ρ_i are not involved in ϕ_1, ϕ_2 , if it satisfies the $r(r-1)$ relations $[\rho_1 - \phi_1, \rho_2 - \phi_2] = 0$, has a solution $s = \psi(x_1, \dots, x_n)$, $\rho_i = d\psi/dx_i, \dots, \rho_n = d\psi/dx_n$, reducing to an arbitrary function of x_1, \dots, x_n only, when $x_1 = x_1^0, \dots, x_n = x_n^0$ under certain conditions as to developability; a generalization of the theorem for linear equations. The problem of integration of this system is, as before, to put

$$ds - \phi_1 dx_1 - \dots - \phi_n dx_n - \rho_{r+1} dx_{r+1} - \dots - \rho_n dx_n$$

into the form $\sigma(dt - u_1 dx_1 - \dots - u_n dx_n)$; and here $f, \xi_1, \dots, \xi_r, u_1, \dots, u_n$ may be taken, as before, to be principal integrals of a certain complete system of linear equations; those, namely, determining the characteristic chains.

If L be a function of t and of the $2n$ quantities $x_1, \dots, x_n, z_1, \dots, z_n$, where z_i denotes dx_i/dt , &c., and if in the n equations

$$\frac{d(L)}{dt} = \frac{dL}{dx_1} \frac{dx_1}{dt} + \dots + \frac{dL}{dz_1} \frac{dz_1}{dt} = \frac{dL}{dx_1} z_1 + \dots + \frac{dL}{dz_1} z_1$$

we put $\rho_i = \frac{dL}{dx_i}$, and so express z_1, \dots, z_n in terms of $t, x_1, \dots, x_n, \rho_1, \dots, \rho_n$, assuming that the determinant of the quantities $\frac{d^2 L}{dx_i dx_j}$ is not zero; if, further, H denote the function of $t, x_1, \dots, x_n, \rho_1, \dots, \rho_n$, numerically equal to $\rho_1 z_1 + \dots + \rho_n z_n - L$, it is easy to prove that $d\rho_i/dt = -dH/dx_i$; $dx_i/dt = dH/d\rho_i$. These so-called canonical equations form part of those for the characteristic chains of the single partial equation

$ds/dt + H(t, x_1, \dots, x_n, ds/dx_1, \dots, ds/dx_n) = 0$, to which then the solution of the original equations for x_1, \dots, x_n can be reduced. It may be shown (1) that if $s = \psi(t, x_1, \dots, x_n, c_1) + c_1$ be a complete integral of this equation, then $\rho_i = d\psi/dx_i, d\psi/dc_1 = c_1$ are $2n$ equations giving the solution of the canonical equations referred to, where c_1, \dots, c_n and ϕ_1, \dots, ϕ_n are arbitrary constants; (2) that if $x_1 = X_1(t, x_2^0, \dots, x_n^0), \rho_1 = P_1(t, x_2^0, \dots, x_n^0)$ be the principal solutions of the canonical equations for t, x_2^0, \dots, x_n^0 , and ω denote the result of substituting these values in $\rho_1 dH/d\rho_1 + \dots + \rho_n dH/d\rho_n - H$, and $\Omega = \int \omega dt$, where, after integration, Ω is to be expressed as a function of $t, x_1^0, \dots, x_n^0, x_1^0, \dots, x_n^0$, then $s = \Omega + \psi$ is a complete integral of the partial equation.

A system of differential equations is said to allow a certain continuous group of transformations (see GROUPS, THEORY OF) when the introduction for the variables in the differential equations of the new variables given by the equations of the group leads, for all values of the parameters of the group, to the same differential equations in the new variables. It would be interesting to verify in examples that this is the case in at least the majority of the differential equations which are known to be integrable in finite terms. We give a theorem of very general application for the case of a simultaneous complete

system of linear partial homogeneous differential equations of the first order, to the solution of which the various differential equations discussed have been reduced. It will be enough to consider whether the given differential equations allow the infinitesimal transformations of the group.

It can be shown easily that sufficient conditions in order that a complete system $\Pi_1 f = 0, \dots, \Pi_r f = 0$, in n independent variables, should allow the infinitesimal transformation $Pf = 0$ are expressed by k equations $\Pi_1 P - P \Pi_1 f = \lambda_{11} \Pi_1 f + \dots + \lambda_{r1} \Pi_r f$. Suppose now a complete system of $n-r$ equations in n variables to allow a group of r infinitesimal transformations $(P_1 f, \dots, P_r f)$ which has an invariant subgroup of $r-1$ parameters $(P_1' f, \dots, P_{r-1}' f)$, it being supposed that the n quantities $\Pi_1 f, \dots, \Pi_{r-1} f, P_1 f, \dots, P_{r-1} f$ are not connected by an identical linear equation (with coefficients even depending on the independent variables). Then it can be shown that one solution of the complete system is determinable by a quadrature. For each of $\Pi_1 P - P \Pi_1 f$ is a linear function of $\Pi_1 f, \dots, \Pi_{r-1} f$ and the simultaneous system of independent equations $\Pi_1 f = 0, \dots, \Pi_{r-1} f = 0, P_1 f = 0, \dots, P_{r-1} f = 0$ is therefore a complete system, allowing the infinitesimal transformation $P_1 f$. This complete system of $n-1$ equations has therefore one common solution ω , and $P_1 \omega = 1$ is a function of ω . By choosing ω suitably, we can then make $P_1(\omega) = 1$. From this equation and the $n-1$ equations $\Pi_1 \omega = 0, \dots, \Pi_{r-1} \omega = 0$, we can determine ω by a quadrature only. Hence can be deduced a much more general result, that if the group of r parameters be integrable, the complete system can be entirely solved by quadratures; it is only necessary to introduce the solution found by the first quadrature as an independent variable, whereby we obtain a complete system of $n-r$ equations in $n-1$ variables, subject to an integrable group of $r-1$ parameters, and to continue this process. We give some examples of the application of the theorem. (1) If an equation of the first order $y' = \psi(x, y)$ allow the infinitesimal transformation $\xi dx + \eta dy$, the integral curves $\omega(x, y) = y^0$, wherein $\omega(x, y)$ is the solution of $\frac{d\omega}{dx} + \psi(x, y) \frac{d\omega}{dy} = 0$ reducing to y for $x = x^0$, are interchanged among themselves by the infinitesimal transformation, or $\omega(x, y)$ can be chosen to make $\xi d\omega/dx + \eta d\omega/dy = 1$; this, with $d\omega/dx + \psi d\omega/dy = 0$, determines ω as the integral of the complete differential $(dy - \psi dx)/(\eta - \psi \xi)$. This result itself shows that every ordinary differential equation of the first order is subject to an infinite number of infinitesimal transformations. But every infinitesimal transformation $\xi dx + \eta dy$ can be changed by variables (after integration) be brought to the form $d\omega/dy$, and all differential equations of the first order allowing this group can then be reduced to the form $F(x, d\omega/dx) = 0$. (2) In an ordinary equation of the second order $y'' = \psi(x, y, y')$, equivalent to $d^2 y/dx^2 = \psi(x, y, y')$, if H, H_1 be the solutions for y and y_1 chosen to reduce to y' and y'' when $x = x^0$, and the equations $H = y, H_1 = y_1$ be equivalent to $x = y^0, \omega = y_1^0$, then ω, ω_1 are the principal solutions of $\Pi f = d^2 f/dx^2 + y_1 d^2 f/dy^2 + y_1' d^2 f/dy dy_1 = 0$. If the original equation allow an infinitesimal transformation whose first extended form (see GROUPS) is $Pf = \xi f/dx + \eta f/dy + \eta_1 f/dy_1$, where $\eta_1 dt$ is the increment of $d^2 y/dx^2$ when $\xi dx, \eta dy$ are the increments of x, y , and is to be expressed in terms of x, y, y_1 , then each of $P\omega$ and $P\omega_1$ must be functions of ω and ω_1 , or the partial differential equation Πf must allow the group Pf . Thus by our general theorem, if the differential equation allow a group of two parameters (and such a group is always integrable), it can be solved by quadratures, our explanation sufficing, however, only provided the form Πf and the two infinitesimal transformations are not linearly connected. It can be shown, from the fact that η is a quadratic polynomial in y_1 , that no differential equation of the second order can allow more than 8 really independent infinitesimal transformations, and that every homogeneous linear differential equation of the second order allows just 8, being in fact reducible to $d^2 y/dx^2 = 0$. Since every group of more than two parameters has subgroups of two parameters, a differential equation of the second order allowing a group of more than two parameters can, as a rule, be solved by quadratures. By transforming the group we see that if a differential equation of the second order allows a single infinitesimal transformation, it can be transformed to the form $F(x, d^2 y/dx^2, d^2 y/dx^2)$; this is not the case for every differential equation of the third order; (3) For an ordinary differential equation of the third order, allowing an integrable group of three parameters whose infinitesimal transformations are not linearly connected with the partial equation to which the solution of the given ordinary equation is reducible, the similar result follows that it can be integrated by quadratures. But if the group of three parameters be simple, this result must be replaced by the statement that the integration is reducible to quadratures and that of a so-called Riccati equation of the first order, of the form $d^2 y/dx^2 = A + By + Cy^2$, where A, B, C are functions of x . (4) Similarly for the integration by quadratures of an ordinary equation $y'' = \psi(x, y, y_1, \dots, y_{n-1})$ of any order. Moreover, the group allowed by the equation may quite well consist of extended contact transformations. An important application is to the case where the differential equation is the resolvent equation defining the group of

system of linear partial homogeneous differential equations of the first order, to the solution of which the various differential equations discussed have been reduced. It will be enough to consider whether the given differential equations allow the infinitesimal transformations of the group.

It can be shown easily that sufficient conditions in order that a complete system $\Pi_1 f = 0, \dots, \Pi_r f = 0$, in n independent variables, should allow the infinitesimal transformation $Pf = 0$ are expressed by k equations $\Pi_1 P - P \Pi_1 f = \lambda_{11} \Pi_1 f + \dots + \lambda_{r1} \Pi_r f$. Suppose now a complete system of $n-r$ equations in n variables to allow a group of r infinitesimal transformations $(P_1 f, \dots, P_r f)$ which has an invariant subgroup of $r-1$ parameters $(P_1' f, \dots, P_{r-1}' f)$, it being supposed that the n quantities $\Pi_1 f, \dots, \Pi_{r-1} f, P_1 f, \dots, P_{r-1} f$ are not connected by an identical linear equation (with coefficients even depending on the independent variables). Then it can be shown that one solution of the complete system is determinable by a quadrature. For each of $\Pi_1 P - P \Pi_1 f$ is a linear function of $\Pi_1 f, \dots, \Pi_{r-1} f$ and the simultaneous system of independent equations $\Pi_1 f = 0, \dots, \Pi_{r-1} f = 0, P_1 f = 0, \dots, P_{r-1} f = 0$ is therefore a complete system, allowing the infinitesimal transformation $P_1 f$. This complete system of $n-1$ equations has therefore one common solution ω , and $P_1 \omega = 1$ is a function of ω . By choosing ω suitably, we can then make $P_1(\omega) = 1$. From this equation and the $n-1$ equations $\Pi_1 \omega = 0, \dots, \Pi_{r-1} \omega = 0$, we can determine ω by a quadrature only. Hence can be deduced a much more general result, that if the group of r parameters be integrable, the complete system can be entirely solved by quadratures; it is only necessary to introduce the solution found by the first quadrature as an independent variable, whereby we obtain a complete system of $n-r$ equations in $n-1$ variables, subject to an integrable group of $r-1$ parameters, and to continue this process. We give some examples of the application of the theorem. (1) If an equation of the first order $y' = \psi(x, y)$ allow the infinitesimal transformation $\xi dx + \eta dy$, the integral curves $\omega(x, y) = y^0$, wherein $\omega(x, y)$ is the solution of $\frac{d\omega}{dx} + \psi(x, y) \frac{d\omega}{dy} = 0$ reducing to y for $x = x^0$, are interchanged among themselves by the infinitesimal transformation, or $\omega(x, y)$ can be chosen to make $\xi d\omega/dx + \eta d\omega/dy = 1$; this, with $d\omega/dx + \psi d\omega/dy = 0$, determines ω as the integral of the complete differential $(dy - \psi dx)/(\eta - \psi \xi)$. This result itself shows that every ordinary differential equation of the first order is subject to an infinite number of infinitesimal transformations. But every infinitesimal transformation $\xi dx + \eta dy$ can be changed by variables (after integration) be brought to the form $d\omega/dy$, and all differential equations of the first order allowing this group can then be reduced to the form $F(x, d\omega/dx) = 0$. (2) In an ordinary equation of the second order $y'' = \psi(x, y, y')$, equivalent to $d^2 y/dx^2 = \psi(x, y, y')$, if H, H_1 be the solutions for y and y_1 chosen to reduce to y' and y'' when $x = x^0$, and the equations $H = y, H_1 = y_1$ be equivalent to $x = y^0, \omega = y_1^0$, then ω, ω_1 are the principal solutions of $\Pi f = d^2 f/dx^2 + y_1 d^2 f/dy^2 + y_1' d^2 f/dy dy_1 = 0$. If the original equation allow an infinitesimal transformation whose first extended form (see GROUPS) is $Pf = \xi f/dx + \eta f/dy + \eta_1 f/dy_1$, where $\eta_1 dt$ is the increment of $d^2 y/dx^2$ when $\xi dx, \eta dy$ are the increments of x, y , and is to be expressed in terms of x, y, y_1 , then each of $P\omega$ and $P\omega_1$ must be functions of ω and ω_1 , or the partial differential equation Πf must allow the group Pf . Thus by our general theorem, if the differential equation allow a group of two parameters (and such a group is always integrable), it can be solved by quadratures, our explanation sufficing, however, only provided the form Πf and the two infinitesimal transformations are not linearly connected. It can be shown, from the fact that η is a quadratic polynomial in y_1 , that no differential equation of the second order can allow more than 8 really independent infinitesimal transformations, and that every homogeneous linear differential equation of the second order allows just 8, being in fact reducible to $d^2 y/dx^2 = 0$. Since every group of more than two parameters has subgroups of two parameters, a differential equation of the second order allowing a group of more than two parameters can, as a rule, be solved by quadratures. By transforming the group we see that if a differential equation of the second order allows a single infinitesimal transformation, it can be transformed to the form $F(x, d^2 y/dx^2, d^2 y/dx^2)$; this is not the case for every differential equation of the third order; (3) For an ordinary differential equation of the third order, allowing an integrable group of three parameters whose infinitesimal transformations are not linearly connected with the partial equation to which the solution of the given ordinary equation is reducible, the similar result follows that it can be integrated by quadratures. But if the group of three parameters be simple, this result must be replaced by the statement that the integration is reducible to quadratures and that of a so-called Riccati equation of the first order, of the form $d^2 y/dx^2 = A + By + Cy^2$, where A, B, C are functions of x . (4) Similarly for the integration by quadratures of an ordinary equation $y'' = \psi(x, y, y_1, \dots, y_{n-1})$ of any order. Moreover, the group allowed by the equation may quite well consist of extended contact transformations. An important application is to the case where the differential equation is the resolvent equation defining the group of

Application of theory of continuous groups to formal theories.

Application of theory of continuous groups to formal theories.

Application of theory of continuous groups to formal theories.

Application of theory of continuous groups to formal theories.

Application of theory of continuous groups to formal theories.

Application of theory of continuous groups to formal theories.

Application of theory of continuous groups to formal theories.

transformations or rationality group of another differential equation (see below); in particular, when the rationality group of an ordinary linear differential equation is integrable, the equation can be solved by quadratures.

Following the practical and provisional division of theories of differential equations, to which we alluded at starting, into transformation theories and function theories, we pass now to give some account of the latter. These are both a necessary logical complement of the former, and the only remaining resource when the expedients of the former have been exhausted. While in the former investigations we have dealt only with values of the independent variables about which the functions are developable, the leading idea now becomes, as was long ago remarked by G. Green, the consideration of the neighbourhood of the values of the variables for which this developable character ceases. Beginning, as before, with existence theorems applicable for ordinary values of the variables, we are to consider the cases of failure of such theorems.

When in a given set of differential equations the number of equations is greater than the number of dependent variables, the equations cannot be expected to have common solutions unless certain conditions of compatibility, obtainable by equating different forms of the same differential coefficients deducible from the equations, are satisfied. We have had examples in systems of linear equations, and in the case of a set of equations $y_1 = \phi_1, \dots, y_p = \phi_p$. For the case when the number of equations is the same as that of dependent variables, the following is a general theorem which should be referred to: Let there be r equations in r dependent variables x_1, \dots, x_r and n independent variables x_0, \dots, x_n ; let the differential coefficient of x_0 of highest order which enters be of order k_0 , and suppose $d^k x_0/dx_0^k = \Phi_0$, so that the equations can be written $d^k x_0/dx_0^k = \Phi_0$, where in the general differential coefficient of x_0 which enters in Φ_0 , say

$$d^{k_1} x_1 \dots d^{k_p} x_p / dx_0^{k_1} \dots dx_0^{k_p},$$

we have $k_1 < k_0$ and $k_1 + \dots + k_p < k_0$. Let $a_1, \dots, a_n, b_1, \dots, b_n$ and b_0, \dots, b_n be a set of values of x_1, \dots, x_n, x_0 .

and of the differential coefficients entering in Φ_0 about which all the functions Φ_1, \dots, Φ_r are developable. Corresponding to each dependent variable x_i , we take now a set of k_i functions of x_2, \dots, x_n , say $\phi_1, \phi_2, \dots, \phi_{k_i}$ arbitrary save that they must be developable about a_2, a_3, \dots, a_n , and such that for these values of x_2, \dots, x_n , the function ϕ_i reduces to b_i , and the differential coefficient

$$d^{k_1} x_1 \dots d^{k_p} x_p / dx_2^{k_1} \dots dx_2^{k_p}$$

reduces to b^p . Then the theorem is that there exists one, and only one, set of functions x_1, \dots, x_r of x_2, \dots, x_n developable about a_2, \dots, a_n , satisfying the given differential equations, and such that for $x_2 = a_2$ we have

$$x_1 = \phi_1, dx_2/dx_2 = \phi_2^{(1)}, \dots, d^{k_r-1} x_r/dx_2^{k_r-1} = \phi_r^{(k_r-1)}.$$

And, moreover, if the arbitrary functions ϕ_1, ϕ_2, \dots contain a certain number of arbitrary variables h_1, \dots, h_m , and be developable about the values h_1^0, \dots, h_m^0 of these variables, the solutions x_1, \dots, x_r will contain h_1, \dots, h_m , and be developable about h_1^0, \dots, h_m^0 .

The proof of this theorem may be given by showing that if ordinary power series in $x_1 - a_1, \dots, x_n - a_n, h_1 - h_1^0, \dots, h_m - h_m^0$ be substituted in the equations wherein in x_0 the coefficients of $(x_1 - a_1)^p, x_1 - a_1, \dots, (x_1 - a_1)^{k_1-1}$ are the arbitrary functions $\phi_1, \phi_2, \dots, \phi_{k_1}^{(1)}, \dots, \phi_{k_1}^{(k_1-1)}$, divided respectively by 1, 1!, 2!, &c., then the differential equations determine uniquely all the other coefficients, and that the resulting series are convergent. We rely, in fact, upon the theory of monogenic analytical functions (see FUNCTION), a function being determined entirely by its development in the neighbourhood of one set of values of the independent variables, from which all its other values arise by continuation; it being of course understood that the coefficients in the differential equations are to be continued at the same time. But it is to be remarked that there is no ground for believing, if this method of continuation be

utilized, that the function is single-valued; we may quite well return to the same values of the independent variables with a different value of the function, belonging, as we say, to a different branch of the function; and there is even no reason for assuming that the number of branches is finite, or that different branches have the same singular points and regions of existence. Moreover, and this is the most difficult consideration of all, all these circumstances may be dependent upon the values supposed given to the arbitrary constants of the integral; in other words, the singular points may be either fixed, being determined by the differential equations themselves, or they may be movable with the variation of the arbitrary constants of integration. Such difficulties arise even in establishing the reversion of an elliptic integral, in solving the equation

Singular points of solutions.

$$\left(\frac{dx}{x}\right)^2 = (x-a_1)(x-a_2)(x-a_3)(x-a_4);$$

about an ordinary value the right side is developable; if we put $x-a_1 = h^2$, the right side becomes developable about $h=0$; if we put $x=1/h$, the right side of the changed equation is developable about $h=0$; it is quite easy to show that the integral reducing to a definite value x_0 for a value x_0 is obtainable by a series in integral powers; this, however, must be supplemented by showing that for no value of x does the value of x become entirely undetermined.

These remarks will show the place of the theory now to be sketched of a particular class of ordinary linear homogeneous differential equations whose importance arises from the completeness and generality with which they can be discussed. We have seen that if in the equations $Linear differential equations with rational coefficients.$

$dy/dx = y_1, dy_1/dx = y_2, \dots, dy_{n-1}/dx = y_n,$
 $dy_{n-1}/dx = a_0 y + a_1 y_1 + \dots + a_{n-1} y_{n-1},$ where a_1, a_2, \dots, a_n are now to be taken to be rational functions of x , the value x^2 be one for which no one of these rational functions is infinite, and y, y_1, \dots, y_{n-1} be quite arbitrary finite values, then the equations are satisfied by

$$y = y^0 u + y^1 u_1 + \dots + y^{n-1} u_{n-1},$$

where u, u_1, \dots, u_{n-1} are functions of x , independent of y, \dots, y_{n-1} , developable about $x=x^2$; this value of y is such that for $x=x^2$ the functions y, y_1, \dots, y_{n-1} reduce respectively to $y^0, y_1^0, \dots, y_{n-1}^0$; it can be proved that the region of existence of these series extends within a circle centre x^2 and radius equal to the distance from x^2 of the nearest point at which one of a_1, \dots, a_n becomes infinite. Now consider a region enclosing x^2 , and only one of the places, say Z , at which one of a_1, \dots, a_n becomes infinite. When x is made to describe a closed curve in this region, including this point Z in its interior, it may well happen that the continuations of the functions u, u_1, \dots, u_{n-1} give, when we have returned to the point x^2 , values $y^1, y_1^1, \dots, y_{n-1}^1$, so that the integral under consideration becomes changed to $y^1 + y_1^1 y_1 + \dots + y_{n-1}^1 y_{n-1}$. At x^2 let this branch and the corresponding values of y_1, \dots, y_{n-1} be $y^0, y_1^0, \dots, y_{n-1}^0$; then, as there is only one series satisfying the equation and reducing to $(y^0, y_1^0, \dots, y_{n-1}^0)$ for $x=x^2$, and the coefficients in the differential equation are single-valued functions, we must have $y^1 + y_1^1 u_1 + \dots + y_{n-1}^1 u_{n-1} = y^0 + y_1^0 y_1 + \dots + y_{n-1}^0 y_{n-1}$; as this holds for arbitrary values of y^0, \dots, y_{n-1}^0 , upon which u, \dots, u_{n-1} and y^0, \dots, y_{n-1}^0 do not depend, it follows that each of u, \dots, u_{n-1} is a linear function of u, \dots, u_{n-1} with constant coefficients, say $y_1 = A_{11} u + \dots + A_{1n-1} u_{n-1}$. Then

$$y^1 u + \dots + y^{n-1} u_{n-1} = (Z_1 A_{11} y_1^0) u + \dots + (Z_1 A_{1n-1} y_1^0) u_{n-1};$$

this is equal to $\mu(y^0 u + \dots + y^{n-1} u_{n-1})$ if $Z_1 A_{11} y_1^0 = \mu y^0$; eliminating y^0, \dots, y^{n-1} from these linear equations, we have a determinantal equation of order n for μ ; let μ_1 be one of its roots; determining the ratios of $y^0, y_1^0, \dots, y_{n-1}^0$ to satisfy the linear equations, we have thus proved that there exists an integral, H , of the equation, which when continued round the point Z and back to the starting-point, becomes changed to $H_1 = \mu_1 H$. Let now ξ be the value of x at Z and r_1 one of the values of $(1/2\pi i) \log \mu_1$; consider the function $(x-\xi)^{-r_1} H$; when x makes a circuit round $x=\xi$, this becomes changed to

$$\exp(-2\pi i r_1) (x-\xi)^{-r_1} H,$$

that is, is unchanged; thus we may put $H = (x-\xi)^{r_1} \phi_1$, ϕ_1 being a function single-valued for paths in the region considered described about Z , and therefore, by Laurent's Theorem (see FUNCTION), capable of expression in the annular region about this point by a series of positive and negative integral powers of $x-\xi$, which in general may contain an infinite number of negative powers; there is, however, no reason to suppose r_1 to be an integer, or even real. Thus, if all the roots of the determinantal equation in μ are different, we obtain n integrals of the forms $(x-\xi)^{r_1} \phi_1, \dots, (x-\xi)^{r_{n-1}} \phi_{n-1}$. In general we obtain as many integrals of this form as there are really different roots; and the problem arises to discover, in case a root be k times repeated, $k-1$ equations of as simple a form as possible to replace the $k-1$ equations of the form $y^0 u + \dots + y^{n-1} u_{n-1} = \mu(y^0 u + \dots + y^{n-1} u_{n-1})$ which would have existed had the roots been different. The most natural method of obtaining a suggestion lies probably in remarking that if $r_2 = r_1 + h$, there is an integral $[(x-\xi)^{r_1} \phi_1 - (x-\xi)^{r_1} \phi_2]/h$, where the coefficients in ϕ_2 are

the same functions of $r_1 + k$ as are the coefficients in ϕ_1 of r_1 ; when k vanishes, this integral takes the form

$$(x-\xi)^{-1} \left[\frac{d}{dx} \phi_1 + \phi_1 \log(x-\xi) \right]$$

or say denoting this by $2\pi i \mu_k K$, and $(x-\xi)^{-1} \phi_1$ by H_1 , a circuit of the point ξ changes K into

$$K' = \frac{1}{2\pi i \mu_1} \left[e^{2\pi i r_1} (x-\xi)^{-r_1} \phi_1 + e^{2\pi i r_2} (x-\xi)^{-r_2} \phi_1 (2\pi i + \log(x-\xi)) \right] = \mu_1 K + H_1$$

A similar argument suggests itself when three of the roots of the determinantal equation are the same, and so on. We are thus led to the result, which is justified by an examination of the algebraic conditions, that whatever may be the circumstances as to the roots of the determinantal equation, n integrals exist, breaking up into batches, the values of the constituents H_1, H_2, \dots of a batch after circuit about $x = \xi$ being $H_1' = \mu_1 H_1, H_2' = \mu_2 H_2 + H_1, H_3' = \mu_3 H_3 + H_2$, and so on. And this is found to lead to the forms $(x-\xi)^{-1} \phi_1, (x-\xi)^{-1} (\phi_1 + \phi_2 \log(x-\xi)), (x-\xi)^{-1} (\phi_1 + \phi_2 \log(x-\xi) + \phi_3 (\log(x-\xi))^2)$, and so on. Here each of $\phi_1, \phi_2, \phi_3, \dots$ is a series of positive and negative integral powers of $x-\xi$ in which the number of negative powers may be infinite.

It appears natural enough now to inquire whether, under proper conditions for the forms of the rational functions ϕ_1, \dots, ϕ_m , it may be possible to ensure that in each of the series ϕ_1, ϕ_2, \dots the number of negative powers shall be finite. Herein lies, in fact, the limitation which experience has shown to be justified by the completeness of the results obtained. Assuming n integrals in which in each of ϕ_1, ϕ_2, \dots the number of negative powers is finite, there is a definite homogeneous linear differential equation having these integrals; this is found by forming it to have the form

$$y^{(n)} + a_{n-1}(x-\xi)^{-1} y^{(n-1)} + \dots + a_1(x-\xi)^{-1} y' + a_0 y = 0$$

where b_1, \dots, b_n are finite for $x=\xi$. Conversely, assume the equation to have this form. Then on substituting a series of the form $(x-\xi)^{-1} [A_1(x-\xi) + A_2(x-\xi)^2 + \dots]$ and equating the coefficients of like powers of $x-\xi$, it is found that r must be a root of an algebraic equation of order n ; this equation, which we shall call the index equation, can be obtained at once by substituting for y only $(x-\xi)^r$ and replacing each of b_1, \dots, b_n by their values at $x=\xi$; arrange the roots r_1, r_2, \dots of this equation so that the real part of r_1 is equal to, or greater than, the real part of r_{i+1} , and take r equal to r_1 ; it is found that the coefficients A_1, A_2, \dots are uniquely determinate, and that the series converges within a circle about $x=\xi$ which includes no other of the points at which the rational functions ϕ_1, \dots, ϕ_m become infinite. We have thus a solution $H_1 = (x-\xi)^{-1} \phi_1$ of the differential equation. If we now substitute in the equation $y = H_1 g(x)$, it is found to reduce to an equation of order $n-1$ for g of the form

$$g^{(n-1)} + c_{n-1}(x-\xi)^{-1} g^{(n-2)} + \dots + c_1(x-\xi)^{-1} g' + c_0 g = 0$$

where c_1, \dots, c_{n-1} are not infinite at $x=\xi$. To this equation precisely similar reasoning can then be applied; its index equation has in fact the roots $r_2 - r_1 - 1, \dots, r_{n-1} - r_1 - 1$; if $r_2 - r_1$ be zero, the integral $(x-\xi)^{-1} \phi_2$ of the η equation will give an integral of the original equation containing $\log(x-\xi)$; if $r_2 - r_1$ be an integer, and therefore a negative integer, the same will be true, unless in ϕ_2 the term in $(x-\xi)^{-r_2}$ be absent; if neither of these arise, the original equation will have an integral $(x-\xi)^{-r_2} \phi_2$. The η equation can now, by means of the one integral of η belonging to the index $r_2 - r_1 - 1$, be similarly reduced to one of order $n-2$, and so on. The result will be that stated above. We shall say that an equation of the form in question is regular about $x=\xi$.

We may examine in this way the behaviour of the integrals at all the points at which any one of the rational functions ϕ_1, \dots, ϕ_m becomes infinite; in general we must expect that beside these the value $x=\infty$ will be a singular point for the differential equation. To test this we put $x=1/t$ throughout, and examine as before at $t=0$. For instance, the ordinary linear equation with constant coefficients has no singular point for finite values of x ; at $x=\infty$ it has a singular point and is not regular; or again, Bessel's equation $x^2 y'' + xy' + (x^2 - \nu^2)y = 0$ is singular about $x=0$, but not about $x=\infty$. An equation regular at all the finite singularities and also at $x=\infty$ is called a Fuchsian equation. We proceed to examine particularly the case of an equation of the second order

$$y'' + ay' + by = 0$$

Putting $x=1/t$, it becomes

$$t^2 y'' + (2t^2 - at^3) y' + bt^4 y = 0$$

which is not regular about $t=0$ unless $2-at^3$ and bt^4 , that is, unless ax and bx^2 are finite at $x=\infty$, which we thus assume; putting $y = t^r (1 + A_1 t + \dots)$, we find for the index equation at $x=\infty$ the equation $r(r-1) + r(2-ax) + bx^2 = 0$. If there be finite singular points at x_1, x_2, \dots, x_m , where we assume $m > 1$, the cases $m=0, m=1$ being easily dealt with, and if $\phi(x) = (x-\xi_1) \dots (x-\xi_m)$, we must have $a\phi(x)$ and $b[\phi(x)]^2$ finite for all finite values of x , equal say to the respective polynomials $\psi(x)$ and $\theta(x)$, of which by the conditions at $x=\infty$ the highest respective orders possible are $m-1$ and $2(m-1)$.

The index equation at $x=\xi_i$ is $r(r-1) + r\psi(\xi_i)/\phi(\xi_i) + \theta(\xi_i)/[\phi(\xi_i)]^2 = 0$, and if α_1, β_1 be its roots, we have $\alpha_1 + \beta_1 = 1 - \psi(\xi_i)/\phi(\xi_i)$ and $\alpha_1 \beta_1 = \theta(\xi_i)/[\phi(\xi_i)]^2$. By its roots, we have $\alpha_1 + \beta_1 = 1 - \psi(\xi_i)/\phi(\xi_i)$ and $\alpha_1 \beta_1 = \theta(\xi_i)/[\phi(\xi_i)]^2$. For this, by an elementary theorem of algebra, the sum $\sum (1 - \alpha_i - \beta_i)/(x-\xi_i)$, extended to the m finite singular points, is equal to $\psi(x)/\phi(x)$, and the sum $\sum (1 - \alpha_i - \beta_i)$ is equal to the ratio of the coefficients of the highest powers of x in $\psi(x)$ and $\phi(x)$, and therefore equal to $1 + a + b$, where a, b are the indices at $x=\infty$. Further, if in $(1, m)$ denote the integral part of the quotient $\theta(x)/\phi(x)$, we have $\sum \alpha_i \beta_j \phi(\xi_i)/\phi(\xi_j)$ equal to $-(x, 1)_{m-1} + \theta(x)/\phi(x)$, and the coefficient of x^{m-2} in $(x, 1)_{m-1}$ is $a\beta$. Thus the differential equation has the form

$$y'' + y \sum (1 - \alpha_i - \beta_i)/(x-\xi_i) + y(x, 1)_{m-1} + \sum \alpha_i \beta_j \phi(\xi_i)/\phi(\xi_j) = 0$$

If, however, we make a change in the dependent variable, putting $y = (x-\xi_1)^{\lambda_1} \dots (x-\xi_m)^{\lambda_m}$, it is easy to see that the equation changes into one having the same singular points about each of which it is regular, and that the indices at $x=\xi_i$ become $\alpha_i + \beta_i - \lambda_i$, which we shall denote by λ_i , for $(x-\xi_i)^{\lambda_i}$ can be developed in positive integral powers of $x-\xi_i$, about $x=\xi_i$; by this transformation the indices at $x=\infty$ are changed to

$$a + \alpha_1 + \dots + \alpha_m, \beta + \beta_1 + \dots + \beta_m$$

which we shall denote by λ, μ . If we suppose this change to have been introduced, and still denote the independent variable by y , the equation has the form

$$y'' + y \sum (1 - \lambda_i - \mu_i)/(x-\xi_i) + y(x, 1)_{m-1} = 0$$

while $\lambda + \mu + \lambda_1 + \dots + \lambda_m = m - 1$. Conversely, it is easy to verify that if λ, μ be the coefficient of x^{m-1} in $(x, 1)_{m-1}$, this equation has the specified singular points and indices whatever be the other coefficients in $(x, 1)_{m-1}$.

Thus we see that (beside the cases $m=0, m=1$) the "Fuchsian equation" of the second order with two finite singular points is distinguished by the fact that it has a definite form when the singular points and the indices are assigned. In that case, putting $(x-\xi_i)/\phi(x) = 1/(i-1)$, the singular points are transformed to $1, \infty$, and, as is clear, without change of indices. Still denoting the independent variable by x , the equation then has the form

$$x(1-x)y'' + y[1-\lambda_1 - x(1+\lambda_1+\mu)] - \lambda_2 \mu y = 0$$

which is the ordinary hypergeometric equation. Provided none of $\lambda_1, \lambda_2, \lambda - \mu$ be zero or integral about $x=0$, it has the solutions

$$F(\lambda, \mu, 1-\lambda_1, x), x^{\lambda_1} F(\lambda+\lambda_1, \mu+\lambda_1, 1+\lambda_1, x);$$

about $x=1$ it has the solutions

$$F(\lambda, \lambda_1, 1-\lambda_1, 1-x), (1-x)^{\lambda_2} F(\lambda+\lambda_1, \mu+\lambda_1, 1+\lambda_1, 1-x),$$

where $\lambda + \mu + \lambda_1 + \lambda_2 = 1$; about $x=\infty$ it has the solutions

$$x^{-\lambda} F(\lambda, \lambda+\lambda_1, \lambda-\mu+1, x^{-1}), x^{-\mu} F(\mu, \mu+\lambda_1, \mu-\lambda+1, x^{-1}),$$

where $F(\alpha, \beta, \gamma, x)$ is the series $\sum \frac{\alpha \beta \dots (\alpha + \beta - 1) x^k}{k! \gamma (\gamma + 1) \dots (\gamma + k - 1)}$, which converges when $|x| < 1$, whatever α, β, γ may be, converges for all values of x for which $|x| = 1$ provided the real part of $\gamma - \alpha - \beta < 0$ algebraically, and converges for all these values except $x=1$ provided the real part of $\gamma - \alpha - \beta > -1$ algebraically. In accordance with our general theory, logarithms may be expected in the solution when one of $\lambda_1, \lambda_2, \lambda - \mu$ is zero or integral. Indeed when λ_1 is a negative integer, not zero, the second solution about $x=0$ would contain vanishing factors in the denominators of its coefficients; in case λ or μ be one of the positive integers $1, 2, \dots, (-\lambda_1)$, vanishing factors occur also in the numerators; and then, in fact, the second solution about $x=0$ becomes x^{λ_1} times an integral polynomial of degree $(-\lambda_1) - \lambda$ or of degree $(-\lambda_1) - \mu$. But when λ_1 is a negative integer including zero, and neither λ nor μ is one of the positive integers $1, 2, \dots, (-\lambda_1)$, the second solution about $x=0$ involves a term having the factor $\log x$. When λ_1 is a positive integer, not zero, the second solution about $x=0$ persists as a solution, in accordance with the order of arrangement of the roots of the index equation in our theory; the first solution is then replaced by an integral polynomial of degree $-\lambda$ or $-\mu$, when λ or μ is one of the negative integers $0, -1, -2, \dots, -1-\lambda_1$, but otherwise contains a logarithm. Similarly for the solutions about $x=1$ or $x=\infty$; it will be seen below how the results are deducible from those for $x=0$.

Denote now the solutions about $x=0$ by u_1, u_2 ; those about $x=1$ by v_1, v_2 ; and those about $x=\infty$ by w_1, w_2 ; in the region (S, S_1) common to the circles S_0, S_1 of radius 1 whose centres are the points $x=0, x=1$, all the first four are valid, and there exist equations $u_1 = A v_1 + B w_1, u_2 = C v_2 + D w_2$, where A, B, C, D are constants; in the region (S, S_2) where A, B, C, D are constants; in the region (S, S_3) that are lying inside the circle S_1 and outside the circle S_0 , those that are valid are v_1, v_2, w_1, w_2 , and there exist equations $v_1 = P w_1 + Q w_2, v_2 = R w_1 + T w_2$, where P, Q, R, T are constants; thus considering any integral whose expression within the circle S_1 is $a u_1 + b u_2$, where a, b are constants, the same integral will be represented within the circle S_2 by $(a + b)C v_1 + (a + b)D v_2$, and outside these circles will be represented by $(a + b)C P + (a + b)D R$; within $(a + b)C Q + (a + b)D T$. A single-valued branch of such an integral can be obtained by making a barrier in the plane joining ∞ to 0 and 1 to ∞ ; for instance, by excluding the consideration of real negative values of x and of real

positive values greater than 1, and defining the phase of x and $x-1$ for real values between 0 and 1 as respectively 0 and π .

We can form the Fuchsian equation of the second order with three arbitrary singular points ξ_1, ξ_2, ξ_3 , and no singular point at $x = \infty$, and with respective indices $\alpha_1, \beta_1, \alpha_2, \beta_2, \alpha_3, \beta_3$ such that $\alpha_1 + \beta_1 + \alpha_2 + \beta_2 + \alpha_3 + \beta_3 = 1$. This equation can then be transformed into the hypergeometric equation in 24 ways; for out of ξ_1, ξ_2, ξ_3 we can in six ways choose two, say ξ_1, ξ_2 , which are to be transformed respectively into 0 and 1, by $(x-\xi_2)/(x-\xi_1) = t/(t-1)$; and then there are four possible transformations of the dependent variable which will reduce one of the indices at $t=0$ to zero and one of the indices at $t=1$ also to zero, namely, we may reduce either α_1 or β_1 at $t=0$, and simultaneously either α_2 or β_2 at $t=1$. Thus the hypergeometric equation itself can be transformed into itself in 24 ways, and from the expression $F(\lambda, \mu, \nu, x)$ which satisfies it follow 23 other forms of solution; they involve four series in each of the arguments, $x, x-1, 1/x, 1/(1-x), (x-1)/x, x/(x-1)$. Five of the 23 solutions agree with the fundamental solutions already described about $x=0, x=1, x=\infty$; and from the principles by which these were obtained it is immediately clear that the 24 forms are, in value, equal in form.

The quarter periods K, K' of Jacobi's theory of elliptic functions, of which $K = \int_0^1 (1-t^2 \sin^2 \theta)^{-1/2} dt$, and K' is the same function of $1-k$, can easily be proved to be the solutions of a hypergeometric equation of which k is the independent variable. When K, K' are regarded as defined in terms of k by the differential equation, the ratio K'/K is an infinitely many valued function of k . But it is remarkable that Jacobi's own theory of theta functions leads to an expression for k in terms of K'/K (see FUNCTION) in terms of single-valued functions. We may then attempt to investigate, in general, in what cases the independent variable x of a hypergeometric equation is a single-valued function of the ratio τ of two independent integrals of the equation. The same inquiry is suggested by the problem of ascertaining in what cases the hypergeometric series $F(\alpha, \beta, \gamma, x)$ is the expansion of an algebraic (irrational) function of x . In order to explain the meaning of the question, suppose that the plane of x is divided along the real axis from $-\infty$ to 0 and from 1 to $+\infty$, and, supposing logarithms not to enter about $x=0$, choose two quite definite integrals γ_1, γ_2 of the equation, say

$$\gamma_1 = F(\lambda, \mu, \nu, x), \gamma_2 = x^2 F(\lambda + \lambda_1, \mu + \mu_1, \nu + \nu_1, x),$$

with the condition that the phase of x is zero when x is real and between 0 and 1. Then the value of $\tau = \gamma_2/\gamma_1$ is definite for all values of x in the divided plane, τ being a single-valued monogenic branch of an analytical function existing and without singularities all over this region. If, now, the values of τ that so arise be plotted on to another plane, a value $\rho + i\eta$ of τ being represented by a point (ρ, η) of this τ -plane, and the value of x from which it arose being mentally associated with this point of the τ -plane, these points will fill a connected region therein, with a continuous boundary formed of four portions corresponding to the two sides of the two barriers of the x -plane. The question is then, firstly, whether the same value of τ can arise for two different values of x , that is, whether the same point (ρ, η) of the τ -plane can arise twice, or in other words, whether the region of the τ -plane overlaps itself or not. Supposing this is not so, a second part of the question presents itself. If in the x -plane the barrier joining $-\infty$ to 0 be momentarily removed, and x describe a small circle with centre at $x=0$ starting from a point $x = -h-ik$, where h, k are small, real, and positive and coming back to this point, the original value τ at this point will be changed to a value σ , which in the original case did not arise for this value of x , and possibly not at all. If, now, after restoring the barrier the values arising by continuation from σ be similarly plotted on the τ -plane, we shall again obtain a region which, while not overlapping itself, may quite possibly overlap the former region. In that case two values of τ would arise for the same value or values of the quotient γ_2/γ_1 , arising from two different branches of the equation. We shall understand then, by the condition that x is to be a single-valued function of τ , that the region in the τ -plane corresponding to any branch is not to overlap itself, and that no two of the regions corresponding to the different branches are to overlap. Now in describing the circle about $x=0$ from $x = -h-ik$ to $-h+ik$, where h is small and k evanescent,

$$\sigma = x^2 F(\lambda + \lambda_1, \mu + \mu_1, \nu + \nu_1, x) / F(\lambda, \mu, \nu, x)$$

is changed to $\sigma = \tau e^{2\pi i \lambda_1}$. Thus the two portions of boundary of the τ -region corresponding to the two sides of the barrier $(-\infty, 0)$ meet (at $\tau = 0$ if the real part of λ_1 be positive) at an angle $2\pi \lambda_1$, where λ_1 is the absolute value of the real part of λ_1 ; the same is true for the σ -region representing the branch σ . The condition that the τ -region shall not overlap itself requires, then, $\lambda_1 = 1$. But, further, we may form an infinite number of branches $\sigma = \tau e^{2\pi i \lambda_1}, \sigma = \tau e^{4\pi i \lambda_1}, \dots$ in the same way, and the corresponding regions in the plane upon which γ_2/γ_1 is represented will have a common point and each have an angle $2\pi \lambda_1$; if neither overlaps the preceding, it will happen, if λ_1 is not zero, that at length one is reached overlapping the first, unless for some positive integer n we have $2\pi n \lambda_1 = 2\pi$, in other words

$\lambda_1 = 1/n$. If this be so, the branch $\sigma_{-1} = \tau e^{-2\pi i \lambda_1}$ will be represented by a region having the angle at the common point common with the region for the branch τ ; but not altogether coinciding with this last region unless λ_1 be real, and therefore $= 1/n$; then there is only a finite number, n , of branches obtainable in this way by crossing the barrier $(-\infty, 0)$. In precisely the same way, if we had begun by taking the quotient

$$\sigma' = (x-1)^2 F(\lambda + \lambda_2, \mu + \mu_2, \nu + \nu_2, 1-x) / F(\lambda, \mu, \nu, 1-x)$$

of the two solutions about $x=1$, we should have found that x is not a single-valued function of σ' unless λ_2 is the inverse of an integer, or is zero; as σ' is of the form $(A\tau+B)/(C\tau+D)$, A, B, C, D constants, the same is true in our case; equally, by considering the integrals about $x=\infty$ we find, as a third condition necessary in order that x may be a single-valued function of τ , that $\lambda-\nu$ must be the inverse of an integer or be zero. These three differences of the indices, namely, $\lambda_1, \lambda_2, \lambda-\nu$, are the quantities which enter in the differential equation satisfied by x as a function of τ , which is easily found to be

$$\frac{d^2x}{d\tau^2} + \frac{2\tau dx}{\tau^2} = \left\{ \frac{h_1 - h_2}{\tau} x^{-1} (x-1)^{-1} + \frac{h_2}{\tau} x^{-2} + \frac{h_1}{\tau} (x-1)^{-2} \right\} dx^2$$

where $x_1 = dx/d\tau, dx/d\tau$; and $h_1 = 1-\gamma_1^2, h_2 = 1-\lambda_2^2, h_3 = 1-(\lambda-\nu)^2$. Into the converse question whether the three conditions are sufficient to ensure (1) that the τ region corresponding to any branch does not overlap itself, (2) that no two such regions overlap, we have no space to enter. The second question clearly requires the inquiry whether the group (that is, the monodromy group) of the differential equation is properly discontinuous. (See GROUPS, THEORY OF.)

The foregoing account will give an idea of the nature of the function theories of differential equations; it appears essential not to exclude some explanation of a theory intimately related both to such theories and to transformation theories, which is a generalization of Galois's theory of algebraic equations. We deal only with the application to homogeneous linear differential equations.

In general a function of variables x_1, x_2, \dots is said to be rational when it can be formed from them and the integers 1, 2, 3, ... by a finite number of additions, subtractions, multiplications and divisions. We generalize this definition. Assume that we have assigned a fundamental series of quantities and functions of x , in which x itself is included, such that all quantities formed by a finite number of additions, subtractions, multiplications, divisions and differentiations in regard to x , of the terms of this series, are themselves members of this series. Then the quantities of this series, and only these, are called *rational*. By a rational function of quantities p, q, r, \dots is meant a function formed from them and any of the fundamental rational quantities by a finite number of the five fundamental operations. Thus it is a function which would be called, simply, rational if the fundamental series were widened by the addition to it of the quantities p, q, r, \dots and those derivable from them by the five fundamental operations. A rational ordinary differential equation, with x as independent and y as dependent variable, is then one which equates to zero a rational function of y , the order k of the differential equation being that of the highest differential coefficient $y^{(k)}$ which enters; only such equations are here discussed. Such an equation $P=0$ is called *irreducible* when, firstly, being arranged as an integral polynomial in $y^{(k)}$, this polynomial is not the product of other polynomials in $y^{(k)}$ also of rational form; and, secondly, the equation has no solution satisfying also a rational equation of lower order. From this it follows that if an irreducible equation $P=0$ have one solution satisfying another rational equation $Q=0$ of the same or higher order, then all the solutions of $P=0$ also satisfy $Q=0$. For from the equation $P=0$ we can by differentiation express $y^{(k+1)}, y^{(k+2)}, \dots$ in terms of $x, y, y^{(1)}, \dots, y^{(k)}$, and so put the function Q rationally in terms of these quantities only. It is sufficient, then, to prove the result when the equation $Q=0$ is of the same order as $P=0$. Let both the equations be arranged as integral polynomials in $y^{(k)}$; their algebraic eliminant in regard to $y^{(k)}$ must then vanish identically, for they are known to have one common solution not satisfying an equation of lower order; thus the equation $P=0$ involves $Q=0$ for all solutions of $P=0$.

Now let $y^{(k)} = a_1 y^{(k-1)} + \dots + a_n y$ be a given rational homogeneous linear differential equation; let $\gamma_1, \dots, \gamma_n$ be n particular functions of x , unconnected by any equation with constant coefficients of the form $c_1 \gamma_1 + \dots + c_n \gamma_n = 0$, all satisfying the differential equation; let η_1, \dots, η_n be linear functions of $\gamma_1, \dots, \gamma_n$, say $\eta_1 = A_{11} \gamma_1 + \dots + A_{1n} \gamma_n$, where the constant coefficients A_{ij} have a non-vanishing determinant; write $(\eta) = A(\gamma)$, these being the equations of a general linear homogeneous group whose transformations may be denoted by A, B, \dots . We desire to form a rational function $\phi(\eta)$, or say $\phi(A(\gamma))$, of η_1, \dots, η_n in which the η constants A_{ij} shall all be essential, and not reduce effectively to a fewer number, as they would, for instance, if the $\gamma_1, \dots, \gamma_n$ were connected by a linear equation with constant coefficients. Such a function is in fact given, if the solutions $\gamma_1, \dots, \gamma_n$ be developable

Rationally group of a linear equation.

Irreducibility of a rational equation.

The variant function for a linear equation.

in positive integral powers about $x=0$, by $\phi(x) = \eta_0 + (x-0)^m + \dots + (x-0)^{n-1} \eta_{n-1}$. Such a function, V , is called a *variant*.

Then differentiating V in regard to x , and replacing $\eta_i^{(n)}$ by its value $\alpha_i \eta_i^{(n-1)} + \dots + \alpha_n \eta_n$, we can arrange dV/dx , and similarly each of $d^2V/dx^2, \dots, d^pV/dx^p$, where $N = n^2$, as a linear function of the N quantities $\eta_1, \dots, \eta_n, \eta_1^{(2)}, \dots, \eta_n^{(2)}, \dots, \eta_1^{(p)}, \dots, \eta_n^{(p)}$, and thence by elimination obtain a linear differential equation for V of order N with rational coefficients. This we denote by $F=0$. Further, each of η_1, \dots, η_n is expressible as a linear function of $V, dV/dx, \dots, d^{p-1}V/dx^{p-1}$, with rational coefficients not involving any of the n^2 coefficients A_{ij} , since otherwise V would satisfy a linear equation of order less than N , which is impossible, as it involves (linearly) the n^2 arbitrary coefficients A_{ij} , which would not enter into the coefficients of the supposed equation. In particular, η_1, \dots, η_n are expressible rationally as linear functions of $\omega, d\omega/dx, \dots, d^{p-1}\omega/dx^{p-1}$, where ω is the particular function $\phi(y)$. Any solution W of the equation $F=0$ is derivable from any functions η_1, \dots, η_n , which are linear functions of η_1, \dots, η_n , just as V was derived from η_1, \dots, η_n ; but it does not follow that these functions, η_1, \dots, η_n , are obtained from η_1, \dots, η_n by a transformation of the linear group A, B, \dots ; for it may happen that the determinant $d(\eta_1, \dots, \eta_n)/d(y_1, \dots, y_n)$ is zero. In that case η_1, \dots, η_n may be called a singular set, and W a singular solution; it satisfies an equation of lower than the N -th order. But every solution V, W , ordinary or singular, of the equation $F=0$, is expressible rationally in terms of $\omega, d\omega/dx, \dots, d^{p-1}\omega/dx^{p-1}$; we shall write, simply, $V=r(\omega)$. Consider now the rational irreducible equation of lowest order, not necessarily a linear equation, which is satisfied by ω ; as η_1, \dots, η_n are particular functions, it may quite well be of order less than N ; we call it the *resolvent equation*, suppose it of order p , and denote it by $\gamma(\omega)$. Upon it the whole theory turns. In the first place, as $\gamma(\omega)=0$ is satisfied by the solution ω of $F=0$, all the solutions of $\gamma(\omega)$ are solutions $F=0$, and are therefore rationally expressible by ω ; any one may then be denoted by $r(\omega)$. If this solution of $F=0$ be not singular, it corresponds to a transformation A of the linear group (A, B, \dots) , effected upon η_1, \dots, η_n . The coefficients A_{ij} of this transformation follow from the expressions before mentioned for η_1, \dots, η_n in terms of $V, dV/dx, d^2V/dx^2, \dots$ by substituting $V=r(\omega)$; thus they depend on the p arbitrary parameters which enter into the general expression for the integral of the equation $\gamma(\omega)=0$. Without going into further details, it is then clear enough that the resolvent equation, being irreducible and such that any solution is expressible rationally, with p parameters, in terms of the solution ω , enables us to define a linear homogeneous group of transformations $\omega, \eta_1, \dots, \eta_n$, depending on p parameters; and every operation of this (continuous) group corresponds to a rational transformation of the solution of the resolvent equation. This is the group called the *rationality group*, or the *group of linear transformations* of the original homogeneous linear differential equation. The group must not be confounded with a subgroup of itself, the *monodromy group* of the equation, often called simply the group of the equation, which is a set of transformations, not depending on arbitrary variable parameters, arising from one particular fundamental set of solutions of the linear equation (see GROUPS, THEORY OF).

The resolvent equation.

The fundamental theorem in regard to the rationality group.

The importance of the rationality group consists in three propositions. (1) Any rational function of η_1, \dots, η_n , which is unaltered in value by the transformations of the group can be written in rational form. (2) If any rational function be changed in form, becoming a rational function of η_1, \dots, η_n , a transformation of the group applied to its new form will leave its value unaltered. (3) Any homogeneous linear transformation leaving unaltered the value of every rational function of η_1, \dots, η_n , which has a rational value, belongs to the group. It follows from these that any group of linear homogeneous transformations having the properties (1) (2) is identical with the group in question. It is clear that with these properties the group must be of the greatest importance in attempting to discover what functions of x must be regarded as rational in order that the values of η_1, \dots, η_n may be expressed. And this is the problem of solving the equation from another point of view.

LITERATURE.—(a) *Formal or Transformation Theories for Equations of the First Order*.—E. Goursat, *Leçons sur l'intégration des équations aux dérivées partielles du premier ordre* (Paris, 1891); E. v. Weber, *Vorlesungen über das Pfaff'sche Problem und die Theorie der partiellen Differentialgleichungen erster Ordnung* (Leipzig, 1900); S. Lie und G. Scheffers, *Geometrie der Berührungstransformationen*, Bd. i. (Leipzig, 1896); Forsyth, *Theory of Differential Equations, Part i., Exact Equations and Pfaff's Problem* (Cambridge, 1890); S. Lie, "Allgemeine Untersuchungen über Differentialgleichungen, die eine kontinuierliche endliche Gruppe gestatten" (Memoir, *Mathem. Annal.* xxv. (1885), pp. 71-151; S. Lie und G. Scheffers, *Vorlesungen über Differentialgleichungen mit bekannten infinitesimalen Transformationen* (Leipzig, 1891). A very full bibliography is given in the book of E. v. Weber referred to; those here named are perhaps sufficiently representative of modern works. Of classical works may be named: Jacobi, *Vorlesungen über Dynamik* (von A. Clebsch, Berlin, 1866); *Werke*, Supplementband; G. Monge, *Application de l'analyse à la géométrie* (par M. Liouville, Paris, 1850); J. L. Lagrange, *Leçons*

sur le calcul des fonctions (Paris, 1806), and *Théorie des fonctions analytiques* (Paris, Prarial, an V); G. Boole, *A Treatise on Differential Equations* (London, 1859); and *Supplementary Volume* (London, 1865); Darboux, *Leçons sur la théorie générale des surfaces*, t. i.-iv. (Paris, 1887-1896); S. Lie, *Théorie der transformationengruppen* ii. (on Contact Transformations) (Leipzig, 1890).

(b) *Quantitative or Function Theories for Linear Equations*.—C. Jordan, *Cours d'analyse*, t. iii. (Paris, 1896); E. Picard, *Traité d'analyse*, t. ii. and iii. (Paris, 1893, 1896); Fuchs, *Various Memoirs*, beginning with that in *Crelle's Journal*, Bd. lxvi. p. 121; Riemann, *Werke*, 2^e Aufl. (1892); Schlesinger, *Handbuch der Theorie der linearen Differentialgleichungen*, Bde. i.-ii. (Leipzig, 1895-1898); Heffter, *Einführung in die Theorie der linearen Differentialgleichungen mit einer unabhängigen Variablen* (Leipzig, 1894); Klein, *Vorlesungen über lineare Differentialgleichungen der zweiten Ordnung* (Autographed, Göttingen, 1894); and *Vorlesungen über die hypergeometrische Function* (Autographed, Göttingen, 1894); Forsyth, *Theory of Differential Equations, Linear Equations*.

(c) *Rationality Group of Linear Differential Equations*.—Picard, *Traité d'Analyse*, as above, t. iii.; Vessiot, *Annales de l'École Normale*, série III. t. ix. p. 199 (Mémorial); S. Lie, *Transformationengruppen*, as above, iii. A connected account is given in Schlesinger, as above, Bd. ii., erstes Theil.

(d) *Function Theories of Non-Linear Ordinary Equations*.—Painlevé, *Leçons sur la théorie analytique des équations différentielles* (Paris, 1897, Autographed); Forsyth, *Theory of Differential Equations, Part ii., Ordinary Equations not Linear* (two volumes, ii. and iii.) (Cambridge, 1900); Königsberger, *Lehrbuch der Theorie der Differentialgleichungen* (Leipzig, 1889); Painlevé, *Leçons sur l'intégration des équations différentielles de la mécanique et applications* (Paris, 1895).

(e) *Formal Theories of Partial Equations of the Second and Higher Orders*.—E. Goursat, *Leçons sur l'intégration des équations aux dérivées partielles du second ordre*, t. i. and ii. (Paris, 1896, 1898); Forsyth, *Treatise on Differential Equations* (London, 1889); and *Phil. Trans. Roy. Soc. (A)*, vol. cxci. (1898), pp. 1-86.

(f) See also the six extensive articles in the second volume of the German *Encyclopædia of Mathematics*. (H. F. BA.)

DIFFLUGIA (L. Leclerc), a genus of lobose Rhizopoda, characterized by a shell formed of sand granules cemented together; these are swallowed by the animal, and during the process of bud-fission they pass to the surface of the daughter-bud and are cemented there. *Centroporys* (Steia) and *Lequeuxia* (Schlumberg) differ only in minor points.

DIFFRACTION OF LIGHT.—r. When light proceeding from a small source falls upon an opaque object, a shadow is cast upon a screen situated behind the obstacle, and this shadow is found to be bordered by alternations of brightness and darkness, known as "diffraction bands." The phenomena thus presented were described by Grimaldi and by Newton. Subsequently T. Young showed that in their formation interference plays an important part, but the complete explanation was reserved for A. J. Fresnel. Later investigations by Fraunhofer, Airy and others have greatly widened the field, and under the head of "diffraction" are now usually treated all the effects dependent upon the limitation of a beam of light, as well as those which arise from irregularities of any kind at surfaces through which it is transmitted, or at which it is reflected.

2. *Shadows.*—In the infancy of the undulatory theory the objection most frequently urged against it was the difficulty of explaining the very existence of shadows. Thanks to Fresnel and his followers, this department of optics is now precisely the one in which the theory has gained its greatest triumphs. The principle employed in these investigations is due to C. Huygens, and may be thus formulated. If round the origin of waves an ideal closed surface be drawn, the whole action of the waves in the region beyond may be regarded as due to the motion continually propagated across the various elements of this surface. The wave motion due to any element of the surface is called a *secondary wave*, and in estimating the total effect regard must be paid to the phases as well as the amplitudes of the components. It is usually convenient to choose as the surface of resolution a *wave-front*, i.e. a surface at which the primary vibrations are in one phase. Any obscurity that may hang over Huygens's principle is due mainly to the indefiniteness of thought and expression which we must be content to put up with if we wish to avoid pledging ourselves as to the character of the vibrations. In the application to sound, where we know what we are dealing with, the matter is simple enough in principle, although mathematical difficulties would often stand in the way of the calculations we might wish to make.

The ideal surface of resolution may be there regarded as a flexible lamina; and we know that, if by forces locally applied every element of the lamina be made to move normally to itself exactly as the air at that place does, the external aerial motion is fully determined. By the principle of superposition the whole effect may be found by integration of the partial effects due to each element of the surface, the other elements remaining at rest.

We will now consider in detail the important case in which uniform plane waves are resolved at a surface coincident with a wave-front (OQ). We imagine a wave-front divided into elementary rings or zones—often named after Huygens, but better after Fresnel—by spheres described round P (the point at which the aggregate effect is to be estimated), the first sphere, touching the plane at O, with a radius equal to PO, and the succeeding spheres with radii increasing at each step by $\frac{1}{2}\lambda$. There are thus marked out a series of circles, whose radii x are given by $x^2 + r^2 = (r + \frac{1}{2}\lambda)^2$, or $x^2 = r\lambda$ nearly; so that the rings are at first of nearly equal area.

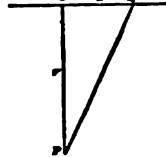

FIG. 1.

depends also upon the angle of the secondary ray to the direction of vibration and to the wave-front.

The latter question can only be treated in connexion with the dynamical theory (see below, § 11); but under all ordinary circumstances the result is independent of the precise answer that may be given. All that it is necessary to assume is that the effects of the successive zones gradually diminish, whether from the increasing obliquity of the secondary ray or because (on account of the limitation of the region of integration) the zones become at last more and more incomplete. The component vibrations at P due to the successive zones are thus nearly equal in amplitude and opposite in phase (the phase of each corresponding to that of the infinitesimal circle midway between the boundaries), and the series which we have to sum is one in which the terms are alternately opposite in sign and, while at first nearly constant in numerical magnitude, gradually diminish to zero. In such a series each term may be regarded as very nearly indeed destroyed by the halves of its immediate neighbours, and thus the sum of the whole series is represented by half the first term, which stands over uncompensated. The question is thus reduced to that of finding the effect of the first zone, or central circle, of which the area is $\pi r\lambda$.

We have seen that the problem before us is independent of the law of the secondary wave as regards obliquity; but the result of the integration necessarily involves the law of the intensity and phase of a secondary wave as a function of r , the distance from the origin. And we may in fact, as was done by A. Smith (*Cosm. Math. Journ.*, 1845, 3, p. 46), determine the law of the secondary wave, by comparing the result of the integration with that obtained by supposing the primary wave to pass on to P without resolution.

Now as to the phase of the secondary wave, it might appear natural to suppose that it starts from any point Q with the phase of the primary wave, so that on arrival at P, it is retarded by the amount corresponding to QP. But a little consideration will prove that in that case the series of secondary waves could not reconstitute the primary wave. For the aggregate effect of the secondary waves is the half of that of the first Fresnel zone, and it is the central element only of that zone for which the distance to be travelled is equal to r . Let us conceive the zone in question to be divided into infinitesimal rings of equal area. The effects due to each of these rings are equal in amplitude and of phase ranging uniformly over half a complete period. The phase of the resultant is midway between those of the extreme elements, that is to say, a quarter of a period behind that due to the element at the centre of the circle. It is accordingly necessary to suppose that the secondary waves start with a phase one-quarter of a period in advance of that of the primary wave at the surface of resolution.

Further, it is evident that account must be taken of the variation of phase in estimating the magnitude of the effect at P of the first zone. The middle element alone contributes without deduction; the effect of every other must be found by introduction of a resolving factor, equal to $\cos \theta$, if θ represent the difference of phase between this element and the resultant. Accordingly, the amplitude of the resultant will be less than if all its components had the same phase, in the ratio

$$\int_{-\frac{1}{2}\pi}^{+\frac{1}{2}\pi} \cos \theta \sin \theta \, d\theta : \pi,$$

or $2 : \pi$. Now 2 area $\pi r\lambda$; so that, in order to reconcile the amplitude of the primary wave (taken as unity) with the half effect of the first zone, the amplitude, at distance r , of the secondary wave emitted from the element of area dS must be taken to be

$$dS/\lambda r \dots \dots \dots (1).$$

By this expression, in conjunction with the quarter-period acceleration of phase, the law of the secondary wave is determined.

That the amplitude of the secondary wave should vary as r^{-1} was to be expected from considerations respecting energy; but the occurrence of the factor λ^{-1} , and the acceleration of phase, have sometimes been regarded as mysterious. It may be well therefore to remember that precisely these laws apply to a secondary wave of sound, which can be investigated upon the strictest mechanical principles.

The recombination of the secondary waves may also be treated analytically. If the primary wave at O be $\cos kat$, the effect of the secondary wave proceeding from the element dS at Q is

$$\frac{dS}{\lambda r} \cos k(at - \rho + \frac{1}{2}\lambda) = -\frac{dS}{\lambda r} \sin k(at - \rho).$$

If $dS = 2\pi r dx$, we have for the whole effect

$$-\frac{2\pi}{\lambda} \int_0^r \frac{\sin k(at - \rho) x \, dx}{r},$$

$$\text{or, since } x dx = r d\rho, k = 2\pi/\lambda, \\ -k \int_0^r \sin k(at - \rho) d\rho = [-\cos k(at - \rho)]_0^r.$$

In order to obtain the effect of the primary wave, as retarded by traversing the distance r , viz. $\cos k(at - r)$, it is necessary to suppose that the integrated term vanishes at the upper limit. And it is important to notice that without some further understanding the integral is really ambiguous. According to the assumed law of the secondary wave, the result must actually depend upon the precise radius of the outer boundary of the region of integration, supposed to be exactly circular. This case is, however, at most very special and exceptional. We may usually suppose that a large number of the outer rings are incomplete, so that the integrated term at the upper limit may properly be taken to vanish. If a formal proof be desired, it may be obtained by introducing into the integral a factor such as $e^{-\rho}$, in which k is ultimately made to diminish without limit.

When the primary wave is plane, the area of the first Fresnel zone is $\pi r\lambda$; and, since the secondary waves vary as r^{-1} , the intensity is independent of r , as of course it should be. If, however, the primary wave be spherical, and of radius a at the wave-front of resolution, then we know that at a distance r further on the amplitude of the primary wave will be diminished in the ratio $a:(r+a)$. This may be regarded as a consequence of the altered area of the first Fresnel zone. For, if a be its radius, we have $\{(r + \frac{1}{2}\lambda)^2 - a^2\} + \lambda \{a^2 - a^2\} = r + a$,

so that

$$x^2 = \lambda ar / (a + r) \text{ nearly.}$$

Since the distance to be travelled by the secondary waves is still r , we see how the effect of the first zone, and therefore of the whole series is proportional to $a/(a+r)$. In like manner may be treated other cases, such as that of a primary wave-front of unequal principal curvatures.

The general explanation of the formation of shadows may also be conveniently based upon Fresnel's zones. If the point under consideration be so far away from the geometrical shadow that a large number of the primary zones are complete, then the illumination, determined sensibly by the first zone, is the same as if there were no obstruction at all. If, on the other hand, the point be well immersed in the geometrical shadow, the earlier zones are altogether missing, and, instead of a series of terms beginning with finite numerical magnitude and gradually diminishing to zero, we have now to deal with one of which the terms diminish to zero at both ends. The sum of such a series is very approximately zero, each term being neutralized by the halves of its immediate neighbours, which are of the opposite sign. The question of light or darkness then depends upon whether the series begins or ends abruptly. With few exceptions, abruptness can occur only in the presence of the first term, viz. when the secondary wave of least retardation is unobstructed, or when a ray passes through the point under consideration. According to the undulatory theory the light cannot be regarded strictly as travelling along a ray; but the existence of an unobstructed ray implies that the system of Fresnel's zones can be commenced, and, if a large number of these zones are fully developed and do not terminate abruptly, the illumination is unaffected by the neighbourhood of obstacles. Intermediate cases in which a few zones only are formed belong especially to the province of diffraction.

An interesting exception to the general rule that full brightness requires the existence of the first zone occurs when the obstacle assumes the form of a small circular disk parallel to the plane of the incident waves. In the earlier half of the 18th century R. Delisle found that the centre of the circular shadow was occupied by a bright point of light, but the observation passed into oblivion until S. D. Poisson brought forward as an objection to Fresnel's theory that it required at the centre of a circular shadow a point as bright as if no obstacle were intervening. If we conceive the primary wave to be broken up at the plane of the disk, a system of Fresnel's zones can be constructed which begins from the circumference; and the first zone external to the disk plays the part ordinarily taken by the centre of the entire system. The whole effect is the

half of that of the first existing zone, and this is sensibly the same as if there were no obstruction.

When light passes through a small circular or annular aperture, the illumination at any point along the axis depends upon the precise relation between the aperture and the distance from it at which the point is taken. If, as in the last paragraph, we imagine a system of zones to be drawn commencing from the inner circular boundary of the aperture, the question turns upon the manner in which the series terminates at the outer boundary. If the aperture be such as to fit exactly an integral number of zones, the aggregate effect may be regarded as the half of those due to the first and last zones. If the number of zones be even, the action of the first and last zones are antagonistic, and there is complete darkness at the point. If on the other hand the number of zones be odd, the effects conspire; and the illumination (proportional to the square of the amplitude) is four times as great as if there were no obstruction at all.

The process of augmenting the resultant illumination at a particular point by stopping some of the secondary rays may be carried much further (Soret, *Pogg. Ann.*, 1875, 156, p. 99). By the aid of photography it is easy to prepare a plate, transparent where the zones of odd order fall, and opaque where those of even order fall. Such a plate has the power of a condensing lens, and gives an illumination out of all proportion to what could be obtained without it. An even greater effect (fourfold) can be attained by providing that the stoppage of the light from the alternate zones is replaced by a phase-reversal without loss of amplitude. R. W. Wood (*Phil. Mag.*, 1898, 45, p. 513) has succeeded in constructing zone plates upon this principle.

In such experiments the narrowness of the zones renders necessary a pretty close approximation to the geometrical conditions. Thus in the case of the circular disk, equidistant (r) from the source of light and from the screen upon which the shadow is observed, the width of the first exterior zone is given by

$$dx = \lambda(2r)/4(2x),$$

$2x$ being the diameter of the disk. If $2r = 1000$ cm., $2x = 1$ cm., $\lambda = 6 \times 10^{-7}$ cm., then $dx = .0015$ cm. Hence, in order that this zone may be perfectly formed, there should be no error in the circumference of the order of .001 cm. (It is easy to see that the radius of the bright spot is of the same order of magnitude.) The experiment succeeds in a dark room of the length above mentioned, with a threepenny bit (supported by three threads) as obstacle, the origin of light being a small needle hole in a plate of tin, through which the sun's rays shine horizontally after reflection from an external mirror. In the absence of a heliostat it is more convenient to obtain a point of light with the aid of a lens of short focus.

The amplitude of the light at any point in the axis, when plane waves are incident perpendicularly upon an annular aperture, is, as above,

$$\cos k(at-r_1) - \cos k(at-r_2) = 2 \sin kat \sin k(r_1-r_2),$$

r_1, r_2 being the distances of the outer and inner boundaries from the point in question. It is scarcely necessary to remark that in all such cases the calculation applies in the first instance to homogeneous light, and that, in accordance with Fourier's theorem, each homogeneous component of a mixture may be treated separately. When the original light is white, the presence of some components and the absence of others will usually give rise to coloured effects, variable with the precise circumstances of the case.

Although the matter can be fully treated only upon the basis of a dynamical theory, it is proper to point out at once that there is an element of assumption in the application of Huygens's principle to the calculation of the effects produced by opaque screens of limited extent. Properly applied, the principle could not fail; but, as may readily be proved in the case of sonorous waves, it is not in strictness sufficient to assume the expression for a secondary wave suitable when the primary wave is undisturbed, with mere limitation of

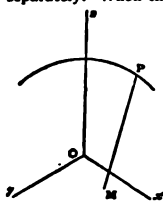

FIG. 2.

the integration to the transparent parts of the screen. But, except perhaps in the case of very fine gratings, it is probable that the error thus caused is insignificant; for the incorrect estimation of the secondary waves will be limited to distances of a few wave-lengths only from the boundary of opaque and transparent parts.

3. *Fraunhofer's Diffraction Phenomena.*—A very general problem in diffraction is the investigation of the distribution of light over a screen upon which impinge divergent or convergent spherical waves after passage through various diffracting apertures. When the waves are convergent and the recipient screen is placed so as to contain the centre of convergency—the image of the original radiant point, the calculation assumes a less complicated form. This class of phenomena was investigated by J. von Fraunhofer (upon principles laid down by Fresnel), and are sometimes called after his name. We may conveniently

commence with them on account of their simplicity and great importance in respect to the theory of optical instruments.

If f be the radius of the spherical wave at the place of resolution, where the vibration is represented by $\cos kat$, then at any point M (fig. 2) in the recipient screen the vibration due to an element dS of the wave-front is ($\frac{1}{2}$)

$$-\frac{dS}{\lambda\rho} \sin k(at-\rho),$$

ρ being the distance between M and the element dS .

Taking co-ordinates in the plane of the screen with the centre of the wave as origin, let us represent M by ξ, η , and P (where dS is situated) by x, y, z .

Then

$$\rho^2 = (x-\xi)^2 + (y-\eta)^2 + z^2, \quad \rho^2 = x^2 + y^2 + z^2;$$

so that

$$\rho^2 = \rho^2 - 2x\xi - 2y\eta + \xi^2 + \eta^2.$$

In the applications with which we are concerned, ξ, η are very small quantities; and we may take

$$\rho = f \left\{ 1 - \frac{x\xi + y\eta}{f^2} \right\}.$$

At the same time dS may be identified with $dx dy$, and in the denominator ρ may be treated as constant and equal to f . Thus the expression for the vibration at M becomes

$$-\frac{1}{\lambda f} \iint \sin k \left\{ at - f + \frac{x\xi + y\eta}{f} \right\} dx dy \dots (1);$$

and for the intensity, represented by the square of the amplitude,

$$I^2 = \frac{1}{\lambda^2 f^2} \left[\iint \sin k \left\{ at + \frac{x\xi + y\eta}{f} \right\} dx dy \right]^2 + \frac{1}{\lambda^2 f^2} \left[\iint \cos k \left\{ at + \frac{x\xi + y\eta}{f} \right\} dx dy \right]^2 \dots (2).$$

This expression for the intensity becomes rigorously applicable when f is indefinitely great, so that ordinary optical aberration disappears. The incident waves are thus plane, and are limited to a plane aperture coincident with a wave-front. The integrals are then properly functions of the *direction* in which the light is to be estimated.

In experiment under ordinary circumstances it makes no difference whether the collecting lens is in front of or behind the diffracting aperture. It is usually most convenient to employ a telescope focused upon the radiant point, and to place the diffracting apertures immediately in front of the object-glass. What is seen through the eye-piece in any case is the same as would be depicted upon a screen in the focal plane.

Before proceeding to special cases it may be well to call attention to some general properties of the solution expressed by (2) (see *Bridge, Phil. Mag.*, 1858).

If when the aperture is given, the wave-length (proportional to k^{-1}) varies, the composition of the integrals is unaltered, provided ξ and η are taken universally proportional to λ . A diminution of λ thus leads to a simple proportional shrinkage of the diffraction pattern, attended by an augmentation of brilliancy in proportion to λ^2 .

If the wave-length remains unchanged, similar effects are produced by an increase in the scale of the aperture. The linear dimension of the diffraction pattern is inversely as that of the aperture, and the brightness at corresponding points is as the square of the area of aperture.

If the aperture and wave-length increase in the same proportion, the size and shape of the diffraction pattern undergo no change.

We will now apply the integrals (2) to the case of a rectangular aperture of width a parallel to x and of width b parallel to y . The limits of integration for x may thus be taken to be $-\frac{1}{2}a$ and $+\frac{1}{2}a$, and for y to be $-\frac{1}{2}b$, $+\frac{1}{2}b$. We readily find (with substitution for k of $2\pi/\lambda$)

$$I^2 = \frac{a^2 b^2}{\lambda^2 f^2} \cdot \frac{\sin^2 \frac{\pi a \xi}{\lambda}}{\frac{\pi^2 \xi^2}{\lambda^2}} \cdot \frac{\sin^2 \frac{\pi b \eta}{\lambda}}{\frac{\pi^2 \eta^2}{\lambda^2}} \dots (3),$$

as representing the distribution of light in the image of a mathematical point when the aperture is rectangular, as is often the case in spectroscopes.

The second and third factors of (3) being each of the form $\sin^2 u/u^2$, we have to examine the character of this function. It vanishes when $u = m\pi$, m being any whole number other than zero. When $u = 0$, it takes the value unity. The maxima occur when

$$u = \tan u, \dots (4),$$

and then

$$\sin^2 u/u^2 = \cos^2 u \dots (5).$$

To calculate the roots of (5) we may assume

$$u = (m + \frac{1}{2})\pi - U, \gamma,$$

where y is a positive quantity which is small when u is large. Substituting this, we find $\cot y = U - y$, whence

$$y = \frac{1}{U} \left(1 + \frac{y}{U} + \frac{y^2}{U^2} + \dots \right) - \frac{y^3}{3} - \frac{2y^5}{15} - \frac{17y^7}{315}$$

This equation is to be solved by successive approximation. It will readily be found that

$$u = U - y = U - U^{-2} - \frac{2}{3}U^{-3} - \frac{13}{15}U^{-4} - \frac{146}{105}U^{-5} - \dots \quad (6)$$

In the first quadrant there is no root after zero, since $\tan u > u$, and in the second quadrant there is none because the signs of u and $\tan u$ are opposite. The first root after zero is thus in the third quadrant, corresponding to $m = 1$. Even in this case the series converges sufficiently to give the value of the root with considerable accuracy, while for higher values of m it is all that could be desired. The actual values of u/π (calculated in another manner by F. M. Schwed) are 1.4303, 2.4590, 3.4709, 4.4747, 5.4818, 6.4844, &c.

Since the maxima occur when $u = (m + \frac{1}{2})\pi$ nearly, the successive values are not very different from

$$\frac{4}{9\pi^2}, \frac{4}{25\pi^2}, \frac{4}{49\pi^2}, \text{ &c.}$$

The application of these results to (3) shows that the field is brightest at the centre $\xi = 0, \eta = 0$, viz. at the geometrical image of the radiant point. It is traversed by dark lines whose equations are

$$\xi = m\lambda/a, \eta = n\lambda/b$$

Within the rectangle formed by pairs of consecutive dark lines, and not far from its centre, the brightness rises to a maximum; but these subsequent maxima are in all cases much inferior to the brightness at the centre of the entire pattern ($\xi = 0, \eta = 0$).

By the principle of energy the illumination over the entire focal plane must be equal to that over the diffracting area; and thus, in accordance with the suppositions by which (3) was obtained, its value when integrated from $\xi = -\infty$ to $\xi = +\infty$, and from $\eta = -\infty$ to $\eta = +\infty$ should be equal to ab . This integration, employed originally by P. Kelland (*Edin. Trans.* 15, p. 315) to determine the absolute intensity of a secondary wave, may be at once effected by means of the known formula

$$\int_{-\infty}^{+\infty} \frac{\sin^2 u}{u^2} du = \int_{-\infty}^{+\infty} \frac{\sin u}{u} du = \pi$$

It will be observed that, while the total intensity is proportional to ab , the intensity at the focal point is proportional to a^2b^2 . If the aperture be increased, not only is the total brightness over the focal plane increased with it, but there is also a concentration of the diffraction pattern. The form of (3) shows immediately that, if a and b be altered, the co-ordinates of any characteristic point in the pattern vary as a^{-1} and b^{-1} .

The contraction of the diffraction pattern with increase of aperture is of fundamental importance in connexion with the resolving power of optical instruments. According to common optics, where images are absolute, the diffraction pattern is supposed to be infinitely small, and two radiant points, however near together, form separated images. This is tantamount to an assumption that λ is infinitely small. The actual finiteness of λ imposes a limit upon the separating or resolving power of an optical instrument.

This indistinctness of images is sometimes said to be due to diffraction by the edge of the aperture, and proposals have even been made for curing it by causing the transition between the interrupted and transmitted parts of the primary wave to be less abrupt. Such a view of the matter is altogether misleading. What requires explanation is not the imperfection of actual images so much as the possibility of their being as good as we find them.

At the focal point ($\xi = 0, \eta = 0$) all the secondary waves agree in phase, and the intensity is easily expressed, whatever be the form of the aperture. From the general formula (2), if A be the area of aperture,

$$I^2 = A^2/\lambda^2 \dots \dots \dots (7)$$

The formation of a sharp image of the radiant point requires that the illumination become insignificant when ξ, η attain small values, and this insignificance can only arise as a consequence of discrepancies of phase among the secondary waves from various parts of the aperture. So long as there is no sensible discrepancy of phase there can be no sensible diminution of brightness as compared with that to be found at the focal point itself. We may go further, and lay it down that there can be no considerable loss of brightness until the difference of phase of the waves proceeding from the nearest and farthest parts of the aperture amounts to $\frac{1}{2}\lambda$.

When the difference of phase amounts to λ , we may expect the resultant illumination to be very much reduced. In the particular case of a rectangular aperture the course of things can be readily followed, especially if we conceive f to be infinite. In the direction (suppose horizontal) for which $\theta = 0, \xi/f = \sin \theta$, the phases of the secondary waves range over a complete period when $\sin \theta = \lambda/a$, and, since all parts of the horizontal aperture are equally effective, there is in this direction a complete compensation and consequent absence of illumination. When $\sin \theta = \frac{1}{2}\lambda/a$, the phases range one and a half

periods, and there is revival of illumination. We may compare the brightness with that in the direction $\theta = 0$. The phase of the resultant amplitude is the same as that due to the central secondary wave, and the discrepancies of phase among the components reduce the amplitude in the proportion

$$\frac{1}{3\pi} \int_{-\frac{1}{2}\pi}^{+\frac{1}{2}\pi} \cos \phi d\phi : 1$$

or $-\frac{2}{3}\pi$; so that the brightness in this direction is $4/9\pi^2$ of the maximum at $\theta = 0$. In like manner we may find the illumination in any other direction, and it is obvious that it vanishes when $\sin \theta$ is any multiple of λ/a .

The reason of the augmentation of resolving power with aperture will now be evident. The larger the aperture the smaller are the angles through which it is necessary to deviate from the principal direction in order to bring in specified discrepancies of phase—the more concentrated is the image.

In many cases the subject of examination is a luminous line of uniform intensity, the various points of which are to be treated as independent sources of light. If the image of the line be $\xi = 0$, the intensity at any point ξ, η of the diffraction pattern may be represented by

$$\int_{-\infty}^{+\infty} I^2 d\eta = \frac{a^2 b}{\lambda^2} \frac{\sin^2 \frac{\pi a \xi}{\lambda^2}}{\frac{\pi a \xi}{\lambda^2}} \dots \dots \dots (8)$$

the same law as obtained for a luminous point when horizontal directions are alone considered. The definition of a fine vertical line, and consequently the resolving power for contiguous vertical lines, is thus independent of the vertical aperture of the instrument, a law of great importance in the theory of the spectroscope.

The distribution of illumination in the image of a luminous line is shown by the curve ABC (fig. 3), representing the value of the function $\sin^2 u/u^2$ from $u = 0$ to $u = 2\pi$. The part corresponding to negative values of u is similar, OA being a line of symmetry.

Let us now consider the distribution of brightness in the image of a double line whose components are of equal strength, and at such an angular interval that the central line in the image of one coincides with the first zero of brightness in the image of the other. In fig. 3 the curve of brightness for one component is ABC, and for the other OA'C'; and the curve representing half the combined brightnesses is E'BE.

The brightness (corresponding to B) midway between the two central points AA' is $\frac{1}{8106}$ of the brightness at the central points themselves. We may consider this to be about the limit of closeness at which there could be any decided appearance of resolution, though doubtless an observer accustomed to his instrument would recognize the duplicity with certainty. The obliquity, corresponding to $u = \pi$, is such that the phases of the secondary waves range over a complete period, i.e. such that the projection of the horizontal aperture upon this direction is one wave-length. We conclude that a double line cannot be fairly resolved unless its components subtend an angle exceeding that subtended by the wave-length of light at a distance equal to the horizontal aperture. This rule is convenient on account of its simplicity; and it is sufficiently accurate in view of the necessary uncertainty as to what exactly is meant by resolution.

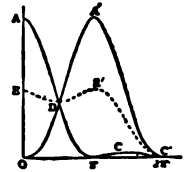

FIG. 3.

If the angular interval between the components of a double line be half as great again as that supposed in the figure, the brightness midway between is $\frac{1}{8106}$ as against $\frac{1}{40450}$ at the central lines of each image. Such a falling off in the middle must be more than sufficient for resolution. If the angle subtended by the components of a double line be twice that subtended by the wave-length at a distance equal to the horizontal aperture, the central bands are just clear of one another, and there is a line of absolute blackness in the middle of the combined images.

The resolving power of a telescope with circular or rectangular aperture is easily investigated experimentally. The best object for examination is a grating of fine wires, about fifty to the inch, backed by a sodium flame. The object-glass is provided with diaphragms pierced with round holes or slits. One of these, of width equal, say, to one-tenth of an inch, is inserted in front of the object-glass, and the telescope, carefully focused all the while, is drawn gradually back from the grating until the lines are no longer seen. From a measurement of the maximum distance the least angle between consecutive lines consistent with resolution may be deduced, and a comparison made with the rule stated above.

Merely to show the dependence of resolving power on aperture it is not necessary to use a telescope at all. It is sufficient to look at wire gauze backed by the sky or by a flame, through a piece of blackened cardboard, pierced by a needle and held close to the eye. By varying the distance the point is easily found at which resolution ceases; and the observation is as sharp as with a telescope. The

function of the telescope is in fact to allow the use of a wider, and therefore more easily measurable, aperture. An interesting modification of the experiment may be made by using light of various wave-lengths.

Since the limitation of the width of the central band in the image of a luminous line depends upon discrepancies of phase among the secondary waves, and since the discrepancy is greatest for the waves which come from the edges of the aperture, the question arises how far the operation of the central parts of the aperture is advantageous. If we imagine the aperture reduced to two equal narrow slits bordering its edges, compensation will evidently be complete when the projection on an oblique direction is equal to $\frac{1}{2}\lambda$, instead of λ as for the complete aperture. By this procedure the width of the central band in the diffraction pattern is halved, and so far an advantage is attained. But, as will be evident, the bright bands bordering the central band are now not inferior to it in brightness; in fact, a band similar to the central band is reproduced an indefinite number of times, so long as there is no sensible discrepancy of phase in the secondary waves proceeding from the various parts of the same slit. Under these circumstances the narrowing of the band is paid for at a ruinous price, and the arrangement must be condemned altogether.

A more moderate suppression of the central parts is, however, sometimes advantageous. Theory and experiment alike prove that a double line, of which the components are equally strong, is better resolved when, for example, one-sixth of the horizontal aperture is blocked off by a central screen; or the rays quite at the centre may be allowed to pass, while others a little farther removed are blocked off. Stops, each occupying one-eighth of the width, and with centres situated at the points of trisection, answer well the required purpose.

It has already been suggested that the principle of energy requires that the general expression for I^2 in (2) when integrated over the whole of the plane ξ, η should be equal to A , where A is the area of the aperture. A general analytical verification has been given by Sir G. G. Stokes (*Edin. Trans.*, 1853, 20, p. 317). Analytically expressed—

$$\iint_{-\infty}^{+\infty} I^2 d\xi d\eta = \iint dx dy = A \dots (9).$$

We have seen that I_0^2 (the intensity at the focal point) was equal to A^2/λ^2 . If A' be the area over which the intensity must be I_0^2 in order to give the actual total intensity in accordance with

$$A'I_0^2 = \iint_{-\infty}^{+\infty} I^2 d\xi d\eta,$$

the relation between A and A' is $AA' = \lambda^2 I_0^2$. Since A' is in some sense the area of the diffraction pattern, it may be considered to be a rough criterion of the definition, and we infer that the definition of a point depends principally upon the area of the aperture, and only in a very secondary degree upon the shape when the area is maintained constant.

4. *Theory of Circular Aperture.*—We will now consider the important case where the form of the aperture is circular.

Writing for brevity

$$k\ell/l = p, \quad h\eta/l = q, \dots (1),$$

we have for the general expression (§ 11) of the intensity

$$\lambda^2 I^2 = S^2 + C^2 \dots (2),$$

where

$$S = \iint \sin(\rho x + qy) dx dy, \dots (3),$$

$$C = \iint \cos(\rho x + qy) dx dy, \dots (4).$$

When, as in the application to rectangular or circular apertures, the form is symmetrical with respect to the axes both of x and y , $S=0$, and C reduces to

$$C = \iint \cos \rho x \cos qy dx dy, \dots (5).$$

In the case of the circular aperture the distribution of light is of course symmetrical with respect to the focal point $\rho=0, q=0$; and C is a function of ρ and q only through $\sqrt{(\rho^2+q^2)}$. It is thus sufficient to determine the intensity along the axis of ρ . Putting $q=0$, we get

$$C = \iint \cos \rho x dx dy = 2 \int_0^{\sqrt{R^2-x^2}} \cos \rho x \sqrt{R^2-x^2} dx,$$

R being the radius of the aperture. This integral is the Bessel's function of order unity, defined by

$$J_1(z) = \frac{z}{\pi} \int_0^\pi \cos(z \cos \phi) \sin^2 \phi d\phi \dots (6).$$

Thus, if $x=R \cos \phi$,

$$C = \pi R^2 \frac{2J_1(\rho R)}{\rho R} \dots (7);$$

and the illumination at distance r from the focal point is

$$I^2 = \frac{\pi^2 R^4}{\lambda^2 r^2} \cdot \frac{4J_1^2\left(\frac{2\pi Rr}{\lambda}\right)}{\left(\frac{2\pi Rr}{\lambda}\right)^2} \dots (8).$$

The ascending series for $J_1(z)$, used by Sir G. B. Airy (*Camb. Trans.*,

1834) in his original investigation of the diffraction of a circular object-glass, and readily obtained from (6), is

$$J_1(z) = \frac{z}{2} - \frac{z^3}{2^2 \cdot 4} + \frac{z^5}{2^2 \cdot 4^2 \cdot 6} - \frac{z^7}{2^2 \cdot 4^3 \cdot 6 \cdot 8} + \dots (9).$$

When z is great, we may employ the semi-convergent series

$$J_1(z) = \sqrt{\left(\frac{2}{\pi z}\right) \sin\left(z - \frac{1}{2}\pi\right)} \left\{ 1 + \frac{3.5.1}{8.16} \left(\frac{1}{z}\right)^2 - \frac{3.5.7.9.1.3.5}{8.16.24.32} \left(\frac{1}{z}\right)^4 + \dots \right\} + \sqrt{\left(\frac{2}{\pi z}\right) \cos\left(z - \frac{1}{2}\pi\right)} \left\{ \frac{3}{8} \frac{1}{z} - \frac{3.5.7.1.3}{8.16.24} \left(\frac{1}{z}\right)^3 + \frac{3.5.7.9.1.1.3.5.7}{8.16.24.32.40} \left(\frac{1}{z}\right)^5 - \dots \right\} \dots (10).$$

A table of the values of $2\pi^{-1}J_1(z)$ has been given by E. C. J. Lommel (*Schlömilch*, 1870, 15, p. 166), to whom is due the first systematic application of Bessel's functions to the diffraction integrals.

The illumination vanishes in correspondence with the roots of the equation $J_1(z)=0$. If these be called z_1, z_2, z_3, \dots the radii of the dark rings in the diffraction pattern are

$$\frac{\lambda z_1}{2\pi R}, \frac{\lambda z_2}{2\pi R}, \dots$$

being thus *inversely* proportional to R .

The integrations may also be effected by means of polar coordinates, taking first the integration with respect to ϕ so as to obtain the result for an infinitely thin annular aperture. Thus, if

$$x = \rho \cos \phi, \quad y = \rho \sin \phi,$$

$$C = \iint \cos \rho x dx dy = \int_0^R \int_0^{2\pi} \cos(\rho \rho \cos \theta) \rho d\theta d\rho.$$

Now by definition

$$J_0(z) = \frac{1}{\pi} \int_0^\pi \cos(z \cos \theta) d\theta = 1 - \frac{z^2}{2^2 \cdot 4} + \frac{z^4}{2^2 \cdot 4^2 \cdot 6} - \dots (11).$$

The value of C for an annular aperture of radius r and width dr is thus

$$dC = 2\pi J_0(\rho r) \rho dr, \dots (12).$$

For the complete circle,

$$C = \frac{2\pi}{\rho^2} \int_0^{\rho R} J_0(s) s ds = \frac{2\pi}{\rho^2} \left\{ \frac{\rho^2 R^2}{2} - \frac{\rho^4 R^4}{2^2 \cdot 4} + \frac{\rho^6 R^6}{2^2 \cdot 4^2 \cdot 6} - \dots \right\} = \pi R^2 \frac{2J_1(\rho R)}{\rho R} \text{ as before.}$$

In these expressions we are to replace ρ by $k\ell/l$, or rather, since the diffraction pattern is symmetrical, by kr/l , where r is the distance of any point in the focal plane from the centre of the system.

The roots of $J_0(z)$ after the first may be found from

$$\frac{z}{\pi} = i - 25 + \frac{050861}{4z-1} - \frac{053041}{(4z-1)^2} + \frac{262051}{(4z-1)^3} \dots (13).$$

and those of $J_1(z)$ from

$$\frac{z}{\pi} = i + 25 - \frac{151982}{4z+1} + \frac{015399}{(4z+1)^2} - \frac{245835}{(4z+1)^3} \dots (14).$$

formulae derived by Stokes (*Camb. Trans.*, 1850, vol. ix.) from the descending series.¹ The following table gives the actual values:—

i	$\frac{z}{\pi}$ for $J_0(z)=0$	$\frac{z}{\pi}$ for $J_1(z)=0$	i	$\frac{z}{\pi}$ for $J_0(z)=0$	$\frac{z}{\pi}$ for $J_1(z)=0$
1	0.7655	1.2197	6	5.7522	6.2439
2	1.7571	2.2330	7	6.7519	7.2448
3	2.7546	3.2383	8	7.7516	8.2454
4	3.7534	4.2411	9	8.7514	9.2459
5	4.7527	5.2428	10	9.7513	10.2463

In both cases the image of a mathematical point is thus a symmetrical ring system. The greatest brightness is at the centre, where

$$dC = 2\pi \rho d\rho, \quad C = \pi R^2.$$

For a certain distance outwards this remains sensibly unimpaired and then gradually diminishes to zero, as the secondary waves become discrepant in phase. The subsequent revivals of brightness forming the bright rings are necessarily of inferior brilliancy as compared with the central disk.

The first dark ring in the diffraction pattern of the complete circular aperture occurs when

$$r/l = 1.2197 \lambda / 2R \dots (15).$$

¹ The descending series for $J_0(z)$ appears to have been first given by Sir W. Hamilton in a memoir on "Fluctuating Functions," *Koy. Irish Trans.*, 1840.

We may compare this with the corresponding result for a rectangular aperture of width a ,

$$E/f = \lambda/a;$$

and it appears that in consequence of the preponderance of the central parts, the compensation in the case of the circle does not set in at so small an obliquity as when the circle is replaced by a rectangular aperture, whose side is equal to the diameter of the circle.

Again, if we compare the complete circle with a narrow annular aperture of the same radius, we see that in the latter case the first dark ring occurs at a much smaller obliquity, viz.

$$r/f = 7655 \lambda / 2R.$$

It has been found by Sir William Herschel and others that the definition of a telescope is often improved by stopping off a part of the central area of the object-glass; but the advantage to be obtained in this way is in no case great, and anything like a reduction of the aperture to a narrow annulus is attended by a development of the external luminous rings sufficient to outweigh any improvement due to the diminished diameter of the central area.¹

The maximum brightnesses and the places at which they occur are easily determined with the aid of certain properties of the Bessel's functions. It is known (see SPHERICAL HARMONICS) that

$$J_0'(s) = -J_1(s), \dots \dots \dots (16);$$

$$J_1(s) = \frac{1}{2} J_0(s) - J_1'(s) \dots \dots \dots (17);$$

$$J_0(s) + J_1(s) = \frac{2}{s} J_1(s) \dots \dots \dots (18).$$

The maxima of C occur when

$$\frac{d}{ds} \left(\frac{J_1(s)}{s} \right) = \frac{J_1'(s)}{s} - \frac{J_1(s)}{s^2} = 0;$$

or by (17) when $J_1(s) = 0$. When s has one of the values thus determined,

$$\frac{2}{s} J_1(s) = J_0(s).$$

The accompanying table is given by Lommel, in which the first column gives the roots of $J_1(s) = 0$, and the second and third columns the corresponding values of the functions specified. It appears that the maximum brightness in the first ring is only about $\frac{1}{4}$ of the brightness at the centre.

s	$2s^{-1}J_1(s)$	$4s^{-2}J_1^2(s)$
0.000000	+1.000000	1.000000
3.135630	- .132279	-0.17498
8.417236	+ .064482	-0.04158
11.619857	- .040008	-0.01601
14.795938	+ .027919	-0.00779
17.959820	- .020905	-0.00437

We will now investigate the total illumination distributed over the area of the circle of radius r . We have

$$I = \frac{\pi R^2}{\lambda^2 f^2} \int_0^s J_1^2(s) ds \dots \dots \dots (19),$$

where

$$s = 2\pi Rr/\lambda f \dots \dots \dots (20).$$

Thus

$$2\pi \int I^2 dr = \frac{\lambda^2 \pi^2 R^4}{2\pi R^2 \lambda^2 f^2} \int I^2 ds = \pi R^2 \cdot 2 \int s^{-1} J_1^2(s) ds.$$

Now by (17), (18)

$$s^{-1} J_1(s) = J_0(s) - J_1'(s);$$

so that

$$s^{-1} J_1^2(s) = -\frac{d}{ds} J_0^2(s) - \frac{d}{ds} J_1^2(s),$$

and

$$2 \int_0^s s^{-1} J_1^2(s) ds = 1 - J_0^2(s) - J_1^2(s) \dots \dots \dots (21).$$

If r , or s , be infinite, $J_0(s)$, $J_1(s)$ vanish, and the whole illumination is expressed by πR^2 , in accordance with the general principle. In any case the proportion of the whole illumination to be found outside the circle of radius r is given by

$$J_0^2(s) + J_1^2(s).$$

For the dark rings $J_1(s) = 0$; so that the fraction of illumination outside any dark ring is simply $J_0^2(s)$. Thus for the first, second, third and fourth dark rings we get respectively .161, .090, .062, .047, showing that more than $\frac{1}{4}$ ths of the whole light is concentrated within the area of the second dark ring (*Phil. Mag.*, 1881).

When s is great, the descending series (10) gives

$$\frac{2J_1(s)}{s} = \frac{2}{s} \sqrt{\left(\frac{2}{\pi s}\right)} \sin(s - \frac{1}{2}\pi) \dots \dots \dots 22;$$

so that the places of maxima and minima occur at equal intervals.

¹ Airy, *loc. cit.* "Thus the magnitude of the central spot is diminished, and the brightness of the rings increased, by covering the central parts of the object-glass."

The mean brightness varies as s^{-4} (or as r^{-4}), and the integral found by multiplying it by $s ds$ and integrating between 0 and ∞ converges.

It may be instructive to contrast this with the case of an infinitely narrow annular aperture, where the brightness is proportional to $J_0^2(s)$. When s is great,

$$J_0(s) = \sqrt{\left(\frac{2}{\pi s}\right)} \cos\left(s - \frac{1}{2}\pi\right).$$

The mean brightness varies as s^{-2} ; and the integral $\int_0^\infty J_0^2(s) s ds$ is not convergent.

5. *Resolving Power of Telescopes.*—The efficiency of a telescope is of course intimately connected with the size of the disk by which it represents a mathematical point. In estimating theoretically the resolving power on a double star we have to consider the illumination of the field due to the superposition of the two independent images. If the angular interval between the components of a double star were equal to twice that expressed in equation (15) above, the central disks of the diffraction patterns would be just in contact. Under these conditions there is no doubt that the star would appear to be fairly resolved, since the brightness of its external ring system is too small to produce any material confusion, unless indeed the components are of very unequal magnitude. The diminution of the star disks with increasing aperture was observed by Sir William Herschel, and in 1823 Fraunhofer formulated the law of inverse proportionality. In investigations extending over a long series of years, the advantage of a large aperture in separating the components of close double stars was fully examined by W. R. Dawes.

The resolving power of telescopes was investigated also by J. B. L. Foucault, who employed a scale of equal bright and dark alternate parts; it was found to be proportional to the aperture and independent of the focal length. In telescopes of the best construction and of moderate aperture the performance is not sensibly prejudiced by outstanding aberration, and the limit imposed by the finiteness of the waves of light is practically reached. M. E. Verdet has compared Foucault's results with theory, and has drawn the conclusion that the radius of the visible part of the image of a luminous point was equal to half the radius of the first dark ring.

The application, unfortunately long delayed, of this principle to the microscope by H. L. F. Helmholtz in 1871 is the foundation of the important doctrine of the *microscopic limit*. It is true that in 1823 Fraunhofer, inspired by his observations upon gratings, had very nearly hit the mark.² And a little before Helmholtz, E. Abbe published a somewhat more complete investigation, also founded upon the phenomena presented by gratings. But although the argument from gratings is instructive and convenient in some respects, its use has tended to obscure the essential unity of the principle of the limit of resolution whether applied to telescopes or microscopes.

In fig. 4, AB represents the axis of an optical instrument (telescope or microscope), A being a point of the object and B a point of the image. By the operation of the object-glass LL' all the rays issuing from A arrive in the same phase at B. Thus if A be self-luminous, the illumination is a maximum at B, where all the secondary waves agree in phase. B is in fact the centre of the diffraction disk which constitutes the image of A. At neighbouring points the illumination is less, in consequence of the discrepancies of phase which there enter. In like manner if we take a neighbouring point P, also self-luminous, in the plane of the object, the waves which issue from it will arrive at B with phases no longer absolutely concordant, and the discrepancy of phase will increase as the interval AP

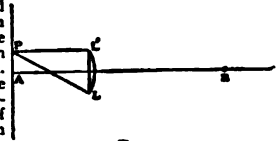

FIG. 4.

² "Man kann daraus schliessen, was möglicher Weise durch Mikroskope noch zu sehen ist. Ein mikroskopischer Gegenstand z. B. dessen Durchmesser = λ ist, und der aus zwei Theilen besteht, kann nicht mehr als zwei Theilen bestehend erkannt werden. Dieses zeigt uns eine Grenze des Sehvermögens durch Mikroskope" (*Gilberti's Ann.* 74, 337). Lord Rayleigh has recorded that he was himself convinced by Fraunhofer's reasoning at a date antecedent to the writings of Helmholtz and Abbe.

increases. When the interval is very small the discrepancy, though mathematically existent, produces no practical effect, and the illumination at B due to P is as important as that due to A, the intensities of the two luminous sources being supposed equal. Under these conditions it is clear that A and P are not separated in the image. The question is to what amount must the distance AP be increased in order that the difference of situation may make itself felt in the image. This is necessarily a question of degree; but it does not require detailed calculations in order to show that the discrepancy first becomes conspicuous when the phases corresponding to the various secondary waves which travel from P to B range over a complete period. The illumination at B due to P then becomes comparatively small, indeed for some forms of aperture evanescent. The extreme discrepancy is that between the waves which travel through the outermost parts of the object-glass at L and L'; so that if we adopt the above standard of resolution, the question is where must P be situated in order that the relative retardation of the rays PL and PL' may on their arrival at B amount to a wave-length (λ). In virtue of the general law that the reduced optical path is stationary in value, this retardation may be calculated without allowance for the different paths pursued on the farther side of L, L', so that the value is simply PL - PL'. Now since AP is very small, AL' - PL' = AP sin α , where α is the angular semi-aperture LAB. In like manner PL - AL has the same value, so that

$$PL - PL' = 2AP \sin \alpha.$$

According to the standard adopted, the condition of resolution is therefore that AP, or δ , should exceed $\frac{1}{2}\lambda/\sin \alpha$. If δ be less than this, the images overlap too much; while if δ greatly exceed the above value the images become unnecessarily separated.

In the above argument the whole space between the object and the lens is supposed to be occupied by matter of one refractive index, and λ represents the wave-length in this medium of the kind of light employed. If the restriction as to uniformity be violated, what we have ultimately to deal with is the wave-length in the medium immediately surrounding the object.

Calling the refractive index μ , we have as the critical value of δ ,

$$\delta = \frac{1}{2}\lambda/\mu \sin \alpha \quad (1).$$

λ_0 being the wave-length in *vacuo*. The denominator $\mu \sin \alpha$ is the quantity well known (after Abbe) as the "numerical aperture."

The extreme value possible for α is a right angle, so that for the microscopic limit we have

$$\delta = \frac{1}{2}\lambda_0/\mu \quad (2).$$

The limit can be depressed only by a diminution in λ_0 , such as photography makes possible, or by an increase in μ , the refractive index of the medium in which the object is situated.

The statement of the law of resolving power has been made in a form appropriate to the microscope, but it admits also of immediate application to the telescope. If 2R be the diameter of the object-glass and D the distance of the object, the angle subtended by AP is α/D , and the angular resolving power is given by

$$\lambda/2D \sin \alpha = \lambda/2R \quad (3).$$

This method of derivation (substantially due to Helmholtz) makes it obvious that there is no essential difference of principle between the two cases, although the results are conveniently stated in different forms. In the case of the telescope we have to deal with a linear measure of aperture and an angular limit of resolution, whereas in the case of the microscope the limit of resolution is linear, and it is expressed in terms of angular aperture.

It must be understood that the above argument distinctly assumes that the different parts of the object are self-luminous, or at least that the light proceeding from the various points is without phase relations. As has been emphasized by Gr. J. Stoney, the restriction is often, perhaps usually, violated in the microscope. A different treatment is then necessary, and for some of the problems which arise under this head the method of Abbe is convenient.

The importance of the general conclusions above formulated, as imposing a limit upon our powers of direct observation, can hardly be overestimated; but there has been in some quarters a tendency to ascribe to it a more precise character than it can bear, or even to mistake its meaning altogether. A few words of further explanation may therefore be desirable. The first point to be emphasized is that nothing whatever is said as to the smallness of a single object that may be made visible. The eye, unaided or armed with a telescope, is able to see, as points of light, stars subtending no sensible angle. The visibility of a star is a question of brightness simply, and has nothing to do with resolving power. The latter element enters only when it is a question of recognizing the duplicity of a double star, or of distinguishing detail upon the surface of a planet. So in the microscope there is nothing except lack of light to hinder the visibility of an object however small. But if its dimensions be much less than the half wave-length, it can only be seen as a whole, and its parts cannot be distinctly separated, although in cases near the border line some inference may be possible, founded upon experience of what appearances are presented in various cases. In observing observations upon particles, *ultra-microscopic* in the above sense, have been recorded by H. F. W. Siedentopf and R. A. Zsigmondy (*Drude's Ann.*, 1903, 10, p. 1).

In a somewhat similar way a dark linear interruption in a bright ground may be visible, although its actual width is much inferior to the half wave-length. In illustration of this fact a simple experiment may be mentioned. In front of the naked eye was held a piece of copper foil perforated by a fine needle hole. Observed through this the structure of some wire gauze just disappeared at a distance from the eye equal to 17 in., the gauze contained 46 meshes to the inch. On the other hand, a single wire 0.034 in. in diameter remained fairly visible up to a distance of 20 ft. The ratio between the limiting angles subtended by the periodic structure of the gauze and the diameter of the wire was $(.022 \cdot 034) \times (240/17) = 9.1$. For further information upon this subject reference may be made to *Phil. Mag.*, 1896, 42, p. 167; *Journ. R. Micr. Soc.*, 1903, p. 447.

6. Coronas or Glories.—The results of the theory of the diffraction patterns due to circular apertures admit of an interesting application to coronas, such as are often seen encircling the sun and moon. They are due to the interposition of small spherules of water, which act the part of diffracting obstacles. In order to the formation of a well-defined corona it is essential that the particles be exclusively, or preponderantly, of one size.

If the origin of light be treated as infinitely small, and be seen in focus, whether at the naked eye or with the aid of a telescope, the whole of the light in the absence of obstacles would be concentrated in the immediate neighbourhood of the focus. As other parts of the field the effect is the same, in accordance with the principle known as Babinet's, whether the imaginary screen in front of the object-glass is generally transparent but studded with a number of opaque circular disks, or is generally opaque but perforated with corresponding apertures. Since at these points the resultant due to the whole aperture is zero, any two portions into which the whole may be divided must give equal and opposite resultants. Consider now the light diffracted in a direction many times more oblique than any with which we should be concerned, were the whole aperture uninterrupted, and take first the effect of a single small aperture. The light in the proposed direction is that determined by the size of the small aperture in accordance with the laws already investigated, and its phase depends upon the position of the aperture. If we take a direction such that the light (of given wave-length) from a single aperture vanishes, the evanescence continues even when the whole series of apertures is brought into contemplation. Hence, whatever else may happen, there must be a system of dark rings formed, the same as from a single small aperture. In directions other than these it is a more delicate question how the partial effects should be compounded. If we make the extreme suppositions of an infinitely small source and absolutely homogeneous light, there is no escape from the conclusion that the light in a definite direction is arbitrary, that is, dependent upon the chance distribution of apertures. If, however, as in practice, the light be heterogeneous, the source of finite size, the obstacles in motion, and the discrimination of different directions imperfect, we are concerned merely with the mean brightness found by varying the arbitrary phase-relations, and this is obtained by simply multiplying the brightness due to a single aperture by the number of apertures (n) (see INTERFERENCE OF LIGHT, § 4). The diffraction pattern is therefore that due to a single aperture, merely brightened n times.

In his experiments upon this subject Fraunhofer employed plates of glass dusted over with lycopodium, or studded with small metallic disks of uniform size; and he found that the diameters of the rings were proportional to the length of the waves and inversely as the diameter of the disks.

In another respect the observations of Fraunhofer appear at first sight to be in discord with theory; for his measures of the diameters of the red rings, visible when white light was employed, correspond with the law applicable to dark rings, and not to the different law applicable to the luminous maxima. Verdet has, however, pointed out that the observation in this form is essentially different from that in which homogeneous red light is employed, and that the position of the red rings would correspond to the absence of blue-green light rather than to the greatest abundance of red light. Verdet's own observations, conducted with great care, fully confirm this view, and exhibit a complete agreement with theory.

By measurements of coronas it is possible to infer the size of the particles to which they are due, an application of considerable interest in the case of natural coronas—the general rule being the larger the corona the smaller the water spherules. Young employed this method not only to determine the diameters of cloud particles (e.g. 1.5μ in.), but also those of fibrous material, for which the theory is analogous. His instrument was called the *criometer* (see 'Chromatics,' vol. iii. of *supp. to Ency. Brit.*, 1877).

7. Influence of Aberration. Optical Power of Instruments.—Our investigations and estimates of resolving power have thus far proceeded upon the supposition that there are no optical imperfections, whether of the nature of a regular aberration or dependent upon irregularities of material and workmanship. In

practice there will always be a certain aberration or error of phase, which we may also regard as the deviation of the actual wave-surface from its intended position. In general, we may say that aberration is unimportant when it nowhere (or at any rate over a relatively small area only) exceeds a small fraction of the wavelength (λ). Thus in estimating the intensity at a focal point, where, in the absence of aberration, all the secondary waves would have exactly the same phase, we see that an aberration nowhere exceeding $\frac{1}{2}\lambda$ can have but little effect.

The only case in which the influence of small aberration upon the entire image has been calculated (*Phil. Mag.*, 1879) is that of a rectangular aperture, traversed by a cylindrical wave with aberration equal to $c\lambda^2$. The aberration is here unsymmetrical, the wave being in advance of its proper place in one half of the aperture, but behind in the other half. No terms in x or x^2 need be considered. The first would correspond to a general turning of the beam; and the second would imply imperfect focusing of the central parts. The effect of aberration may be considered in two ways. We may suppose the aperture (a) constant, and inquire into the operation of an increasing aberration; or we may take a given value of c (i.e. a given wave-surface) and examine the effect of a varying aperture. The results in the second case show that an increase of aperture up to that corresponding to an extreme aberration of half a period has no ill effect upon the central band (β 3), but it increases unduly the intensity of one of the neighbouring lateral bands; and the practical conclusion is that the best results will be obtained from an aperture giving an extreme aberration of from a quarter to half a period, and that with an increased aperture aberration is not so much a direct cause of deterioration as an obstacle to the attainment of that improved definition which should accompany the increase of aperture.

If, on the other hand, we suppose the aperture given, we find that aberration begins to be distinctly mischievous when it amounts to about a quarter period, i.e. when the wave-surface deviates at each end by a quarter wave-length from the true plane.

As an application of this result, let us investigate what amount of temperature disturbance in the tube of a telescope may be expected to impair definition. According to J. B. Biot and F. J. D. Arago, the index μ for air at t° C. and at atmospheric pressure is given by

$$\mu - 1 = \frac{0.00279}{1 + 0.0037t}$$

If we take 0° C. as standard temperature, $\delta\mu = -1.1 \times 10^{-6}$.

Thus, on the supposition that the irregularity of temperature t extends through a length l , and produces an acceleration of a quarter of a wave-length,

$$\delta\lambda = 1.1 l \times 10^{-6}$$

or, if we take $\lambda = 5.3 \times 10^{-7}$,

$$l = 12,$$

the unit of length being the centimetre.

We may infer that, in the case of a telescope tube 12 cm. long, a stratum of air heated 1° C. lying along the top of the tube, and occupying a moderate fraction of the whole volume, would produce a not insensible effect. If the change of temperature progressed uniformly from one side to the other, the result would be a lateral displacement of the image without loss of definition; but in general both effects would be observable. In longer tubes a similar disturbance would be caused by a proportionally less difference of temperature. S. P. Langley has proposed to obviate such ill-effects by stirring the air included within a telescope tube. It has long been known that the definition of a carbon bisulphide prism may be much improved by a vigorous shaking.

We will now consider the application of the principle to the formation of images, unassisted by reflection or refraction (*Phil. Mag.*, 1881). The function of a lens in forming an image is to compensate by its variable thickness the differences of phase which would otherwise exist between secondary waves arriving at the focal point from various parts of the aperture. If we suppose the diameter of the lens to be given ($2R$), and its focal length f gradually to increase, the original differences of phase at the image of an infinitely distant luminous point diminish without limit. When f attains a certain value, say f_1 , the extreme error of phase to be compensated falls to $\frac{1}{2}\lambda$. But, as we have seen, such an error of phase causes no sensible deterioration in the definition; so that from this point onwards the lens is useless, as only improving an image already sensibly as perfect as the aperture admits of. Throughout the operation of increasing the focal length, the resolving power of the instrument, which depends only upon the aperture, remains unchanged; and we thus arrive at the rather startling conclusion that a telescope of any degree of resolving power might be constructed without an object-glass, if only there were no limit to the admissible focal length. This last proviso, however, as we shall see, takes away almost all practical importance from the proposition.

To get an idea of the magnitudes of the quantities involved, let us take the case of an aperture of $\frac{1}{2}$ in., about that of the pupil of the eye. The distance f_1 , which the actual focal length must exceed, is given by

$$\sqrt{(f_1^2 + R^2)} - f_1 = \frac{1}{2}\lambda;$$

so that

$$f_1 = 2R^2/\lambda \dots \dots \dots (1).$$

Thus, if $\lambda = \frac{1}{100000}$, $R = \frac{1}{4}$, we find

$$f_1 = 800 \text{ inches.}$$

The image of the sun thrown upon a screen at a distance exceeding 66 ft., through a hole $\frac{1}{2}$ in. in diameter, is therefore at least as well defined as that seen direct.

As the minimum focal length increases with the square of the aperture, a quite impracticable distance would be required to rival the resolving power of a modern telescope. Even for an aperture of $\frac{1}{4}$ in., f_1 would have to be 5 miles.

A similar argument may be applied to find at what point an achromatic lens becomes sensibly superior to a single one. The question is whether, when the adjustment of focus is correct for the central rays of the spectrum, the error of phase for the most extreme rays (which it is necessary to consider) amounts to a quarter of a wave-length. If not, the substitution of an achromatic lens will be of no advantage. Calculation shows that, if the aperture be $\frac{1}{2}$ in., an achromatic lens has no sensible advantage if the focal length be greater than about 11 in. If we suppose the focal length to be 66 ft., a single lens is practically perfect up to an aperture of 1.7 in.

Another obvious inference from the necessary imperfection of optical images is the uselessness of attempting anything like an absolute destruction of spherical aberration. An admissible error of phase of $\frac{1}{2}\lambda$ will correspond to an error of $\frac{1}{2}\lambda$ in a reflecting and $\frac{1}{4}\lambda$ in a (glass) refracting surface, the incidence in both cases being perpendicular. If we inquire what is the greatest admissible longitudinal aberration (δf) in an object-glass according to the above rule, we find

$$\delta f = \lambda a^2 \dots \dots \dots (2),$$

a being the angular semi-aperture.

In the case of a single lens of glass with the most favourable curvatures, δf is about equal to $a^2 f$, so that a^2 must not exceed λ/f . For a lens of 3 ft. focus this condition is satisfied if the aperture does not exceed $\frac{1}{2}$ in.

When parallel rays fall directly upon a spherical mirror the longitudinal aberration is only about one-eighth as great as for the most favourably shaped single lens of equal focal length and aperture. Hence a spherical mirror of 3 ft. focus might have an aperture of $2\frac{1}{2}$ in., and the image would not suffer materially from aberration.

On the same principle we may estimate the least visible displacement of the eye-piece of a telescope focused upon a distant object, a question of interest in connexion with range-finders. It appears (*Phil. Mag.*, 1885, 20, p. 354) that a displacement δf from the true focus will not sensibly impair definition, provided

$$\delta f < f^2/R^2 \dots \dots \dots (3),$$

$2R$ being the diameter of aperture. The linear accuracy required is thus a function of the ratio of aperture to focal length. The formula agrees well with experiment.

The principle gives an instantaneous solution of the question of the ultimate optical efficiency in the method of "mirror-reading," as commonly practised in various physical observations. A rotation by which one edge of the mirror advances $\frac{1}{2}\lambda$ (while the other edge retreats to a like amount) introduces a phase-discrepancy of a whole period where before the rotation there was complete agreement. A rotation of this amount should therefore be easily visible, but the limits of resolving power are being approached; and the conclusion is independent of the focal length of the mirror; and of the employment of a telescope, provided of course that the reflected image is seen in focus, and that the full width of the mirror is utilized.

A comparison with the method of a material pointer, attached to the parts whose rotation is under observation, and viewed through a microscope, is of interest. The limiting efficiency of the microscope is attained when the angular aperture amounts to 180° ; and it is evident that a lateral displacement of the point under observation through $\frac{1}{2}\lambda$ entails (at the old image) a phase-discrepancy of a whole period, one extreme ray being accelerated and the other retarded by half that amount. We may infer that the limits of efficiency in the two methods are the same when the length of the pointer is equal to the width of the mirror.

We have seen that in perpendicular reflection a surface error not exceeding $\frac{1}{2}\lambda$ may be admissible. In the case of oblique reflection at an angle ϕ , the error of retardation due to an elevation BD (fig. 5) is

$$QQ' - QS = BD \sec \phi (1 - \cos SQQ') = BD \sec \phi (1 + \cos 2\phi) = 2BD \cos \phi;$$

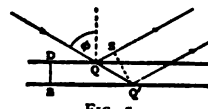

FIG. 5.

from which it follows that an error of given magnitude in the figure of a surface is less important in oblique than in perpendicular reflection. It must, however, be borne in mind that errors can sometimes be compensated by altering adjustments. If a surface intended to be flat is affected with a slight general curvature, a remedy may be found in an alteration of focus, and the remedy is the less complete as the reflection is more oblique.

The formula expressing the optical power of prismatic spectroscopes may readily be investigated upon the principles of the wave theory. Let A_0B_0 be a plane wave-surface of the light before it falls upon the prism, AB the corresponding wave-surface for a particular part of the spectrum after the light has passed the prism, or after it has passed the eye-piece of the observing telescope. The path of a ray from the wave-surface A_0B_0 to A or B is determined by the condition that the optical distance, $\int \mu ds$, is a minimum; and, as AB is by supposition a wave-surface, this optical distance is the same for both points. Thus

$$\int \mu ds \text{ (for A)} = \int \mu ds \text{ (for B)} \dots (4)$$

We have now to consider the behaviour of light belonging to a neighbouring part of the spectrum. The path of a ray from the wave-surface A_0B_0 to the point A is changed; but in virtue of the minimum property the change may be neglected in calculating the optical distance, as it influences the result by quantities of the second order only in the changes of refrangibility. Accordingly, the optical distance from A_0B_0 to A is represented by $\int (\mu + \mu') ds$, the integration being along the original path $A_0 \dots A$; and similarly the optical distance between A_0B_0 and B is represented by $\int (\mu + \mu'') ds$, the integration being along $B_0 \dots B$. In virtue of (4) the difference of the optical distances to A and B is

$$\int \mu' ds \text{ (along } B_0 \dots B) - \int \mu' ds \text{ (along } A_0 \dots A) \quad (5)$$

The new wave-surface is formed in such a position that the optical distance is constant; and therefore the dispersion, or the angle through which the wave-surface is turned by the change of refrangibility, is found simply by dividing (5) by the distance AB. If, as in common flint-glass spectroscopes, there is only one dispersing substance, $\int \mu' ds = \mu' s$, where s is simply the thickness traversed by the ray. If t_1 and t_2 be the thicknesses traversed by the extreme rays, and a denote the width of the emergent beam, the dispersion θ is given by

$$\theta = \mu' (t_2 - t_1) / a,$$

or, if t_1 be negligible,

$$\theta = \mu' t_2 / a \dots (6)$$

The condition of resolution of a double line whose components subtend an angle θ is that θ must exceed λ/a . Hence, in order that a double line may be resolved whose components have indices μ and $\mu + \mu'$, it is necessary that t should exceed the value given by the following equation—

$$t = \lambda / \mu' \dots (7)$$

8. *Diffraction Gratings.*—Under the heading "Colours of Striated Surfaces," Thomas Young (*Phil. Trans.*, 1802) in his usual summary fashion gave a general explanation of these colours, including the law of sines, the striations being supposed to be straight, parallel and equidistant. Later, in his article "Chromatics" in the supplement to the 5th edition of this encyclopaedia, he shows that the colours "lose the mixed character of periodical colours, and resemble much more the ordinary prismatic spectrum, with intervals completely dark interposed," and explains it by the consideration that any phase-difference which may arise at neighbouring striae is multiplied in proportion to the total number of striae.

The theory was further developed by A. J. Fresnel (1815), who gave a formula equivalent to (5) below. But it is to J. von Fraunhofer that we owe most of our knowledge upon this subject. His recent discovery of the "fixed lines" allowed a precision of observation previously impossible. He constructed gratings up to 340 periods to the inch by straining fine wire over screws. Subsequently he ruled gratings on a layer of gold-leaf attached to glass, or on a layer of grease similarly supported, and again by attacking the glass itself with a diamond point. The best gratings were obtained by the last method, but a suitable diamond point was hard to find, and to preserve. Observing through a telescope with light perpendicularly incident, he showed that the position of any ray was dependent only upon the grating interval, viz. the distance from the centre of one wire or line to the centre of the

next, and not otherwise upon the thickness of the wire and the magnitude of the interspace. In different gratings the lengths of the spectra and their distances from the axis were inversely proportional to the grating interval, while with a given grating the distances of the various spectra from the axis were as 1, 2, 3, &c. To Fraunhofer we owe the first accurate measurements of wave-lengths, and the method of separating the overlapping spectra by a prism dispersing in the perpendicular direction. He described also the complicated patterns seen when a point of light is viewed through two superposed gratings, whose lines cross one another perpendicularly or obliquely. The above observations relate to transmitted light, but Fraunhofer extended his inquiry to the light reflected. To eliminate the light returned from the hinder surface of an engraved grating, he covered it with a black varnish. It then appeared that under certain angles of incidence parts of the resulting spectra were completely polarised. These remarkable researches of Fraunhofer, carried out in the years 1817-1823, are republished in his *Collected Writings* (Munich, 1888).

The principle underlying the action of gratings is identical with that discussed in § 2, and exemplified in J. L. Sorét's "zone plates." The alternate Fresnel's zones are blocked out or otherwise modified; in this way the original compensation is upset and a revival of light occurs in unusual directions. If the source be a point or a line, and a collimating lens be used, the incident waves may be regarded as plane. If, further, on leaving the grating the light be received by a focusing lens, e.g. the object-glass of a telescope, the Fresnel's zones are reduced to parallel and equidistant straight strips, which at certain angles coincide with the ruling. The directions of the lateral spectra are such that the passage from one element of the grating to the corresponding point of the next implies a retardation of an integral number of wave-lengths. If the grating be composed of alternate transparent and opaque parts, the question may be treated by means of the general integrals (§ 3) by merely limiting the integration to the transparent parts of the aperture. For an investigation upon these lines the reader is referred to Airy's *Treatise*, to Verdet's *Lectures*, or to R. W. Wood's *Physical Optics*. If, however, we assume the theory of a simple rectangular aperture (§ 3); the results of the ruling can be inferred by elementary methods, which are perhaps more instructive.

Apart from the ruling, we know that the image of a mathematical line will be a series of narrow bands, of which the central one is by far the brightest. At the middle of this band there is complete agreement of phase among the secondary waves. The dark lines which separate the bands are the places at which the phases of the secondary wave range over an integral number of periods. If now we suppose the aperture AB to be covered by a great number of opaque strips or bars of width d , separated by transparent intervals of width a , the condition of things in the directions just spoken of is not materially changed. At the central point there is still complete agreement of phase; but the amplitude is diminished in the ratio of $a : a + d$. In another direction, making a small angle with the last, such that the projection of AB upon it amounts to a few wave-lengths, it is easy to see that the mode of interference is the same as if there were no ruling. For example, when the direction is such that the projection of AB upon it amounts to one wave-length, the elementary components neutralize one another, because their phases are distributed symmetrically, though discontinuously, round the entire period. The only effect of the ruling is to diminish the amplitude in the ratio $a : a + d$; and, except for the difference in illumination, the appearance of a line of light is the same as if the aperture were perfectly free.

The lateral (spectral) images occur in such directions that the projection of the element $(a + d)$ of the grating upon them is an exact multiple of λ . The effect of each of the n elements of the grating is then the same; and, unless this vanishes on account of a particular adjustment of the ratio $a : d$, the resultant amplitude becomes comparatively very great. These directions, in which the retardation between A and B is exactly $m\lambda$, may be called the principal directions. On either side of any one of them the illumination is distributed according to the same law as for the central image ($m = 0$), vanishing, for example, when the retardation amounts to $(m \pm 1)\lambda$. In considering the relative brightnesses of the different spectra, it is therefore sufficient to attend merely to the principal directions; provided that the whole deviation be not so great that its cosine differs considerably from unity.

We have now to consider the amplitude due to a single element, which we may conveniently regard as composed of a transparent part a bounded by two opaque parts of width $\frac{1}{2}d$. The phase of the resultant effect is by symmetry that of the component which comes from the middle of a . The fact that the other components have phases differing from this by amounts ranging between $\pm \frac{1}{2}m\lambda / (a + d)$ causes the resultant amplitude to be less than for the central image (where there is complete phase agreement).

If B_m denote the brightness of the m^{th} lateral image, and B_0 that of the central image, we have

$$B_m : B_0 = \left[\int_{-\frac{\pi+d}{2}}^{+\frac{\pi+d}{2}} \cos x dx + \frac{2m\pi x}{a+d} \right]^2 = \left(\frac{a+d}{\pi} \right)^2 \sin^2 \frac{m\pi x}{a+d} \quad (1).$$

If B denotes the brightness of the central image when the whole of the space occupied by the grating is transparent, we have

$$B_0 : B = a^2 : (a+d)^2,$$

and thus

$$B_m : B = \frac{1}{m^2} \sin^2 \frac{2m\pi x}{a+d} \quad \dots \quad (2).$$

The sine of an angle can never be greater than unity; and consequently under the most favourable circumstances only $1/m^2$ of the original light can be obtained in the m^{th} spectrum. We conclude that, with a grating composed of transparent and opaque parts, the utmost light obtainable in any one spectrum is in the first, and there amounts to $1/a^2$, or about $1/4$, and that for this purpose a and d must be equal. When $d = a$ the general formula becomes

$$B_m : B = \frac{\sin^2 \frac{1}{2} m\pi x}{m^2} \quad \dots \quad (3),$$

showing that, when m is even, B_m vanishes, and that, when m is odd,

$$B_m : B = 1/m^2.$$

The third spectrum has thus only $1/27$ of the brilliancy of the first.

Another particular case of interest is obtained by supposing a small relatively to $(a+d)$. Unless the spectrum be of very high order, we have simply

$$B_m : B = [a/(a+d)]^2 \quad \dots \quad (4);$$

so that the brightnesses of all the spectra are the same.

The light stopped by the opaque parts of the grating, together with that distributed in the central image and lateral spectra, ought to make up the brightness that would be found in the central image, were all the apertures transparent. Thus, if $a = d$, we should have

$$1 = \frac{1}{2} + \frac{1}{4} + \frac{2}{9} \left(1 + \frac{1}{25} + \dots \right),$$

which is true by a known theorem. In the general case

$$\frac{a}{a+d} = \left(\frac{a}{a+d} \right)^2 + \frac{2}{\pi} \sum_{m=1}^{\infty} \frac{1}{m} \sin^2 \left(\frac{m\pi a}{a+d} \right),$$

a formula which may be verified by Fourier's theorem.

According to a general principle formulated by J. Babinet, the brightness of a lateral spectrum is not affected by an interchange of the transparent and opaque parts of the grating. The vibrations corresponding to the two parts are precisely antagonistic, since if both were operative the resultant would be zero. So far as the application to gratings is concerned, the same conclusion may be derived from (2).

From the value of $B_m : B_0$ we see that no lateral spectrum can surpass the central image in brightness; but this result depends upon the hypothesis that the ruling acts by opacity, which is generally very far from being the case in practice. In an engraved glass grating there is no opaque material present by which light could be absorbed, and the effect depends upon a difference of retardation in passing the alternate parts. It is possible to prepare gratings which give a lateral spectrum brighter than the central image, and the explanation is easy. For if the alternate parts were equal and alike transparent, but so constituted as to give a relative retardation of $\frac{1}{2}\lambda$, it is evident that the central image would be entirely extinguished, while the first spectrum would be four times as bright as if the alternate parts were opaque. If it were possible to introduce at every part of the aperture of the grating an arbitrary retardation, all the light might be concentrated in any desired spectrum. By supposing the retardation to vary uniformly and continuously we

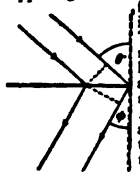

FIG. 6.

fall upon the case of an ordinary prism: but there is then no diffraction spectrum in the usual sense. To obtain such it would be necessary that the retardation should gradually alter by a wave-length in passing over any element of the grating, and then fall back to its previous value, thus springing suddenly over a wave-length (*Phil. Mag.*, 1874, 47, p. 193). It is not likely that such a result will ever be fully attained in practice; but the case is worth stating, in order to show that there is no theoretical limit to the concentration of light of assigned wave-length in one spectrum, and as illustrating the frequently observed unsymmetrical character of the spectra on the two sides of the central image.¹

We have hitherto supposed that the light is incident perpen-

dicularly upon the grating; but the theory is easily extended. If the incident rays make an angle θ with the normal (fig. 6), and the diffracted rays make an angle ϕ (upon the same side), the relative retardation from each element of width $(a+d)$ to the next is $(a+d) (\sin \theta \sin \phi)$; and this is the quantity which is to be equated to $m\lambda$. Thus

$$\sin \theta + \sin \phi = 2 \sin \frac{1}{2}(\theta + \phi) \cos \frac{1}{2}(\theta - \phi) = m\lambda / (a+d) \quad (5).$$

The "deviation" is $(\theta + \phi)$, and is therefore a minimum when $\theta = \phi$, i.e. when the grating is so situated that the angles of incidence and diffraction are equal.

In the case of a reflection grating the same method applies. If θ and ϕ denote the angles with the normal made by the incident and diffracted rays, the formula (5) still holds, and, if the deviation be reckoned from the direction of the regularly reflected rays, it is expressed as before by $(\theta + \phi)$, and is a minimum when $\theta = \phi$, that is, when the diffracted rays return upon the course of the incident rays.

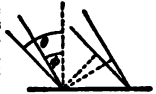

FIG. 7.

In either case (as also with a prism) the position of minimum deviation leaves the width of the beam unaltered, i.e. neither magnifies nor diminishes the angular width of the object under view.

From (5) we see that, when the light falls perpendicularly upon a grating ($\theta = 0$), there is no spectrum formed (the image corresponding to $m = 0$ not being counted as a spectrum), if the grating interval a or $(a+d)$ is less than λ . Under these circumstances, if the material of the grating be completely transparent, the whole of the light must appear in the direct image, and the ruling is not perceptible. From the absence of spectra Fraunhofer argued that there must be a microscopic limit represented by λ ; and the inference is plausible, to say the least (*Phil. Mag.*, 1836). Fraunhofer should, however, have fixed the microscopic limit at $\frac{1}{2}\lambda$, as appears from (5), when we suppose $\theta = \frac{1}{2}\pi$, $\phi = \frac{1}{2}\pi$.

We will now consider the important subject of the resolving power of gratings, as dependent upon the number of lines (n) and the order of the spectrum observed (m). Let BP (fig. 8) be the direction of the principal maximum (middle of central band) for the wave-length λ in the m^{th} spectrum. Then the relative retardation of the extreme rays (corresponding to the edges A, B of the grating) is $m\pi\lambda$. If BQ be the direction for the first minimum (the darkness between the central and first lateral band), the relative retardation of the extreme rays is $(m\pi + \frac{1}{2})\lambda$. Suppose now that $\lambda + \delta\lambda$ is the wave-length for which BQ gives the principal maximum, then

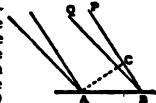

FIG. 8.

$$(m\pi + \frac{1}{2})\lambda = m\pi(\lambda + \delta\lambda);$$

whence

$$\delta\lambda / \lambda = 1/m\pi n \quad \dots \quad (6).$$

According to our former standard, this gives the smallest difference of wave-lengths in a double line which can be just resolved; and we conclude that the resolving power of a grating depends upon the total number of lines, and upon the order of the spectrum, without regard to any other considerations. It is here of course assumed that the n lines are really utilized.

In the case of the D lines the value of $\delta\lambda/\lambda$ is about $1/1000$; so that to resolve this double line in the first spectrum requires 1000 lines, in the second spectrum 500, and so on.

It is especially to be noticed that the resolving power does not depend directly upon the closeness of the ruling. Let us take the case of a grating $\frac{1}{2}$ in. broad, and containing 1000 lines, and consider the effect of interpolating an additional 1000 lines, so as to bisect the former intervals. There will be destruction by interference of the first, third and odd spectra generally; while the advantage gained in the spectra of even order is not in dispersion, nor in resolving power, but simply in brilliancy, which is increased four times. If we now suppose half the grating cut away, so as to leave 1000 lines in half an inch, the dispersion will not be altered, while the brilliancy and resolving power are halved.

There is clearly no theoretical limit to the resolving power of gratings, even in spectra of given order. But it is possible that, as suggested by Rowland,² the structure of natural spectra may be too coarse to give opportunity for resolving powers much higher than those now in use. However this may be, it would always be possible, with the aid of a grating of given resolving power, to construct artificially from white light mixtures of slightly different wave-length whose resolution or otherwise would discriminate between powers inferior and superior to the given one.³

¹ Compare also F. F. Lippich, *Pogg. Ann.* cxxxix. p. 465, 1870; *Rayleigh, Nature* (October 2, 1873).

² The power of a grating to construct light of nearly definite wave-length is well illustrated by Young's comparison with the production of a musical note by reflection of a sudden sound from a row of palls. The objection raised by Herschel (*Light*, § 703) to this comparison depends on a misconception.

³ The last sentence is repeated from the writer's article "Wave Theory" in the 9th edition of this work, but A. A. Michelson's ingenious échelon grating constitutes a realization in an unexpected manner of what was thought to be impracticable.—[R.]

If we define as the "dispersion" in a particular part of the spectrum the ratio of the angular interval $\delta\theta$ to the corresponding increment of wave-length $\delta\lambda$, we may express it by a very simple formula. For the alteration of wave-length entails, at the two limits of a diffracted wave-front, a relative retardation equal to $m\delta\lambda$. Hence, if a be the width of the diffracted beam, and $\delta\theta$ the angle through which the wave-front is turned,

$$\text{or } \frac{a\delta\theta}{\delta\lambda} = m\sin\delta, \quad \text{dispersion} = m\sin\delta/a \quad (7).$$

The resolving power and the width of the emergent beam fix the optical character of the instrument. The latter element must eventually be decreased until less than the diameter of the pupil of the eye. Hence a wide beam demands treatment with further apparatus (usually a telescope) of high magnifying power.

In the above discussion it has been supposed that the ruling is accurate, and we have seen that by increase of m a high resolving power is attainable with a moderate number of lines. But this procedure (apart from the question of illumination) is open to the objection that it makes excessive demands upon accuracy. According to the principle already laid down it can make but little difference in the principal direction corresponding to the first spectrum, provided each line lie within a quarter of an interval $(a+\delta)$ from its theoretical position. But, to obtain an equally good result in the m^{th} spectrum, the error must be less than $1/m$ of the above amount.¹

There are certain errors of a systematic character which demand special consideration. The spacing is usually effected by means of a screw, to each revolution of which corresponds a large number (e.g. one hundred) of lines. In this way it may happen that although there is almost perfect periodicity with each revolution of the screw after (say) 100 lines, yet the 100 lines themselves are not equally spaced. The "ghosts" thus arising were first described by G. H. Quincke (*Pogg. Ann.* 1873, 146, p. 1), and have been elaborately investigated by C. S. Peirce (*Am. Jour. Math.*, 1879, 2, p. 330), both theoretically and experimentally. The general nature of the effects to be expected in such a case may be made clear by means of an illustration already employed for another purpose. Suppose two similar and accurately ruled transparent gratings to be superposed in such a manner that the lines are parallel. If the one set of lines exactly bisect the intervals between the others, the grating interval is practically halved, and the previously existing spectra of odd order vanish. But a very slight relative displacement will cause the apparition of the odd spectra. In this case there is approximate periodicity in the half interval, but complete periodicity only after the whole interval. The advantage of approximate bisection lies in the superior brilliancy of the surviving spectra; but in any case the compound grating may be considered to be perfect in the longer interval, and the definition is as good as if the bisection were accurate.

The effect of a gradual increase in the interval (fig. 9) as we pass across the grating has been investigated by M. A. Cornu (*C.R.*, 1875, 80, p. 655), who thus explains an anomaly observed by

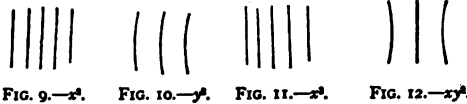

E. E. N. Mascart. The latter found that certain gratings exercised a converging power upon the spectra formed upon one side, and a corresponding diverging power upon the spectra on the other side. Let us suppose that the light is incident perpendicularly, and that the grating interval increases from the centre towards that edge which lies nearest to the spectrum under observation, and decreases towards the hinder edge. It is evident that the waves from both halves of the grating are accelerated in an increasing degree, as we pass from the centre out-

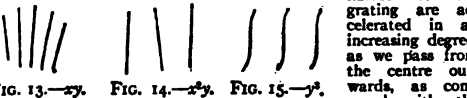

wards, as compared with the phase they would possess were the central value of the grating interval maintained throughout. The irregularity of spacing has thus the effect of a convex lens, which accelerates the marginal relatively to the central rays. On the other side the effect is reversed. This kind of irregularity may clearly be present in a

¹ It must not be supposed that errors of this order of magnitude are unobjectionable in all cases. The position of the middle of the bright band representative of a mathematical line can be fixed with a spider-line micrometer within a small fraction of the width of the band, just as the accuracy of astronomical observations far transcends the separating power of the instrument.

degree surpassing the usual limits, without loss of definition, when the telescope is focused so as to secure the best effect.

It may be worth while to examine further the other variations from correct ruling which correspond to the various terms expressing the deviation of the wave-surface from a perfect plane. If x and y be co-ordinates in the plane of the wave-surface, the axis of y being parallel to the lines of the grating, and the origin corresponding to the centre of the beam, we may take as an approximate equation to the wave-surface

$$z = \frac{x^2}{2\rho} + Bxy + \frac{y^2}{2\rho'} + ax^3 + \beta x^2y + \gamma xy^2 + \delta y^3 + \dots \quad (8);$$

and, as we have just seen, the term in x^2 corresponds to a linear error in the spacing. In like manner, the term in y^2 corresponds to a general curvature of the lines (fig. 10), and does not influence the definition at the (primary) focus, although it may introduce astigmatism.² If we suppose that everything is symmetrical on the two sides of the primary plane $y=0$, the coefficients B, β, δ vanish. In spite of this inequality between ρ and ρ' , the definition will be good to this order of approximation, provided a and γ vanish. The former measures the thickness of the primary focal line, and the latter measures its curvature. The error of ruling giving rise to a is one in which the intervals increase or decrease in both directions from the centre outwards (fig. 11), and it may often be compensated by a slight rotation in azimuth of the object-glass of the observing telescope. The term in γ corresponds to a variation of curvature in crossing the grating (fig. 12).

When the plane xz is not a plane of symmetry, we have to consider the terms in $xy, x^2y,$ and y^3 . The first of these corresponds to a deviation from parallelism, causing the interval to alter gradually as we pass along the lines (fig. 13). The error thus arising may be compensated by a rotation of the object-glass about one of the diameters $y = \pm x$. The term in x^2y corresponds to a deviation from parallelism in the same direction on both sides of the central line (fig. 14); and that in y^3 would be caused by a curvature such that there is a point of inflection at the middle of each line (fig. 15).

All the errors, except that depending on a , and especially those depending on γ and δ , can be diminished, without loss of resolving power, by contracting the vertical aperture. A linear error in the spacing, and a general curvature of the lines, are eliminated in the ordinary use of a grating.

The explanation of the difference of focus upon the two sides as due to unequal spacing was verified by Cornu upon gratings purposely constructed with an increasing interval. He has also shown how to rule a plane surface with lines so disposed that the grating shall of itself give well-focused spectra.

A similar idea appears to have guided H. A. Rowland to his brilliant invention of concave gratings, by which spectra can be photographed without any further optical appliance. In these instruments the lines are ruled upon a spherical surface, a speculum metal, and mark the intersections of the surface by a system of parallel and equidistant planes, of which the middle member passes through the centre of the sphere. If we consider for the present only the primary plane of symmetry, the figure is reduced to two dimensions. Let AP (fig. 16) represent the surface of the grating, O being the centre of the circle. Then, if Q be any radiant point and Q' its image (primary focus) in the spherical mirror AP, we have

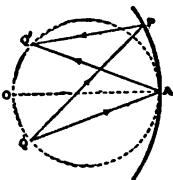

FIG. 16.

$$\frac{1}{\rho} + \frac{1}{\rho'} = \frac{2\cos\phi}{a},$$

where $\rho_1 = AQ', \rho_2 = AQ, \rho = OA, \phi =$ angle of incidence QAO, equal to the angle of reflection Q'AO. If Q be on the circle described upon OA as diameter, and so that $\rho = a \cos \phi$, then Q' lies also upon the same circle; and in this case it follows from the symmetry that the unsymmetrical aberration (depending upon a) vanishes. This disposition is adopted in Rowland's instrument; only, in addition to the central image (formed at the angle $\phi' = \phi$), there are a series of spectra with various values of ϕ' , but all disposed upon the same circle. Rowland's investigation is contained in the paper already referred to; but the following account of the theory is in the form adopted by R. T. Glazebrook (*Phil. Mag.*, 1883).

In order to find the difference of optical distances between the courses QAQ', QPQ', we have to express QP-QA, PQ'-AQ'. To find the former, we have, if OAQ = ϕ , AOP = ω ,

$$QP^2 = a^2 + a^2 \sin^2 \omega - 2a^2 \sin \omega \sin (\omega - \phi) = (a + a \sin \phi \sin \omega)^2 - a^2 \sin^2 \omega + a^2 \sin^2 \omega (\omega - \phi).$$

² In the same way we may conclude that in flat gratings any departure from a straight line has the effect of causing the dust in the slit and the spectrum to have different foci—a fact sometimes observed" (Rowland, "On Concave Gratings for Optical Purposes," *Phil. Mag.*, September 1883).

Now as far as ω'

$$4 \sin^2 \omega = \sin^2 \omega + 4 \sin^2 \omega',$$

and thus to the same order

$$QP^2 = (u + a \sin \phi \sin \omega)^2 - a \cos \phi (u - a \cos \phi) \sin^2 \omega + \frac{1}{2} a^2 (u - a \cos \phi) \sin^4 \omega.$$

But if we now suppose that Q lies on the circle $u = a \cos \phi$, the middle term vanishes, and we get, correct as far as ω' ,

$$QP = (u + a \sin \phi \sin \omega) \sqrt{1 + \frac{a^2 \sin^2 \phi \sin^2 \omega}{4u}};$$

so that

$$QP - u = a \sin \phi \sin \omega + \frac{1}{2} a \sin \phi \tan \phi \sin^3 \omega \dots (9),$$

in which it is to be noticed that the adjustment necessary to secure the disappearance of $\sin^3 \omega$ is sufficient also to destroy the term in $\sin^5 \omega$.

A similar expression can be found for $Q'P - Q'A$; and thus, if $Q'A = v$, $Q'AO = \phi'$, where $v = a \cos \phi'$, we get

$$QP + PQ' - QA - AQ' = a \sin \omega (\sin \phi \sin \omega' + \frac{1}{2} a \sin \omega' (\sin \phi \tan \phi + \sin \phi' \tan \phi')) \dots (10).$$

If $\phi' = \phi$, the term of the first order vanishes, and the reduction of the difference of path $\omega'P$ and $\omega'Q$ to a term of the fourth order proves not only that Q and Q' are conjugate foci, but also that the foci are exempt from the most important term in the aberration. In the present application ϕ' is not necessarily equal to ϕ ; but if P corresponded to a line upon the grating, the difference of retardations for consecutive positions of P, so far as expressed by the term of the first order, will be equal to $m\lambda$ (m integral), and therefore without influence, provided

$$e (\sin \phi - \sin \phi') = m\lambda \dots (11),$$

where e denotes the constant interval between the planes containing the lines. This is the ordinary formula for a reflecting plane grating, and it shows that the spectra are formed in the usual directions. They are here focused (so far as the rays in the primary plane are concerned) upon the circle $QQ'A$, and the outstanding aberration is of the fourth order.

In order that a large part of the field of view may be in focus at once, it is desirable that the locus of the focused spectrum should be nearly perpendicular to the line of vision. For this purpose Rowland places the eye-piece at O, so that $\phi = 0$, and then by (11) the value of ϕ' in the m^{th} spectrum is

$$e \sin \phi' = m\lambda \dots (12).$$

If ω now relate to the edge of the grating, on which there are altogether n lines,

$$n\omega = 2a \sin \omega,$$

and the value of the last term in (10) becomes

$$\frac{1}{2} n\omega \sin^3 \omega \sin^3 \phi \tan \phi',$$

or

$$\frac{1}{2} n m \lambda \sin^3 \omega \tan \phi' \dots (13).$$

This expresses the retardation of the extreme relatively to the central ray, and is to be reckoned positive, whatever may be the signs of ω , and ϕ' . If the semi-angular aperture (ω) be $\frac{1}{2}a$, and $\tan \phi' = 1$, $m\lambda$ might be as great as four millions before the error of phase would reach $\frac{1}{2}\lambda$. If it were desired to use an angular aperture so large that the aberration according to (13) would be injurious, Rowland points out that on his machine there would be no difficulty in applying a remedy by making e slightly variable towards the edges. Or, retaining e constant, we might attain compensation by so polishing the surface as to bring the circumference slightly forward in comparison with the position it would occupy upon a true sphere.

It may be remarked that these calculations apply to the rays in the primary plane only. The image is greatly affected with astigmatism; but this is of little consequence, if γ in (8) be small enough. Curvature of the primary focal line having a very injurious effect upon definition, it may be inferred from the excellent performance of these gratings that γ is in fact small. Its value does not appear to have been calculated. The other coefficients in (8) vanish in virtue of the symmetry.

The mechanical arrangements for maintaining the focus are of great simplicity. The grating at A and the eye-piece at O are rigidly attached to a bar AO, whose ends rest on carriages, moving on rails OQ, AQ at right angles to each other. A tie between the middle point of the rod OA and Q can be used if thought desirable.

The absence of chromatic aberration gives a great advantage in the comparison of overlapping spectra, which Rowland has turned to excellent account in his determinations of the relative wave-lengths of lines in the solar spectrum (*Phil. Mag.*, 1887).

For absolute determinations of wave-lengths plane gratings are used. It is found (Bell, *Phil. Mag.*, 1887) that the angular measurements present less difficulty than the comparison of the grating interval with the standard metre. There is also some uncertainty as to the actual temperature of the grating when in use. In order to minimize the heating action of the light, it might be submitted to a preliminary prismatic analysis before it reaches the slit of the spectrometer, after the manner of Helmholtz.

In spite of the many improvements introduced by Rowland and

of the care with which his observations were made, recent workers have come to the conclusion that errors of unexpected amount have crept into his measurements of wave-lengths, and there is even a disposition to discard the grating altogether for fundamental work in favour of the so-called "interference methods," as developed by A. A. Michelson, and by C. Fabry and J. B. Pérot. The grating would in any case retain its utility for the reference of new lines to standards otherwise fixed. For such standards a relative accuracy of at least one part in a million seems now to be attainable.

Since the time of Fraunhofer many skilled mechanicians have given their attention to the ruling of gratings. Those of Nobert were employed by A. J. Ångström in his celebrated researches upon wave-lengths. L. M. Rutherfurd introduced into common use the reflection grating, finding that speculum metal was less trying than glass to the diamond point, upon the permanence of which so much depends. In Rowland's dividing engine the screws were prepared by a special process devised by him, and the resulting gratings, plane and concave, have supplied the means for much of the best modern optical work. It would seem, however, that further improvements are not excluded.

There are various copying processes by which it is possible to reproduce an original ruling in more or less perfection. The earliest is that of Quincke, who coated a glass grating with a chemical silver deposit, subsequently thickened with copper in an electrolytic bath. The metallic plate thus produced formed, when stripped from its support, a reflection grating reproducing many of the characteristics of the original. It is best to commence the electrolytic thickening in a silver acetate bath. At the present time excellent reproductions of Rowland's speculum gratings are on the market (Thorpe, Ives, Wallace), prepared, after a suggestion of Sir David Brewster, by coating the original with a varnish, e.g. of celluloid. Much skill is required to secure that the film when stripped shall remain undeformed.

A much easier method, applicable to glass originals, is that of photographic reproduction by contact printing. In several papers dating from 1872, Lord Rayleigh (see *Collected Papers*, i. 157, 160, 199, 504; iv. 226) has shown that success may be attained by a variety of processes, including bichromated gelatin and the old bitumen process, and has investigated the effect of imperfect approximation during the exposure between the prepared plate and the original. For many purposes the copies, containing lines up to 10,000 to the inch, are not inferior. It is to be desired that transparent gratings should be obtained from first-class ruling machines. To save the diamond point it might be possible to use something softer than ordinary glass as the material of the plate.

9. Talbot's Bands.—These very remarkable bands are seen under certain conditions when a tolerably pure spectrum is regarded with the naked eye, or with a telescope, half the aperture being covered by a thin plate, e.g. of glass or mica. The view of the matter taken by the discoverer (*Phil. Mag.*, 1837, 10, p. 364) was that any ray which suffered in traversing the plate a retardation of an odd number of half wave-lengths would be extinguished, and that thus the spectrum would be seen interrupted by a number of dark bars. But this explanation cannot be accepted as it stands, being open to the same objection as Arago's theory of stellar scintillation.¹ It is as far as possible from being true that a body emitting homogeneous light would disappear on merely covering half the aperture of vision with a half-wave plate. Such a conclusion would be in the face of the principle of energy, which teaches plainly that the retardation in question leaves the aggregate brightness unaltered. The actual formation of

¹ On account of inequalities in the atmosphere giving a variable refraction, the light from a star would be irregularly distributed over a screen. The experiment is easily made on a laboratory scale, with a small source of light, the rays from which, in their course towards a rather distant screen, are disturbed by the neighbourhood of a heated body. At a moment when the eye, or object-glass of a telescope, occupies a dark position, the star vanishes. A fraction of a second later the aperture occupies a bright place, and the star reappears. According to this view the chromatic effects depend entirely upon atmospheric dispersion.

the bands comes about in a very curious way, as is shown by a circumstance first observed by Brewster. When the retarding plate is held on the side towards the red of the spectrum, *the bands are not seen*. Even in the contrary case, the thickness of the plate must not exceed a certain limit, dependent upon the purity of the spectrum. A satisfactory explanation of these bands was first given by Airy (*Phil. Trans.*, 1840, 225; 1841, 1), but we shall here follow the investigation of Sir G. G. Stokes (*Phil. Trans.*, 1848, 227), limiting ourselves, however, to the case where the retarded and unretarded beams are contiguous and of equal width.

The aperture of the unretarded beam may thus be taken to be limited by $x = -h$, $x = 0$, $y = -l$, $y = +l$; and that of the beam retarded by R to be given by $x = 0$, $x = h$, $y = -l$, $y = +l$. For the former (1) § 3 gives

$$-\frac{1}{\lambda f} \int_{-h}^0 \int_{-l}^l \sin k \left\{ at - f - \frac{x^2 + y^2}{2f} \right\} dx dy \\ = -\frac{2lh}{\lambda f} \int_{-l}^l \sin \frac{ky}{f} \cdot \frac{2f}{k} \sin \frac{kx}{2f} \cdot \sin k \left\{ at - f - \frac{y^2}{2f} \right\} dy \quad (1).$$

on integration and reduction.

For the retarded stream the only difference is that we must subtract R from at , and that the limits of x are 0 and $+h$. We thus get for the disturbance at ξ , η , due to this stream

$$-\frac{2lh}{\lambda f} \int_{-l}^l \sin \frac{ky}{f} \cdot \frac{2f}{k} \sin \frac{kx}{2f} \cdot \sin k \left\{ at - f - R + \frac{y^2}{2f} \right\} dy \quad (2).$$

If we put for shortness τ for the quantity under the last circular function in (1), the expressions (1), (2) may be put under the forms $u \sin \tau$, $v \sin (\tau - a)$ respectively; and, if I be the intensity, I will be measured by the sum of the squares of the coefficients of $\sin \tau$ and $\cos \tau$ in the expression

$$u \sin \tau + v \sin (\tau - a),$$

so that

$$I = u^2 + v^2 + 2uv \cos a,$$

which becomes on putting for u , v , and a their values, and putting

$$\left\{ \int_{-l}^l \sin \frac{ky}{f} \right\}^2 = Q \quad (3),$$

$$I = Q \cdot \frac{4f^2}{\lambda^2} \sin^2 \frac{\pi k}{\lambda f} \left\{ 2 + 2 \cos \left(\frac{2\pi R}{\lambda} - \frac{2\pi k h}{\lambda f} \right) \right\} \quad (4).$$

If the subject of examination be a luminous line parallel to η , we shall obtain what we require by integrating (4) with respect to η from $-\infty$ to $+\infty$. The constant multiplier is of no special interest so that we may take as applicable to the image of a line

$$I = \frac{2}{\lambda^2} \sin^2 \frac{\pi k}{\lambda f} \left\{ 1 + \cos \left(\frac{2\pi R}{\lambda} - \frac{2\pi k h}{\lambda f} \right) \right\} \quad (5).$$

If $R = \frac{1}{2}\lambda$, I vanishes at $\xi = 0$; but the whole illumination, represented by $\int_{-\infty}^{\infty} I d\xi$, is independent of the value of R . If $R = 0$, $I = \frac{2}{\lambda^2} \sin^2 \frac{2\pi k h}{\lambda f}$, in agreement with § 3, where s has the meaning here attached to $2h$.

The expression (5) gives the illumination at ξ due to that part of the complete image whose geometrical focus is at $\xi = 0$, the retardation for this component being R . Since we have now to integrate for the whole illumination at a particular point O due to all the components which have their foci in its neighbourhood, we may conveniently regard O as origin. ξ is then the co-ordinate relatively to O of any focal point O' for which the retardation is R ; and the required result is obtained by simply integrating (5) with respect to ξ from $-\infty$ to $+\infty$. To each value of ξ corresponds a different value of λ , and (in consequence of the dispersing power of the plate) of R . The variation of λ may, however, be neglected in the integration, except in $2\pi R/\lambda$, where a small variation of λ entails a comparatively large alteration of phase. If we write

$$\rho = 2\pi R/\lambda \quad (6),$$

we must regard ρ as a function of ξ , and we may take with sufficient approximation under any ordinary circumstances

$$\rho = \rho' + \omega \xi \quad (7),$$

where ρ' denotes the value of ρ at O , and ω is a constant, which is positive when the retarding plate is held at the side on which the blue of the spectrum is seen. The possibility of dark bands depends upon ω being positive. Only in this case can

$$\cos \left\{ \rho' + (\omega - 2\pi h/\lambda f) \xi \right\}$$

retain the constant value -1 throughout the integration, and then only when

$$\omega = 2\pi h/\lambda f \quad (8)$$

and

$$\cos \rho' = -1 \quad (9).$$

The first of these equations is the condition for the formation of

dark bands, and the second marks their situation, which is the same as that determined by the imperfect theory.

The integration can be effected without much difficulty. For the first term in (5) the evaluation is effected at once by a known formula. In the second term if we observe that

$$\cos \left\{ \rho' + (\omega - 2\pi h/\lambda f) \xi \right\} = \cos \left\{ \rho' - \xi \right\} \\ = \cos \rho' \cos \omega \xi + \sin \rho' \sin \omega \xi,$$

we see that the second part vanishes when integrated, and that the remaining integral is of the form

$$w = \int_{-\infty}^{\infty} \sin^2 h_1 \xi \cos \xi_1 \xi_2^2 d\xi,$$

where

$$h_1 = \rho h/\lambda f, \quad \xi_1 = \omega - 2\pi h/\lambda f \quad (10).$$

By differentiation with respect to ξ_1 it may be proved that

$$\begin{aligned} w = 0 & \quad \text{from } \xi_1 = -\infty \text{ to } \xi_1 = -2h_1, \\ w = \frac{1}{2} \pi (2h_1 + \xi_1) & \quad \text{from } \xi_1 = -2h_1 \text{ to } \xi_1 = 0, \\ w = \frac{1}{2} \pi (2h_1 - \xi_1) & \quad \text{from } \xi_1 = 0 \text{ to } \xi_1 = 2h_1, \\ w = 0 & \quad \text{from } \xi_1 = 2h_1 \text{ to } \xi_1 = \infty. \end{aligned}$$

The integrated intensity, I' , or

$$2\pi h_1 + 2 \cos \rho',$$

is thus

$$I' = 2\pi h_1 \quad (11),$$

when ξ_1 numerically exceeds $2h_1$; and, when ξ_1 lies between $-2h_1$,

$$I' = \pi [2h_1 + (2h_1 - \sqrt{\xi_1^2})] \quad (12).$$

It appears therefore that there are no bands at all unless ω lies between 0 and $+4h_1$, and that within these limits the best bands are formed at the middle of the range when $\omega = 2h_1$. The formation of bands thus requires that the retarding plate be held upon the side already specified, so that ω be positive; and that the thickness of the plate (to which ω is proportional) do not exceed a certain limit, which we may call 2λ . At the best thickness ω the bands are black, and not otherwise.

The linear width of the band (c) is the increment of ξ which alters ρ by 2π , so that

$$c = 2\pi/\omega \quad (13).$$

With the best thickness

$$\omega = 2\pi h/\lambda f \quad (14),$$

so that in this case

$$c = \lambda/f h \quad (15).$$

The bands are thus of the same width as those due to two infinitely narrow apertures coincident with the central lines of the retarded and unretarded streams, the subject of examination being itself a fine luminous line.

If it be desired to see a given number of bands in the whole or in any part of the spectrum, the thickness of the retarding plate is thereby determined, independently of all other considerations. But in order that the bands may be really visible, and still more in order that they may be black, another condition must be satisfied. It is necessary that the aperture of the pupil be accommodated to the angular extent of the spectrum, or reciprocally. Black bands will be too fine to be well seen unless the aperture ($2h$) of the pupil be somewhat contracted. One-twentieth to one-fiftieth of an inch is suitable. The aperture and the number of bands being both fixed, the condition of blackness determines the angular magnitude of a band and of the spectrum. The use of a grating is very convenient, for not only are there several spectra in view at the same time, but the dispersion can be varied continuously by sloping the grating. The slits may be cut out of tin-plate, and half covered by mica or "microscopic glass," held in position by a little cement.

If a telescope be employed there is a distinction to be observed, according as the half-covered aperture is between the eye and the ocular, or in front of the object-glass. In the former case the function of the telescope is simply to increase the dispersion, and the formation of the bands is of course independent of the particular manner in which the dispersion arises. If, however, the half-covered aperture be in front of the object-glass, the phenomenon is magnified as a whole, and the desirable relation between the (unmagnified) dispersion and the aperture is the same as without the telescope. There appears to be no further advantage in the use of a telescope than the increased facility of accommodation, and for this of course a very low power suffices.

The original investigation of Stokes, here briefly sketched, extends also to the case where the streams are of unequal width h_1 , h_2 , and are separated by an interval $2g$. In the case of unequal width the bands cannot be black; but if $h = h_1$, the finiteness of $2g$ does not preclude the formation of black bands.

The theory of Talbot's bands with a half-covered circular aperture has been considered by H. Struve (*St. Peters. Trans.*, 1883, 31, No. 1). The subject of "Talbot's bands" has been treated in a very instructive manner by A. Schuster (*Phil. Mag.*, 1904), whose point of view offers the great advantage of affording an instantaneous explanation of the peculiarity noticed by Brewster. A plane pulse, i.e. a disturbance limited to an infinitely thin slice of the medium, is supposed to fall upon a parallel grating, which again may

be regarded as formed of infinitely thin wires, or infinitely narrow lines traced upon glass. The secondary pulses diverged by the ruling fall upon an object-glass as usual, and on arrival at the focus constitute a procession equally spaced in time, the interval between consecutive members depending upon the obliquity. If a retarding plate be now inserted so as to operate upon the pulses which come from one side of the grating, while leaving the remainder unaffected, we have to consider what happens at the focal point chosen. A full discussion would call for the formal application of Fourier's theorem, but some conclusions of importance are almost obvious.

Previously to the introduction of the plate we have an effect corresponding to wave-lengths closely grouped around the principal wave-length, viz. $a \sin \phi$, where a is the grating interval and ϕ the obliquity, the closeness of the grouping increasing with the number of intervals. In addition to these wave-lengths there are other groups centred round the wave-lengths which are submultiples of the principal one—the overlapping spectra of the second and higher orders. Suppose now that the plate is introduced so as to cover half the aperture and that it retards those pulses which would otherwise arrive first. The consequences must depend upon the amount of the retardation. As this increases from zero, the two processions which correspond to the two halves of the aperture begin to overlap, and the overlapping gradually increases until there is almost complete superposition. The stage upon which we will fix our attention is that where the one procession bisects the intervals between the other, so that a new simple procession is constituted, containing the same number of members as before the insertion of the plate, but now spaced at intervals only half as great. It is evident that the effect at the focal point is the obliteration of the first and other spectra of odd order, so that as regards the spectrum of the first order we may consider that the two beams *interfere*. The formation of black bands is thus explained, and it requires that the plate be introduced upon one particular side, and that the amount of the retardation be adjusted to a particular value. If the retardation be too little, the overlapping of the processions is incomplete, so that besides the procession of half period there are residues of the original processions of full period. The same thing occurs if the retardation be too great. If it exceed the double of the value necessary for black bands, there is again no overlapping and consequently no interference. If the plate be introduced upon the other side, so as to retard the procession originally in arrear, there is no overlapping, whatever may be the amount of retardation. In this way the principal features of the phenomenon are accounted for, and Schuster has shown further how to extend the results to spectra having their origin in prisms instead of gratings.

10. *Diffraction when the Source of Light is not seen in Focus.*—The phenomena to be considered under this head are of less importance than those investigated by Fraunhofer, and will be treated in less detail; but in view of their historical interest and of the ease with which many of the experiments may be tried, some account of their theory cannot be omitted. One or two examples have already attracted our attention when considering Fresnel's zones, viz. the shadow of a circular disk and of a screen circularly perforated.

Fresnel commenced his researches with an examination of the fringes, external and internal, which accompany the shadow of a narrow opaque strip, such as a wire. As a source of light he used sunshine passing through a very small hole perforated in a metal plate, or condensed by a lens of short focus. In the absence of a heliostat the latter was the more convenient. Following, unknown to himself, in the footsteps of Young, he deduced the principle of interference from the circumstance that the darkness of the interior bands requires the co-operation of light from both sides of the obstacle. At first, too, he followed Young in the view that the exterior bands are the result of interference between the direct light and that reflected from the edge of the obstacle, but he soon discovered that the character of the edge—e.g. whether it was the cutting edge or the back of a razor—made no material difference, and was thus led to the conclusion that the explanation of these phenomena requires nothing more than the application of Huygens's principle to the unobstructed parts of the wave. In observing the bands he received them at first upon a screen of finely ground glass, upon which a magnifying lens was focused; but it soon appeared that the ground glass could be dispensed with, the diffraction pattern being viewed in the same way as the image formed by the object-glass of a telescope is viewed through the eye-piece. This simplification was attended by a great saving of light, allowing measures to be taken such as would otherwise have presented great difficulties.

In theoretical investigations these problems are usually treated as of two dimensions only, everything being referred to the plane

passing through the luminous point and perpendicular to the diffracting edges, supposed to be straight and parallel. In strictness this idea is appropriate only when the source is a luminous line, emitting cylindrical waves, such as might be obtained from a luminous point with the aid of a cylindrical lens. When, in order to apply Huygens's principle, the wave is supposed to be broken up, the phase is the same at every element of the surface of resolution which lies upon a line perpendicular to the plane of reference, and thus the effect of the whole line, or rather infinitesimal strip, is related in a constant manner to that of the element which lies in the plane of reference, and may be considered to be represented thereby. The same method of representation is applicable to spherical waves, issuing from a point, if the radius of curvature be large; for, although there is variation of phase along the length of the infinitesimal strip, the whole effect depends practically upon that of the central parts where the phase is sensibly constant.¹

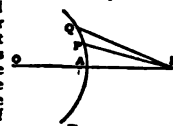

FIG. 17.

In fig. 17 APQ is the arc of the circle representative of the wave-front of resolution, the centre being at O, and the radius OA being equal to a . B is the point at which the effect is required, distant $a + b$ from O, so that $AB = b$, $AP = z$, $PQ = ds$.

Taking as the standard phase that of the secondary wave from A, we may represent the effect of PQ by

$$\cos 2\pi \left(\frac{z}{\lambda} - \frac{b}{\lambda} \right) ds,$$

where $z = BP - AP$ is the retardation at B of the wave from P relatively to that from A.

Now

$$0 = (a+b)^2 - z^2 - a^2 \dots \dots \dots (1),$$

so that, if we write

$$\frac{2\pi z}{\lambda} = \frac{\pi(a+b)^2}{a\lambda} - \frac{\pi a^2}{\lambda} \dots \dots \dots (2),$$

the effect at B is

$$\left\{ \frac{ab\lambda}{2(a+b)} \right\}^2 \int \cos \frac{2\pi z}{\lambda} \cos \frac{1}{2} \pi r^2 ds + \sin \frac{2\pi z}{\lambda} \int \sin \frac{1}{2} \pi r^2 ds \dots \dots \dots (3),$$

the limits of integration depending upon the disposition of the diffracting edges. When a, b, λ are regarded as constant, the first factor may be omitted,—as indeed should be done for consistency's sake, inasmuch as other factors of the same nature have been omitted already.

The intensity I , the quantity with which we are principally concerned, may thus be expressed

$$I = \left\{ \int \cos \frac{1}{2} \pi r^2 ds \right\}^2 + \left\{ \int \sin \frac{1}{2} \pi r^2 ds \right\}^2 \dots \dots (4).$$

These integrals, taken from $r=0$, are known as Fresnel's integrals; we will denote them by C and S, so that

$$C = \int_0^r \cos \frac{1}{2} \pi r^2 ds, \quad S = \int_0^r \sin \frac{1}{2} \pi r^2 ds \dots \dots (5).$$

When the upper limit is infinity, so that the limits correspond to the inclusion of half the primary wave, C and S are both equal to $\frac{1}{2}$, by a known formula; and on account of the rapid fluctuation of sign the parts of the range beyond very moderate values of r contribute but little to the result.

Ascending series for C and S were given by K. W. Knockenbauer, and are readily investigated. Integrating by parts, we find

$$C + iS = \int_0^r e^{i\pi r^2} ds = e^{i\pi r^2} \left\{ r - \frac{1}{2} i \int_0^r e^{-i\pi r^2} ds \right\};$$

and, by continuing this process,

$$C + iS = e^{i\pi r^2} \left\{ r - \frac{i\pi}{3} r^3 + \frac{i\pi}{3} \frac{i\pi}{5} r^5 - \frac{i\pi}{3} \frac{i\pi}{5} \frac{i\pi}{7} r^7 + \dots \right\}.$$

By separation of real and imaginary parts,

$$\begin{aligned} C &= M \cos \frac{1}{2} \pi r^2 + N \sin \frac{1}{2} \pi r^2 \\ S &= M \sin \frac{1}{2} \pi r^2 - N \cos \frac{1}{2} \pi r^2 \dots \dots \dots (6), \end{aligned}$$

where

$$M = \frac{r}{1} - \frac{\pi r^3}{3 \cdot 5} + \frac{\pi^2 r^5}{3 \cdot 5 \cdot 7} - \dots \dots \dots (7),$$

$$N = \frac{\pi r^2}{1 \cdot 3} - \frac{\pi^2 r^4}{1 \cdot 3 \cdot 5 \cdot 7} + \frac{\pi^3 r^6}{1 \cdot 3 \cdot 5 \cdot 7 \cdot 9 \cdot 11} - \dots \dots \dots (8).$$

These series are convergent for all values of r , but are practically useful only when r is small.

Expressions suitable for discussion when r is large were obtained

¹ In experiment a line of light is sometimes substituted for a point in order to increase the illumination. The various parts of the line are here *independent* sources, and should be treated accordingly. To assume a cylindrical form of primary wave would be justifiable only when there is synchronism among the secondary waves issuing from the various centres.

by L. P. Gilbert (*Mém. cour. de l'Acad. de Bruxelles*, 31, p. 1). Taking $\int r^2 = s$ (9),

we may write

$$C + iS = \frac{1}{\sqrt{2\pi}} \int_0^{\infty} \frac{e^{-x} dx}{\sqrt{x}}$$
 (10).

Again, by a known formula,

$$\frac{1}{\sqrt{x}} = \frac{1}{\sqrt{\pi}} \int_0^{\infty} \frac{e^{-x} dx}{\sqrt{x}}$$
 (11).

Substituting this in (10), and inverting the order of integration, we get

$$C + iS = \frac{1}{\sqrt{2}} \int_0^{\infty} \frac{dx}{\sqrt{x}} \int_0^{\infty} \frac{e^{-x} dx}{\sqrt{x}}$$
 (12).

Thus, if we take

$$G = \frac{1}{\sqrt{2}} \int_0^{\infty} \frac{e^{-x} dx}{1+x^2}, H = \frac{1}{\sqrt{2}} \int_0^{\infty} \frac{e^{-x} dx}{x(1+x^2)}$$
 (13),

$$C = \frac{1}{2} G \cos u + H \sin u, S = \frac{1}{2} G \sin u - H \cos u$$
 (14).

The constant parts in (14), viz. $\frac{1}{2}$, may be determined by direct integration of (12), or from the observation that by their constitution G and H vanish when $u=0$, coupled with the fact that C and S then assume the value $\frac{1}{2}$.

Comparing the expressions for C, S in terms of M, N, and in terms of G, H, we find that

$$G = \frac{1}{2}(\cos u + \sin u) - M, H = \frac{1}{2}(\cos u - \sin u) + N$$
 (15),

formulae which may be utilized for the calculation of G, H when u (or v) is small. For example, when $u=0, M=0, N=0$, and consequently $G=H=\frac{1}{2}$.

Descending series of the semi-convergent class, available for numerical calculation when u is moderately large, can be obtained from (12) by writing $x=xy$, and expanding the denominator in powers of y . The integration of the several terms may then be effected by the formula

$$\int_0^{\infty} e^{-y} y^{-1} dy = \Gamma(g+1) = (g-1)(g-2) \dots \frac{1}{\Gamma g}$$

and we get in terms of v

$$G = \frac{1}{\sqrt{2}} \left(\frac{1.3.5}{v^2} + \frac{1.3.5.7.9}{v^4} + \dots \right)$$
 (16).

$$H = \frac{1}{\sqrt{2}} \left(\frac{1.3}{v^2} + \frac{1.3.5.7}{v^4} + \dots \right)$$
 (17).

The corresponding values of C and S were originally derived by A. L. Cauchy, without the use of Gilbert's integrals, by direct integration by parts.

From the series for G and H just obtained it is easy to verify that

$$\frac{dH}{dv} = -vG, \frac{dG}{dv} = vH - \frac{1}{v}$$
 (18).

We now proceed to consider more particularly the distribution of light upon a screen PBQ near the shadow of a straight edge A. At a point P within the geometrical shadow of the obstacle, the half of the wave to the right of C (fig. 18), the nearest point on the wave-front, is wholly intercepted, and on the left the integration is to be taken from $s=CA$ to $s=\infty$. If V be the value of v corresponding to CA, viz.

$$V = \sqrt{\left\{ \frac{2(a+b)}{ab\lambda} \right\}} \cdot CA$$
 (19),

we may write

$$I^2 = \left(\int_0^{\infty} \cos \frac{1}{2} \pi^2 s^2 ds \right)^2 + \left(\int_0^{\infty} \sin \frac{1}{2} \pi^2 s^2 ds \right)^2$$
 (20),

or, according to our previous notation,

$$I^2 = \frac{1}{2}(C-C_0)^2 + \frac{1}{2}(S-S_0)^2 = G^2 + H^2$$
 (21).

Now in the integrals represented by G and H every element diminishes as V increases from zero. Hence, as CA increases, viz. as the point P is more and more deeply immersed in the shadow, the illumination continuously decreases, and that without limit. It has long been known from observation that there are no bands on the interior side of the shadow of the edge.

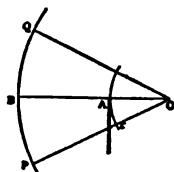

FIG. 18.

The law of diminution when V is moderately large is easily expressed with the aid of the series (16), (17) for G, H. We have ultimately $G=0, H=(vV)^{-1}$, so that

$$I^2 = \frac{1}{v^2 V^2}$$

or the illumination is inversely as the square of the distance from the shadow of the edge.

For a point Q outside the integration extends over

more than half the primary wave. The intensity may be expressed by

$$I^2 = \frac{1}{2}(C+C_0)^2 + \frac{1}{2}(S+S_0)^2$$
 (22);

and the maxima and minima occur when

$$\frac{1}{2}(C+C_0) \frac{dC}{dV} + \frac{1}{2}(S+S_0) \frac{dS}{dV} = 0,$$

whence

$$\sin \frac{1}{2} \pi V^2 + \cos \frac{1}{2} \pi V^2 = G$$
 (23).

When $V=0$, viz. at the edge of the shadow, $I^2 = \frac{1}{2}$; when $V=\infty$, $I^2=2$, on the scale adopted. The latter is the intensity due to the uninterrupted wave. The quadrupling of the intensity in passing outwards from the edge of the shadow is, however, accompanied by fluctuations giving rise to bright and dark bands. The position of these bands determined by (23) may be very simply expressed when V is large, for then sensibly $G=0$, and

$$\frac{1}{2} \pi V^2 = \frac{1}{2} \pi + n\pi$$
 (24).

n being an integer. In terms of δ , we have from (2)

$$\delta = \left(\frac{1}{2} + \frac{1}{2} n \right) \lambda$$
 (25).

The first maximum in fact occurs when $\delta = \frac{1}{2} \lambda - 0.066\lambda$, and the first minimum when $\delta = \frac{1}{2} \lambda - 0.016\lambda$, the corrections being readily obtainable from a table of G by substitution of the approximate value of V .

The position of Q corresponding to a given value of V , that is, to a band of given order, is by (19)

$$BQ = \frac{a+b}{2} AD = V \sqrt{\left\{ \frac{b\lambda(a+b)}{2a} \right\}}$$
 (26).

By means of this expression we may trace the locus of a band of given order as b varies. With sufficient approximation we may regard BQ and b as rectangular co-ordinates of Q. Denoting them by x, y , so that AB is axis of y and a perpendicular through A the axis of x , and rationalizing (26), we have

$$2ax^2 - \sqrt{\lambda} ay^2 - V^2 ab y = 0,$$

which represents a hyperbola with vertices at O and A.

From (24), (26) we see that the width of the bands is of the order $\sqrt{b\lambda(a+b)}/a$. From this we may infer the limitation upon the width of the source of light, in order that the bands may be properly formed. If ω be the apparent magnitude of the source seen from A, ωb should be much smaller than the above quantity, or

$$\omega < \sqrt{\lambda(a+b)/ab}$$
 (27).

If a be very great in relation to b , the condition becomes

$$\omega < \sqrt{\lambda/b}$$
 (28).

so that if b is to be moderately great (1 metre), the apparent magnitude of the sun must be greatly reduced before it can be used as a source. The values of V for the maxima and minima of intensity, and the magnitudes of the latter, were calculated by Fresnel. An extract from his results is given in the accompanying table.

	V	I ²
First maximum	1.2172	2.7413
First minimum	1.8726	1.5570
Second maximum	2.3449	2.3990
Second minimum	2.7392	1.6867
Third maximum	3.0820	2.3022
Third minimum	3.3913	1.7440

A very thorough investigation of this and other related questions, accompanied by fully worked-out tables of the functions concerned, will be found in a paper by E. Lommel (*Abh. Bayer. Akad. d. Wiss.* II. Cl., 15, Bd., iii. Abth., 1886).

When the functions C and S have once been calculated, the discussion of various diffraction problems is much facilitated by the idea, due to M. A. Cornu (*Journ. de Phys.*, 1874, 3, p. 1; a similar suggestion was made independently by G. F. Fitzgerald), of exhibiting as a curve the relationship between C and S, considered as the rectangular co-ordinates (x, y) of a point. Such a curve is shown in fig. 19, where, according to the definition (5) of C, S,

$$x = \int_0^{\infty} \cos \frac{1}{2} \pi^2 s^2 ds, y = \int_0^{\infty} \sin \frac{1}{2} \pi^2 s^2 ds$$
 (29).

The origin of co-ordinates O corresponds to $v=0$; and the asymptotic points J, J', round which the curve revolves in an ever-closing spiral, correspond to $v=\infty$.

The intrinsic equation, expressing the relation between the arc σ (measured from O) and the inclination ϕ of the tangent at any points to the axis of x , assumes a very simple form. For

$$dx = \cos \frac{1}{2} \pi^2 s^2 ds, dy = \sin \frac{1}{2} \pi^2 s^2 ds;$$

so that

$$\sigma = \int \sqrt{(dx^2 + dy^2)} = \sigma$$
 (30),

$$\phi = \tan^{-1}(dy/dx) = \frac{1}{2} \pi^2 s^2$$
 (31).

Accordingly,

$$\phi = \frac{1}{2}\pi r^2 \quad (32);$$

and for the curvature,

$$d\phi/ds = \pi r \quad (33).$$

Cornu remarks that this equation suffices to determine the general character of the curve. For the osculating circle at any point includes the whole of the curve which lies beyond; and the successive convolutions envelop one another without intersection.

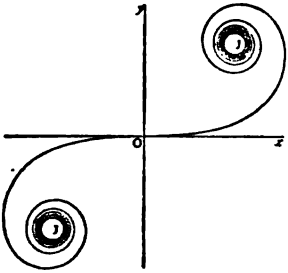

FIG. 19.

with the rule for compounding vector vibration at B, due to any finite part of the primary wave, is represented in amplitude and phase by the chord joining the extremities of the corresponding arc ($\sigma_1 - \sigma_2$).

In applying the curve in special cases of diffraction to exhibit the effect at any point P (fig. 18) the centre of the curve O is to be considered to correspond to that point C of the primary wave-front which lies nearest to P. The operative part, or parts, of the curve are of course those which represent the unobstructed portions of the primary wave.

Let us reconsider, following Cornu, the diffraction of a screen unlimited on one side, and on the other terminated by a straight edge. On the illuminated side, at a distance from the shadow, the vibration is represented by J' . The co-ordinates of J' , J' being $(\frac{1}{2}, \frac{1}{2})$, $(-\frac{1}{2}, -\frac{1}{2})$. It is π ; and the phase is $\frac{1}{2}$ period in arrears of that of the element at O. As the point under contemplation is supposed to approach the shadow, the vibration is represented by the chord drawn from J' to a point on the other half of the curve, which travels inwards from J' towards O. The amplitude is thus subject to fluctuations, which increase as the shadow is approached. At the point O the intensity is one-quarter of that of the entire wave, and after this point is passed, that is, when we have entered the geometrical shadow, the intensity falls off gradually to zero, without fluctuations. The whole progress of the phenomenon is thus exhibited to the eye in a very instructive manner.

We will next suppose that the light is transmitted by a slit, and inquire what is the effect of varying the width of the slit upon the illumination at the projection of its centre. Under these circumstances the arc to be considered is bisected at O, and its length is proportional to the width of the slit. It is easy to see that the length of the chord (which passes in all cases through O) increases to a maximum near the place where the phase-retardation is $\frac{1}{4}$ of a period, then diminishes to a minimum when the retardation is about $\frac{3}{4}$ of a period, and so on.

If the slit is of constant width and we require the illumination at various points on the screen behind it, we must regard the arc of the curve as of constant length. The intensity is then, as always, represented by the square of the length of the chord. If the slit be narrow, so that the arc is short, the intensity is constant over a wide range, and does not fall off to an important extent until the discrepancy of the extreme phases reaches about a quarter of a period.

We have hitherto supposed that the shadow of a diffracting obstacle is received upon a diffusing screen, or, which comes to nearly the same thing, is observed with an eye-piece. If the eye, provided if necessary with a perforated plate in order to reduce the aperture, be situated inside the shadow at a place where the illumination is still sensible, and be focused upon the diffracting edge, the light which it receives will appear to come from the neighbourhood of the edge, and will present the effect of a silver lining. This is doubtless the explanation of a "pretty optical phenomenon, seen in Switzerland, when the sun rises from behind distant trees standing on the summit of a mountain."¹

11. *Dynamical Theory of Diffraction.*—The explanation of diffraction phenomena given by Fresnel and his followers is

¹ H. Necker (*Phil. Mag.*, November 1832); Fox Talbot (*Phil. Mag.*, June 1833). "When the sun is about to emerge . . . every branch and leaf is lighted up with a silvery lustre of indescribable beauty. . . The birds, as Mr Necker very truly describes, appear like flying brilliant sparks." Talbot ascribes the appearance to diffraction; and he recommends the use of a telescope.

independent of special views as to the nature of the aether, at least in its main features; for in the absence of a more complete foundation it is impossible to treat rigorously the mode of action of a solid obstacle such as a screen. But, without entering upon matters of this kind, we may inquire in what manner a primary wave may be resolved into elementary secondary waves, and in particular as to the law of intensity and polarization in a secondary wave as dependent upon its direction of propagation, and upon the character as regards polarization of the primary wave. This question was treated by Stokes in his "Dynamical Theory of Diffraction" (*Camb. Phil. Trans.*, 1849) on the basis of the elastic solid theory.

Let x, y, z be the co-ordinates of any particle of the medium in its natural state, and ξ, η, ζ the displacements of the same particle at the end of time t , measured in the directions of the three axes respectively. Then the first of the equations of motion may be put under the form

$$\frac{d^2\xi}{dt^2} = \nu^2 \left(\frac{\partial^2\xi}{\partial x^2} + \frac{\partial^2\xi}{\partial y^2} + \frac{\partial^2\xi}{\partial z^2} \right) + (\sigma^2 - \nu^2) \frac{d}{dx} \left(\frac{d\xi}{dx} + \frac{d\eta}{dy} + \frac{d\zeta}{dz} \right),$$

where σ^2 and ν^2 denote the two arbitrary constants. Put for shortness

$$\frac{d\xi}{dx} + \frac{d\eta}{dy} + \frac{d\zeta}{dz} = \delta. \quad (1),$$

and represent by $\nabla^2\xi$ the quantity multiplied by ν^2 . According to this notation, the three equations of motion are

$$\left. \begin{aligned} \frac{d^2\xi}{dt^2} &= \nu^2 \nabla^2\xi + (\sigma^2 - \nu^2) \frac{d\delta}{dx} \\ \frac{d^2\eta}{dt^2} &= \nu^2 \nabla^2\eta + (\sigma^2 - \nu^2) \frac{d\delta}{dy} \\ \frac{d^2\zeta}{dt^2} &= \nu^2 \nabla^2\zeta + (\sigma^2 - \nu^2) \frac{d\delta}{dz} \end{aligned} \right\} \quad (2).$$

It is to be observed that δ denotes the dilatation of volume of the element situated at (x, y, z) . In the limiting case in which the medium is regarded as absolutely incompressible δ vanishes; but, in order that equations (2) may preserve their generality, we must suppose σ at the same time to become infinite, and replace $\sigma^2 \delta$ by a new function of the co-ordinates.

These equations simplify very much in their application to plane waves. If the ray be parallel to OX, and the direction of vibration parallel to OZ, we have $\xi=0, \eta=0$, while ζ is a function of x and t only. Equation (1) and the first pair of equations (2) are thus satisfied identically. The third equation gives

$$\frac{d^2\zeta}{dt^2} = \nu^2 \frac{d^2\zeta}{dx^2} \quad (3),$$

of which the solution is

$$\zeta = f(b-t-x) \quad (4),$$

where f is an arbitrary function.

The question as to the law of the secondary waves is thus answered by Stokes. "Let $\xi=0, \eta=0, \zeta=f(b-t-x)$ be the displacements corresponding to the incident light; let O_1 be any point in the plane P (of the wave-front), α an element of that plane adjacent to O_1 ; and consider the disturbance due to that portion only of the incident disturbance which passes continually across dS . Let O be any point in the medium situated at a distance from the point O_1 which is large in comparison with the length of a wave; let $O_1O=r$, and let this line make an angle θ with the direction of propagation of the incident light, or the axis of x , and ϕ with the direction of vibration, or axis of z . Then the displacement at O will take place in a direction perpendicular to O_1O , and lying in the plane ZO_1O ; and, if r' be the displacement at O , reckoned positive in the direction nearest to that in which the incident vibrations are reckoned positive,

$$r' = \frac{dS}{4\pi r^2} (1 + \cos\theta) \sin\phi f'(b-t-r).$$

In particular, if

$$f(b-t-x) = c \sin \frac{2\pi}{\lambda} (b-t-x) \quad (5),$$

we shall have

$$r' = \frac{cdS}{2\lambda r^2} (1 + \cos\theta) \sin\phi \cos \frac{2\pi}{\lambda} (b-t-r) \quad (6)."$$

It is then verified that, after integration with respect to dS , (6) gives the same disturbance as if the primary wave had been supposed to pass unbroken.

The occurrence of $\sin\phi$ as a factor in (6) shows that the relative intensities of the primary light and of that diffracted in the direction θ depend upon the condition of the former as regards polarization. If the direction of primary vibration be perpendicular to the plane of diffraction (containing both primary and secondary rays), $\sin\phi = 1$; but, if the primary vibration be in the plane of diffraction, $\sin\phi = \cos\theta$. This result was employed by Stokes as a criterion of the direction of vibration; and his experiments, conducted with gratings, led him to the conclusion that the vibrations

of polarized light are executed in a direction *perpendicular* to the plane of polarization.

The factor $(1 + \cos \theta)$ shows in what manner the secondary disturbance depends upon the direction in which it is propagated with respect to the front of the primary wave.

If, as suffices for all practical purposes, we limit the application of the formulæ to points in advance of the plane at which the wave is supposed to be broken up, we may use simpler methods of resolution than that above considered. It appears indeed that the purely mathematical question has no definite answer. In illustration of this the analogous problem for sound may be referred to. Imagine a flexible lamina to be introduced so as to coincide with the plane at which resolution is to be effected. The introduction of the lamina (supposed to be devoid of inertia) will make no difference to the propagation of plane parallel sonorous waves through the position which it occupies. At every point the motion of the lamina will be the same as would have occurred in its absence, the pressure of the waves impinging from behind being just what is required to generate the waves in front. Now it is evident that the aerial motion in front of the lamina is determined by what happens at the lamina without regard to the cause of the motion there existing. Whether the necessary forces are due to aerial pressures acting on the rear, or to forces directly impressed from without, is a matter of indifference. The conception of the lamina leads immediately to two schemes, according to which a primary wave may be supposed to be broken up. In the first of these the element dS , the effect of which is to be estimated, is supposed to execute its actual motion, while every other element of the plane lamina is maintained at rest. The resulting aerial motion in front is readily calculated (see Rayleigh, *Theory of Sound*, § 278); it is symmetrical with respect to the origin, i.e. independent of θ ; when the secondary disturbance thus obtained is integrated with respect to dS over the entire plane of the lamina, the result is necessarily the same as would have been obtained had the primary wave been supposed to pass on without resolution, for this is precisely the motion generated when every element of the lamina vibrates with a common motion, equal to that attributed to dS . The only assumption here involved is the evidently legitimate one that, when two systems of variously distributed motion at the lamina are superposed, the corresponding motions in front are superposed also.

The method of resolution just described is the simplest, but it is only one of an indefinite number that might be proposed, and which are all equally legitimate, so long as the question is regarded as a merely mathematical one, without reference to the physical properties of actual screens. If, instead of supposing the motion at dS to be that of the primary wave, and to be zero elsewhere, we suppose the force operative over the element dS of the lamina to be that corresponding to the primary wave, and to vanish elsewhere, we obtain a secondary wave following quite a different law. In this case the motion in different directions varies as $\cos \theta$, vanishing at right angles to the direction of propagation of the primary wave. Here again, on integration over the entire lamina, the aggregate effect of the secondary waves is necessarily the same as that of the primary.

In order to apply these ideas to the investigation of the secondary wave of light, we require the solution of a problem, first treated by Stokes, viz. the determination of the motion in an infinitely extended elastic solid due to a locally applied periodic force. If we suppose that the force impressed upon the element of mass $D dx dy dz$

$$DZ dx dy dz,$$

being everywhere parallel to the axis of Z , the only change required in our equations (1), (2) is the addition of the term Z to the second member of the third equation (2). In the forced vibration, now under consideration, Z , and the quantities ξ, η, ζ , δ expressing the resulting motion, are to be supposed proportional to $e^{i\omega t}$, where $t = \sqrt{-1}$, and $\omega = 2\pi/\tau$, τ being the periodic time. Under these circumstances the double differentiation with respect to t of any quantity is equivalent to multiplication by the factor $-\omega^2$, and thus our equations take the form

$$\left. \begin{aligned} (\beta^2 \nabla^2 + \omega^2) \xi + (\alpha^2 - \beta^2) \frac{\partial \delta}{\partial x} &= 0 \\ (\beta^2 \nabla^2 + \omega^2) \eta + (\alpha^2 - \beta^2) \frac{\partial \delta}{\partial y} &= 0 \\ (\beta^2 \nabla^2 + \omega^2) \zeta + (\alpha^2 - \beta^2) \frac{\partial \delta}{\partial z} &= -Z \end{aligned} \right\} \dots (7).$$

It will now be convenient to introduce the quantities $\omega_1, \omega_2, \omega_3$, which express the rotations of the elements of the medium round axes parallel to those of co-ordinates, in accordance with the equations

$$\omega_1 = \frac{d\xi}{dy} - \frac{d\eta}{dx}, \quad \omega_2 = \frac{d\eta}{dz} - \frac{d\zeta}{dy}, \quad \omega_3 = \frac{d\zeta}{dx} - \frac{d\xi}{dz} \dots (8).$$

In terms of these we obtain from (7), by differentiation and subtraction,

$$\left. \begin{aligned} (\beta^2 \nabla^2 + \omega^2) \omega_1 &= 0 \\ (\beta^2 \nabla^2 + \omega^2) \omega_2 &= dZ/dy \\ (\beta^2 \nabla^2 + \omega^2) \omega_3 &= -dZ/dx \end{aligned} \right\} \dots (9).$$

The first of equations (9) gives

$$\omega_1 = 0 \dots (10).$$

For ω_2 we have

$$\omega_2 = -\frac{1}{4\pi\beta} \iiint \frac{dZ}{dy} \frac{e^{i\omega t}}{r} dx dy dz \dots (11),$$

where r is the distance between the element $dx dy dz$ and the point where ω_2 is estimated, and

$$k = \pi/\lambda = 2\pi/\lambda \dots (12),$$

λ being the wave-length.

(This solution may be verified in the same manner as Poisson's theorem, in which $k=0$.)

We will now introduce the supposition that the force Z acts only within a small space of volume T , situated at (x, y, z) , and for simplicity suppose that it is at the origin of co-ordinates that the rotations are to be estimated. Integrating by parts in (11), we get

$$\iiint \frac{e^{i\omega t}}{r} \frac{dZ}{dy} dy = \left[Z \frac{e^{i\omega t}}{r} \right] - \int Z \frac{d}{dy} \left(\frac{e^{i\omega t}}{r} \right) dy,$$

in which the integrated terms at the limits vanish, Z being finite only within the region T . Thus

$$\omega_2 = \frac{1}{4\pi\beta} \iiint T \frac{d}{dy} \left(\frac{e^{i\omega t}}{r} \right) dx dy dz.$$

Since the dimensions of T are supposed to be very small in comparison with λ , the factor $\frac{d}{dy} \left(\frac{e^{i\omega t}}{r} \right)$ is sensibly constant; so that, if Z stand for the mean value of Z over the volume T , we may write

$$\omega_2 = \frac{TZ}{4\pi\beta} \cdot \frac{2}{r} \cdot \frac{d}{dr} \left(\frac{e^{i\omega t}}{r} \right) \dots (13).$$

In like manner we find

$$\omega_3 = -\frac{TZ}{4\pi\beta} \cdot \frac{2}{r} \cdot \frac{d}{dr} \left(\frac{e^{i\omega t}}{r} \right) \dots (14).$$

From (10), (13), (14) we see that, as might have been expected, the rotation at any point is about an axis perpendicular both to the direction of the force and to the line joining the point to the source of disturbance. If the resultant rotation be ω , we have

$$\omega = \frac{TZ}{4\pi\beta} \cdot \frac{\sqrt{(\alpha^2 + \beta^2)}}{r} \cdot \frac{d}{dr} \left(\frac{e^{i\omega t}}{r} \right) = \frac{TZ \sin \phi}{4\pi\beta^2} \frac{d}{dr} \left(\frac{e^{i\omega t}}{r} \right),$$

ϕ denoting the angle between r and α . In differentiating $e^{i\omega t}/r$ with respect to r , we may neglect the term divided by r^2 as altogether insensible, kr being an exceedingly great quantity at any moderate distance from the origin of disturbance. Thus

$$\omega = -\frac{ik}{4\pi\beta^2} \frac{TZ \sin \phi}{r} \cdot \frac{e^{i\omega t}}{r} \dots (15),$$

which completely determines the rotation at any point. For a disturbing force of given integral magnitude it is seen to be everywhere about an axis perpendicular to r and the direction of the force, and in magnitude dependent only upon the angle (ϕ) between these two directions and upon the distance (r).

The intensity of light is, however, more usually expressed in terms of the actual displacement in the plane of the wave. This displacement, which we may denote by ζ ; is in the plane containing α and r , and perpendicular to the latter. Its connexion with ω is expressed by $\omega = d\zeta/dr$; so that

$$\zeta = \frac{TZ \sin \phi}{4\pi\beta^2} \cdot \frac{e^{i(\omega t - kr)}}{r} \dots (16),$$

where the factor $e^{i\omega t}$ is restored.

Retaining only the real part of (16), we find, as the result of a local application of force equal to

$$DTZ \cos \omega t \dots (17),$$

the disturbance expressed by

$$\zeta = \frac{TZ \sin \phi}{4\pi\beta^2} \cdot \frac{\cos(\omega t - kr)}{r} \dots (18).$$

The occurrence of $\sin \phi$ shows that there is no disturbance radiated in the direction of the force, a feature which might have been anticipated from considerations of symmetry.

We will now apply (18) to the investigation of a law of secondary disturbance, when a primary wave

$$\zeta = \sin(\omega t - kr) \dots (19)$$

is supposed to be broken up in passing the plane $x=0$. The first step is to calculate the force which represents the reaction between the parts of the medium separated by $x=0$. The force operative upon the positive half is parallel to OZ , and of amount per unit of area equal to

$$-\beta^2 D d\zeta/dx = \beta^2 k D \cos \omega t;$$

and to this force acting over the whole of the plane the actual motion on the positive side may be conceived to be due. The

secondary disturbance corresponding to the element dS of the plane may be supposed to be that caused by a force of the above magnitude acting over dS and vanishing elsewhere; and it only remains to examine what the result of such a force would be.

Now it is evident that the force in question, supposed to act upon the positive half only of the medium, produces just double of the effect that would be caused by the same force if the medium were undivided, and on the latter supposition (being also localized at a point) it comes under the head already considered. According to (18), the effect of the force acting at dS parallel to OZ , and of amount equal to

$$2\rho^2 h D \, dS \cos \theta,$$

will be a disturbance

$$f' = \frac{dS \sin \phi}{\lambda v} \cos (nt - hr) \dots \dots (20),$$

regard being had to (12). This therefore expresses the secondary disturbance at a distance r and in a direction making an angle ϕ with OZ (the direction of primary vibration) due to the element dS of the wave-front.

The proportionality of the secondary disturbance to $\sin \phi$ is common to the present law and to that given by Stokes, but here there is no dependence upon the angle θ between the primary and secondary rays. The occurrence of the factor $(\lambda v)^{-1}$, and the necessity of supposing the phase of the secondary wave accelerated by a quarter of an undulation, were first established by Archibald Smith, as the result of a comparison between the primary wave, supposed to pass on without resolution, and the integrated effect of all the secondary waves (§ 2). The occurrence of factors such as $\sin \phi$, or $\frac{1}{2}(1 + \cos \theta)$, in the expression of the secondary wave has no influence upon the result of the integration, the effects of all the elements for which the factors differ appreciably from unity being destroyed by mutual interference.

The choice between various methods of resolution, all mathematically admissible, would be guided by physical considerations respecting the mode of action of obstacles. Thus, to refer again to the acoustical analogue in which plane waves are incident upon a perforated rigid screen, the circumstances of the case are best represented by the first method of resolution, leading to symmetrical secondary waves, in which the normal motion is supposed to be zero over the unperforated parts. Indeed, if the aperture is very small, this method gives the correct result, save as to a constant factor. In like manner our present law (20) would apply to the kind of obstruction that would be caused by an actual physical division of the elastic medium, extending over the whole of the area supposed to be occupied by the intercepting screen, but of course not extending to the parts supposed to be perforated.

On the electromagnetic theory, the problem of diffraction becomes definite when the properties of the obstacle are laid down. The simplest supposition is that the material composing the obstacle is perfectly conducting, i.e. perfectly reflecting. On this basis A. J. W. Sommerfeld (*Math. Ann.*, 1895, 47, p. 317), with great mathematical skill, has solved the problem of the shadow thrown by a semi-infinite plane screen. A simplified exposition has been given by Hecmi Lamb (*Proc. Lond. Math. Soc.*, 1906, 4, p. 190). It appears that Fresnel's results, although based on an imperfect theory, require only insignificant corrections. Problems not limited to two dimensions, such for example as the shadow of a circular disk, present great difficulties, and have not hitherto been treated by a rigorous method; but there is no reason to suppose that Fresnel's results would be departed from materially. (R.)

DIFFUSION (from the Lat. *diffundere*; *dis*-, asunder, and *fundere*, to pour out), in general, a spreading out, scattering or circulation; in physics the term is applied to a special phenomenon, treated below.

1. *General Description.*—When two different substances are placed in contact with each other they sometimes remain separate, but in many cases a gradual mixing takes place. In the case where both the substances are gases the process of mixing continues until the result is a uniform mixture. In other cases the proportions in which two different substances can mix lie between certain fixed limits, but the mixture is distinguished from a chemical compound by the fact that between these limits the composition of the mixture is capable of continuous variation, while in chemical compounds, the proportions of the different constituents can only have a discrete series of numerical values, each different ratio representing a different compound. If we take, for example, air and water in the presence of each other, air will become dissolved in the water, and water will evaporate into the air, and the proportions of either constituent absorbed by the other will vary continuously. But a limit will come when the air will absorb no more water, and the water will absorb no more air, and throughout the change a definite surface of separation will exist between the liquid and the gaseous parts. When no surface

of separation ever exists between two substances they must necessarily be capable of mixing in all proportions. If they are not capable of mixing in all proportions a discontinuous change must occur somewhere between the regions where the substances are still unmixed, thus giving rise to a surface of separation.

The phenomena of mixing thus involves the following processes:—(1) A motion of the substances relative to one another throughout a definite region of space in which mixing is taking place. This relative motion is called "diffusion." (2) The passage of portions of the mixing substances across the surface of separation when such a surface exists. These surface actions are described under various terms such as solution, evaporation, condensation and so forth. For example, when a soluble salt is placed in a liquid, the process which occurs at the surface of the salt is called "solution," but the salt which enters the liquid by solution is transported from the surface into the interior of the liquid by "diffusion."

Diffusion may take place in solids, that is, in regions occupied by matter which continues to exhibit the properties of the solid state. Thus if two liquids which can mix are separated by a membrane or partition, the mixing may take place through the membrane. If a solution of salt is separated from pure water by a sheet of parchment, part of the salt will pass through the parchment into the water. If water and glycerin are separated in this way most of the water will pass into the glycerin and a little glycerin will pass through in the opposite direction, a property frequently used by microscopists for the purpose of gradually transferring minute algae from water into glycerin. A still more interesting series of examples is afforded by the passage of gases through partitions of metal, notably the passage of hydrogen through platinum and palladium at high temperatures. When the process is considered with reference to a membrane or partition taken as a whole, the passage of a substance from one side to the other is commonly known as "osmosis" or "transpiration" (see SOLUTION), but what occurs in the material of the membrane itself is correctly described as diffusion.

Simple cases of diffusion are easily observed qualitatively. If a solution of a coloured salt is carefully introduced by a funnel into the bottom of a jar containing water, the two portions will at first be fairly well defined, but if the mixture can exist in all proportions, the surface of separation will gradually disappear; and the rise of the colour into the upper part and its gradual weakening in the lower part, may be watched for days, weeks or even longer intervals. The diffusion of a strong aniline colouring matter into the interior of gelatine is easily observed, and is commonly seen in copying apparatus. Diffusion of gases may be shown to exist by taking glass jars containing vapours of hydrochloric acid and ammonia, and placing them in communication with the heavier gas downmost. The precipitation of ammonium chloride shows that diffusion exists, though the chemical action prevents this example from forming a typical case of diffusion. Again, when a film of Canada balsam is enclosed between glass plates, the disappearance during a few weeks of small air bubbles enclosed in the balsam can be watched under the microscope.

In fluid media, whether liquids or gases, the process of mixing is greatly accelerated by stirring or agitating the fluids, and liquids which might take years to mix if left to themselves can thus be mixed in a few seconds. It is necessary to carefully distinguish the effects of agitation from those of diffusion proper. By shaking up two liquids which do not mix we split them up into a large number of different portions, and so greatly increase the area of the surface of separation, besides decreasing the thicknesses of the various portions. But even when we produce the appearance of a uniform turbid mixture, the small portions remain quite distinct. If however the fluids can really mix, the final process must in every case depend on diffusion, and all we do by shaking is to increase the sectional area, and decrease the thickness of the diffusing portions, thus rendering the completion of the operation more rapid. If a gas is shaken up in a liquid the process of absorption of the bubbles is also accelerated by capillary action, as occurs in an ordinary sparklet bottle. To state the matter precisely, however finely two fluids have been

subdivided by agitation, the molecular constitution of the different portions remains unchanged. The ultimate process by which the individual molecules of two different substances become mixed, producing finally a homogeneous mixture, is in every case diffusion. In other words, diffusion is that relative motion of the molecules of two different substances by which the proportions of the molecules in any region containing a finite number of molecules are changed.

In order, therefore, to make accurate observations of diffusion in fluids it is necessary to guard against any cause which may set up currents; and in some cases this is exceedingly difficult. Thus, if gas is absorbed at the upper surface of a liquid, and if the gaseous solution is heavier than the pure liquid, currents may be set up, and a steady state of diffusion may cease to exist. This has been tested experimentally by C. G. von Hüfner and W. E. Adney. The same thing may happen when a gas is evolved into a liquid at the surface of a solid even if no bubbles are formed; thus if pieces of aluminium are placed in caustic soda, the currents set up by the evolution of hydrogen are sufficient to set the aluminium pieces in motion, and it is probable that the motions of the Diatomaceae are similarly caused by the evolution of oxygen. In some pairs of substances diffusion may take place more rapidly than in others. Of course the progress of events in any experiment necessarily depends on various causes, such as the size of the containing vessels, but it is easy to see that when experiments with different substances are carried out under similar conditions, however these "similar conditions" be defined, the rates of diffusion must be capable of numerical comparison, and the results must be expressible in terms of at least one physical quantity, which for any two substances can be called their coefficient of diffusion. How to select this quantity we shall see later.

2. *Quantitative Methods of observing Diffusion.*—The simplest plan of determining the progress of diffusion between two liquids would be to draw off and examine portions from different strata at some stage in the process; the disturbance produced would, however, interfere with the subsequent process of diffusion, and the observations could not be continued. By placing in the liquid column hollow glass beads of different average densities, and observing at what height they remain suspended, it is possible to trace the variations of density of the liquid column at different depths, and different times. In this method, which was originally introduced by Lord Kelvin, difficulties were caused by the adherence of small air bubbles to the beads.

In general, optical methods are the most capable of giving exact results, and the following may be distinguished. (a) *By refraction in a horizontal plane.* If the containing vessel is in the form of a prism, the deviation of a horizontal ray of light in passing through the prism determines the index of refraction, and consequently the density of the stratum through which the ray passes. (b) *By refraction in a vertical plane.* Owing to the density varying with the depth, a horizontal ray entering the liquid also undergoes a small vertical deviation, being bent downwards towards the layers of greater density. The observation of this vertical deviation determines not the actual density, but its rate of variation with the depth, i.e. the "density gradient" at any point. (c) *By the saccharimeter.* In the cases of solutions of sugar, which cause rotation of the plane of polarized light, the density of the sugar at any depth may be determined by observing the corresponding angle of rotation, this was done originally by W. Voigt.

3. *Elementary Definitions of Coefficient of Diffusion.*—The simplest case of diffusion is that of a substance, say a gas, diffusing in the interior of a homogeneous solid medium, which remains at rest, when no external forces act on the system. We may regard it as the result of experience that: (1) if the density of the diffusing substance is everywhere the same no diffusion takes place, and (2) if the density of the diffusing substance is different at different points, diffusion will take place from places of greater to those of lesser density, and will not cease until the density is everywhere the same. It follows that the rate of flow of the diffusing substance at any point in any direction must depend on the density gradient at that point in that direction, i.e. on the rate at which the density of the diffusing substance decreases as we move in that direction. We may define the *coefficient of diffusion* as the ratio of the total mass per unit area which flows across any small section, to the rate of decrease of the density per unit distance in a direction perpendicular to that section.

In the case of steady diffusion parallel to the axis of x , if ρ be the density of the diffusing substance, and q the mass which flows across a unit of area in a plane perpendicular to the axis of x , then the density gradient is $-d\rho/dx$ and the ratio of q to this is called the "coefficient of diffusion." By what has been said this ratio remains finite, however small the actual gradient and flow may be; and it is natural to assume, at any rate as a first approximation, that it is constant as far as the quantities in question are concerned. Thus if the coefficient of diffusion be denoted by K we have $q = -K(d\rho/dx)$.

Further, the rate at which the quantity of substance is increasing in an element between the distances x and $x+dx$ is equal to the difference of the rates of flow in and out of the two faces, whence as in hydrodynamics, we have $d\rho/dt = -dq/dx$.

It follows that the equation of diffusion in this case assumes the form

$$\frac{d\rho}{dt} = -\frac{d}{dx}\left(K\frac{d\rho}{dx}\right)$$

which is identical with the equations representing conduction of heat, flow of electricity and other physical phenomena. For motion in three dimensions we have in like manner

$$\frac{d\rho}{dt} = -\frac{d}{dx}\left(K\frac{d\rho}{dx}\right) - \frac{d}{dy}\left(K\frac{d\rho}{dy}\right) - \frac{d}{dz}\left(K\frac{d\rho}{dz}\right)$$

and the corresponding equations in electricity and heat for anisotropic substances would be available to account for any parallel phenomena, which may arise, or might be conceived, to exist in connexion with diffusion through a crystalline solid.

In the case of a very dilute solution, the coefficient of diffusion of the dissolved substance can be defined in the same way as when the diffusion takes place in a solid, because the effects of diffusion will not have any perceptible influence on the solvent, and the latter may therefore be regarded as remaining practically at rest. But in most cases of diffusion between two fluids, both of the fluids are in motion, and hence there is far greater difficulty in determining the motion, and even in defining the coefficient of diffusion. It is important to notice in the first instance, that it is only the relative motion of the two substances which constitutes diffusion. Thus when a current of air is blowing, under ordinary circumstances the changes which take place are purely mechanical, and do not depend on the separate diffusions of the oxygen and nitrogen of which the air is mainly composed. It is only when two gases are flowing with unequal velocity, that is, when they have a relative motion, that these changes of relative distribution, which are called diffusion, take place. The best way out of the difficulty is to investigate the separate motions of the two fluids, taking account of the mechanical actions exerted on them, and supposing that the mutual action of the fluids causes either fluid to resist the relative motion of the other.

4. *The Coefficient of Resistance.*—Let us call the two diffusing fluids A and B. If B were absent, the motion of the fluid A would be determined entirely by the variations of pressure of the fluid A, and by the external forces, such as that due to gravity acting on A. Similarly if A were absent, the motion of B would be determined entirely by the variations of pressure due to the fluid B, and by the external forces acting on B. When both fluids are mixed together, each fluid tends to resist the relative motion of the other, and by the law of equality of action and reaction, the resistance which A experiences from B is everywhere equal and opposite to the resistance which B experiences from A. If the amount of this resistance per unit volume be divided by the relative velocity of the two fluids, and also by the product of their densities, the quotient is called the "coefficient of resistance." If then ρ_1, ρ_2 are the densities of the two fluids, u_1, u_2 their velocities, C the coefficient of resistance, then the portion of the fluid A contained in a small element of volume v will experience from the fluid B a resistance $C\rho_1\rho_2v(u_1 - u_2)$, and the fluid B contained in the same volume element will experience from the fluid A an equal and opposite resistance, $C\rho_1\rho_2v(u_2 - u_1)$.

This definition implies the following laws of resistance to diffusion, which must be regarded as based on experience, and not as self-evident truths: (1) each fluid tends to assume, so far as diffusion is concerned, the same equilibrium distribution that it would assume if its motion were unresisted by the presence of the other fluid. (Of course, the mutual attraction of gravitation of the two fluids might affect the final distribution, but this is practically negligible. Leaving such actions as this out of

account the following statement is correct.) In a state of equilibrium, the density of each fluid at any point thus depends only on the partial pressure of that fluid alone, and is the same as if the other fluids were absent. It does not depend on the partial pressures of the other fluids. If this were not the case, the resistance to diffusion would be analogous to friction, and would contain terms which were independent of the relative velocity $u_2 - u_1$. (2) For slow motions the resistance to diffusion is (approximately at any rate) proportional to the relative velocity. (3) The coefficient of resistance C is not necessarily always constant; it may, for example, and, in general, does, depend on the temperature.

If we form the equations of hydrodynamics for the different fluids occurring in any mixture, taking account of diffusion, but neglecting viscosity, and using suffixes 1, 2 to denote the separate fluids, these assume the form given by James Clerk Maxwell ("Diffusion," in *Ency. Brit.*, 9th ed.)—

$$D \frac{m_1}{Dt} + \frac{d p_1}{dx} - X_1 \rho_1 + C_{12} \rho_1 (u_1 - u_2) + \&c. = 0,$$

where

$$\frac{D m_1}{Dt} = \frac{d m_1}{dt} + u_1 \frac{d m_1}{dx} + v_1 \frac{d m_1}{dy} + w_1 \frac{d m_1}{dz},$$

and these equations imply that when diffusion and other motions cease, the fluids satisfy the separate conditions of equilibrium $\frac{d p_1}{dx} - X_1 \rho_1 = 0$. The assumption made in the following account is that terms such as $D m_1 / Dt$ may be neglected in the cases considered.

A further property based on experience is that the motions set up in a mixture by diffusion are very slow compared with those set up by mechanical actions, such as differences of pressure. Thus, if two gases at equal temperature and pressure be allowed to mix by diffusion, the heavier gas being below the lighter, the process will take a long time; on the other hand, if two gases, or parts of the same gas, at different pressures be connected, equalization of pressure will take place almost immediately. It follows from this property that the forces required to overcome the "inertia" of the fluids in the motions due to diffusion are quite imperceptible. At any stage of the process, therefore, any one of the diffusing fluids may be regarded as in equilibrium under the action of its own partial pressure, the external forces to which it is subjected and the resistance to diffusion of the other fluids.

5. *Slow Diffusion of two Gases. Relation between the Coefficients of Resistance and of Diffusion.*—We now suppose the diffusing substances to be two gases which obey Boyle's law, and that diffusion takes place in a closed cylinder or tube of unit sectional area at constant temperature, the surfaces of equal density being perpendicular to the axis of the cylinder, so that the direction of diffusion is along the length of the cylinder, and we suppose no external forces, such as gravity, to act on the system.

The densities of the gases are denoted by ρ_1, ρ_2 , their velocities of diffusion by u_1, u_2 , and if their partial pressures are p_1, p_2 , we have by Boyle's law $p_1 = h_1 \rho_1, p_2 = h_2 \rho_2$, where h_1, h_2 are constants for the two gases, the temperature being constant. The axis of the cylinder is taken as the axis of x .

From the considerations of the preceding section, the effects of inertia of the diffusing gases may be neglected, and at any instant of the process either of the gases is to be treated as kept in equilibrium by its partial pressure and the resistance to diffusion produced by the other gas. Calling this resistance per unit volume R, and putting $R = C \rho_1 \rho_2 (u_1 - u_2)$, where C is the coefficient of resistance, the equations of equilibrium give

$$\frac{d p_1}{dx} + C \rho_1 \rho_2 (u_1 - u_2) = 0, \text{ and } \frac{d p_2}{dx} + C \rho_1 \rho_2 (u_2 - u_1) = 0. \quad (1).$$

These involve

$$\frac{d p_1}{dx} + \frac{d p_2}{dx} = 0 \text{ or } p_1 + p_2 = P \dots \dots (2),$$

where P is the total pressure of the mixture, and is everywhere constant, consistently with the conditions of mechanical equilibrium.

Now $\frac{d p_1}{dx}$ is the pressure-gradient of the first gas, and is, by Boyle's law, equal to h_1 times the corresponding density-gradient. Again $\rho_1 u_1$ is the mass of gas flowing across any section per unit time, and $h_1 \rho_1 u_1$ or $p_1 u_1$ can be regarded as representing the flux of partial pressure produced by the motion of the gas. Since the total pressure is everywhere constant, and the ends of the cylinder are supposed fixed, the fluxes of partial pressure due to the two gases are equal and opposite, so that

$$p_1 u_1 + p_2 u_2 = 0 \text{ or } h_1 \rho_1 u_1 + h_2 \rho_2 u_2 = 0 \dots \dots (3).$$

From (2) (3) we find by elementary algebra

$$u_1 / p_2 = -u_2 / p_1 = (u_1 - u_2) / (p_1 + p_2) = (u_1 - u_2) / P,$$

and therefore

$$p_2 u_1 = -p_2 u_2 = p_1 p_2 (u_1 - u_2) / P = h_1 h_2 \rho_1 \rho_2 (u_1 - u_2) / P$$

Hence equations (1) (2) gives

$$\frac{d p_1}{dx} + \frac{C P}{h_1 h_2} (p_1 u_1) = 0, \text{ and } \frac{d p_2}{dx} + \frac{C P}{h_1 h_2} (p_2 u_2) = 0;$$

whence also substituting $p_1 = k_1 \rho_1, p_2 = k_2 \rho_2$, and by transposing

$$u_1 u_2 = -\frac{h_1 k_2}{C P} \frac{d p_1}{dx}, \text{ and } u_2 u_1 = -\frac{h_2 k_1}{C P} \frac{d p_2}{dx}.$$

We may now define the "coefficient of diffusion" of either gas as the ratio of the rate of flow of that gas to its density-gradient. With this definition, the coefficients of diffusion of both the gases in a mixture are equal, each being equal to $h_1 k_1 / C P$. The ratios of the fluxes of partial pressure to the corresponding pressure-gradients are also equal to the same coefficient. Calling this coefficient K, we also observe that the equations of continuity for the two gases are

$$\frac{d \rho_1}{dt} + \frac{d (\rho_1 u_1)}{dx} = 0, \text{ and } \frac{d \rho_2}{dt} + \frac{d (\rho_2 u_2)}{dx} = 0,$$

leading to the equations of diffusion

$$\frac{d \rho_1}{dt} = \frac{d}{dx} \left(K \frac{d \rho_1}{dx} \right), \text{ and } \frac{d \rho_2}{dt} = \frac{d}{dx} \left(K \frac{d \rho_2}{dx} \right),$$

exactly as in the case of diffusion through a solid.

If we attempt to treat diffusion in liquids by a similar method, it is, in the first place, necessary to define the "partial pressure" of the components occurring in a liquid mixture. This leads to the conception of "osmotic pressure," which is dealt with in the article SOLUTION. For dilute solutions at constant temperature, the assumption that the osmotic pressure is proportional to the density, leads to results agreeing fairly closely with experience, and this fact may be represented by the statement that a substance occurring in a dilute solution behaves like a perfect gas.

6. *Relation of the Coefficient of Diffusion to the Units of Length and Time.*—We may write the equation defining K in the form

$$u = -K \times \frac{1}{\rho} \frac{d \rho}{dx}.$$

Here $-d \rho / \rho dx$ represents the "percentage rate" at which the density decreases with the distance x ; and we thus see that the coefficient of diffusion represents the ratio of the velocity of flow to the percentage rate at which the density decreases with the distance measured in the direction of flow. This percentage rate being of the nature of a number divided by a length, and the velocity being of the nature of a length divided by a time, we may state that K is of two dimensions in length and -1 in time, i.e. dimensions L^2/T .

Example 1. Taking $K = 0.1423$ for carbon dioxide and air (at temperature $0^\circ C$. and pressure 76 cm. of mercury) referred to a centimetre and a second as units, we may interpret the result as follows.—Supposing in a mixture of carbon dioxide and air, the density of the carbon dioxide decreases by, say, 1, 2 or 3% of itself in a distance of 1 cm., then the corresponding velocities of the diffusing carbon dioxide will be respectively 0.01, 0.02 and 0.03 times 0.1423, that is, 0.001423, 0.002846 and 0.004269 cm. per second in the three cases.

Example 2. If we wished to take a foot and a second as our units, we should have to divide the value of the coefficient of diffusion in Example 1 by the square of the number of centimetres in 1 ft., that is, roughly speaking, by 900, giving the new value of $K = 0.00016$ roughly.

7. *Numerical Values of the Coefficient of Diffusion.*—The table on p. 258 gives the values of the coefficient of diffusion of several of the principal pairs of gases at a pressure of 76 cm. of mercury, and also of a number of other substances. In the gases the centimetre and second are taken as fundamental units, in other cases the centimetre and day.

8. *Irreversible Changes accompanying Diffusion.*—The diffusion of two gases at constant pressure and temperature is a good example of an "irreversible process." The gases always tend to mix, never to separate. In order to separate the gases a change must be effected in the external conditions to which the mixture is subjected, either by liquefying one of the gases, or by separating them by diffusion through a membrane, or by bringing other outside influences to bear on them. In the case of liquids, electrolysis affords a means of separating the constituents of a mixture. Every such method involves some change taking place outside the mixture, and this change may be regarded as a "compensati-

transformation." We thus have an instance of the property that every irreversible change leaves an indelible imprint somewhere or other on the progress of events in the universe. That the process of diffusion obeys the laws of irreversible thermodynamics (if these laws are properly stated) is proved by the fact that the compensating transformations required to separate mixed gases do not essentially involve anything but transformation of energy. The process of allowing gases to mix by diffusion, and then separating them by a compensating transformation, thus constitutes an irreversible cycle, the outside effects of which

it thus affords a measure of the extent to which energy has run to waste during the change. Moreover, when a body is heated, the increase of entropy is the factor which determines how much of the energy imparted to the body is unavailable for conversion into work under given conditions. In all cases we have

$$\text{increase of unavailable energy} = \text{increase of entropy.} \\ \text{temperature of auxiliary medium}$$

When diffusion takes place between two gases inside a closed vessel at uniform pressure and temperature no energy in the form of heat or work is received from without, and hence the entropy gained by the gases from without is zero. But the irreversible processes inside the vessel may involve a gain of entropy, and this can only be estimated by examining by what means mixed

gases can be separated, and, in particular, under what conditions the process of mixing and separating the gases could (theoretically) be made reversible.

9. Evidence derived from Liquefaction of one or both of the Gases.—The gases in a mixture can often be separated by liquefying, or even solidifying, one or both of the components. In connexion with this property we have the important law according to which "The pressure of a vapour in equilibrium with its liquid depends only on the temperature and is independent of the pressures of any other gases or vapours which may be mixed with it." Thus if two closed vessels be taken containing some water and one be exhausted, the other containing air, and if the temperatures be equal, evaporation will go on until the pressure of the vapour in the exhausted vessel is equal to

its partial pressure in the other vessel, notwithstanding the fact that the total pressure in the latter vessel is greater by the pressure of the air.

To separate mixed gases by liquefaction, they must be compressed and cooled till one separates in the form of a liquid. If no changes are to take place outside the system, the separate components must be allowed to expand until the work of expansion is equal to the work of compression, and the heat given out in compression is reabsorbed in expansion. The process may be made as nearly reversible as we like by performing the operations so slowly that the substances are practically in a state of equilibrium at every stage. This is a consequence of an important axiom in thermodynamics according to which "any small change in the neighbourhood of a state of equilibrium is to a first approximation reversible."

Suppose now that at any stage of the compression the partial pressures of the two gases are p_1 and p_2 , and that the volume is changed from V to $V-dV$. The work of compression is $(p_1+p_2)dV$, and this work will be restored at the corresponding stage if each of the separated gases increases in volume from $V-dV$ to V . The ultimate state of the separated gases will thus be one in which each gas occupies the volume V originally occupied by the mixture.

We may now obtain an estimate of the amount of energy rendered unavailable by diffusion. We suppose two gases occupying volumes V_1 and V_2 at equal pressure p to mix by diffusion, so that the final volume is V_1+V_2 . Then if before mixing each gas had been allowed to expand till its volume was V_1+V_2 , work would have been done in the expansion, and the gases could still have been mixed by a reversal of the process above described. In the actual diffusion this work of expansion is lost, and represents energy rendered unavailable at the temperature at which diffusion takes place. When divided by that temperature the quotient gives the increase of entropy. Thus the irreversible processes, and, in particular, the entropy changes associated with diffusion of two gases at uniform pressure, are the same as would take place if each of the gases in turn were to expand by rushing into a vacuum, till it occupied the whole volume of the mixture. A more rigorous proof involves considerations of the thermodynamic potentials, following the methods of J. Willard Gibbs (see ENERGETICS).

Substances.	Temp.	K.	Author.
Carbon dioxide and air	0°C.	0.1423 cm ² /sec.	J. Loschmidt.
" " hydrogen	0°C.	0.5558 "	"
" " oxygen	0°C.	0.1409 "	"
" " carbon monoxide	0°C.	0.1406 "	"
" " marsh gas (methane)	0°C.	0.1586 "	"
" " nitrous oxide	0°C.	0.0983 "	"
Hydrogen and oxygen	0°C.	0.7214 "	"
" " carbon monoxide	0°C.	0.6228 "	"
" " sulphur dioxide	0°C.	0.4800 "	"
Oxygen and carbon monoxide	0°C.	0.1802 "	"
Water and ammonia	20°C.	1.250 "	G. Häfner.
" " common salt (density 1.0269)	5°C.	0.822 "	"
" " " "	14.33°C.	0.355 cm ² /hour.	J. Graham.
" " " "	"	1.020, 0.996, 0.972,	"
" " " "	"	0.932 cm ² /day.	F. Heimbrodt.
" " zinc sulphate (0.312 gm/cm ³)	"	0.1162 "	W. Seitz.
" " zinc sulphate (normal)	"	0.2355 "	"
" " zinc acetate (double normal)	"	0.1195 "	"
" " zinc formate (half normal)	"	0.4654 "	"
" " cadmium sulphate (double normal)	"	0.2456 "	"
" " glycerin (1n, 1/2n, 1/3n, 1.5n)	10-14°C.	0.356, 0.350, 0.342,	"
" " " "	"	0.315 cm ² /day.	F. Heimbrodt.
" " urea	14.83°C.	0.973, 0.946, 0.926,	"
" " " "	"	0.883 cm ² /day.	"
" " hydrochloric acid	14.30°C.	2.208, 2.331,	"
" " " "	"	2.480 cm ² /day.	"
Gelatin 20% and ammonia	17°C.	127.1 "	A. Hagenbach.
" " carbon dioxide	"	0.845 "	"
" " nitrous oxide	"	0.509 "	"
" " oxygen	"	0.230 "	"
" " hydrogen	"	0.0565 "	"

are that energy somewhere or other must be less capable of transformation than it was before the change. We express this fact by stating that an irreversible process essentially implies a loss of availability. To measure this loss we make use of the laws of thermodynamics, and in particular of Lord Kelvin's statement that "It is impossible by means of inanimate material agency to derive mechanical effect from any portion of matter by cooling it below the temperature of the coldest of the surrounding objects."

Let us now assume that we have any system such as the gases above considered, and that it is in the presence of an indefinitely extended medium which we shall call the "auxiliary medium." If heat be taken from any part of the system, only part of this heat can be converted into work by means of thermodynamic engines; and the rest will be given to the auxiliary medium, and will constitute unavailable energy or waste. To understand what this means, we may consider the case of a condensing steam engine. Only part of the energy liberated by the combustion of the coal is available for driving the engine, the rest takes the form of heat imparted to the condenser. The colder the condenser the more efficient is the engine, and the smaller is the quantity of waste.

The amount of unavailable energy associated with any given transformation is proportional to the absolute temperature of the auxiliary medium. When divided by that temperature the quotient is called the change of "entropy" associated with the given change (see THERMODYNAMICS). Thus if a body at temperature T receives a quantity of heat Q , and if T_0 is the temperature of the auxiliary medium, the quantity of work which could be obtained from Q by means of ideal thermodynamic engines would be $Q(T-T_0/T)$, and the balance, which is QT_0/T , would take the form of unavailable or waste energy given to the medium. The quotient of this, when divided by T_0 , is Q/T , and this represents the quantity of entropy associated with Q units of heat at temperature T .

Any irreversible change for which a compensating transformation of energy exists represents, therefore, an increase of unavailable energy, which is measurable in terms of entropy. The increase of entropy is independent of the temperature of the auxiliary medium.

Another way in which two or more mixed gases can be separated is by placing them in the presence of a liquid which can freely absorb one of the gases, but in which the other gas or gases are insoluble. Here again it is found by experience that when equilibrium exists at a given temperature between the dissolved and undissolved portions of the first gas, the partial pressure of that gas in the mixture depends on the temperature alone, and is independent of the partial pressures of the insoluble gases with which it is mixed, so that the conclusions are the same as before.

10. *Diffusion through a Membrane or Partition.* Theory of the semi-permeable Membrane.—It has been pointed out that diffusion of gases frequently takes place in the interior of solids; moreover, different gases behave differently with respect to the same solid at the same temperature. A membrane or partition formed of such a solid can therefore be used to effect a more or less complete separation of gases from a mixture. This method is employed commercially for extracting oxygen from the atmosphere, in particular for use in projection lanterns where a high degree of purity is not required. A similar method is often applied to liquids and solutions and is known as "dialysis."

In such cases as can be tested experimentally it has been found that a gas always tends to pass through a membrane from the side where its density, and therefore its partial pressure, is greater to the side where it is less; so that for equilibrium the partial pressures on the two sides must be equal. This result is unaffected by the presence of other gases on one or both sides of the membrane. For example, if different gases at the same pressure are separated by a partition through which one gas can pass more rapidly than the other, the diffusion will give rise to a difference of pressure on the two sides, which is capable of doing mechanical work in moving the partition. In evidence of this conclusion Max Planck quotes a test experiment made by him in the Physical Institute of the university of Munich in 1883, depending on the fact that platinum foil at white heat is permeable to hydrogen but impermeable to air, so that if a platinum tube filled with hydrogen be heated the hydrogen will diffuse out, leaving a vacuum.

The details of the experiment may be quoted here:—"A glass tube of about 5 mm. internal diameter, blown out to a bulb at the middle, was provided with a stop-cock at one end. To the other a platinum tube 10 cm. long was fastened, and closed at the end. The whole tube was exhausted by a mercury pump, filled with hydrogen at ordinary atmospheric pressure, and then closed. The closed end of the platinum portion was then heated in a horizontal position by a Bunsen burner. The connexion between the glass and platinum tubes, having been made by means of sealing-wax, had to be kept cool by a continuous current of water to prevent the softening of the wax. After four hours the tube was taken from the flame, cooled to the temperature of the room, and the stop-cock opened under mercury. The mercury rose rapidly, almost completely filling the tube, proving that the tube had been very nearly exhausted."

In order that diffusion through a membrane may be reversible so far as a particular gas is concerned, the process must take place so slowly that equilibrium is set up at every stage (see § 9 above).

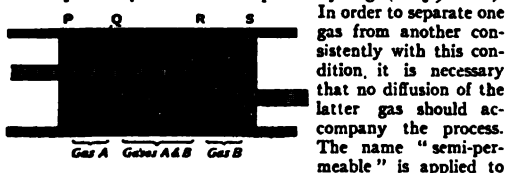

an ideal membrane or partition through which one gas can pass, and which offers an insuperable barrier to any diffusion whatever of a second gas. By means of two semi-permeable partitions acting oppositely with respect to two different gases A and B these gases could be mixed or separated by reversible methods. The annexed figure shows a diagrammatic representation of the process.

We suppose the gases contained in a cylindrical tube; P, Q, R, S are four pistons, of which P and R are joined to one connecting rod, Q and S to another. P, S are impermeable to both gases; Q is semi-permeable, allowing the gas A to pass through but not B, similarly R allows the gas B to pass through but not A. The distance PR is equal to the distance QS, so that if the rods are pushed towards each other as far as they will go, P and Q will be in contact, as also R and S. Imagine the space RQ filled with a mixture of the two gases

under these conditions. Then by slowly drawing the connecting rods apart until R, Q touch, the gas A will pass into the space PQ, and B will pass into the space RS, and the gases will finally be completely separated; similarly, by pushing the connecting rods together, the two gases will be remixed in the space RQ. By performing the operations slowly enough we may make the processes as nearly reversible as we please, so that no available energy is lost in either change. The gas A being at every instant in equilibrium on the two sides of the piston Q, its density, and therefore its partial pressure, is the same on both sides, and the same is true regarding the gas B on the two sides of R. Also no work is done in moving the pistons, for the partial pressures of B on the two sides of R balance each other, consequently, the resultant thrust on R is due to the gas A alone, and is equal and opposite to its resultant thrust on P, so that the connecting rods are at every instant in a state of mechanical equilibrium so far as the pressures of the gases A and B are concerned. We conclude that in the reversible separation of the gases by this method at constant temperature without the production or absorption of mechanical work, the densities and the partial pressures of the two separated gases are the same as they were in the mixture. These conclusions are in entire agreement with those of the preceding section. If this agreement did not exist it would be possible, theoretically, to obtain perpetual motion from the gases in a way that would be inconsistent with the second law of thermodynamics.

Most physicists admit, as Planck does, that it is impossible to obtain an ideal semi-permeable substance; indeed such a substance would necessarily have to possess an infinitely great resistance to diffusion for such gases as could not penetrate it. But in an experiment performed under actual conditions the losses of available energy arising from this cause would be attributable to the imperfect efficiency of the partitions and not to the gases themselves; moreover, these losses are, in every case, found to be completely in accordance with the laws of irreversible thermodynamics. The reasoning in this article being somewhat condensed the reader must necessarily be referred to treatises on thermodynamics for further information on points of detail connected with the argument. Even when he consults these treatises he may find some points omitted which have been examined in full detail at some time or other, but are not sufficiently often raised to require mention in print.

11. *Kinetic Models of Diffusion.*—Imagine in the first instance that a very large number of red balls are distributed over one half of a billiard table, and an equal number of white balls over the other half. If the balls are set in motion with different velocities in various directions, diffusion will take place, the red balls finding their way among the white ones, and vice versa; and the process will be retarded by collisions between the balls. The simplest model of a perfect gas studied in the kinetic theory of gases (see MOLECULE) differs from the above illustration in that the bodies representing the molecules move in space instead of in a plane, and, unlike billiard balls, their motion is unresisted, and they are perfectly elastic, so that no kinetic energy is lost either during their free motions, or at a collision.

The mathematical analysis connected with the application of the kinetic theory to diffusion is very long and cumbersome. We shall therefore confine our attention to regarding a medium formed of elastic spheres as a mechanical model, by which the most important features of diffusion can be illustrated. We shall assume the results of the kinetic theory, according to which—(1) In a dynamical model of a perfect gas the mean kinetic energy of translation of the molecules represents the absolute temperature of the gas. (2) The pressure at any point is proportional to the product of the number of molecules in unit volume about that point into the mean square of the velocity. (The mean square of the velocity is different from but proportional to the square of the mean velocity, and in the subsequent arguments either of these two quantities can generally be taken.) (3) In a gas mixture represented by a mixture of molecules of unequal masses, the mean kinetic energies of the different kinds are equal.

Consider now the problem of diffusion in a region containing two kinds of molecules A and B of unequal mass. The molecules of A in the neighbourhood of any point will, by their motion, spread out in every direction until they come into collision with other molecules of either kind, and this spreading out from every point of the medium will give rise to diffusion. If we imagine the velocities of the A molecules to be equally distributed in all directions, as they would be in a homogeneous mixture, it is obvious that the process of diffusion will be greater, *ceteris paribus*, the greater the velocity of the molecules, and the greater the length of the free path before a collision takes place. If we assume consistently with this, that the coefficient of diffusion of the gas A is proportional to the mean value of $w_0 l_0$, where w_0 is the velocity and l_0 is the length of the path of -

molecule of A, this expression for the coefficient of diffusion is of the right dimensions in length and time. If, moreover, we observe that when diffusion takes place in a fixed direction, say that of the axis of x , it depends only on the resolved part of the velocity and length of path in that direction: this hypothesis readily leads to our taking the mean value of $\frac{1}{\rho} \frac{d\rho}{dx}$ as the coefficient of diffusion for the gas A. This value was obtained by O. E. Meyer and others.

Unfortunately, however, it makes the coefficients of diffusion unequal for the two gases, a result inconsistent with that obtained above from considerations of the coefficient of resistance, and leading to the consequence that differences of pressure would be set up in different parts of the gas. To equalize these differences of pressure, Meyer assumed that a counter current is set up, this current being, of course, very slow in practice; and J. Stefan assumed that the diffusion of one gas was not affected by collisions between molecules of the same gas. When the molecules are mixed in equal proportions both hypotheses lead to the value $\frac{1}{2} \left(\frac{1}{\rho} \frac{d\rho}{dx} + \frac{1}{\rho} \frac{d\rho}{dy} \right)$, (square brackets denoting mean values). When one gas preponderates largely over the other, the phenomena of diffusion are too difficult of observation to allow of accurate experimental tests being made. Moreover, in this case no difference exists unless the molecules are different in size or mass.

Instead of supposing a velocity of translation added after the mathematical calculations have been performed, a better plan is to assume from the outset that the molecules of the two gases have small velocities of translation in opposite directions, superposed on the distribution of velocity, which would occur in a medium representing a gas at rest. When a collision occurs between molecules of different gases a transference of momentum takes place between them, and the quantity of momentum so transferred in one second in a unit of volume gives a dynamical measure of the resistance to diffusion. It is to be observed that, however small the relative velocity of the gases A and B, it plays an all-important part in determining the coefficient of resistance; for without such relative motion, and with the velocities evenly distributed in all directions, no transference of momentum could take place. The coefficient of resistance being found, the motion of each of the two gases may be discussed separately.

One of the most important consequences of the kinetic theory is that if the volume be kept constant the coefficient of diffusion varies as the square root of the absolute temperature. To prove this, we merely have to imagine the velocity of each molecule to be suddenly increased \sqrt{n} fold; the subsequent processes, including diffusion, will then go on \sqrt{n} times as fast; and the temperature T , being proportional to the kinetic energy, and therefore to the square of the velocity, will be increased n fold. Thus K , the coefficient of diffusion, varies as \sqrt{T} .

The relation of K to the density when the temperature remains constant is more difficult to discuss, but it may be sufficient to notice that if the number of molecules is increased n fold, the chances of a collision are n times as great, and the distance traversed between collisions is (not therefore) but as the result of more detailed reasoning) on the average $1/n$ of what it was before. Thus the free path, and therefore the coefficient of diffusion, varies inversely as the density, or directly as the volume. If the pressure p and temperature T be taken as variables, K varies inversely as p and directly as \sqrt{T} .

Now according to the experiments first made by J. C. Maxwell and J. Loschmidt, it appeared that with constant density K was proportional to T more nearly than to \sqrt{T} . The inference is that in this respect a medium formed of colliding spheres fails to give a correct mechanical model of gases. It has been found by L. Boltzmann, Maxwell and others that a system of particles whose mutual actions vary according to the inverse fifth power of the distance between them represents more correctly the relation between the coefficient of diffusion and temperature in actual gases. Other recent theories of diffusion have been advanced by M. Thiesen, P. Langevin and W. Sutherland. On the other hand, J. Thovert finds experimental evidence that the coefficient of diffusion is proportional to molecular velocity in the cases examined of non-electrolytes dissolved in water at 18° at 2.5 grams per litre.

BIBLIOGRAPHY.—The best introduction to the study of theories of diffusion is afforded by O. E. Meyer's *Kinetic Theory of Gases*, translated by Robert E. Baynes (London, 1899). The mathematical portion, though sufficient for ordinary purposes, is mostly of the simplest possible character. Another useful treatise is R. Rühlmann's *Handbuch der mechanischen Wärmetheorie* (Brunswick, 1885). For a shorter sketch the reader may refer to J. C. Maxwell's *Theory of Heat*, chaps. xix. and xxiii., or numerous other treatises on physics. The theory of the semi-permeable membrane is discussed by

M. Planck in his *Treatise on Thermodynamics*, English translation by A. Ogg (1903), also in treatises on thermodynamics by W. Voigt and other writers. For a more detailed study of diffusion in general the following papers may be consulted:—L. Boltzmann, "Zur Integration der Diffusionsgleichung," *Sitzung, der k. bayer. Acad. math.-phys. Klasse* (May 1894); T. des Coudres, "Diffusionsvorgänge in einem Zylinder," *Wied. Ann. Iv.* (1895), p. 213; J. Loschmidt, "Experimentaluntersuchungen über Diffusion," *Wien. Sitz. lxi.*, lxii. (1870); J. Stefan, "Gleichgewicht und . . . Diffusion von Gasemengen," *Wien. Sitz. lxiii.*, "Dynamische Theorie der Diffusion," *Wien. Sitz. lvi.* (April 1872); M. Töpler, "Gasdiffusion," *Wied. Ann. lviii.* (1896), p. 599; A. Wretschko, "Experimentaluntersuchungen über die Diffusion von Gasemengen," *Wien. Sitz. lxxi.* The mathematical theory of diffusion, according to the kinetic theory of gases, has been treated by a number of different methods, and for the study of these the reader may consult L. Boltzmann, *Vorlesungen über Gaslehre* (Leipzig, 1896–1898); S. H. Burbury, *Kinetic Theory of Gases* (Cambridge, 1899), and papers by L. Boltzmann in *Wien. Sitz.* lxxxv. (1882), lxxxvii. (1883); P. G. Tait, "Foundations of the Kinetic Theory of Gases," *Trans. R.S.E.* xxxiii., xxxv., xxvii., or *Scientific Papers*, ii. (Cambridge, 1900). For recent work reference should be made to the current issues of *Science Abstracts* (London), and entries under the heading "Diffusion" will be found in the general index at the end of each volume. (G. H. Ba.)

DIGBY, SIR EVERARD (1578–1606), English conspirator, son of Everard Digby of Stoke Dry, Rutland, was born on the 16th of May 1578. He inherited a large estate at his father's death in 1592, and acquired a considerable increase by his marriage in 1596 to Mary, daughter and heir of William Muloth of Gothurst (now Gayhurst), in Buckinghamshire. He obtained a place in Queen Elizabeth's household and as a ward of the crown was brought up a Protestant; but about 1599 he came under the influence of the Jesuit, John Gerard, and soon afterwards joined the Roman Catholics. He supported James's accession and was knighted by the latter on the 23rd of April 1603. In a letter to Salisbury, the date of which has been ascribed to May 1605, Digby offered to go on a mission to the pope to obtain from the latter a promise to prevent Romanist attempts against the government in return for concessions to the Roman Catholics; adding that if severe measures were again taken against them "within brief there will be massacres, rebellions and desperate attempts against the king and state." Digby had suffered no personal injury or persecution on account of his religion, but he sympathized with his co-religionists; and when at Michaelmas, 1605, the government had fully decided to return to the policy of repression, the authors of the Gunpowder Plot (*q.v.*) sought his financial support, and he joined eagerly in the conspiracy. His particular share in the plan was the organization of a rising in the Midlands; and on the pretence of a hunting party he assembled a body of gentlemen together at Danchurch in Warwickshire on the 5th of November, who were to take action immediately the news arrived from London of the successful destruction of the king and the House of Lords, and to seize the person of the princess Elizabeth, who was residing in the neighbourhood. The conspirators arrived late on the evening of the 6th to tell their story of failure and disaster, and Digby, who possibly might have escaped the more serious charge of high treason, was persuaded by Catesby, with a false tale that the king and Salisbury were dead, to further implicate himself in the plot and join the small band of conspirators in their hopeless endeavour to raise the country. He accompanied them, the same day, to Huddington in Worcestershire and on the 7th to Holbeche in Staffordshire. The following morning, however, he abandoned his companions, dismissed his servants except two, who declared "they would never leave him but against their will," and attempted with these to conceal himself in a pit. He was, however, soon discovered and surrounded. He made a last effort to break through his captors on horseback, but was taken and conveyed a prisoner to the Tower. His trial took place in Westminster Hall, on the 27th of January 1606, and alone among the conspirators he pleaded guilty, declaring that the motives of his crime had been his friendship for Catesby and his devotion to his religion. He was condemned to death, and his execution, which took place on the 31st, in St Paul's Churchyard, was accompanied by all the brutalities exacted by the law.

Digby was a handsome man, of fine presence. Father Gerard

extols his skill in sport, his "riding of great horses," as well as his skill in music, his gifts of mind and his religious devotion, and concludes "he was as complete a man in all things, that deserved estimation or might win affection as one should see in a kingdom." Some of Digby's letters and papers, which include a poem before his execution, a last letter to his infant sons and correspondence with his wife from the Tower, were published in *The Gunpowder Treason* by Thomas Barlow, bishop of Lincoln, in 1679. He left two sons, of whom the elder, Sir Kenelm Digby, was the well-known author and diplomatist.

See works on the Gunpowder Plot; Narrative of Father Gerard, in *Condition of the Catholics under James I.* by J. Morris (1872), &c. A life of Digby under the title of *A Life of a Conspirator*, by a Romish Recusant (Thomas Longueville), was published in 1895. (P. C. Y.)

DIGBY, SIR KENELM (1603-1665), English author, diplomatist and naval commander, son of Sir Everard Digby (q.v.), was born on the 11th of July, 1603, and after his father's execution in 1606 resided with his mother at Gayhurst, being brought up apparently as a Roman Catholic. In 1617 he accompanied his cousin, Sir John Digby, afterwards 1st earl of Bristol, and then ambassador in Spain, to Madrid. On his return in April 1618 he entered Gloucester Hall (now Worcester College), Oxford, and studied under Thomas Allen (1542-1632), the celebrated mathematician, who was much impressed with his abilities and called him the *Mirandula*, i.e. the infant prodigy, of his age.¹ He left the university without taking a degree in 1620, and travelled in France, where, according to his own account, he inspired an uncontrollable passion in the queen-mother, Marie de' Medici, now a lady of more than mature age and charms; he visited Florence, and in March 1623 joined Sir John Digby again at Madrid, at the time when Prince Charles and Buckingham arrived on their adventurous expedition. He joined the prince's household and returned with him to England on the 5th of October 1623, being knighted by James I. on the 23rd of October and receiving the appointment of gentleman of the privy chamber to Prince Charles. In 1625 he married secretly Venetia, daughter of Sir Edward Hanley of Tonge Castle, Shropshire, a lady of extraordinary beauty and intellectual attainments, but of doubtful virtue. Digby was a man of great stature and bodily strength. Edward Hyde, afterwards earl of Clarendon, who with Ben Jonson was included among his most intimate friends, describes him as "a man of very extraordinary person and presence which drew the eyes of all men upon him, a wonderful graceful behaviour, a flowing courtesy and civility, and such a volubility of language as surprised and delighted."² Digby for some time was excluded from public employment by Buckingham's jealousy of his cousin, Lord Bristol. At length in 1627, on the latter's advice, Digby determined to attempt "some generous action," and on the 22nd of December, with the approval of the king, embarked as a privateer with two ships, with the object of attacking the French ships in the Venetian harbour of Scanderon. On the 18th of January he arrived off Gibraltar and captured several Spanish and Flemish vessels. From the 15th of February to the 27th of March he remained at anchor off Algiers on account of the sickness of his men, and extracted a promise from the authorities of better treatment of the English ships. He seized a rich Dutch vessel near Majorca, and after other adventures gained a complete victory over the French and Venetian ships in the harbour of Scanderon on the 11th of June. His successes, however, brought upon the English merchants the risk of reprisals, and he was urged to depart. He returned home in triumph in February 1629, and was well received by the king, and was made a commissioner of the navy in October 1630, but his proceedings were disavowed on account of the complaints of the Venetian ambassador. In 1633 Lady Digby died, and her memory was celebrated by Ben Jonson in a series of poems entitled *Eupheme*, and by other poets of the day. Digby retired to Gresham College, and exhibited extravagant grief, maintaining a seclusion for two years. About this time Digby professed himself a Protestant, but by October 1635, while in France, he had already returned to the Roman

Catholic faith.³ In a letter dated the 27th of March 1636 Laud remonstrates with him, but assures him of the continuance of his friendship.⁴ In 1638 he published *A Conference with a Lady about choice of a Religion*, in which he argues that the Roman Church, possessing alone the qualifications of universality, unity of doctrine and uninterrupted apostolic succession, is the only true church, and that the intrusion of error into it is impossible. The same subject is treated in letters to George Digby, afterwards 2nd earl of Bristol, dated the 2nd of November 1638 and the 20th of November 1639, which were published in 1651, as well as in a further *Discourse concerning Infallibility in Religion* in 1652. Returning to England he associated himself with the queen and her Roman Catholic friends, and joined in the appeal to the English Romanists for money to support the king's Scottish expedition.⁵ In consequence he was summoned to the bar of the House of Commons on the 27th of January 1641, and the king was petitioned to remove him with other recusants from his councils. He left England, and while at Paris killed in a duel a French lord who had insulted Charles I. in his presence. Louis XIII. took his part, and furnished him with a military escort into Flanders. Returning home he was imprisoned, by order of the House of Commons, early in 1642, successively in the "Three Tobacco Pipes nigh Charing Cross," where his delightful conversation is said to have transformed the prison into "a place of delight,"⁶ and at Winchester House. He was finally released and allowed to go to France on the 30th of July 1643, through the intervention of the queen of France, Anne of Austria, on condition that he would neither promote nor conceal any plots abroad against the English government.

Before leaving England an attempt was made to draw from him an admission that Laud, with whom he had been intimate, had desired to be made a cardinal, but Digby denied that the archbishop had any leanings towards Rome. On the 1st of November 1643 it was resolved by the Commons to confiscate his property. He published in London the same year *Observations on the 22nd stanza in the 9th canto of the 2nd book of Spenser's "Fabric Queen,"* the MS. of which is in the Egerton collection (British Museum, No. 2725 f. 117 b), and *Observations on a surreptitious and unauthorized edition of the Religio Medici*, by Sir Thomas Browne, from the Roman Catholic point of view, which drew a severe rebuke from the author. After his arrival in Paris he published his chief philosophical works, *Of Bodies* and *Of the Immortality of Man's Soul* (1644), autograph MSS. of which are in the Bibliothèque Ste Geneviève at Paris, and made the acquaintance of Descartes. He was appointed by Queen Henrietta Maria her chancellor, and in the summer of 1645 he was despatched by her to Rome to obtain assistance. Digby promised the conversion of Charles and of his chief supporters. At first his eloquence made a great impression. Pope Innocent X. declared that he spoke not merely as a Catholic but as an ecclesiastic. But the absence of any warrant from Charles himself roused suspicions as to the solidity of his assurances, and he obtained nothing but a grant of 20,000 crowns. A violent quarrel with the pope followed, and he returned in 1646, having consented in the queen's name to complete religious freedom for the Roman Catholics, both in England and Ireland, to an independent parliament in Ireland, and to the surrender of Dublin and all the Irish fortresses into the hands of the Roman Catholics, the king's troops to be employed in enforcing the articles and the pope granting about £36,000 with a promise of further payments in obtaining direct assistance. In February 1649 Digby was invited to come to England to arrange a proposed toleration of the Roman Catholics, but on his arrival in May the scheme had already been abandoned. He was again banished on the 31st of August, and it was not till 1654 that he was allowed by the council of state to return. He now entered into close relations with Cromwell, from whom he hoped to obtain toleration for the Roman Catholics, and whose alliance he desired to secure for France rather than for

¹ *Strafford's Letters*, i. 474.

² *Laud's Works*, vi. 47.

³ *Thomasson's Tracts*, Brit. Mus. E 164 (15).

⁴ *Archæologia Cantiana*, ii. 190.

¹ *Letters by Eminent Persons* (Aubrey's Lives), ii. 324.

² *Life and Conversation*.

Spain, and was engaged by Cromwell, much to the scandal of both Royalists and Roundheads, in negotiations abroad, of which the aim was probably to prevent a union between those two foreign powers. He visited Germany, in 1660 was in Paris, and at the Restoration returned to England. He was well received in spite of his former relations with Cromwell, and was confirmed in his post as Queen Henrietta Maria's chancellor. In January 1661 he delivered a lecture, which was published the same month, at Gresham College, on the vegetation of plants, and became an original member of the Royal Society in 1663. In January 1664 he was forbidden to appear at court, the cause assigned being that he had interposed too far in favour of the 2nd earl of Bristol, disgraced by the king on account of the charge of high treason brought by him against Clarendon into the House of Lords. The rest of his life was spent in the enjoyment of literary and scientific society at his house in Covent Garden. He died on the 11th of June 1665. He had five children, of whom two, a son and one daughter, survived him.

Digby, though he possessed for the time a considerable knowledge of natural science, and is said to have been the first to explain the necessity of oxygen to the existence of plants, bears no high place in the history of science. He was a firm believer in astrology and alchemy, and the extraordinary fables which he circulated on the subject of his discoveries are evidence of anything rather than of the scientific spirit. In 1656 he made public a marvellous account of a city in Tripoli, petrified in a few hours, which he printed in the *Mercurius Politicus*. Malicious reports had been current that his wife had been poisoned by one of his prescriptions, viper wine, taken to preserve her beauty. Evelyn, who visited him in Paris in 1651, describes him as an "errant mountebank." Henry Stubbes characterizes him as "the very Pliny of our age for lying," and Lady Fanshawe refers to the same "infirmity." His famous "powder of sympathy," which seems to have been only powder of "vitriol," healed without any contact, by being merely applied to a rag or bandage taken from the wound, and Digby records a miraculous cure by this means in a lecture given by him at Montpellier on this subject in 1658, published in French and English the same year, in German in 1660 and in Dutch in 1663; but Digby's claim to its original discovery is doubtful, Nathaniel Highmore in his *History of Generation* (1651, p. 113) calling the powder "Talbot's powder," and ascribing its invention to Sir Gilbert Talbot. Some of Digby's pills and preparations, however, described in *The Closet of the Eminently Learned Sir Kenelm Digby Knt. Opened* (publ. 1677), are said to make less demand upon the faith of patients, and his injunction on the subject of the making of tea, to let the water "remain upon it no longer than you can say the Miserere Psalm very leisurely," is one by no means to be ridiculed. As a philosopher and an Aristotelian Digby shows little originality and followed the methods of the schoolmen. His Roman Catholic orthodoxy mixed with rationalism, and his political opinions, according to which any existing authority should receive support, were evidently derived from Thomas White (1582-1676), the Roman Catholic philosopher, who lived with him in France. White published in 1651 *Institutionum Peripateticorum libri quinque*, purporting to expound Digby's "peripatetic philosophy," but going far beyond Digby's published treatises. Digby's *Memoirs* are composed in the high-flown fantastic manner then usual when recounting incidents of love and adventure, but the style of his more sober works is excellent. In 1632 he presented to the Bodleian library a collection of 236 MSS., bequeathed to him by his former tutor Thomas Allen, and described in *Catalogi codicum manuscriptorum bibliothecae Bodleianae*, by W. D. Macray, part ix. Besides the works already mentioned Digby translated *A Treatise of adhering to God written by Albert the Great, Bishop of Ratisbon* (1653); and he was the author of *Private Memoirs*, published by Sir N. H. Nicholas from *Harleian MS. 8758* with introduction (1827); *Journal of the Scanderoon Voyage in 1628*, printed by J. Bruce with preface (Camden Society, 1868); *Poems from Sir Kenelm Digby's Papers* . . . with

¹ *Dict. of Nat. Biog.* sub "Digby." See also Robert Boyle's *Works* (1744), v. 302.

preface and notes (Roxburghe Club, 1877); in the *Add. MSS.* 34,362 f. 66 is a poem *Of the Miserys of Man*, probably by Digby; *Choice of Experimental Receipts in Physick and Chirurgery* . . . collected by Sir K. Digby (1668), and *Chymical Secrets and Rare Experiments* (1683), were published by G. Hartman, who describes himself as Digby's steward and laboratory assistant.

See the *Life of Sir Kenelm Digby by one of his Descendants* (T. Longueville), 1896. (P. C. Y.)

DIGBY, KENELM HENRY (1800-1880), English writer, youngest son of William Digby, dean of Clonfert, was born at Clonfert, Ireland, in 1800. He was educated at Trinity College, Cambridge, and soon after taking his B.A. degree there in 1819 became a Roman Catholic. He spent most of his life, which was mainly devoted to literary pursuits, in London, where he died on the 22nd of March 1880. Digby's reputation rests chiefly on his earliest publication, *The Broadstone of Honour, or Rules for the Gentlemen of England* (1823), which contains an exhaustive survey of mediæval customs, full of quotations from varied sources. The work was subsequently enlarged and issued (1826-1827) in four volumes entitled: *Godefridus, Tamcredus, Morus and Orlandus* (numerous re-impressions, the best of which is the edition brought out by B. Quaritch in five volumes, 1876-1877).

Among Digby's other works are: *Mores Catholici, or Ages of Faith* (11 vols., London, 1831-1840); *Compius; or the Meeting of the Ways at the Catholic Church* (7 vols., London, 1848-1854); *The Lovers' Seal, Kathemerina; or Common Things in relation to Beauty, Virtue and Faith* (2 vols., London, 1856). A complete list is given in J. Gillow's *Bibliographical Dictionary of English Catholics*, ii. 81-83.

DIGENES ACIRITAS, BASILIUS, Byzantine national hero, probably lived in the 10th century. He is named Digenes (of double birth) as the son of a Moslem father and a Christian mother; Aciritas (*ἀκρη*, frontier, boundary), as one of the frontier guards of the empire, corresponding to the Roman *militēs limitanei*. The chief duty of these *acritæ* consisted in repelling Moslem inroads and the raids of the *apclatae* (cattle-lifters), brigands who may be compared with the more modern Klefts. The original Digenes epic is lost, but four poems are extant, in which the different incidents of the legend have been worked up by different hands. The first of these consists of about 4000 lines, written in the so-called "political" metre, and was discovered in the latter part of the 19th century, in a 16th-century MS., at Trebizond; the other three MSS. were found at Grotta Ferrata, Andros and Oxford. The poem, which has been compared with the *Chanson de Roland* and the *Romançe of the Cid*, undoubtedly contains a kernel of fact, although it cannot be regarded as in any sense an historical record. The scene of action is laid in Cappadocia and the district of the Euphrates.

Editions of the Trebizond MS. by C. Sathas and E. Legrand in the *Collection des monuments pour servir à l'étude de la langue néo-hellénique*, new series, vi. (1875), and by S. Joannides (Constantinople, 1887). See monographs by A. Luber (Salzburg, 1885) and G. Wartenberg (Berlin, 1897). Full information will be found in C. Krumbacher's *Geschichte der byzantinischen Litteratur*, p. 827 (and *ibid.*, 1897); see also G. Schlumberger, *L'Épopée Byzantine à la fin des dixième siècle* (1897).

DIGEST, a term used generally of any digested or carefully arranged collection or compendium of written matter, but more particularly in law of a compilation in condensed form of a body of law digested in a systematical method; e.g. the Digest (*Digesta*) or Pandects (*Πανδέκτα*) of Justinian, a collection of extracts from the earlier jurists compiled by order of the emperor Justinian. The word is also given to the compilations of the main points (marginal or hand-notes) of decided cases, usually arranged in alphabetical and subject order, and published under such titles as "Common Law Digest," "Annual Digest," &c.

DIGESTIVE ORGANS (PATHOLOGY). Several facts of importance have to be borne in mind for a proper appreciation of the pathology of the organs concerned in digestive processes (for the anatomy see ALIMENTARY CANAL and allied articles). In the first place, more than all other systems, the digestive comprises greater range of structure and exhibits widest diversity of function within its domain. Each separate structure and each different function presents special pathological signs and symptoms. Again, the duties imposed upon the system have to be performed

notwithstanding constant variations in the work set them. The crude articles of diet offered them vary immensely in nature, bulk and utility, from which they must elaborate simple food-elements for absorption, incorporate them after absorption into complex organic substances properly designed to supply the constant needs of cellular activity, of growth and repair, and fitly harmonized to fulfil the many requirements of very divergent processes and functions. Any form of unphysiological diet, each failure to cater for the wants of any special tissue engaged in, or of any processes of, metabolism, carry with them pathological signs. Perhaps in greater degree than elsewhere are the individual sections of the digestive system dependent upon, and closely correlated with, one another. The lungs can only yield oxygen to the blood when the oxygen is uncombined; no compounds are of use. The digestive organs have to deal with an enormous variety of compound bodies, from which to obtain the elements necessary for protoplasmic upkeep and activity. Morbid lesions of the respiratory and circulatory systems are frequently capable of compensation through increased activity elsewhere; and the symptoms they give rise to follow chiefly along one line; diseases of the digestive organs are more liable to occasion disorders elsewhere than to excite compensatory actions. The digestive system includes every organ, function and process concerned with the utilization of food-stuffs, from the moment of their entrance into the mouth, their preparation in the canal, assimilation with the tissues, their employment therein, up to their excretion or expulsion in the form of waste. Each portion resembles a link of a continuous chain; each link depends upon the integrity of the others, the weakening or breaking of one straining or making impotent the chain as a whole.

The mucous membrane lining the alimentary tract is the part most subject to pathological alterations, and in this connexion it should be remembered that this membrane differs both in structure and functions throughout the tract. Chiefly protective from the mouth to the cardia, it is secretory and absorbent in the stomach and bowel; while the glandular cells forming part of it secrete both acid and alkaline fluids, several ferments or mucus. Over the dorsum of the tongue its modified cells subserv the sense of taste. Without, connected with it by the submucous connective tissue, is placed the muscular coat, and externally over the greater portion of its length the peritoneal serous membrane. All parts are supplied with blood-vessels, lymph-ducts and nerves, the last belonging either to local or to central circuits. Associated with the tract are the salivary glands, the liver and the pancreas; while, in addition, lymphoid tissue is met with diffusely scattered throughout the lining membranes in the tonsils, appendix, solitary glands and Peyer's patches, and the mesenteric glands. The functions of the various parts of the system in whose lesions we are here interested are many in number, and can only be summarized here. (For the physiology of digestion see NUTRITION.) Broadly, they may be given as: (1) Ingestion and swallowing of food, transmission of it through the tract, and expulsion of the waste material; (2) secretion of acids and alkalis for the performance of digestive processes, aided by (3) elaboration and addition of complex bodies, termed enzymes or ferments; (4) secretion of mucus; (5) protection of the body against organismal infection, and against toxic products; (6) absorption of food elements and reconstitution of them into complex substances fitted for metabolic application; and (7) excretion of the waste products of protoplasmic action. These functions may be altered by disease, singly or in conjunction; it is rare, however, to find but one affected, while an apparently identical disturbance of function may often arise from totally different organic lesions. Another point of importance is seen in the close interdependence which exists between the secretions of acid and those of alkaline reaction. The difference in reaction seems to act *mutatis mutandis* as a stimulant in each instance.

General Diseases.

In all sections of the alimentary canal actively engaged in the digestion of food, a well-marked local engorgement of the blood-vessels supplying the walls occurs. The hyperæmia abates soon

after completion of the special duties of the individual sections. This normal condition may be abnormally exaggerated by over-stimulation from irritant poisons introduced into the canal; from too rich, too copious or indigestible articles of diet; or from too prolonged an experience of some unvaried kind of food-stuff, especially if large quantities of it are necessary for metabolic needs; entering into the first stage of inflammation, acute hyperæmia. More important, because productive of less tractable lesions, is passive congestion of the digestive organs. Whenever the flow of blood into the right side of the heart is hindered, whether it arise from disease of the heart itself, or of the lungs, or proceed from obstruction in some part of the portal system, the damming-back of the venous circulation speedily produces a more or less pronounced stasis of the blood in the walls of the alimentary canal and in the associated abdominal glands. The lack of a sufficiently vigorous flow of blood is followed by deficient secretion of digestive agents from the glandular elements involved, by decreased motility of the muscular coats of the stomach and bowel, and lessened adaptability throughout for dealing with even slight irregular demands on their powers. The mucous membrane of the stomach and bowel, less able to withstand the effects of irritation, even of a minor character, readily passes into a condition of chronic catarrh, while it frequently is the seat of small abrasions, hæmorrhagic erosions, which may cause vomiting of blood and the appearance of blood in the stools. Obstruction to the flow of blood from the liver leads to dilatation of its blood-vessels, consequent pressure upon the hepatic cells adjoining them, and their gradual loss of function, or even atrophy and degeneration. In addition to the results of such passive congestion exhibited by the stomach and bowel as noted above, passive congestion of the liver is often accompanied by varicose enlargement of the abdominal veins, in particular of those which surround the lower end of the œsophagus, the lowest part of the rectum and anus. In the latter position these dilated veins constitute what are known as hæmorrhoids or piles, internal or external as their site lies within or outside the anal aperture.

The mucous and serous membranes of the canal and the glandular elements of the associated organs are the parts most subject to inflammatory affections. Among the several sections of the digestive tract itself, the œsophagus and jejunum are singularly exempt from inflammatory processes; the fauces, stomach, caecum and appendix, ileum, mouth and duodenum (including the opening of the common bile-duct), are more commonly involved. *Stomatitis*, or inflammation of the mouth, has many predisposing factors, but it has now been definitely determined that its exciting cause is always some form of micro-organism. Any condition favouring oral sepsis, as carious teeth, pyorrhœa alveolaris (a discharge of pus due to inflamed granulations round carious teeth), granulations beneath thick crusts of tartar, or an irritating tooth plate, favours the growth of pyogenic organisms and hence of stomatitis. Many varieties of this disease have been described, but all are forms of "pyogenic" or "septic stomatitis." This in its mildest form is catarrhal or erythematous, and is attended only by slight swelling tenderness and salivation. In its next stage of acuteness it is known as "membranous," as a false membrane is produced somewhat resembling that due to diphtheria, though caused by a staphylococcus only. A still more acute form is "ulcerative," which may go on to the formation of an abscess beneath the tongue. Scarlet fever usually gives rise to a slight inflammation of the mouth followed by desquamation, but more rarely it is accompanied by a most severe oedematous stomatitis with glossitis and tonsillitis. Erysipelas on the face may infect the mouth, and an acute stomatitis due to the diphtheria bacillus, Klebs-Loeffer bacillus, has been described. A distinct and very dangerous form of stomatitis in infants and young children is known as "aphthous stomatitis" or "thrush." This is caused by the growth of *Oidium albicans*. It is always preceded by a gastro-enteritis and dry mouth, and if this is not attended to, soon attracts attention by the little white raised patches surrounded by a dusky red zone

VENOUS
OBSCES.

INFLAM-
MATORY
LESION.

scattered on tongue and cheeks. Epidemics have occurred in hospitals and orphanages. Mouth breathing is the cause of many ills. As a result of this, the mucous membrane of the tongue, &c., becomes dry, micro-organisms multiply and the mouth becomes foul. Also from disease of the nose, the upper jaw, palate and teeth do not make proper progress in development. There is overgrowth of tonsils, and adenoids, with resulting deafness, and the child's mental development suffers. An ordinary "sore throat" usually signifies acute catarrh of the fauces, and is of purely organismal origin, "catching cold" being only a secondary and minor cause. In "relaxed throats" there is a chronic catarrhal state of the lining membrane, with some passive congestion. The tonsils are peculiarly liable to catarrhal attacks, as might a priori be expected by reason of their Cerberus-like function with regard to bacterial intruders. Still, acute attacks of tonsillitis appear on good evidence to be more common among individuals predisposed constitutionally to rheumatic manifestations. Cases of acute tonsillitis may or may not go on to suppuration or quinsy; in all there is great congestion of the glands, increased mucus secretion, and often secondary involvement of the lymphatic glands of the neck. Repeated acute attacks often lead to chronic inflammation, in which the glands are enlarged, and often hypertrophied in the true sense of the term. The oesophagus is the seat of inflammation but seldom. In infants and young children thrush due to *Oidium albicans* may spread from the mouth, and also a diphtheritic inflammation spreads from the fauces into the oesophagus. A catarrhal oesophagitis is rarely seen, but the commonest form is traumatic, due to the swallowing of boiling water, corrosive or irritant substances, &c. A non-malignant ulceration may result which later leads on to an oesophageal stricture. The physical changes presented by the coats of the stomach and the intestine, the subjects of catarrhal attacks, closely resemble one another, but differ symptomatically. Acute catarrh of the stomach is associated with intense hyperaemia of its lining coats, with visible engorgement and swelling of the mucous membrane, and an excessive secretion of mucus. The formation of active gastric juice is arrested, digestion ceases, peristaltic movements are sluggish or absent, unless so over-stimulated that they act in a direction the reverse of the normal, and induce expulsion of the gastric contents by vomiting. The gastric contents, in whatever degree of dilution or concentration they may have been ingested, when ejected are of porridge-thick consistency, and often but slightly digested. Such conditions may succeed a severe alcoholic bout, be caused by irritant substances taken in by the mouth or arise from fermentative processes in the stomach contents themselves. Should the irritating material succeed in passing from the stomach into the bowel, similar physical signs are present; but as the quickest path offered for the expulsion of the offending substances, from the body is downwards, peristalsis is increased, the flow of fluid from the intestinal glands is larger in bulk, though of less potency as regards its normal actions, than in health, and diarrhoea, with removal of the irritant, follows. As a general rule, the more marked the involvement of the large bowel, the severer and more fluid is the resultant diarrhoea. Inflammation of the stomach may be due to mechanical injury, thermal or chemical irritants or invasion by micro-organisms. Also all the symptoms of gastric catarrh may be brought on by any acute emotion. The commonest mechanical injury is that due to an excess of food, especially when following on a fast; poisons act as irritants, and also the weevils of cheese and the larvae of insects.

Inflammatory affections of the caecum and its attached appendix vermiformis are very common, and give rise to several special symptoms and signs. Acute inflammatory appendicitis appears to be increasing in frequency, and is associated by many with the modern deterioration in the teeth. Constipation certainly predisposes to it, and it appears to be more prevalent among medical men, commercial travellers, or any engaged in arduous callings, subjected to irregular meals, fatigue and exposure. A foreign body is the exciting cause in many cases, though less commonly so than was formerly imagined. The inflammation in the appendix varies in intensity from a very

slight catarrhal or simple form to an ulcerative variety, and much more rarely to the acute fulminating appendicitis in which necrosis of the appendix with abscess formation occurs. It is always accompanied by more or less peritonitis, which is protective in nature, shutting in the inflammatory process. Very similar symptomatically is the condition termed perityphlitis, doubtless in former days frequently due to the appendix, an acute or chronic inflammation of the walls of the caecum often leading to abscess formation outside the gut, with or without direct communication with the canal. The colon is subject to three main forms of inflammation. In simple colitis the mucous membrane of the colon is intensely injected, bright red in colour, and secreting a thick mucus, but there is no accompanying ulceration. It is often found in association with some constitutional disease, as Bright's disease, and also with cancer of the bowel. But when it has no association with other trouble it is probably bacterial in origin, the *Bacillus enteritidis spirogenes* having been isolated in many cases. The motions always contain large quantities of mucus and more or less blood. A second very severe form of inflammation of the colon is known as "membranous colitis," and this may be either dyspeptic, or secondary to other diseases. In this trouble membranes are passed *per casum*, accompanied by a pain so intense as often to cause fainting. In severe cases complete tubular casts of the intestine have been found. Often the motions contain very little faecal matter, but consist only of membranes, mucus and a little blood. A third form is that known as "ulcerative colitis." Any part of the large intestine may be affected, and the ulceration shows no special distribution. In severe cases the muscular coat is exposed, and perforation may ensue. The number of ulcers varies from a few to many dozen, and in size from a pea to a five-shilling piece. Like all chronic intestinal ulcers they show a tendency to become transverse.

Chronic catarrhal affections of the stomach are very common, and often follow upon repeated acute attacks. In them the connective tissue increases at the expense of the glandular elements; the mucous membrane becomes thickened and less active in function. Should the muscular coat be involved, the elasticity and contractility of the organ suffer; peristaltic movement is weakened; expulsion of the contents through the pylorus hindered; and, aggravated by these effects, the condition becomes worse, atonic dyspepsia in its most pronounced form results, with or without dilatation. Chronic vascular congestion may occasion in process of time similar signs and symptoms.

Duodenal catarrh is constantly associated with jaundice, indeed is most probably the commonest cause of catarrhal jaundice; often it is accompanied by catarrh of the common bile-duct. Chronic inflammation of the small intestine gives rise to less prominent symptoms than in the stomach. It generally arises from more than one cause; or rather secondary causes rapidly become as important as the primary in its incidence. Chronic congestion and prolonged irritation lead to deficient secretion and sluggish peristalsis; these effects encourage intestinal putrefaction and auto-intoxication; and these latter, in turn, increase the local unrest.

The intestinal mucous membrane, the peritoneum and the mesenteric glands are the chief sites of tubercular infection in the digestive organs. Rarely met with in the gullet and stomach, and comparatively seldom in the mouth and lips, tubercular inflammation of the small intestine and peritoneum is common. Tubercular enteritis is a frequent accompaniment of phthisis, but may occur apart from tubercle of other organs. Children are especially subject to the primary form. Tubercular peritonitis often is present also. The inflammatory process readily tends towards ulcer formation, with haemorrhage and sometimes perforation. If in the large bowel, the symptoms are usually less acute than those characterizing tubercular inflammation of the small intestine. The appendix has been found to be the seat of tubercular processes; in the rectum they form the general cause of the fistulae and abscesses so commonly met with here. Tubercular peritonitis may be primary or secondary, acute or chronic; occasionally very acute cases are seen running a rapid course; the majority are chronic in type.

Infective
Anatom.

The tubercles spread over the surface of the serous membrane, and if small and not very numerous may give rise in chronic cases to few symptoms; if larger, and especially when they involve and obstruct the lymph- and blood-vessels, ascites follows. It is hardly possible that tubercular invasion of the mesenteric glands can ever occur unaccompanied by peritoneal infection; but when the infection of the glands constitutes the most prominent sign, the term *tubercles mesentericae* is sometimes employed. Here the glands, enlarged, form a doughy mass in the abdomen, leading to marked protrusion of the abdominal walls, with wasting elsewhere and diarrhoea.

The liver is seldom attacked by tubercle, unless in cases of general miliary tuberculosis. Now and then it contains large caseous tubercular masses in its substance.

An important fact with regard to the tubercular processes in the digestive organs lies in the ready response to treatment shown by many cases of peritoneal or mesenteric invasion, particularly in the young.

The later sequelae of syphilis display a predilection for the rectum and the liver, usually leading to the development of a stricture in the former, to a diffuse hepatitis or the formation of gummata in the second. In inherited syphilis the temporary teeth usually appear early, are discoloured and soon crumble away. The permanent teeth may be sound and healthy, but are often—especially the upper incisors—notched and stunted, when they are known as "Hutchinson's teeth." As the result both of syphilis and of tubercle, the tissues of the liver and bowel may present a peculiar alteration; they become amyloid, or lardaceous, a condition in which they appear "waxy," are coloured dark mahogany brown with dilute iodine solutions, and show degenerative changes in the connective tissue.

The *Bacillus typhosus* discovered by Eberth is the causal agent of typhoid fever, and has its chief seat of activity in the small intestine, more especially in the lower half of the ileum. Attacking the lymphoid follicles in the mucous membrane, it causes first inflammatory enlargement, then necrosis and ulceration. The adjacent portions of the mucous membrane show acute catarrhal changes. Diarrhoea, of a special "pea-soup" type, may or may not be present; while haemorrhage from the bowel, if ulcers have formed, is common. As the ulcers frequently extend down to the peritoneal coat of the bowel, perforation of this membrane and extravasation into the peritoneal cavity is easily induced by irritants introduced into or elaborated in the bowel, acting physically or by the excitation of hyper-peristalsis.

True Asiatic cholera is due to the comma-bacillus or spirillum of cholera, which is found in the rice-water evacuations, in the contents of the intestine after death, and in the mucous membrane of the intestine just beneath the epithelium. It has not been found in the blood. It produces an intense irritation of the bowel, seldom of the stomach, without giving rise locally to any marked physical change; it causes violent diarrhoea and copious discharges of "rice-water" stools, consisting largely of serum swarming with the organism.

Dysentery gives rise to an inflammation of the large intestine and sometimes of the lower part of the ileum, resulting in extensive ulceration and accompanied by faecal discharges of mucus, mucus-pus or blood. In some forms a protozoan, the *Amoeba dysenteriae*, is found in the stools—this is the amoebic dysentery; in other cases a bacillus, *Bacillus dysenteriae*, is found—the bacillary dysentery.

Acute parotitis, or mumps, is an infectious disease of the parotid glands, chiefly interesting because of the association between it and the testes in males, inflammation of these glands occasionally following or replacing the affection of the parotids. The causal agent is probably organismal, but has as yet escaped detection.

The relative frequency with which malignant growths occur in the different organs of the digestive system may be gathered from

the tabular analysis, on p. 266, of 1768 cases recorded in the books of the Edinburgh Royal Infirmary as having been treated in the medical and surgical wards between the years 1892 and 1899 inclusive. Of these, 1263, or 71.44 %, were males; 505, or 28.56 %, females. (See Table I. p. 266.)

If the figures there given be classified upon broader lines, the results are as given in Table II. p. 266, and speak for themselves.

The digestive organs are peculiarly subject to malignant disease, a result of the incessant changes from passive to active conditions, and vice versa, called for by repeated introduction of food; while the comparative frequency with which different parts are attacked depends, in part, upon the degree of irritation or changes of function imposed upon them. Scirrhus, encephaloid and colloid forms of carcinoma occur. In the stomach and oesophagus the scirrhus form is most common, the soft encephaloid form coming next. The most common situation for cancerous growth in the stomach is the pyloric region. Walshout of 1300 cases found 60.8 % near the pylorus, 11.4 % over the lesser curvature, and 4.7 % more or less over the whole organ. The small intestine is rarely attacked by cancer; the large intestine frequently. The rectum, sigmoid flexure, caecum and colon are affected, and in this order, the cylindrical-celled form being the most common. Carcinoma of the peritoneum is generally colloid in character, and is often secondary to growths in other organs. Cancer of the liver follows cancer of the stomach and rectum in frequency of occurrence, and is relatively more common in females than males. Secondary invasion of the liver is a frequent sequel to gastric cancer. The pancreas occasionally is the seat of cancerous growth.

Sarcomata are not so often met with in the digestive organs. When present, they generally involve the peritoneum or the mesenteric glands. The liver is sometimes attacked, the stomach rarely.

Benign tumours are not of common occurrence in the digestive organs. Simple growths of the salivary glands, cysts of the pancreas and polypoid tumours of the rectum are the most frequent.

The intestinal canal is the habitat of the majority of animal parasites found in man. Frequently their presence leads to no morbid symptoms, local or general; nor are the symptoms, when they do arise, always characteristic of the presence of parasites alone. Discovery of their bodies, or of their eggs, in the stools is in most instances the only satisfactory proof of their presence. The parasites found in the bowel belong principally to two natural groups, Protozoa and Metazoa. The great class of the Protozoa furnish amoebae, members of Sporozoa and Infusoria. The amoebae are almost invariably found in the large intestine; one species, indeed, is termed *Amoeba coli*. The frequently observed relation, between attacks of dysentery and the presence of amoebae in the stools has led to the proposition that an *Amoeba dysenterica* exists, causing the disease—a theory supported by the detection of amoebae in the contents of dysenteric abscesses of the liver. No symptoms of injury to health appear to accompany the presence of Sporozoa in the bowel, while the species of Infusoria found in it, the *Cercomonas*, and *Trichomonas intestinalis*, and the *Balantidium coli*, may or may not be guilty of prolonging conditions within the bowel as have previously set up diarrhoea.

The Metazoa supply examples of intestinal parasites from the classes Annuloida and Nematoida. To the former class belong the various tapeworms found in the small intestine of man. They, like other intestinal parasites, are destitute of any power of active digestion, simply absorbing the nutritious proceeds of the digestive processes of their hosts. Nematode worms infest both the small and large intestine; *Ascaris lumbricoides*, the common round worm, and the male *Oxyuris vermicularis* are found in the small bowel, the adult female *Oxyuris vermicularis* and the *Tricocephalus dispar* in the large.

The eggs of the *Trichina spiralis*, when introduced with the food, develop in the bowel into larval forms which invade the tissues of the body, to find in the muscles congenial spots wherein to reach maturity. Similarly, the eggs of the Echinococcus are hatched in the bowel, and the embryos proceed to take up their abode in the tissues of the body, developing into cysts capable of growth into mature worms after their ingestion by dogs.

Animal
parasites.

Numbers of bacterial forms habitually infest the alimentary canal. Many of them are non-pathogenic; some develop pathogenic characters only under provocation or when a suitable environment induces them to act in such a manner; others may form the *materies morbi* of special lesions, or be casual visitors capable of originating disease if opportunity occurs. Apart from those organisms associated with acute infective diseases, disturbances of function and physical

Vegetable parasites.

Bacillus lactis may be found where the child is bottle fed. If there is trouble with the first dentition and food is allowed to collect, staphylococci, streptococci, pneumococci and colon bacilli may be present. Even in healthy babies *Oidium albicans* may be present, and in older children the pseudo-diphtheria bacillus. From carious teeth may be isolated streptothrix, leptothrix, spirilla and fusiform bacilli. Under conditions of health these micro-organisms live in the mouth as saprophytes,

TABLE I.

Males.		Females.		Both Sexes.	
Organ or Tissue in Order of Frequency.	Per-centage.	Organ or Tissue in Order of Frequency.	Per-centage.	Organ or Tissue in Order of Frequency.	Per-centage.
1 Stomach	22-56	1 Stomach	22-37	1 Stomach	22-49
2 Lip	12-94	2 Rectum	17-24	2 Rectum	13-12
3 Rectum	11-57	3 Liver	15-50	3 Liver	10-02
4 Tongue	11-36	4 Peritoneum	7-86	4 Lip	9-89
5 Oesophagus	10-90	5 Oesophagus	5-33	5 Oesophagus	9-29
6 Liver	7-80	6 Sigmoid	4-53	6 Tongue	8-06
7 Jaw	6-38	7 Pancreas	3-52	7 Jaw	5-65
8 Mouth	2-88	8 Tongue	3-12	8 Peritoneum	2-94
9 Tonsils	2-09	9 Omentum	2-98	9 Sigmoid	2-56
10 Sigmoid flexure	1-77	10 Lip	2-57	10 Mouth	2-40
11 Parotid	1-10	11 Jaw	1-97	11 Pancreas	1-80
12 Pancreas	1-10	12 Colon	1-84	12 Tonsils	1-35
13 Caecum	0-94	13 Abdomen	1-56	13 Omentum	1-25
14 Peritoneum	0-89	14 Intestine	1-37	14 Parotid	1-12
15 Colon	0-89	15 Caecum	1-18	15 Colon	1-08
16 Pharynx	0-79	16 Mouth	0-98	16 Caecum	1-00
17 Intestine (site unknown)	0-71	17 Parotid	0-68	17 Intestine	0-62
18 Abdomen	0-55	18 Splenic flexure	0-68	18 Abdomen	0-52
19 Mesentery	0-39	19 Jejunum and ileum	0-40	19 Pharynx	0-28
20 Omentum	0-31	20 Tonsils	0-20	20 Mesentery	0-22
21 Hepatic flexure	0-23	21 Pharynx	0-15	21 Jejunum and ileum	0-44
22 Submaxillary gland	0-15	22 Hepatic flexure	0-15	22 Hepatic flexure	0-44
23 Jejunum and ileum	0-15	23 Mesentery	0-15	23 Splenic flexure	0-28
24 Duodenum	0-15	24 Submaxillary	0-15	24 Submaxillary	0-28
25 Splenic flexure	0-15	25 Duodenum	0-15	25 Duodenum	0-22

Note.—The figures where several organs are bracketed apply to each organ separately.

lesions may be the result of abnormal bacterial activity in the canal; and these disturbances may be both local and general. Many of the bacteria commonly present produce putrefactive changes in the contents of the tract by their metabolic processes. They render the medium they grow in alkaline, produce different gases and elaborate more or less virulent toxins. Other species set up an acid fermentation, seldom accompanied by gas or toxin formation. The products of either class are inimical to the free

abnormalities which are interesting to the surgeon rather than to the pathologist. The oesophagus may be the seat of a diverticulum, or blind pouch, usually situated in its lower half, which in most instances is probably partly acquired and partly congenital; a local weakness succumbing to pressure. Hypertrophy of the muscular coat of the pyloric region is an infrequent congenital gastric anomaly in infants, preventing the passage of food into the bowel, and causing death

Physical abnormality.

TABLE II.

Males.	Per-centage.	Females.	Per-centage.	Total.	Per-centage.
1 Mouth and pharynx	37-85	1 Intestines	28-9	1 Oesophagus and stomach	31-78
2 Oesophagus and stomach	33-46	2 Oesophagus and stomach	27-7	2 Mouth and pharynx	30-27
3 Intestines	17-04	3 Liver	15-5	3 Intestines	20-42
4 Liver	7-8	4 Peritoneum	13-1	4 Liver	10-02
5 Peritoneum	2-75	5 Mouth and pharynx	11-3	5 Peritoneum	5-71
6 Pancreas	1-1	6 Pancreas	3-5	6 Pancreas	1-80

growth of members of the other. The species which produce acids are more resistant to the action of acids. Thus, when the contents of the stomach possess a normal or excessive proportion of free hydrochloric acid, a much larger number of putrefactive and pathogenic organisms in the food are destroyed or inhibited than of the bacteria of acid fermentation. Diminished gastric acidity allows of the entry of a greater number of putrefactive (and pathogenic) types, with, as a consequence, increased facilities for their growth and activity, and the appearance of intestinal derangements.

In a healthy new-born infant the mouth is free from micro-organisms, and very few are found in a breast-fed baby, but

More frequently dilatation of a section is met with, due as a rule to the presence of a stricture. The stomach often diverges from the normal in size, shape and position. Normally capable in the adult of containing from fifty to sixty ounces, either by reason of organic disease, or as the result of functional disturbance, its capacity may vary enormously. The writer has seen post mortem a stomach which held a gallon (160 ounces), and again one holding only two ounces. Cancer spread over a large area and cirrhosis of the stomach wall cause diminution in capacity; pyloric obstruction, weakness of the muscular coat, and nervous influences are associated with dilatation. A peculiar distortion of the shape of the stomach follows cicatrization of

and show no virulence when cultivated and injected into animals. The two common pyogenic organisms, *Staphylococcus albus* and *brevis*, show no virulence: Also the pneumococcus, though often present, must be raised in virulence before it can produce untoward results. The foulness of the mouth is supposed to be due to the colon bacillus and its allies, but those obtained from the mouth are innocuous. Also to enable the *Oidium albicans* to attack the mucous membrane there must be some slight inflammation or injury. The micro-organisms found in the stomach gain access to that organ in the food or by regurgitation from the small intestine. Most are relatively inert, but some have a special fermentative action on the food (see NUTRITION). Abelson isolated sixteen distinct species of organism from a healthy stomach, including Sarcinae, *B. lactis*, *pyocyanus*, *subtilis*, *lactis erythrogenes*, *amylobacter*, *megatherium*, and *Vibrio rugosa*.

ulcers of greater or lesser curvature; the gastric cavity becomes "hour-glass" in shape. In addition, the stomach may be displaced downwards as a whole, a condition known as gastropnoia; if the pyloric portion only be displaced, the lesion is termed pyloroptosis. Poses of other abdominal organs are described; the liver, transverse colon, spleen and kidneys may be involved. Displacements downwards of the stomach and transverse colon, along with a movable right kidney and associated with dyspepsia and neurasthenia, form the malady termed by Glénard enteroptosis. A general visceroptosis often occurs in those patients who have some tuberculous lesion of the lungs or elsewhere, this disease causing a general weakening and subsequent stretching of all ligaments. Displacements of the abdominal viscera are almost invariably accompanied by symptoms of dyspepsia of a neurotic type. The rectum is liable to prolapse, consequent upon constipation and straining at stool, or following local injuries of the perineal floor.

Every pathological lesion shown by digestive organs is closely associated with the state of the nervous system, general or local; *Influence of the nervous system.* so stoppage of active gastric digestive processes after profound nervous shock, and occurrence of nervous diarrhoea from the same cause. Gastric dyspepsia of nervous origin presents most varied and contradictory symptoms: diminished acidity of the gastric juice, hyper-acidity, over-production, arrest of secretion, lessened or increased movements, greater sensitiveness to the presence of contents, dilatation or spasm. Often the nervous cause can be traced back farther,—in females, frequently to the pelvic organs; in both sexes, to the condition of the blood, the brain or the bowel. Unhealthy conditions related to evacuation of the bowel—contents commonly induce reflex nervous manifestations of abnormal character referred to the stomach and liver. Gastric disturbances similarly react upon the proper conduct of intestinal functions.

Local Diseases.

The Mouth.—The lining membrane of the cheeks inside the mouth, of the gums and the under-surface and edges of the tongue, is often the seat of small irritable ulcers, usually associated with some digestive derangement. A crop of minute vesicles known as Koplik's spots over these parts has been lately stated by Koplik to be an early symptom of measles. Xerostomia, or dry mouth, is a rare condition, connected with lack of salivary secretion. Gangrenous stomatitis, cancrum oris, or noma, occasionally attacks debilitated children, or patients convalescing from acute fevers, more especially after measles. It commences in the gums or cheeks, and causes widespread sloughing of the adjacent soft parts—it may be of the bones.

The Stomach.—It were futile to attempt to enumerate all the protean manifestations of disturbance which proceed from a disordered stomach. The possible permutations and combinations of the causes of gastric vagaries almost reach infinity. Idiosyncrasy, past and present gastric education, penury or plethora, actual digestive power, motility, bodily requirements and conditions, environment, mental influences, local or adjacent organic lesions, and, not least, reflex impressions from other organs, all contribute to the variance.

Ulcer of the stomach, however,—the perforating gastric ulcer—occupies a unique position among diseases of this organ. Gastric ulcers are circumscribed, punched out, rarely larger than a sixpenny-bit, funnel-shaped, the narrower end towards the peritoneal coat, and distributed in those regions of the stomach wall which are most exposed to the action of the gastric contents. They occur most frequently in females, especially if anaemic, and are usually accompanied by excess of acid, actual or relative to the state of the blood, in the stomach contents. Local pain, dorsal pain, generally to the left of the eighth or ninth dorsal spinous process, and haematemesis and melaena, are symptomatic of it. The amount of blood lost varies with the rapidity of ulcer formation and the size of vessel opened into. Fatal results arise from ulceration into large blood-vessels, followed by copious haemorrhage, or by perforation of the ulcer into the peritoneal

cavity. Scars of such ulcers may be found post mortem, although no symptoms of gastric disease have been exhibited during life; gastric ulcers, therefore, may be latent.

Irritation of the sensory nerve-endings in the stomach wall from the presence of an increased proportion of acid, organic or mineral, in the stomach contents is accountable for the well-known symptom heartburn. Water-brash is a term applied to eructation of a colourless, almost tasteless fluid, probably saliva, which has collected in the lower part of the oesophagus from failure of the cardiac sphincter of the stomach to relax; reversed oesophageal peristalsis causing regurgitation. A similar reversed action serves in mercurism, or rumination, occasionally found in man, to raise part of the food, lately ingested, from the stomach to the mouth. Vomiting also is aided by reversed peristaltic action, both of the stomach and the oesophagus, with the help of the diaphragm and the muscles of the anterior abdominal wall. Emesis may be caused both by local nervous influence, and through the central nervous mechanism either reflexly or from the direct action of substances circulating in the blood. Further, the causal agent acting on the central nervous apparatus may be organic or functional, as well as medicinal. Vomiting without any apparent cause suggests nervous lesions, organic or reflex. The obstinate vomiting of pregnancy is a case in point. Here the primary cause proceeds reflexly from the pelvis. In females the pelvic organs are often the true source of emesis. Haematemesis accompanies gastric ulcer, cancer, chronic congestion with haemorrhagic erosion, congestion of the liver, or may follow violent acts of vomiting. In cases of ulcer the blood is usually bright and in considerable amount; in cancer, darker, like coffee-grounds; and in cases of erosion, in smaller quantity and of bright colour. The reaction of the stomach contents, if the cause be doubtful, yields valuable aid towards a diagnosis. Of increased acidity in gastric ulcer, normal in hepatic congestion, it is diminished in cancer; but as the acid present in cancer is largely lactic, analysis of the gastric contents must often be a *sine qua non*, because hyperacidity from lactic may obscure hyp acidity of hydrochloric acid.

Flatulence usually results from fermentative processes in the stomach and bowel, as the outcome of bacterial activity. A different form of flatulence is common in neurotic individuals; in such the gas evolved consists simply in carbonic acid liberated from the blood, and its evolution is generally characterized by rapid development and by lack of all fermentative signs.

The Liver.—The liver is an organ frequently libelled for the delinquencies of other organs, and regarded as a common source of ill. In catarrhal jaundice it is in most cases the bowel that is at fault, the liver acting properly, but unable to get rid of all the bile produced. The liver suffers, however, from several diseases of its own. Its fibrous or connective tissue is very apt to increase at the expense of the cellular elements, destroying their functions. This cirrhotic process usually follows long-continued irritation, such as is produced by too much alcohol absorbed from the bowel habitually, the organ gradually becoming harder in texture and smaller in bulk. Hypertrophic cirrhosis of the liver is not uncommonly met with, in which the liver is much increased in size, the "unilobular" form, also of alcoholic origin. In still-born children and in some infants a form of hypertrophic cirrhosis is occasionally seen, probably of hereditary syphilitic origin. Acute congestion of the liver forms an important symptom of malarial fever, and often leads in time to establishment of cirrhotic changes; here the liver is generally enlarged, but not invariably so, and the part played by alcohol in its causation has still to be investigated. Acute yellow atrophy of the liver is a disease *sui generis*. Of rare occurrence, possibly of toxic origin, it is marked by jaundice, at first of usual type, later becoming most intense; by vomiting; haemorrhages widely distributed; rapid diminution in the size of the liver; the appearance of leucin and tyrosin in the urine, with lessened urea; and in two or three days, death. The liver after death is soft, of a reddish colour dotted with yellow patches, and weighs only about a third part of the normal—about 1½ lb in place of 3½ lb. A closely analogous affection of the liver, known as Weil's disease, is of infectious type, and has been noted in

epidemic form. In this the spleen and liver are commonly but not always swollen, and the liver is often tender on pressure. As a large proportion of the sufferers from this disease have been butchers, and the epidemics have occurred in the hot season of the year, it probably arises from contact with decomposing animal matter. Hepatic abscess may follow on an attack of amoebic dysentery, and is produced either by infection through the portal vein, or by direct infection from the adjacent colon. In general pyaemia multiple small abscesses may occur in the liver.

The Gall-Bladder.—The formation of biliary calculi in the gall-bladder is the chief point of interest here. At least 75% of such cases occur in women, especially in those who have borne children. Tight-lacing has been stated to act as an exciting cause, owing to the consequent retardation of the flow of bile. Gall-stones may number from one to many thousands. They are largely composed of cholesterin, combined with small amounts of bile-pigments and acids, lime and magnesium salts. Their presence may give rise to no symptoms, or may cause violent biliary colic, and, if the bile-stream be obstructed, to jaundice. Inflammatory processes may be initiated in the gall-bladder or the bile-ducts, catarrhal or suppurative in character.

The Pancreas.—Haemorrhages into the body of the pancreas, acute and chronic inflammation, calculi, cysts and tumours, among which cancer is by far the most common, are recognized as occurring in this organ; the point of greatest interest regarding them lies in the relations established between pancreatic disease and diabetes mellitus, affections of the gland frequently being complicated by, and probably causing, the appearance of sugar in the urine.

The Small Intestine.—Little remains to be added to the account of inflammatory lesions in connexion with the small intestine. It offers but few conditions peculiar to itself, save in typhoid fever, and the ease with which it contrives to become kinked, or intussuscepted, producing obstruction, or to take part in hernial protrusions. The first section, the duodenum, is subject to development of ulcers very similar to those of the gastric mucous membrane. For long duodenal ulceration has been regarded as a complication of extensive burns of the skin, but the relationship between them has not yet been quite satisfactorily explained. The condition of colic in the bowel usually arises from over-distension of some part of the small gut with gas, the frequent sharp turns of the gut facilitating temporary closure of its lumen by pressure of the dilated gut near a curve against the part beyond. In the large bowel accumulations of gas seldom cause such acute symptoms, having a readier exit.

The Large Intestine.—The colon, especially the ascending portion, may become immensely dilated, usually after prolonged constipation and paralysis of the gut; occasionally the condition is congenital. Straining efforts made in defaecation may often account for prolapse of the lower end of the rectum through the anus. Haemorrhage from the bowel is usually a sign of disease situated in the large intestine: if bright in colour, the source is probably low down; if dark, from the caecum or from above the ileo-caecal valve. Blood after a short stay in any section of the alimentary canal darkens, and eventually becomes almost black in colour. (A. L. G.; M. F.)*

DIGGES, WEST (1720–1786), English actor, made his first stage appearance in Dublin in 1749 as Jaffer in *Venice Preserved*; and both there and in Edinburgh until 1764 he acted in many tragic rôles with success. He was the original "young Norval" in Home's *Douglas* (1756). His first London appearance was as Cato in the Haymarket in 1777, and he afterwards played Lear, Macbeth, Shylock and Wolsey. In 1881 he returned to Dublin and retired in 1784.

DIGIT (Lat. *digitus*, finger), literally a finger or toe, and so used to mean, from counting on the fingers, a single numeral, or, from measuring, a finger's breadth. In astronomy a digit is the twelfth part of the diameter of the sun or moon; it is used to express the magnitude of an eclipse.

DIGITALIS. The leaves of the foxglove (*s.s.*), gathered from wild plants when about two-thirds of their flowers are expanded,

deprived usually of the petiole and the thicker part of the midrib, and dried, constitute the drug *digitalis* or *digitalis folia* of the Pharmacopoeia. The prepared leaves have a faint odour and bitter taste; and to preserve their properties they must be kept excluded from light in stoppered bottles. They are occasionally adulterated with the leaves of *Inula Conyza*, ploughman's spikenard, which may be distinguished by their greater roughness, their less divided margins, and their odour when rubbed; also with the leaves of *Symphylum officinale*, comfrey, and of *Verbascum Thapsus*, great mullein, which unlike those of the foxglove have woolly upper and under surfaces. The earliest known descriptions of the foxglove are those given by Leonhard Fuchs and Tragus about the middle of the 16th century, but its virtues were doubtless known to herbalists at a much remoter period. J. Gerarde, in his *Herbal* (1597), advocates the use of foxglove for a variety of complaints; and John Parkinson, in the *Theatrum Botanicum, or Theater of Plants* (1640), and later W. Salmon, in *The New London Dispensatory*, similarly praised the remedy. Digitalis was first brought prominently under the notice of the medical profession by Dr W. Withering, who, in his *Account of the Foxglove* (1785), gave details of upwards of 200 cases chiefly dropsical, in which it was used.

Digitalis contains four important glucosides, of which three are cardiac stimulants. The most powerful is *digitoxin* $C_{41}H_{64}O_{11}$, an extremely poisonous and cumulative drug, insoluble in water. *Digitalin*, $C_{33}H_{56}O_{10}$, is crystalline and is also insoluble in water. *Digitalein* is amorphous but readily soluble in water. It can therefore be administered subcutaneously, in doses of about one-hundredth of a grain. *Digitonin*, on the other hand, is a cardiac depressant, and has been found to be identical with saponin, the chief constituent of senega root. There are numerous preparations, patent and pharmacopoeial, their composition being extremely varied, so that, unless one has reason to be certain of any particular preparation, it is almost better to use only the dried leaves themselves in the form of a powder (dose ½–2 grains). The pharmacopoeial tincture may be given in doses of five to fifteen minims, and the infusion has the unusually small dose of two to four drachms—the dose of other infusions being an ounce or more. The tincture contains a fair proportion of both digitalin and digitoxin.

Digitalis leaves have no definite external action. Taken by the mouth, the drug is apt to cause considerable digestive disturbance, varying in different cases and sometimes so severe as to cause serious difficulty. This action is probably due to the digitonin, which is thus a constituent in every way undesirable. The all-important property of the drug is its action on the circulation. Its first action on any of the body-tissues is upon unstriated muscle, so that the first consequence of its absorption is a contraction of the arteries and arterioles. No other known drug has an equally marked action in contracting the arterioles. As the vaso-motor centre in the medulla oblongata is also stimulated, as well as the contractions of the heart, there is thus trebly caused a very great rise in the blood-pressure.

The clinical influence of digitalis upon the heart is very well defined. After the taking of a moderate dose the pulse is markedly slowed. This is due to a very definite influence upon the different portions of the cardiac cycle. The systole is not altered in length, but the diastole is very much prolonged, and since this is the period not only of cardiac rest but also of cardiac "feeding"—the coronary vessels being compressed and occluded during systole—the result is greatly to benefit the nutrition of the cardiac muscle. So definite is this that, despite a great increase in the force of the contractions and despite experimental proof that the heart does more work in a given time under the influence of digitalis, the organ subsequently displays all the signs of having rested, its improved vigour being really due to its obtaining a larger supply of the nutrient blood. Almost equally striking is the fact that digitalis causes an irregular pulse to become regular. Added to the greater force of cardiac contraction is a permanent tonic contraction of the organ, so that its internal capacity is reduced. The bearing of this fact on cases of cardiac dilatation is evident. In larger doses a remarkable sequel to these actions

may be observed. The cardiac contractions become irregular, the ventricle assumes curious shapes—"hour-glass," &c.—becomes very pale and bloodless, and finally the heart stops in a state of spasm, which shortly afterwards becomes rigor-mortis. Before this final change the heart may be started again by the application of a soluble potassium salt, or by raising the fluid pressure within it. Clinically it is to be observed that the drug is cumulative, being very slowly excreted, and that after it has been taken for some time the pulse may become irregular, the blood-pressure low, and the cardiac pulsations rapid and feeble. These symptoms with more or less gastro-intestinal irritation and decrease in the quantity of urine passed indicate digitalis poisoning. The initial action of digitalis is a stimulation of the cardiac terminals of the vagus nerves, so that the heart's action is slowed. Thereafter follows the most important effect of the drug, which is a direct stimulation of the cardiac muscle. This can be proved to occur in a heart so embryonic that no nerves can be recognized in it, and in portions of cardiac muscle that contain neither nerve-cells nor nerve-fibres.

The action of this drug on the kidney is of importance only second to its action on the circulation. In small or moderate doses it is a powerful diuretic. Though Heidenhain asserts that rise in the renal blood-pressure has not a diuretic action *per se*, it seems probable that this influence of the drug is due to a rise in the general blood-pressure associated with a relatively dilated condition of the renal vessels. In large doses, on the other hand, the renal vessels also are constricted and the amount of urine falls. It is probable that digitalis increases the amount of water rather than that of the urinary solids. In large doses the action of digitalis on the circulation causes various cerebral symptoms, such as seeing all objects blue, and various other disturbances of the special senses. There appears also to be a specific action of lowering the reflex excitability of the spinal cord.

Digitalis is used in therapeutics exclusively for its action on the circulation. In prescribing this drug it must be remembered that fully three days elapse before it gets into the system, and thus it must always be combined with other remedies to tide the patient over this period. It must never be prescribed in large doses to begin with, as some patients are quite unable to take it, intractable vomiting being caused. The three days that must pass before any clinical effect is obtained renders it useless in an emergency. A certain consequence of its use is to cause or increase cardiac hypertrophy—a condition which has its own dangers and ultimately disastrous consequences, and must never be provoked beyond the positive needs of the case. But digitalis is indicated whenever the heart shows itself unequal to the work it has to perform. This formula includes the vast majority of cardiac cases. The drug is contra-indicated in all cases where the heart is already beating too slowly; in aortic incompetence—where the prolongation of diastole increases the amount of the blood that regurgitates through the incompetent valve; in chronic Bright's disease and in fatty degeneration of the heart—since nothing can cause fat to become contractile.

DIGNE, the chief town of the department of the Basses Alpes, in S.E. France, 14 m. by a branch line from the main railway line between Grenoble and Avignon. Pop. (1906), town, 4628; commune, 7456. The Ville Haute is built on a mountain spur running down to the left bank of the Bléone river, and is composed of a labyrinth of narrow winding streets, above which towers the present cathedral church, dating from the end of the 15th century, but largely reconstructed in modern times; and the former bishop's palace (now the prison). The fine Boulevard Gassendi separates the Ville Haute from the Ville Basse, which is of modern date. The old cathedral (Notre Dame du Bourg) is a building of the 13th century, but is now disused except for funerals: it stands at the east end of the Ville Basse. The neighbourhood of Digne is rich in orchards, which have long made the town famous in France for its preserved fruits and confections. It is the *Diosia* of the Romans, and was the capital of the Bodionti. From the early 6th century at least it has been an episcopal see, which till 1790 was in the ecclesiastical province of Embrun, but since 1802 in that of Aix en Provence. The history of Digne in the middle

ages is bound up with that of its bishops, under whom it prospered greatly. But it suffered much during the religious wars of the 16th and 17th centuries, when it was sacked several times. A little way off, above the right bank of the Bléone, is Champstercier, the birthplace of the astronomer Gassendi (1592-1655), whose name has been given to the principal thoroughfare of the little town.

See F. Guichard, *Souvenirs historiques sur la ville de Digne et ses environs* (Digne, 1847). (W. & A. B. C.)

DIGOIN, a town of east-central France, in the department of Saône-et-Loire, on the right bank of the Loire, 55 m. W.N.W. of Mâcon on the Paris-Lyon railway. Pop. (1906) 5321. It is situated at the meeting places of the Loire, the Lateral canal of the Loire and the Canal du Centre, which here crosses the Loire by a fine aqueduct. The town carries on considerable manufactures of faience, pottery and porcelain. The port on the Canal du Centre has considerable traffic in timber, sand, iron, coal and stone.

DIJON, a town of eastern France, capital of the department of Côte d'Or and formerly capital of the province of Burgundy, 195 m. S.E. of Paris on the Paris-Lyon railway. Pop. (1906) 65,516. It is situated on the western border of the fertile plain of Burgundy, at the foot of Mont Afrique, the north-eastern summit of the Côte d'Or range, and at the confluence of the Ouche and the Suzon; it also has a port on the canal of Burgundy. The great strategic importance of Dijon as a centre of railways and roads, and its position with reference to an invasion of France from the Rhine, have led to the creation of a fortress forming part of the Langres group. There is no *enceinte*, but on the east side detached forts, 3 to 4 m. distant from the centre, command all the great roads, while the hilly ground to the west is protected by Fort Hauteville to the N.W. and the "groups" of Motte Giron and Mont Afrique to the S.W., these latter being very formidable works. Including a fort near Saussy (about 8 m. to the N.W.) protecting the water-supply of Dijon, there are eight forts, besides the groups above mentioned. The fortifications which partly surrounded the old and central portion of the city have disappeared to make way for tree-lined boulevards with fine squares at intervals. The old churches and historic buildings of Dijon are to be found in the irregular streets of the old town, but industrial and commercial activity has been transferred to the new quarters beyond its limits. A fine park more than 80 acres in extent lies to the south of the city, which is rich in open spaces and promenades, the latter including the botanical garden and the Promenade de l'Arquebuse, in which there is a black poplar famous for its size and age.

The cathedral of St Bénigne, originally an abbey church, was built in the latter half of the 13th century on the site of a Romanesque basilica, of which the crypt remains. The west front is flanked by two towers and the crossing is surmounted by a slender timber spire. The plan consists of three naves, short transepts and a small choir, without ambulatory, terminating in three apses. In the interior there is a fine organ and a quantity of statuary, and the vaults contain the remains of Philip the Bold, duke of Burgundy, and Anne of Burgundy, daughter of John the Fearless. The site of the abbey buildings is occupied by the bishop's palace and an ecclesiastical seminary. The church of Notre-Dame, typical of the Gothic style of Burgundy, was erected from 1252 to 1334, and is distinguished for the grace of its interior and the beauty of the western façade. The portal consists of three arched openings, above which are two stages of arcades, open to the light and supported on slender columns. A row of gargoyles surmounts each storey of the façade, which is also ornamented by sculptured friezes. A turret to the right of the portal carries a clock called the Jaquemart, on which the hours are struck by two figures. The church of St Michel belongs to the 15th century. The west façade, the most remarkable feature of the church, is, however, of the Renaissance period. The vaulting of the three portals is of exceptional depth owing to the projection of the lower storey of the façade. Above this storey rise two towers of five stages, the fifth stage being formed by an octagonal cupola. The columns decorating the façade represent all the four orders. The design of this façade is wrongly attributed to Hugues

Sambin (fl. c. 1540), a native of Dijon, and pupil of Leonardo da Vinci, but the sculpture of the portals, including "The Last Judgment" on the tympanum of the main portal, is probably from his hand. St Jean (15th century) and St Étienne (15th, 16th and 17th centuries), now used as the exchange, are the other chief churches. Of the ancient palace of the dukes of Burgundy there remain two towers, the Tour de la Terrasse and the Tour de Bar, the guard-room and the kitchens; these now form part of the hôtel de ville, the rest of which belongs to the 17th and 18th centuries. This building contains an archaeological museum with a collection of Roman stone monuments; the archives of the town; and the principal museum, which, besides valuable paintings and other works of art, contains the magnificent tombs of Philip the Bold and John the Fearless, dukes of Burgundy. These were transferred from the Chartreuse of Dijon (or of Champmol), built by Philip the Bold as a mausoleum, now replaced by a lunatic asylum. Relics of it survive in the old Gothic entrance, the portal of the church, a tower and the well of Moses, which is adorned with statues of Moses and the prophets by Claux Sluter (fl. end of 14th century), the Dutch sculptor, who also designed the tomb of Philip the Bold. The Palais de Justice, which belongs to the reign of Louis XII., is of interest as the former seat of the *parlement* of Burgundy. Dijon possesses several houses of the 15th, 16th and 17th centuries, notably the Maison Richard in the Gothic, and the Hôtel Vogüé in the Renaissance style. St Bernard, the composer J. P. Rameau and the sculptor François Rude have statues in the town, of which they were natives. There are also monuments to those inhabitants of Dijon who fell in the engagement before the town in 1870, and to President Carnot and Garibaldi.

The town is important as the seat of a prefecture, a bishopric, a court of appeal and a court of assizes, and as centre of an *académie* (educational district). There are tribunals of first instance and of commerce, a board of trade-arbitrators, a chamber of commerce, an exchange (occupying the former cathedral of St Étienne), and an important branch of the Bank of France. Its educational establishments include faculties of law, of science and of letters, a preparatory school of medicine and pharmacy, a higher school of commerce, a school of fine art, a conservatoire of music, *lycées* and training colleges, and there is a public library with about 100,000 volumes.

Dijon is well known for its mustard, and for the black currant liqueur called *cassis de Dijon*; its industries include the manufacture of machinery, automobiles, bicycles, soap, biscuits, brandy, leather, boots and shoes, candles and hosiery. There are also flour mills, breweries, important printing works, vinegar works and, in the vicinity, nursery gardens. The state has a large tobacco manufactory in the town. Dijon has considerable trade in cereals and wool, and is the second market for the wines of Burgundy.

Under the Romans Dijon (*Disonense castrum*) was a *vicus* in the *civitas* of Langres. In the 2nd century it was the scene of the martyrdom of St Benignus (Bénigne, *vulg.* Berin, Berain), the apostle of Burgundy. About 274 the emperor Aurelian surrounded it with ramparts. Gregory of Tours, in the 6th century, comments on the strength and pleasant situation of the place, expressing surprise that it does not rank as a *civitas*. During the middle ages the fortunes of Dijon followed those of Burgundy, the dukes of which acquired it early in the 11th century. The communal privileges, conferred on the town in 1182 by Hugh III., duke of Burgundy, were confirmed by Philip Augustus in 1183, and in the 13th century the dukes took up their residence there. For the decoration of the palace and other monuments built by them, eminent artists were gathered from northern France and Flanders, and during this period the town became one of the great intellectual centres of France. The union of the duchy with the crown in 1477 deprived Dijon of the splendour of the ducal court; but to counterbalance this loss it was made the capital of the province and seat of a *parlement*. Its fidelity to the monarchy was tested in 1513, when the citizens were besieged by 50,000 Swiss and Germans, and forced to agree to a treaty so disadvantageous that Louis XII.

refused to ratify it. In the wars of religion Dijon sided with the League, and only opened its gates to Henry IV. in 1595. The 18th century was a brilliant period for the city; it became the seat of a bishopric, its streets were improved, its commerce developed, and an academy of science and letters founded; while its literary salons were hardly less celebrated than those of Paris. The neighbourhood was the scene of considerable fighting during the Franco-German War, which was, however, indirectly of some advantage to the city owing to the impetus given to its industries by the immigrants from Alsace.

See H. Chabeuf, *Dijon à travers les âges* (Dijon, 1897), and *Dijon, monuments et souvenirs* (Dijon, 1894).

DIKE, or **DYKE** (Old Eng. *dic*, a word which appears in various forms in many Teutonic languages, cf. Dutch *dijk*, German *Teich*, Danish *dige*, and in French, derived from Teutonic, *digue*; it is the same word as "ditch" and is ultimately connected with the root of "dig"), properly a trench dug out of the earth for defensive and other purposes. Water naturally collects in such trenches, and hence the word is applied to natural and artificial channels filled with water, as appears in the proverbial expression "February fill-dyke," and in the names of many narrow waterways in East Anglia. "Dike" also is naturally used of the bank of earth thrown up out of the ditch, and so of any embankment, dam or causeway, particularly the defensive works in Holland, the Fen district of England, and other low-lying districts which are liable to flooding by the sea or rivers (see **HOLLAND** and **FENS**). In Scotland any wall, fence or even hedge, used as a boundary is called a dyke. In geology the term is applied to wall-like masses or rock (sometimes projecting beyond the surrounding surface) which fill up vertical or highly inclined fissures in the strata.

DIKKA, a term in Mahomedan architecture for the tribune raised upon columns, from which the Koran is recited and the prayers intoned by the Imam of the mosque.

DILAPIDATION (Lat. for "scattering the stones," *lapides*, of a building), a term meaning in general a falling into decay, but more particularly used in the plural in English law for (1) the waste committed by the incumbent of an ecclesiastical living; (2) the disrepair for which a tenant is usually liable when he has agreed to give up his premises in good repair (see **EASEMENT**; **FLAT**; **LANDLORD** and **TENANT**). By the general law a tenant for life has no power to cut down timber, destroy buildings, &c. (voluntary waste), or to let buildings fall into disrepair (permissive waste). In the eye of the law an incumbent of a living is a tenant for life of his benefice, and any waste, voluntary or permissive, on his part must be made good by his administrators to his successor in office. The principles on which such dilapidations are to be ascertained, and the application of the money payable in respect thereof, depend partly on old ecclesiastical law and partly on acts of parliament. Questions as to ecclesiastical dilapidations usually arise in respect of the residence house and other buildings belonging to the living. Inclosures, hedges, ditches and the like are included in things "of which the benefited person hath the burden and charge of reparation." In a leading case (*Ross v. Adcock*, 1868, L.R. 3 C.P. 657) it was said that the court was acquainted with no precedent or decision extending the liability of the executors of a deceased incumbent to any species of waste beyond dilapidation of the house, chancel or other buildings or fences of the benefice. And it has been held that the mere mismanagement or miscultivation of the ecclesiastical lands will not give rise to an action for dilapidations. To place the law relating to dilapidations on a more satisfactory footing, the Ecclesiastical Dilapidations Act 1871 was passed. The buildings to which the act applies are defined to be such houses of residence, chancels, walls, fences and other buildings and things as the incumbent of the benefice is by law and custom bound to maintain in repair. In each diocese a surveyor is appointed by the archdeacons and rural deans subject to the approval of the bishop; and such surveyor shall by the direction of the bishop examine the buildings on the following occasions—viz. (1) when the benefice is sequestrated; (2) when it is vacant; (3) at the request of the incumbent or on complaint by the archdeacon, rural dean or patron. The surveyor specifies the works required, and gives an

estimate of their probable cost. In the case of a vacant benefice, the new incumbent and the old incumbent or his representatives may lodge objections to the surveyor's report on any grounds of fact or law, and the bishop, after consideration, may make an order for the repairs and their cost, for which the late incumbent or his representatives are liable. The sum so stated becomes a debt due from the late incumbent or his representatives to the new incumbent, who shall pay over the money when recovered to the governors of Queen Anne's Bounty. The governors pay for the works on execution on receipt of a certificate from the surveyor; and the surveyor, when the works have been completed to his satisfaction, gives a certificate to that effect, the effect of which, so far as regards the incumbent, is to protect him from liability for dilapidations for the next five years. Unnecessary buildings belonging to a residence house may, by the authority of the bishop and with the consent of the patron, be removed. An amending statute of 1872 (Ecclesiastical Dilapidations Act (1872) Amendment) relates chiefly to advances by the governors of Queen Anne's Bounty for the purposes of the act.

DILATATION (from Lat. *dis*, distributive, and *latus*, wide), a widening or enlarging; a term used in physiology, &c.

DILATORY (from Lat. *dilatus*, from *differre*, to put off or delay), delaying, or slow; in law a "dilatatory plea" is one made merely for delaying the suit.

DILEMMA (Gr. *δίλημμα*, a double proposition, from *δί-* and *λέγωμαι*), a term used technically in logic, and popularly in common parlance and rhetoric. (1) The latter use has no exact definition, but in general it describes a situation wherein from either of two (or more) possible alternatives an unsatisfactory conclusion results. The alternatives are called the "horns" of the dilemma. Thus a nation which has to choose between bankruptcy and the repudiation of its debts is on the horns of a dilemma. (2) In logic there is considerable divergence of opinion as to the best definition. Whately defined it as "a conditional syllogism with two or more antecedents in the major and a disjunctive minor." Aulus Gellius gives an example as follows:—"Women are either fair or ugly; if you marry a fair woman, she will attract other men; if an ugly woman she will not please you; therefore marriage is absurd." From either alternative, an unpleasant result follows. Four kinds of dilemma are admitted:—(a) *Simple Constructive*: If A, then C; if B, then C, but either B or A; therefore C. (b) *Simple Destructive*: If A is true, B is true; if A is true, C is true; B and C are not both true; therefore A is not true. (c) *Complex Constructive*: If A, then B; if C, then D; but either A or C; therefore either B or D. (d) *Complex Destructive*: If A is true, B is true; if C is true, D is true; but B and D are not both true; hence A and C are not both true. The soundness of the dilemmatic argument in general depends on the alternative possibilities. Unless the alternatives produced exhaust the possibilities of the case, the conclusion is invalid. The logical form of the argument makes it especially valuable in public speaking, before uncritical audiences. It is, in fact, important rather as a rhetorical subtlety than as a serious argument.

Dilemmist is also a term used to translate *Vaidikashikas*, the name of a Buddhist school of philosophy.

DILETTANTE, an Italian word for one who delights in the fine arts, especially in music and painting, so a lover of the fine arts in general. The Ital. *dilettare* is from Lat. *delectare*, to delight. Properly the word refers to an "amateur" as opposed to a "professional" cultivation of the arts, but like "amateur" it is often used in a depreciatory sense for one who is only a dabbler, or who only has a superficial knowledge or interest in art. The Dilettanti Society founded in 1733-1734 still exists in England. A history of the society, by Lionel Cust, was published in 1898.

DILIGENCE, in law, the care which a person is bound to exercise in his relations with others. The possible degrees of diligence are of course numerous, and the same degree is not required in all cases. Thus a mere depositary would not be held bound to the same degree of diligence as a person borrowing an article for his own use and benefit. Jurists, following the divisions of the civil law, have concurred in fixing three approximate

standards of diligence—*vis.* ordinary (*diligentia*), less than ordinary (*levissima diligentia*) and more than ordinary (*exactissima diligentia*). Ordinary or common diligence is defined by Story (*On Bailments*) as "that degree of diligence which men in general exert in respect of their own concerns." So Sir William Jones:—"This care, which every person of common prudence and capable of governing a family takes of his own concerns, is a proper measure of that which would uniformly be required in performing every contract, if there were not strong reasons for exacting in some of them a greater and permitting in others a less degree of attention" (*Essay on Bailments*). The highest degree of diligence would be that which only very prudent persons bestow on their own concerns; the lowest, that which even careless persons bestow on their own concerns. The want of these various degrees of diligence is negligence in corresponding degrees. These approximations indicate roughly the greater or less severity with which the law will judge the performance of different classes of contracts; but English judges have been inclined to repudiate the distinction as a useless refinement of the jurists. Thus Baron Rolfe could see no difference between negligence and gross negligence; it was the same thing with the addition of a vituperative epithet. See **NEGLECTANCE**.

Diligence, in Scots law, is a general term for the process by which persons, lands or effects are attached on execution, or in security for debt.

DILKE, SIR CHARLES WENTWORTH, BART. (1810-1860), English politician, son of Charles Wentworth Dilke, proprietor and editor of *The Athenaeum*, was born in London on the 18th of February 1810, and was educated at Westminster school and Trinity Hall, Cambridge. He studied law, and in 1834 took his degree of LL.B., but did not practise. He assisted his father in his literary work, and was for some years chairman of the council of the Society of Arts, besides taking a prominent part in the affairs of the Royal Horticultural Society and other bodies. He was one of the most zealous promoters of the Great Exhibition (1851), and a member of the executive committee. At the close of the exhibition he was honoured by foreign sovereigns, and the queen offered him knighthood, which, however, he did not accept; he also declined a large remuneration offered by the royal commission. In 1853 Dilke was one of the English commissioners at the New York International Exhibition, and prepared a report on it. He again declined to receive any money reward for his services. He was appointed one of the five royal commissioners for the Great Exhibition of 1862; and soon after the death of the prince consort he was created a baronet. In 1865 he entered parliament as member for Wallingford. In 1869 he was sent to Russia as representative of England at the horticultural exhibition held at St Petersburg. His health, however, had been for some time failing, and he died suddenly in that city, on the 10th of May 1869. A selection from his writings, *Papers of a Critic* (2 vols., 1875), contains a biographical sketch by his son.

His son, **SIR CHARLES WENTWORTH DILKE, BART.** (1843-), became a prominent Liberal politician, as M.P. for Chelsea (1868-1886), under-secretary for foreign affairs (1880-1882), and president of the local government board (1882-1885); and he was then marked out as one of the best-informed and ablest of the advanced Radicals. He was chairman of the royal commission on the housing of the working classes in 1884-1885. But his sensational appearance as co-respondent in a divorce case of a peculiarly unpleasant character in 1885 cast a cloud over his career. He was defeated in Chelsea in 1886, and did not return to parliament till 1892, when he was elected for the Forest of Dean; and though his knowledge of foreign affairs and his powers as a critic and writer on military and naval questions were admittedly of the highest order, his official position in public life could not again be recovered. His military writings are *The British Army* (1888); *Army Reform* (1898) and, with Mr Spenser Wilkinson, *Imperial Defence* (1892). On colonial questions he wrote with equal authority. His *Greater Britain* (2 vols., 1866-1867) reached a fourth edition in 1868, and was followed by *Problems of Greater Britain* (2 vols., 1890) and *The British Empire* (1899). He was twice married, his second wife

Emilia Frances Strong), the widow of Mark Pattison, being an accomplished art critic and collector. She died in 1904. The most important of her books were the studies on *French Painters of the Eighteenth Century* (1899) and three subsequent volumes on the architects and sculptors, furniture and decoration, engravers and draughtsmen of the same period, the last of which appeared in 1902. A posthumous volume, *The Book of the Spiritual Life* (1905), contains a memoir of her by Sir Charles Dilke.

DILL (*Anethum* or *Peucedanum graveolens*), a member of the natural botanical order Umbelliferae, indigenous to the south of Europe, Egypt and the Cape of Good Hope. It resembles fennel in appearance. Its root is long and fusiform; the stem is round, jointed and about a yard high; the leaves have fragrant leaflets;



Dill (*Anethum* or *Peucedanum graveolens*), leaf and inflorescence.

and the fruits are brown, oval and concavo-convex. The plant flowers from June till August in England. The seeds are sown, preferably as soon as ripe, either broadcast or in drills between 6 and 12 in. asunder. The young plants should be thinned when 3 or 4 weeks old, so as to be at distances of about 10 in. A sheltered spot and dry soil are needed for the production of the seed in the climate of England. The leaves of the dill are used in soups and sauces, and, as well as the umbels, for flavouring pickles. The seeds are employed for the preparation of dill-water and oil of dill; they are largely consumed in the manufacture of gin, and, when ground, are eaten in the East as a condiment. The British Pharmacopoeia contains the Aqua Anethi or dill-water (dose 1-2 oz.), and the Oleum Anethi, almost identical in composition with caraway oil, and given in doses of ½-3 minims. Dill-water is largely used as a carminative for children, and as a vehicle for the exhibition of nauseous drugs.

DILLEN [DILLENUS], **JOHANN JAKOB** (1684-1747), English botanist, was born at Darmstadt in 1684, and was educated at the university of Giessen, where he wrote several botanical papers for the *Ephemerides naturae curiosorum*, and printed, in 1719, his *Catalogus plantarum sponte circa Gissam nascentium*, illustrated with figures drawn and engraved by his own hand, and containing descriptions of many new species. In 1721, at the instance of the botanist William Sherard (1659-1728), he came to England, and in 1724 he published a new edition of Ray's *Synopsis stirpium Britannicarum*. In 1732 he published *Horius Elthamensis*, a catalogue of the rare plants growing at Eltham, Kent, in the collection of Sherard's younger brother, James (1666-1738), who, after making a fortune as an apothecary, devoted himself to gardening and music. For this work Dillen himself executed 324 plates, and it was described by Linnaeus, who spent a month with him at Oxford in 1736, and afterwards dedicated his *Critica botanica* to him, as "opus botanicum quo absolutius mundus non vidit." In 1734 he was appointed Sherardian professor of botany at Oxford, in accordance with the will of W. Sherard, who at his death in 1728 left the university £3000 for the endowment of the chair, as well as his library and herbarium. Dillen, who was also the author of an *Historia muscorum* (1741), died at Oxford, of apoplexy, on the 2nd of April 1747. His manuscripts, books and collections of dried plants, with many drawings, were bought by his successor at Oxford, Dr Humphry Sibthorp (1713-1797), and ultimately passed into the possession of the university.

For an account of his collections preserved at Oxford, see *The Dillenan Herbaria*, by G. Claridge Druce (Oxford, 1907).

DILLENBURG, a town of Germany, in the Prussian province of Hesse-Nassau, delightfully situated in the midst of a well-wooded country, on the Dill, 25 m. N.W. from Giessen on the railway to Treisdorf. Pop. 4500. On an eminence above it lie the ruins of the castle of Dillenburg, founded by Count Henry the Rich

of Nassau, about the year 1255, and the birthplace of Prince William of Orange (1533). It has an Evangelical church, with the vault of the princes of Nassau-Dillenburg, a Roman Catholic church, a classical school, a teachers' seminary and a chamber of commerce. Its industries embrace iron-works, tanneries and the manufacture of cigars. Owing to its beautiful surroundings Dillenburg has become a favourite summer resort.

DILLENS, JULIEN (1849-1904), Belgian sculptor, was born at Antwerp on the 8th of June 1849, son of a painter. He studied under Eugène Simonis at the Brussels Academy of Fine Arts. In 1877 he received the *prix de Rome* for "A Gaulish Chief taken Prisoner by the Romans." At Brussels, in 1881, he executed the groups entitled "Justice" and "Herkenbald, the Brussels Brutus." For the pediment of the orphanage at Uccle, "Figure Kneeling" (Brussels Gallery), and the statue of the lawyer Metdepennigen in front of the Palais de Justice at Ghent, he was awarded the medal of honour in 1889 at the Paris Universal Exhibition, where, in 1900, his "Two Statues of the Anspach Monument" gained him a similar distinction. For the town of Brussels he executed "The Four Continents" (Maison du Renard, Grand' Place), "The Lansquenet" crowning the lucarnes of the Maison de Roi, and the "Monument t' Serclae" under the arcades of the Maison de l'Etoile, and, for the Belgian government, "Flemish Art," "German Art," "Classic Art" and "Art applied to Industry" (all in the Palais des Beaux Arts, Brussels), "The Laurel" (Botanic Garden, Brussels), and the statue of "Bernard van Orley" (Place du petit Sablon, Brussels). Mention must also be made of "An Enigma" (1876), the bronze busts of "Rogier de la Pasture" and "P. P. Rubens" (1879), "Etruria" (1880), "The Painter Leon Frederic" (1888), "Madame Leon Herbo," "Hermes," a scheme of decoration for the original façade of the hôtel de ville at Ghent (1893), "The Genius of the Funeral Monument of the Moselli Family," "The Silence of Death" (for the entrance of the cemetery of St Gilles), two caryatides for the town hall of St Gilles, presentation plaquette to Dr Heger, medals of MM. Godefroid and Vanderkinderen and of "The Three Burgomasters of Brussels," and the ivories "Allegretto," "Minerva" and the "Jamaer Memorial." Dillens died at Brussels in November 1904.

DILLINGEN, a town of Germany, in the kingdom of Bavaria, on the left bank of the Danube, 25 m. N.E. from Ulm, on the railway to Ingolstadt. Pop. (1905) 6078. Its principal buildings are an old palace, formerly the residence of the bishops of Augsburg and now government offices, a royal gymnasium, a Latin school with a library of 75,000 volumes, seven churches (six Roman Catholic), two episcopal seminaries, a Capuchin monastery, a Franciscan convent and a deaf and dumb asylum. The university, founded in 1549, was abolished in 1804, being converted into a lyceum. The inhabitants are engaged in cattle-rearing, the cultivation of corn, hops and fruit, shipbuilding and the shipping trade, and the manufacture of cloth, paper and cutlery. In the vicinity is the Karolinen canal, which cuts off a bend in the Danube between Lauingen and Dillingen. In 1488 Dillingen became the residence of the bishops of Augsburg; was taken by the Swedes in 1632 and 1648, by the Austrians in 1702, and on the 17th of June 1800 by the French. In 1803 it passed to Bavaria.

DILLMANN, CHRISTIAN FRIEDRICH AUGUST (1823-1894), German orientalist and biblical scholar, the son of a Württemberg schoolmaster, was born at Illingen on the 25th of April 1823. He was educated at Tübingen, where he became a pupil and friend of Heinrich Ewald, and studied under F. C. Baur, though he did not join the new Tübingen school. For a short time he worked as pastor at Gersheim, near his native place, but he soon came to feel that his studies demanded his whole time. He devoted himself to the study of Ethiopic MSS. in the libraries of Paris, London and Oxford, and this work caused a revival of Ethiopic study in the 19th century. In 1847 and 1848 he prepared catalogues of the Ethiopic MSS. in the British Museum and the Bodleian library at Oxford. He then set to work upon an edition of the Ethiopic bible. Returning to Tübingen in 1848, in 1853 he was appointed professor extraordinary. Subsequently he became

professor of philosophy at Kiel (1854), and of theology at Giessen (1864) and Berlin (1869). He died on the 4th of July 1894.

In 1851 he had published the *Book of Enoch* in Ethiopian (German, 1853), and at Kiel he completed the first part of the Ethiopic bible, *Oclateucus Aethiopicus* (1853-1855). In 1857 appeared his *Grammatik der äthiopischen Sprache* (2nd ed. by C. Bezold, 1899); in 1859 the *Book of Jubilees*; in 1861 and 1871 another part of the Ethiopic bible, *Libri Regum*; in 1865 his great *Lexicon linguae aethiopicae*; in 1866 his *Chrestomathia aethiopica*. Always a theologian at heart, however, he returned to theology in 1864. His Giessen lectures were published under the titles, *Ursprung der alttestamentlichen Religion* (1865) and *Die Propheten des alten Bundes nach ihrer politischen Wirksamkeit* (1868). In 1869 appeared his *Commentar zum Hiob* (4th ed. 1891) which stamped him as one of the foremost Old Testament exegetes. His renown as a theologian, however, was mainly founded by the series of commentaries, based on those of August Wilhelm Knobel's *Genesis* (Leipzig, 1875; 6th ed. 1892; Eng. trans. by W. B. Stevenson, Edinburgh, 1897); *Exodus und Leviticus*, 1880, revised edition by V. Ryssel, 1897; *Numeri, Deuteronomium und Josua*, with a dissertation on the origin of the Hexateuch, 1886; *Jesaja*, 1890 (revised edition by Rudolf Kittel in 1898). In 1877 he published the *Ascension of Isaiah* in Ethiopian and Latin. He was also a contributor to D. Schenkel's *Bibelllexikon*, Brockhaus's *Conversationslexikon*, and Herzog's *Realencyclopädie*. His lectures on Old Testament theology, *Vorlesungen über Theologie des Alten Testaments*, were published by Kittel in 1895.

See the articles in Herzog-Hauck, *Realencyclopädie*, and the *Allgemeine deutsche Biographie*; F. Lichtenberger, *History of German Theology in the Nineteenth Century* (1889); Wolf Baudissin, *A. Dillmann* (Leipzig, 1895).

DILLON, ARTHUR RICHARD (1721-1807), French archbishop, was the son of Arthur Dillon (1670-1733), an Irish gentleman who became general in the French service. He was born at St Germain, entered the priesthood and was successively curé of Elan near Mezières, vicar-general of Pontoise (1747), bishop of Evreux (1753) and archbishop of Toulouse (1758), archbishop of Narbonne in 1763, and in that capacity, president of the estates of Languedoc. He devoted himself much less to the spiritual direction of his diocese than to its temporal welfare, carrying out many works of public utility, bridges, canals, roads, harbours, &c.; had chairs of chemistry and of physics created at Montpellier and at Toulouse, and tried to reduce the poverty, especially in Narbonne. In 1787 and in 1788 he was a member of the Assembly of Notables called together by Louis XVI., and in 1788 presided over the assembly of the clergy. Having refused to accept the civil constitution of the clergy, Dillon had to leave Narbonne in 1790, then to emigrate to Coblenz in 1791. Soon afterwards he went to London, where he lived until his death in 1807, never accepting the Concordat, which had suppressed his archiepiscopal see.

See L. Audibert, *Le Dernier Président des États du Languedoc*, Mgr. Arthur Richard Dillon, archevêque de Narbonne (Bordeaux, 1868); L. de Lavergne, *Les Assemblées provinciales sous Louis XVI* (Paris, 1864).

DILLON, JOHN (1851-), Irish nationalist politician, was the son of John Blake Dillon (1816-1866), who sat in parliament for Tipperary, and was one of the leaders of "Young Ireland." John Dillon was educated at the Roman Catholic university of Dublin, and afterwards studied medicine. He entered parliament in 1880 as member for Tipperary, and was at first an ardent supporter of C. S. Parnell. In August he delivered a speech on the Land League at Kildare which was characterized as "wicked and cowardly" by W. E. Forster; he advocated boycotting, and was arrested in May 1881 under the Coercion Act, and again after two months of freedom in October. In 1883 he resigned his seat for reasons of health, but was returned unopposed in 1885 for East Mayo, which he continued to represent. He was one of the prime movers in the famous "plan of campaign," which provided that the tenant should pay his rent to the National League instead of the landlord, and in case of eviction be supported by the general fund. Mr Dillon was compelled by the court of queen's bench on

the 14th of December 1886 to find securities for good behaviour, but two days later he was arrested while receiving rents on Lord Clanricarde's estates. In this instance the jury disagreed, but in June 1888 under the provisions of the new Criminal Law Procedure Bill he was condemned to six months' imprisonment. He was, however, released in September, and in the spring of 1889 sailed for Australia and New Zealand, where he collected funds for the Nationalist party. On his return to Ireland he was again arrested, but, being allowed bail, sailed to America, and failed to appear at the trial. He returned to Ireland by way of Boulogne, where he and Mr W. O'Brien held long and indecisive conferences with Parnell. They surrendered to the police in February, and on their release from Galway gaol in July declared their opposition to Parnell. After the expulsion of Mr T. M. Healy and others from the Irish National Federation, Mr Dillon became the chairman (February 1896). His early friendship with Mr O'Brien gave place to considerable hostility, but the various sections of the party were ostensibly reconciled in 1900 under the leadership of Mr Redmond. In the autumn of 1896 he arranged a convention of the Irish race, which included 200 delegates from various parts of the world. In 1897 Mr Dillon opposed in the House the Address to Queen Victoria on the occasion of the Diamond Jubilee, on the ground that her reign had not been a blessing to Ireland, and he showed the same uncompromising attitude in 1901 when a grant to Lord Roberts was under discussion, accusing him of "systematized inhumanity." He was suspended on the 20th of March for violent language addressed to Mr Chamberlain. He married in 1895 Elizabeth (d. 1907), daughter of Lord Justice J. C. Mathew.

DILUVIUM (Lat. for "deluge," from *diluere*, to wash away), a term in geology for superficial deposits formed by flood-like operations of water, and so contrasted with alluvium (*q.v.*) or alluvial deposits formed by slow and steady aqueous agencies. The term was formerly given to the "boulder clay" deposits, supposed to have been caused by the Noachian deluge.

DIME (from the Lat. *decima*, a tenth, through the O. Fr. *disme*), the tenth part, the tithe paid as church dues, or as tribute to a temporal power. In this sense it is obsolete, but is found in Wycliffe's translation of the Bible—"He gave him dymes of alle thingis" (Gen. xiv. 20). A dime is a silver coin of the United States, in value 10 cents (English equivalent about 5d.) or one-tenth of a dollar; hence "dime-novel," a cheap sensational novel, a "penny dreadful"; also "dime-museum."

DIMENSION (from Lat. *dimensio*, a measuring), in geometry, a magnitude measured in a specified direction, *i.e.* length, breadth and thickness; thus a line has only length and is said to be of one dimension, a surface has length and breadth, and has two dimensions, a solid has length, breadth and thickness, and has three dimensions. This concept is extended to algebra: since a line, surface and solid are represented by linear, quadratic and cubic equations, and are of one, two and three dimensions; a biquadratic equation has its highest terms of four dimensions, and, in general, an equation in any number of variables which has the greatest sum of the indices of any term equal to n is said to have n dimensions. The "fourth dimension" is a type of non-Euclidean geometry, in which it is conceived that a "solid" has one dimension more than the solids of experience. For the dimensions of units see UNITS, DIMENSIONS OF.

DIMITY, derived from the Gr. *διμυτος* "double thread," through the Ital. *dimio*, "a kind of course linzie-wolzie" (Florio, 1611); a cloth commonly employed for bed upholstery and curtains, and usually white, though sometimes a pattern is printed on it in colours. It is stout in texture, and woven in raised patterns.

DINAJPUR, a town (with a population in 1901 of 13,430) and district of British India, in the Rajshahi division of Eastern Bengal and Assam. The earthquake of the 12th of June 1897 caused serious damage to most of the public buildings of the town. There is a railway station and a government high school. The district comprises an area of 3946 sq. m. It is traversed in every direction by a network of channels and water courses. Along the banks of the Kulik river, the undulating ridges and long line—

mango-trees give the landscape a beauty which is not found elsewhere. Dinajpur forms part of the rich arable tract lying between the Ganges and the southern slopes of the Himalayas. Although essentially a fluvial district, it does not possess any river navigable throughout the year by boats of 4 tons burden. Rice forms the staple agricultural product. The climate of the district, although cooler than that of Calcutta, is very unhealthy, and the people have a sickly appearance. The worst part of the year is at the close of the rains in September and October, during which months few of the natives escape fever. The average maximum temperature is 92.3° F., and the minimum 74.8°. The average rainfall is 85.54 in. In 1901 the population was 1,567,080, showing an increase of 6% in the decade. The district is partly traversed by the main line of the Eastern Bengal railway and by two branch lines: Save between 1404 and 1442, when it was the seat of an independent *raj*, founded by Raja Ganesh, a Hindu turned Mussulman, Dinajpur has no separate history. Pillars and copper-plate inscriptions have yielded numerous records of the Pal kings who ruled the country from the 9th century onwards, and the district is famous for many other antiquities, some of which are connected by legend with an immemorial past (see *Reports, Arch. Survey of India*, xv.; *Epigraphia Indica*, ii.).

DINAN, a town of north-western France, capital of an arrondissement in the department of Côtes-du-Nord, 37 m. E. of St Briec on the Western railway. Pop. (1906) 8588. Dinan is situated on a height on the left bank of the Rance (here canalized), some 17 m. above its mouth at St Malo, with which it communicates by means of small steamers. It is united to the village of Lanvallay on the right bank of the river by a granite viaduct 130 ft. in height. The town is almost entirely encircled by the ramparts of the middle ages, strengthened at intervals by towers and defended on the south by a castle of the late 14th century, which now serves as prison. Three old gateways are also preserved. Dinan has two interesting churches; that of St Malo, of late Gothic architecture, and St Sauveur, in which the Romanesque and Gothic styles are intermingled. In the latter church a granite monument contains the heart of Bertrand Du Guesclin, whose connexion with the town is also commemorated by an equestrian statue. The quaint winding streets of Dinan are often bordered by medieval houses. Its picturesqueness attracts large numbers of visitors and there are many English residents in the town and its vicinity. About three-quarters of a mile from the town are the ruins of the château and the Benedictine abbey at Léhon; near the neighbouring village of St Esprit stands the large lunatic asylum of Les Bas Foins, founded in 1836; and at no great distance is the now dismantled château of La Garaye, which was rendered famous in the 18th century by the philanthropic devotion of the count and countess whose story is told in Mrs Norton's *Lady of La Garaye*. Dinan is the seat of a sub-prefect and has a tribunal of first instance, and a communal college. There is trade in grain, cider, wax, butter and other agricultural products. The industries include the manufacture of leather, farm-implements and canvas.

The principal event in the history of Dinan, which was a stronghold of the dukes of Brittany, is the siege by the English under the duke of Lancaster in 1359, during which Du Guesclin and an English knight called Thomas of Canterbury engaged in single combat.

DINANT, an ancient town on the right bank of the Meuse in the province of Namur, Belgium, connected by a bridge with the left bank, on which are the station and the suburb of St Medard. Pop. (1904) 7674. The name is supposed to be derived from Diana, and as early as the 7th century it was named as one of the dependencies of the bishopric of Tongres. In the 10th century it passed under the titular sway of Liège, and remained the fief of the prince-bishopric till the French revolution put an end to that survival of feudalism. In the middle of the 15th century Dinant reached the height of its prosperity. With a population of 60,000, and 8000 workers in copper, it was one of the most flourishing cities in Walloon Belgium until it incurred the wrath of Charles the Bold. Belief in the strength of its walls and of the castle that occupied the centre bridge, thus effectually command-

ing navigation by the river, engendered arrogance and over-confidence, and the people of Dinant thought they could defy the full power of Burgundy. Perhaps they also expected aid from France or Liège. In 1466 Charles, in his father's name, laid siege to Dinant, and on the 27th of August carried the place by storm. He razed the walls and allowed the women, children and priests to retire in safety to Liège, but the male prisoners he either hanged or drowned in the river by causing them to be cast from the projecting cliff of Bouvignes. In 1675 the capture of Dinant formed one of the early military achievements of Louis XIV., and it remained in the hands of the French for nearly thirty years after that date. The citadel on the cliff, 300 ft. or 408 steps above the town, was fortified by the Dutch in 1818. It is now dismantled, but forms the chief curiosity of the place. The views of the river valley from this eminence are exceedingly fine. Half way up the cliff, but some distance south of the citadel, is the grotto of Montfat, alleged to be the site of Diana's shrine. The church of Notre Dame, dating from the 13th century, stands immediately under the citadel and flanking the bridge. It has been restored, and is considered by some authorities, although others make the same claim on behalf of Huy, the most complete specimen in Belgium of pointed Gothic architecture. The baptismal fonts date from the 12th century, and the curious spire in the form of an elongated pumpkin and covered with slates gives a fantastic and original appearance to the whole edifice. The present prosperity of Dinant is chiefly derived from its being a favourite summer resort for Belgians as well as foreigners. It has facilities for boating and bathing as well as for trips by steamer up and down the river Meuse. It is also a convenient central point for excursions into the Ardennes. Although there are some indications of increased industrial activity in recent years, the population of Dinant is not one-eighth of what it was at the time of the Burgundians.

DINAPUR, a town and military station of British India, in the Patna district of Bengal, on the right bank of the Ganges, 12 m. W. of Patna city by rail. Pop. (1901) 33,699. It is the largest military cantonment in Bengal, with accommodation for two batteries of artillery, a European and a native infantry regiment. In 1857 the sepoy garrison of the place initiated the mutiny of that year in Patna district, but after a conflict with the European troops were forced to retire from the town, and subsequently laid siege to Arrah.

DINARCHUS, last of the "ten" Attic orators, son of Sostratus (or, according to Suidas, Socrates), born at Corinth about 361 B.C. He settled at Athens early in life, and when not more than twenty-five was already active as a writer of speeches for the law courts. As an alien, he was unable to take part in the debates. He had been the pupil both of Theophrastus and of Demetrius Phalereus, and had early acquired a certain fluency and versatility of style. In 324 the Areopagus, after inquiry, reported that nine men had taken bribes from Harpalus, the fugitive treasurer of Alexander. Ten public prosecutors were appointed. Dinarchus wrote, for one or more of these prosecutors, the three speeches which are still extant—*Against Demosthenes*, *Against Aristogiton*, *Against Philoctes*. The sympathies of Dinarchus were in favour of an Athenian oligarchy under Macedonian control; but it should be remembered that he was not an Athenian citizen. Aeschines and Demades had no such excuse. In the Harpalus affair, Demosthenes was doubtless innocent, and so, probably, were others of the accused. Yet Hyperides, the most fiery of the patriots, was on the same side as Dinarchus.

Under the regency of his old master, Demetrius Phalereus, Dinarchus exercised much political influence. The years 317-307 were the most prosperous of his life. On the fall of Demetrius Phalereus and the restoration of the democracy by Demetrius Poliorcetes, Dinarchus was condemned to death and withdrew into exile at Chalcis in Euboea. About 292, thanks to his friend Theophrastus, he was able to return to Attica, and took up his abode in the country with a former associate, Proxenus. He afterwards brought an action against Proxenus on the ground that he had robbed him of some money and plate. Dinarchus died at Athens about 291.

According to Suidas, Dinarchus wrote 160 speeches; and Dionysius held that, out of 85 extant speeches bearing his name, 58 were genuine,—28 relating to public, 30 to private causes. Although the authenticity of the three speeches mentioned above is generally admitted, Demetrius of Magnesia doubted that of the speech *Against Demosthenes*, while A. Westermann rejected all three. Dinarchus had little individual style and imitated by turns Lysias, Hyperides and Demosthenes. He is called by Hermogenes δ *απὸ τοῦ ἀγροῦ*, a metaphor taken from barley compared with wheat, or beer compared with wine,—a Demosthenes whose strength is rougher, without flavour or sparkle.

Editions: (text and exhaustive commentary) E. Mätzner (1842); (text) T. Thalheim (1887), F. Blass (1888); see L. L. Forman, *Index Andocideus, Lycurgus, Dinarchus* (1897); and, in general, F. Blass, *Attische Beredsamkeit*, iii. There is a valuable treatise on the life and speeches of Dinarchus by Dionysius of Halicarnassus.

DINARD, a seaside town of north-western France, in the department of Ille-et-Vilaine. The town, which is the chief watering-place of Brittany, is situated on a rocky promontory at the mouth of the Rance opposite St Malo, which is about 1 m. distant. It is a favourite resort of English and Americans as well as of the French, its attractions being the beauty of its situation, the mildness of the climate and the good bathing. It has two casinos and numerous luxurious hotels and elegant villas. Together with the adjoining watering-place of St Enogat, Dinard has a population of 4882 (1906).

DINDIGUL, a town of British India, in the Madura district of Madras, 886 ft. above the sea, 40 m. from Madura by rail. Pop. (1901) 25,182. Dindigul has risen into importance as the centre of a trade in tobacco and manufacture of cigars, which are exported to England. There are two large European cigar factories here. The town has manufactures of silk, muslin and blankets, and an export trade in hides and cardamoms; and there is a large native Christian population, with two churches. The ancient fort, well preserved, stands on a rock rising 350 ft. above the town; this was formerly a position of great strategic importance, commanding passes into Madura from Coimbatore, and figured prominently in the military operations of the Mahrratas in the 17th and 18th centuries, and of Hyder Ali in 1755 seq., being thrice captured by the British (1767, 1783, 1790). After the second capture it was restored to Hyder Ali under treaty; after the third it was ceded to the East India Company.

DINDORF, KARL WILHELM (1802-1883), German classical scholar, was born at Leipzig on the 2nd of January 1802. From his earliest years he showed a strong taste for classical studies, and after completing F. Invernizzi's edition of Aristophanes at an early age, and editing several grammarians and rhetoricians, was in 1828 appointed extraordinary professor of literary history in his native city. Disappointed at not obtaining the ordinary professorship when it became vacant in 1833, he resigned his post in the same year, and devoted himself entirely to study and literary work. His attention had at first been chiefly given to Athensæus, whom he edited in 1827, and to the Greek dramatists, all of whom he edited separately and combined in his *Poetæ scenici Græci* (1830 and later editions). He also wrote a work on the metres of the Greek dramatic poets, and compiled special lexicons to Aeschylus and Sophocles. He edited Procopius for Niebuhr's *Corpus* of the Byzantine writers, and between 1846 and 1851 brought out at Oxford an important edition of Demosthenes; he also edited Lucian and Josephus for the Didot classics. His last important editorial labour was his *Eusebius of Caesarea* (1867-1871). Much of his attention was occupied by the republication of Stephanus's *Thesaurus* (Paris, 1831-1865), chiefly executed by him and his brother Ludwig, a work of prodigious labour and utility. His reputation suffered somewhat through the imposture practised upon him by the Greek Constantine Simonides, who succeeded in deceiving him by a fabricated fragment of the Greek historian Uranus. The book was printed, and a few copies had been circulated, when the forgery was discovered, just in time to prevent its being given to the world under the auspices of the university of Oxford. Shortly after the

death of his brother, he lost all his property and his library by rash speculations. He died on the 1st of August 1883.

His brother LUDWIG (1805-1871) was born at Leipzig on the 3rd of January 1805, and died there on the 6th of September 1871. He never held any academical position, and led so secluded a life that many doubted his existence, and declared that he was a mere pseudonym. The important share which he took in the edition of the *Thesaurus* is nevertheless authenticated by his own signature to his contributions. He also published valuable editions of Polybius, Dio Cassius and other Greek historians.

D'INDY, PAUL-MARIE-THÉODORE-VINCENT (1851-), French musical composer, was born in Paris, on the 27th of March 1851. He studied composition and the organ at the Paris Conservatoire under César Franck, and obtained the grand prize offered by the city of Paris in 1885 with *Le Chant de la Cloche*, a dramatic legend after Schiller. His principal works, beside the above, are the symphonic trilogy *Wallenstein*, the symphonic works entitled *Saugefeurie*, *La Forêt enchantée*, *Istar*, *Symphonie sur un air montagnard français*; overture to *Antihony and Cleopatra*; *Sté Marie Magdeleine*, a cantata; *Attendez-moi sous l'orme*, a one-act opera; *Fervaal*, a musical drama in three acts. Vincent d'Indy is perhaps the most prominent among the disciples of César Franck. Imbued with very high aims, he was always guided by a lofty ideal, and few musicians have attained so complete a mastery over the art of instrumentation. His music, however, lacks simplicity, and can never become popular in the widest sense. His opera *Fervaal*, which is styled "action musicale," is constructed upon the system of *Leit-motifs*. Its legendary subject recalls both *Parsifal* and *Tristan*, and the music is also suggestive of Wagnerian influence. D'Indy can scarcely be considered so typical a representative of modern French music as his juniors Alfred Bruneau, the composer of *Le Rêve*, *L'Attaque du moulin*, *Messidor*, or Gustave Charpentier, the author of *Louise*, who chose subjects of modern life for their operatic works.

DINEIR, a small town in Asia Minor, built amidst the ruins of Celaenae-Apamea, near the sources of the Maeander (Menderes). It is the terminus of the Smyrna-Aidin-Dineir railway. Pop. 1400. (See APAMEA.)

DINGELSTEDT, FRANZ VON (1814-1881), German poet and dramatist, was born at Haldorf, in Hesse Cassel, on the 30th of June 1814. Having studied at the university of Marburg, he became in 1836 a master at the Lyceum in Cassel, from which he was transferred to Fulda in 1838. In 1839 he produced a novel, *Unter der Erde*, which obtained considerable success, and in 1841 published the book by which he is best remembered, the *Lieder eines kosmopolitischen Nachwüchslers*. These poems, animated as they are by a spirit of bitter opposition to everything that savours of despotism, were an effective contribution to the political poetry of the day. The popularity of this book determined Dingelstedt to take up a literary career, and in 1841 he obtained an appointment on the staff of the *Augsburger allgemeine Zeitung*. In 1843, however, the satirist of German princes accepted, to the general surprise, the appointment of private librarian to the king of Würtemberg, and in the same year he married the celebrated Bohemian opera singer, Jenny Lutzer. In 1845 he published a volume of poems, some of which, treating of modern life, possessed great literary rather than strictly poetical merit. A subsequent collection, published in 1852, attracted little attention. The success of his tragedy *Das Haus der Barnevelt* (1850) obtained for him the position of intendant at the court theatre at Munich, where he soon became the centre of literary society. He incurred, however, the animosity of the Jesuit clique at the court, and in 1856 was suddenly dismissed on the most frivolous charges. A similar position was offered to him at Weimar through the influence of Liszt, and he remained there until 1867. His administration was most successful, and he especially distinguished himself by presenting all Shakespeare's historical plays upon the stage in an unbroken cycle. In 1867 he became director of the court opera house in Vienna, and in 1872 of the Hofburgtheater, a position he held until his death on the 15th of May 1881. Among his other works may be noticed an autobiographical sketch of his Munich career, entitled *München*

Bilderbogen (1879), *Die Amazone*, an art novel of considerable merit (1869), translations of several of Shakespeare's comedies, and several writings dealing with questions of practical dramaturgy. He was ennobled in 1867 by the king of Bavaria and in 1876 was created *Freiherr* by the emperor of Austria.

Dingelstedt's *Sämliche Werke* appeared in 12 vols. (1877-1878), but this edition is far from complete. On his life see, besides the autobiography mentioned above, J. Rodenberg, *Heimaterinnerungen an F. Dingelstedt* (Berlin, 1892), and by the same author, *F. Dingelstedt, Blicke aus seinem Nachlass* (2 vols., 1891). Also an essay by A. Stern in *Zur Literatur der Gegenwart* (Leipzig, 1886).

DINGHY, or **DINGEY** (from the Hindu *džngi* a small boat, the diminutive of *denga*, a sloop or coasting vessel), a boat of greatly varying size and shape, used on the rivers of India; the term is applied also, in certain districts, to a larger boat used for coasting purposes. The name was adopted by the merchantmen trading with India, and is now generally used to designate the small extra boat kept for general purposes on a man-of-war or merchant vessel, and also, on the Thames, for small pleasure boats built for one or two pairs of sculls.

DINGLE, a seaport and market town of county Kerry, Ireland, in the west parliamentary division, the terminus of the Tralce and Dingle railway. Pop. (1901) 1786. This may be considered the most westerly town in the United Kingdom unless Knightstown at Valencia Island be excepted; it lies on the south side of the northernmost of the great promontories which protrude into the Atlantic on the south-western coast of Ireland, on the fine natural harbour of Dingle Bay, in a wild hilly district abundant in relics of antiquity. The town, which is the centre of a considerable fishing industry, especially in mackerel, was in the 16th century of no little importance as a seaport; it had also a noted manufacture of linen. It was incorporated by Queen Elizabeth, and returned two members to the Irish parliament until the Union.

DINGO, a name applied apparently by Europeans to the warrigal, or native Australian dog, the *Canis dingo* of J. F. Blumenbach. The dingo is a stoutly-built, rather short-legged, sandy-coloured dog, intermediate in size between a jackal and a wolf, and measuring about 51 in. in total length, of which the tail takes up about eleven. In general appearance it is very like some of the pariah dogs of India and Egypt; and, except on distributional grounds, there is no reason for regarding it as specifically distinct from such breeds. Dingos, which are found both wild and tame, interbreed freely with European dogs introduced into the country, and it may be that the large amount of black on the back of many specimens may be the result of crossing of this nature.

The main point of interest connected with the dingo relates to its origin; that is to say, whether it is a member of the indigenous Australian fauna (among which it is the only large placental mammal), or whether it has been introduced into the country by man. There seems to be no doubt that fossilized remains of the dingo occur intermingled with those of the extinct Australian mammals, such as giant kangaroos, giant wombats and the still more gigantic *Diprotodon*. And since remains of man have apparently not yet been detected in these deposits, it has been thought by some naturalists that the dingo must be an indigenous species. This was the opinion of Sir Frederick McCoy, by whom the deposits in question were regarded as probably of Pliocene age. A similar view is adopted by D. Ogilvy in a *Catalogue of Australian Mammals*, published at Sydney in 1892; the writer going however one step further and expressing the belief that the dingo is the ancestor of all domesticated dogs. The latter contention cannot for a moment be sustained; and there are also strong arguments against the indigenous origin of the dingo. That the animal now occurs in a wild state is no argument whatever as to its being indigenous, seeing that a domesticated breed introduced by man into a new country abounding in game would almost certainly revert to the wild state. The apparent absence of human remains in the beds yielding dingo teeth and bones (which are almost certainly not older than the Pleistocene) is of only negative value, and liable to be upset by new discoveries. Then, again (as has been pointed out by R. I. Pocock in the first part of

the *Kenel Encyclopaedia*, 1907), the absence of any really wild species of the typical group of the genus *Canis* between Burma and Siam on the one hand and Australia on the other is a very strong argument against the dingo being indigenous, seeing that, whether brought by man or having travelled thither of its own accord, the dingo must have reached its present habitat by way of the Austro-Malay archipelago. If it had followed that route in the course of nature, it is inconceivable that it would not still be found on some portions of the route. On the supposition that the dingo was introduced by man, we have now fairly decisive evidence that the native Australian, in place of being (as formerly supposed) a member of the negro stock, is a low type of Caucasian allied to the Veddahs of Ceylon and the Toalas of Celebes. Consequently the Australian natives must be presumed to have reached the island-continent by way of Malaya; and if this be admitted, nothing is more likely than that they should have been accompanied by pariah dogs of the Indian type. Confirmation of this is afforded by the occurrence in the mountains of Java of a pariah-like dog which has reverted to an almost completely wild condition; and likewise by the fact that the old voyagers met with dogs more or less similar to the dingo in New Guinea, New Zealand and the Solomon and certain other of the smaller Pacific islands. On the whole, then, the most probable explanation of the case is that the dingo is an introduced species closely allied to the Indian pariah dog. Whether the latter represents a truly wild type now extinct, cannot be determined. If so, all pariahs should be classed with the Australian warrigal under the name of *Canis dingo*. If, on the other hand, pariahs, and consequently the dingo, cannot be separated specifically from the domesticated dogs of western Europe, then the dingo should be designated *Canis familiaris dingo*. (R. L.*)

DINGWALL, a royal and police burgh and county town of the shire of Ross and Cromarty, Scotland. Pop. (1901) 2519. It is situated near the head of Cromarty Firth where the valley of the Peffery unites with the alluvial lands at the mouth of the Conon, 18½ m. N.W. of Inverness by the Highland railway. Its name, derived from the Scandinavian *Thingvallr*, "field or meeting-place of the thing," or local assembly, preserves the Norse origin of the town; its Gaelic designation is Inverpefferon, "the mouth of the Peffery." The 18th-century town house, and some remains of the ancient mansion of the once powerful earls of Ross still exist. There is also a public park. An obelisk, 57 ft. high, was erected over the grave of the 1st earl of Cromarty. The town belongs to the Wick district group of parliamentary burghs. It is a flourishing distributing centre and has an important corn market and auction marts. Some shipping is carried on at the harbour at the mouth of the Peffery, about a mile below the burgh. Branch lines of the Highland railway run to Strathpeffer and to Strome Ferry and Kyle of Lochalsh (for Skye). Alexander II. created Dingwall a royal burgh in 1226, and its charter was renewed by James IV. On the top of Knockfarrel (Gaelic, *cnoc*, hill; *faire*, watch, or guard), a hill about 3 m. to the west, is a large and very complete vitrified fort with ramparts.

DINKA (called by the Arabs *Jango*), a widely spread negro people dwelling on the right bank of the White Nile to about 12° N., around the mouth of the Bahr-el-Ghazal, along the right bank of that river and on the banks of the lower Sobat. Like the Shilluk, they were greatly harried from the north by Nuba-Arabic tribes, but remained comparatively free owing to the vast extent of their country, estimated to cover 40,000 sq. m., and their energy in defending themselves. They are a tall race with skins of almost blue black. The men wear practically no clothes, married women having a short apron, and unmarried girls a fringe of iron cones round the waist. They tattoo themselves with tribal marks, and extract the lower incisors; they also pierce the ears and lip for the attachment of ornaments, and wear a variety of feather, iron, ivory and brass ornaments. Nearly all shave the head, but some give the hair a reddish colour by moistening it with animal matter. Polygamy is general; some headmen have as many as thirty or more wives; but six is the average number. They are great cattle and sheep breeders; the men tend their beasts with great devotion, despising agriculture,

which is left to the women; the cattle are called by means of drums. Save under stress of famine cattle are never killed for food, the people subsisting largely on durra. The Dinkas reverence the cow, and snakes, which they call "brothers." Their folklore recognizes a good and evil deity; one of the two wives of the good deity created man, and the dead go to live with him in a great park filled with animals of enormous size. The evil deity created cripples. The Dinka came, in 1899, under the control of the Sudan government, justice being administered as far as possible in accord with tribal custom. A compendium of Dinka laws was compiled by Captain H. D. E. O'Sullivan.

See G. A. Schweinfurth, *The Heart of Africa* (1874); W. Junker, *Travels in Africa*, Eng. edit. (London, 1890-1892); *The Anglo-Egyptian Sudan*, edited by Count Gleichen (London, 1905).

DINKELSBÜHL, a town of Germany, in the kingdom of Bavaria, on the Wörnitz, 16 m. N. from Nördlingen, on the railway to Dombühl. Pop. 5000. It is an interesting medieval town, still surrounded by old walls and towers, and has an Evangelical and two Roman Catholic churches. Notable is the so-called *Deutsches Haus*, the ancestral home of the counts of Drechsel-Deufstetten, a fine specimen of the German renaissance style of wooden architecture. There are a Latin and industrial school, several benevolent institutions, and a monument to Christoph von Schmid (1768-1854), a writer of stories for the young. The inhabitants carry on the manufacture of brushes, gloves, stockings and gingerbread, and deal largely in cattle.

Fortified by the emperor Henry I., Dinkelsbühl received in 1305 the same municipal rights as Ulm, and obtained in 1351 the position of a free imperial city, which it retained till 1802, when it passed to Bavaria. Its municipal code, the *Dinkelsbühler Recht*, published in 1536, and revised in 1738, contained a very extensive collection of public and private laws.

DINNER, the chief meal of the day, eaten either in the middle of the day, as was formerly the universal custom, or in the evening. The word "dine" comes through Fr. from Med. Lat. *disnare*, for *disjejunare*, to break one's fast (*jejunium*); it is, therefore, the same word as Fr. *déjeuner*, to breakfast, in modern France, to take the midday meal, *dîner* being used for the later repast. The term "dinner-wagon," originally a movable table to hold dishes, is now used of a two-tier side-board.

DINOCRATES, a great and original Greek architect, of the age of Alexander the Great. He tried to captivate the ambitious fancy of that king with a design for carving Mount Athos into a gigantic seated statue. This plan was not carried out, but Dinocrates designed for Alexander the plan of the new city of Alexandria, and constructed the vast funeral pyre of Hephaestion. Alexandria was, like Peiraeus and Rhodes (see HIPPODAMUS), built on a regular plan; the streets of most earlier towns being narrow and confused.

DINOFLAGELLATA, so called by O. Bütschli (= the CILIOFLAGELLATA of E. Claparède and H. Lachmann), a group of Protozoa, characterized as Mastigophora, provided with two flagella, the one anterior extended in locomotion, the other coiled round its base, or lying in a transverse groove. The body is bounded by a firm pellicle, often supplemented by an armour ("lorica") of cuticular cellulose plates, with usually a marked longitudinal groove from which the anterior flagellum springs, and an oblique or spiral transverse

groove for the second flagellum. In *Polykrikos* (fig. 2, 9) there are eight transverse grooves each with its flagellum. The armour-plates are often exquisitely sculptured, and may be produced into spines or perpendicular plates to give greater surface extension, as we find in other plankton organisms. The cortical plasma may protrude pseudopodia in the longitudinal groove; it contains trichocysts in several species, true nematocysts in *Polykrikos*. It contains chromatophores in many species, coloured by a mixed lipochrome pigment which

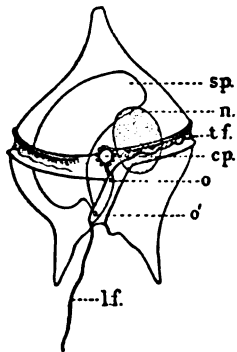

After F. Schütt in Engler and Prantl's *Pflanzenfamilien*, by permission of Wm. Engelmann.

FIG. 1.—*Peridinium diversgens* showing longitudinal and transverse grooves in which lie the respective flagella l.f., l.f.; s.p., large "sack pusule" discharging through a tube by pore o'; c.p., "collective pusule discharging at o., and surrounded by a ring of formative" or "daughter pusules"; n., nucleus.

The body is bounded by a firm pellicle, often supplemented by an armour ("lorica") of cuticular cellulose plates, with usually a marked longitudinal groove from which the anterior flagellum springs, and an oblique or spiral transverse

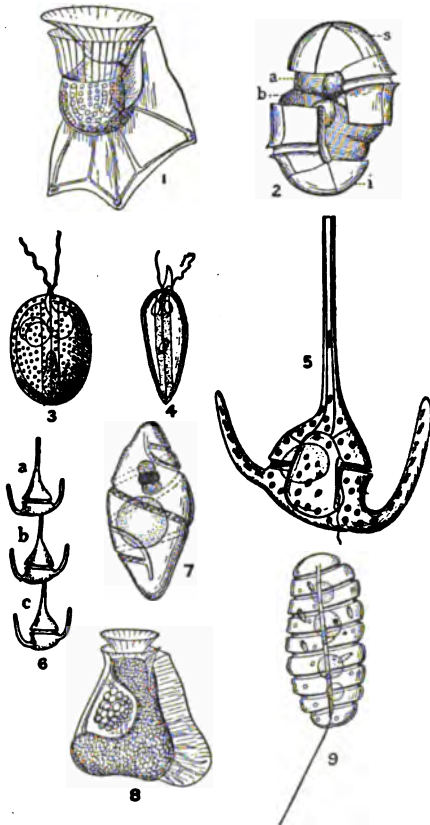

FIG. 2.
From Delage and Hérouard's *Traité de zoologie concrète*, by permission of Schleicher Frères.

1. Modified from Schütt, *Ornithoceras*.
2. Diagram of transverse fission of a Dinoflagellate.
3. After Schütt, *Exuviaella*.
4. After Stein, *Prorocentrum*.
- 5, 6. *Ceratium*, single and series.
7. *Pouchetia fusus* (Schütt).
8. *Citharistes*.
9. After Bütschli, *Polykrikos*.

appears to be distinct from diatom. The endoplasm is ramified between alveoli, it contains a large nucleus (in *Polykrikos* there are eight nuclei, accompanied by smaller, more numerous bodies regarded by O. Bütschli as micro-nuclei). Besides the other spaces are definite rounded or oval vacuoles with a permanent pellicular wall termed by Schütt "pusules"; these open by a duct or ducts into the longitudinal groove. They enlarge and diminish, and are possibly excretory like the "contractile vacuoles" of other Protista; though it has been suggested that by their communication with the medium they subserve nutrition. Nutrition is of course holozoic or

saprophytic in the colourless forms, holophytic in the coloured; but these divergent methods are exhibited by different species of the same genus, or even by individuals of one and the same species under different conditions. Binary fission has been widely observed, both in the active condition or after loss of the flagella: it differs from that of true Flagellates in not being longitudinal, but transverse or oblique (fig. 2, 2). Repeated fission (brood-formation) within a cyst has also been observed, as in *Pyrocystis* and *Ceratium*; and possibly the chains of *Ceratium* and other (fig. 2, 5 and 6) genera are due to the non-separation of the brood-cells. Conjugation of adults has been observed in several species, the most complete account being that of Zederbauer on *Ceratium hirundinella* (marine): either mate puts forth a tube which meets and opens into that of the other (as in some species of *Chlamydomonas* and Desmids); the two cell-bodies fuse in this tube, and encyst to form a resting zygospore. The Dinoflagellates are relatively large for Mastigophora, many attaining 50 μ (rh*) in length. The majority are marine; but some genera (*Ceratium*, *Peridinium*) include fresh-water species. Many are highly phosphorescent and some by their abundance colour the water of the sea or pool which they dwell in. Like so many coloured Protista, they frequently possess a pigmented "eye-spot" in which may be sunk a spheroidal refractive body ("lens").

The affinities of the Dinoflagellata are certainly with those Cryptomonadine Flagellates which possess two unequal flagella; the zoospores or young of the Cystoflagellates are practically colourless Dinoflagellates.

1. *Gymnodiniaceae*: body naked, or with a simple cellulose or gelatinous envelope; both grooves present. *Pyrocystis* (Murray), often encysted, spherical or crescentic, becoming free within cyst wall, and escaping whole or after brood-divisions as a form like *Gymnodinium*; *Gymnodinium* (Stein); *Hemidinium* (Stein); *Pouchetia* (Schütt) (fig. 2, 7) with complex eye-spot; to this group we may refer *Polyrhizis* (Bütschli) (fig. 2, 9), with its metameric transverse grooves and flagella.

2. *Prorocentraceae* (Schütt) (= the Adinida of Bergh): body surrounded by a firm shell of two valves without a girdle band; transverse groove absent; transverse flagellum coiled round base of longitudinal. *Exuviaella* (Cienk.) (fig. 2, 3); *Prorocentrum* (Ehrb.) (fig. 2, 4).

3. *Peridiniaceae* (Schütt): body with a shell of plates, a girdle band along the transverse groove, in which the transverse flagellum lies. Genera, *Peridinium* (Ehrb.) (fig. 1), fresh-water and marine; *Ceratium* (Schrank) (fig. 2, 5, 6), fresh-water and marine; *Citharistes* (Stein); *Ornithoceras* (Claparède and Lachmann) (fig. 2, 1).

LITERATURE.—R. S. Bergh, "Der Organismus der Ciliatoflagellaten," *Morphol. Jahrbuch*, vii. (1881); F. von Stein, *Organismus der Infusorien*, Abth. 3, 2. Hälfte; *Die Naturgeschichte der arthroden Flagellaten* (1883); Bütschli, "Mastigophora" (in Bronn's *Thierreich*, i. Abth. 2), 1881-1887; G. Pouchet, various observations on Dinoflagellates, *Journal de l'anatomie et de la physiologie* (1885, 1887, 1891); F. Schütt, "Die Peridineen der Plankton Expedition" (*Ergebnisse d. Pl. Exed.*, i. Th. vol. iv. 1895); and "Peridinales" in Engler and Prantl's *Pflanzenfamilien*, vol. i. Abt. 2 b. (1896); Zederbauer, *Berichte d. deutschen botanischen Gesellschaft*, vol. xx. (1900); Delage and Hérouard, *Traité de zoologie concrète*, vol. i. *La Cellule et les protozoaires* (1896). (M. HA.)

DINOTHERIUM, an extinct mammal, fossil remains of which occur in the Miocene beds of France, Germany, Greece and Northern India. These consist chiefly of teeth and the bones of the head. An entire skull, obtained from the Lower Pliocene beds of Eppelsheim, Hesse-Darmstadt, in 1836, measured 4½ ft. in length and 3 ft. in breadth, and indicates an animal exceeding the elephant in size. The upper jaw is apparently destitute of incisor and canine teeth, but possesses five molars on each side, with a corresponding number in the jaw beneath. The most remarkable feature, however, consists in the front part of the lower jaw being bent downwards and bearing two tusk-like incisors also directed downwards and backwards. *Dinotherium* is a member of the group Proboscidea, of the line of descent of the elephants.

DINWIDDIE, ROBERT (1693-1770), English colonial governor of Virginia, was born near Glasgow, Scotland, in 1693. From the position of customs clerk in Bermuda, which he held in 1747-1758, he was promoted to be surveyor-general of the customs "of the southern ports of the continent of America," as a reward

for having exposed the corruption in the West Indian customs service. In 1743 he was commissioned to examine into the customs service in the Barbadoes and exposed similar corruption there. In 1751-1758 he was lieutenant-governor of Virginia, first as the deputy of Lord Albemarle and then, from July 1756 to January 1758, as deputy for Lord Loudon. He was energetic in the discharge of his duties, but aroused much animosity among the colonists by his zeal in looking after the royal quit-rents, and by exacting heavy fees for the issue of land-patents. It was his chief concern to prevent the French from building in the Ohio Valley a chain of forts connecting their settlements in the north with those on the Gulf of Mexico; and in the autumn of 1753 he sent George Washington to Fort Le Boeuf, a newly established French post at what is now Waterford, Pennsylvania, with a message demanding the withdrawal of the French from English territory. As the French refused to comply, Dinwiddie secured from the reluctant Virginia assembly a grant of £10,000 and in the spring of 1754 he sent Washington with an armed force toward the forks of the Ohio river "to prevent the intentions of the French in settling those lands." In the latter part of May Washington encountered a French force at a spot called Great Meadows, near the Youghiogheny river, in what is now southwestern Pennsylvania, and a skirmish followed which precipitated the French and Indian War. Dinwiddie was especially active at this time in urging the co-operation of the colonies against the French in the Ohio Valley; but none of the other governors, except William Shirley of Massachusetts, was then much concerned about the western frontier, and he could accomplish very little. His appeals to the home government, however, resulted in the sending of General Edward Braddock to Virginia with two regiments of regular troops; and at Braddock's call Dinwiddie and the governors of Massachusetts, New York, Pennsylvania and Maryland met at Alexandria, Virginia, in April 1755, and planned the initial operations of the war. Dinwiddie's administration was marked by a constant wrangle with the assembly over money matters; and its obstinate resistance to military appropriations caused him in 1754 and 1755 to urge the home government to secure an act of parliament compelling the colonies to raise money for their protection. In January 1758 he left Virginia and lived in England until his death on the 27th of July 1770 at Clifton, Bristol.

The Official Records of Robert Dinwiddie, Lieutenant-Governor of Virginia (1751-1758), published in two volumes, at Richmond, Va., in 1883-1884, by the Virginia Historical Society, and edited by R. A. Brock, are of great value for the political history of the colonies in this period.

DIO CASSIUS (more correctly CASSIUS DIO), COCCIANUS (c. A.D. 150-235), Roman historian, was born at Nicaea in Bithynia. His father was Cassius Apronianus, governor of Dalmatia and Cilicia under Marcus Aurelius, and on his mother's side he was the grandson of Dio Chrysostom, who had assumed the surname of Cocceianus in honour of his patron the emperor Cocceius Nerva. After his father's death, Dio Cassius left Cilicia for Rome (180) and became a member of the senate. During the reign of Commodus, Dio practised as an advocate at the Roman bar, and held the offices of aedile and quaestor. He was raised to the praetorship by Pertinax (193), but did not assume office till the reign of Septimius Severus, with whom he was for a long time on the most intimate footing. By Macrinus he was entrusted with the administration of Pergamum and Smyrna; and on his return to Rome he was raised to the consulship about 220. After this he obtained the proconsulship of Africa, and again on his return was sent as legate successively to Dalmatia and Pannonia. He was raised a second time to the consulship by Alexander Severus, in 229; but on the plea of ill health soon afterwards retired to Nicaea, where he died. Before writing his history of Rome (*Ἱστορία* or *Ῥωμαίων Ἱστορία*), Dio Cassius had dedicated to the emperor Severus an account of various dreams and prodigies which had presaged his elevation to the throne (perhaps the *Ἐπίκρα* attributed to Dio by Suidas), and had also written a biography of his fellow-countryman Arrian. The history of Rome, which

consisted of eighty books,—and, after the example of Livy, was divided into decades,—began with the landing of Aeneas in Italy, and was continued as far as the reign of Alexander Severus (222–235). Of this great work we possess books 36–60, containing the history of events from 68 B.C.–A.D. 47; books 36 and 55–60 are imperfect. We also have part of 35 and 36–80 in the epitome of John Xiphilius, an 11th-century Byzantine monk. For the earlier period the loss of Dio's work is partly supplied by the history of Zonaras, who followed him closely. Numerous fragments are also contained in the excerpts of Constantine Porphyrogenitus. Dio's work is a most important authority for the history of the last years of the republic and the early empire. His industry was great and the various important offices he held afforded him ample opportunities for historical investigation. His style, though marred by Latinisms, is clearer than that of his model Thucydides, and his narrative shows the hand of the practised soldier and politician; the language is correct and free from affectation. But he displays a superstitious regard for miracles and prophecies; he has nothing to say against the arbitrary acts of the emperors, which he seems to take as a matter of course; and his work, although far more than a mere compilation, is not remarkable for impartiality, vigour of judgment or critical historical faculty.

The best edition with notes is that of H. S. Reimar (1750–1752), new ed. by F. G. Sturz (1824–1836); text by J. Melber (1890 foll.), with account of previous editions, and U. P. Boissevain (1895–1901); translation by H. B. Foster (Troy, New York, 1905 foll.), with full bibliography; see also W. Christ, *Geschichte der griechischen Literatur* (1898), p. 675; E. Schwartz in Pauly-Wissowa's *Realencyclopädie*, iii. pt. 2 (1897); C. Wachsmuth, *Einführung in das Studium der alten Geschichte* (1895).

DIOCESE (formed on Fr. *diocèse*, in place of the Eng. form *diocesis*—current until the 19th century—from Lat. *diocesis*, med. Lat. variant *diocesis*, from Gr. *diokēnos*, "house-keeping," "administration," *diokēnō*, "to keep house," "to govern"), the sphere of a bishop's jurisdiction. In this, its sole modern sense, the word diocese (*diocesis*) has only been regularly used since the 9th century, though isolated instances of such use occur so early as the 3rd, what is now known as a diocese having been till then usually called a *parochia* (parish). The Greek word *diokēnos*, from meaning "administration," came to be applied to the territorial circumscription in which administration was exercised. It was thus first applied e.g. to the three districts of Cibra, Apamea and Synnada, which were added to Cilicia in Cicero's time (between 50 and 50 B.C.). The word is here equivalent to "assize-districts" (Tyrrell and Purser's edition of Cicero *Epist. ad Jam.* iii. 8. 4; xiii. 67; cf. Strabo xiii. 628–629). But in the reorganization of the empire, begun by Diocletian and completed by Constantine, the word "diocese" acquired a more important meaning, the empire being divided into twelve dioceses, of which the largest—Oriens—embraced sixteen provinces, and the smallest—Britain—four (see ROMAN *Ancient History*); and W. T. Arnold, *Roman Provincial Administration*, pp. 187, 194–196, which gives a list of the dioceses and their subdivisions). The organization of the Christian church in the Roman empire following very closely the lines of the civil administration (see *CHRUCH HISTORY*), the word diocese, in its ecclesiastical sense, was at first applied to the sphere of jurisdiction, not of a bishop, but of a metropolitan.¹ Thus Anastasius Bibliothecarius (d. c. 886), in his life of Pope Dionysius, says that he assigned churches to the presbyters, and established dioceses (*parochias*) and provinces (*diocesses*). The word, however, survived in its general sense of "office" or "administration," and it was even used during the middle ages for "parish" (see Du Cange, *Glossarium*, s. "Diocesis" 2).

The practice, under the Roman empire, of making the areas of ecclesiastical administration very exactly coincide with those of the civil administration, was continued in the organization of the church beyond the borders of the empire, and many dioceses to this day preserve the limits of long vanished political divisions. The process is well illustrated in the case of English bishoprics. But this practice was based on convenience, not principle; and

¹ For exceptions see Hinschius ii. p. 39, note 1.

the limits of the dioceses, once fixed, did not usually change with the changing political boundaries. Thus Hincmar, archbishop of Reims, complains that not only his metropolitanate (*diocesis*) but his bishopric (*parochia*) is divided between two realms under two kings; and this inconvenient overlapping of jurisdictions remained, in fact, very common in Europe until the readjustments of national boundaries by the territorial settlements of the 19th century. In principle, however, the subdivision of a diocese, in the event of the work becoming too heavy for one bishop, was very early admitted, e.g. by the first council at Lugo in Spain (569), which erected Lugo into a metropolitanate, the consequent division of diocese being confirmed by the king of the second council, held in 572. Another reason for dividing a diocese, and establishing a new see, has been recognized by the church as duly existing "if the sovereign should think fit to endow some principal village or town with the rank and privileges of a city" (Bingham, lib. xvii. c. 5). But there are canons for the punishment of such as might induce the sovereign so to erect any town into a city, solely with the view of becoming bishop thereof. Nor could any diocese be divided without the consent of the primate.

In England an act of parliament is necessary for the creation of new dioceses. In the reign of Henry VIII. six new dioceses were thus created (under an act of 1539); but from that time onward until the 19th century they remained practically unchanged. The Ecclesiastical Commissioners Act 1836, which created two new dioceses (Ripon and Manchester), remodelled the state of the old dioceses by an entirely new adjustment of the revenues and patronage of each see, and also extended or curtailed the parishes and counties in the various jurisdictions.

By the ancient custom of the church the bishop takes his title, not from his diocese, but from his see, i.e. the place where his cathedral is established. Thus the old episcopal titles are all derived from cities. This tradition has been broken, however, by the modern practice of bishops in the United States and the British colonies, e.g. archbishop of the West Indies, bishop of Pennsylvania, Wyoming, &c. (see BISHOP).

See Hinschius, *Kirchenrecht*, ii. 38, &c.; Joseph Bingham, *Origines ecclesiasticæ*, 9 vols. (1840); Du Cange, *Glossarium*, s. "Diocesis"; *New English Dictionary* (Oxford, 1897), s. "Diocese."

DIO CHRYSOSTOM (c. A.D. 40–115), Greek sophist and rhetorician, was born at Prusa (mod. *Brusa*), a town at the foot of Mount Olympus in Bithynia. He was called Chrysostom ("golden-mouthed") from his eloquence, and also to distinguish him from his grandson, the historian Dio Cassius, his surname Coecelianus was derived from his patron, the emperor Coecilius Nerva. Although he did much to promote the welfare of his native place, he became so unpopular there that he migrated to Rome, but, having incurred the suspicion of Domitian, he was banished from Italy. With nothing in his pocket but Plato's *Phaedo* and Demosthenes' *De falsa legatione*, he wandered about in Thrace, Mysia, Scythia and the land of the Getae. He returned to Rome on the accession of Nerva, with whom and his successor Trajan he was on intimate terms. During this period he paid a visit to Prusa, but, disgusted at his reception, he went back to Rome. The place and date of his death are unknown; it is certain, however, that he was alive in 112, when the younger Pliny was governor of Bithynia.

Eighty orations, or rather essays on political, moral and philosophical subjects, have come down to us under his name; the *Corinthiaca*, however, is generally regarded as spurious, and is probably the work of Favorinus of Arles. Of the extant orations the following are the most important:—*Borysthenitica* (xxxvi.), on the advantages of monarchy, addressed to the inhabitants of Olbia, and containing interesting information on the history of the Greek colonies on the shores of the Black Sea; *Olympica* (xii.), in which Phœdias is represented as setting forth the principles which he had followed in his statue of Zeus, one passage being supposed by some to have suggested Lessing's *Laocoon*; *Rhodiaca* (xxxi.), an attack on the Rhodians for altering the names on their statues, and thus converting them into memorials of famous men of the day (an imitation of Demosthenes'

Leptines); *De regno* (I–iv.), addressed to Trajan, a eulogy of the monarchical form of government, under which the emperor is the representative of Zeus upon earth; *De Aeschylis et Sophocle et Euripide* (lii.), a comparison of the treatment of the story of Philoctetes by the three great Greek tragedians; and *Philoctetes* (lix.), a summary of the prologue to the lost play by Euripides. In his later life, Dio, who had originally attacked the philosophers, himself became a convert to Stoicism. To this period belong the essays on moral subjects, such as the denunciation of various cities (Tarsus, Alexandria) for their immorality. Most pleasing of all is the *Euboea* (vii.), a description of the simple life of the herdsmen and huntsmen of Euboea as contrasted with that of the inhabitants of the towns. *Troica* (xi.), an attempt to prove to the inhabitants of Ilium that Homer was a liar and that Troy was never taken, is a good example of a sophistical rhetorical exercise. Amongst his lost works were attacks on philosophers and Domitian, and *Getica* (wrongly attributed to Dio Cassius by Suidas), an account of the manners and customs of the Getae, for which he had collected material on the spot during his banishment. The style of Dio, who took Plato and Xenophon especially as his models, is pure and refined, and on the whole free from rhetorical exaggeration. With Plutarch he played an important part in the revival of Greek literature at the end of the 1st century of the Christian era.

Editions: J. J. Reiske (Leipzig, 1784); A. Emperius (Brunswick, 1844); L. Dindorf (Leipzig, 1857); H. von Arnim (Berlin, 1893–1896). The ancient authorities for his life are Philostratus, *Vit. Soph.* i. 7; Photius, *Bibliotheca*, cod. 209; Suidas, s.v.; Synesius, *Diaw.* On Dio generally see H. von Arnim, *Leben und Werke des Dion von Prusa* (Berlin, 1898); C. Marthas, *Les Moralistes sous l'empire romain* (1865); W. Christ, *Geschichte der griechischen Litteratur* (1898), § 520; J. E. Sandys, *History of Classical Scholarship* (2nd ed., 1906); W. Schmid in Pauly-Wissowa's *Realencyclopädie*, v. pt. 1 (1905). The *Euboea* has been abridged by J. P. Mahaffy in *The Greek World under Roman Sway* (1890), and there is a translation of *Select Essays* by Gilbert Wakefield (1800).

DIOCLETIAN (GAIVS AURELIUS VALERIUS DIOCLETIANVS) (A.D. 245–313), Roman emperor 284–305, is said to have been born at Dioclea, near Salona, in Dalmatia. His original name was Diocles. Of humble origin, he served with high distinction and held important military commands under the emperors Probus and Aurelian, and accompanied Carus to the Persian War. After the death of Numerianus he was chosen emperor by the troops at Chalcedon, on the 17th of September 284, and slew with his own hands Arrius Aper, the praefect of the praetorians. He thus fulfilled the prediction of a druidess of Gaul, that he would mount a throne as soon as he had slain a wild boar (*aper*). Having been installed at Nicomedia, he received general acknowledgment after the murder of Carinus. In consequence of the rising of the Bagaudae in Gaul, and the threatening attitude of the German peoples on the Rhine, he appointed Maximian Augustus in 286; and, in view of further dangers and disturbances in the empire, proclaimed Constantius Chlorus and Galerius Caesars in 293. Each of the four rulers was placed at a separate capital—Nicomedia, Mediolanum (Milan), Augusta Trevirorum (Trier), Sirmium. This amounted to an entirely new organization of the empire, on a plan commensurate with the work of government which it now had to carry on. At the age of fifty-nine, exhausted with labour, Diocletian abdicated his sovereignty on the 1st of May 305, and retired to Salona, where he died eight years afterwards (others give 316 as the year of his death). The end of his reign was memorable for the persecution of the Christians. In defence of this it may be urged that he hoped to strengthen the empire by reviving the old religion, and that the church as an independent state over whose inner life at least he possessed no influence, appeared to be a standing menace to his authority. Under Diocletian the senate became a political nonentity, the last traces of republican institutions disappeared, and were replaced by an absolute monarchy approaching to despotism. He wore the royal diadem, assumed the title of lord, and introduced a complicated system of ceremonial and etiquette, borrowed from the East, in order to surround the monarchy and its representative with mysterious sanctity. But at the same time he devoted his energies to the improvement of the administration of the

empire; he reformed the standard of coinage, fixed the price of provisions and other necessities of daily life, remitted the tax upon inheritances and manumissions, abolished various monopolies, repressed corruption and encouraged trade. In addition, he adorned the city with numerous buildings, such as the thermae, of which extensive remains are still standing (Aurelius Victor, *De Caesaribus*, 39; Eutropius ix. 13; Zonaras xii. 31).

See A. Vogel, *Der Kaiser Diocletian* (Gotha, 1857), a short sketch, with notes on the authorities; T. Preuss, *Kaiser Diocletian und seine Zeit* (Leipzig, 1869); V. Casagrandi, *Diocleziano* (Faenza, 1876); H. Schiller, *Gesch. der römischen Kaiserzeit*, ii. (1887); T. Bernhard, *Geschichte Roms von Valerian bis zu Diocletians Tod* (1867); A. J. Mason, *The Persecution of Diocletian* (1876); P. Allard, *La Persecution de Diocletien* (1890); V. Schultze in Herzog-Hauck's *Realencyclopädie für protestantische Theologie*, iv. (1898); Gibbon, *Decline and Fall*, chaps. 13 and 16; A. W. Hunzinger, *Die Diocletianische Staatsreform* (1899); O. Seck, "Die Schatzungsordnung Diocletians" in *Zeitschrift für Social- und Wirtschaftsgeschichte* (1896), a valuable paper with notes containing references to sources; and O. Seck, *Geschichte des Untergangs der antiken Welt*, vol. i. cap. 1. On his military reforms see T. Mommsen in *Hermes*, xxiv., and on his tariff system, **DIOCLETIAN, EDICT OF**.

DIOCLETIAN, EDICT OF (*De pretiis rerum venalium*), an imperial edict promulgated in A.D. 301, fixing a maximum price for provisions and other articles of commerce, and a maximum rate of wages. Incomplete copies of it have been discovered at various times in various places, the first (in Greek and Latin) at Stratonicea in Caria, by W. Sherard, British consul at Smyrna, containing the preamble and the beginning of the tables down to No. 403. This partial copy was completed by W. Bankes in 1817. A second fragment (now in the museum at Aix in Provence) was brought from Egypt in 1809; it supplements the preamble by specifying the titles of the emperors and Caesars and the number of times they had held them, whereby the date of publication can be accurately determined. For other fragments and their localities see *Corpus Inscriptionum Latinarum* (iii., 1873, pp. 801 and 1055; and supplement 1., 1893, p. 1909); special mention may be made of those of Elatea, Plataea and Megalopolis. Latin being the official language all over the empire, there was no official Greek translation (except for Greece proper), as is shown by the variations in those portions of the text of which more than one Greek version is extant. Further, all the fragments come from the provinces which were under the jurisdiction of Diocletian, from which it is argued that the edict was only published in the eastern portion of the empire; certainly the phrase *universo orbi* in the preamble is against this, but the words may merely be an exaggerated description of Diocletian's special provinces, and if it had been published in the western portion as well, it is curious that no traces have been found of it. The articles mentioned in the edict, which is chiefly interesting as giving their relative values at the time, include cereals, wine, oil, meat, vegetables, fruits, skins, leather, furs, foot-gear, timber, carpets, articles of dress, and the wages range from the ordinary labourer to the professional advocate. The unit of money was the denarius, not the silver, but a copper coin introduced by Diocletian, of which the value has been fixed approximately at $\frac{1}{16}$ of a penny. The punishment for exceeding the prices fixed was death or deportation. The edict was a well-intended but abortive attempt, in great measure in the interests of the soldiers, to meet the distress caused by several bad harvests and commercial speculation. The actual effect was disastrous; the restrictions thus placed upon commercial freedom brought about a disturbance of the food supply in non-productive countries, many traders were ruined, and the edict soon fell into abeyance.

See Lactantius, *De mortibus persecutorum*, vii., a contemporary who, as a Christian, writes with natural bias against Diocletian; T. Mommsen, *Das Edict Diocletians* (1851); W. M. Leake, *An Edict of Diocletian* (1826); W. H. Waddington, *L'Édit de Diocletien* (1864), and E. Lépaule, *L'Édit de maximum* (1886), both containing introductions and ample notes; J. C. Rolfe and F. B. Tarbell in *Papers of the American School of Classical Studies at Athens*, v. (1892) (Plataea); W. Loring in *Journal of Hellenic Studies*, xi. (1890) (Megalopolis); P. Paris in *Bulletin de correspondance hellénique*, ix. (1885) (Elatea). There is an edition of the whole by Mommsen, with notes by H. Blümner (1893).

DIODATI, GIOVANNI (1576–1649), Swiss Protestant divine, was born at Geneva on the 6th of June 1576, of a noble family originally belonging to Lucca, which had been expatriated on account of its Protestantism. At the age of twenty-one he was nominated professor of Hebrew at Geneva on the recommendation of Theodor Beza. In 1606 he became professor of theology, in 1608 pastor, or parish minister, at Geneva, and in the following year he succeeded Beza as professor of theology. As a preacher he was eloquent, bold and fearless. He held a high place among the reformers of Geneva, by whom he was sent on a mission to France in 1614. He had previously visited Italy, and made the acquaintance of Paolo Sarpi, whom he endeavoured unsuccessfully to engage in a reformation movement. In 1618–1619 he attended the synod of Dort, and took a prominent part in its deliberations, being one of the six divines appointed to draw up the account of its proceedings. He was a thorough Calvinist, and entirely sympathized with the condemnation of the Arminians. In 1645 he resigned his professorship, and died at Geneva on the 3rd of October 1649. Diodati is chiefly famous as the author of the translation of the Bible into Italian (1603, edited with notes, 1607). He also undertook a translation of the Bible into French, which appeared with notes in 1644. Among his other works are his *Annotazioni in Biblia* (1607), of which an English translation (*Pious and Learned Annotations upon the Holy Bible*) was published in London in 1648, and various polemical treatises, such as *De scitio Pontificiorum Purgatorio* (1619); *De justa secessione Reformatorum ab Ecclesia Romana* (1628); *De Antichristo*, &c. He also published French translations of Sarpi's *History of the Council of Trent*, and of Edwin Sandys's *Account of the State of Religion in the West*.

DIODORUS CRONUS (4th century B.C.), Greek philosopher of the Megarian school. Practically nothing is known of his life. Diogenes Laërtius (ii. 111) tells a story that, while staying at the court of Ptolemy Soter, Diodorus was asked to solve a dialectical subtlety by Stilpo. Not being able to answer on the spur of the moment, he was nicknamed ὁ Κρόνος (the God, equivalent to "slowcoach") by Ptolemy. The story goes that he died of shame at his failure. Strabo, however, says (xv. 618; xvii. 838) that he took the name from Apollonius, his master. Like the rest of the Megarian school he revelled in verbal quibbles, proving that motion and existence are impossible. His was the famous sophism known as the *Κυριεύω*. The impossible cannot result from the possible; a past event cannot become other than it is; but if an event, at a given moment, had been possible, from this possible would result something impossible; therefore the original event was impossible. This problem was taken up by Chrysippus, who admitted that he could not solve it. Apart from these verbal gymnastics, Diodorus did not differ from the Megarian school. From his great dialectical skill he earned the title ὁ δαλακτικός, or δαλακτικώτατος, a title which was borne by his five daughters, who inherited his ability.

See Cicero, *De Fato*, 6, 7, 9; Aristotle, *Metaphysica*, θ 3; Sext. *Empiric*, *adv. Math.* x. 85; Ritter and Preller, *Hist. philos. Gr. et Rom.* chap. v. §§ 234–236 (ed. 1869); and bibliography appended to article MEGARIAN SCHOOL.

DIODORUS SICULUS, Greek historian, born at Agrigium in Sicily, lived in the times of Julius Caesar and Augustus. From his own statements we learn that he travelled in Egypt between 60–57 B.C. and that he spent several years in Rome. The latest event mentioned by him belongs to the year 21 B.C. He asserts that he devoted thirty years to the composition of his history, and that he undertook frequent and dangerous journeys in prosecution of his historical researches. These assertions, however, find little credit with recent critics. The history, to which Diódoros gave the name βιβλιοθήκη ἱστορικῆ (Bibliotheca historica, "Historical Library"), consisted of forty books, and was divided into three parts. The first treats of the mythic history of the non-Hellenic, and afterwards of the Hellenic tribes, to the destruction of Troy; the second section ends with Alexander's death; and the third continues the history as far as the beginning of Caesar's Gallic War. Of this extensive work there are still extant only the first five books, treating of the mythic history of the Egyptians,

Assyrians, Ethiopians and Greeks; and also the 11th to the 20th books inclusive, beginning with the second Persian War, and ending with the history of the successors of Alexander, previous to the partition of the Macedonian empire (302). The rest exists only in fragments preserved in Photius and the excerpts of Constantine Porphyrogenitus. The faults of Diodorus arise partly from the nature of the undertaking, and the awkward form of annals into which he has thrown the historical portion of his narrative. He shows none of the critical faculties of the historian, merely setting down a number of unconnected details. His narrative contains frequent repetitions and contradictions, is without colouring, and monotonous; and his simple diction, which stands intermediate between pure Attic and the colloquial Greek of his time, enables us to detect in the narrative the undigested fragments of the materials which he employed. In spite of its defects, however, the *Bibliotheca* is of considerable value as to some extent supplying the loss of the works of older authors, from which it is compiled. Unfortunately, Diodorus does not always quote his authorities, but his general sources of information were—in history and chronology, Castor, Ephorus and Apollodorus; in geography, Agatharchides and Artemidorus. In special sections he followed special authorities—e.g. in the history of his native Sicily, Philistus and Timaeus.

Ediitio princeps, by H. Stephanus (1559); of other editions the best are: P. Wesseling (1746), not yet superseded; L. Dindorf (1828–1831); (text) L. Dindorf (1866–1868, revised by F. Vogel, 1888–1893 and C. T. Fischer, 1905–1906). The standard works on the sources of Diodorus are C. G. Heyne, *De fontibus et auctoribus historiarum Diodori*, printed in Dindorf's edition, and C. A. Volquardsen, *Die Quellen der griechischen und sicilischen Geschichten bei Diodor* (1868); A. von Mesa, *Rheinisches Museum* (1906); see also L. O. Bröcker, *Untersuchungen über Diodor* (1879), short, but containing much information; O. Maass, *Kleinarth und Diodor* (1894); G. J. Schneider, *De Diodori fontibus*, i–iv. (1880); C. Wachsmuth, *Eisleitung in das Studium der alten Geschichte* (1895); ГРЕБСЪ, *Ancient History*, "Authorities."

DIODOTUS, Seleucid satrap of Bactria, who rebelled against Antiochus II. (about 255) and became the founder of the Graeco-Bactrian kingdom (Trogus, *Prof.* 41; Justin li. 4, 5, where he is wrongly called Theodotus; Strabo xi. 515). His power seems to have extended over the neighbouring provinces. Arsaces, the chieftain of the nomadic (Dahan) tribe of the Parni, fled before him into Parthia and here became the founder of the Parthian kingdom (Strabo l.c.). When Seleucus II. in 239 attempted to subjugate the rebels in the east he seems to have united with him against the Parthians (Justin li. 4, 9). Soon afterwards he died and was succeeded by his son Diodotus II., who concluded a peace with the Parthians (Justin l.c.). Diodotus II. was killed by another usurper, Euthydemus (Polyb. xi. 34, 2). Of Diodotus I. we possess gold and silver coins, which imitate the coins of Antiochus II.; on these he sometimes calls himself Soter, "the saviour." As the power of the Seleucids was weak and continually attacked by Ptolemy II., the eastern provinces and their Greek cities were exposed to the invasion of the nomadic barbarians and threatened with destruction (Polyb. xi. 34, 5); thus the erection of an independent kingdom may have been a necessity and indeed an advantage to the Greeks, and this epithet well deserved. Diodotus Soter appears also on coins struck in his memory by the later Graeco-Bactrian kings Agathocles and Antimachus. Cf. A. v. Sallet, *Die Nachfolger Alexanders d. Gr. in Baktrien und Indien*; Percy Gardner, *Catal. of the Coins of the Greek and Scythian Kings of Bactria and India* (Brit. Mus.); see also BACTRIA. Ed. M.)

DIOGENES, "the Cynic," Greek philosopher, was born at Sinope about 412 B.C., and died in 323 at Corinth, according to Diogenes Laërtius, on the day on which Alexander the Great died at Babylon. His father, Iccias, a money-changer, was imprisoned or exiled on the charge of adulterating the coinage. Diogenes was included in the charge, and went to Athens with one attendant, whom he dismissed, saying, "If Manes can live without Diogenes, why not Diogenes without Manes?" Attracted by the ascetic teaching of Antisthenes, he became his pupil, despite the brutality with which he was received, and rapidly excelled his master both in reputation and in the austerity of his life. The stories which

are told of him are probably true; in any case, they serve to illustrate the logical consistency of his character. He inured himself to the vicissitudes of weather by living in a tub belonging to the temple of Cybele. The single wooden bowl he possessed he destroyed on seeing a peasant boy drink from the hollow of his hands. On a voyage to Aegina he was captured by pirates and sold as a slave in Crete to a Corinthian named Xeniadēs. Being asked his trade, he replied that he knew no trade but that of governing men, and that he wished to be sold to a man who needed a master. As tutor to the two sons of Xeniadēs, he lived in Corinth for the rest of his life, which he devoted entirely to preaching the doctrines of virtuous self-control. At the Isthmian games he lectured to large audiences who turned to him from Antisthenes. It was, probably, at one of these festivals that he craved from Alexander the single boon that he would not stand between him and the sun, to which Alexander replied "If I were not Alexander, I would be Diogenes." On his death, about which there exist several accounts, the Corinthians erected to his memory a pillar on which there rested a dog of Parian marble. His ethical teaching will be found in the article *CYNICS* (q.v.). It may suffice to say here that virtue, for him, consisted in the avoidance of all physical pleasure; that pain and hunger were positively helpful in the pursuit of goodness; that all the artificial growths of society appeared to him incompatible with truth and goodness; that moralization implies a return to nature and simplicity. He has been credited with going to extremes of impropriety in pursuance of these ideas; probably, however, his reputation has suffered from the undoubted immorality of some of his successors. Both in ancient and in modern times, his personality has appealed strongly to sculptors and to painters. Ancient busts exist in the museums of the Vatican, the Louvre and the Capitol. The interview between Diogenes and Alexander is represented in an ancient marble bas-relief found in the Villa Albani. Rubens, Jordans, Steen, Van der Werff, Jeaurat, Salvator Rosa and Karel Dujardin have painted various episodes in his life.

The chief ancient authority for his life is Diogenes Laërtius vi. 20; see also Mayor's notes on Juvenal, *Satires*, xiv. 308-314; and article *CYNICS*.

DIOGENES APOLLONIATES (d. 460 B.C.), Greek natural philosopher, was a native of Apollonia in Crete. Although of Dorian stock, he wrote in the Ionic dialect, like all the *physiologi* (physical philosophers). There seems no doubt that he lived some time at Athens, where it is said that he became so unpopular (probably owing to his supposed atheistical opinions) that his life was in danger. The views of Diogenes are transferred in the *Clouds* (264 ff.) of Aristophanes to Socrates. Like Anaximenes, he believed air to be the one source of all being, and all other substances to be derived from it by condensation and rarefaction. His chief advance upon the doctrines of Anaximenes is that he asserted air, the primal force, to be possessed of intelligence—"the air which stirred within him not only prompted, but instructed. The air as the origin of all things is necessarily an eternal, imperishable substance, but as soul it is also necessarily endowed with consciousness." In fact, he belonged to the old Ionian school, whose doctrines he modified by the theories of his contemporary Anaxagoras, although he avoided his dualism. His most important work was *Περὶ φύσεως* (*De natura*), of which considerable fragments are extant (chiefly in Simplicius); it is possible that he wrote also *Against the Sophists* and *On the Nature of Man*, to which the well-known fragment about the veins would belong; possibly these discussions were subdivisions of his great work.

Fragments in F. Mullach, *Fragmenta philosophorum Graecorum*, i. (1860); F. Panzerbieter, *Diogenes Apolloniates* (1830), with philosophical dissertation; J. Burnet, *Early Greek Philosophy* (1892); H. Ritter and L. Preller, *Historia philosophiæ* (4th ed., 1869), §§ 59-68; E. Krause, *Diogenes von Apollonia* (1909). See *IONIAN SCHOOL*.

DIOGENES LAËRTIUS (or **LAËRTIUS DIOGENES**), the biographer of the Greek philosophers, is supposed by some to have received his surname from the town of Laërte in Cilicia, and by others from the Roman family of the Laërtii. Of the circumstances of his life we know nothing. He must have lived after

Sextus Empiricus (c. A.D. 200), whom he mentions, and before Stephanus of Byzantium (c. A.D. 500), who quotes him. It is probable that he flourished during the reign of Alexander Severus (A.D. 222-235) and his successors. His own opinions are equally uncertain. By some he was regarded as a Christian; but it seems more probable that he was an Epicurean. The work by which he is known professes to give an account of the lives and sayings of the Greek philosophers. Although it is at best an uncritical and unphilosophical compilation, its value, as giving us an insight into the private life of the Greek sages, justly led Montaigne to exclaim that he wished that instead of one Laërtius there had been a dozen. He treats his subject in two divisions which he describes as the Ionian and the Italian schools; the division is quite unscientific. The biographies of the former begin with Anaximander, and end with Clitomachus, Theophrastus and Chrysippus; the latter begins with Pythagoras, and ends with Epicurus. The Socratic school, with its various branches, is classed with the Ionic; while the Eleatics and sceptics are treated under the Italic. The whole of the last book is devoted to Epicurus, and contains three most interesting letters addressed to Herodotus, Pythocles and Menoœceus. His chief authorities were Diocles of Magnesia's *Cursory Notice* (*Ἐπιτομή*) of *Philosophers* and Favorinus's *Miscellaneous History and Memoirs*. From the statements of Burlaeus (Walter Burley, a 14th-century monk) in his *De vita et moribus philosophorum* the text of Diogenes seems to have been much fuller than that which we now possess. In addition to the *Lives*, Diogenes was the author of a work in verse on famous men, in various metres.

BIBLIOGRAPHY.—*Éditio princeps* (1533); H. Hübner and C. Jacobitz with commentary (1828-1833); C. G. Cobet (1850), text only. See F. Nietzsche, "De Diogenis Laërtii fontibus" in *Rheinisches Museum*, xxiii., xxiv. (1868-1869); J. Freudenthal, "Zu Quellenkunde Diog. Laërt.," in *Hellenistische Studien*, iii. (1879); O. Maass, *De biographis Graecis* (1880); V. Egger, *De fontibus Diog. Laërt.* (1881). There is an English translation by C. D. Yonge in Bohn's Classical Library.

DIOGENIANUS, of Heraclea on the Pontus (or in Caria), Greek grammarian, flourished during the reign of Hadrian. He was the author of an alphabetical lexicon, chiefly of poetical words, abridged from the great lexicon (*Περὶ γλῶσσοῦ*) of Pamphilus of Alexandria (fl. A.D. 50) and other similar works. It was also known by the title *Πεπερογγοβήρες* (for the use of "industrious poor students"). It formed the basis of the lexicon, or rather glossary, of Hesychius of Alexandria, which is described in the preface as a new edition of the work of Diogenianus. We still possess a collection of proverbs under his name, probably an abridgment of the collection made by himself from his lexicon (ed. by E. Leutsch and F. W. Schneidewin in *Paroemiographi Graeci*, i. 1839). Diogenianus was also the author of an Anthology of epigrams, of treatises on rivers, lakes, fountains and promontories; and of a list (with map) of all the towns in the world.

DIOGNETUS, EPISTLE TO, one of the early Christian apocrypha. Diognetus, of whom nothing is really known, has expressed a desire to know what Christianity really means—"What is this new race" of men who are neither pagans nor Jews? "What is this new interest which has entered into men's lives now and not before?" The anonymous answer begins with a refutation of the folly of worshipping idols, fashioned by human hands and needing to be guarded if of precious material. The repulsive smell of animal sacrifices is enough to show their monstrous absurdity. Next Judaism is attacked. Jews abstain from idolatry and worship one God, but they fall into the same error of repulsive sacrifice, and have absurd superstitions about meats and sabbaths, circumcision and new moons. So far the task is easy; but the mystery of the Christian religion "think not to learn from man." A passage of great eloquence follows, showing that Christians have no obvious peculiarities that mark them off as a separate race. In spite of blameless lives they are hated. Their home is in heaven, while they live on earth. "In a word, what the soul is in a body, this the Christians are in the world. . . . The soul is enclosed in the body, and yet itself holdeth the body together: so Christians are kept in the world as in a prison-house, and yet they themselves hold the world

together." This strange life is inspired in them by the almighty and invisible God, who sent no angel or subordinate messenger to teach them, but His own Son by whom He created the universe. No man could have known God, had He not thus declared Himself. "If thou too wouldst have this faith, learn first the knowledge of the Father. For God loved men, for whose sake He made the world. . . . Knowing Him, thou wilt love Him and imitate His goodness; and marvel not if a man can imitate God: he can, if God will." By kindness to the needy, by giving them what God has given to him, a man can become "a god of them that receive, an imitator of God." "Then shalt thou on earth behold God's life in heaven; then shalt thou begin to speak the mysteries of God." A few lines after this the letter suddenly breaks off.

Even this rapid summary may show that the writer was a man of no ordinary power, and there is no other early Christian writing outside the New Testament which appeals so strongly to modern readers. The letter has been often classed with the writings of the Apostolic Fathers, and in some ways it seems to mark the transition from the sub-apostolic age to that of the Apologists. Bishop Lightfoot, who speaks of the letter as "one of the noblest and most impressive of early Christian apologies," places it c. A.D. 150, and inclines to identify Diognetus with the tutor of Marcus Aurelius. Harnack and others would place it later, perhaps in the 3rd century. There are some striking parallels in method and language to the Apology of Aristides (q.v.), and also to the early "Preaching of Peter."

The one manuscript which contained this letter perished by fire at Strassburg in 1870, but happily it had been accurately collated by Reuss nine years before. It formed part of a collection of works supposed to be by Justin Martyr, and to this mistaken attribution its preservation is no doubt due. Both thought and language mark the author off entirely from Justin. The end of the letter is lost, but there followed in the codex the end of a homily,¹ which was attached without a break to the epistle: this points to the loss in some earlier codex of pages containing the end of the letter and the beginning of the homily.

The Epistle may be read in J. B. Lightfoot's *Apostolic Fathers* (ed. min.), where there is also a translation into English. (J. A. R.)

DIOMEDES, in Greek legend, son of Tydeus, one of the bravest of the heroes of the Trojan War. In the *Iliad* he is the favourite of Athena, by whose aid he not only overcomes all mortals who venture to oppose him, but is even enabled to attack the gods. In the post-Homeric story, he made his way with Odysseus by an underground passage into the citadel of Troy and carried off the Palladium, the presence of which within the walls secured Troy against capture (Virgil, *Aeneid*, ii. 164). On his return to Argos, finding that his wife had been unfaithful, he removed to Aetolia, and thence to Daunia (Apulia), where he married the daughter of King Daunus. He was buried or mysteriously disappeared on one of the islands in the Adriatic called after him Diomedes, his sorrowing companions being changed into birds by the gods out of compassion (Ovid, *Metam.* xiv. 457 ff.). He was the reputed founder of Argrippa (Arpi) and other Italian cities (*Aeneid*, xi. 243 ff.). He was worshipped as a hero not only in Greece, but on the coast of the Adriatic, as at Thurii and Metapontum. At Argos, his native place, during the festival of Athens, his shield was carried through the streets as a relic, together with the Palladium, and his statue was washed in the river Inachus.

DIOMEDES, Latin grammarian, flourished at the end of the 4th century A.D. He was the author of an extant *Ars grammatica* in three books, dedicated to a certain Athanasius. The third book is the most important, as containing extracts from Suetonius's *De poetis*. Diomedes wrote about the same time as Charisius (q.v.) and used the same sources independently. The works of both grammarians are valuable, but whereas much of Charisius has been lost, the *Ars* of Diomedes has come down to us complete. In book i. he treats of the eight parts of speech; in ii. of the elementary ideas of grammar and of style; in iii. of quantity and metres.

The best edition is in H. Keil's *Grammatici Latini*, i.; see also C. von Paucker, *Kleinere Studien*, i. (1883), on the Latinity of Diomedes.

¹ Chapters xi. and xii., which Lightfoot suggested might be the work of Pantaenus.

DION, tyrant of Syracuse (408–353 B.C.), the son of Hipparchus, and brother-in-law of Dionysius the Elder. In his youth he was an admirer and pupil of Plato, whom Dionysius had invited to Syracuse; and he used every effort to inculcate the maxims of his master in the mind of the tyrant. The stern morality of Dion was distasteful to the younger Dionysius, and the historian Philistus, a faithful supporter of despotic power, succeeded in procuring his banishment on account of alleged intrigues with the Carthaginians. The exiled philosopher retired to Athens, where he was at first permitted to enjoy his revenues in peace; but the intercession of Plato (who had again visited Syracuse to procure Dion's recall) only served to exasperate the tyrant, and at length provoked him to confiscate the property of Dion, and give his wife to another. This last outrage roused Dion. Assembling a small force at Zacynthus, he sailed to Sicily (357) and was received with demonstrations of joy. Dionysius, who was in Italy, returned to Sicily, but was defeated and obliged to flee. Dion himself was soon after supplanted by the intrigues of Heracleides, and again banished. The incompetency of the new leader and the cruelties of Apollocrates, the son of Dionysius, soon led to his recall. He had, however, scarcely made himself master of Sicily when the people began to express their discontent with his tyrannical conduct, and he was assassinated by Callippus, an Athenian who had accompanied him in his expedition.

See *Lives* by Plutarch and Cornelius Nepos (cf. Diod. Sic. xvi. 6–20) and in modern times by T. Lau (1860); see also SYRACUSE and SICILY: *History*.

DIONE, in the earliest Greek mythology, the wife of Zeus. As such she is associated with Zeus Nalus (the god of fertilizing moisture) at Dodona (Strabo vii. p. 320), by whose side she sits, adorned with a bridal veil and garland and holding a sceptre. As the oracle declined in importance, her place as the wife of Zeus was taken by Hera. It is probable that in very early times the cult of Dione existed in Athens, where she had an altar before the Erechtheum. After her admission to the general religious system of the Greeks, Dione was variously described. In the *Iliad* (v. 370) she is the mother by Zeus of Aphrodite, who is herself in later times called Dione (the epithet Dionaea was given to Julia Caesar as claiming descent from Venus). In Hesiod (*Theog.* 353) she is one of the daughters of Oceanus; in Pherecydes (ap. schol. *Iliad*, xviii. 486), one of the nymphs of Dodona, the nurses of Dionysus; in Euripides (frag. 177), the mother of Dionysus; in Hyginus (fab. g. 82), the daughter of Atlas, wife of Tantalus and mother of Pelops and Niobe. Others make her a Titanid, the daughter of Uranus and Gaea (Apollodorus i. 1). Speaking generally, Dione may be regarded as the female embodiment of the attributes of Zeus, to whose name her own is related as Juno (= Jovino) to Jupiter.

DIONYSIA, festivals in honour of the god Dionysus generally, but in particular the festivals celebrated in Attica and by the branches of the Attic-Ionic race in the islands and in Asia Minor. In Attica there were two festivals annually. (1) The *lesser* Dionysia, or *rá kar' átyois*, was held in the country places for four days (about the 19th to the 22nd of December) at the first tasting of the new wine. It was accompanied by songs, dance, phallic processions and the impromptu performances of itinerant players, who with others from the city thronged to take part in the excitement of the rustic sports. A favourite amusement was the *Ascoliasmus*, or dancing on one leg upon a leathern bag (*áowós*), which had been smeared with oil. (2) The *greater* Dionysia, or *rá év ára*, was held in the city of Athens for six days (about the 28th of March to the 2nd of April). This was a festival of joy at the departure of winter and the promise of summer, Dionysus being regarded as having delivered the people from the wants and troubles of winter. The religious act of the festival was the conveying of the ancient image of the god, which had been brought from Eleutherae to Athens, from the ancient sanctuary of the Lenæum to a small temple near the Acropolis and back again, with a chorus of boys and a procession carrying masks and singing the dithyrambus. The festival culminated in the production of tragedies, comedies and satyric dramas in the great theatre of Dionysus. Other festivals in honour of Dionysus were the

Antheſteria (q.v.); the Lenaea (about the 28th to the 31st of January), or festival of vats, at which, after a great public banquet, the citizens went through the city in procession to attend the dramatic representations; the Oſchophoria (October–November), a vintage festival, so called from the branches of vine with grapes carried by twenty youths from the epehei, two from each tribe, in a race from the temple of Dionysus in Athens to the temple of Athena Sciras in Phalerum.

See A. Mommsen, *Feste der Stadt Athen* (1898); L. Preller, *Griechische Mythologie*; L. C. Purser in Smith's *Dictionary of Antiquities* (3rd ed., 1890); article *DIONYSOS* in W. H. Roscher's *Lexikon der Mythologie*; and the exhaustive account with bibliography by J. Girard in Daremberg and Saglio's *Dictionnaire des antiquités*.

DIONYSIUS, pope from 259 to 268. To Dionysius, who was elected pope in 259 after the persecution of Valerian, fell the task of reorganizing the Roman church, which had fallen into great disorder. At the protest of some of the faithful at Alexandria, he demanded from the bishop of Alexandria, also called Dionysius, explanations touching his doctrine. He died on the 26th of December 268.

DIONYSIUS (c. 432–367 B.C.), tyrant of Syracuse, began life as a clerk in a public office, but by courage and diplomacy succeeded in making himself supreme (see *SYRACUSE*). He carried on war with Carthage with varying success; his attempts to drive the Carthaginians entirely out of the island failed, and at his death they were masters of at least a third of it. He also carried on an expedition against Rhegium and its allied cities in Magna Graecia. In one campaign, in which he was joined by the Lucanians, he devastated the territories of Thurii, Croton and Locri. After a protracted siege he took Rhegium (386), and sold the inhabitants as slaves. He joined the Illyrians in an attempt to plunder the temple of Delphi, pillaged the temple of Caere on the Etruscan coast, and founded several military colonies on the Adriatic. In the Peloponnesian War he espoused the side of the Spartans, and assisted them with mercenaries. He also posed as an author and patron of literature; his poems, severely criticized by Philoxenus, were hissed at the Olympic games; but having gained a prize for a tragedy on the *Ransom of Hector* at the Lenaea at Athens, he was so elated that he engaged in a debauch which proved fatal. According to others, he was poisoned by his physicians at the instigation of his son. His life was written by Philistus, but the work is not extant. Dionysius was regarded by the ancients as a type of the worst kind of despot—cruel, suspicious and vindictive. Like Peisistratus, he was fond of having distinguished literary men about him, such as the historian Philistus, the poet Philoxenus, and the philosopher Plato, but treated them in a most arbitrary manner.

See *Diod. Sic. xiii., xiv., xv.*; J. Bass, *Dionysius I. von Syrakus* (Vienna, 1881), with full references to authorities in footnotes; articles *SICILY* and *SYRACUSE*.

His son **DIONYSIUS**, known as "the Younger," succeeded in 367 B.C. He was driven from the kingdom by Dion (356) and fled to Locri; but during the commotions which followed Dion's assassination, he managed to make himself master of Syracuse. On the arrival of Timoleon he was compelled to surrender and retire to Corinth (343), where he spent the rest of his days in poverty (Diodorus Siculus xvi.; Plutarch, *Timoleon*).

See *SYRACUSE* and *TIMOLEON*; and, on both the Dionysii, articles by B. Niese in Pauly-Wisowa's *Realencyclopädie*, v. pt. 1 (1905).

DIONYSIUS AREOPAGITICUS (or "the Areopagite"), named in Acts xvii., 34 as one of those Athenians who believed when they had heard Paul preach on Mars Hill. Beyond this mention our only knowledge of him is the statement of Dionysius, bishop of Corinth (A. D. 171), recorded by Eusebius (*Church Hist.* iii. 4; iv. 23), that this same Dionysius the Areopagite was the first "bishop" of Athens. Some hundreds of years after the Areopagite's death, his name was attached by the Pseudo-Areopagite to certain theological writings composed by the latter. These were destined to exert enormous influence upon medieval thought, and their fame led to the extension of the personal legend of the real Dionysius. Hilduin, abbot of St Denys (814–840), identified him with St Denys, martyr and patron-saint of France.

In Hilduin's *Areopagitica*, the Life and Passion of the most holy Dionysius (Migne, *Patrol. Lat.* tome 106), the Areopagite is sent to France by Clement of Rome, and suffers martyrdom upon the hill where the monastery called St Denys was to rise in his honour. There is no earlier trace of this identification, and Gregory of Tours (d. 594) says (*Hist. Francorum*, i. 18) that St Denys came to France in the reign of Decius (A. D. 250), which falls about midway between the presumptive death of the real Areopagite and the probable date of the writings to which he owed his adventitious fame.

Traces of the influence of these writings appear in the works of Eastern theologians in the early part of the 6th century. They also were cited at the council held in Constantinople in 533, which is the first certain dated reference to them. In the West, Gregory the Great (d. 604) refers to them in his thirty-fourth sermon on the gospels (Migne, *Pat. Lat.* tome 76, col. 1254). They did not, however, become generally known in the Western church till after the year 827, when the Byzantine emperor Michael the Stammerer sent a copy to Louis the Pious. It was given over to the care of the above-mentioned abbot Hilduin. In the next generation the scholar and philosopher Joannes Scotus Erigena (q.v.) translated the Dionysian writings into Latin. This appears to have been the only Latin translation until the 12th century when another was made, followed by several others.

Thus, the author, date and place of composition of these writings are unknown. External evidence precludes a date later than the year 500, and the internal evidence from the writings themselves precludes any date prior to 4th-century phases of Neo-platonism. The extant writings of the Pseudo-Areopagite are: (a) *Περὶ τῆς οὐρανίας ἱεραρχίας*, Concerning the *Celestial Hierarchy*, in fifteen chapters. (b) *Περὶ τῆς καθ' ἑαυτοῦ ἱεραρχίας*, Concerning the *Ecclesiastical Hierarchy*, in seven chapters. (c) *Περὶ θεῶν ὀνομάτων*, Concerning *Divine Names*, in thirteen chapters. (d) *Περὶ μυστικῆς θεολογίας*, Concerning *Mystic Theology*, in five chapters. (e) Ten letters addressed to various worthies of the apostolic period.

Although these writings seem complete, they contain references to others of the same author. But of the latter nothing is known, and they may never have existed.

The writings of the Pseudo-Areopagite are of great interest, first as a striking presentation of the heterogeneous elements that might unite in the mind of a gifted man in the 5th century, and secondly, because of their enormous influence upon subsequent Christian theology and art. Their ingredients—Christian, Greek, Oriental and Jewish—are not crudely mingled, but are united into an organic system. Perhaps theological philosophic fantasy has never constructed anything more remarkable. The system of Dionysius was a proper product of its time,—lofty, apparently complete, comparable to the *Enneads* of Plotinus which formed part of its materials. But its materials abounded everywhere, and offered themselves temptingly to the hand strong enough to build with them. There was what had entered into Neo-platonism, both in its dialectic form as established by Plotinus, and in its magic-mystic modes devised by Iamblichus (d. c. 333). There was Jewish angel lore and Eastern mood and fancy; and there was Christianity so variously understood and heterogeneously constituted among Syro-Judaic Hellenic communities. Such Christianity held materials for formula and creed; also principles of liturgic and sacramental doctrine and priestly function; also a mass of popular beliefs as to intermediate superhuman beings who seemed nearer to men than any member of the Trinity.

Out of this vast spiritual conglomerate, Pseudo-Dionysius formed his system. It was not juristic,—not Roman, Pauline or Augustinian. Rather he borrowed his constructive principles from Hellenism in its last great creation, Neo-platonism. That had been able to gather and arrange within itself the various elements of latter-day paganism. The Neo-platonic categories might be altered in name and import, and yet the scheme remain a scheme; since the general principle of the transmission of life from the ultimate Source downward through orders of mediating beings unto men, might readily be adapted to the Christian God

and his ministering angels. Pseudo-Dionysius had lofty thoughts of the sublime transcendence of the ultimate divine Source. That source was not remote or inert; but a veritable Source from which life streamed to all lower orders of existence,—in part directly, and in part indirectly as power and guidance through the higher orders to the lower. Life, creation, every good gift, is from God directly; but his flaming ministers also intervene to guide and aid the life of man; and the life which through love floods forth from God has its counterflow whereby it draws its own creations to itself. God is at once absolutely transcendent and universally immanent. To live is to be united with God; evil is the non-existent, that is, severance from God. Whatever is, is part of the forth-flowing divine life which ever purifies, enlightens and perfects, and so draws all back to the Source.

The transcendent Source, as well as the universal immanence, is the Triune God. Between that and men are ranged the three triads of the Celestial Hierarchy: Seraphim, Cherubim and Thrones; Dominations, Virtues, Powers; Principalities, Archangels, Angels. Collectively their general office is to raise mankind to God through purification, illumination and perfection; and to all may be applied the term angel. The highest triad, which is nearest God, contemplates the divine effulgence, and reflects it onward to the second, the third, and more specifically angelic triad, immediately ministers to men. The sources of these names are evident: seraphim and cherubim are from the Old Testament; later Jewish writings gave names to archangels and angels, who also fill important functions in the New Testament. The other names are from Paul (Eph. i. 21; Col. i. 16).

Such is the system of Pseudo-Dionysius, as presented mainly in *The Celestial Hierarchy*. That work is followed by *The Ecclesiastical Hierarchy*, its counterpart on earth. What the primal triune Godhead is to the former, Jesus is to the latter. The Ecclesiastical Hierarchy likewise is composed of Triads. The first includes the symbolic sacraments: Baptism, Communion, Consecration of the Holy Chrism. Baptism signifies purification; Communion signifies enlightening; the Holy Chrism signifies perfecting. The second triad is made up of the three orders of Bishops, Presbyters and Deacons, or rather, as the Areopagite names them: Hierarchs, Light-bearers, Servitors. The third triad consists of monks, who are in a state of perfection, the initiated laity, who are in a state of illumination, and the catechumens, in a state of purification. All worship, in this treatise, is a celebration of mysteries, and the pagan mysteries are continually suggested by the terms employed.

The work *Concerning the Divine Names* is a noble discussion of the qualities which may be predicated of God, according to the warrant of the terms applied to him in Scripture. The work *Concerning Mystic Theology* explains the function of symbols, and shows that he who would know God truly must rise above them and above the conceptions of God drawn from sensible things.

The works of Pseudo-Dionysius began to influence theological thought in the West from the time of their translation into Latin by Erigena. Their use may be followed through the writings of scholastic philosophers, e.g. Peter Lombard, Albertus Magnus, Thomas Aquinas and many others. In poetry we find their influence in Dante, Spenser, Milton. The fifteenth chapter of *The Celestial Hierarchy* constituted the canon of symbolical angelic lore for the literature and art of the middle ages. Therein the author explains in what respect theology ascribes to angels the qualities of fire, why the thrones are said to be fiery (*υρβουνοι*); why the seraphim are burning (*εκαυροντας*) as their name indicates. The fiery form signifies, with Celestial Intelligences, likeness to God. Dionysius explains the significance of the parts of the human body when given to celestial beings: feet are ascribed to angels to denote their unceasing movement on the divine business, and their feet are winged to denote their celerity. He likewise explains the symbolism of wands and axes, of brass and precious stones, when joined to celestial beings; and what wheels and a chariot denote when furnished to them,—and much more besides.

BIBLIOGRAPHY.—There is an enormous literature on Pseudo-Dionysius. The reader may be first referred to the articles in

Smith's *Dictionary of Christian Biography* and Hauck's *Realencyclopädie für protestantische Theologie* (Leipzig, 1898). The bibliography in the latter is very full. Some other references, especially upon the later influence of these works, are given in H. O. Taylor's *Classical Heritage of the Middle Ages* (Macmillan, 1903). The works themselves are in Migne's *Patrologia Graeca*, tomes 3 and 4, with a Latin version. Erigena's version is in Migne, *Patrol. Lat.* t. 122. *Vita Dionysii* by Hilduin is in Migne, *Pat. Lat.* 106. There is an English version by Parker (London, 1894 and 1897). (H. O. T.)

DIONYSIUS EXIGUUS, one of the most learned men of the 6th century, and especially distinguished as a chronologist, was, according to the statement of his friend Cassiodorus, a Scythian by birth, "*Scythia natione*." This may mean only that he was a native of the region bordering on the Black Sea, and does not necessarily imply that he was not of Greek origin. Such origin is indicated by his name and by his thorough familiarity with the Greek language. His surname "Exiguus" is usually translated "the Little," but he probably assumed it out of humility. He was living at Rome in the first half of the 6th century, and is usually spoken of as abbot of a Roman monastery. Cassiodorus, however, calls him simply "monk," while Bede calls him "abbot." But as it was not unusual to apply the latter term to distinguished monks who were not heads of their houses, it is uncertain whether Dionysius was abbot in fact or only by courtesy. He was in high repute as a learned theologian, was profoundly versed in the Holy Scriptures and in canon law, and was also an accomplished mathematician and astronomer. We owe to him a collection of 401 ecclesiastical canons, including the apostolical canons and the decrees of the councils of Nicaea, Constantinople, Chalcedon and Sardis, and also a collection of the decretals of the popes from Siricius (385) to Anastasius II. (498). These collections, which had great authority in the West (see CANON LAW), were published by Justel in 1628. Dionysius did good service to his contemporaries by his translations of many Greek works into Latin; and by these translations some works, the originals of which have perished, have been handed down to us. His name, however, is now perhaps chiefly remembered for his chronological labours. It was Dionysius who introduced the method of reckoning the Christian era which we now use (see CHRONOLOGY). His friend Cassiodorus depicts in glowing terms the character of Dionysius as a saintly ascetic, and praises his wisdom and simplicity, his accomplishments and his lowly-mindedness, his power of eloquent speech and his capacity of silence. He died at Rome, some time before A.D. 550.

His works have been published in Migne, *Patrologia Latina*, tome 67; see especially A. Tardif, *Histoire des sources du droit canonique* (Paris, 1897), and D. Pitra, *Analecta novissima, Spicilegium Solesmensis continuatio*, vol. i. p. 36 (Paris, 1885).

DIONYSIUS HALICARNASSENSIS ("of Halicarnassus"), Greek historian and teacher of rhetoric, flourished during the reign of Augustus. He went to Rome after the termination of the civil wars, and spent twenty-two years in studying the Latin language and literature and preparing materials for his history. During this period he gave lessons in rhetoric, and enjoyed the society of many distinguished men. The date of his death is unknown. His great work, entitled *Ῥωμαϊκὴ ἀρχαιολογία* (Roman Antiquities), embraced the history of Rome from the mythical period to the beginning of the first Punic War. It was divided into twenty books,—of which the first nine remain entire, the tenth and eleventh are nearly complete, and the remaining books exist in fragments in the excerpts of Constantine Porphyrogenitus and an epitome discovered by Angelo Mai in a Milan MS. The first three books of Appian, and Plutarch's *Life of Camillus* also embody much of Dionysius. His chief object was to reconcile the Greeks to the rule of Rome, by dilating upon the good qualities of their conquerors. According to him, history is philosophy teaching by examples, and this idea he has carried out from the point of view of the Greek rhetorician. But he has carefully consulted the best authorities, and his work and that of Livy are the only connected and detailed extant accounts of early Roman history.

Dionysius was also the author of several rhetorical treatises, in which he shows that he has thoroughly studied the best Attic models.—*The Art of Rhetoric* (which is rather a collection of

essays on the theory of rhetoric), incomplete, and certainly not all his work; *The Arrangement of Words* (Περὶ συνθέσεως ὀνομάτων), treating of the combination of words according to the different styles of oratory; *On Imitation* (Περὶ μιμήσεως), on the best models in the different kinds of literature and the way in which they are to be imitated—a fragmentary work; *Commentaries on the Attic Orators* (Περὶ τῶν Ἀρχαίων ἑλληνῶν ὁμιλημάτων), which, however, only deal with Lysias, Isaeus, Isocrates and (by way of supplement) Dinarchus; *On the admirable Style of Demosthenes* (Περὶ τῆς λεκτικῆς Δημοσθένους δεινότητος); and *On the Character of Thucydides* (Περὶ τοῦ Θουκυδίδου χαρακτήρος), a detailed but on the whole an unfair estimate. These two treatises are supplemented by letters to Cn. Pompeius and Ammaeus (two).

Complete edition by J. J. Reiske (1774-1777); of the *Archaeologia* by A. Kiesling and V. Prou (1886) and C. Jacoby (1885-1891); Opuscula by Usener and Radermacher (1899); Eng. translation by E. Spelman (1758). A full bibliography of the rhetorical works is given in W. Rhys Roberts's edition of the *Three Literary Letters* (1901); the same author published an edition of the *De compositione verborum* (1910, with trans.); see also M. Egger, *Densy's de Heficarnensis* (1902), a very useful treatise. On the sources of Dionysius see O. Bocksch, "De fontibus Dion. Halicarnassensis" in *Leipziger Studien*, xvii. (1895). Cf. also J. E. Sandys, *Hist. of Class. Schol.* i. (1906).

DIONYSIUS PERIEGETES, author of a Περὶ γῆς τῆς οὐρανόθεν, a description of the habitable world in Greek hexameter verse, written in a terse and elegant style. Nothing certain is known of the date or nationality of the writer, but there is some reason for believing that he was an Alexandrian, who wrote in the time of Hadrian (some put him as late as the end of the 3rd century). The work enjoyed a high degree of popularity in ancient times as a school-book; it was translated into Latin by Rufus Festus Avienus, and by the grammarian Priscian. The commentary of Eustathius is valuable.

The best editions are by G. Bernhardt (1828) and C. Müller (1861) in their *Geographica Graeca minores*; see also E. H. Bunbury, *Ancient Geography* (ii. p. 480), who regards the author as flourishing from the reign of Nero to that of Trajan, and U. Bernays, *Studien zu Dion. Perieg.* (1905). There are two old English translations: T. Twinn (1572, black letter), J. Free (1789, blank verse).

DIONYSIUS TELMAHARENSIS ("of Tell-Mahré"), patriarch or supreme head of the Syrian Jacobite Church during the years 818-848, was born at Tell-Mahré near Rakka (ar-Rakkaḥ) on the Balikh. He was the author of an important historical work, which has seemingly perished except for some passages quoted by Barhebraeus and an extract found by Assemani in *Cod. Vat.* 144 and published by him in the *Bibliotheca orientalis* (ii. 72-77). He spent his earlier years as a monk at the convent of Ken-nehré on the upper Euphrates; and when this monastery was destroyed by fire in 815, he migrated northwards to that of Kaisim in the district of Samosata. At the death of the Jacobite patriarch Cyriacus in 817, the church was agitated by a dispute about the use of the phrase "heavenly bread" in connexion with the Eucharist. An anti-patriarch had been appointed in the person of Abraham of Kartamin, who insisted on the use of the phrase in opposition to the recognized authorities of the church. The council of bishops who met at Rakka in the summer of 818 to choose a successor to Cyriacus had great difficulty in finding a worthy occupant of the patriarchal chair, but finally agreed on the election of Dionysius, hitherto known only as an honest monk who devoted himself to historical studies. Sorely against his will he was brought to Rakka, ordained deacon and priest on two successive days, and raised to the supreme ecclesiastical dignity on the 1st of August. From this time he showed the utmost zeal in fulfilling the duties of his office, and undertook many journeys both within and without his province. The ecclesiastical schism continued unhealed during the thirty years of his patriarchate. The details of this contest, of his relations with the caliph Ma'mūn, and of his many travels—including a journey to Egypt, on which he viewed with admiration the great Egyptian monuments,—are to be found in the *Ecclesiastical Chronicle* of Barhebraeus.¹ He died in 848, his last days having been especially

embittered by Mahomedan oppression. We learn from Michael the Syrian that his *Annals* consisted of two parts each divided into eight chapters, and covered a period of 260 years, viz. from the accession of the emperor Maurice (582-583) to the death of Theophilus (842-843).

In addition to the lost *Annals*, Dionysius was from the time of Assemani until 1896 credited with the authorship of another important historical work—a *Chronicle*, which in four parts narrates the history of the world from the creation to the year A.D. 774-775 and is preserved entire in *Cod. Vat.* 162. The first part (edited by Tullberg, Upsala, 1850) reaches to the epoch of Constantine the Great, and is in the main an epitome of the Eusebian Chronicle.² The second part reaches to Theodosius II. and follows closely the *Ecclesiastical History* of Socrates; while the third, extending to Justin II., reproduces the second part of the *History* of John of Asia or Ephesus, and also contains the well-known chronicle attributed to Joshua the Stylite. The fourth part³ is not like the others a compilation, but the original work of the author, and reaches to the year 774-775—apparently the date when he was writing. On the publication of this fourth part by M. Chabot, it was discovered and clearly proved by Nöldeke (*Vierteljahrsschrift für orient. Archäol. u. Gesch.*, xvii. 321-327), who independently reached the same conclusion, that Assemani's opinion was a mistake, and that the chronicle in question was the work not of Dionysius of Tell-Mahré but of an earlier writer, a monk of the convent of Zukūn near Amid (Diarbekr) on the upper Tigris. Though the author was a man of limited intelligence and destitute of historical skill, yet the last part of his work at least has considerable value as a contemporary account of events during the middle period of the 8th century. (N. M.)

DIONYSIUS THRAΞ (so called because his father was a Thracian), the author of the first Greek grammar, flourished about 200 B.C. He was a native of Alexandria, where he attended the lectures of Aristarchus, and afterwards taught rhetoric in Rhodes and Rome. His *Τέχνη γραμματική*, which we possess (though probably not in its original form), begins with the definition of grammar and its functions. Dealing next with accent, punctuation marks, sounds and syllables, it goes on to the different parts of speech (eight in number) and their inflections. No rules of syntax are given, and nothing is said about style. The authorship of Dionysius was doubted by many of the early middle-age commentators and grammarians, and in modern times its origin has been attributed to the oecumenical college founded by Constantine the Great, which continued in existence till 730. But there seems no reason for doubt; the great grammarians of imperial times (Apollonius Dyscolus and Herodian) were acquainted with the work in its present form, although, as was natural considering its popularity, additions and alterations may have been made later. The *τέχνη* was first edited by J. A. Fabricius from a Hamburg MS. and published in his *Bibliotheca Graeca*, vi. (ed. Harles). An Armenian translation, belonging to the 4th or 5th century, containing five additional chapters, was published with the Greek text and a French version, by M. Cirbied (1830). Dionysius also contributed much to the criticism and elucidation of Homer, and was the author of various other works—amongst them an account of Rhodes, and a collection of *Mόλεραι* (literary studies), to which the considerable fragment in the *Stromata* (v. 8) of Clement of Alexandria probably belongs.

Editions, with scholia, by I. Bekker in *Anecdota Graeca*, ii. and G. Uhlig (1884), reviewed exhaustively by P. Egenolf in *Burnian's Jahresbericht*, vol. xvi. (1888); Scholia, ed. A. Hilgard (1901); see also W. Hörchelmann, *De Dionysii Thracis interpretibus veteribus* (1874); J. E. Sandys, *Hist. of Classical Scholarship*, i. (1906).

DIONYSUS (probably = "son of Zeus," from Διὸς υἱός, a Thracian word for "son"), in Greek mythology, originally a nature god of fruitfulness and vegetation, especially of the vine; hence, distinctively, the god of wine. The names Bacchus (Βάκχος, in use among the Greeks from the 5th

¹ Ed. Abbeloos and Lamy, i. 343-386; cf. Wright, *Syriac Literature*, 196-200, and Chabot's introduction to his translation of the fourth part of the *Chronicle* of (pseudo) Dionysius.

² See the studies by Siegfried and Gelzer, *Eusebii canonum epitoma ex Dionysii Telmaharensis chronico petita* (Leipzig, 1884), and von Gutschmid, *Untersuchungen über die syrische Epitome der Eusebischen Canonen* (Stuttgart, 1886).

³ Text and translation by J.-B. Chabot (Paris, 1895).

century), Sabazius, and Bassareus, are also Thracian names of the god. The two first (like Iacchus, Bromius and Euios) have been connected with the loud "shout" ($\alpha\beta\alpha\zeta\epsilon\omega = \beta\alpha\zeta\epsilon\omega = \epsilon\beta\alpha\zeta\epsilon\omega$) of his worshippers, Bassareus with $\beta\alpha\sigma\alpha\rho\alpha\upsilon\sigma$, the fox-skin garments of the Thracian Bacchanals. It has been suggested (J. E. Harrison *Prolegomena to Greek Religion*) that Sabazius and Bromius = "beer-god," "god of a cereal intoxicant" (cf. Illyrian *sabasis* and modern Greek $\beta\alpha\upsilon\sigma\alpha$, "oats"), while W. Ridgeway (*Classical Review*, January 1896), comparing Apollo Smintheus, interprets Bassareus as "he who keeps away the foxes from the vineyards" (for various interpretations of these and other cult-titles, see O. Gruppe, *Griechische Mythologie*, II, pp. 1408, 1532, especially the notes).

In Homer, notwithstanding the frequent mention of the use of wine, Dionysus is never mentioned as its inventor or introducer, nor does he appear in Olympus; Hesiod is the first who calls wine the gift of Dionysus. On the other hand, he is spoken of in the *Iliad* (vi. 130 foll.), a passage belonging to the latest period of epic, as "raging" an epithet that indicates that in those comparatively early times the orgiastic character of his worship was recognized. In fact, Dionysus may be regarded under two distinct aspects: that of a popular national Greek god of wine and cheerfulness, and that of a foreign deity, worshipped with ecstatic and mysterious rites introduced from Thrace. According to the usual tradition, he was born at Thebes—originally the local centre of his worship in Greece—and was the son of Zeus, the fertilizing rain god, and Semele, the daughter of Cadmus, a personification of earth. Before the child was mature, Zeus appeared to Semele at her request in his majesty as god of lightning, by which she was killed, but the infant was saved from the flames by Zeus (or Hermes). The epithet *repucubros*, originally referring to an ivy-crowned, pillar-shaped fetish of the god, afterwards gave rise to the legend of a miraculous growth of ivy "round the pillars" of the royal palace, whereby the infant Dionysus was preserved from the flames. Zeus took him up, enclosed him within his own thigh till he came to maturity, and then brought him to the light, so that he was twice born; it was to celebrate this double birth that the *dietyrambos* (also used as an epithet of the god) was sung (see *Elym. Mag.* s.v.). It has been suggested that this is an allusion to the *couvade* of certain barbarous tribes, amongst whom it is customary, when a child is born, for the husband to take to his bed and receive medical treatment, as if he shared the pains of maternity (see COUVADE, and references there). Dionysus was then conveyed by Hermes to be brought up by the nymphs of Nysa, a purely imaginary spot, afterwards localized in different parts of the world, which claimed the honour of having been the birthplace of the god. As soon as Dionysus was grown up, he started on a journey through the world, to teach the cultivation of the vine and spread his worship among men. While so engaged he met with opposition, even in his own country, as in the case of Pentheus, king of Thebes, who opposed the orgiastic rites introduced by Dionysus among the women of Thebes, and, having been discovered watching one of these ceremonies, was mistaken for some animal of the chase, and slain by his own mother (see A. G. Bather, *Journ. Hell. Studies*, xiv. 1894). A similar instance is that of Lycurgus, a Thracian king, from whose attack Dionysus saved himself by leaping into the sea, where he was kindly received by Thetis. Lycurgus was blinded by Zeus and soon died, or became frantic and bewed down his own son, mistaking him for a vine. At Orchomenus, the three daughters of Minyas refused to join the other women in their nocturnal orgies, and for this were transformed into birds (see AGRIONIA). These and similar stories point to the vigorous resistance offered to the introduction of the mystic rites of Dionysus, in places where an established religion already existed. On the other hand, when the god was received hospitably he repaid the kindness by the gift of the vine, as in the case of Icarus of Attica (see ELYCONE).

The worship of Dionysus was actively conducted in Asia Minor, particularly in Phrygia and Lydia. Here, as Sabazius, he was associated with the Phrygian goddess Cybele, and was followed in his expeditions by a *thiasos* (retinue) of centaurs and satyrs, with

Pan and Silenus. In Lydia his triumphant return from India was celebrated by an annual festival on Mount Tmolus; in Lydia he assumed the long beard and long robe which were afterwards given him in his character of the "Indian Bacchus," the conqueror of the East, who, after the campaigns of Alexander, was reported to have advanced as far as the Ganges. The other incidents in which he appears in a purely triumphal character are his transforming into dolphins the Tyrrhene pirates who attacked him, as told in the Homeric hymn to Dionysus and represented on the monument of Lycicrates at Athens, and his part in the war of the gods against the giants. The former story has been connected with the sailors' custom of hanging vine leaves, ivy and bunches of grapes round the masts of vessels in honour of vintage festivals. The adventure with the pirates occurred on his voyage to Naxos, where he found Ariadne abandoned by Theseus. At Naxos Ariadne (probably a Cretan goddess akin to Aphrodite) was associated with Dionysus as his wife, by whom he was the father of Oenopion (wine-drinker), Staphylus (grape), and Euanthes (blooming), and their marriage was annually celebrated by a festival. Having compelled all the world to recognize his divinity, he descended to the underworld to bring up his mother, who was afterwards worshipped with him under the name of Thyone ("the raging"), he himself being called after her Thyoneus.

Another phase in the myth of Dionysus originated in observing the decay of vegetation in winter, to suit which he was supposed to be slain and to join the deities of the lower world. This phase of his character was developed by the Orphic poets, he having here the name of Zagreus ("torn in pieces"), and being no longer the Theban god, but a son of Zeus and Persephone. The child was brought up secretly, watched over by Curetes; but the jealous Hera discovered where he was, and sent Titans to the spot, who, finding him at play, tore him to pieces, and cooked and ate his limbs, while Hera gave his heart to Zeus. The tearing in pieces is referred by some to the torture experienced by the grape (*Naturgeschichte*) when crushed for making into wine (cf. Burns's *John Barleycorn*); but it is better to refer it to the tearing of the flesh of the victim at sacrifices at which the deity or the sacred animal was slain, and sacramentally eaten raw (cf. the title *εὐπαρής* given to Dionysus in certain places, probably pointing to human sacrifice.) To connect this with the myth of the Theban birth of Dionysus, it is said that Zeus gave the child's heart to Semele, or himself swallowed it and gave birth to the new Dionysus (called Iacchus by his worshippers' cry of rejoicing), who was cradled and swung in a winnowing fan (*Μαύος*; see J. E. Harrison, *Journ. Hellenic Studies*, xxiii.), the swinging being supposed to act as a charm in awakening vegetation from its winter sleep. The conception of Zagreus, or the winter Dionysus, appears to have originated in Crete, but it was accepted also in Delphi, where his grave was shown, and sacrifice was secretly offered at it annually on the shortest day. The story is in many respects similar to that of Osiris. According to others, Zagreus was originally a god of the chase, who became a hunter of men and a god of the underworld, more akin to Hades than to Dionysus (see also TITANS).

Dionysus further possessed the prophetic gift, and his oracle at Delphi was as important as that of Apollo. Like Hermes, Dionysus was a god of the productiveness of nature, and hence Priapus was one of his regular companions, while not only in the mysteries but in the rural festivals his symbol, the phallus, was carried about ostentatiously. His symbols from the animal kingdom were the bull (perhaps a totemistic attribute and identified with him), the panther, the lion, the tiger, the ass, the goat, and sometimes also the dolphin and the snake. His personal attributes are an ivy wreath, the thyrsus (a staff with pine cone at the end), the laurel, the pine, a drinking cup, and sometimes the horn of a bull on his forehead. Artistically he was represented mostly either as a youth of soft, nearly feminine form, or as a bearded and draped man, but frequently also as an infant, with reference to his birth or to his bringing up in "Nysa." His earliest images were of wood with the branches still attached in parts, whence he was called Dionysus Dendrites, an allusion to his

protection of trees generally (according to Pherecydes in C. W. Müller, *Frag. Hist. Graec.* iv. p. 637, the word *vōva* signified "tree"). It is suggested that the cult of Dionysus absorbed that of an old tree-spirit. He was figured also, like Hermes, in the form of a pillar or term surmounted by his head. For the connexion of Dionysus with Greek tragedy see DRAMA.

See Farnell, *Cults of the Greek States*, v. (1910); also O. Rapp, *Beziehungen des Dionysuskultus zu Thrakien* (1882); O. Ribbeck, *Anfänge und Ent Wickelung des Dionysuskultes in Attica* (1869); A. Lang, *Myth, Ritual and Religion*, ii. p. 241; L. Dyer, *The Gods in Greece* (1891); J. E. Harrison, *Prolegomena to the Study of Greek Religion* (1903); J. G. Frazer, *The Golden Bough*, ii. (1906), pp. 160, 291, who regards the bull and goat form of Dionysus as expressions of his proper character as a deity of vegetation; F. A. Voigt in Roscher's *Lexikon der Mythologie*; L. Preller, *Griechische Mythologie* (4th ed. by C. Robert); F. Lenormant (s.v. "Bacchus") in Daremberg and Saglio's *Dictionnaire des antiquités*; O. Kern in Pauly-Wissowa's *Realencyclopädie* (with list of cult titles); W. Pater, *Greek Studies* (1895); E. Rohde, *Psyche*, ii., who finds the origin of the Hellenic belief in the immortality of the soul in the "enthusiastic" rites of the Thracian Dionysus, which lifted persons out of themselves, and exalted them to a fancied equality with the gods; O. Gruppe, *Griechische Mythologie und Religionsgeschichte*, ii. (1907), who considers Boeotia, not Thrace, to have been the original home of Dionysus; P. Foucart, "Le Culte de Dionysos en Attique" in *Mémoires de l'Institut national de France*, xxxvii. (1906), who finds the prototype of Dionysus in Egypt. *The Great Dionysian Myth* (1877-1878) by R. Brown contains a wealth of material, but is weak in scholarship. For a striking survival of Dionysiac rites in Thrace (Bizye), see Dawkins, in *J.H.S.* (1906), p. 191.

DIOPHANTUS, of Alexandria, Greek algebraist, probably flourished about the middle of the 3rd century. Not that this date rests on positive evidence. But it seems a fair inference from a passage of Michael Psellus (*Diophantus*, ed. P. Tannery, ii. p. 38) that he was not later than Anatolius, bishop of Laodicea from A.D. 270, while he is not quoted by Nicomachus (fl. c. A.D. 100), nor by Theon of Smyrna (c. A.D. 130), nor does Greek arithmetic as represented by these authors and by Iamblichus (end of 3rd century) show any trace of his influence, facts which can only be accounted for by his being later than those arithmeticians at least who would have been capable of understanding him fully. On the other hand he is quoted by Theon of Alexandria (who observed an eclipse at Alexandria in A.D. 365); and his work was the subject of a commentary by Theon's daughter Hypatia (d. 415). The *Arithmetica*, the greatest treatise on which the fame of Diophantus rests, purports to be in thirteen Books, but none of the Greek MSS. which have survived contain more than six (though one has the same text in seven Books). They contain, however, a fragment of a separate tract on *Polygonal Numbers*. The missing books were apparently lost early, for there is no reason to suppose that the Arabs who translated or commented on Diophantus ever had access to more of the work than we now have. The difference in form and content suggests that the *Polygonal Numbers* was not part of the larger work. On the other hand the *Porisms*, to which Diophantus makes three references ("we have it in the *Porisms* that . . ."), were probably not a separate book but were embodied in the *Arithmetica* itself, whether placed all together or, as Tannery thinks, spread over the work in appropriate places. The "Porisms" quoted are interesting propositions in the theory of numbers, one of which was clearly that the *difference between two cubes can be resolved into the sum of two cubes*. Tannery thinks that the solution of a complete quadratic promised by Diophantus himself (I. def. 11), and really assumed later, was one of the *Porisms*.

Among the great variety of problems solved are problems leading to determinate equations of the first degree in one, two, three or four variables, to determinate quadratic equations, and to indeterminate equations of the first degree in one or more variables, which are, however, transformed into determinate equations by arbitrarily assuming a value for one of the required numbers, Diophantus being always satisfied with a rational, even if fractional, result and not requiring a solution in integers. But the bulk of the work consists of problems leading to indeterminate equations of the second degree, and these universally take the form that one or two (and never more) linear or quadratic functions of one variable x are to be made rational square numbers by finding a suitable value for x . A few problems lead to indeterminate equations of the third and fourth degrees, an easy indeterminate equation of the sixth degree being

also found. The general type of problem is to find two, three or four numbers such that different expressions involving them in the first and second, and sometimes the third, degree are squares, cubes, partly squares and partly cubes, &c. E.g.—*To find three numbers such that the product of any two added to the sum of those two gives a square* (III. 15, ed. Tannery); *To find four numbers such that, if we take the square of their sum = any one of them singly, all the resulting numbers are squares* (III. 23); *To find two numbers such that their product = their sum gives a cube* (IV. 29); *To find three squares such that their continued product added to any one of them gives a square* (V. 21). Book VI. contains problems of finding rational right-angled triangles such that different functions of their parts (the sides and the area) are squares. A word is necessary on Diophantus' notation. He has only one symbol (written somewhat like a final sigma) for an unknown quantity, which he calls *ἀριθμός* (defined as "an undefined number of units"); the symbol may be a contraction of the initial letters $\sigma\alpha$, as $\Delta\gamma$, $K\gamma$, $\Delta\gamma\Delta$, &c., are for the powers of the unknown ($\delta\iota\omicron\upsilon\sigma\alpha\mu\epsilon\tau\alpha$, square; $\kappa\upsilon\beta\omicron\varsigma$, cube; $\delta\iota\omicron\upsilon\sigma\alpha\mu\epsilon\tau\alpha\mu\epsilon\tau\alpha$, fourth power, &c.). The only other algebraical symbol is Λ for minus; plus being expressed by merely writing terms one after another. With one symbol for an unknown, it will easily be understood what scope there is for adroit assumptions, for the required numbers, of expressions in the one unknown which are at once seen to satisfy some of the conditions, leaving only one or two to be satisfied by the particular value of x to be determined. Often assumptions are made which lead to equations in x which cannot be solved "rationally," i.e. would give negative, surd or imaginary values; Diophantus then traces how each element of the equation has arisen, and formulates the auxiliary problem of determining how the assumptions must be corrected so as to lead to an equation (in place of the "impossible" one) which can be solved rationally. Sometimes his x has to do duty twice, for different unknowns, in one problem. In general his object is to reduce the final equation to a simple one by making such an assumption for the side of the square or cube to which the expression in x is to be equal as will make the necessary number of coefficients vanish. The book is valuable also for the propositions in the theory of numbers, other than the "porisms," stated or assumed in it. Thus Diophantus knew that no number of the form $8n+7$ can be the sum of three squares. He also says that, if $2n+1$ is to be the sum of two squares, " n must not be odd" (i.e. no number of the form $4n+3$, or $4n-1$, can be the sum of two squares), and goes on to add, practically, the condition stated by Fermat, "and the double of it (n) increased by one, when divided by the greatest square which measures it, must not be divisible by a prime number of the form $4n-1$," except for the omission of the words "when divided by . . . measures it."

AVTHORITIES.—The first to publish anything on Diophantus in Europe was Rafael Bombelli, who embodied in his Algebra (1572) all the problems of Books I.-IV., and some of Book V., interspersing them with his own problems. Next Xylander (Wilhelm Holzmann) published a Latin translation (Basel, 1575), an altogether meritorious work, especially having regard to the difficulties he had with the text of his MS. The Greek text was first edited by C. G. Bachet (*Diophanti Alexandrini arithmeticonum libri sex, et de numeris multangularibus liber unus, nunc primum graeco et latine editis abque absolutissimis commentariis illustrati* . . . Lutetiae Parisiorum . . . MDCXXI.). A reprint of 1670 is only valuable because it contains P. de Fermat's notes; as far as the Greek text is concerned it is much inferior to the other. There are two German translations, one by Otto Schulz (1822) and the other by G. Wertheim (Leipzig, 1890), and an English edition in modern notation (T. L. Heath, *Diophantus of Alexandria: A Study in the History of Greek Algebra* (Cambridge, 1885). The Greek text has now been definitively edited (with Latin translation, Scholia, &c.) by P. Tannery (Teubner, vol. I, 1893; vol. II, 1895). General accounts of Diophantus' work are to be found in H. Hankel and M. Cantor's histories of mathematics, and more elaborately analysed are those of Neuselmann (*Die Algebra der Griechen*, Berlin, 1842) and G. Loria (*La Scienza esatta Algebraica Greca*, libro v., Modena, 1902, pp. 95-158). (T. L. H.)

DIOPSIDE, an important member of the pyroxene group of rock-forming minerals. It is a calcium-magnesium metasilicate, $\text{CaMg}(\text{SiO}_3)_2$, and crystallizes in the monoclinic system. Usually some iron is present replacing magnesium, and with this predominates there is a passage to hedenbergite, $\text{CaFe}(\text{SiO}_3)_2$, a closely allied variety of monoclinic pyroxene. These are distinguished from augite by containing little or no aluminium. Diopside is colourless, white, pale green to dark green or nearly black in colour, the depth of the colour depending on the amount of iron present. The specific gravity and optical constants also vary with the chemical composition; the sp. gr. of diopside is 3.2, increasing to 3.6 in hedenbergite, and the angle of optical extinction in the plane of symmetry varies between 38° and 47° in the two extremes of the series. Crystals are usually prismatic in habit with a rectangular cross-section as shown in the figure: the angle between the prism faces m , parallel to which there are perfect cleavages, is $92^\circ 50'$.

Several varieties, depending on differences in structure and chemical composition, have been distinguished, viz. coccolite (from *σκοκος*, a grain), a granular variety; salite or sahite, from Sala in Sweden; malacolite; diallage; violane, a lamellar variety of a dark violet-blue colour; chrome-diopside, a bright green variety containing a small amount of chromium; and many others. Belonging to the same series with diopside and hedenbergite is a manganese pyroxene, known as schefferite, which has the composition (Ca, Mg) (Fe, Mn) (SiO₃).

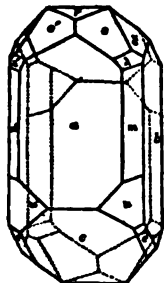

Diopside is the characteristic pyroxene of metamorphic rocks, occurring especially in crystalline limestones, and often in association with garnet and epidote. It is also an essential constituent of some pyroxene-granites, diorites and a few other igneous rocks, but the characteristic pyroxene of this class of rocks is augite. Fine transparent crystals of a pale green colour occur, with crystals of yellowish-red garnet (hessonite) and chlorite, in veins traversing serpentine in the Ala valley near Turin in Piedmont: a crystal of this variety ("alalite") is represented in the accompanying figure. These, as well as the long, transparent, bottle-green crystals from the Zillerthal in the Tyrol, have occasionally been cut as gem-stones. Good crystals have been found also at Achmatovsk near Zlatoust in the Urals, Traversella near Ivrea in Piedmont ("traversellite"), Nordmark in Sweden, Monroe in New York, Burgess in Lanark county, Ontario, and several other places; at Nordmark the large, rectangular black crystals occur with magnetite in the iron mines. (L. J. S.)

DIOPTASE, a rare mineral species consisting of acid copper orthosilicate, H₂CuSiO₆, crystallizing in the parallel-faced hemihedral class of the rhombohedral system. The degree of symmetry is the same as in the mineral phenacite, there being only an axis of triad symmetry and a centre of symmetry. The crystals have the form of a hexagonal prism π terminated by a rhombohedron r , the alternate edges between these being sometimes replaced by the faces of a rhombohedron s . The faces are striated parallel to the edges between r , s and π . There are perfect cleavages parallel to the faces of a rhombohedron which truncate the polar edges of r : from the cleavage cracks internal reflections are often to be seen in the crystal, and it was on account of this that the mineral was named diophtase, by

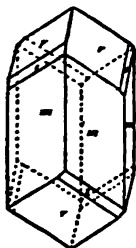

R. J. Haty in 1797, from *διοφτᾶσις*, "to see into." The crystals vary from transparent to translucent with a vitreous lustre, and are bright emerald-green in colour; they thus have a certain resemblance to emerald, hence the early name emerald-copper (German, *Kupfer-Smaragd*). Hardness 5; sp. gr. 3.3. The mineral is decomposed by hydrochloric acid with separation of gelatinous silica. At a red heat it blackens and gives off water. The fine crystals from Mount Altyn-Tube on the western slopes of the Altai Mountains in the Kirghiz Steppes, Asiatic Russia, line cavities in a compact limestone; they were first sent to Europe in 1785 by Achir Mahmed, a Bucharian merchant, after whom the mineral has been named archirite. More recently, in 1890, good crystals of similar habit, but rather darker in colour, have been found with quartz and malachite near Komba in the French Congo. As drusy crystalline crusts it has been found at Copiapo in Chile and in Arizona.

Diophtase has occasionally been used as a gem-stone, especially in Russia and Persia; it has a fine colour, but a low degree of hardness and the transparency is imperfect. (L. J. S.)

DIORITE (from the Gr. *διορίτης* to distinguish, from *διᾶ* through, *ἄρος*, a boundary), in petrology, the name given by Haty to a family of rocks of granitic texture, composed of plagioclase feldspar and hornblende. As they are richer in the dark

coloured ferromagnesian minerals they are usually grey or dark grey, and have a higher specific gravity than granite. They also rarely show visible quartz. But there are diorites of many kinds, as the name applies rather to a family of rocks than to a single species. Some contain biotite, others augite or hypersthene; many have a small amount of quartz. Orthoclase is rarely entirely absent, and when it is fairly common the rock becomes a tonalite; in this way a transition is furnished between diorites and granites. It is rare to find the pure types of "hornblende-diorite," "augite-diorite," &c., but in most cases the rocks contain two or more ferromagnesian silicates, and such combinations as "hornblende-biotite-diorite" are commonest in nature.

The feldspar of the diorites ranges in composition from oligoclase to labradorite, and is often remarkably zonal, the external layers being more alkaline than the internal. Small fluid enclosures and black grains, probably iron oxides, often occur in it in great numbers. Weathering produces epidote, calcite, sericite and kaolin. The biotite is always brown or yellow; the hornblende usually green, but sometimes brown or yellowish brown in those diorites which have affinities to lamprophyres. The augite is nearly always green but sometimes has a reddish tinge; bronzite and hypersthene have their usual green and brown shades. Apatite, iron oxides and zircon are almost invariably present; sphene, garnet and orthite are occasionally observed; calcite, chlorite, muscovite, kaolin, epidote and basite are secondary. The structure is not essentially different from that of granite. The ferromagnesian minerals crystallize comparatively early and have some idiomorphism; the feldspar usually follows and only in part shows good crystalline outlines. Orthoclase and quartz, if present, are last to separate out, and fill the spaces between the other minerals; often they interpenetrate to form micropegmatite. In many diorites the plagioclase feldspar has crystallized before the hornblende, which consequently has less perfect outlines and forms irregular plates which enclose sharply formed individuals of feldspar. This produces the ophitic structure (very common also in the dolerites). More rarely biotite and augite exhibit the same relations to the plagioclase. Orbicular structure also occasionally appears in these rocks; in fact the orbicular diorite of Corsica (also called "Napoleonite" or "Corsite") was for a long time the best-known example of this structure. The rock seems composed of spheroids, about an inch in diameter, surrounded by a smaller amount of dark-coloured dioritic matrix. The spheroids have a radiate structure and often show concentric dark and pale shells. These consist of hornblende (dark green) and basic plagioclase feldspar, labradorite and bytownite (grey or nearly white). Occasionally diorites have a parallel banded or foliated structure, but these must not be confounded with the epidiorites, which are metamorphic rocks and also have a conspicuous foliation.

Diorites must also be distinguished from hornblende gabbros, which contain more basic feldspars, rarely quartz and occasionally olivine; but the boundary lines between diorites and gabbros are admittedly somewhat vague, e.g. some authors would call rocks gabbro which others would regard as augite-diorite. The hornblendites differ from the diorites in containing little feldspar, and consist principally of hornblende. Among varietal designations given to rocks of the diorite family are "banatite" for an augite-diorite with or without quartz (from the Schemnitz district), "granodiorite" for a quartz-hornblende-diorite (essentially the same as tonalite) from California, &c., "adamellite" for the quartz-mica-diorite or tonalite of Monte Adamello (Alps), "ornite" for a hornblende-diorite rich in feldspar, from Sweden. (J. S. F.)

DIP (Old Eng. *dyppan*, connected with the common Teutonic root seen in "deep"), the angle which the magnetic needle makes with the horizon. A freely suspended magnetic needle will not maintain a horizontal position except at the magnetic equator. Over the N. magnetic pole the north-seeking end of the needle points directly downwards and dips at an intermediate angle at intermediate distances between the magnetic poles and equator. There are secular progressive variations of dip as well as of declination and the maxima are independent of each other. †



1756 the dip at London was $71^{\circ} 50'$, in 1730 (max.) $74^{\circ} 45'$, in 1900 $67^{\circ} 9'$. (For Dip Circle see INCLINOMETER.)

DIPHENYL (phenyl benzene), $C_6H_5.C_6H_5$, a hydrocarbon found in that fraction of the coal-tar distillate boiling between 240 - $300^{\circ} C.$, from which it may be obtained by warming with sulphuric acid, separating the acid layer and strongly cooling the undissolved oil. It may be artificially prepared by passing benzene vapour through a red-hot tube; by the action of sodium on bromobenzene dissolved in ether; by the action of stannous chloride on phenyldiazonium chloride; or by the addition of solid phenyldiazonium sulphate to warm benzene (R. Möhlau, *Berichte*, 1893, 26, 1997) $C_6H_5N_2.HSO_4 + C_6H_6 = H_2SO_4 + N_2 + C_6H_5.C_6H_5$. L. Gattermann (*Berichte*, 1890, 23, 1226) has also prepared it by the decomposition of a solution of phenyldiazonium sulphate with alcohol and copper powder. It crystallizes in plates (from alcohol) melting at 70 - $71^{\circ} C.$ and boiling at $254^{\circ} C.$ It is oxidized by chromic acid in glacial acetic acid solution to benzoic acid, dilute nitric acid and chromic acid mixture being without effect. It is not reduced by hydriodic acid and phosphorus, but sodium in the presence of amyl alcohol reduces it to tetrahydrodiphenyl $C_{12}H_{14}$.

Many substitution derivatives are known: the monosubstitution derivatives being capable of existing in three isomeric forms. Of the disubstitution derivatives the most important are those derived from diparadiazinodiphenyl or benzidine (q.v.).

Orthoaminodiphenyl, , is prepared by the action of bromine and caustic soda on orthophenylbenzamide (R. Hirsch, *Berichte*, 1892, 25, 1974); when its vapour is passed over heated lime, carbazol (q.v.) is formed.

Diorthodiazinodiphenyl, , is obtained by the reduction of the corresponding nitro compound (obtained by the action of ethyl nitrite at $0^{\circ} C.$ on metadinitrobenzidine hydrochloride). Its tetrazo compound on reduction gives a hydrazine which, on warming with hydrochloric acid at $150^{\circ} C.$, decomposes into ammonium

chloride and phenazone,  ($C_{12}H_8N_2$). One of the most important derivatives of diphenyl, from the theoretical point of view, is *diphenic acid* or diorthodiphenyl carboxylic acid, which can be obtained from diparadiazinodiphenyldiorthocarboxylic acid,  (H_2N and NH_2 from phenanthrene (q.v.), the consti-

tution of which it determines. See BENZIDINE for diparadiazinodiphenyl.

DIPHILUS, of Sinope, poet of the new Attic comedy and contemporary of Menander (342-291 B.C.). Most of his plays were written and acted at Athens, but he led a wandering life, and died at Smyrna. He was on intimate terms with the famous courtesan Gnathæna (Athenæus xiii. pp. 579, 583). He is said to have written 100 comedies, the titles of fifty of which are preserved. He sometimes acted himself. To judge from the imitations of Plautus. (*Casina* from the *Καλοπυραο*, *Asinaria* from the *Ἵραρυς*, *Rudens* from some other play), he was very skillful in the construction of his plots. Terence also tells us that he introduced into the *Adelphi* (ii. 1) a scene from the *Συρανοβήσσας*, which had been omitted by Plautus in his adaptation (*Commoventes*) of the same play. The style of Diphilus was simple and natural, and his language on the whole good Attic; he paid great attention to versification, and was supposed to have invented a peculiar kind of metre. The ancients were undecided whether to class him among the writers of the New or Middle comedy. In his fondness for mythological subjects (*Hercules*, *Theseus*) and his introduction on the stage (by a bold anachronism) of the poets Archilochus and Hipponax as rivals of Sappho, he approximates to the spirit of the latter.

Fragments in H. Koch, *Comicorum Atticorum fragmenta*, ii.; see J. Denis, *La Comédie grecque* (1886), ii. p. 414; R. W. Bond in *Classical Review* (Feb. 1910, with trans. of *Emporos* fragm.).

DIPHTHERIA (from *διφθέρα*, a skin or membrane), the term applied to an acute infectious disease, which is accompanied by

a membranous exudation on a mucous surface, generally on the tonsils and back of the throat or pharynx.

In general the symptoms at the commencement of an attack of diphtheria are comparatively slight, being those commonly accompanying a cold, viz. chilliness and depression. Sometimes more severe phenomena usher in the attack, such as vomiting and diarrhoea. A slight feeling of uneasiness in the throat is experienced along with some stiffness of the back of the neck. When looked at the throat appears reddened and somewhat swollen, particularly in the neighbourhood of the tonsils, the soft palate and upper part of pharynx, while along with this there is tenderness and swelling of the glands at the angles of the jaws. The affection of the throat spreads rapidly, and soon the characteristic exudation appears on the inflamed surface in the form of greyish-white specks or patches, increasing in extent and thickness until a yellowish-looking false membrane is formed. This deposit is firmly adherent to the mucous membrane beneath or incorporated with it, and if removed leaves a raw, bleeding, ulcerated surface, upon which it is reproduced in a short period. The appearance of the exudation has been compared to wet parchment or washed leather, and it is more or less dense in texture. It may cover the whole of the back of the throat, the cavity of the mouth, and the posterior nares, and spread downwards into the air-passages on the one hand and into the alimentary canal on the other, while any wound on the surface of the body is liable to become covered with it. This membrane is apt to be detached spontaneously, and as it loosens it becomes decomposed, giving a most offensive and characteristic odour to the breath. There is pain and difficulty in swallowing, but unless the disease has affected the larynx no affection of the breathing. The voice acquires a snuffing character. When the disease invades the posterior nares an acrid, fetid discharge, and sometimes also copious bleeding, takes place from the nostrils. Along with these local phenomena there is evidence of constitutional disturbance of the most severe character. There may be no great amount of fever, but there is marked depression and loss of strength. The pulse becomes small and frequent, the countenance pale, the swelling of the glands of the neck increases, which, along with the presence of albumen in the urine, testifies to a condition of blood poisoning. Unless favourable symptoms emerge death takes place within three or four days or sooner, either from the rapid extension of the false membrane into the air-passage, giving rise to asphyxia, or from a condition of general collapse, which is sometimes remarkably sudden. In cases of recovery the change for the better is marked by an arrest in the extension of the false membrane, the detachment and expectoration of that already formed, and the healing of the ulcerated mucous membrane beneath. Along with this there is a general improvement in the symptoms, the power of swallowing returns, and the strength gradually increases, while the glandular enlargement of the neck diminishes, and the albumen disappears from the urine. Recovery, however, is generally slow, and it is many weeks before full convalescence is established. Even, however, where diphtheria ends thus favourably, the peculiar sequelæ already mentioned are apt to follow, generally within a period of two or three weeks after all the local evidence of the disease has disappeared. These secondary affections may occur after mild as well as after severe attacks, and they are principally in the form of paralysis affecting the soft palate and pharynx, causing difficulty in swallowing with regurgitation of food through the nose, and giving a peculiar nasal character to the voice. There are, however, other forms of paralysis occurring after diphtheria, especially that affecting the muscles of the eye, which produces a loss of the power of accommodation and consequent impairment of vision. There may be, besides, paralysis of both legs, and occasionally also of one side of the body (hemiplegia). These symptoms, however, after continuing for a variable length of time, almost always ultimately disappear.

Under the name of the *Malum Egyptiacum*, Aretæus in the 2nd century gives a minute description of a disease which in all its essential characteristics corresponds to diphtheria. In the 16th, 17th and 18th centuries epidemics of diphtheria appear to have

frequently prevailed in many parts of Europe, particularly in Holland, Spain, Italy, France, as well as in England, and were described by physicians belonging to those countries under various titles; but it is probable that other diseases of a similar nature were included in their descriptions, and no accurate account of this affection had been published till M. Bretonneau of Tours in 1821 laid his celebrated treatise on the subject before the French Academy of Medicine. By him the term *La Diphthérisie* was first given to the disease.

Great attention has been paid to diphtheria in recent years, with some striking results. Its cause and nature have been definitely ascertained, the conditions which influence its prevalence have been elucidated, and a specific "cure" has been found. In the last respect it occupies a unique position at the present time. In the case of several other zymotic diseases much has been done by way of prevention, little or nothing for treatment; in the case of diphtheria prevention has failed, but treatment has been revolutionized by the introduction of antitoxin, which constitutes the most important contribution to practical medicine as yet made by bacteriology.

The exciting cause of diphtheria is a micro-organism, identified by Klebs and Löffler in 1883 (see PARASITIC DISEASES). It has been shown by experiment that the symptoms of diphtheria, including the after-effects, are produced by a toxin derived from the micro-organisms which lodge in the air-passages and multiply in a susceptible subject. The natural history of the organism outside the body is not well understood, but there is some reason to believe that it lives in a dormant condition in suitable soils. Recent research does not favour the theory that it is derived from defective drains or "sewer gas," but these things, like damp and want of sunlight, probably promote its spread, by lowering the health of persons exposed to them, and particularly by causing an unhealthy condition of the throat, rendering it susceptible to the contagion. Defective drainage, or want of drainage, may also act, by polluting the ground, and so providing a favourable soil for the germ, though it is to be noted that "the steady increase in the diphtheria mortality has coincided, in point of time, with steady improvement in regard of such sanitary circumstances as water supply, sewerage, and drainage" (Thorne Thorne). Cats and cows are susceptible to the diphtheric bacillus, and fowls, turkeys and other birds have been known to suffer from a disease like diphtheria, but other domestic animals appear to be more or less resistant or immune. In human beings the mere presence of the germ is not sufficient to cause disease; there must also be susceptibility, but it is not known in what that consists. Individuals exhibit all degrees of resistance up to complete immunity. Children are far more susceptible than adults, but even children may have the Klebs-Löffler bacillus in their throats without showing any symptoms of illness. Altogether there are many obscure points about this micro-organism, which is apt to assume a puzzling variety of forms. Nevertheless its identification has greatly facilitated the diagnosis of the disease, which was previously a very difficult matter, often determined in an arbitrary fashion on no particular principles.

Diphtheria, as at present understood, may be defined as sore throat in which the bacillus is found; if it cannot be found, the illness is regarded as something else, unless the clinical symptoms are quite unmistakable. One result of this is a large transference of registered mortality from other throat affections, and particularly from croup, to diphtheria. Croup, which never had a well-defined application, and is not recognized by the College of Physicians as a synonym for diphtheria, appears to be dying out from the medical vocabulary in Great Britain. In France the distinction has never been recognized.

Diphtheria is endemic in all European and American countries, and is apparently increasing, but the incidence varies greatly.

It is far more prevalent on the continent than in England, and still more so in the United States and Canada. The following table, compiled from figures collected by Dr Newsholme, shows how London compares with some foreign cities. The figures give the mean death-rate from

diphtheria and croup for the term of years during which records have been kept. The period varies in different cases, and therefore the comparison is only a rough one.

Mean Death-Rates from Diphtheria and Croup per Million living.

New York	1610	Munich	990
Chicago	1400	Milan	990
Buenos Aires	1360	Florence	850
Trieste	1300	Vienna	770
Dresden	1290	Stockholm	750
Berlin	1190	St. Petersburg	650
Boston	1160	Moscow	640
Marseilles	1130	Paris	630
Christiania	1090	Hamburg	490
Budapest	1880	London	386

There is comparatively little diphtheria in India and Japan, but in Egypt, the Cape and Australasia it prevails very extensively among the urban populations. The mortality varies greatly from year to year in all countries and cities. In Berlin, for instance, it has oscillated between a maximum of 2420 in 1883 and a minimum of 340 in 1866; in New York between 2760 in 1877 and 680 in 1868; in Christiania between 3290 in 1887 and 170 in 1871. In some American cities still higher maxima have been recorded. In other words, diphtheria, though always endemic, exhibits at times a great increase of activity, and becomes epidemic or even pandemic. The following table for 1859-99 shows fairly well the periodical rise and fall in England and Wales. Diphtheria and croup are given both separately and together, showing the increasing transference from one to the other of late years. Diphtheria was first entered separately in the year 1859.

Deaths from Diphtheria and Croup per Million living in England and Wales.

Years.	Diphtheria.	Croup.	Diphtheria and Croup.
1859	517	286	803
1860	261	220	481
1861-70	185	246	431
1871-80	121	168	289
1881-90	163	144	307
1891-95	254	70	324
1896-97	269	43	312
1898	244	27	271
1899	293	32	325

The combined figures for diphtheria and croup in later years are:—(1900) 316; (1901) 296; (1902) 255; (1903) 195; (1904) 184; (1905) 174; (1906) 190; (1907) 175; (1908) 166.

Several facts are roughly indicated by the table. It begins with an extremely severe epidemic, which has not been approached since. Then follows a fall extending over twenty years. On the whole this diminution was progressive, though not in reality so steady as the decennial grouping makes it appear, being interrupted by smaller oscillations in single years and groups of years. Still the main fact holds good. After 1880 an opposite movement began, likewise interrupted by minor oscillations, but on the whole progressive, and culminating in the year 1893 with a death-rate of 389, the highest recorded since 1865. After 1896 a marked fall again took place. This is partly accounted for by the use of antitoxin, which only began on a considerable scale in 1895, and did not become general until a year or two later at least. Its effects were only then fully felt. The registrar-general's returns record mortality, not prevalence—that is to say, the number of deaths, not of cases.

On the whole, we get clear evidence of an epidemic rise and fall, which may serve to dispose of some erroneous conceptions. The belief, held until recently, that diphtheria is steadily increasing in Great Britain was obviously premature; it did rise over a series of years, but has now ebbed again. Moreover, the general prevalence during the last thirty years has been notably less than in the previous twelve years. Yet it is during years since 1870 that compulsory education has been in existence and main drainage chiefly carried out. It follows that neither school attendance nor sewer gas exercises such an important influence over the epidemicity of diphtheria as some other conditions.

What are those conditions? Dr Newsholme has advanced the theory, based on an elaborate examination of statistics in various countries, that the activity of diphtheria is connected with the rainfall, and he lays down the following general induction from the facts: "Diphtheria only becomes epidemic in years in which the rainfall is deficient, and the epidemics are on the largest scale when three or more years of deficient rainfall follow each other." He points out that the comparative rarity of diphtheria in tropical climates, which are characterized by excessive rainfall, and its greater prevalence in continental than in insular countries, confirm his theory. His observations seem quite contrary to the view laid down by various authorities, and hitherto accepted, that wet weather favours diphtheria. The two, however, are not irreconcilable. The key to the problem—and possibly to many other epidemiological problems—may perhaps be found in the movements of the subsoil water. It has been suggested by different observers, and particularly by Mr M. A. Adams, who has for some years made a study of the subsoil water at Maidstone, that there is a definite connexion between it and diphtheria. In England the underground water normally reaches its lowest level at the end of the summer; then it gradually rises, fed by percolation from the winter rains, reaching a maximum level about the end of March, after which it gradually sinks. This maximum level Mr Adams calls the annual spring cleaning of the soil, and his observations go to show that when the normal movement is arrested or disturbed, diphtheria becomes active. Now that is what happens in periods of drought. The underground water does not rise to its usual level, and there is no spring cleaning. The hypothesis, then, is this: The diphtheria bacillus lives in the soil, but is "drowned out" in wet periods by the subsoil water. In droughty ones it lives and flourishes in the warm, dry soil; then when rain comes, it is driven out with the ground air into the houses. This process will continue for some time, so that epidemic outbreaks may well seem to be associated with wet. But they begin in drought, and are stopped by long-continued periods of copious rainfall. This is quite in keeping with the observed fact that diphtheria is a seasonal disease, always most prevalent in the last quarter of the year. The summer develops the poison in the soil, the autumnal rains bring it out. The fact that the same cause does not produce the same effect in tropical countries may perhaps be explained by the extreme violence of the alternations, which are too great to suit this particular micro-organism, or possibly the regularity of the rainfall prevents its development.

The foregoing hypothesis is supported by a good deal of evidence, and notably by the concurrence of the great epidemic or pandemic prevalence in Great Britain, culminating in 1859, with a prolonged period of exceptionally deficient rainfall. Again, the highest death-rate registered since 1865 was in 1893, a year of similarly exceptional drought. But it is no more than an hypothesis, and the fate of former theories is a warning against drawing conclusions from statistics and records extending over too short a period of time. The warning is particularly necessary in connexion with meteorological conditions, which are apt to upset all calculations. As it happens, a period of deficient rainfall even greater than that of 1854-1858 has recently been experienced. It began in 1893 and culminated in the extraordinary season of 1899. The dry years were 1893, 1895, 1896, 1898 and 1899, and the deficiency of rainfall was not made good by any considerable excess in 1894 and 1897. It surpassed all records at Greenwich; streams and wells ran dry all over the country, and the flow of the Thames and Lea was reduced to the lowest point ever recorded. There should be, according to the theory, at least a very large increase in the prevalence of diphtheria. To a certain extent it has held good. There was a marked rise in 1893-1896 over the preceding period, though not so large as might have been expected, but it was followed by a decided fall in 1897-1898. The experience of 1898 contradicts, that of 1899 supports, the theory. Further light is therefore required; but perhaps the failure of the recent drought to produce results at all comparable with the epidemic of the 'fifties may be due to variations in the resistance of the disease, which differs widely in different years. It may also be due in part to improved

sanitation, to the notification of infectious diseases, the use of isolation hospitals, which have greatly developed in quite recent years, and, lastly, to the beneficial effects of antitoxin. If these be the real explanations, then scientific and administrative work has not been thrown away after all in combating this very painful and fatal enemy of the young.

The conditions governing the general prevalence of diphtheria, and its epidemic rise and fall, which have just been discussed, do not touch the question of actual dissemination. The contagion is spread by means which are in constant operation, whether the general amount of disease is great or small. Water, so important in some epidemic diseases, is believed not to be one of them, though a negative proof based on absence of evidence cannot be accepted as conclusive. On the other hand, milk is undoubtedly a means of dissemination. Several outbreaks of an almost explosive character, besides minor extensions of disease from one place to another, have been traced to this cause. Milk may be contaminated in various ways—at the dairy, for instance, or on the way to customers,—but several cases, investigated by the officers of the Local Government Board and others, have been thought to point to infection from cows suffering from a diphtheritic affection of the udder. The part played by aerial convection is undetermined, but there is no reason to suppose that the infecting material is conveyed any distance by wind or air currents. Instances which seem to point to the contrary may be explained in other ways, and particularly by the fact, now fully demonstrated, that persons suffering from minor sore throats, not recognized as diphtheria, may carry the disease about and introduce it into other localities. Human intercourse is the most important means of dissemination, the contagion passing from person to person either by actual contact, as in kissing, or by the use of the same utensils and articles, or by mere proximity. In the last case the germs must be supposed to be air-borne for short distances, and to enter with the breath. Rooms appear liable to become infected by the presence of diphtheritic cases, and so spread the disease among other persons using them. At a small outbreak which occurred at Darenth Asylum in 1898 the infection clung obstinately to a particular ward, in spite of the prompt removal of all cases, and fresh ones continued to occur until it had been thoroughly disinfected, after which there were no more. The part played by human intercourse in fostering the spread of the disease suggests that it would naturally be more prevalent in urban communities, where people congregate together more, than in rural ones. This is at variance with the conclusion laid down by some authorities, that in this country diphtheria used to affect chiefly the sparsely populated districts, and though tending to become more urban, is still rather a rural disease. That view is based upon an analysis of the distribution by counties in England and Wales from 1855 to 1880, and it has been generally accepted and repeated until it has become a sort of axiom. Of course the facts of distribution are facts, but the general inference drawn from them, that diphtheria peculiarly affects the country and is changing its *habitat*, may be erroneous. Dr Newsholme, by taking a wider basis of experience, has arrived at the opposite conclusion, and finds that diphtheria does not, in fact, flourish more in sparsely-peopled districts. "When a sufficiently long series of years is taken," he says, "it appears clear that there is more diphtheria in urban than in rural communities." The rate for London has always been in excess of that for the whole of England and Wales. Its distribution at any given time is determined by a number of circumstances, and by their incidental co-operation, not by any property or predilection for town or country inherent in the disease. There are the epidemic conditions of soil and rainfall, previously discussed, which vary widely in different localities at different times; there is the steady influence of regular intercourse, and the accidental element of special distribution by various means. These things may combine to alter the incidence. In short, accident plays too great a part to permit any general conclusion to be drawn from distribution, except from a very wide basis of experience. The variations are very great and sometimes very sudden. For instance, the county of London for some years headed the list,

having a far higher death-rate than any other. In 1808 it dropped to the 6th place, and was surpassed by Rutland, a purely rural county, which had the lowest mortality of all in the previous year and very nearly the lowest for the previous ten years. Again, South Wales, which had had a low mortality for some years, suddenly came into prominence as a diphtheria district, and in 1808 had the highest death-rate in the country. Staffordshire and Bedfordshire show a similar rise, the one an urban, the other a rural, county. All the northern counties, both rural and urban,—namely, Northumberland, Durham, Cumberland, Westmorland, Lancashire, Yorkshire, Cheshire and Lincolnshire,—had a very high rate in 1861-1870, and a low one in 1896-1898. It is obviously unsafe to draw general conclusions from distribution data on a small scale. Diphtheria appears to creep about very slowly, as a rule, from place to place, and from one part of a large town to another; it forsakes one district and appears in another; occasionally it attacks a fresh locality with great energy, presumably because the local conditions are exceptionally favourable, which may be due to the soil or, possibly, to the susceptibility of the inhabitants, who are, so to speak, virgin ground. But through all personal infection is the chief means of spread.

The acceptance of this doctrine has directed great attention to the practical question of school influence. There is no doubt whatever that it plays a very considerable part in spreading diphtheria. The incidence of the disease is chiefly on children, and nothing so often and regularly brings large numbers together in close contact under the same roof as school attendance. Nothing, in fact, furnishes such constant and extensive opportunities for personal infection. Many outbreaks have definitely been traced to schools. In London the subject has been very fully investigated by Sir Shirley Murphy, the medical officer of health to the London County Council, and by Dr W. R. Smith, formerly medical officer of health to the London School Board. Sir Shirley Murphy has shown that a special incidence on children of school age began to manifest itself after the adoption of compulsory education, and that the summer holidays are marked by a distinct diminution of cases, which is succeeded by an increase on the return to school. Dr W. R. Smith's observations are directed rather to minimizing the effect of school influence, and to showing that it is less important than other factors; which is doubtless true, as has been already remarked. It appears that the heaviest incidence falls upon infants under school age, and that liability diminishes progressively after school age is reached. But this by no means disposes of the importance of school influence, as the younger children at home may be infected by older ones, who have picked up the contagion at school, but, being less susceptible, are less severely affected and exhibit no worse symptoms than a sore throat. From a practical point of view the problem is a difficult one to deal with, as it is virtually impossible to ensure the exclusion of all infection, on account of the deceptively mild forms it may assume; but considering how very often outbreaks of diphtheria necessitate the closing of schools, it would probably be to the advantage of the authorities to discourage, rather than to compel, the attendance of children with sore throats. A fact of some interest revealed by statistics is that in the earliest years of life the incidence of diphtheria is greater upon male than upon female children, but from three years onwards the position is reversed, and with every succeeding year the relative female liability becomes greater. This is probably due to the habit of kissing maintained among females, but more and more abandoned by boys from babyhood onwards.

All these considerations suggest the importance of segregating the sick in isolation hospitals. Of late years this preventive measure has been carried out with increasing efficiency, owing to the better provision of such hospitals and the greater willingness of the public to make use of them; and probably the improvement so effected has had some share in keeping down the prevalence of the disease to comparatively moderate proportions. Unfortunately, the complete segregation of infected persons is hardly possible, because of the mild symptoms, and even absence of symptoms, exhibited by some individuals. A further difficulty arises with reference to the discharge of patients. It has been

proved that the bacillus may persist almost indefinitely in the air-passages in certain cases, and in a considerable proportion it does persist for several weeks after convalescence. On returning home such cases may, and often do, infect others.

Since the antitoxin treatment was introduced in 1894 it has overshadowed all other methods. We owe this drug originally to the Berlin school of bacteriologists, and particularly to Dr Behring. The idea of making use of serum arose about 1890, out of researches made in connexion with Mechnikov's theory of phagocytosis, by which is meant the action of the phagocytes or white corpuscles of the blood in destroying the bacteria of disease. It was shown by the German bacteriologists that the serum or liquid part of the blood plays an equally or more important part in resisting disease, and the idea of combating the toxins produced by pathogenic bacteria with resistant serum injected into the blood presented itself to several workers. The idea was followed up and worked out independently in France and Germany, so successfully that by the year 1894 the serum treatment had been tried on a considerable scale with most encouraging results. Some of these were published in Germany in the earlier part of that year, and at the International Hygienic Congress, held in Budapest a little later, Dr Roux, of the Institut Pasteur, whose experience was somewhat more extensive than that of his German colleagues, read a paper giving the result of several hundred cases treated in Paris. When all allowance for errors had been made, they showed a remarkable and even astonishing reduction of mortality, fully confirming the conclusions drawn from the German experiments. This consensus of independent opinion proved a great stimulus to further trial, and before long one *délinquante* after another told the same tale. The evidence was so favourable that Professor Virchow—the last man to be carried away by a novelty—declared it “the imperative duty of medical men to use the new remedy” (*The Times*, 19th October 1894). Since then an enormous mass of facts has accumulated from all quarters of the globe, all testifying to the value of antitoxin in the treatment of diphtheria. The experience of the hospitals of the London Metropolitan Asylums Board for five years before and after antitoxin may be given as a particularly instructive illustration; but the subsequent reduction in the rate of mortality (12 in 1900, 11.3 in 1901, 10.8 in 1902, 9.3 in 1903, and an average of 9 in 1904-1908) added further confirmation.

Annual Case Mortality in Metropolitan Asylums Board's Hospitals.

Before Antitoxin.		After Antitoxin.	
Year.	Mortality per cent.	Year.	Mortality per cent.
1890 . . .	33.55	1895 . . .	22.85
1891 . . .	30.61	1896 . . .	21.20
1892 . . .	29.51	1897 . . .	17.79
1893 . . .	30.42	1898 . . .	15.37
1894 . . .	29.29	1899 . . .	13.95

The number of cases dealt with in these five antitoxin years was 32,835, or an average of 6567 a year, and the broad result is a reduction of mortality by more than one-half. It is a fair inference that the treatment saves the lives of about 1000 children every year in London alone. This refers to all cases. Those which occur in the hospitals as a sequel to scarlet fever, and consequently come under treatment from the commencement, show very much more striking results. The case mortality, which was 46.8% in 1892 and 58.8% in 1893, has been reduced to 3.6% since the introduction of antitoxin. But the evidence is not from statistics alone. The beneficial effect of the treatment is equally attested by clinical observation. Dr Roux's original account has been confirmed by a cloud of witnesses year after year. “One may say,” he wrote, “that the appearance of most of the patients is totally different from what it used to be. The pale and leaden faces are scarcely seen in the wards; the expression of the children is brighter and more lively.” Adult patients have described the relief afforded by inoculation; it acts like a charm, and lifts the deadly feeling of oppression off like a cloud in the course of a few hours. Finally, the counteracting effect of antitoxin in preventing the disintegrating action of the

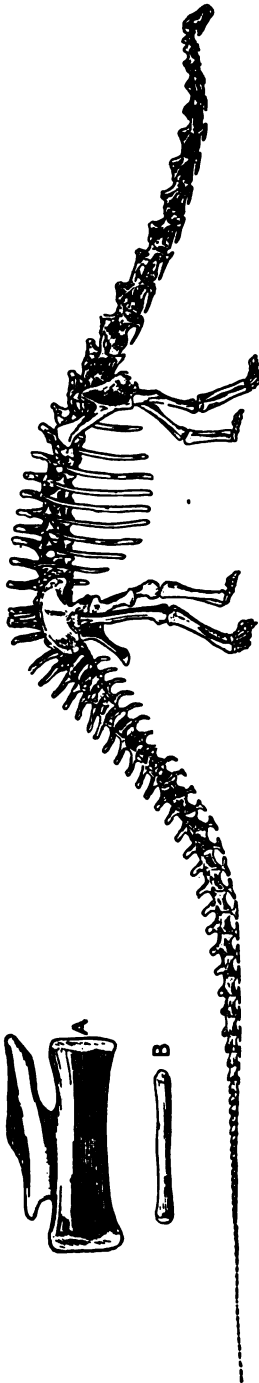

Reconstructed Skeleton of *Diplodocus carnegii*, Hatcher, about one-hundredth natural size. A and B, Caudal Vertebrae Nos. 36 and 70 of the same are about one-quarter natural size.

diphtheritic toxin on the nervous tissues has been demonstrated pathologically. There are some who still affect scepticism as to the value of this drug. They cannot be acquainted with the evidence, for if the efficacy of antitoxin in the treatment of diphtheria has not been proved, then neither can the efficacy of any treatment for anything be said to be proved. Prophylactic properties are also claimed for the serum; but protection is necessarily more difficult to demonstrate than cure, and though there is some evidence to support the claim, it has not been fully made out.

AUTHORITIES.—Adams, *Public Health*, vol. vii.; Thorne Thorne, *Mitroy Lectures* (1891); Newsholme, *Epidemic Diphtheria*; W. R. Smith, *Harben Lectures* (1899); Murphy, *Report to London County Council* (1894); Sims Woodhead, *Report to Metropolitan Asylums Board* (1901).

DIPLODOCUS, a gigantic extinct land reptile discovered in rocks of Upper Jurassic age in western North America, the best-known example of a Sauropodous Dinosaur. The first scattered remains of a skeleton were found in 1877 by Prof. S. W. Williston near Canon City, Colorado; and the tail and hind-limb of this specimen were described in the following year by Prof. O. C. Marsh. He noticed that in the part of the tail which dragged on the ground, each chevron bone below the vertebral column consisted of a pair of bars; and as so peculiar an arrangement for the protection of the artery and vein beneath the tail had not previously been observed in any animal, he proposed the name *Diplodocus* ("double beam" or "double bar") for the new reptile, adding the

specific name *longus* in allusion to the elongated shape of the tail vertebrae. In 1884 Prof. Marsh described the head, vertebrae and pelvis of the same skeleton, which is now in the National Museum, Washington. In 1897 the next important specimen, a tail associated with other fragments, apparently of *Diplodocus longus*, was obtained by the American Museum of Natural History, New York, from Como Bluffs, Wyoming. In 1899–1900 large parts of two skeletons of another species, in a remarkable state of preservation, were disinterred by Messrs J. L. Wortman, O. A. Peterson and J. B. Hatcher in Sheep Creek, Albany county, Wyo., and these are now exhibited with minor discoveries in the Carnegie Museum, Pittsburg. There are also other specimens in New York, Chicago and the University of Wyoming. In 1901 Mr J. B. Hatcher studied the new species at Pittsburg, named it *Diplodocus carnegii*, and published the first restored sketch of a complete skeleton. Shortly afterwards plaster casts of the finest specimens were prepared under the direction of Mr J. B. Hatcher and Dr W. J. Holland, and these were skillfully combined to form the cast of a completely reconstructed skeleton, which was presented to the British Museum by Andrew Carnegie in 1905. This reconstruction is based primarily on a well-preserved chain of vertebrae, extending from the second cervical to the twelfth caudal, associated with the ribs, pelvis and several limb-bones. The tail is completed from two other specimens in the Carnegie Museum, having caudals 13 to 36 and 37 to 73 respectively in apparently unbroken series. Prof. Marsh's specimen in Washington supplied the greater part of the skull; and the fore-foot is copied from a specimen in New York.

The cast of the reconstructed skeleton of *Diplodocus carnegii* measures 84 ft. in length and 12 ft. 9 in. in maximum height at the hind-limbs. It displays the elongated neck and tail and the relatively small head so characteristic of the Sauropodous Dinosaurs. The skull is inclined to the axis of the neck, denoting a browsing animal; while the feeble blunt teeth and flat expanded snout suggest feeding among succulent water-weeds. The large narial opening at the highest point of the head probably indicates an aquatic mode of life, and there seems to have been a soft valve to close the nostrils when under water. The diminutive brain-cavity, scarcely large enough to contain a walnut, is noteworthy. There are 104 vertebrae, namely, 15 in the neck, 11 in the back, 5 in the sacrum and 73 in the tail. The presacral vertebrae are of remarkably light construction, the plates and struts of bone being arranged to give the greatest strength with the least weight. The end of the tail is a flexible lash, which would probably be used as a weapon, like the tail of some existing lizards. The feet, notwithstanding the weight they had to support, are as unsymmetrical as those of a crocodile, with claws only on the three inner toes. There is no external armour. See O. C. Marsh, *Amer. Journ. Sci.* ser. 3, vol. xvi. (1878), p. 414, pl. viii., and *loc. cit.* vol. xxvii. (1884), p. 161, pls. iii., iv.; H. F. Osborn, *Mem. Amer. Mus. Nat. Hist.* vol. i. pt. v. (1899); J. B. Hatcher, *Mem. Carnegie Mus.* vol. i. No. 1 (1901), and vol. ii. No. 1 (1903); W. J. Holland, *Mem. Carnegie Mus.* vol. ii. No. 6 (1906). (A. S. Wo.)

DIPLOMACY (Fr. *diplomatie*), the art of conducting international negotiations. The word, borrowed from the French, has the same derivation as Diplomatic (*q.v.*), and, according to the *New English Dictionary*, was first used in England so late as 1796 by Burke. Yet there is no other word in the English language that could supply its exact sense. The need for such a term was indeed not felt; for what we know as diplomacy was long regarded, partly as falling under the *Jus gentium* or international law, partly as a kind of activity morally somewhat suspect and incapable of being brought under any system. Moreover, though in a certain sense it is as old as history, diplomacy as a uniform system, based upon generally recognized rules and directed by a diplomatic hierarchy having a fixed international status, is of quite modern growth even in Europe. It was finally established only at the congresses of Vienna (1815) and Aix-la-Chapelle (1818), while its effective extension to the great monarchies of the East, beyond the bounds of European civilization, was comparatively an affair of yesterday. So late as 1876 it was possible for the

writer on this subject in the 9th edition of the *Encyclopædia Britannica* to say that "it would be an historical absurdity to suppose diplomatic relations connecting together China, Burma and Japan, as they connect the great European powers."

Principles.—Though diplomacy has been usually treated under the head of international law, it would perhaps be more consonant with the facts to place international law under diplomacy. The principles and rules governing the intercourse of states, defined by a long succession of international lawyers, have no sanction save the consensus of the powers, established and maintained by diplomacy (see BALANCE OF POWER); in so far as they have become, by international agreement, more than mere pious opinions of theorists, they are working rules established for mutual convenience, which it is the function of diplomacy to safeguard or to use for its own ends. In any case they by no means cover the whole field of diplomatic activity; and, were they swept away, the art of diplomacy, developed through long ages of experience, would survive.

This experience may perhaps be called the science, as distinct from the art, of diplomacy. It covers not only the province of international law, but the vast field of recorded experience which we know as history, of which indeed international law is but a part; for, as Biefeld in his *Institutions politiques* (La Haye, 1760, t. I. ch. ii. § 13) points out, "public law is founded on facts. To know it we must know history, which is the soul of this science as of politics in general." The broad outlook on human affairs implied in "historical sense" is more necessary to the diplomatist under modern conditions than in the 18th century, when international policy was still wholly under the control of princes and their immediate advisers. Diplomacy was then a game of wits played in a narrow circle. Its objects too were narrower; for states were practically regarded as the property of their sovereigns, which it was the main function of their "agents" to enlarge or to protect, while scarcely less important than the preservation or rearrangement of territorial boundaries was that of precedence and etiquette generally, over which an incredible amount of time was wasted. The *haute diplomatie* thus resolved itself into a process of exalted haggling, conducted with an utter disregard of the ordinary standards of morality, but with the most exquisite politeness and in accordance with ever more and more elaborate rules. Much of the outcome of these dead debates has become stereotyped in the conventions of the diplomatic service; but the character of diplomacy itself has undergone a great change. This change is threefold: firstly, as the result of the greater sense of the community of interests among nations, which was one of the outcomes of the French Revolution; secondly, owing to the rise of democracy, with its expression in parliamentary assemblies and in the press; thirdly, through the alteration in the position of the diplomatic agent, due to modern means of communication.

The first of these changes may be dated to the circular of Count Kaunitz of the 17th of July 1791, in which, in face of the Revolution, he impressed upon the powers the duty of making common cause for the purpose of preserving "public peace, the tranquillity of states, the inviolability of possessions, and the faith of treaties." The duty of watching over the common interests of Europe, or of the world, was thus for the first time officially recognized as a function of diplomacy, since common action could only be taken as the result of diplomatic negotiations. It would be easy to exaggerate the effective results of this idea, even when it had crystallized in the Grand Alliance of 1814 and been proclaimed to the world in the Holy Alliance of the 26th of September 1815 and the declaration of Aix-la-Chapelle. The cynical picture given by La Bruyère of the diplomatist of the 18th century still remained largely true: "His talk is only of peace, of alliances, of the public tranquillity, and of the public interests; in reality he is thinking only of his own, that is to say, of those of his master or of his republic."¹ The proceedings of the congress of Vienna proved how little the common good weighed unless reinforced by particular interests; but the conception of "Europe" as a political entity none the less survived. The congresses, notably

¹ La Bruyère, *Caractères*, ii. 77 (ed. P. Jouast, Paris, 1881).

the congress of Aix-la-Chapelle (q.v.) in 1818, were in a certain sense European parliaments, and their ostensible object was the furtherance of common interests. Had the imperial dreamer Alexander I. of Russia had his way, they would have been permanently established on the broad basis of the Holy Alliance, and would have included, not the great powers only, but representatives of every state (see ALEXANDER I. and EUROPE: *History*). Whatever the effective value of that "Concert of Europe" which was the outcome of the period of the congresses, it certainly produced a great effect on the spirit and the practice of diplomacy. In the congresses and conferences diplomacy assumes international functions both legislative and administrative. The diplomat is responsible, not only to his own government, but to "Europe." Thus Castlereagh was accused of subordinating the interests of Great Britain to those of Europe; and the same charge was brought, perhaps with greater justice, against Metternich in respect of Austria. Canning's principle of "Every nation for itself and God for us all!" prevailed, it is true, over that of Alexander's "Confederation of Europe"; yet, as one outcome of the congresses, every diplomatic agent, though he represents the interests of his own state, has behind him the whole body of the treaties which constitute the public law of the world, of which he is in some sort the interpreter and the guardian.

Parallel with this development runs the second process making for change: the increasing responsibility of diplomacy to public opinion. To discuss all the momentous issues involved in this is impossible; but the subject is too important to be altogether passed over, since it is one of the main problems of modern international intercourse, and concerns every one who by his vote may influence the policy of the state to which he belongs. The question, broadly speaking, is: how far has the public discussion of international affairs affected the legitimate functions of diplomacy for better or for worse? To the diplomatist of the old school the answer seems clear. For him diplomacy was too delicate and too personal an art to survive the glare and confusion of publicity. Metternich, the last representative of the old *haute diplomatie*, lived to moralize over the ruin caused by the first manifestations of the "new diplomacy," the outcome of the rise of the power of public opinion. He had early, from his own point of view, unfavourably contrasted the "limited" constitutional monarchies of the west with the "free" autocracies of the east of Europe, free because they were under no obligation to give a public account of their actions. He himself was a master of the old diplomatic art, of intrigue, of veiling his purpose under a cloud of magniloquence, above all, of the art of personal fascination. But public opinion was for him only a dangerous force to be kept under control; and, even had he realized the necessity for appealing to it, he had none of the qualities that would have made the appeal successful. In direct antagonism to him was George Canning, who may be called the great prototype of the "new diplomacy," and to Metternich was a "malevolent meteor hurled by divine providence upon Europe." Canning saw clearly the immense force that would be added to his diplomatic action if he had behind him the force of public opinion. In answer to Metternich's complaint of the tone of speeches in parliament and of the popular support given in England to revolutionary movements, he wrote, "Our influence, if it is to be maintained abroad, must be secure in its sources of strength at home: and the sources of that strength are in the sympathy between the people and the government; in the union of the public sentiment with the public counsels; in the reciprocal confidence of the House of Commons and the crown."²

It would be a mistake to jump to the conclusion that Canning was wholly right and Metternich wholly wrong. The conditions of the Habsburg monarchy were not those of Great Britain,³ and even if it had been possible to speak of a public opinion in the Austrian empire at all, it certainly possessed no such organ as the British parliament. But the argument may be carried yet

² To Wellealey, in Stapleton's *Canning*, i. 374.

³ For the motives of Metternich's foreign policy see AUSTRIA-HUNGARY: *History* (iii. 332-333).

further. In the abstract the success of the policy of a minister in a democratic state must ultimately rest upon the support of public opinion; yet the necessity for this support has in the conduct of foreign affairs its peculiar dangers. In the difficult game of diplomacy a certain reticence is always necessary. Secret sources of information would be dried up were they to be lightly revealed; a plain exposition of policy would often give an undue advantage to the other party to a negotiation. Thus, even in Great Britain, the diplomatic correspondence laid before parliament is carefully edited, and all governments are jealous of granting access to their modern archives. Yet a representative assembly is apt to be resentful of such reservations. Its members know little or nothing of the conditions under which foreign affairs are conducted, and they are not unnaturally irritated by explanations which seem to lack candour or completeness. Canning himself had experience of this in the affair of the capture of the Danish fleet at Copenhagen; and Castlereagh's diplomacy was hampered by the bitter attacks of an opposition which accused him, with little justice, of pursuing a policy which he dared not reveal in its full scope to parliament. Moreover, the appeal to public opinion may be used as a diplomatic weapon for ends no less "selfish" than any aimed at by the old diplomacy. Bismarck, whose statesmanship was at least as cynical as that of Metternich, was a master of the art of taking the world into his confidence—when it suited him to do so; and the "reptile press," hired to give a seemingly independent support to his policy, was one of his most potent weapons. So far the only necessary consequence of the growth of the power of public opinion on the art of diplomacy has been to extend the sphere of its application; it is but one more factor to be dealt with; and experience has proved that it is subject to the wiles of a skillful diplomatist no less than were the princes and statesmen with whom the old diplomacy was solely concerned.

The third factor making for change—the revolution in the means of communication which has brought all the world into closer touch—remains to be discussed. It is obvious that before the invention of the telegraph, the diplomatic agent was in a far more responsible position than he is now, when he can, in most cases, receive immediate instructions from his government on difficult questions as they arise. When communication was still slow there was often no time to await instructions, or the instructions when they arrived were not seldom already out of date and had to be set aside on the minister's own responsibility. It would, however, be easy to exaggerate the importance of this change as affecting the character and status of diplomatic agents. It is true that the tendency has been for ministers of foreign affairs to hold the threads of diplomacy in their own hands to a far greater extent than was formerly the case; but they must still depend for information and advice on the "man on the spot," and the success of their policy largely depends upon his qualities of discretion and judgment. The growth of democracy, moreover, has given to the ambassador a new and peculiar importance; for he represents not only the sovereign to the sovereign, but the nation to the nation; and, as a succession of notable American ambassadors to Great Britain has proved, he may by his personal qualities do a large amount to remove the prejudices and ignorances which stand as a barrier between the nations. It marks an immense advance in the comity of international intercourse when the representatives of friendly powers are no longer regarded as "spies rather than ambassadors," to be "quickly heard and dismissed," as Philippe de Commines would have them, but as agreeable guests to be parted from with regret.

As to the qualifications for an ambassador, it is clearly impossible to lay down a general rule, for the same qualities are obviously not required in Washington as in Vienna, nor in Paris as in Pekin. Yet the effort to depict the ideal ambassador bulks large in the works of the earlier theorists, and the demands they make are sufficiently alarming. Ottaviano Maggi, himself a diplomatist of the brilliant age of the Renaissance, has left us in his *De Legato* (Hanoviae, 1596) his idea of what an ambassador should be. He must not only be a good Christian but a learned theologian; he must be a philosopher, well versed in Aristotle

and Plato, and able at a moment's notice to solve in correct dialectical form the most abstruse problems; he must be well read in the classics, and an expert in mathematics, architecture, music, physics and civil and canon law. He must not only know how to write and speak Latin with classical refinement, but he must be a master of Greek, Spanish, French, German and Turkish. He must have a sound knowledge of history, geography and the science of war; but at the same time is not to neglect the poets, and never to be without his Homer. Add to this that he must be well born, rich and of a handsome presence, and we have a portrait of a diplomatist whose original can hardly have existed even in that age of brilliant versatility. The Dutchman Frederikus de Marselaer, in his *rapport sive legationum insigne* (Antwerp, 1618), is scarcely less exacting than the Venetian. His ideal ambassador is a nobleman of fine presence and in the prime of life, famous, rich, munificent, abstemious, not violent, nor quarrelsome, nor morose, no flatterer, learned, eloquent, witty without being talkative, a good linguist, widely read, prudent and cautious, but brave and—as he adds somewhat superfluously—many-sided.

With these theoretical perfections one or two instances of the qualifications demanded by the exigencies of practical politics may be cited by way of illuminating contrast. At the court of the empress Elizabeth of Russia good looks were a surer means of diplomatic success than all the talents and virtues, and the princess of Zerbst (mother of the empress Catherine II.) wrote to Frederick of Prussia advising him to replace his elderly ambassador by a handsome young man with a good complexion; and the essential qualification for an ambassador to Switzerland, Germany, Poland, Denmark and Russia used to be that he should be able to drink the native diplomatists, seasoned from babyhood to strong liquors, under the table.

History.—In its widest sense the history of diplomacy is that of the intercourse between nations, in so far as this has not been a mere brute struggle for the mastery;¹ in a narrower sense, with which the present article is alone concerned, it is that of the methods and spirit of diplomatic intercourse and of the character and status of diplomatic agents. Earlier writers on the office and functions of ambassadors, such as Gentili or Archbishop Germonius, conscientiously trace their origin to God himself, who created the angels to be his legats; and they fortify their arguments by copious examples drawn from ancient history, sacred and profane. But, whatever the influence upon it of earlier practice, modern diplomacy really dates from the rise of permanent missions, and the consequent development of the diplomatic hierarchy as an international institution. Of this the first beginnings are traceable to the 15th century and to Italy. There had, of course, during the middle ages been embassies and negotiations; but the embassies had been no more than temporary missions directed to a particular end and conducted by ecclesiastics or nobles of a dignity appropriate to each occasion; there were neither permanent diplomatic agents nor a professional diplomatic class. To the evolution of such a class the Italy of the Renaissance, the nursing-ground of modern statecraft, gave the first impetus. This was but natural; for Italy, with its numerous independent states, between which there existed a lively intercourse and a yet livelier rivalry, anticipated in miniature the modern states' system of Europe. In feudal Europe there had been little room for diplomacy; but in northern and central Italy feudalism had never taken root, and in the struggles of the peninsula diplomacy had early played a part as great as, or greater than, war. Where all were struggling for the mastery, the existence of each depended upon alliances and counter-alliances, of which the object was the maintenance of the balance of power. In this school there was trained a notable succession of men of affairs. Thus, in the 13th and 14th centuries Florence counted among her envoys Dante, Petrarch and Boccaccio, and later on could boast of agents such as Capponi, Vettori, Guicciardini and Machiavelli. Papal Rome, too, as was to be expected, had always been a fruitful nursing-mother of diplomatists; and some

¹ e.g. *A History of Diplomacy in the International Development of Europe*, by D. J. Hill (London and New York, 1905).

authorities have traced the beginnings of modern diplomacy to a conscious imitation of her legatine system.¹

It is, however, in Venice, that the origins of modern diplomacy are to be sought.² So early as the 13th century the republic, with a view to safeguarding the public interests, began to lay down a series of rules for the conduct of its ambassadors. Thus, in 1236, envoys to the court of Rome are forbidden to procure a benefice for anyone without leave of the doge and little council; in 1268 ambassadors are commanded to surrender on their return any gifts they may have received, and by another decree they are compelled to take an oath to conduct affairs to the honour and advantage of the republic. About the same time it was decided that diplomatic agents were to hand in, on their return, a written account of their mission; in 1288 this was somewhat expanded by a law decreeing that ambassadors were to deposit, within fifteen days of their return, a written account of the replies made to them during their mission, together with anything they might have seen or heard to the honour or in the interests of the republic. These provisions, which were several times renewed, notably in 1296, 1295 and 1533, are the origin of the famous reports of the Venetian ambassadors to the senate, which are at once a monument to the political genius of Venetian statesmen and a mine of invaluable historical material.³

These are but a few examples of a long series of regulations, many others also dating to the 13th century, by which the Venetian government sought to systematize its diplomatic service. That permanent diplomatic agencies were not established by it earlier than was the case is probably due to the distrust of its agents by which most of this legislation of the republic is inspired. In the 13th century two or three months was considered over-long a period for an ambassador to reside at a foreign court; in the 15th century the period of residence was extended to two years, and in the 16th century to three. This latter rule continued till the end of the republic; the embassy had become permanent, but the ambassador was changed every three years.

The origin of the change from temporary to permanent missions has been the subject of much debate and controversy. The theory that it was due, in the first instance, to the evolution of the Venetian consulates (*bajulati*) in the Levant into permanent diplomatic posts, and that the idea was thence transferred to the West, is disproved by the fact that Venice had established other permanent embassies before the *bajlo* (*q.v.*) at Constantinople was transformed into a diplomatic agent of the first rank. Nor is the first known instance of the appointment of a permanent ambassador Venetian. The earliest record⁴ is contained in the announcement by Francesco Sforza, duke of Milan, in 1455, of his intention to maintain a permanent embassy at Genoa⁵; and in 1460 the duke of Savoy sent Eusebio Margaria, archdeacon of Vercelli, as his permanent representative to the Curia.⁶ Though, however, the early records of such appointments are rare, the practice was probably common among the Italian states. Its extension to countries outside Italy was a somewhat later development. In 1494 Milan is already represented in France by a permanent ambassador. In 1495 Zacharia Contarini, Venetian ambassador to the emperor Maximilian, is described by Sanuto (*Diarii*, i. 294) as *stato ambasciatore*, and from the time of

¹ For this see Hinschius, *Kirchenrecht*, i. p. 498.

² The Venetians, however, in their turn, doubtless learned their diplomacy originally from the Byzantines, with whom their trade expansion in the Levant early brought them into close contact. For Byzantine diplomacy see ROMAN EMPIRE, LATER: *Diplomacy*.

³ See Eugenio Alberi, *Le Relazioni degli ambasciatori Veneti al senato*, 15 vols. (Florence, 1839-1863).

⁴ The *apocrisarii* (*ἀποκριταί*) or *respondes* should perhaps be mentioned, though they certainly did not set the precedent for the modern permanent missions. They were resident agents, practically legates, of the popes at the court of Constantinople. They were established by Pope Leo I., and continued until the Iconoclastic controversy broke the intimate ties between East and West. See Luxardo, *Das vordeutsche Gesandtschaftsrecht der Päpste* (Innsbruck, 1878); also Hinschius, *Kirchenrecht*, i. 501.

⁵ N. Bianchi, *Le Materie politiche relative all' estero degli archivi di stato piemontesi* (Bologna, Modena, 1875), p. 29.

⁶ *Ib.* Note 2, *teneamus et deputemus ibidem continue mansurum*.

Charles V. onwards the succession of ambassadors of the republic at the imperial court is fairly traceable. In 1496 "as the way to the British Isles is very long and very dangerous," two merchants resident in London, Pietro Contarini and Luca Valaressa, were appointed by the republic *subambasciatori*, and in June of the same year Andrea Trevisano arrived in London as permanent ambassador at the court of Henry VII.⁷ Florence, too, from 1498 onwards, was represented at the courts of Charles V. and of France by permanent ambassadors.

During the same period the practice had been growing up among the other European powers. Spain led the way in 1487 by the appointment of Dr Roderigo Gondesalvi de Puebla as ambassador in England. As he was still there in 1500, the Spanish embassy in London may be regarded as the oldest still surviving post of the new permanent diplomacy. Other states followed suit, but only fitfully; it was not till late in the 16th century that permanent embassies were regarded as the norm. The precarious relations between the European powers during the 16th century, indeed, naturally retarded the development of the system. Thus it was not till after good relations had been established with France by the treaty of London that, in 1519, Sir Thomas Boleyn and Dr West were sent to Paris as resident English ambassadors, and, after the renewed breach between the two countries, no others were appointed till the reign of Elizabeth. Nine years before, Sir Robert Wingfield, whose simplicity earned him the nickname of "Summer-shall-be-green," had been sent as ambassador to the court of Charles V., where he remained from 1510 to 1517; and in 1520 the mutual appointment of resident ambassadors was made a condition of the treaty between Henry VIII. and Charles V. In 1517 Thomas Spinely, who had for some years represented England at the court of the Netherlands, was appointed "resident ambassador to the court of Spain," where he remained till his death on the 22nd of August 1522. These are the most important early instances of the new system. Alone of the great powers, the emperor remained permanently unrepresented at foreign courts. In theory this was the result of his unique dignity, which made him superior to all other potentates; actually it was because, as emperor, he could not speak for the practically independent princes nominally his vassals. It served all practical purposes if he were represented abroad by his agents as king of Spain or archduke of Austria.

All the evidence now available goes to prove that the establishment of permanent diplomatic agencies was not an unconscious and accidental development of previous conditions, but deliberately adopted as an obvious convenience. But, while all the powers were agreed as to the convenience of maintaining such agencies abroad, all were equally agreed in viewing the representatives accredited to them by foreign states with extreme suspicion. This attitude was abundantly justified by the peculiar ethics of the new diplomacy. The old "orators" of the Summer-shall-be-green type could not long hold their own against the new men who had studied in the school of Italian statecraft, for whom the end justified the means. Machiavelli had gathered in *The Prince* and *The Discourses on Livy* the principles which underlay the practice of his day in Italy; Francis I., the first monarch to establish a completely organized diplomatic machinery, did most to give these principles a European extension. By the close of the 16th century diplomacy had become frankly "Machiavellian," and the ordinary rules of morality were held not to apply to the intercourse between nations. This was admitted in theory as well as in practice. Germonius, after a vigorous denunciation of lying in general, argues that it is permissible for the safety or convenience (*commodo*) of princes, since *salus populi suprema lex*, and *quod non permittit naturalis ratio, admittit civilis*; and he adduces in support of this principle the answer given by Ulysses to Neoptolemus, in the *Ajax* of Sophocles, and the examples of Abraham, Jacob and David. Paschalius, while affirming that an ambassador must study to speak the truth, adds that he is not

⁷ The first ambassador of Venice to visit England was Zuanne da Lezze, who came in 1319 to demand compensation for the plundering of Venetian ships by English pirates.

such a "rustic boor" as to say that an "official lie" (*officiosum mendacium*) is never to be employed, or to deny that an ambassador should be, on occasion, *splendide mendax*.¹ The situation is summed up in the famous definition of Sir Henry Wotton, which, though excused by himself as a jest, was held to be an indiscreet revelation of the truth: "An ambassador is an honest man sent to lie abroad for the good of his country."² The most successful liar, in fact, was esteemed the most successful diplomatist. "A prime article of the catechism of ambassadors," says Bayle in his *Dictionnaire critique* (1699), "whatever their religion, is to invent falsehoods and to go about making society believe them." So universally was this principle adopted that, in the end, no diplomatist even expected to be believed; and the best way to deceive was—as Bismarck cynically avowed—to tell the truth.

But, in addition to being a liar *ex officio*, the ambassador was also "an honourable spy." "The principal functions of an envoy," says François de Callières, himself an ex-ambassador of Louis XIV., "are two; the first is to look after the affairs of his own prince; the second is to discover the affairs of the other." A clever minister, he maintains, will know how to keep himself informed of all that goes on in the mind of the sovereign, in the councils of ministers or in the country, and for this end "good cheer and the warming effect of wine" are excellent allies.³ This being so, it is hardly to be wondered at that foreign ambassadors were commonly regarded as perhaps necessary, but certainly very unwelcome, guests. The views of Philippe de Commines have already been quoted above, and they were shared by a long series of theoretical writers as well as by men of affairs. Gentilis is all but alone in his protest against the view that all ambassadors were *exploratores magis quam oratores*, and to be treated as such. So early as 1481 the government of Venice had decreed the penalty of banishment and a heavy fine for any one who should talk of affairs of state with a foreign envoy, and though the more civilized princes did not follow the example of the sultan, who by way of precaution locked the ambassador of Ferdinand II., Jerome Lascki, into "a dark and stinking place without windows," they took the most minute precautions to prevent the ambassadors of friendly powers from penetrating into their secrets. Charles V. thought it safest to keep them as far away as possible from his court. So did Francis I.; and, when affairs were critical, he made his frequent changes of residence and his hunting expeditions the excuse for escaping from their presence. Henry VII. forbade his subjects to hold any intercourse with them, and, later on, set spies upon them and examined their correspondence—a practice by no means confined to England. If the system of permanent embassies survived, it is clear that this was mainly due to the belief of the sovereigns that they gained more by maintaining "honourable spies" at foreign courts than they lost by the presence of those of foreign courts at their own. It was purely a question of the balance of advantage. Neither among statesmen nor among theorists was there any premonition of the great part to be played by the permanent diplomatic body in the development and maintenance of the concert of Europe. To Paschalius the permanent embassies were "a miserable outgrowth of a miserable age."⁴ Grotius himself condemned them as not only harmful,

¹ Germonius, *De legatis principum et populorum libri tres* (Rome, 1627), chap. vi. p. 164; Paschalius, *Legatus* (Rouen, 1598), p. 302. Etienne Dolet, who had been secretary to Cardinal Jean du Bellay, and was burned for atheism in 1546, in his *De officio legati* (1541) advises ambassadors to surround themselves with taciturn servants, to employ vigilant spies, and to set afoot all manner of sections, especially when negotiating with the court of Rome or with the Italian princes.

² See Pearnall Smith, *Sir Henry Wotton*, pp. 49, 126 et seq.

³ François de Callières, *De la manière de négocier avec les souverains* (Brussels, 1716). See also A. Sorel, *Recueil des instructions données aux ambassadeurs et ministres de France* (Paris, 1884), e.g. vol. *Austrie*, pp. 77, 88, 102, 112.

⁴ *Nova res est, quod sciam, et infelicitis hujus ætatis infelix partus. . . . Hinc orti securitatem universorum, hinc stabiliri pacem gentium. Quæ utinam tam vere diceretur, quam speciose. Ego quidem, ne quid dissimulem, ab lætis seorsum sentio. Nimirum, effocta virtutis, foecunda fraudis hæc sæcula video peperisse*

but useless, the proof of the latter being that they were unknown to antiquity.⁵

Development of the Diplomatic Hierarchy.—The history of the diplomatic body⁶ is, like that of other bodies, that of the progressive differentiation of functions. The middle ages knew no classification of diplomatic agents; the person sent on mission is described indifferently as *legatus, orator, nuntius, ablegatus, commissarius, procurator, mandataris, agens* or *ambaxator* (*ambassador, &c.*). In Gundissalvus, *De legato* (1485), the oldest printed work on the subject, the word *ambaxiator*, first found in a Venetian decree of 1268, is applied to any diplomat. Florence was the first to make distinction; the *orator* was appointed by the council of the republic; the *mandataris*, with inferior powers, by the Council of Ten. In 1500 Machiavelli, who held only the latter rank, wrote from France urging the Signoria to send *ambaxiadori*. This was, however, rather a question of powers than of dignity. But the causes which ultimately led to the elaborate differentiation of diplomatic ranks were rather questions of dignity than of functions.⁷ The breakdown of feudalism, with the consequent rise of a series of sovereign states or of states claiming to be sovereign, of very various size and importance, led to a certain confusion in the ceremonial relation between them, which had been unknown to the comparatively clearly defined system of the middle ages. The smaller states were eager to assert the dignity of their actual or practical independence; the greater powers were equally bent on "keeping them in their place." If the emperor, as has been stated above, was too exalted to send ambassadors, certain of the lesser states were soon esteemed too humble to be represented at the courts of the great powers save by agents of an inferior rank. By the second half of the 16th century, then, there are two classes of diplomatists, ambassadors and residents or agents, the latter being accounted ambassadors of the second class.⁸ At first the difference of rank was determined by the status of the sovereign by whom or to whom the diplomatic agent was accredited; but early in the 16th century it became fairly common for powers of the first rank to send agents of the second class to represent them at courts of an equal status. The reasons were various, and not unamusing. First and foremost came the question of expense. The ambassador, as representing the person of his sovereign, was bound by the sentiment of the age to display an exaggerated magnificence. His journeys were like royal progresses, his state entries surrounded with every circumstance of pomp, and it was held to be his duty to advertise the munificence of his prince by boundless largesses. Had this munificence been as unlimited in fact as in theory, all might have been well, but, in that age of vaulting ambitions, depleted exchequers were the rule rather than the exception in Europe; the records are full of pitiful appeals from ambassadors for arrears of pay, and appointment to an embassy often meant ruin, even to a man of substance. To give but one example, Sir Richard Morison, Edward VI.'s ambassador in Germany, had to borrow money to pay his debts before he could leave Augsburg (*Cal. State Pap. Edw. VI., No. 467*), and later on he writes from Hamburg (April 9, 1552) that he could buy nothing, because everyone believed that he had packed up in

spissata hæc imperia, sive summas potestates, unde, ut e vomitaris, hæc legationes undatim se fundunt." Paschalius, *Legatus* (1598), p. 447. So too Félix de la Mothe Le Vayer (1547-1625), in his *Legatus* (Paris, 1579), says "Legatos tunc primum aut nos multum post institutos fuisse cum Pandora malorum omnium semina in hunc mundum . . . demisit."

⁵ *De jure belli et pacis* (Amsterdam, 1621), li. c. 18, § 3, n. 2.

⁶ The term *corps diplomatique* originated about the middle of the 18th century. "The Chancellor Fürst," says Ranke (xxx. 47, note), "does not use it as yet in his report (1754) but he knows it, and it would appear that it had just been invented at Vienna." *Corps diplomatique, nom qu'une dame donna un jour à ce corps nombreux de ministres étrangers à Vienne.*

⁷ So too Pradier-Fodéré, vol. i. p. 262.

⁸ Thus Charles V. would not allow the representatives of the duke of Mantua, Ferrara, &c., to style themselves "ambassadors," on the ground that this title could be borne only by the agents of kings and of the republic of Venice, and not by those of states whose sovereignty was impaired by any feudal relation to a superior power. (See Krauske, p. 155.)

readiness to flit secretly, for "How must they buy things, where men know their stuff is ready trussed up, and they fleeing every day?" (*ib.* No. 544). But the dignity of ambassador carried another drawback besides expense; his function of "honourable spy" was seriously hampered by the trammels of his position. He was unable to move freely in society, but lived a ceremonial existence in the midst of a crowd of retainers, through whom alone it was proper for him to communicate with the world outside. It followed that, though the office of ambassador was more dignified, that of agent was more generally useful.

Yet a third cause, possibly the most immediately potent, encouraged the growth of the lesser diplomatic ranks: the question of precedence among powers theoretically equal. Modern diplomacy has settled a difficulty which caused at one time much heart-burning and even bloodshed by a simple appeal to the alphabet. Great Britain feels no humiliation in signing after France, if the reason be that her name begins with G; had she not been Great, she would sign before. The vexed question of the precedence of ambassadors, too, has been settled by the rule, already referred to above, as to seniority of appointment. But while the question remained unsettled it was obviously best to evade it; and this was most easily done by sending an agent of inferior rank to a court where the precedence claimed for an ambassador would have been refused.

Thus set in motion, the process of differentiation continues until the system is stereotyped in the 19th century. It is unnecessary to trace this evolution here in any detail. It is mainly a question of names, and diplomatic titles are no exception to the general rule by which all titles tend to become cheapened and therefore, from time to time, need to be reinforced by fresh verbal devices. The method was the familiar one of applying terms that had once implied a particular quality in a fashion that implied actually nothing. The ambassador extraordinary had originally been one sent on an extraordinary mission; for the time and purpose of this mission his authority superseded that of the resident ambassador. But by the middle of the 17th century the custom had grown up of calling all ambassadors "extraordinary," in order to place them on an equality with the others. The same process was extended to diplomatists of the second rank; and envoys (*envoyé* for *abegatus*) were always "extraordinary," and as such claimed and received precedence over mere "residents," who in their day had asserted the same claim against the agents—all three terms having at one time been synonymous. Similarly a "minister plenipotentiary" had originally meant an agent armed with full powers (*plein-pouvoir*); but, by a like process, the combination came to mean as little as "envoy extraordinary"—though a plenipotentiary *tout simple* is still an agent, of no ceremonially defined dignity, despatched with full powers to treat and conclude. Finally, the evolution of the title of a diplomatist of the second rank is crowned by the high-sounding combination, now almost exclusively used, of "envoy extraordinary and minister plenipotentiary." The ultimate fate of the simple title "resident" was the same as that of "agent." Both had been freely sold by needy sovereigns to all and sundry who were prepared to pay for what gave them a certain social status. The "agent" fell thus into utter discredit, and those "residents" who were still actual diplomatic agents became "ministers resident" to distinguish them from the common herd.

The classification of diplomatic agents was for the first time definitely included in the general body of international law by the *Règlement* of the 19th of March 1815 at Vienna¹; and the whole question was finally settled at the congress of Aix-la-Chapelle (November 21, 1818) when, the proposal to establish precedence by the status of the accrediting powers having wisely been rejected, diplomatic agents were divided into four classes: (1) Ambassadors, legates, nuncios; (2) Envoys extraordinary and ministers plenipotentiary, and other ministers accredited direct to the sovereign; (3) Ministers resident; (4) *Chargés d'affaires*. With a few exceptions (*e.g.* Turkey), this settlement was accepted by all states, including the United States of America.

¹ See Pradier-Fodéré, i. 265.

Rights and Privileges of Diplomatic Agents.—These are partly founded upon immemorial custom, partly the result of negotiations embodied in international law. The most important, as it is the most ancient, is the right of personal *inviolability* extended to the diplomatic agent and the members of his suite. This inviolability is maintained after a rupture between the two governments concerned, and even after the outbreak of war. The habit of the Ottoman government of imprisoning in the Seven Towers the ambassador of a power with which it quarrelled was but an exception which proved the rule. The second important right is that of *exterritoriality* (*q.v.*), a convenient fiction by which the house and equipages of the diplomatic agent are regarded as the territory of the power by whom he is accredited. This involves the further principle that the agent is in no way subject to the receiving government. He is exempt from taxation and from the payment at least of certain local rates. He also enjoys immunity (1) from civil jurisdiction, *e.g.* he cannot be sued, nor can his goods be seized, for debt; (2) from criminal jurisdiction, *e.g.* he cannot be arrested and tried for a criminal offence. For a crime of violence, however, or for plotting against the state, he can be placed under the necessary restraint and expelled the country.² These immunities extend to all the members of an envoy's suite. The difficulties that might be supposed to arise from such exemptions have not in practice been found very serious; for though, in the case of crimes committed by servants of agents of the first or second class the procedure is not clearly defined, each case would easily be made the subject of arrangement. In certain cases, *e.g.* embassies in Turkey, the exterritoriality of ambassadors implies a fairly extensive criminal jurisdiction; in other cases the dismissal of the servant would deprive him of his diplomatic immunity and bring him under the law of the land. The right of granting asylum claimed by diplomatic agents in virtue of that of exterritoriality, at one time much abused, is now strictly limited. A political or criminal offender may seek asylum in a foreign embassy; but if, after a request has been formally made for his surrender, the ambassador refuses to deliver him up, the authorities may take the measures necessary to effect his arrest, and even force an entrance into the embassy for the purpose. The "right of chapel" (*droit de chapelle*, or *droit de culte*), enjoyed by envoys in reference to their exterritoriality, *i.e.* the right of free exercise of religious worship within their house, formerly of great importance, has been rendered superfluous by the spread of religious toleration. (See L. Oppenheim, *Internat. Law* (London, 1905), i. p. 441, &c.; A. W. Haflter, *Das europäische Völkerrecht* (Berlin, 1888), p. 435, &c.)

The Personnel of the "Corps diplomatique."—The establishment of diplomacy as a regular branch of the civil service is of modern growth, and even now by no means universal. From old time states naturally chose as their agents those who would best serve their interests in the matter in hand. In the middle ages diplomacy was practically a monopoly of the clergy, who as a class alone possessed the necessary qualifications; and in later times, when learning had spread to the laity as well, there were still potent reasons why the clergy should continue to be employed as diplomatic agents. Of these reasons the most practical was that of expense; for the wealth of the church formed an inexhaustible reserve which was used without scruple for secular purposes. Francis I. of France, who by the Concordat with Rome had in his hands the patronage of all the sees and abbeys in France, used this partly to reward his clerical ministers, partly as a great secret service fund for bribing the ambassadors of other powers, partly for the payment of those high-placed spies at foreign courts maintained by the elaborately organized system

² Gentilis, who had been consulted by the government in the case of the Spanish ambassador, Don Bernardino de Mendoza, expelled for intriguing against Queen Elizabeth, lays this down definitely. An ambassador, he says, need not be received, and he may be expelled. In actual practice a diplomatic agent who has made himself objectionable is withdrawn by his government on the representations of that to which he is accredited, and it is customary, before an ambassador is despatched, to find out whether he is a *persona grata* to the power to which he is accredited.

known as the *Secrét du Roi*.¹ None the less, in the 16th century, laymen as diplomats are already well in evidence. They are usually lawyers, rarely soldiers, occasionally even simple merchants. Not uncommonly they were foreigners, like the Italian Thomas Spinely mentioned above, drawn from that cosmopolitan class of diplomats who were ready to serve any master. Though nobles were often employed as ambassadors by all the powers, Venice alone made nobility a condition of diplomatic service. They were professional in the sense that, for the most part, diplomacy was the main occupation of their lives; there was, however, no graded diplomatic service in which, as at present, it was possible to rise on a fixed system from the position of simple *attaché* to that of minister and ambassador. The "attaché to the embassy" existed; but he was not, as is now the case, a young diplomat learning his profession, but an experienced man of affairs, often a foreigner employed by the ambassador as adviser, secret service agent and general go-between, and he was without diplomatic status.² The 18th century saw the rise of the diplomatic service in the modern sense. The elaboration of court ceremonial, for which Versailles had set the fashion, made it desirable that diplomatic agents should be courtiers, and young men of rank about the court began to be attached to missions for the express purpose of teaching them the art of diplomacy. Thus arose that aristocratic diplomatic class, distinguished by the exquisite refinement of its manners, which survived from the 18th century into the 19th. Modern democracy has tended to break with this tradition, but it still widely prevails. Even in Great Britain, where the rest of the public services have been thrown open to all classes, a certain social position is still demanded for candidates for the diplomatic service and the foreign office, and in addition to passing a competitive examination, they must be nominated by someone of recognized station prepared to vouch for their social qualifications. In America, where no regular diplomatic service exists, all diplomatic agents are nominated by the president.

The existence of an official diplomatic service, however, by no means excludes the appointment of outsiders to diplomatic posts. It is, in fact, one of the main grievances of the regular diplomatic body that the great rewards of their profession, the embassies, are so often assigned to politicians or others who have not passed through the drudgery of the service. But though this practice has, doubtless, sometimes been abused, it is impossible to criticize the wisdom of its occasional application.

A word may be added as to the part played by women in diplomacy. So far as their unofficial influence upon it is concerned, it would be impossible to exaggerate its importance; it would suffice to mention three names taken at random from the annals of the 19th century, Madame de Staël, Baroness von Krüdener, and Princess Lieven. Gentz comments on the "feminine intrigues" that darkened the counsels of the congresses of Vienna and Aix-la-Chapelle, and from which the powers so happily escaped in the bachelor seclusion of Troppau. Nor is it to be supposed that statesmen will ever renounce a diplomatic weapon so easy of disguise and so potent for use. A brilliant *salon* presided over by a woman of charm may be a most valuable centre of a political propaganda; and ladies are still widely employed in the secret diplomacy of the powers. Their employment as regularly accredited diplomatic agents, however, though not unknown, has been extremely rare. An interesting instance is the appointment of Catherine of Aragon, when princess of Wales, as representative of her father, Ferdinand the Catholic, at the court of Henry VII. (G. A. Bergenroth, *Calendar of State Papers . . . England and Spain—in the Archives at Simancas, &c.*, i. pp. xxxiii, cxix).

LITERATURE.—Besides general works on international law (q.v.) which necessarily deal with the subject of diplomacy, a vast mass of treatises on diplomatic agents exists. The earliest printed work is the *Tractatus de legato* (Rome, 1485) of Gundissalvus (Gonsalvo de Villadiego), professor of law at Salamanca, auditor for Spain at the

Roman court of the Rota, and bishop of Oviedo; but the first really systematic writer on the subject was Albericus Gentilis, *De legationibus libri iii.* (London, 1583, 1585, Hanover, 1596, 1607, 1612). For a full bibliography of works on ambassadors see Baron Dierich H. L. von Ompteda, *Littérature des états et des ambassadeurs, sowohl natürlichen als politischen Völkerrechts* (Regensburg, 1785), p. 534, &c., which was completed and continued by the Prussian minister Karl Albert von Kamptz, in *Neue Littérature des Völkerrechts seit dem Jahre 1784* (Berlin, 1817), p. 231. A list of writers, with critical and biographical remarks, is also given in Ernest Nys's "Les Commencements de la diplomatie et le droit d'ambassade jusqu'à Grotius," in the *Revue de droit international*, vol. xvi. p. 167. Other useful modern works on the history of diplomacy are: E. C. Grenville-Murray, *Embassies and Foreign Courts, a History of Diplomacy* (2nd ed., 1856); J. Zeller, *La Diplomatie française vers le milieu du XVII^e siècle* (Paris, 1881); A. O. Meyer, *Die englische Diplomatie in Deutschland zur Zeit Eduards VI. und Mariens* (Breslau, 1900); and, above all, Otto Krauske, *Die Entwicklung der ständigen Diplomatie vom fünfzehnten Jahrhundert bis zu den Beschlüssen von 1815 und 1818*, in *Gustav Schmoller's Staats- und sozialwissenschaftliche Forschungen*, vol. v. (Leipzig, 1885). To these may be added, as admirably illustrating in detail the early developments of modern diplomacy, Logan Pearsall Smith's *Life and Letters of Sir Henry Wotton* (Oxford, 1907). Of works on modern diplomacy the most important are the *Guide diplomatique* of Baron Charles de Martens, new edition revised by F. H. Geffcken, 2 vols. (Leipzig, 1866), and P. Pradier-Fodéré, *Cours de droit diplomatique*, 2 vols. (Paris, 1881).

DIPLOMATIC, the science of diplomas, founded on the critical study of the "diplomatic" sources of history: diplomas, charters, acts, treaties, contracts, judicial records, rolls, chartularies, registers, &c. The employment of the word "diploma," as a general term to designate an historical document, is of comparatively recent date. The Roman diploma, so called because it was formed of two sheets of metal which were shut together (Gr. *διπλοῦν*, to double) like the leaves of a book, was the passport or licence to travel by the public post; also, the certificate of discharge, conferring privileges of citizenship and marriage on soldiers who had served their time; and, later, any imperial grant of privileges. The word was adopted, rather pedantically, by the humanists of the Renaissance and applied by them to important deeds and to acts of sovereign authority, to privileges granted by kings and by great personages; and by degrees the term became extended and embraced generally the documents of the middle ages.

History of the Study.—The term "diplomatic," the French *diplomatique*, is a modern adaptation of the Latin phrase *res diplomatice* employed in early works upon the subject, and more especially in the first great text-book, the *De re diplomatice*, issued in 1681 by the learned Benedictine, Dom Jean Mabillon, of the abbey of St Germain-des-Prés. Mabillon's treatise was called forth by an earlier work of Daniel van Papenbroeck, the editor of the *Acta Sanctorum* of the Bollandists, who, with no great knowledge or experience of archives, undertook to criticize the historical value of ancient records and monastic documents, and raised wholesale suspicions as to their authenticity in his *Prophyllacum antiquarium circa veri ac falsi discrimen in vetustis membranis*, which he printed in 1675. This was a rash challenge to the Benedictines, and especially to the congregation of St Maur, or confraternity of the Benedictine abbeys of France, whose combined efforts produced great literary works which still remain as monuments of profound learning. Mabillon was at that time engaged in collecting material for a great history of his order. He worked silently for six years before producing the work above referred to. His refutation of Papenbroeck's criticisms was complete, and his rival himself accepted Mabillon's system of the study of diplomatic as the true one. The *De re diplomatice* established the science on a secure basis; and it has been the foundation of all subsequent works on the subject, although the immediate result of its publication was a flood of controversial writings between the Jesuits and the Benedictines, which, however, did not affect its stability.

In Spain, the Benedictine Perez published, in 1688, a series of dissertations following the line of Mabillon's work. In England, Madox's *Formulare Anglicanum*, with a dissertation concerning ancient charters and instruments, appeared in 1702, and in 1705 Hickeys followed with his *Linguarum septentrionalium thesaurus*, both accepting the principles laid down by the learned

¹ See Zeller.

² A. O. Meyer, p. 22.

³ See the amusing account of the methods of these agents in Morysine to Cecil (January 23, 1551-1552), *Cal. State Pap. Edw. VI.*, No. 530.

Benedictine. In Italy, Maffei appeared with his *Historia diplomatica* in 1727, and Muratori, in 1740, introduced dissertations on diplomacy into his great work, the *Antiquitates Italicae*. In Germany, the first diplomatic work of importance was that by Bessel, entitled *Chronicon Gotwicense* and issued in 1732; and this was followed closely by similar works of Baring, Eckhard and Heumann.

France, however, had been the cradle of the science, and that country continued to be the home of its development. Mabillon had not taken cognizance of documents later than the 13th century. Arising out of a discussion relative to the origin of the abbey of St Vricen en Caux and the authenticity of its archives, a more comprehensive work than Mabillon's was compiled by the two Benedictines, Dom Toussaint and Dom Tassin, viz. the *Nouveau Traité de diplomatique*, in six volumes, 1750-1765, which embraced more than diplomatic proper and extended to all branches of Latin palaeography. With great industry the compilers gathered together a mass of details; but their arrangement is faulty, and the text is broken up into such a multitude of divisions and subdivisions that it is tediously minute. However, its more extended scope has given the *Nouveau Traité* an advantage over Mabillon's work, and modern compilations have drawn largely upon it.

As a result of the Revolution, the archives of the middle ages lost in France their juridical and legal value; but this rather tended to enhance their historical importance. The taste for historical literature revived. The Académie des Inscriptions fostered it. In 1821 the École des Chartes was founded; and, after a few years of incipient inactivity, it received a further impetus, in 1829, by the issue of a royal ordinance re-establishing it. Thenceforth it has been an active centre for the teaching and for the encouragement of the study of diplomatic throughout the country, and has produced results which other nations may envy. Next to France, Germany and Austria are distinguished as countries where activity has been displayed in the systematic study of diplomatic archives, more or less with the support of the state. In Italy, too, diplomatic science has not been neglected. In England, after a long period of regrettable indifference to the study of the national and municipal archives of the country, some effort has been made in recent years to remove the reproach. The publications of the Public Record Office and of the department of MSS. in the British Museum are more numerous and are issued more regularly than in former times; and an awakened interest is manifested by the foundation in the universities of a few lectureships in diplomatic and palaeography, and by the attention which those subjects receive in such an institution as the London School of Economics, and in the publications of private literary societies. But such efforts can never show the systematic results which are to be attained by a special institution of the character of the French École des Chartes.

Extent of the Science.—The field covered by the study of diplomatic is so extensive and the different kinds of documents which it takes into its purview are so numerous and various, that it is impossible to do more than give a few general indications of their nature. No nation can have advanced far on the path of civilization before discovering the necessity for documentary evidence both in public and in private life. The laws, the constitutions, the decrees of government, on the one hand, and private contracts between man and man, on the other, must be embodied in formal documents, in order to ensure permanent record. In the case of a nation advancing independently from a primitive to a later stage of civilization we should have to trace the origin of its documentary records and examine their development from a rudimentary condition. But in an inquiry into the history of the documents of the middle ages in Europe we do not begin with primitive forms. Those ages inherited the documentary system which had been created and developed by the Romans; and, imperfect and limited in number as are the earliest surviving charters and diplomas of European medieval history, they present themselves to us fully developed and cast in the mould and employing the methods and formulæ of the earlier tradition. Based on this foundation the chanceries of the several

countries of Europe, as they came into existence and were organized, reduced to method and rule on one general system the various documents which the exigencies of public and of private life from time to time called into existence, each individual chancery at the same time following its own line of practice in detail, and evolving and confirming particular formulæ which have become characteristic of it.

Classification of Documents.—If we classify these documents under the two main heads of public and private deeds, we shall have to place in the former category the legislative, administrative, judicial, diplomatic documents emanating from public authority in public form: laws, constitutions, ordinances, privileges, grants and concessions, proclamations, decrees, judicial records, pleas, treaties; in a word, every kind of deed necessary for the orderly government of a civilized state. In early times many of these were comprised under the general term of "letters," *litterae*, and to the large number of them which were issued in open form and addressed to the community the specific title of "letters patent," *litterae patentes*, was given. In contradistinction those public documents which were issued in closed form under seal were known as "close letters," *litterae clausae*.

Such public documents belong to the state archives of their several countries, and are the monuments of administrative and political and domestic history of a nation from one generation to another. In no country has so perfect a series been preserved as in our own. Into the Public Record Office in London have been brought together all the collections of state archives which were formerly stored in different official repositories of the kingdom. Beginning with the great survey of Domesday, long series of enrolments of state documents, in many instances extending from the times of the Angevin kings to our own day in almost unbroken sequence, besides thousands of separate deeds of all descriptions, are therein preserved (see RECORD).

Under the category of private documents must be included, not only the deeds of individuals, but also those of corporate bodies representing private interests and standing in the position of individual units in relation to the state, such as municipal bodies and monastic foundations. The largest class of documents of this character is composed of those numerous conveyances of real property and other title deeds of many descriptions and dating from early periods which are commonly described by the generic name of "charters," and which are to be found in thousands, not only in such public repositories as the Public Record Office and the British Museum, but also in the archives of municipal and other corporate bodies throughout the country and in the muniment-rooms of old families. There are also the records of the manorial courts preserved in countless court-rolls and registers; also the scattered muniments of the dissolved monasteries represented by the many collections of charters and the valuable chartularies, or registers of charters, which have fortunately survived and exist both in public and in private keeping.

It will be noticed that in this enumeration of public and private documents in England reference is made to rolls. The practice of entering records on rolls has been in favour in England from a very early date subsequent to the Norman Conquest; and while in other countries the comprehensive term of "charters" (literally "papers": Gr. *χάρτης*) is employed as a general description of documents of the middle ages, in England the fuller phrase "charters and rolls" is required. The master of the rolls, the *Magister Rotulorum*, is the official keeper of the public records.

From the great body of records, both public and private, many fall easily and naturally into the class in which the text takes a simpler narrative form; such as judicial records, laws, decrees, proclamations, registers, &c., which tell their own story in formulæ and phraseology early developed and requiring little change. These we may leave on one side. For fuller description we select those deeds which, conferring grants and favours and privileges, conform more nearly to the idea of the Roman diploma and have received the special attention of the chanceries in the

development and arrangement of their formulæ and in their methods of execution.

All such medieval deeds are composed of certain recognized members or sections, some essential, others special and peculiar to the more elaborate and solemn documents. A deed of the most elaborate character is made up of two principal divisions: 1. THE TEXT, in which is set out the object of the deed, the statement of the considerations and circumstances which have led to it, and the declaration of the will and intention of the person executing the deed, together with such protecting clauses as the particular circumstances of the case may require; 2. THE PROTOCOL (originally, the first sheet of a papyrus roll; Gr. *πρότος*, first, and *κόλλας*, to glue), consisting of the introductory and of the concluding formulæ: superscription, address, salutation, &c., at the beginning, and date, formulæ of execution, &c., at the end, of the deed. The latter portion of the protocol is sometimes styled the eschatocol (Gr. *ἐσχάτος*, last, and *κόλλας*, to glue). While the text followed certain formulæ which had become fixed by common usage, the protocol was always special and varied with the practices of the several chanceries, changing in a sovereign chancery with each successive reign.

The different sections of a full deed, taking them in order under the heads of Initial Protocol, Text and Final Protocol or Eschatocol, are as follows:—The initial protocol consists of the Invocation, the

The Invocation. Superscription, the Address and the Salutation. 1. THE INVOCATION, lending a character of sanctity to the proceedings, might be either verbal or symbolic. The verbal invocation consisted usually of some pious ejaculation, such as *In nomine Dei*, *In nomine domini nostri Jesu Christi*; and from the 8th century, *In nomine Sanctæ et individuæ Trinitatis*; and later, *In nomine Patris et Filii et Spiritus Sancti*. The symbolic form was usually the *chrismon*, or monogram composed of the Greek initials XP of the name of Christ. In the course of the 10th and 11th centuries this symbol came to be so scrawled that it had probably lost all meaning with the scribes. From the 9th century the letter C (initial of *Christus*) came gradually into use, and in German imperial diplomas it superseded the *chrismon*. Stenographic signs of the system known as Tironian notes were also sometimes added to this symbol down to the end of the 10th century, expressing such a phrase as *Ante omnia Christus, or Christus, or Amen*. From the Merovingian period, too, a cross was often used. The symbol gradually died out after the 12th century for general use, surviving only in notarial instruments and wills. 2. THE SUPERSCRPTION (*superscriptio, intitulation*) expressed the name and titles of the grantor or person issuing the deed. 3. THE ADDRESS. As diplomas were originally in epistolary form the address was then a necessity. While in Merovingian deeds the old pattern was adhered to, in the Carolingian period the address was sometimes omitted. From the 8th century it was not considered necessary, and a distinction arose in the case of royal acts, those having the address being styled letters, and those omitting it, charters. The general form of address ran in phrase as *Omnibus (or Universis) Christi fidelibus presentibus et futuris*.

The Salutation. 4. THE SALUTATION was expressed in such words as *Salvatus et dilectionem; Salutem et apostolicam benedictionem*, but it was not essential. Then follows the text in five sections: the Preamble, the Notification, the Exposition, the Disposition and the Final Clauses. 5. THE PREAMBLE (*prologus, arenga*): an ornamental introduction generally composed of pious or moral sentiments, a *prefatio ad captandum benevolentiam* which *facit ad ornamentum*, degenerating into tiresome platitudes. It became stereotyped at an early age; in the 10th and 11th centuries it was a most ornate performance; in the 12th century it was cut short; in the 13th century it died out. 6. THE NOTIFICATION (*notificatio, promulgatio*) publication of the purport of the deed introduced by such a phrase as *notum sit, &c.* 7. THE EXPOSITION set out the motives influencing the issue of the deed. 8. THE DISPOSITION described the object of the deed and the will and intention of the grantor. 9. THE FINAL CLAUSES ensured the fulfilment of the terms of the deed; guarded against infringement; by comminatory anathemas and imprecations, not infrequently of a vehement description, or by penalties; guaranteed the validity of the deed; enumerated the formalities of subscription and execution; reserved rights, &c.

Next comes the final protocol or eschatocol comprising: the Date, the Appreciation, the Authentication. It was particularly in this portion of the deed that the varying practices of the several chanceries led to minute and intricate distinctions at different periods. 10. THE DATE. By the Roman law every act must be dated by the day and the year of execution. Yet in the middle ages, from the 9th to the 12th century, a large proportion of deeds bears no date. In the most ancient charters the date clause was frequently separated from the body of the deed and placed in an isolated position at the foot of the sheet. From the 12th century it commonly followed the text immediately. Certain classes of documents, such as decrees of councils, notarial deeds, &c., began with

the date. The usual formula was *data, datum, actum, factum, scriptum*. In the Carolingian period a distinction grew up between *datum* and *actum*, the former applying to the time, the latter to the place, of date. In the papal chancery from an early period down to the 12th century the use of a double date prevailed, the first following the text and being inserted by the scribe when the deed was written (*scriptum*), the second being added at the foot of the deed on its execution (*actum*), by the chancellor or other high functionary. From the Roman custom of dating by the consular year arose the medieval practice of dating by the regnal year of emperor, king or pope. Special dates were sometimes employed, such as the year of some great historical event, battle, siege, pestilence, &c. 11. THE APPRECIATION. The *felicitur* of the Romans became the medieval *felicitur in Domino*, or *The Appreciation*. *In Dei nomine felicitur*, or the more simple *Deo gratias* or the still more simple *Amen*, for the auspicious closing of a deed.

In Merovingian and Carolingian diplomas it follows the date; in other cases it closes the text. In the greater papal bulls it appears in the form of a triple *Amen*. *Benedicite* was also employed as the appreciation in early deeds; but in Merovingian diplomas and in papal bulls this valedictory salutation becomes a mark of authentication, as will be noticed below. 12. THE AUTHENTICATION was a solemn proceeding which was discharged by more than one act. The most important was the subscription or subscriptions of the person or persons from whom the deed emanated. The laws of the late Roman empire required the subscriptions and the impressions of the signet seals of the parties and of the witnesses to the deed. The subscription (*subscriptio*) comprised the name, signature and description (of the person signing). The impression of the signet (not the signature) was the *signum*, sometimes *signaculum*, rarely *sigillum*. The practice of subscribing with the autograph signature obtained in the early middle ages, as appears from early documents such as those of Ravenna. But from the 7th century it began to decline, and by the 12th century it had practically ceased. In Roman deeds an illiterate person affixed his mark, or *signum manuale*, which was attested. The cross being an easy form for a mark, it was very commonly used and naturally became connected with the Christian symbol. Hence, in course of time, it came to be attached very generally to subscriptions, autograph or otherwise. Great personages who were illiterate required something more elaborate than a common mark. Hence arose the use of the monogram, the *caracter nominis*, composed of the letters of the name. The emperor Justin, who could not write, made use of a monogram, as did also Theodorik, king of the Ostrogoths. Those Merovingian kings, likewise, who were illiterate, had their individual monograms; and at length Charlemagne adopted the monogram as his regular form of signature. From his reign down to that of Philip the Fair the monogram was the recognized sign manual of the sovereigns of France (see AUTOGRAPHS). It was employed by the German emperors down to the reign of Maximilian I. The royal use of the monogram was naturally imitated by great officers and ecclesiastics. But another form of sign manual also arose out of the subscription. The closing word (usually *subscriptus*), written or abbreviated as *sub*, or *cl*, or *z*, was often finished off with flourishes and interlacings, sometimes accompanied with Tironian notes, the whole taking the shape of a domed structure to which the French have given the name of *ruche* or bee-hive. Thus in the early middle ages we have deeds authenticated by the subscription, usually autograph, giving the name and titles of the person executing, and stating the part taken by him in the deed, and closing with the *subscriptus*, often in shape of the *ruche* and constituting the *signum manuale*. If not autograph, the subscription might be impersonal in such form as *signum (or signum manus) + N*. In the Carolingian period, while phrases were constantly used in the body of the deed implying that it was executed by autograph subscription, it did not necessarily follow that such subscription was actually written in person. The *ruche* was also adopted by chancellors, notaries and scribes as their official mark. While autograph subscriptions continued to be employed, chiefly by ecclesiastics, down to the beginning of the 12th century, the monogram was perpetuated from the 10th century by the notaries. Their marks, simple at first, became so elaborate from the end of the 13th century that they found it necessary to add their names in ordinary writing, or also to employ a less complicated design. This was the commencement of the modern practice of writing the signature which first came into vogue in the 14th century.

To lend further weight and authority to the subscription, certain symbols and forms were added at different periods. Imitating the corroborative *Legi* of the Byzantine quæstor and the *Legimus* of the Eastern emperors, the Frankish chancery in the West made use of the same form, notably in the reign of Charles the Bald, in some of whose diplomas the *Legimus* appears written in larger letters in red. The valedictory *Benedicite*, employed in early deeds as a form of appreciation (see above), appears in Merovingian and in early Carolingian royal diplomas, and also in papal bulls, as an authenticating addition to the subscription. In the diplomas it was written in cursive letters in two lines, *Bene valete*, just to the right of the incision cut in the sheet to hold fast the seal, which sometimes even covered part of the word. In the most ancient papal bulls it was written by the pope himself at the foot of the deed,

The Notarisation.

The Exposition.

The Disposition.

The Final Clauses.

The Authentication.

The Date.

The Appreciation.

The Subscription.

The Eschatocol.

The Invocation.

The Address.

The Superscription.

The Text.

The Initial Protocol.

The Final Protocol.

The Authentication.

The Subscription.

The Eschatocol.

The Address.

The Superscription.

The Invocation.

The Text.

The Initial Protocol.

The Final Protocol.

The Authentication.

The Subscription.

The Eschatocol.

The Address.

The Superscription.

The Invocation.

The Text.

The Initial Protocol.

The Final Protocol.

The Authentication.

The Subscription.

The Eschatocol.

The Address.

The Superscription.

The Invocation.

The Text.

The Initial Protocol.

The Final Protocol.

The Authentication.

The Subscription.

The Eschatocol.

The Address.

The Superscription.

The Invocation.

The Text.

in two lines, generally in larger capital or uncial characters, placed between two crosses. From the beginning of the 11th century it became the fashion to link the letters; and, dating from the time of Leo IX., A.D. 1048-1054, the *Benevolens* was inscribed in form of a monogram. During Leo's pontificate it was also accompanied with a flourish called the *Komma*, which was only an exaggeration of the mark of punctuation (*periodus*) which from the 9th to the 11th century closed the subscription and generally resembled the modern semicolon. Leo's successors abandoned the *Komma*, but the monogrammatic *Benevolens* continued, invariable in form, but from time to time varying in size. In Leo IX.'s pontificate also was introduced the *Rota*. This sign, when it had received its final shape in the 11th century, was in form of a wheel, composed of two concentric circles, in the space between of which was written the motto or device of the pope (*signum papae*), usually a short sentence from one of the Psalms or some other portion of Scripture; preceded by a small cross, which the pontiff himself sometimes inscribed. The central space within the wheel was divided (by cross lines) into four quarters, the two upper ones being occupied by the names of the apostles St Peter and St Paul, and the two lower ones by the name of the pope. The *Rota* was placed on the left of the subscription, the monogrammatic *Benevolens* on the right. From the same period also the Spanish and Portuguese monarchs adopted the *Rota*, the *signo rodado*, which is so conspicuous in the royal charters of the Peninsula.

Besides the subscription, an early auxiliary method of authentication was by the impression of the seal which, as noticed above, was required by the Roman law. But the general use of the signet gradually failed, and by the 7th century it had ceased. Still it survived in the royal chanceries; and the sovereigns both of the Merovingian and of the Carolingian lines had their seals; and in the 8th century, the mayors of the palace likewise. It is interesting to find instances of the use of antique intaglios for the purpose by some of them. In England too there is proof that the Mercian kings Offa and Coenwulf used seals, in imitation of the Frankish monarchs. In the 7th century, and still more so in the 8th and 9th centuries, the royal seals were of exaggerated size: the precursors of the great seals of the later sovereigns of western Europe. The waxen seals of the early diplomas were in all cases *en placard*: that is, they were attached to the face of the document and not suspended from it, being held in position by a cross-cut incision in the material, through which the wax was pressed and then flattened at the back. On the cessation of autograph signatures in subscriptions, the general use of seals revived, beginning in the 10th century and becoming the ordinary method of authentication from the 12th to the 15th century inclusive. Even when signatures had once again become universal, the seal continued to hold its place; and thus sealing is, to the present day, required for the legal execution of a deed. The attachment *en placard* was discontinued, as a general practice, in the middle of the 11th century; and seals thenceforward were, for the most part, suspended, leathern thongs being used at first, and afterwards silken and hempen cords or parchment labels. In documents of minor importance it was sometimes the custom to impress the seal or seals on one or more strips of the parchment of the deed itself, cut, but not entirely detached, from the lower margin, and left to hang loose. Besides waxen impressions of seals, impressions in metal, bearing a device on both faces, after the fashion of a coin, and suspended, were employed from an early period. The most widely known instances are the *bullae* attached to papal documents, generally of lead. The earliest surviving papal *bulle* is one of Pope Zachary, A.D. 746, but earlier examples are known from the time of Boniface V. to Leo IV., A.D. 817-855, the name of the pontiff, in the genitive case, was impressed on the obverse, and his title as pope on the reverse, *e. Bonifacii papae*. After that period, for some time, the name was inscribed in a circle round a central ornament. Other variations followed; but at length in the pontificate of Paschal II., A.D. 1099, the *bulle* took the form which it afterwards retained: on the obverse, the heads of the apostles St Peter and St Paul; on the reverse, the pope's name, title and number in succession. In the period of time between his election and consecration, the pope made use of the half-bull, that is, the obverse only was impressed. It should be mentioned that, in order to conform to modern conditions and for convenience of despatch through the post, Leo XIII., in 1878, substituted for the leaden *bulle* a red ink stamp bearing the heads of the two apostles with the name of the pope inscribed as a legend.

The Carolingian monarchs also used metal *bullae*. None of Charlemagne's have survived, but there are still extant leaden examples of Charles the Bald. The use of lead was not persisted in either in the chancery of France or in that of Germany. Golden *bullae* were employed on special occasions by both popes and temporal monarchs; for example, they were attached to the confirmations of the elections of the emperors in the 12th and 13th centuries: the bull of Leo X. conferring the title of Defender of the Faith on Henry VIII. in 1524, and the deed of alliance between Henry and Francis I. in 1527, had golden *bullae*; and other examples could be cited. But lead has always been the common metal to be thus

employed. In the southern countries of Europe, where the warmth of the climate renders wax an undesirable material, leaden *bullae* have been in ordinary use, not only in Italy but also in the Peninsula, in southern France, and in the Latin East (see *SRAAS*).

The necessity of conforming to exact phraseology in diplomas and of observing regularity in expressing formulas naturally led to the compilation of formularies. From the early middle ages the art of composition, not only of charters but also of general correspondence, was commonly taught in the monasteries. The teacher was the *dictator*, his method of teaching was described by the verb *dictare*, and his teaching was *dictamen* or the *ars dictaminis*. For the use of these monastic schools, formularies and manuals comprising formulas and models for the composition of the various acts and documents soon became indispensable. At a later stage such formularies developed into the models and treatises for epistolary style which have had their imitations even in modern times. The widespread use of the formularies had the advantage of imposing a certain degree of uniformity on the phrasing of documents of the western nations of Europe. Those compilations which are of an earlier period than the 11th century have been systematically examined and are published; those of more recent date still remain to be thoroughly edited. The early formularies are of the simpler kind, being collections of formulas without dissertation. The *Formulae Marculfi*, compiled by the monk Marculf about the year 650, was the most important work of this nature of the Merovingian period and became the official formulary of the time; and it continued in use in a revised edition in the early Carolingian chancery. Of the same period there are extant formularies compiled at various centres, such as Angers, Tours, Bourges, Sens, Reichenau, St Gall, Salzburg, Passau, Regensburg, Cordova, &c. (see Giry, *Manuel de diplomatique*, pp. 482-488). The *Liber stirvensis Romanorum Pontificum* was compiled in the 7th and 8th centuries, and was employed in the papal chancery to the end of the 11th century. Of the more developed treatises and manuals of epistolary rhetoric which succeeded, and which originated in Italy, the earliest example was the *Breviarium de dictamine* of the monk Alberic of Monte Cassino, compiled about the year 1075. Another well-known work, the *Rationes dictandi*, is also attributed to the same author. Of later date was the *Ars dictaminis* of Bernard of Chartres of the 12th century. (Among special works on formularies are: E. de Rozière, *Recueil général des formules usitées dans l'empire des Francs* (3 vols., Paris, 1861-1871); K. Zeumer, *Formulae Merovingici et Karolini aevi* (Hanover, 1886); and L. Rockinger, *Briefsteller und Formelbücher des 11 bis 14 Jahrhunderts* (Munich, 1863-1864).)

Organisation.—The formalities observed by the different chanceries of medieval Europe, which are to be learned from a study of the documents issued by them, are so varied and often so minute, that it is impossible to give a full account of them within the limits of the present article. We can only state some of the results of the investigations of students of diplomatic.

The chancery which stands first and foremost is the papal chancery. On account of its antiquity and of its steady development, it has served as a model for the other chanceries of Europe. Organized in remote times, it adopted for the structure of its letters a number of formulas and rules which developed and became more and more fixed and precise from century to century. The Apostolic court being organized from the first on the model of the Roman imperial court, the early pontiffs would naturally have collected their archives, as the emperors had done, into *scrinia*. Pope Julius I., A.D. 337-353, reorganized the papal archives under an official *schola notariorum*, at the head of which was a *primicerius notariorum*. Pope Damasus, A.D. 366-384, built a record office at the Lateran, *archivium sanctae Romanae ecclesiae*, where the archives were kept and registers of them compiled. The collection and orderly arrangement of the archives provided material for the establishment of regular diplomatic usages, and the science of formulae naturally followed.

For the study of papal documents four periods have been defined, each successive period being distinguished from its predecessor by some particular development of forms and procedure. The first period is reckoned from the earliest times to the accession of Leo IX., A.D. 1048. For almost the whole of the first eight centuries no original papal documents have survived. But copies are found in canonical works and registers, many of them false, and others probably not transcribed in full or in the original words; but still of use, as showing the growth of formulas. The earliest original document is a fragment of a letter of Adrian I., A.D. 788. From that date there is a series, but the documents are rare to the beginning of the 11th century, all down to that period being written on papyrus. The latest existing

Papal
Chancery.

papyrus document in France is one of Sergius IV., A.D. 1011; in Germany, one of Benedict VIII., A.D. 1022. The earliest document on vellum is one of John XVIII., A.D. 1005. The nomenclature of papal documents even at an early period is rather wide. In their earliest form they are Letters, called in the documents themselves, *litterae, epistola, pagina, scriptum*, sometimes *decretum*. A classification, generally accepted, divides them into: 1. Letters or Epistles: the ordinary acts of correspondence with persons of all ranks and orders; including constitutions (a later term) or decisions in matters of faith and discipline, and encyclicals giving directions to bishops of the whole church or of individual countries. 2. Decrees, being letters promulgated by the popes of their own motion. 3. Decretals, decisions on points of ecclesiastical administration or discipline. 4. Rescripts (called in the originals *preceptum, auctoritas, privilegium*), granting requests to petitioners. But writers differ in their terms, and such subdivisions must be more or less arbitrary. The comprehensive term "bull" (the name of the leaden papal seal, *bulia*, being transferred to the document) did not come into use until the 13th century.

Copies of papal deeds were collected into registers or *bullaria*. Lists showing the chronological sequence of documents are catalogues of acts. When into such lists indications from narrative sources are introduced they become *regesta (res gestae)*: a term not to be confused with "register."

Clearness and conciseness have been recognized as attributes of early papal letters; but even in those of the 4th century certain rhythmical periods have been detected in their composition which became more marked under Leo the Great, A.D. 440-461, and which developed into the *cursus* or prose rhythm of the pontifical chancery of the 11th and 12th centuries.

In the most ancient deed the pope styles himself *Episcopus*, sometimes *Episcopus Catholice Ecclesiae*, or *Episcopus Romanae Ecclesiae*, rarely *Papa*. Gregory I., A.D. 590, was the first to adopt the form *Episcopus, servus servorum Dei*, which became general in the 9th century, and thenceforth was invariable.

The second period of papal documents extends from Leo IX. to the accession of Innocent III., A.D. 1048-1198. At the beginning of the period formulae tended to take more definite shape and to become fixed. In the superscription of bulls a distinction arose: those which conferred lasting privileges employing the words *in perpetuum* to close this clause; those whose benefaction was of a transitory character using the form of salutation, *salutem et apostolicam benedictionem*. But it was under Urban II., A.D. 1088-1099, that the principal formulae became stereotyped. Then the distinction between documents of lasting, and those of transitory, value became more exactly defined; the former class being known as greater bulls, *bullae majores* (also called *privilegia*), the latter lesser bulls, *bullae minores*. The leading characteristics of the greater bulls were these: The first line containing the superscription and closing with the words *in perpetuum* (or, sometimes, *ad perpetuam, or aeternam, rei memoriam*) was written in tall and slender ornamental letters, close packed; the final clauses of the text develop with tendency to fixity; the pope's superscription is accompanied with the *rota* on the left and the *benevalete* monogram on the right; and certain elaborate forms of dating are punctiliously observed. The introduction of subscriptions of cardinals as witnesses had gradually become a practice. Under Victor II., A.D. 1055-1057, the practice became more confirmed, and after the time of Innocent II., A.D. 1130-1145, the subscriptions of the three orders were arranged according to rank, those of the cardinal bishops being placed in the centre under the papal subscription, those of the priests under the *rota* on the left, and those of the deacons under the *benevalete* on the right. In the lesser bulls simpler forms were employed; there was no introductory line of stilted letters; the salutation, *salutem et apostolicam benedictionem*, closed the superscription; the final clauses were shortened; there was neither papal subscription, nor *rota*, nor *benevalete*; the date was simple.

From the time of Adrian I., A.D. 772-795, the system of double dating was followed in the larger bulls. The first date was written by the scribe of the document, *scriptum per manum N.* with the month (rarely the day of the month) and year of the indiction.

The second, the actual date of the execution of the deed, was entered (ostensibly) by some high official, *data, or datum, per manum N.*, and contained the day of the month (according to the Roman calendar), the year of indiction, the year of pontificate (in some early deeds, also the year of the empire and the post-consulate year), and the year of the Incarnation, which, however, was gradually introduced and only became more common in the course of the 11th century. For example, a common form of a full date would run thus: *Datum Laterani, per manum N., sanctae Romanae ecclesiae diaconi cardinalis, xiiii. kl. Maii, indictione V., anno dominicae Incarnationis mxcvii., pontificatus autem domini papae Urbani secundi X°.* The simpler form of the date of a lesser bull might be: *Datum Laterani, iii. non. Jan., pontificatus nostri anno iiii.*

By degrees the use of the lesser bulls almost entirely superseded that of the greater bulls, which became exceptional in the 13th century and almost ceased after the migration to Avignon in 1309. In modern times the greater bulls occasionally reappear for very solemn acts, as *bullae consistoriales*, executed in the consistory.

The third period of papal documents extends from Innocent III. to Eugenius IV., A.D. 1198-1431. The pontificate of Innocent III. was a most important epoch in the history of the development of the papal chancery. Formulae became more exactly fixed, definitions more precise, the observation of rules and precedents more constant. The staff of the chancery was reorganized. The existing series of registers of papal documents was then commenced. The growing use of lesser bulls for the business of the papal court led to a further development in the 13th century. They were now divided into two classes: *Tituli* and *Mandamenta*. The former conferred favours, promulgated precepts, judgments, decisions, &c. The latter comprised ordinances, commissions, &c., and were executive documents. There are certain features which distinguish the two classes. In the *tituli*, the initial letter of the pope's name is ornamented with openwork and the other letters are stilted. In the *mandamenta*, the initial is filled in solid and the other letters are of the same size as the rest of the text. In the *tituli*, enlarged letters mark the beginnings of the text and of certain clauses; but not in the *mandamenta*. In the former the mark of abbreviation is a looped sign; in the latter it is a horizontal stroke. In the former the old practice of leaving a gap between the letters *s* and *t*, and *c* and *t*, whenever they occur together in a word (e.g. *is te, sanctus*), and linking them by a coupling stroke above the line is continued; in the latter it disappears. The leaden bulla attached to a *titulus* (as a permanent deed) is suspended by cords of red and yellow silks; while that of a *mandamentum* (a temporary deed) hangs from a hempen cord.

In the fourth period, extending from 1431 to the present time, the *tituli* and *mandamenta* have continued to be the ordinary documents in use; but certain other kinds have also arisen. Briefs (*brevia*), or apostolic letters, concerning the personal affairs of the pope or the administration of the temporal dominion, or conceding indulgences, came into general use in the 13th century in the pontificate of Eugenius IV. They are written in the italic hand on thin white vellum; and the name of the pope with his style as *papa* is written at the head of the sheet, e.g. *Eugenius papa iiii.* They are closed and sealed with Seal of the Fisherman, *sub anulo Piscatoris*. Briefs have almost superseded the *mandamenta*. The documents known as Signatures of the court of Rome or Latin letters, and used principally for the expedition of indulgences, were first introduced in the 15th century. They were drawn in the form of a petition to the pope, which he granted by the words *fiat ut petatur* written across the top. They were not sealed; and only the pontifical year appears in the date. Lastly, the documents to which the name of *Motu proprio* is given are also without seal and are used in the administration of the papal court, the formula *placet et ita motu proprio mandamus* being signed by the pope.

The character of the handwriting employed by the papal chancery is discussed in the article PALAEOGRAPHY. Here it will be enough to state that the early style was derived from the Lombardic hand, and that it continued in use down to the beginning of the 12th century; but that, from the 10th century,

owing to the general adoption of the Caroline minuscule writing, it began to fail and gradually became so unfamiliar to the uninitiated, that, while it still continued in use for papal bulls, it was found necessary to accompany them with copies written in the more intelligible Caroline script. The intricate, fanciful character, known as the *Liters sancti Petri*, was invented in the time of Clement VIII., A.D. 1592-1605, was fully developed under Alexander VIII., 1689-1691, and was only abolished at the end of the year 1878 by Leo XIII.

Of the chancery of the Merovingian line of kings as many as ninety authentic diplomas are known, and, of these, thirty-seven are originals, the earliest being of the year 625. The most ancient examples were written on papyrus, vellum superseding that material towards the end of the 7th century. All these diplomas are technically letters, having the superscription and address and, at the foot, close to the seal, the valedictory *benevolete*. They commence with a monogrammatic invocation, which, together with the superscription and address written in fanciful elongated letters, occupies the first line. The superscription always runs in the form, *N. rex Francorum*. The most complete kinds of diplomas were authenticated by the king's subscription, that of the *referendarius* (the official charged with the custody of the royal seal), the impression of the seal, and exceptionally by subscriptions of prelates and great personages. The royal subscription was usually autograph; but, if the sovereign were too young or too illiterate to write, a monogram was traced by the scribe. The referendary, if he countersigned the royal subscription, added the word *optulit* to his own signature; if he subscribed independently, he wrote *recognovit et subscripsit*, the end of the last word being usually lost in flourishes forming a *ruche*. The date gave the place, day, month and year of the reign. The Merovingian royal diplomas are of two classes: (1) Precepts, conferring gifts, favours, immunities and confirmations, entitled in the documents themselves as *præceptum*, *præceptio*, *actorialis*; some drawn up in full form, with preamble and ample final clauses; others less precise and formal. (2) Judgments (*judicia*), which required no preamble or final clauses as they were records of the sovereign's judicial decisions; they were subscribed by the referendary and were sealed with the royal seal. Other classes of documents were the *cartæ de mundeburde*, taking persons under the royal protection, and *indicti* or letters transmitting orders or notifying decisions; but no examples have survived.

The diplomas of the early Carolingians differed, as was natural, but little from those of their predecessors. As mayors of the palace, Charles Martel and Pippin took the style of *vir iustus*. On becoming king, Pippin retained it; Pippinus, *vir iustus*, *rex Francorum*, and it continued to be part of the royal title till Charlemagne became emperor. The royal subscription was in form of a sign-manual or mark; but Charlemagne elaborated this into a monogram of the letters of his name built up on a cross. In 775 the royal title of Charlemagne became *Carolus, gratia Dei rex Francorum et Langobardorum, ac patricius Romanorum*, the last words being assumed on his visit to Rome in 774. On becoming emperor in 800, he was styled *Imperator, Romanus gubernans imperium, rex Francorum et Langobardorum*. It is to be noticed that thenceforth his name was spelt with initial K (as it was on the monogram), having previously been written with C in the deeds. Most of his diplomas were authenticated by the subscription of the chancellor and impression of the seal. A novelty in the form of dating was also introduced, two words, *datum* (for time) and *actum* (for place), being now employed. The character of the writing of the diplomas, founded on the Roman cursive hand, which had become very intricate under the Merovingians, improved under their successors, yet the reform which was introduced into the literary script hardly affected the cursive writing of diplomatic until the latter part of Charlemagne's reign. The archaic style was particularly maintained in judgments, which were issued by the private chancery of the palace, a department more conservative in its methods than the imperial chancery. It was in the reign of Louis Debonair, A.D. 814-840, that the Carolingian

diploma took its final shape. A variation now appears in the monogram, that monarch's sign-manual being built up, not on a cross as previously, but on the letter H., the initial of his name Hludovicus, and serving as the pattern for successive monarchs of the name of Louis.

In the Carolingian chancery the staff was exclusively ecclesiastical; at its head was the chancellor, whose title is traced back to the *cancellarius*, or petty officer under the Roman empire, stationed at the bar or lattice (*cancelli*) of the basilica or other law court and serving as usher. As keeper of the royal archives his subscription was indispensable for royal acts. The diplomas were drawn up by the notaries, an important body, upon whom devolved the duty of maintaining the formulæ and traditions of the office. It has been observed that in the 9th century the documents were drawn carefully, but that in the 10th century there was a great degeneration in this respect. Under the early Capetian kings there was great confusion and want of uniformity in their diplomas; and it was not until the reign of Louis VI., A.D. 1108, that the formulæ were again reduced to rules.

The acts of the imperial chancery of Germany followed the patterns of the Carolingian diplomas, with little variation down to the reign of Frederick Barbarossa, A.D. 1152-1190. The sovereign's style was *N. divina favente clementia rex*; after coronation at Rome he became *imperator augustus*. At the end of the 10th century, Otto III. developed the latter title into *Romanorum imperator augustus*. Under Henry III., and regularly from the time of Henry V., A.D. 1106-1125, the title before coronation has been *Romanorum rex*. The royal monogram did not necessarily contain all the letters of the name; but, on the other hand, from the year 976, it became more complicated and combined the imperial title with the name. For example, the monogram of Henry II. combines the words *Henricus Romanorum imperator augustus*. The flourished *ruches* also, as in the Frankish chanceries, were in vogue. Eventually they were used by certain of the chancellors as a sign-manual, and took fanciful shapes, such as a building with a cupola, or even a diptych. They disappear early in the 12th century, the period when in other respects the chancery of the Holy Roman Empire largely adopted a more simple style in its diplomas. Lists of witnesses, in support of the royal and official subscriptions, were sometimes added in the course of the 11th century, and they appear regularly in documents a hundred years later.

For the study of diplomatic in England, material exists in two distinct series of documents, those of the Anglo-Saxon period, and those subsequent to the Norman Conquest. The Anglo-Saxon kings appear to have borrowed, partially, the style of their diplomas from the chanceries of their Frankish neighbours, introducing at the same time modifications which give those documents a particular character marking their nationality. In some of the earlier examples we find that the lines of the foreign style are followed more or less closely; but very soon a simpler model was adopted which, while it varied in formulas from reign to reign, lasted in general construction down to the time of the Norman Conquest. The royal charters were usually drawn up in Latin, sometimes in Anglo-Saxon, and began with a preamble or exordium (in some instances preceded by an invocation headed with the *chrismon* or with a cross), in the early times of a simple character, but, later, drawn out not infrequently to great length in involved and bombastic periods. Then immediately followed the disposing or granting clause, often accompanied with a few words explaining the motive, such as, for the good of the soul of the grantor; and the text was closed with final clauses of varying extent, protecting the deed against infringement, &c. In early examples the dating clause gave the day and month (often according to the Roman calendar) and the year of the indiction; but the year of the Incarnation was also immediately adopted; and, later, the regnal year also. The position of this clause in the charter was subject to variation. The subscriptions of the king and of the personages witnessing the deed, each preceded by a cross, but all written by the hand of the scribe, usually closed the charter. A peculiarity was the introduction, in many instances, either in the body of the charter,

Merovingian chancery.

Imperial German chancery.

Diplomatic in England.

or in a separate paragraph at the end, of the boundaries of the land granted, written in the native tongue. The sovereigns of the several kingdoms of the Heptarchy, as well as those of the United Kingdom, usually styled themselves *rex*. But from the time of Æthelstan, A.D. 825-840, they also assumed fantastic titles in the text of their charters, such as: *rex et primicerius, rex et rector, gubernator et rector, monarchus*, and particularly the Greek *basileus*, and *basileus indistrisus*. At the same time the name of Albion was also frequently used for Britain.

A large number of documents of the Anglo-Saxon period, dating from the 7th century, has survived, both original and copies entered in chartularies. Of distinct documents there are nearly two hundred; but a large proportion of these must be set aside as copies (both contemporary and later) or as spurious deeds.

Although there is evidence, as above stated, of the use of seals by certain of the Mercian kings, the method of authentication of diplomas by seal impression was practically unknown to the Anglo-Saxon sovereigns, save only to Edward the Confessor, who, copying the custom which obtained upon the continent, adopted the use of a great seal.

With the Norman Conquest the old tradition of the Anglo-Saxons disappeared. The Conqueror brought with him the practice of the Roman chancery, which naturally followed the Capetian model; and his diplomas of English origin differed only from those of Normandy by the addition of his new style, *rex Anglorum*, in the superscription. But even from the first there was a tendency to simplicity in the new English chancery, not improbably suggested by the brief formalities of Anglo-Saxon charters, and, side by side with the more formal royal diplomas, others of shorter form and less ceremony were issued, which by the reign of Henry II. quite superseded the more solemn documents. These simpler charters began with the royal superscription, the address, and the salutation, e.g. *Willelmus, Dei gratia rex Anglorum, N. episcopo et omnibus baronibus et fidelibus suis Francis et Angli salutem*. Then followed the notification and the grant, e.g. *Sciatis me concessisse, &c.*, generally without final clauses, or, if any, brief clauses of protection and warranty; and, at the end, the list of witnesses and the date. The regnal year was usually cited; but the year of the Incarnation was also sometimes given. The great seal was appended. To some of the Conqueror's charters his subscription and those of his queen and sons are attached, written by the scribe, but accompanied with crosses which may or may not be autograph. By the reign of John the simpler form of royal charters had taken final shape, and from this time the acts of the kings of England have been classified under three heads: viz. (1) Charters, generally of the pattern described above; (2) Letters patent, in which the address is general, *Universis presentes litteras inspecturis, &c.*; the corroborative clause describes the character of the document, *In cuius rei testimonium has litteras nostras fieri fecimus patentes*; the king himself is his own witness, *Teste me ipso*; and the great seal is appended; (3) Close letters, administrative documents conveying orders, the king witnessing, *Teste me ipso*.

The style of the English kings down to John was, with few exceptions, *Rex Anglorum*; thenceforward, *Rex Angliæ*. Henry II. added the feudal titles, *dux Normannorum et Aquitanorum et comes Andegavorum*, which Henry III. curtailed to *dux Aquitaniae*. John added the title *dominus Hiberniæ*; Edward III., on claiming the crown of France, styled himself *rex Angliæ et Franciæ*, the same title being borne by successive kings down to the year 1801; and Henry VIII., in 1521, assumed the title of *fidei defensor*. The formula *Dei gratia* does not consistently accompany the royal title until the reign of Henry II., who adopted it in 1173 (see L. Delisle, *Mémoire sur la chronologie des chartes de Henri II.*, in the *Bibl. de l'École des Chartes*, lvii. 361-401).

The forms adopted in the royal chanceries were naturally imitated in the composition of private deeds which in all countries form the mass of material for historical and diplomatic research. The student of English diplomatic will soon remark how readily the private charters, especially conveyances of real property, fall into classes, and how stereotyped the phraseology and formulæ of each class become,

only modified from time to time by particular acts of legislation. The brevity of the early conveyances is maintained through successive generations, with only moderate growth as time progresses through the 12th, 13th and 14th centuries. The different kinds of deeds which the requirements of society have from time to time called into existence must be learned by the student from the text-books. But a particular form of document which was especially in favour in England should be mentioned. This was the chirograph (Gr. *χρῆρ*, a hand, *γράφω*, to write), which is found even in the Anglo-Saxon period, and which got its name from the word *chirographum, cirographum* or *cyrographum* being written in large letters at the head of the deed. At first the word was written, presumably, at the head of each of the two authentic copies which the two parties to a transaction would require. Then it became the habit to use the word thus written as a tally, the two copies of the deed being written on one sheet, head to head, with the word between them, which was then cut through longitudinally in a straight, or more commonly waved or indented (*in modum dentium*) line, each of the two copies thus having half of the word at the head. Any other word, or a series of letters, might thus be employed; and more than two copies of a deed could thus be made to tally. The chirograph was the precursor of the modern indenture, the commonest form of English deeds, though no longer a tally. In other countries, the notarial instrument has performed the functions which the chirograph and indenture have discharged for us.

AUTHORITIES.—General treatises, handbooks, &c., are J. Mabillon, *De re diplomatica* (1709); Tassin and Toustain, *Nouveau Traité de diplomatique* (1750-1765); T. Madox, *Formulæ Anglicanæ* (1702); G. Hicken, *Linguarum septentrionalium thesaurus* (1703-1705); F. S. Maffei, *Historia diplomatica* (1727); G. Marini, *I Papiri diplomatici* (1805); G. Bessel, *Chronicon Gohwiense* (*De diplomatibus imperatorum ac regum Germaniæ*) (1732); A. Fumagalli, *Delle istituzioni diplomatiche* (1802); M. F. Köpp, *Palaeographia critica* (1817-1829); K. T. G. Schönemann, *Versuch eines vollständigen Systems der Diplomatik* (1818); T. Sichel, *Lehre von den Urkunden der ersten Karolinger* (1867); J. Ficker, *Beiträge zur Urkundenlehre* (1877-1878); A. Gloria, *Compendio delle lezioni di paleografia e diplomatia* (1870); C. Paoli, *Programma scolastico di paleografia Latina e di diplomatia* (1888-1890); H. Bresslau, *Handbuch der Urkundenlehre für Deutschland und Italien* (1889); A. Giry, *Manuel de diplomatique* (1894); F. Leist, *Urkundenlehre* (1893); E. M. Thompson, *Handbook of Greek and Latin Palaeography*, cap. six. (1906); J. M. Kemble, *Codex diplomaticus aevi Saxonici* (1839-1848); W. G. Birch, *Cartularium Saxonum* (1885-1893); J. Muñoz y Rivero, *Manuel de palaeografia diplomatia Española* (1890); M. Russi, *Paleografia e diplomatia de documenti delle provincie Napolitane* (1883). Facsimiles are given in J. B. Silvestre, *Palaeographie universelle* (English edition, 1850); and in the *Facsimiles, &c.*, published by the Palaeographical Society (1873-1894) and the New Palaeographical Society (1903, &c.); and also in the following works:—A. Champollion-Figeac, *Chartes et manuscrits sur papyrus* (1840); J. A. Letronne, *Diplômes et chartes de l'époque mérovingienne* (1845-1866); J. Tardif, *Archives de l'Empire: Facsimilé de chartes et diplômes mérovingiens et carlovingiens* (1866); G. H. Pertz, *Schriftförm zum Gebrauch bei diplomatischen Vorlesungen* (1844-1869); H. von Sybel and T. Sichel, *Kaiserurkunden in Abbildungen* (1880-1891); J. von Pflugk-Hartung, *Specimina selecta chartarum Pontificum Romanorum* (1885-1887); *Specimina palaeographica restorum Romanorum pontificum* (1888); *Recueil de fac-similés à l'usage de l'École des Chartes* (not published) (1880, &c.); J. Muñoz y Rivero, *Chrestomathia palaeographica: scripturæ Hispanæ veteris specimina* (1890); E. A. Bond, *Facsimiles of Ancient Charters in the British Museum* (1873-1878); W. B. Sanders, *Facsimiles of Anglo-Saxon Manuscripts* (charters) (1878-1884); G. F. Warner and H. J. Ellis, *Facsimiles of Royal and other Charters in the British Museum* (1903). (E. M. T.)

DIPOENUS and **SCYLLIS**, early Greek sculptors, who worked together, and are said to have been pupils of Daedalus. Pliny assigns to them the date 580 B.C., and says that they worked at Sicyon, which city from their time onwards became one of the great schools of sculpture. They also made statues for Cleonæ and Argos. They worked in wood, ebony and ivory, and apparently also in marble. It is curious that no inscription bearing their names has come to light.

DIPPEL, JOHANN KONRAD (1673-1734), German theologian and alchemist, son of a Lutheran pastor, was born at the castle of Frankenstein, near Darmstadt, on the 10th of August 1673. He studied theology at Giessen. After a short visit to Wittenberg

he went to Strassburg, where he lectured on alchemy and chiro-mancy, and occasionally preached. He gained considerable popularity, but was obliged after a time to quit the city, owing to his irregular manner of living. He had up to this time espoused the cause of the orthodox as against the pietists; but in his two first works, published under the name "Christianus Democritus," *Orthodoxia Orthodoxorum* (1697) and *Papismus papulans Protestantismum* (1698), he assailed the fundamental positions of the Lutheran theology. He held that religion consisted not in dogma but exclusively in love and self-sacrifice. To avoid persecution he was compelled to wander from place to place in Germany, Holland, Denmark and Sweden. He took the degree of doctor of medicine at Leiden in 1711. He discovered Prussian blue, and by the destructive distillation of bones prepared the evil-smelling product known as Dippel's animal oil. He died near Berleburg on the 25th of April 1734.

An enlarged edition of Dippel's collected works was published at Berleburg in 1743. See the biographies by J. C. G. Ackermann (Leipzig, 1781), H. V. Hoffmann (Darmstadt, 1783), K. Henning (1881) and W. Bender (Bonn, 1882); also a memoir by K. Bucher in the *Historisches Taschenbuch* for 1858.

DIPSOMANIA (from Gr. *dipsa*, thirst, and *mania*, madness), a term formerly applied to the attacks of delirium (*q.v.*) caused by alcoholic poisoning. It is now sometimes loosely used as equivalent to the condition of incurable inebriates, but strictly should be confined to the pathological and insatiable desire for alcohol, sometimes occurring in paroxysms.

DIPTERA (*dis*, double, *πτερά*, wings), a term (first employed in its modern sense by Linnaeus, *Fauna Suecica*, 1st ed., 1746, p. 306) used in zoological classification for one of the Orders into which the Hexapoda, or Insecta, are divided. The relation of the Diptera (two-winged flies, or flies proper) to the other Orders is dealt with under *Hexapoda* (*q.v.*).

The chief characteristic of the Diptera is expressed in the name of the Order, since, with the exception of certain aberrant and apterous forms, flies possess but a single pair of membranous wings, which are attached to the meso-thorax. Wing-covers and hind-wings are alike absent, and the latter are represented by a pair of little knobbed organs, the halteres or balancers, which have a controlling and directing function in flight. The other structural characters of the Order may be briefly summarized as:—mouth-parts adapted for piercing and sucking, or for suction alone, and consisting of a proboscis formed of the labium, and enclosing modifications of the other usual parts of the mouth, some of which, however, may be wanting; a thorax fused into a single mass; and legs with five-jointed tarsi. The wings, which are not capable of being folded, are usually transparent, but occasionally pigmented and adorned with coloured spots, blotches or bands; the wing-membrane, though sometimes clothed with minute hairs, seldom bears scales; the wing-veins, which are of great importance in the classification of Diptera, are usually few in number and chiefly longitudinal, there being a marked paucity of cross-veins. In a large number of Diptera an incision in the posterior margin of the wing, near the base, marks off a small lobe, the posterior lobe or alula, while connected with this but situated on the thorax itself there is a pair of membranous scales, or squamae, which when present serve to conceal the halteres. The antennae of Diptera, which are also extremely important in classification, are thread-like in the more primitive families, such as the *Tipulidae* (daddy-long-legs), where they consist of a considerable number of joints, all of which except the first two, and sometimes also the last two, are similar in shape; in the more specialized families, such as the *Tabanidae* (horse-flies), *Syrphidae* (hover-flies) or *Muscidae* (house-flies, blue-bottles and their allies), the number of antennal joints is greatly reduced by coalescence, so that the antennae appear to consist of only three joints. In these forms, however, the third joint is really a complex, which in many families bears in addition a jointed bristle (arista) or style, representing the terminal joints of the primitive antenna. Although in the case of the majority of Diptera the body is more or less clothed with hair, the hairy covering is usually so short that to the unaided eye the insects appear almost bare; some forms, however, such as the bee-flies

(*Bombylii*), and certain robber-flies (*Asilidae*) are conspicuously hairy. Bristles are usually present on the legs, and in the case of many families on the body also; those on the head and thorax are of great importance in classification.

Between 40,000 and 50,000 species of Diptera are at present known, but these are only a fraction of those actually in existence. The species recognized as British number some 2700, but to this total additions are constantly being made. As a rule flies are of small or moderate size, and many, such as certain blood-sucking midges of the genus *Ceratopogon*, are even minute; as extremes of size may be mentioned a common British midge, *Ceratopogon varius*, the female of which measures only $1\frac{1}{2}$ millimetre, and the gigantic *Mydaidae* of Central and South America as well as certain Australian robber-flies, which have a body $1\frac{1}{2}$ in. long, with a wing-expanse of $3\frac{1}{2}$ in. In bodily form Diptera present two main types, either, as in the case of the more primitive and generalized families, they are gnat- or midge-like in shape, with slender bodies and long, delicate legs, or else they exhibit a more or less distinct resemblance to the common house-fly, having compact and stoutly built bodies and legs of moderate length. Diptera in general are not remarkable for brilliancy of coloration; as a rule they are dull and inconspicuous in hue, the prevailing body-tints being browns and greys; occasionally, however, more especially in species (*Syrphidae*) that mimic Hymenoptera, the body is conspicuously banded with yellow; a few are metallic, such as the species of *Formosia*, found in the islands of the East Indian Archipelago, which are among the most brilliant of all insects. The sexes in Diptera are usually alike, though in a number of families with short antennae the males are distinguished by the fact that their eyes meet together (or nearly so) on the forehead. Metamorphosis in Diptera is complete; the larvae are utterly different from the perfect insects in appearance, and, although varying greatly in outward form, are usually footless grubs; those of the *Muscidae* are generally known as maggots. The pupa either shows the appendages of the perfect insect, though these are encased in a sheath and adherent to the body, or else it is entirely concealed within the hardened and contracted larval integument, which forms a barrel-shaped protecting capsule or puparium.

Diptera are divided into some sixty families, the exact classification of which has not yet been finally settled. The majority of authors, however, follow Brauer in dividing the order into two sections, Orthorrhapha and Cyclorrhapha, according to the manner in which the pupa-case splits to admit of the escape of the perfect insect. The general characteristics of the pupae in these two sections have already been described.

In the Orthorrhapha, in the pupae of which the appendages of the perfect insect are usually visible, the pupa-case generally splits in a straight line down the back near the cephalic end; in front of this longitudinal cleft there may be a small transverse one, the two together forming a T-shaped fissure. In the Cyclorrhapha on the other hand, in which the actual pupa is concealed within the hardened larval skin, the imago escapes through a circular orifice formed by pushing off or through the head end of the puparium. The Diptera Orthorrhapha include the more primitive and less specialized families such as the *Tipulidae* (daddy-long-legs), *Culicidae* (gnats or mosquitoes), *Chironomidae* (midges), *Mycetophilidae* (fungus-midges), *Tabanidae* (horse-flies), *Asilidae* (robber-flies), &c. The Diptera Cyclorrhapha on the other hand consist of the most highly specialized families, such as the *Syrphidae* (hover-flies), *Oestridae* (bot and warble flies), and *Muscidae* (*sensu lato*)—the house-fly and its allies, including tsetse-flies, flesh-flies, *Tachinidae*, or flies the larvae of which are internal parasites of caterpillars, &c.). It is customary to divide the Orthorrhapha into the two divisions Nematocera and Brachycera, in the former of which the antennae are elongate and in a more or less primitive condition, as described above, while in the latter these organs are short, and, as already explained, apparently composed of only three joints.

Within the divisions named—Orthorrhapha Nematocera, Orthorrhapha Brachycera and Cyclorrhapha—the constituent families are usually grouped into a series of "superfamilies,"

distinguished by features of structure or habit. Certain extremely aberrant Diptera, which, in consequence of the adoption of a parasitic mode of life, have undergone great structural modification, are further remarkable for their peculiar mode of reproduction, on account of which the families composing the group are often termed Pupipara. In these forms the pregnant female, instead of laying eggs, as Diptera usually do, or even producing a number of minute living larvae, gives birth at one time but to a single larva, which is retained within the oviduct of the mother until adult, and assumes the pupal state immediately on extrusion. The Pupipara are also termed Eproboscidea (although they actually possess a well-developed and functional proboscis), and by some dipterists the Eproboscidea are regarded as a suborder and contrasted as such with the rest of the Diptera, which are styled the suborder Proboscidea. By other writers Proboscidea and Eproboscidea are treated as primary divisions of the Cyclorrhapha. In reality, however, the families designated Eproboscidea (*Hippoboscidae*, *Bruidae*, *Nycteribiidae* and *Streblidae*), are not entitled to be considered as constituting either a suborder, or even a main division of the Cyclorrhapha; they are simply Cyclorrhapha much modified owing to parasitism, and in view of the closely similar mode of reproduction in the tsetse-flies the special designation Pupipara should be abandoned. Before leaving the subject of classification it may be noted in passing that in 1906 Professor Lameere, of Brussels, proposed a scheme for the classification of Diptera which as regards both the limits of the families and their grouping into higher categories differs considerably from that in current use.

Little light on the relationship and evolution of the various families of Diptera is afforded by fossil forms, since as a rule the latter are readily referable to existing families. With the exception of a few species from the Solenhofen lithographic Oolite, fossil Diptera belong to the Tertiary Period, during which the members of this order attained a high degree of development. In amber, as proved by the deposits on the shores of the Baltic, the proverbial "fly" is more numerous than any other creatures, and with very few exceptions representatives of all the existing families have been found. The famous Tertiary beds at Florissant, Colorado, have yielded a considerable number or remarkably well-preserved *Tipulidae* (in which family are included the most primitive of existing Diptera), as also species belonging to other families, such as *Mycetophilidae* and even *Oestridae*.

Diptera as an order are probably more widely distributed over the earth's surface than are the representatives of any similar division of the animal kingdom. Flies seem capable of adapting themselves to extremes of cold equally as well as to those of heat, and species belonging to the order are almost invariably included in the collections brought back by members of Arctic expeditions. Others are met with in the most isolated localities; thus the Rev. A. E. Eaton discovered on the desolate shores of Kerguelen's Island apterous and semi-apterous Diptera (*Tipulidae* and *Ephydriidae*) of a degraded type adapted to the climatic peculiarities of the locality. Many bird parasites belonging to the *Hippoboscidae* have naturally been carried about the world by their hosts, while other species, such as the house-fly, blow-fly and drone-fly, have in like manner been disseminated by human agency. Most families and a large proportion of genera are represented throughout the world, but in some cases (e.g. *Glossina*—see TSETSE-FLY) the distribution of a genus is limited to a continent. As a rule the general *facies* as well as dimensions are remarkably uniform throughout a family, so that tropical species often differ little in appearance from those inhabiting temperate regions. Many instances of exaggerated and apparently unnatural structure nevertheless occur, as in the case of the genera *Pangonia*, *Nemestrina*, *Achias*, *Diopsis* and the family *Celyphidae*, and, as might be expected, it is chiefly in tropical species that these peculiarities are found. To a geographical distribution of the widest extent, Diptera add a range of habits of the most diversified nature; they are both animal and vegetable feeders, an enormous number of species acting, especially in the larval state, as scavengers in consuming putrescent or decomposing

matter of both kinds. The phytophagous species are attached to various parts of plants, dead or alive; and the carnivorous in like manner feed on dead or living flesh, or its products, many larvae being parasitic on living animals of various classes (in Australia the larva of a species of *Muscidae* is even a parasite of frogs), especially the caterpillars of Lepidoptera, which are destroyed in great numbers by *Tachininae*. The recent discovery of a blood-sucking maggot, which is found in native huts throughout the greater part of tropical and subtropical Africa, and attacks the inmates when asleep, is of great interest.

It may confidently be asserted that, of insects which directly or indirectly affect the welfare of man, Diptera form the vast majority, and it is a moot point whether the good effected by many species in the rapid clearing away of animal and vegetable impurities, and in keeping other insect enemies in check, counterbalances the evil and annoyance wrought by a large section of the Order. The part played by certain blood-sucking Diptera in the dissemination of disease is now well known (see MOSQUITO and TSETSE-FLY), and under the term *myiasis* medical literature includes a lengthy recital of instances of the presence of Dipterous larvae in various parts of the living human body, and the injuries caused thereby. That Diptera of the type of the common house-fly are often in large measure responsible for the spread of such diseases as cholera and enteric fever is undeniable, and as regards blood-sucking forms, in addition to those to which reference has already been made, it is sufficient to mention the vast army of pests constituted by the midges, sand-flies, horse-flies, &c., from the attacks of which domestic animals suffer equally with man, in addition to being frequently infested with the larvae of the bot and warble flies (*Gastrophilus*, *Oestrus* and *Hypoderma*). Lastly, as regards the phytophagous forms, there can be no doubt that the destruction of grass-lands by "leather-jackets" (the larvae of crane-flies, or daddy-long-legs,—*Tipula oleracea* and *T. paludosa*), of divers fruits by *Ceratitis capitata* and species of *Dacus*, and of wheat and other crops by the Hessian-fly (*Mayetiola destructor*) and species of *Oscinis*, *Chlorops*, &c., is of very serious consequence.

With many writers it is customary to treat the fleas as a suborder of Diptera, under the title Aphaniptera or Siphonaptera. Since, however, although undoubtedly allied to the Diptera, they must have diverged from the ancestral stem at an early period, before the existing forms of Diptera became so extremely specialized, it seems better to regard the fleas as constituting an independent order (see FLA). (E. E. A.)

DIPTERAL (Gr. for "double-winged"), the architectural term applied to those temples which have a double range of columns in the peristyle, as in the temple of Diana at Ephesus.

DIPTYCH (Gr. *διπτυχος*, two-folding), (1) A tablet made with a hinge to open and shut, used in the Roman empire for letters (especially love-letters), and official tokens of the commencement of a consul's, praetor's or aedile's term of office. The latter variety of diptych was inscribed with the magistrate's name and bore his portrait, and was issued to his friends and the public generally. They were made of boxwood or maple. More costly examples were in cedar, ivory (*q.v.*), silver or sometimes gold. They were often sent as New Year gifts.

(2) In the primitive church when the worshippers brought their own offerings of bread and wine, from which were taken the Communion elements, the names of the contributors were recorded on diptychs and read aloud. To these names were early added those of deceased members of the community whom it was desired to commemorate. This custom rapidly developed into a kind of commemoration of saints and benefactors, living and dead; especially, in each church, were the names of those who had been its bishops recorded. The custom was maintained until the lists became so long that it was impossible to read them through, and the observance in this form had to be abandoned. The insertion of a name on the diptych, thereby securing the prayers of the church, was a privilege from which a person could be excluded on account of suspicion of heresy or by the intrigues of enemies. His name could, if written, be expunged under similar circumstances. The names thus written were read from

the ambo, in which the diptych was kept. The reading of these names during the canon of the mass gave rise to the term *canonization*. By various councils it was ordained that the name of the pope should always be inserted in the diptych list.

The addition of *dates* resulted from the custom of recording baptisms and deaths; and thus the diptych developed into a calendar and formed the germ of the elaborate system of *festologies*, *martirologies* and *calendars* which developed in the church.

The diptych went by various names in the early church—mystical tablets, anniversary books, ecclesiastical matriculation registers or books of the living. According to the names inscribed, bishops, the dead or the living, a diptych might be a *diptycha episcoporum*, *diptycha mortuorum* or *diptycha vivorum*.

In course of time the list of the names swelled to such proportions that the space afforded by the diptych was insufficient. A third fold was consequently provided, and the tablet became a *triptych* (though the name *diptych* was retained as a general term for the object). Further room was afforded by the insertion of leaves of parchment or wood between the folds. The custom of reading names from the diptychs died out about the 8th century. The diptychs, however, were retained as altar ornaments. From the original consular documents onwards, the outsides of the folds had always been richly ornamented, and when they ceased to be of immediate practical use they became merely decorative. Instead of the list of names the inside was ornamented like the outer, and in the middle ages the best painters of the day would often paint them. When folded, the portraits of the donor and his wife might be shown; when open there would be three paintings, one on each fold, of a religious character. (R. A. S. M.)

DIR, an independent state in the North-West Frontier Province of India, lying to the north-east of Swat. Its importance chiefly arises from the fact that it commands the greater part of the route between Chitral and the Peshawar frontier. The quarrels and intrigues between the khan of Dir and Umra Khan of Jandol were among the chief events that led up to the Chitral Campaign of 1895. During that expedition the khan made an agreement with the British Government to keep the road to Chitral open in return for a subsidy. Including the Bashkars, an aboriginal tribe allied to the Torwals and Garhuis, who inhabit Panjkora Kohistan, the population is estimated at about 100,000.

DIRCE, in Greek legend, daughter of Helios the sun-god, the second wife of Lycus, king of Thebes. She sorely persecuted Antiope, his first wife, who escaped to Mount Cithaeron, where her twin sons Amphion and Zethus were being brought up by a herdsman who was ignorant of their parentage. Having recognized their mother, the sons avenged her by tying Dirce to the horns of a wild bull, which dragged her about till she died. Her body was cast into a spring near Thebes, which was ever afterwards called by her name. Her punishment is the subject of the famous group called "The Farnese Bull," by Apollonius and Tauriscus of Tralles, in the Naples museum (see GREEK ART, Plate I. fig. 51).

DIRECT MOTION, in astronomy, the apparent motion of a body of the solar system on the celestial sphere in the direction from west to east; so called because this is the usual direction of revolution and rotation of the heavenly bodies.

DIRECTORS, in company law, the agents by whom a trading or public company acts, the company itself being a legal abstraction and unable to do anything. As joint-stock companies have multiplied and their enterprise has extended, the position of directors has become one of increasing influence and importance. It is they who control the colossal funds now invested in trading companies, and who direct their policy (for shareholders are seldom more than dividend-drawers). Upon their uprightness, vigilance and sound judgment depends the welfare of the greater part of the trade of the country concerned. It is not to be wondered at that in view of this influence and independence of action the law courts have held directors to a strict standard of duty, and that the parliament of the United Kingdom has singled out directors from other agents for special legislation in

the Directors Liability Act 1890, the Larceny Act 1861, the Companies Act 1867 and the Winding-up Act 1890.

The first directors of a company are generally appointed by the articles of association. Their consent to act must now, under the Companies Act 1908, be filed with the registrar of joint-stock companies. Directors other than the first are elected at the annual general meeting, a certain proportion of the acting directors—usually one-third—retiring under the articles by rotation each year, and their places being filled up by election. A share qualification is nearly always required, on the well-recognized principle that a substantial stake in the undertaking is the best guarantee of fidelity to the company's interests. A director once appointed cannot be removed during his term of office by the shareholders, unless there is a special provision for that purpose in the articles of association; but a company may dismiss a director if the articles—as is usually the case—authorize dismissal. The authority and powers of directors are *prima facie* those necessary for carrying on the ordinary business of the company, but it is usual to define the more important of such powers in the articles of association. For instance, it is commonly prescribed how and when the directors may make calls, to what amount they may borrow, how they may invest the funds of the company, in what circumstances they may forfeit shares, or veto transfers, in what manner they shall conduct their proceedings, and what shall constitute a quorum of the board. Whenever, indeed, specific directions are desirable they may properly be given by the articles. But superadded to and supplementing these specific powers there is usually inserted in the articles a general power of management in terms similar to those of clause 55 of the model regulations for a company, known as Table A (clause 71 of the revised Table). The powers, whether general or specific, thus confided to directors are in the nature of a trust, and the directors must exercise them with a single eye to the benefit of the company. For instance, in allotting shares they must consult the interests of the company, not favour their friends. So in forfeiting shares they must not use the power collusively for the purpose of relieving the shareholder from liability. To do so is an abuse of the power and a fraud on the other shareholders.

It would give a very erroneous idea of the position and functions of directors to speak of them—as is sometimes done—as trustees. They are only trustees in the sense that every agent is. They are "commercial men managing a trading concern for the benefit of themselves and the other shareholders." They have to carry on the company's business, to extend and consolidate it, and to do this they must have a free hand and a large discretion to deal with the exigencies of the commercial situation. This large discretion the law allows them so long as they keep within the limits set by the company's memorandum and articles. They are not to be held liable for mere errors of judgment, still less for being defrauded. That would make their position intolerable. All that the law requires of them is that they should be faithful to their duties as agents—"diligent and honest," to use the words of Sir George Jessel, formerly master of the rolls. Thus in the matter of diligence it is a director's duty to attend as far as possible all meetings of the board; at the same time non-attendance, unless gross, will not amount to negligence such as to render a director liable for irregularities committed by his co-directors in his absence. A director again must not sign cheques without informing himself of the purpose for which they are given. A director, on the same principle, must not delegate his duties to others unless expressly authorized to do so, as where the company's articles empower the directors to appoint a committee. Directors may, it is true, employ skilled persons, such as engineers, valuers or accountants, to assist them, but they must still exercise their judgment as business men on the materials before them. Then in the matter of honesty, a director must not accept a present in cash or shares or in any other form whatever from the company's vendor, because such a present is neither more nor less than a bribe to betray the interests of the company, nor must he make any profit in the matter of his agency without the knowledge and consent of his principal, the company. He must not, in other words, put himself in a position in which his duty to the company

and his own interest conflict or even may conflict. This rule often comes into play in the case of contracts between a company and a director. There is nothing in itself invalid in such a contract, but the onus is on the director if he would keep such a contract to show that the company assented to his making a profit out of the contract, and for that purpose he must show that he made full and fair disclosure to the company of the nature and extent of his interest under the contract. It is for this reason that when a company's vendor is also a director he does not join the board until his co-directors have exercised an independent judgment on the propriety of the purchase.

A director must also bear in mind—what is a fundamental principle of company management—that the funds of the company are entrusted to the directors for the objects of the company as defined by the company's memorandum of association and authorized by the general law, and that they must not be diverted from those objects or applied to purposes which are outside the objects of the company, *ultra vires*, as it is commonly called, or outside the powers of management given by the shareholders to the directors. This does not abridge the large discretion allowed to directors in carrying on the business of the company. The funds embarked in a trading company are intended to be employed for the acquisition of gain, and risk, greater or less according to circumstances, is necessarily incidental to such employment; but it is quite another matter when directors pay dividends out of capital, or return capital to the shareholders, or spend money of the company in "rigging" the market, or in buying the company's shares or paying commission for underwriting the shares of the company except where such commission is authorized under acts of 1900 and 1907, incorporated in the Companies Act 1908. Directors who in these or any other ways misapply the funds of the company are guilty of what is technically known as "misfeasance" or breach of trust, and all who join in the misapplication are jointly and severally liable to replace the sums so misapplied. The remedy of the company for misfeasance, if the company is a going concern, is by action against the delinquent directors; but where a company is being wound up, the legislature has, under the Winding-up Act 1890, provided a summary mode of proceeding, by which the official receiver or liquidator, or any creditor or contributory of the company, may take out what is known as a misfeasance summons, to compel the delinquent director or officer to repay the misapplied moneys or make compensation. The departmental committee of the Board of Trade in its report (July 1906) recommended that the court should be given a discretionary power, analogous to that it already possesses in the case of trustees under the Judicial Trustees Act 1896, s. 3, to relieve a director (or a promoter) in certain cases from liability. This recommendation has been given effect to by s. 279 of the Companies Act 1908, which provides that, "If in any proceeding against a director of a company for negligence or breach of trust it appears to a court that the director is or may be liable in respect of the negligence or breach of trust, but has acted honestly and reasonably and ought fairly to be excused for the negligence or breach of trust, the court may relieve him either wholly or partly from his liability on such terms as the court may think proper."

Directors who circulate a prospectus containing statements which they know to be false, with intent to induce any person to become a shareholder, may be prosecuted under § 84 of the Larceny Act 1861. They are also liable criminally for falsification of the company's books, and for this or any other criminal offence the court in winding up may, on the application of the liquidator, direct a prosecution. As to the liability of directors for statements or omissions in a prospectus see COMPANY.

In managing the affairs of the company directors must meet together and act as a body, for the company is entitled to their collective wisdom in council assembled. Board meetings are held at such intervals as the directors think expedient. Notice of the meeting must be given to all directors who are within reach, but the notice need not specify the particular business to be transacted. The articles usually fix, or give the directors power to fix,

what number shall constitute a quorum for a board meeting. They also empower the directors to elect a chairman of the board. The directors exercise their powers by a resolution of the board which is recorded in the directors' minute-book.

The court will not as a rule interfere with the discretion of directors honestly exercised in the management of the affairs of the company. The directors have *prima facie* the confidence of the shareholders, and it is not for the court to say that such confidence is misplaced. If the shareholders are dissatisfied with the management the remedy is in their own hands—they can call a meeting and elect a new board.

A company's articles usually provide for the payment of a certain sum to each director for his services during the year. When this is the case it is an authority to the directors to pay themselves the amount of such remuneration. The remuneration, unless otherwise expressly provided, covers all expenses incidental to the directors' duties. A director, for instance, cannot claim to be paid in addition to his fixed remuneration his travelling expenses for attending board meetings.

When a company winds up, the directors' powers of management come to an end. Their agency is superseded in favour of that of the liquidator. (E. M. A.)

DIRECTORY, a term meaning literally that which guides or directs, and so applied to a book or set of rules giving directions for public worship. The *Directorium* or *ordo* of the Roman Church contains regulations as to the Mass and office to be used on each day throughout the year, and the word is found in the *Directory for the Publick Worship of God* drawn up in 1644 at the Westminster Assembly. The term now usually signifies a book containing the names, addresses and occupations, &c. of the inhabitants of a town or district, or of a similar list of the users of a telephone supply, or of the members of a particular profession or trade. The name *Directoire* or Directory was given to the body which held the executive power in France from October 1795 until November 1799 (see FRENCH REVOLUTION).

DIRGE, a song or hymn of mourning, particularly one sung at funerals or at a service in commemoration of the dead. It is derived from the first word of the antiphon "*Dirige, Domine, Deus meus, in conspectu tuo viam meam*" (Guide, O Lord, my God, my way in Thy sight), of the opening psalm in the office for the dead in the Roman Church. The antiphon is adapted from verse 8 of Psalm v.

DIRK, a dagger, particularly the heavy dagger carried by the Highlanders of Scotland. The dirk as worn in full Highland costume is an elaborately ornamented weapon, with cairngorms or other stones set in the head of the handle, which has no guard. Inserted in the sheath there may be two small knives. The dirk, in the shape of a straight blade, with a small guard, some 18 in. long, is worn by midshipmen in the British navy. The origin of the word is doubtful. The earlier forms were *dark* and *durk*, and the spelling *dirk*, adopted by Johnson, represents the pronunciation of the second form. The name seems to have been early applied to the daggers of the Highlanders, but the Gaelic word is *biodag*, and the Irish *duirc*, often stated to be the origin, is only an adaptation of the English word. It may be a corruption of the German *Dolch*, a dagger. The suggestion that it is an application of the Christian name "Dirk," the short form of "Dieterich," is not borne out, according to the *New English Dictionary*, by any use of this name for a dagger, and is further disproved by the earlier English spelling.

DIRSCHAU, a town of Germany, in the kingdom of Prussia, province of West Prussia, on the left bank of the Vistula, 20 m. S. from Danzig and at the junction of the important lines of railway Berlin-Königsberg and Danzig-Bromberg. Pop. (1905) 14,185. It has a Roman Catholic and a Protestant church and several schools. The river is here crossed by two fine iron bridges. The older structure dating from the year 1857, originally used for the railway, is now given up to road traffic, and the railway carried by a new bridge completed in 1891. Dirschau has railway workshops and manufactories of sugar, agricultural implements and cement. During the war with Poland, Gustavus Adolphus made it his headquarters for many months after its capture in 1626.

DISABILITY, a term meaning, in general, want of ability, and used in law to denote an incapacity in certain persons or classes of persons for the full enjoyment of duties or privileges, which, but for their disqualification, would be open to them; hence, legal disqualification. Thus, married women, persons under age, insane persons, convicted felons are under disability to do certain legal acts. This disability may be absolute, wholly disabling the person so long as it continues, or partial, ceasing on discontinuation of the disabling state, as attainment of full age.

DISCHARGE (adapted from the O. Fr. *decharge*, modern *décharge* from a med. Lat. *discargere*, to unload, *dis-* and *caricare*, to load, cf. "charge"), a word meaning relief from a load or burden, hence applied to the unloading of a ship, the firing of a weapon, the passage of electricity from an electrified body, the issue from a wound, &c. From the sense of relief from an obligation, "discharge" is also applied to the release of a soldier or sailor from military or naval service, or of the crew of a merchant vessel, or to the dismissal from an office or situation. In law, it is used of a document or other evidence that can be accepted as proof of the release from an obligation, as of a receipt, on payment of money due. Similarly it is applied to the release in accordance with law of a person in custody on a criminal charge, and to the legal release of a bankrupt from further liability for debts provable in the bankruptcy except those incurred by fraud or debts to the crown. It is also applied to the reversal of an order of a court. In the case of divorce, where the rule *nisi* is not made absolute, the rule is said to be discharged.

DISCHARGING ARCH, in architecture, an arch built over a lintel or architrave to take off the superincumbent weight. The earliest example is found in the Great Pyramid, over the lintels of the entrance passage to the tomb; it consisted of two stones only, resting one against the other. The same object was attained in the Lion Gate and the tomb of Agamemnon, both in Mycenae, and in other examples in Greece, where the stones laid in horizontal courses, one projecting over the other, left a triangular hollow space above the lintel of the door, which was subsequently filled in by vertical sculptured stone panels. The Romans frequently employed the discharging arch, and inside the portico of the Pantheon the architraves have such arches over them. In the Golden Gateway of the palace of Diocletian at Spalato the discharging arches, semicircular in form, were adopted as architectural features and decorated with mouldings. The same is found in the synagogues in Palestine of the 2nd century; and later, in Byzantine architecture, these moulded archivolts above an architrave constitute one of the characteristics of the style. In the early Christian churches in Rome, where a colonnade divided off the nave and aisles, discharging arches are turned in the frieze just above the architraves.

DISCIPLE, properly a pupil, scholar (Lat. *discipulus*, from *discere*, to learn, and root seen in *pupillus*), but chiefly used of the personal followers of Jesus Christ, including the inner circle of the Apostles (q.v.).

DISCIPLES OF CHRIST, or **CHRISTIANS**, an American Protestant denomination, founded by Thomas Campbell, his son Alexander Campbell (q.v.) and Barton Warren Stone (1772-1844). Stone had been a Presbyterian minister prominent in the Kentucky revival of 1801, but had been turned against sectarianism and ecclesiastical authority because the synod had condemned Richard McNemar, one of his colleagues in the revival, for preaching (as Stone himself had done) counter to the Westminster Confession, on faith and the work of the Holy Spirit in conversion. He had organized the Springfield Presbytery, but in 1804 with his five fellow ministers signed "The Last Will and Testament of the Springfield Presbytery," giving up that name and calling themselves "Christians." Like Stone, Alexander Campbell had adopted (in 1812) immersion, and, like him, his two great desires were for Christian unity and the restoration of the ancient order of things. But the Campbellite doctrines differed widely from the hyper-Calvinism of the Baptists whom they had joined in 1813, especially on the points on which Stone had quarrelled with the Presbyterians; and after various local breaks in 1825-1830, when there were large additions to the Restorationists from

the Baptist ranks, especially under the apostolic fervour and simplicity of the preaching of Walter Scott (1796-1861), in 1832 the Reformers were practically all ruled out of the Baptist communion. The Campbellites gradually lost sight of Christian unity, owing to the unfortunate experience with the Baptists and to the tone taken by those clergymen who had met them in debates; and for the sake of Christian union it was peculiarly fortunate that in January 1832 at Lexington, Kentucky, the followers of the Campbellites and those of Stone (who had stressed union more than primitive Christianity) united. Campbell objected to the name "Christians" as sectarianized by Stone, but "Disciples" never drove out of use the name "Christians."

During the Civil War the denomination escaped an actual scission by following the neutral views of Campbell, who opposed slavery, war and abolition. In 1849 the American Christian Missionary Society was formed; it was immediately attacked as a "human innovation," unwarranted by the New Testament, by literalists led in later years by Benjamin Franklin (secretary of the missionary society in 1857), who opposed all church music also. Isaac Errett (1820-1888) was the most prominent leader of the progressive party, which was considered corrupt and worldly by the literalists, many of whom, in spite of his efforts, broke off from the main body, especially in Indiana, Kentucky, Tennessee, Arkansas and Texas.

The main body appointed in 1890 a standing committee on Christian union; their aim in this respect is not for absorption, as was clearly shown by their answer in 1887 to overtures from the Protestant Episcopal Church regarding Christian unity. The credal position of the Disciples is simple: great stress is put upon the phrase "the Christ, the Son of the living God," and upon the recognition by Jesus of this confession as the foundation of His church; as to baptism, agreement with Baptists is only as to the mode, immersion; this is considered "the primitive confession of Christ and a gracious token of salvation," and as being "for the remission of sins"; the Disciples generally deny the authority over Christians of the Old Covenant, and Alexander Campbell in particular held this view so forcibly that he was accused by Baptists of "throwing away the Old Testament." The Lord's Supper is celebrated every Sunday, the bread being broken by the communicants. The Disciples are not Unitarian in fact or tendency, but they urge the use of simple New Testament phraseology as to the Godhead. Their church government is congregational.

The growth of the denomination has been greatest in the states along the Ohio river, whence they have spread throughout the Union. In 1908 there were 6673 ministers and 1,285,123 communicants in the United States. There are churches in Canada, in Great Britain and in Australia. Bethany College, at Bethany, West Virginia, was chartered in 1840, and Alexander Campbell, who had founded it as Buffalo Seminary, was its president until his death in 1866; other colleges founded by the sect are: Kentucky University, Lexington, Ky.; Hiram College, Hiram, Ohio (1850, until 1867 known as Western Reserve Eclectic Institute); Butler College, Indianapolis, Indiana (1855); Christian University, Canton, Missouri (1851, coeducational); Eureka College, in Woodford county, Illinois (1855; coeducational); Union Christian College, Merom, Ind. (1859); Texas Christian University, Waco, Texas (1873, founded as Add Ran College at Thorpe's Springs, removing to Waco in 1895); Drake University, Des Moines, Iowa (1881); Milligan College, Milligan, Tennessee (1882); Defiance College, Defiance, O. (1885); Cotner University, Lincoln, Nebraska (1889); Elon College, Elon, North Carolina (1890); American University, Harriman, Tenn. (1893); the Virginia Christian College, Lynchburg, Virginia (1903), and for negroes, the Southern Christian Institute, Edwards, Mississippi (1877), and the Christian Bible College, Newcastle, Henry County, Ky. Theological seminaries are the Berkeley Bible Seminary, Berkeley, California (1896); the Disciples' Divinity House, Chicago, Ill. (1894); and the Eugene Divinity School, Eugene, Oregon (1895). Bible chairs were established in state universities and elsewhere by the Disciples,—at the University of Michigan (1893), at the University of Virginia (1899), at the University of Calcutta (1900) and at the University of Kansas (1901). The denomination has publishing houses in Cincinnati, St. Louis, Louisville and Nashville.

See Errett Gates's *History of the Disciples of Christ* (New York, 1905), in "The Story of the Churches" series, and his *Early Relation and Separation of Baptists and Disciples* (Chicago, 1904), a University of Chicago doctoral thesis; and B. B. Tyler's *History of the Disciples of Christ* in vol. xii. of "The American Church History Series" (New York, 1894).

DISCLAIMER, a renunciation, denial or refusal; a disavowal of claims. In law the term is used more particularly in the following senses:—(1) In the law of landlord and tenant, the direct repudiation of that relation by some act on the part of the tenant. A disclaimer may be verbal or written, but in such case it must be something more than a mere renunciation of the tenant's title, or it may be an act which is wholly inconsistent with the existence of such relation, as the setting up by the tenant of a distinct title either in himself or some third party. (2) In the law of bankruptcy, where any part of the property of a bankrupt consists of land of any tenure burdened with onerous covenants, of stocks or shares in companies, of unprofitable contracts, or of any property that is unsaleable, or not readily saleable, by reason of its binding the possessor to the performance of any onerous act, the trustee, notwithstanding that he has endeavoured to sell or has taken possession of the property, or exercised any act of ownership in relation to it, may, subject to certain provisions, by writing signed by him, at any time within twelve months after the first appointment of a trustee, "disclaim" the property (see **BANKRUPTCY**). (3) In the law of trusts, disclaimer is the refusal or renunciation of the office or duties of a trustee. It is an undisputed rule that no one is compellable to undertake a trust, so that as soon as a person knows he has been appointed a trustee under some instrument, he should determine whether he will accept the office or not. Disclaimer of trust should be by deed, as admitting of no ambiguity, but it may be by conveyance to other accepting trustees, or orally, or by written declaration, or even by conduct. (4) In the law of patents, disclaimer is the renunciation, by amendment of specifications, of the portion of an inventor's claim to protection.

DISCOUNT. (1) A money-market term for the price paid in order to obtain immediate realization of a bill not yet due. If a bill for £100 due six months hence is discounted at the rate of 3% per annum, its holder will obtain £98, 10s. in cash for it. (2) A Stock-Exchange term applied to a security, not fully paid, which has fallen below its issue price, and so is said to stand at so much discount. See **PREMIUM**.

DISCOVERY, in law, the revealing or disclosing of any matter. The English common law courts were originally unable to compel a litigant before a trial to disclose the facts and documents on which he relied. In equity, however, a different rule prevailed, there being an absolute right to discovery of all material facts on which a case was founded. Now the practice is regulated by the Rules of the Supreme Court, 1883, Order 31. Discovery is of two kinds, namely, by interrogatories and by affidavit of documents, provision being also made for the production and inspection of documents. Where a party to a suit can make an affidavit stating that in his belief certain specified documents are or have been in the possession of some other party, the court may make an order that such party state on affidavit whether he has or ever had any of those documents in his possession, or if he has parted with them or what has become of them. A further application may then be made by notice to the party who has admitted possession of the documents for production and inspection. Copies also may be taken of the more important documents. There is also discovery of facts obtained by means of interrogatories, *s.e.* written questions addressed on behalf of one party, before trial, to the other party, who is bound to answer them in writing upon oath. In order to prevent needless expense the party seeking discovery must first secure the cost of it by paying into court a sum of money, generally not less than five pounds. See also **EVIDENCE**.

DISCUS (Gr. *δίσκος*, disk), a circular plate of stone, later of metal, which was used by the ancient Greeks for throwing to a distance as a gymnastic exercise. Judging from specimens found by excavators, the ancient discus was about 8 or 9 in. in diameter and weighed from 4 to 5 lb, although one of bronze, preserved in the British Museum, weighs over 8 lb. Sometimes a kind of quoit, spherical in form, was used, through a hole in which a thong was passed to assist the athlete in throwing it. The sport of throwing the discus was common in the time of Homer, who mentions it repeatedly. It formed a part of the *pentathlon*, or quintuple games, in the ancient Olympic Games. Statius, in *Thebais*, 646-721, fully describes the use of the discus. In the

British Museum there is a restored copy of a statue by Myron (see **GREEK ART**, Plate IV. fig. 68) of a discus-thrower (*discobolus*) in the act of hurling the missile; but the investigations of N. E. Norman Gardiner show that a wrong attitude has been adopted by the restorer.

Throwing the discus was introduced as an event in modern athletics at the revived Olympic Games, first held at Athens in 1896, and since that time it has become a recognized event in the athletic championship meetings of several European nations, as well as in the United States, where it has become very popular. According to the American rules the discus must be of a smooth, hard-wood body without finger-holes, weighted in the centre with lead disks and capped with polished brass disks, with a steel ring on the outside. Its weight must be 4½ lb, its outside diameter 8 in. and its thickness at the centre 2 in. It must be thrown from a 7-ft. circle, which may not be overstepped in throwing, and the throw is measured from the spot where the discus first strikes the ground to the point in the circumference of the circle on a line between the centre and the point of striking.

DISINFECTANTS, substances employed to neutralize the action of pathogenic organisms, and prevent the spread of contagious or infectious disease. The efficiency of any disinfectant is due to its power of destroying, or of rendering inert, specific poisons or disease germs. Therefore antiseptic substances generally are to this extent disinfectants. So also the deodorizers, which act by oxidizing or otherwise changing the chemical constitution of volatile substances disseminated in the air, or which prevent noxious exhalations from organic substances, are in virtue of these properties effective disinfectants in certain diseases. A knowledge of the value of disinfectants, and the use of some of the most valuable agents, can be traced to very remote times; and much of the Levitical law of cleansing, as well as the origin of numerous heathen ceremonial practices, are clearly based on a perception of the value of disinfection. The means of disinfection, and the substances employed, are very numerous, as are the classes and conditions of disease and contagion they are designed to meet. Nature, in the oxidizing influence of freely circulating atmospheric air, in the purifying effect of water, and in the powerful deodorizing properties of common earth, has provided the most potent ever-present and acting disinfecting media. Of the artificial disinfectants employed or available three classes may be recognized:—1st, volatile or vaporizable substances, which attack impurities in the air; 2nd, chemical agents, for acting on the diseased body or on the infectious discharges therefrom; and 3rd, the physical agencies of heat and cold. In some of these cases the destruction of the contagium is effected by the formation of new chemical compounds, by oxidation, deoxidation or other reaction, and in others the conditions favourable to life are removed or life is destroyed by high temperature. Among the first class, aerial or gaseous disinfectants, formic aldehyde has of late years taken foremost place. The vapour is a powerful disinfectant and deodorant, and for the surface disinfection of rooms, fulfils all requirements when used in sufficient amount. It acts more rapidly than equal quantities of sulphurous acid, and it does not affect colours. It is non-poisonous, though irritating to the eyes and throat. With the exception of iron and steel it does not attack metals. It can be obtained in paraform tablets, and with a specially constructed spirit lamp disinfection can be carried out by any one. Twenty tablets must be employed for every 1000 cubic ft. of space. Disinfection by sulphurous acid fumes is of great antiquity, and is still in very general use; for the purpose of destroying vermin it is more powerful than formic aldehyde. Camphor and some volatile oils have also been employed as air disinfectants, but their virtues lie chiefly in masking, not destroying, noxious effluvia. In the 2nd class—non-gaseous disinfecting compounds—all the numerous antiseptic substances may be reckoned; but the substances principally employed in practice are oxidizing agents, as potassium manganates and permanganates, "Condy's fluid," and solutions of the so-called "chlorides of lime," soda and potash, with the chlorides of aluminium and zinc, soluble sulphates and sulphites, solutions of sulphurous acid, and the tar products—carbolic, creosylic and

salficylic acids. Of the physical agents heat and cold, the latter, though a powerful natural disinfectant, is not practically available by artificial means; heat is a power chiefly relied on for purifying and disinfecting clothes, bedding and textile substances generally. Different degrees of temperature are required for the destruction of the virus of various diseases; but as clothing, &c., can be exposed to a heat of about 250° Fahr. without injury, provision is made for submitting articles to nearly that temperature. For the thorough disinfection of a sick-room the employment of all three classes of disinfectants, for purifying the air, for destroying the virus at its point of origin, and for cleansing clothing, &c., may be required.

DISMAL, an adjective meaning dreary, gloomy, and so a name given to stretches of swampy land on the east coast of the United States, as the Dismal Swamp in Virginia and North Carolina. The derivation has been much discussed. In the early examples of the use the word is a substantive, especially in the expression "in the dismal," *i.e.* in the dismal time or days. Later it became adjectival, especially in combination with "days." It has been connected with "decimal," med. Latin *decimalis*, belonging to a title or tenth, and thus the "dismal days" are the unpleasant days connected with the extortion and oppression of exacting payment of tithes. According to the *New English Dictionary*, quoting Professor W. W. Skeat, "dismal" is derived, through an Anglo-Fr. *dis mal*, from the Lat. *dies mali*, evil or unpropitious days. This Anglo-French expression, explained as *les mal jours*, is found in a MS. of Rauf de Linham's *Art de Kalender*, 1256. These days of evil omen were known as *Dies Aegyptiaci* (Du Cange, *Glossarium*, s.v.) or Egyptian days, either as having been instituted by Egyptian astrologers or with reference to the "ten plagues"; so Chaucer, "I trow hit was in the dismal, That were the ten woundes of Egipte" (*Book of the Duchesse*, 1206). There were two such days in each month.

See Skeat, *Trans. Philol. Soc.* (1888), p. 2, and note on the line in the "Book of the Duchesse," *The Complete Works of Geoffrey Chaucer*, vol. i. (1894).

DISORDERLY HOUSE, in law, a house in which the conduct of its inmates is such as to become a public nuisance, or a house where persons congregate to the probable disturbance of the public peace or other commission of crime. In England, by the Disorderly Houses Act 1751, the term includes common bawdy houses or brothels,¹ common gaming houses, common betting houses and disorderly places of entertainment. The keeping of such is a misdemeanour punishable by fine or imprisonment, and in the case of a brothel also punishable on summary conviction by the Criminal Law Amendment Act 1885; the letting out for gain for indiscriminate prostitution of a room or rooms in a house will make it as much a brothel in law as if the whole house were let out for the purpose. Where, however, a woman occupies a house or room which is frequented by men for the purpose of committing fornication with her, she cannot be convicted of keeping a disorderly house. See also PROSTITUTION.

DISPATCH, or DESPATCH, to send off immediately, or by express; particularly in the case of the sending of official messages, or of the immediate sending of troops to their destination, or the like. The word is thus used as a substantive of written official reports of events, battles and the like, sent by ambassadors, generals, &c., by means of a special messenger, or of express correspondence generally. From the primary meaning of the prompt sending of a message, &c., the word is used of the quick disposal of business, or of the disposal of a person by violence; hence the word means to execute or murder. The etymology of the word has been obscured by the connexion with the Fr. *dépecher*, and *dépêche*, which are in meaning the equivalents of

¹ The etymology of this word has been confused by the early adoption into English usage of the O. Fr. *bordel*. The two words are in origin quite distinct. Brothel is an O. Eng. word for a person, not a place. It meant an abandoned vagabond, one who had gone to ruin (*abrethelton*). *Bordel*, on the contrary, is a place, literally a small hut or shelter, especially for fornication, Med. Lat. *bordellum*, diminutive of the Late Lat. *boarda*, board. The words were early confused, and brothel-house, bordel-house, bordel or brothel, are all used for a disorderly house, while bordel was similarly misused, and, like brothel in its proper meaning, was applied to a disorderly person.

the Eng. verb and substantive. The Fr. word is made up of the prefix *de-*, Lat. *dis-*, and the root which appears in *empêcher*, to embarrass, and means literally to disentangle. The Lat. origin of *dépecher* and *empêcher* is a Low Lat. *pedicare*, *pedica*, a letter. The Fr. word came into Eng. as *depeach*, which was in use from the 15th century until "despatch" was introduced. This word is certainly direct from the Ital. *dispacciare*, or Span. *despachar*, which must be derived from the Lat. root appearing in *factus*, fixed, fastened, from *pangere*. The *New English Dictionary* finds the earliest instance of "despatch" in a letter to Henry VIII. from Bishop Tunstall, commissioner to Spain in 1516-1517.

DISPENSATION, a term with two main applications, (1) to the action of administering, arranging or dealing out, and (2) to the action of allowing certain things, rules, &c., to be done away with, relaxed. Of these two meanings the first is to be derived from the classical Latin use of *dispensare*, literally, to weigh out, hence to distribute, especially of the orderly arrangement of a household by a steward; thus *dispensatio* was, in theology, the word chosen to translate the Greek *οικονομία*, economy, *i.e.* divine or religious systems, as in the Jewish, Mosaic, Christian dispensations. Dispensation in law is, strictly speaking, the suspension by competent authority of general rules of law in particular cases. Its object is to modify the hardships often arising from the rigorous application of general laws to particular cases, and its essence is to preserve the law by suspending its operation, *i.e.* making it non-existent, in such cases. It follows, then, that dispensation, in its strict sense, is anticipative, *i.e.* it does not absolve from the consequences of a legal obligation already contracted, but avoids a breach of the law by suspending the obligation to conform to it, *e.g.* a dispensation or licence to marry within the prohibited degrees, or to hold benefices in plurality. The term is, however, frequently used of the power claimed and exercised by the supreme legislative authority of altering or abrogating in particular cases conditions established under the existing law and of releasing individuals from obligations incurred under it, *e.g.* dispensations granted by the pope *ex plenitudine potestatis* from the obligation of celibacy, from religious and other vows, from *matrimonium ratum, non consummatum*, &c.

1. *Ecclesiastical Law*.—In the theory of the canon law the dispensing power is the corollary of the legislative, the authority that makes laws, and no other, having power to suspend them. It follows that the law of nature (*jus naturae*) and *a fortiori* the law of God (*jus divinum*) are not subject to dispensation of any earthly authority, and that it is only the disciplinary laws made by the Church that the Church is empowered to suspend or to abrogate. Thus, not even the pope could grant a dispensation for a marriage between persons related in the direct line of ascent or descent, *e.g.* father and daughter, or between brother and sister, while dispensations are granted for marriages within other prohibited degrees, *e.g.* uncle and niece.

The dispensing power, like the legislative authority, was formerly invested in general councils and even in provincial synods; but in the West, with the gradual centralization of authority at Rome, it became ultimately vested in the pope as the supreme lawgiver of the Church. Subject, however, to the supreme jurisdiction of the pope, the power of dispensation continued to reside in the other organs of the Church in exact proportion to their legislative capacities, *i.e.* in provincial synods in respect of regional rules laid down by them, and in bishops in respect of rules laid down by them for their dioceses. According to Du Cange, the earliest record of the use of the word *dispensatio* in this connexion is in the letter of Pope Gelasius I. of the 11th of March 494, to the bishops of Lucania (in Jaffé, *Reg. Pont. Rom.*, ed. 2, tom. i. no. 636): *necessaria rerum Dispensacione constringimur, . . . sic canonum paternorum decreta librare, . . . ut quae praesentium necessitas temporum restaurandis Ecclesiis relaxanda deponit, adhibita consideratione diligent, quantum fieri potest temperemus.*² Dispensations from the observance

² In this quotation the word *dispensatio* still has its meaning of "economy": "we are bound by the necessary economy of things." Possibly its use by the pope in this connexion may have led to the technical meaning of the word *dispensatio* in the medieval canon law.

of traditional rules were, however, during the early centuries exceedingly rare, and there are more instances of the popes repudiating than of their exercising the power to grant them. Thus Celestine I. (d. 432) wrote: "The rules govern us, not we the rules: we are subject to the canons, since we are the servants of the precepts of the canons" (*Epist. 3 ad Episcopos Illyrici*); and Pope Zozimus wrote even more strongly: "This see possesses no authority to make any concession or change; for with us abides antiquity firmly rooted (*inconvulsis radicibus*), reverence for which the decrees of the Fathers enjoined." As time went on, however, and the Church expanded, this rigidly conservative attitude proved impossible to maintain, and the principle of "tempering" the law when forced to do so "by the exigencies of affairs or of the times" (*verum vel temporum angustia*), as laid down by Gelasius, was adopted into the canon law itself. The principle was, of course, singularly open to abuse. In theory it was laid down from the first that dispensations were only to be granted in cases of urgent necessity and in the highest interests of the Church; in practice, from the 11th century onwards, the power of dispensation was used by the popes as one of the most potent instruments for extending their influence. Dispensations to hold benefices in plurality formed, with provisions and the papal claim to the right of direct appointment, a powerful means for extending the patronage of the Holy See and therefore its hold over the clergy, and from the 13th century onwards this abuse assumed vast proportions (Hinschius iii. p. 250). Even more scandalous was the almost unrestrained traffic in licences and dispensations at Rome, which grew up, at least as early as the 14th century, owing to the fees charged for such dispensations having come to be regarded by the Curia as a regular source of revenue (Woker, *Das kirchliche Finanzwesen der Päpste*, Nördlingen, 1878, pp. 75, 100). Loud complaints of these abuses were raised in the reforming councils of Constance and Basel in the 15th century, but nothing was done effectually to check them.

The actual practice of the Roman Catholic Church is based upon the decisions of the council of Trent, which left the medieval theory intact while endeavouring to guard against its abuses. The proposal put forward by the Gallican and Spanish bishops to subordinate the papal power of dispensation to the consent of the Church in general council was rejected, and even the canons of the council of Trent itself, in so far as they affected reformation of morals or ecclesiastical discipline, were decreed "saving the authority of the Holy See" (*Sess. xxv. cap. 21, de ref.*). At the same time it was laid down in respect of all dispensations, whether papal or other, that they were to be granted only for just and urgent causes, or in view of some decided benefit to the Church (*urgens justaque causa et major quoadmodum utilitas*), and in all cases *gratis*. The payment of money for a dispensation was *ipso facto* to make the dispensation void (*Sess. xxv. cap. 18, de ref.*).

Though verbal dispensations are valid, papal dispensations are given in writing. Before the constitution *Sapienti* of Pius X. (1908) all dispensations *in foro externo*, especially in matrimonial causes, were dealt with by the Dataria Apostolica, those *in foro interno* by the Penitentiary, which latter also possessed *in foro externo* the right to grant dispensations in matrimonial causes to poor people. Since 1908 the Dataria only deals with dispensations in matters concerning benefices, dispensations in matrimonial matters having been transferred to the new Congregation on the discipline of the sacraments (see CURIA ROMANA).

The regular form of dispensation is the *forma commissaria* (*Trid. Sess. xxii. cap. 5, de ref.*), i.e. a mandate to the bishop to grant the dispensation, after due inquiry, in the pope's name. In exceptional cases, e.g. sovereigns or bishops, the dispensation is sent direct to the petitioner (*forma gratiosa*). Dispensations are nominally gratuitous; but the officials are entitled to fees for drawing them up, and there are customary "compositions" (*compositiones*) which are destined for charitable objects in Rome. These fees were and are regulated according to the capacity of the petitioners to pay, the result being that the abuses which the council of Trent had sought to abolish continued to flourish. In the 17th century a specially privileged class of bankers (*banquiers*

expeditionnaires) existed at Rome whose sole business was obtaining dispensations on commission, and one of these, named Pelletier, published at Paris in 1677, under the royal *imprimatur*, a regular tariff of the sums for which in any given case a dispensation might be obtained. That the "urgent and just cause" was, in the circumstances, a very minor consideration was to be expected, and the enlightened pope Benedict XIV., himself a canon lawyer of eminence, complained "Dispensationem non raro concedi in Dataria, sine causa, nempe ob elemosynam quae praestatur" (*Inst. 87, No. 26*). It may be added that the worst abuses of this system have long since disappeared. The bishops have their own correspondents at Rome, and one of the duties of the diplomatic representatives of foreign states at the Curia is to see that their nationals receive their dispensations without overcharge.

Bishops are by right (*jure ordinario*) competent to dispense in all cases expressly reserved to them by the canon law, e.g. in the matter of publication of banns of marriage. They possess besides special powers delegated to them by the pope and renewed every five years (*facultates quinquennales*), or by virtue of faculties granted to them personally (*facultates extraordinariae*), e.g. to dispense from rules of abstinence, from simple vows, and with some exceptions from the prohibition of marriage within prohibited degrees.

Church of England.—By 25 Henry VIII. cap. 21. sec. 2 (1534), it was enacted that neither the king, his successors, nor any of his subjects should henceforth sue for licences, dispensations, &c., to the see of Rome, and that the power to issue such licences, dispensations, &c., "for causes not being contrary or repugnant to the Holy Scriptures and laws of God," should be vested in the archbishop of Canterbury for the time being, who at his own discretion was to issue such dispensations, &c., under his seal, to the king and his subjects. The power of dispensation thus vested in the archbishops partly fell obsolete, partly has been curtailed by subsequent statutes, e.g. the Pluralities Act of 1838. It is now confined to granting dispensations for holding two benefices at once, to issuing licences for non-residence, and in matrimonial cases to the issuing of special licences. The dispensing power of bishops in the Church of England survives only in the right to grant marriage licences, i.e. dispensations from the obligation to publish the banns. Though, however, these licences and dispensations are given under the archiepiscopal and episcopal seals, they are actually issued by the commissaries of faculties and vicars-general (chancellors), independently, in virtue of the powers conferred on them by their patents. This has led, since the passing of the Divorce Acts and the Marriage with a Deceased Wife's Sister Act, to a curiously anomalous position, licences for the remarriage of divorced persons having been issued under the bishop's seal, while the bishop himself publicly protested that such marriages were contrary to "the law of God," but that he himself had no power to prevent his chancellor licensing them.

See Hinschius, *Kirchenrecht* (Berlin, 1883), iii. 250, &c.; article "Dispensation" by Hinschius in Herzog-Hauck, *Realencyclopädie* (Leipzig, 1898); article "Dispensation" in Wetzer and Welte's *Kirchenlexikon* (2nd ed. Freiburg im Breisgau, 1882-1901); F. Lichtenberger, *Encyclopédie des sciences religieuses* (Paris, 1878), s.v. "Dispense"; Phillimore, *Ecc. Law*.

2. *Constitutional Law.*—The power of dispensation from the operation of the ordinary law in particular cases is, of course, everywhere inherent in the supreme legislative authority, however rarely it may be exercised. Divorce (in Ireland) by act of parliament may be taken as an example which still actually occurs. On the other hand, the dispensing power once vested in the crown in England is now merely of historical interest, though of great importance in the constitutional struggles of the past. This power possessed by the crown of dispensing with the statute law is said to have been copied from the dispensations or *non obstante* clauses granted by the popes in matters of canon law; the parallel between them is certainly very striking, and there can be no doubt that the principles of the canon law influenced the decisions of the courts in the matter. It was, for instance, very generally laid down that the king could by dispensation make it lawful to do what was *malum prohibitum* but not to do what was

malum in se, a principle of the canon law, but one difficult to reconcile with English legal principles, since no act is legally *malum* unless forbidden by law. This was pointed out by Chief Justice Vaughan in the celebrated judgment in the case of *Thomas v. Sorrell*, when he rejected the distinction between *mala in se* and *mala prohibita* as confusing, and attempted to define the dispensing power of the crown by limiting it to cases of individual breaches of penal statutes where no third party loses a right of action, and where the breach is not continuous, at the same time denying the power of the crown to dispense with any general penal law. This judgment, as Sir William Anson points out, only showed the extreme difficulty of limiting the power ascribed to the crown, a standing grievance from the time that parliament had risen to be a constituent part of the state. So long as the legal principle by which the law was "the king's law" survived there was in fact no theoretical basis for such limitation, and the matter resolved itself into one of the great constitutional questions between crown and parliament which issued in the Revolution of 1688. The supreme crisis came owing to the use made by James II. of the dispensing power. His action in dispensing with the Test Act, in order to enable Roman Catholics to hold office under the crown, was supported by the courts in the test case of *Godden v. Hales*, but it made the Revolution inevitable. By the Bill of Rights the exercise of the dispensing power was forbidden, except as might be permitted by statute. At the same time the legality of its exercise in the past was admitted by the clause maintaining the validity of dispensations granted in a certain form before the 23rd of October 1689.

See Anson, *Law and Custom of the Constitution*, part i. "Parliament," 3rd ed. pp. 311-319; F. W. Maitland, *Const. Hist. of England* (Cambridge, 1908), pp. 302, &c.; Stubbs, *Const. Hist.* ss. 290, 291. (W. A. P.)

DISPERSION (from Lat. *dispergere*, to scatter), the act or process of separation and distribution. Apart from the technical use of the term, especially in optics (see below), the expression particularly applied to the settlements of Jews in foreign countries outside Palestine. These were either voluntary, for purposes of trade and commerce, or the results of conquest, such as the captivities of Assyria and Babylonia. The word *diaspora* (Gr. *διασπορά*) is also used of these scattered communities, but is usually confined to the dispersion among the Hellenic and Roman peoples, or to the body of Christian Jews outside Palestine (see JEWS).

DISPERSION, in OPTICS. When a beam of light which is not homogeneous in character, *i.e.* which does not consist of simple vibrations of a definite wave-length, undergoes refraction at the surface of any transparent medium, the different colours corresponding to the different wave-lengths become separated or *dispersed*. Thus, if a ray of white light AO (fig. 1) enters obliquely

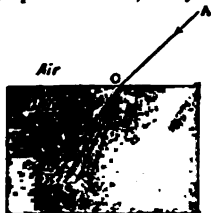

FIG. 1.

into the surface of a block of glass at O, it gives rise to the divergent system of rays ORV, varying continuously in colour from red to violet, the red ray OR being least refracted and the violet ray OV most so. The order of the successive colours in all colourless transparent media is red, orange, yellow, green, blue, indigo and violet. Dispersion is therefore due to the fact that rays of different colours possess different refrangibilities.

The simplest way of showing dispersion is to refract a narrow beam of sunlight through a prism of glass or prismatic vessel containing water or other clear liquid. As the light is twice refracted, the dispersion is increased, and the rays, after transmission through the prism, form a divergent system, which may be allowed to fall on a sheet of white paper, forming the well-known solar spectrum. This method was employed by Sir Isaac Newton, whose experiments constitute the earliest systematic investigation of the phenomenon. Let O (fig. 2) represent a

beam of sunlight which is allowed to fall on a white screen so as to form an image of the sun at S. If now the prism P be interposed as in the figure, the whole beam is not only refracted upward, but also spread out into the spectrum RV, the horizontal breadth of the band of colours being the same as that of the original image S. In an experiment similar to that here represented,

FIG. 2.

Newton made a small hole in the screen and another small hole in a second screen placed behind the first. By slightly turning the prism P, the position of the spectrum on the first screen could be shifted sufficiently to cause light of any desired colour to pass through. Some of this light also passed through the second hole, and thus he obtained a narrow beam of practically homogeneous light in a fixed direction (the line joining the apertures in the two screens). Operating on this beam with a second prism, he found that the homogeneous light was not dispersed, and also that it was more refracted the nearer the point from which it was taken approached to the violet end of the spectrum RV. This confirmed his previous conclusion that the rays increase in refrangibility from red to violet.

Newton also made use of the method of crossed prisms, which has been found of great use in studying dispersion: The prism P (fig. 3) refracts upwards, while the prism Q, which has its refracting edge perpendicular to that of P, refracts towards the right. The combined effect of the two is to produce a spectrum sloping up from left to right. The spectrum will be straight if the two prisms are similar in dispersive property, but if one of them is constructed of a material which possesses any peculiarity in this respect it will be revealed by the curvature of the spectrum.

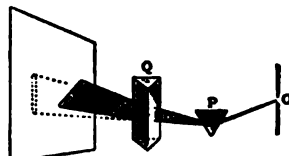

FIG. 3.—Method of Crossed Prisms.

The coloured borders seen in the images produced by simple lenses are due to dispersion. The explanation of the colours of the rainbow, which are also due to dispersion, was given by Newton, although it was known previously to be due to refraction in the drops of rain (see RAINBOW).

According to the wave-theory of light, refraction (*q.v.*) is due to a change of velocity when light passes from one medium to another. The phenomenon of dispersion shows that in dispersive media the velocity is different for lights of different wave-lengths. In free space, light of all wave-lengths is propagated with the same velocity, as is shown by the fact that stars, when occulted by the moon or planets, preserve their white colour up to the last moment of disappearance, which would not be the case if one colour reached the eye later than another. The absence of colour changes in variable stars or in the appearance of new stars is further evidence of the same fact. All material media, however, are more or less dispersive. In air and other gases, at ordinary pressures, the dispersion is very small, because the refractivity is small. The dispersive powers of gases are, however, generally comparable with those of liquids and solids.

Dispersive Power.—In order to find the amount of dispersion caused by any given prism, the deviations produced by it on two rays of any definite pure colours may be measured. The angle of difference between these deviations is called the dispersion for those rays. For this purpose the C and F lines in the spark-spectrum of hydrogen, situated in the red and blue respectively, are usually employed. If δ_r and δ_c are the angular deviations of these rays, then $\delta_r - \delta_c$ is called the mean dispersion of the prism. If the refracting angle of the prism is small, then the ratio of the dispersion to the mean deviation of the two rays is the dispersive power of the material of the prism. Instead of the mean deviation, $\frac{1}{2}(\delta_r + \delta_c)$, it is more usual to take the deviation of some intermediate ray. The exact position of the selected ray does not matter much, but the yellow D line of sodium

is the most convenient. If we denote its deviation by δ_D , then we may put

$$\text{Dispersive power} = (\delta_D - \delta_C) / \delta_D \quad (1).$$

This quantity may readily be expressed in terms of the refractive indices for the three colours, for if A is the angle of the prism (supposed small)

$$\delta_C = (\mu_C - 1)A, \quad \delta_D = (\mu_D - 1)A, \quad \delta_P = (\mu_P - 1)A,$$

where μ_C, μ_D, μ_P are the respective indices of refraction. This gives at once

$$\text{Dispersive power} = (\mu_P - \mu_C) / (\mu_D - 1) \quad (2).$$

The second of these two expressions is generally given as the definition of dispersive power. It is more useful than (1), as the refractive indices may be measured with a prism of any convenient angle.

By studying the dispersion of colours in water, turpentine and crown glass Newton was led to suppose that dispersion is proportional to refraction. He concluded that there could be no refraction without dispersion, and hence that achromatism was impossible of attainment (see **ABERRATION**). This conclusion was proved to be erroneous when Chester M. Hall in 1733 constructed achromatic lenses. Glasses can now be made differing considerably both in refractivity and dispersive power.

Irrationality of Dispersion.—If we compare the spectrum produced by refraction in a glass prism with that of a diffraction grating, we find not only that the order of colours is reversed, but also that the same colours do not occupy corresponding lengths on the two spectra, the blue and violet being much more extended in the refraction spectrum. The refraction spectra for different media also differ amongst themselves. This shows that the connexion between the refrangibility of light and its wave-length does not obey any simple law, but depends on the nature of the refracting medium. This property is referred to as the "irrationality of dispersion." In a diffraction spectrum the diffraction is proportional to the wave-length, and the spectrum is said to be "normal." If the increase of the angle of refraction were proportional to the diminution of wave-length for a prism of any material, the resulting spectrum would also be normal. This, however, is not the case with ordinary refracting media, the refrangibility generally increasing more and more rapidly as the wave-length diminishes.

The irrationality of dispersion is well illustrated by C. Christiansen's experiments on the dispersive properties of white powders. If the powder of a transparent substance is immersed in a liquid of the same refractive index, the mixture becomes transparent and a measurement of the refractive index of the liquid gives the refractivity of the powder. Christiansen found, in an investigation of this kind, that the refractivity of the liquid could only be got to match that of the powder for mono-chromatic light, and that, if white light were used, brilliant colour effects were obtained, which varied in a remarkable manner when small changes occurred in the refractive index of the liquid. These effects are due to the difference in dispersive power of the powder and the liquid. If the refractive index is, for instance, the same for both in the case of green light, and a source of white light is viewed through the mixture, the green component will be completely transmitted, while the other colours are more or less scattered by multiple reflections and refractions at the surfaces of the powdered substance. Very striking colour changes are observed, according to R. W. Wood, when white light is transmitted through a paste made of powdered quartz and a mixture of carbon bisulphide with benzol having the same refractive index as the quartz for yellow light. In this case small temperature changes alter the refractivity of the liquid without appreciably affecting the quartz. R. W. Wood has studied the iridescent colours seen when a precipitate of potassium silicofluoride is produced by adding silicofluoric acid to a solution of potassium chloride, and found that they are due to the same cause, the refractive index of the minute crystals precipitated being about the same as that of the solution, which latter can be varied by dilution.

Anomalous Dispersion.—In some media the usual order of the colours is changed. This curious phenomenon was noticed by W. H. Fox Talbot about 1840, but does not seem to have become generally known. In 1860 F. P. Leroux discovered that iodine vapour refracted the red rays more than the violet, the intermediate colours not being transmitted; and in 1870 Christiansen found that an alcoholic solution of fuchsin refracted the violet less than the red, the order of the successive colours being violet, red, orange, yellow; the green being absorbed and a dark interval occurring between the violet and red. A. Kundt found that similar effects occur with a large number of substances, in particular with all those which possess the property of "surface colour," i.e., which strongly reflect light of a definite colour, as do many of the aniline dyes. Such bodies show strong absorption bands in those colours which they reflect, while of the transmitted light that which is of a slightly greater wave-length than the absorbed light has an abnormally great refrangibility, and that of a slightly shorter wave-length an abnormally small refrangibility. The name given to this phenomenon,—*"anomalous dispersion"*—is an unfortunate one, as it has been found to obey a regular law.

In studying the dispersion of the aniline dyes, a prism with a very small refracting angle is made of two glass plates slightly inclined

to each other and enclosing a very thin wedge of the dye, which is either melted between the plates, or is in the form of a solution retained in position by surface-tension. Only very thin layers are sufficiently transparent to show the dispersion near or within an absorption band, and a large refracting angle is not required, the dispersion usually being very considerable. Another method, which has been used by R. W. Wood and C. E. Magnusson, is to introduce a thin film of the dye into one of the optical paths of a Michelson interferometer, and to determine the consequent displacement of the fringes. E. Mach and J. Arbes have used a method depending on total reflection (Drude's *Theory of Optics*, p. 394).

A very remarkable example of anomalous dispersion, which was first observed by A. Kundt, is that exhibited by the vapour of sodium. It has not been found practicable to make a prism of this vapour in the ordinary way by enclosing it in a glass vessel of the required shape, as sodium vapour attacks glass, quickly rendering it opaque. A. E. Becquerel, however, investigated the character of the dispersion by using prism-shaped flames strongly coloured with sodium. But the best way of exhibiting the effect is by making use of a remarkable property of sodium vapour discovered by R. W. Wood and employed for this purpose in a very ingenious manner. He found that when sodium is heated in a hard glass tube, the vapour which is formed is extraordinarily cohesive, only slowly spreading out in a cloud with well-defined borders, which can be rendered visible by placing the tube in front of a sodium flame, against which the cloud appears black. If a long glass tube with plane ends, and containing some pellets of sodium is heated in the middle by a row of burners, the cool ends remain practically vacuum and do not become obscured. The sodium vapour in the middle is very dense on the heated side, the density diminishing rapidly towards the upper part of the tube, so that, although not prismatic in form, it refracts like a prism owing to the variation in density. Thus if a horizontal slit is illuminated by an arc lamp, and the light—rendered parallel by a collimating lens—is transmitted through the sodium tube and focused on the vertical slit of a spectroscope, the effect of the sodium vapour is to produce its refraction spectrum vertically on the slit. The image of this seen through the glass prism of the spectroscope will appear as in fig. 4. The whole of the light, with the exception of a small part in the neighbourhood of the D lines, is practically undeviated, so that it illuminates only a very short piece of the slit and is spread out into the ordinary spectrum. But the light of slightly greater wave-length than the D lines, being refracted strongly downward by the sodium vapour, illuminates the bottom of the slit; while that of slightly shorter wave-length is refracted upward and illuminates the top of the slit. Fig. 4 represents the inverted image seen in the telescope. The light corresponding to the D lines and the space between them is absorbed, as evidenced by the dark interval. If the sodium is only gently heated, so as to produce a comparatively rarefied vapour, and a grating spectroscope employed, the spectrum obtained is like that shown in fig. 5, which was the effect noticed by Becquerel with the sodium flame. Here the light corresponding to the space between the D lines is transmitted, being strongly refracted upward near D_1 and downward near D_2 .

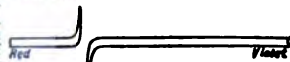

FIG. 4.—Anomalous Dispersion of Sodium Vapour.

The theory of anomalous dispersion has been applied in a very interesting way by W. H. Julius to explain the "Rash spectrum" seen during a solar eclipse at the moment at which totality occurs. The conditions of this phenomenon have been imitated in the laboratory by Wood, and the corresponding effect obtained.

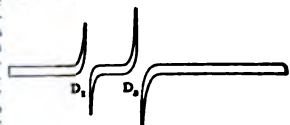

FIG. 5.

The conditions of this phenomenon have been imitated in the laboratory by Wood, and the corresponding effect obtained.

Theories of Dispersion.—The first attempt at a mathematical theory of dispersion was made by A. Cauchy and published in 1835. This was based on the assumption that the medium in which the light is propagated is discontinuous and molecular in character, the molecules being subject to a mutual attraction. Thus, if one molecule is disturbed from its mean position, it communicates the disturbance to its neighbours, and so a wave is propagated. The formula arrived at by Cauchy was

$$n = A + \frac{B}{\lambda^2} + \frac{C}{\lambda^4} + \dots$$

n being the refractive index, λ the wave-length, and A, B, C, \dots , constants depending on the material, which diminish so rapidly that only the first three as here written need be taken into account. If suitable values are chosen for these constants, the formula can be made to represent the dispersion of ordinary transparent media within the visible spectrum very well, but when extended to the infra-red region it often departs considerably from the truth, and it fails altogether in cases of anomalous dispersion. There are also grave theoretical objections to Cauchy's formula.

The modern theory of dispersion, the foundation of which was laid by W. Sellmeier, is based upon the assumption that an interaction takes place between ether and matter. Sellmeier adopted the elastic-solid theory of the ether, and imagined the molecules to be attached to the ether surrounding them, but free to vibrate about their mean positions within a limited range. Thus the ether within the dispersive medium is loaded with molecules which are forced to perform oscillations of the same period as that of the transmitted wave. It can be shown mathematically that the velocity of propagation will be greatly increased if the frequency of the light-wave is slightly greater, and greatly diminished if it is slightly less than the natural frequency of the molecules; also that these effects become less and less marked as the difference in the two frequencies increases. This is exactly in accordance with the observed facts in the case of substances showing anomalous dispersion. Sellmeier's theory did not take account of absorption, and cannot be applied to calculate the dispersion within a broad absorption band. H. von Helmholtz, working on a similar hypothesis, but with a frictional term introduced into his equations, obtained formulæ which are applicable to cases of absorption. A modified form of Helmholtz's equation, due to E. Ketteler and known as the Ketteler-Helmholtz formula, has been much used in calculating dispersion, and expresses the facts with remarkable accuracy. P. Drude has obtained a similar formula based on the electromagnetic theory, thus placing the theory of dispersion on a much more satisfactory basis. The fundamental assumption is that the medium contains positively and negatively charged ions or electrons which are acted on by the periodic electric forces which occur in wave propagation on Maxwell's theory. The equations finally arrived at are

$$\mu^2(1-\pi^2) = 1 + \sum \frac{D\lambda^2(\lambda^2 - \lambda_{\infty}^2)^2}{(\lambda^2 - \lambda_{\infty}^2)^2 + g^2\lambda^2}$$

$$2\pi^2\kappa = \sum \frac{Dg\lambda^2}{(\lambda^2 - \lambda_{\infty}^2)^2 + g^2\lambda^2}$$

where λ is the wave-length in free ether of light whose refractive index is μ , and λ_{∞} the wave-length of light of the same period as the electron, π is a coefficient of absorption, and D and g are constants. The sign of summation Σ is used in cases where there are several absorption bands, and consequently several similar terms on the right-hand side, each with a different value of λ_{∞} . This would occur if there were several kinds of ions, each with its own natural period.

In a region where there is no absorption, we have $\pi=0$ and therefore $g=0$, and we have only one equation, namely,

$$\mu^2 = 1 + \sum \frac{D\lambda^2}{\lambda^2 - \lambda_{\infty}^2}$$

which is identical with Sellmeier's result. As λ_{∞} is a wave-length corresponding to an absorption band, this formula can be used to find values of λ_{∞} which satisfy the observed values of μ within the region of transparency, and so to determine where the absorption bands are situated. In this way the existence of bands in the infra-red part of the spectrum has been predicted in the case of quartz and detected by experiments on the selective reflection of the material.

References.—For the theory of dispersion see P. Drude, *Theory of Optics* (Eng. trans.); R. W. Wood, *Physical Optics*; and A. Schuster, *Theory of Optics*. For descriptive accounts, see Wood's *Physical Optics*, T. Preston's *Theory of Light*, E. Edser's *Light*. The last work contains an elementary treatment of Sellmeier's theory. (J. R. C.)

D'ISRAELI (or **DISRAELI**), **ISAAC** (1766-1848), English man of letters, father of the earl of Beaconsfield (q.v.), was born at Enfield in May 1766. He belonged to a Jewish family which, having been driven by the Inquisition from Spain, towards the end of the 15th century, settled as merchants at Venice, and assumed the name which has become famous; it was generally spelt D'Israeli until the middle of the 19th century. In 1748 his father, Benjamin D'Israeli, then only about eighteen years of age, removed to England, where, before passing the prime of life, he amassed a competent fortune, and retired from business. He belonged to the London congregation of Spanish and Portuguese Jews, of which his son also remained a nominal member until after Benjamin D'Israeli died at the end of 1816.

The strongly marked characteristics which determined Isaac D'Israeli's career were displayed to a singular degree even in his boyhood. He spent his time over books and in long day-dreams, and evinced the strongest distaste for business and all the more bustling pursuits of life. These idiosyncrasies met with no sympathy from either of his parents, whose ambitious plans for his future career they threatened to disappoint. When he was about fourteen, in the hope of changing the bent of his mind, his father sent him to live with his agent at Amsterdam, where he worked under a tutor for four or five years. Here he studied Bayle and Voltaire, and became an ardent disciple of Rousseau. Here also he wrote a long poem against commerce, which he produced as an exposition of his opinions when, on his return to

England, his father announced his intention of placing him in a commercial house at Bordeaux. Against such a destiny D'Israeli's mind strongly revolted, and he carried his poem, with a letter earnestly appealing for advice and assistance, to Samuel Johnson; but when he called again a week after to receive an answer, the packet was returned unopened—the great Doctor was on his death-bed. He also addressed a letter to Dr Vicesimus Knox, master of Tonbridge Grammar School, begging to be received into his family, that he might enjoy the benefit of his learning and experience. How this application was answered we do not know. The evident firmness of his resolve, however, was not without effect. His parents gave up their purpose for a time. He was sent to travel in France, and allowed to occupy himself as he wished; and he had the happiness of spending some months in Paris, in the society of literary men, and devoted to the literary pursuits in which he delighted.

In the beginning of 1788 he returned home, and in the next year he attacked Peter Pindar (John Wolcot) in *The Gentleman's Magazine* in a poem in the manner of Pope, "On the Abuse of Satire." The authorship of the poem was much debated, and it was attributed by some to William Hayley, upon whom it was actually avenged, with characteristic savageness, by its victim. It is greatly to Wolcot's credit that, on learning his mistake, he sought the acquaintance of his young opponent, whose friend he remained to the end of his life. Through the success of this satire D'Israeli made the acquaintance of Henry James Pye, who helped to persuade his father that it would be a mistake to force him into a business career, and introduced him into literary circles. D'Israeli dedicated his first book, *A Defence of Poetry*, to Pye in 1790. Henceforth his life was passed in the way he best liked—in quiet and almost uninterrupted study. In 1802 he married Maria Basevi, by whom he had five children, of whom Benjamin (afterwards Lord Beaconsfield and Prime Minister of England) was the second. He was able to maintain his strenuous habits of study till he reached the advanced age of seventy-two, when he was forced, by paralysis of the optic nerve, to give up work almost entirely. He lived ten years longer, and died at his seat at Bradenham House, Buckinghamshire, on the 19th of January 1848.

Isaac D'Israeli is most celebrated as the author of the *Curiosities of Literature* (1791, subsequent volumes in 1793, 1817, 1823 and 1834). It is a miscellany of literary and historical anecdotes, of original critical remarks, and of interesting and curious information of all kinds, animated by genuine literary feeling, taste and enthusiasm. With the *Curiosities of Literature* may be classed D'Israeli's *Miscellanies, or Literary Recreations* (1796), the *Calamities of Authors* (1812-1813), and the *Quarrels of Authors* (1814). Towards the close of his life D'Israeli projected a continuous history of English literature, three volumes of which appeared in 1841 under the title of the *Amenities of Literature*. But of all his works the most delightful is his *Essay on the Literary Character* (1795), which, like most of his writings, abounds in illustrative anecdotes. In the famous "Pope controversy" he supported Byron and Campbell against Bowles and Hazlitt by a defence of Pope in the form of a criticism of Joseph Spence's *Anecdotes* contributed to the *Quarterly Review* (July 1820). In 1797 D'Israeli published three novels; one of these, *Mejnoun and Leila, the Arabian Petrarch and Laura*, was said to be the first oriental romance in English. His last novel, *Despotism, or the Fall of the Jesuits*, appeared in 1811, but none of his romances was popular. He also published a slight sketch of Jewish history, and especially of the growth of the Talmud, entitled the *Genius of Judaism* (1833).

He was the author of two historical works—a brief defence of the literary merit and personal and political character of James I. (1816), and a learned *Commentary on the Life and Reign of King Charles I.* (1828-1831). This was recognized by the University of Oxford, which conferred upon the author the honorary degree of D.C.L. As an historian D'Israeli is distinguished by two characteristics. In the first place, he had small interest in politics, and no sympathy with the passionate fervour, or adequate appreciation of the importance, of political struggles. And, secondly, with a laborious zeal then less common than now among

historians, he sought to bring to light fresh historical material by patient search for letters, diaries and other manuscripts of value which had escaped the notice of previous students. Indeed, the honour has been claimed for him of being one of the founders of the modern school of historical research.

Of the amiable personal character and the placid life of Isaac D'Israeli a charming picture is to be found in the brief memoir prefixed to the 1849 edition of *Curiosities of Literature*, by his son Lord Beaconsfield.

DISS, a market town in the southern parliamentary division of Norfolk, England; near the river Waveney (the boundary with Suffolk), 95 m. N.E. by N. from London by the Great Eastern railway. Pop. of urban district (1901) 3745. The town lies pleasantly upon a hill rising above a mere, which drains to the Waveney, having its banks laid out as public gardens. The church of St Mary exhibits Decorated and Perpendicular stone and flint work. There is a corn exchange and the agricultural trade is considerable; brushes and matting are manufactured. The poet and satirist, John Skelton (d. 1520), was rector here in the later part of his life, and is doubtfully considered a native.

DISSECTION (from Lat. *dissicare*, to cut apart), the separation into parts by cutting, particularly the cutting of an animal or plant into parts for the purpose of examination or display of its structure.

DISSENTER (Lat. *dis-sensire*, to disagree), one who dissents or disagrees in matters of opinion, belief, &c. The term "dissenter" is, however, practically restricted to the special sense of a member of a religious body in England which has, for one reason or another, separated from the Established Church. Strictly, the term includes the English Roman Catholics, who in the original draft of the Relief Act of 1791 were styled "Protesting Catholic Dissenters." It is in practice, however, restricted to the "Protestant Dissenters" referred to in sec. ii. of the Toleration Act of 1688. The term is not applied to those bodies who dissent from the Established Church of Scotland; and in speaking of members of religious bodies which have seceded from established churches abroad it is usual to employ the term "dissenters" (Lat. *dissidere*, to dissent). In this connotation the terms "dissenter" and "dissenting," which had acquired a somewhat contemptuous flavour, have tended since the middle of the 19th century to be replaced by "nonconformist," a term which did not originally imply secession, but only refusal to conform in certain particulars (e.g. the wearing of the surplice) with the authorized usages of the Established Church. Still more recently the term "nonconformist" has in its turn, as the political attack on the principle of a state establishment of religion developed, tended to give place to the style of "Free Churches" and "Free Churchman." All three terms are now in use, "nonconformist" being the most usual, as it is the most colourless. (See CONGREGATIONALISM, &c.)

DISSOCIATION, a separation or dispersal, the opposite of association. In chemistry the term is given to chemical reactions in which a substance decomposes into two or more substances, and particularly to cases in which associated molecules break down into simpler molecules. Thus the reactions $\text{NH}_4\text{Cl} \rightleftharpoons \text{NH}_3 + \text{HCl}$, and $\text{PCl}_5 \rightleftharpoons \text{PCl}_3 + \text{Cl}_2$ are instances of the first type; $\text{N}_2\text{O}_4 \rightleftharpoons 2\text{NO}_2$, of the second (see CHEMICAL ACTION). Electrolytic or ionic dissociation is the separation of a substance in solution into ions (see ELECTROLYSIS; SOLUTION).

DISSOLUTION (from Lat. *dissolvere*, to break up into parts), the act of dissolving or reducing to constituent parts, especially of the bringing to an end an association such as a partnership or building society, and particularly of the termination of an assembly. A dissolution of parliament in England is thus the end of its existence, brought about by the efflux of time in accordance with the Septennial Act 1716, or by an exercise of the royal prerogative. This is done either in person, or by commission, if parliament is sitting; if prorogued, then by proclamation. The word is used as a synonym for end or death.

DISTAFF, in the early forms of spinning, the "rock" or short stick round one end of which the flax, cotton or wool is loosely wound, and from which it is spun off by the spindle. The word is derived from the Old English *distacel*, the first part of which is

connected with *disen*, in modern English seen in "bedizen," to deck out or embellish, originally "to equip the distaff with flax, &c." cf. the German dialectal word *Diesse*, flax. The last part of the word is "staff." "Distaff" from early times has been used to symbolize woman's work (cf. the use of "spinstar" for an unmarried woman); thus the "distaff" or "spindle" side of a family refers to the female branch, as opposed to the "spear" or male branch. The 7th of January, the day after Epiphany, was formerly known as St Distaff's day, as women then began work again after the Christmas holiday.

DISTILLATION (from the Lat. *distillare*, more correctly *destillare*, to drop or trickle down), an operation consisting in the conversion of a substance or mixture of substances into vapours which are afterwards condensed to the liquid form; it has for its object the separation or purification of substances by taking advantage of differences in volatility. The apparatus consists of three parts—the "retort" or "still," in which the substance is heated; the "condenser," in which the vapours are condensed; and the "receiver," in which the condensed vapours are collected. Generally the components of a mixture will be vaporized in the order of their boiling-points; consequently if the condensates or "fractions" corresponding to definite ranges of temperature be separately collected, it is obvious that a more or less partial separation of the components will be effected. If the substance operated upon be practically pure to start with, or the product of distillation be nearly of constant composition, the operation is termed "purification by distillation" or "rectification"; the latter term is particularly used in the spirit industry. If a complex mixture be operated upon, and a separation effected by collecting the distillates in several portions, the operation is termed "fractional distillation." Since many substances decompose either at, or below, their boiling-points under ordinary atmospheric pressure, it is necessary to lower the boiling-point by reducing the pressure if it be desired to distil them. This variation is termed "distillation under reduced pressure or in a vacuum." The vaporization of a substance below its normal boiling-point can also be effected by blowing in steam or some other vapour; this operation is termed "distillation with steam." "Dry distillation" is the term used when solid substances which do not liquefy on heating are operated upon; "sublimation" is the term used when a solid distils without the intervention of a liquid phase.

Distillation appears to have been practised at very remote times. The Alexandrians prepared oil of turpentine by distilling pine-resin; Zosimus of Panopolis, a voluminous writer of the 5th century A.D., speaks of the distillation of a "divine water" or "panacea" (probably from the complex mixture of calcium polysulphides, thiosulphate, &c., and free sulphur, which is obtained by boiling sulphur with lime and water) and advises "the efficient luting of the apparatus, for otherwise the valuable properties would be lost." The Arabians greatly improved the earlier apparatus, naming one form the alembic (q.v.); they discovered many ethereal oils by distilling plants and plant juices, alcohol by the distillation of wine, and also distilled water. The alchemists gave great attention to the method, as is shown by the many discoveries made. Nitric, hydrochloric and sulphuric acids, all more or less impure, were better studied; and many ethereal oils were discovered. Prior to about the 18th century three forms of distillation were practised: (1) *destillatio per ascensum*, in which the retort was heated from the bottom, and the vapours escaped from the top; (2) *destillatio per latus*, in which the vapours escaped from the side; (3) *destillatio per descensum*, in which the retort was heated at the top, and the vapours led off by a pipe passing through the bottom. According to K. B. Hoffmann the earliest mention of *destillatio per descensum* occurs in the writings of Aëtius, a Greek physician who flourished at about the end of the 5th century.

In modern times the laboratory practice of distillation was greatly facilitated by the introduction of the condenser named after Justus von Liebig; A. Kolbe and E. Frankland introduced the "reflux condenser," i.e. a condenser so placed that the condensed vapours return to the distilling flask, a device permitting the continued boiling of a substance with little loss; W.

Dittmar and R. Anschütz, independently of one another, introduced "distillation under reduced pressure"; and "fractional distillation" was greatly aided by the columns of Wurtz (1855), E. Linnemann (1871), and of J. A. Le Bel and A. Henninger (1874). In chemical technology enormous strides have been made, as is apparent from the coal-gas, coal-tar, mineral oil, spirits and mineral acids industries.

The subject is here treated under the following subdivisions: (1) ordinary distillation, (2) distillation under reduced pressure, (3) fractional distillation, (4) distillation with steam, (5) theory of distillation, (6) dry distillation, (7) distillation in chemical technology and (8) commercial distillation of water.

1. *Ordinary Distillation.*—The apparatus generally used is shown in fig. 1. The substance is heated in a retort *a*, which consists of a large bulb drawn out at the top to form a long neck; it may also

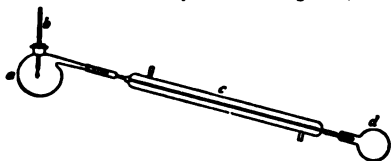

FIG. 1.

be provided with a tubulure, or opening, which permits the charging of the retort, and also the insertion of a thermometer *b*. The retort may be replaced by a distilling flask, which is a round-bottomed flask (generally with a lengthened neck) provided with an inclined side tube. The neck of the retort, or side tube of the flask, is connected to the condenser *c* by an ordinary or rubber cork, according to the nature of the substance distilled; ordinary corks soaked in paraffin wax are very effective when ordinary or rubber corks cannot be used. Sometimes an "adapter" is used; this is simply a tapering tube, the side tube being corked into the wider end, and the condenser on to the narrower end. The thermometer is placed so that the bulb is near the neck of the retort or the side tube of the distilling flask. It generally happens that much of the mercury column is outside the flask and consequently at a lower temperature than the bulb, hence a correction of the observed temperature is necessary. If *N* be the length of the unheated mercury column in degrees, *t* the temperature of this column (generally determined by a small thermometer placed with its bulb at the middle of the column), and *T* the temperature recorded by the thermometer, then the corrected temperature of the vapour is $T + 0.000143 (T-t) N$ (T. E. Thorpe, *Journ. Chem. Soc.*, 1880, p. 159).

The mode of heating varies with the substance to be distilled. For highly volatile liquids, e.g. ether, ligroin, &c., immersion of the flask in warm water suffices; for less volatile liquids a directly heated water or sand bath is used; for other liquids the flask is heated through wire gauze or asbestos board, or directly by a Bunsen. The condensing apparatus must also be conditioned by the volatility. With difficulty volatile substances, e.g. nitrobenzene, air cooling of the retort neck or of a straight tube connected with the distilling flask will suffice; or wet blotting-paper placed on the tube and the receiver immersed in water may be used. For less volatile liquids the Liebig condenser is most frequently used. In its original form, this consists of a long tube surrounded by an outer tube so arranged that cold water circulates in the annular space between the two. The vapours pass through the inner tube, and the cold water enters at the end farthest from the distilling flask. For more efficient condensation—and also for shortening the apparatus—the central tube may be flattened, bent into a succession of *V*'s, or twisted into a spiral form, the object in each case being to increase the condensing surface.

Of other common types of condenser, we may notice the "spiral" or "worm" type, which consists of a glass, copper or tin worm enclosed in a vessel in which water circulates; and the ball condenser, which consists of two concentric spheres, the vapour passing through the inner sphere and water circulating in the space between this and the outer (in another form the vapour circulates in a shell, on the outside and inside of which water circulates). A very effective type is shown in fig. 2. The condensing water enters at the top and is conducted to the bottom of the inner tube, which it fills and then flows over the outside of the outer tube; it collects in the bottom funnel and is then led off. The vapours pass between the inner and outer tubes.

Practically any vessel may serve as a receiver—test tube, flask, beaker, &c. If noxious vapours come over, it is necessary to have an air-tight connexion between the condenser and receiver, and to pro-

vide the latter with an outlet tube leading to an absorption column or other contrivance in which the vapours are taken up. If the substances operated upon decompose when heated in air, as, for example, the zinc alkyls which inflame, the air within the apparatus is replaced by some inert gas, e.g. nitrogen, carbon dioxide, &c., which is led in at the distilling flask before the process is started, and a slow current maintained during the operation.

2. *Distillation under Reduced Pressure.*—This method is adopted for substances which decompose at their boiling-points under ordinary pressure, and, generally, when it is desirable to work at a lower temperature. The apparatus differs very slightly from that employed in ordinary distillation. The "receiver" must be connected on the one side to the condenser, and on the other to the exhaust pump. A safety vessel and a manometer are generally interposed between the pump and receiver. For the purpose of collecting the distillates in fractions, many forms of receivers have been devised. Brühl's is one of the simplest. It consists of a number of tubes mounted vertically on a horizontal circular disk which rotates about a vertical axis in a cylindrical vessel. This vessel has two tubulures: through one the end of the condenser projects so as to be over one of the receiving tubes; the other leads to the pump. By rotating the disk the tubes may be successively brought under the end of the condenser. Boiling under reduced pressure has one very serious drawback, viz. the liquid boils irregularly or "bumps." W. Dittmar showed that this may be avoided by leading a fine, steady stream of dry gas—air, carbon dioxide, hydrogen, &c., according to the substance operated upon—through the liquid by means of a fine capillary tube, the lower end of which reaches to nearly the bottom of the flask. "Bumping" is common in open boiling when the liquid is free from air bubbles and the interior of the vessel is very smooth. It may be diminished by introducing clippings of platinum foil, pieces of porcelain, glass beads or garnets into the liquid. "Frothing" is another objectionable feature with many liquids. When cold, froth can be immediately dissipated by adding a few drops of ether. In boiling liquids its formation may be prevented by adding paraffin wax; the wax melts and forms a ring on the surface of the liquid, which boils tranquilly in the centre.

3. *Fractional Distillation.*—By fractional distillation is meant the separation of a mixture having components which boil at neighbouring temperatures. The distilling flask has an elongated neck so that

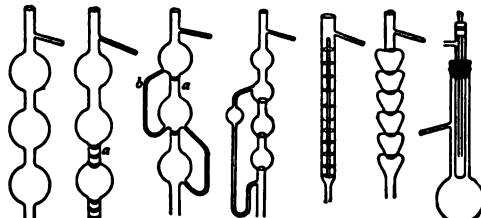

Wurtz. Linnemann. Le Bel-Henninger. Glynsky.

Young.

Krusler.

FIG. 3.

the less volatile vapours are condensed and return to the flask, while the more volatile component passes over. The success of the operation depends upon two factors: (1) that the heating be careful, slow and steady, and (2) that the column attached to the flask be efficient to sort out, as it were, the most volatile vapour. Three types of columns are employed: (1) the elongation is simply a straight or bulb tube; (2) the column, properly termed a "dephlegmator," is so constructed that the vapours have to traverse a column of previously condensed vapour; (3) the column is encircled by a jacket through which a liquid circulates at the same temperature as the boiling-point of the most volatile component. To the first type belongs the simple straight tube, and the Wurtz tube (see fig. 3), which is simply a series of bulbs blown on a tube. These forms are not of much value. Several forms of the second type are in use. In the Linnemann column the condensed vapours temporarily collect on platinum gauzes (*a*) placed at the constrictions of a bulbous tube. In the Le Bel-Henninger form a series of bulbs are connected consecutively by means of syphon tubes (*b*) and having platinum gauzes (*a*) at the constrictions, so that when a certain amount of liquid collects in any one bulb it syphons over into the next lower bulb. The Glynsky form is simpler, having only one syphon tube; at the constrictions it is usual to have a glass bead. The "rod-and-disk" form of Sidney Young is a series of disks mounted on a central spindle and surrounded by a slightly wider tube. The "pear-shaped" form of the same author consists of a series of pear-shaped bulbs, the narrow end of one adjoining the wider end of the next lower one. In this class may also be placed the Hempel tube, which is simply a straight tube filled with glass beads. Of the third type is the Warren column consisting of a spiral kept at a constant temperature by a liquid bath. Improved forms were devised by

F. D. Brown. Kreusler's form is easily made and manipulated. A tube closed at the bottom is traversed by an open narrower tube, and the arrangement is fitted in the neck of the distilling flask. Water is led in by the inner tube, and leaves by a side tube fused on the wider tube. Many comparisons of the effectiveness of dephlegmating columns have been made (see Sidney Young, *Fractional Distillation*, 1903). The pear-shaped form is the most effective, second in order is the Le Bel-Henninger, which, in turn, is better than the Glynsky. The main objection to the Hempel is the retention of liquid in the beads, and the consequent inapplicability to the distillation of small quantities.

4. *Distillation with Steam*.—In this process a current of steam, which is generated in a separate boiler and superheated, if necessary, by circulation through a heated copper worm, is led into the distilling vessel, and the mixed vapours condensed as in the ordinary processes. This method is particularly successful in the case of substances which cannot be distilled at their ordinary boiling-points (it will be seen in the following section that distilling with steam implies a lowering of boiling-point), and which can be readily separated from water. Instances of its application are found in the separation of ortho- and para-nitrophenol, the α -compound distilling and the β -remaining behind; in the separation of aniline from the mixture obtained by reducing nitrobenzene; of the naphthols from the melts produced by fusing the naphthalene monosulphonic acids with potash; and of quinoline from the reaction between aniline, nitrobenzene, glycerin, and sulphuric acid (the product being first steam distilled to remove any aniline, nitrobenzene, or glycerin, then treated with alkali, and again steam distilled when quinoline comes over). With substances prone to discolorization, as, for example, certain amino compounds, the operation may be conducted in an atmosphere of carbon dioxide, or the water may be saturated with sulphuretted hydrogen. Liquids other than water may be used: thus alcohol separates α -piccoline and ether nitropropylene.

5. *Theory of Distillation*.—The general observation that under a constant pressure a pure substance boils at a constant temperature leads to the conclusion that the distillate which comes over while the thermometer records only a small variation is of practically constant composition. On this fact depends "rectification or purification by distillation." A liquid boils when its vapour pressure equals the superincumbent pressure (see VAPORIZATION); consequently any process which diminishes the external pressure must also lower the boiling-point. In this we have the theory of "distillation under reduced pressure." The theory of fractional distillation, or the behaviour of liquid mixtures when heated to their boiling-points, is more complex. For simplicity we confine ourselves to mixtures of two components, in which experience shows that three cases are to be recognized according as the components are (1) completely immiscible, (2) partially miscible, (3) miscible in all proportions.

When the components are completely immiscible, the vapour pressure of the one is not influenced by the presence of the other. The mixture consequently distils at the temperature at which the sum of the partial pressures equals that of the atmosphere. Both components come over in a constant proportion until one disappears; it is then necessary to raise the temperature in order to distil the residue. The composition of the distillate is determinate (by Avogadro's law) if the molecular weights and vapour pressure of the components at the temperature of distillation be known. If M_1 , M_2 , and P_1 , P_2 be the molecular weights and vapour pressures of the components A and B, then the ratio of A to B in the distillate is M_1P_1/M_2P_2 . Although, as is generally the case, one liquid (say A) is more volatile than the other (say B), i.e. P_1 greater than P_2 , if the molecular weight of A be much less than that of B, then it is obvious that the ratio M_1P_1/M_2P_2 need not be very great, and hence the less volatile liquid B could come over in fair amount. These conditions pertain in cases where distillation with steam is successfully practiced, the relatively high volatility of water being counterbalanced by the relatively high molecular weight of the other component; for example, in the case of nitrobenzene and water the ratio is 1 to 5. In general, when the substance to be distilled has a vapour pressure of only 10 mm. at 100° C., distillation with steam can be adopted, if the product can be subsequently separated from the water.

When distilling a mixture of partially miscible components a distillate of constant composition is obtained so long as two layers are present, i.e. A dissolved in B and B dissolved in A, since both of these solutions emit vapours of the same composition (this follows since the same vapour must be in equilibrium with both solutions, for if it were not so a cyclic system contradicting the second law of thermodynamics would be realizable). The composition of the vapour, however, would not be the same as that of either layer. As the distillation proceeded one layer would diminish more rapidly than the other until only the latter would remain; this would then distil as a completely miscible mixture.

The distillation of completely miscible mixtures is the most common practically and the most complex theoretically. A co-ordination of the results obtained on the distillation of mixtures of this nature with the introduction of certain theoretical considerations led to the formation of three groups distinguished by the relative solubilities of the vapours in the liquid components.

(i.) If the vapour of A be readily soluble in the liquid B, and the vapour of B readily soluble in the liquid A, there will exist a mixture of A and B which will have a lower vapour pressure than any other mixture. The vapour pressure-composition curve will be convex to the axis of compositions, the maximum vapour pressure corresponding to pure A and pure B, and the minimum to some mixture of A and B. On distilling such a mixture under constant pressure, a mixture of the two components (of variable composition) will come over until there remains in the distilling flask the mixture of minimum vapour pressure. This will then distil at a constant temperature. Thus nitric acid, boiling-point 68°, forms a mixture with water, boiling point 100°, which boils at a constant temperature of 126°, and contains 68% of acid. Hydrochloric acid forms a similar mixture which boils at 110° and contains 20.2% of acid. Another mixture of this type is formic acid and water.

(ii.) If the vapours be sparingly soluble in the liquids there will exist a mixture having a greater vapour pressure than that of any other mixture. The vapour pressure-composition curve will now be concave to the axis of composition, the minima corresponding to the pure components. On distilling such a mixture, a mixture of constant composition will distil first, leaving in the distilling flask one or other of the components according to the composition of the mixture. An example is propyl alcohol and water. At one time it was thought that these mixtures of constant boiling-point (an extended list is given in Young's *Fractional Distillation*) were definite compounds. The above theory, coupled with such facts as the variation of the composition of the constant boiling-point fraction with the pressure under which the mixture is distilled, the proportionality of the density of all mixtures to their composition, &c., shows this to be erroneous.

(iii.) If the vapour of A be readily soluble in liquid B, and the vapour of B sparingly soluble in liquid A, and if the vapour pressure of A be greater than that of B, then the vapour pressures of mixtures of A and B will continually diminish as one passes from 100% A to 100% B. The vapour tension may approximate to a linear function of the composition, and the curve will then be practically a straight line. On distilling such a mixture pure A will come over first, followed by mixtures in which the quantity of B continually increases; consequently by a sufficient number of distillations A and B can be completely separated. Examples are water and methyl or ethyl alcohol.

Van't Hoff (*Theoretical and Physical Chemistry*, vol. i. p. 51) illustrates the five cases on one diagram. In fig. 4 let AB be the axis of composition, AP be the vapour pressure of pure A, BQ the vapour pressure of pure B. For immiscible liquids the vapour pressure curve is the horizontal line a_1b_1 , described so that $a_1P = QB$ and $b_1Q = AP$. For partially miscible liquids the curve is Pa_1b_1Q . The horizontal line a_1b_1 corresponds to the two layers of liquid, and the inclined lines Pa_1 , Qb_1 to solutions of B in A and of A in B. The curves Pa_2Q , having a minimum at a_2 , Pa_3Q , having a maximum at a_3 , and Pa_4Q , with neither a maximum nor minimum, correspond to the types i., ii., iii. of completely miscible mixtures.

6. *Dry Distillation*.—In this process the substance operated upon is invariably a solid, the vapours being condensed and collected as in the other methods. When the substance operated upon is of uncertain composition, as, for example, coal, wood, coal-tar, &c., the term destructive distillation is employed. A more general designation is "pyrolytic process," which also includes such operations as leading vapours through red-hot tubes and condensing the products. We may also consider here cases of sublimation wherein a solid vaporizes and the vapour condenses without the occurrence of the liquid phase.

Dry distillation is extremely wasteful even when definite substances or mixtures, such as calcium acetate which yields acetone, are dealt with, valueless by-products being obtained and the condensate usually requiring much purification. Prior to 1830, little was known of the process other than that organic compounds generally yielded tarry and solid matters, but the discoveries of Liebig and Dumas (of acetone from acetates), of Mitscherlich (of benzene from benzoates) and of Perrot (of methane from acetates and lime) brought the operation into common laboratory practice. For efficiency the operation must be conducted with small quantities; caking may be prevented by mixing the substance with sand or powdered pumice, or, better, with iron filings, which also renders the decomposition more regular by increasing the conductivity of the mass. The most favourable retort is a shallow iron pan heated in a sand bath, and provided with a screwed-down lid bearing the delivery tube. Sidney Young has suggested conducting the operation in a current of carbon dioxide which sweeps out the vapours as they are evolved, and also heating in a vapour bath, e.g. of sulphur.

One of the earliest red-hot tube syntheses of importance was the formation of naphthalene from a mixture of alcohol and ether vapours. Such condensations were especially studied by M. P. E. Berthelot, and shown to be very fruitful in forming hydrocarbons.

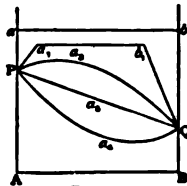

Sometimes reagents are placed in the combustion tube, for example lead oxide (litharge), which takes up bromine and sulphur. In its simplest form the apparatus consists of a straight tube, made of glass, porcelain or iron according to the temperature required and the nature of the reacting substances, heated in an ordinary combustion furnace, the mixture entering at one end and the vapours being condensed at the other. Apparatus can also be constructed in which the unchanged vapours are continually circulated through the tube. Operating in a current of carbon dioxide facilitates the process by preventing overheating.

7. Distillation in Chemical Technology.—In laboratory practice use is made of a fairly constant type of apparatus, only trifling modifications being generally necessary to adapt the apparatus for any distillation or fractionation; in technology, on the other hand, many questions have to be considered which generally demand the adoption of special constructions for the economic distillation of different substances. The modes of distillation enumerated above all occur in manufacturing practice. Distillation in a vacuum is practised in two forms:—if the pump draws off steam as well as air it is termed a "wet" air-pump; if it only draws off air, it is a "dry" air-pump. In the glycerin industry the lyes obtained by saponifying the fats are first evaporated with "wet vacuum" and finally distilled with closed and live steam and a "dry vacuum." Two forms of steam distillation may be distinguished—in one the still is simply heated by a steam coil wound inside or outside the still—this is termed heating by dry steam; in the other steam is injected into the mass within the still—this is the distillation with live steam of laboratory practice. The details of the plant—the material and fittings of the still, the manner of heating, the form of the condensing plant, receivers, &c.—have to be determined for each substance to be distilled in order to work with the maximum economy.

For the distillation of liquids the retort is usually a cylindrical pot placed vertically; cast iron is generally employed, in which case the bottom is frequently incurved and thicker than the sides in order to take up the additional wear and tear. Sometimes linings of enamelled iron or other material are employed, which when worn can be replaced at a far lower cost than that of a new still. Glass stills heated by a sand bath are sometimes employed in the final distillation of sulphuric acid; platinum, and an alloy of platinum and iridium with a lining of gold rolled on (a discovery due to Heraeus), are used for the same purpose. Cast iron stills are provided with a hemispherical head or dome, generally attached to the body of the still by bolts, and of sufficient size to allow for any frothing. It is invariably provided with an opening to carry off the vapours produced. In its more complete form a still has in addition the following fittings:—The dome is provided with openings to admit (1) the axis of the stirring gear (in some stills the stirring gear rotates on a horizontal axis which traverses the side and not the head of the still), (2) the inlet and outlet tubes of a closed steam coil, (3) a tube reaching to nearly the bottom of the still to carry live steam, (4) a tube to carry a thermometer, (5) one or more manholes for charging purposes, (6) sight-holes through which the operation can be watched, and (7) a safety valve. The body of the still is provided with one or more openings at different heights to serve for the discharge of the residue in the still, and sometimes with a glass gauge to record the quantity of matter in the still. For dry distillations the retorts are generally horizontal cylinders, the bottom or lower surface being sometimes flattened. Iron and fireclay are the materials commonly employed; wrought iron is used in the manufacture of wood-spirit, fireclay for coal-gas (see *Gas Manufacture*), phosphorus, zinc, &c. The vertical type, however, is employed in the manufacture of acetone and of iodine.

Several modes of heating are adopted. In some cases, especially in dry distillations, the furnace flames play directly on the retorts, in others, such as in the case of nitric acid, the whole still comes under the action of the furnace gases to prevent condensation on the upper part of the still, while in others the furnace gases do not play directly on the base or upper portion of the still but are conducted around it by a system of flues (see *COAL-TAR*). Steam heating, dry or live, is employed alone and also as an auxiliary to direct firing.

The condensing plant varies with the volatility of the distillate. Air cooling is adopted whenever possible. For example, in the less modern methods for manufacturing nitric acid the vapours were conducted directly into double-necked bottles (*bombonnes*) immersed in water. A more efficient arrangement consists of a stack of vertical pipes standing up from a main or collecting trough and connected at the top in consecutive pairs by a cross tube. By an arrangement of diaphragms in the lower trough the vapours are circulated through the system. As an auxiliary to air cooling the stack may be cooled by a slow stream of water trickling down the outside of the pipes, or, in certain cases, cold water may be injected into the condenser in the form of a spray, where it meets the ascending vapours. Horizontal air-cooling arrangements are also employed. A common type of condenser consists of a copper worm placed in a water bath; but more generally straight tubes of copper or cast iron which cross and recross a rectangular tank are employed, since this form is more readily repaired and cleaned. Wood-spirit, petroleum and coal-tar distillates are condensed in plant of the latter type. In cases where the condenser is likely to become plugged there is a

pipe by means of which live steam can be injected into the condenser. The supply of water to the condenser is regulated according to the volatility of the condensate. When the vapours readily condense to a solid form the condensing plant may take the form of large chambers; such conditions prevail in the manufacture of arsenic, sulphur and lampblack: in the latter case (which, however, is not properly one of distillation) the chamber is hung with sheets on which the pigment collects. Large chambers are also used in the condensation of mercury.

Depletion of the vapours arising from such mixtures as coal-tar fractions, petroleum and the "wash" of the spirit industry, is very important, and many types of apparatus are employed in order to effect a separation of the vapours. The earliest form, invented by C. B. Mansfield to facilitate the fractionation of paraffin and coal-tar distillates, consisted in having a pipe leading from the inclined delivery tube of the still to the still again, so that any vapour which condensed in the delivery tube was returned to the still. Of really effective columns Couper's was one of the earliest. The vapours rising from the still traverse a tall vertical column, and are then conveyed through a series of bulbs placed in a bath kept at the boiling-point of the most volatile constituent. The more volatile vapours pass over to the condensing plant, while the less volatile ones condense in the bulbs and are returned to the column at varying heights by means of connecting tubes. The French column is similar in action. The Coffey still is one of the most effective and is employed in the vertical, ammoniacal coal-tar and other industries. It consists of a vertical column divided into a number of sections by horizontal plates, which are perforated so that the ascending vapours have to traverse a layer of liquid. Above this "separator" is a reflux condenser, termed the "cooler," maintained at the correct temperature so that only the more volatile component passes to the receiver. The success of the operation chiefly depends upon the proper management of the cooler.

8. Commercial Distillation of Water.—Distilled water, *i.e.* water free from salts and to some extent of the dissolved gases which are always present in natural waters, is of indispensable value in many operations both of scientific and industrial chemistry. The apparatus and process for distilling ordinary water are very simple. The body of the still is made of copper, with a head and worm, or condensing apparatus, either of copper or tin. The still is usually fed continuously by the heated water from the condenser. The first portion of the distillate brings over the gases dissolved in the water, ammonia and other volatile impurities, and is consequently rejected; scarcely two-fifths of the entire quantity of water can be safely used as pure distilled water.

Apparatus for the economic production of a potable water from sea-water is of vital importance in the equipment of ships. The simple distillation of sea-water, and the production thereby of a certain proportion of chemically fresh water, is a very simple problem; but it is found that water which is merely evaporated and recondensed has a very disagreeable flat taste, and it is only after long exposure to pure atmospheric air, with continued agitation, or repeated pouring from one vessel to another, that it becomes sufficiently aerated to lose its unpleasant taste and smell and become drinkable. The water, moreover, till it is saturated with gases, readily absorbs noxious vapours to which it may be exposed. For the successful preparation of potable water from sea-water, the following conditions are essential:—1st, aeration of the distilled product so that it may be immediately available for drinking purposes; 2nd, economy of coal to obtain the maximum of water with the minimum expenditure of fuel; and 3rd, simplicity of working parts, to secure the apparatus from breaking down, and enable unskilled attendants to work it with safety. The problem is a comparatively old one, for we find that R. Fitzgerald patented a process in 1683 having for its purpose the "sweetening of sea-water." A history of early attempts is given in S. Hales's *Philosophical Experiments*, published in 1739. Among the earlier of the modern forms of apparatus which came into practical adoption are the inventions of Dr Normandy and of Chaplin of Glasgow, the apparatus of Rocher of Nantes, and that patented by Gallé and Mazeline of Havre. Normandy's apparatus, although economical and producing water of good quality, is very complex in its structure, consisting of very numerous working parts, with elaborate arrangements of pipes, cocks and other fittings. It is consequently expensive and requires careful attention for its working. It was extensively adopted in the British navy, the Cunard line and many other important emigrant and mercantile lines. Chaplin's apparatus, which was invented and patented later, has also since 1865 been sanctioned for use on emigrant, troop and passenger vessels. The apparatus possesses the great merit of simplicity and compactness, in consequence of which it is comparatively cheap and not liable to derangement. It was adopted by many important British and continental shipping companies, among others by the Peninsula & Oriental, the Inman, the North German Lloyd and the Hamburg American companies.

The modern distilling plant consists of two main parts termed the evaporator and the condenser; in addition there must be a boiler (sometimes steam is run off the main boilers, but this practice has several disadvantages), pumps for circulating cold water in the condenser and for supplying salt water to the evaporator, and a filter through which the aerated water passes. The evaporator

consists of a cylindrical vessel having in its lower half a horizontal copper coil connected to the steam supply. The cylindrical vessel is filled to a certain level with salt water and the steam turned on. The water vaporizes and is led from the dome of the evaporator to the head of the condenser. The water level is maintained in the evaporator until it contains a certain amount of salt. It is then run off, and replaced by fresh sea-water. The condenser consists of a vertical cylinder having manifolds at the head and foot and through which a number of tubes pass. In some types, e.g. the Weir, the condensing water circulates upwards through the tubes; in others, e.g. the Quiggins, the water circulates around the tubes. Various forms of the tubes have been adopted. In the Pape-Henneberg condenser, which has been adopted in the German navy, they are oval in section and tend to become circular under the pressure of the steam; in the alteration in shape makes the tubes self-scaling. In the Quiggins condenser, which has been widely adopted, e.g. in the "Luisiania," the steam traverses vertical copper coils tinued inside and outside; the coils are crescent-shaped, a form which gives a greater condensing surface and makes the coils self-scaling. The aeration of the water is effected by blowing air into the steam before it is condensed; as an auxiliary, the storage tanks have a false bottom perforated by fine holes so that if air be injected below it, the water is efficiently aerated by the air which traverses it in fine streams. After condensation the water is filtered through charcoal. The filter is either a separate piece of plant, or, as in the Quiggins form, it may be placed below the coils in the same outer vessel. In this plant the aeration is conducted by blowing in air at the base of the condenser. After filtration the water is pumped to the storage tanks. Many types of distilling plant are in use in addition to those mentioned above, for example the Rayner, Kirkaldy, Merlees, Normand; the United States navy has adopted a form designed by the Bureau of Engineering.

BIBLIOGRAPHY.—The general practice of laboratory distillation is discussed in all treatises on practical organic chemistry; reference may be made to Lassar-Cohn, *Manual of Organic Chemistry* (1896), and *Arbeitsmethoden für organisch-chemische Laboratorien* (1901); Hans Meyer, *Analyse und Konstitutionsermittlung organischer Verbindungen* (1909). The theory of distillation finds a place in all treatises on physical chemistry. Of especial importance is Sidney Young, *Fractional Distillation* (1903). The history of distillation is to be studied in E. Gildemeister and F. Hoffmann, *Die ätherischen Öle* (Berlin, 1899; Eng. tr. by E. Kremers, Milwaukee Press, 1900). The technology of distillation is best studied in relation to the several industries in which it is employed, reference should be made to the articles COAL-TAR, GAS, PETROLEUM, SPIRITS, NITRIC ACID, &c. (C. E.*)

DISTRACTION (from Lat. *distrahere*, to pull asunder), a drawing away or apart; a word now used generally of a state of mind, to mean a diversion of attention, or a violent emotion amounting almost to madness.

DISTRESS (from the O. Fr. *destrece*, *destrresse*, from the past participle of the Lat. *distringere*, to pull apart, used in Late Lat. in the sense of to punish, hence to distract), pressure, especially of sorrow, pain or ill-fortune. As a legal term, the action of distraining or distraint, the right which a landlord has of seizing the personal chattels of his tenant for non-payment of rent. Cattle damage feasant (doing damage or trespassing upon a neighbour's land) may also be *distrained*, i.e. may be detained until satisfaction be rendered for injury they have done. The cattle or other animals thus distrained are a mere pledge in the hands of the injured person, who has only power to retain them until the owner appear to make satisfaction for the mischief they have done. "Distress damage feasant" is also applicable to inanimate things on the land if doing damage thereto or to its produce; things in actual use, however, are exempt. Such distress must be made during the actual trespass, and by whoever is aggrieved by the damage. Distress for rent was also at one time regarded as a mere pledge or security; but the remedy, having been found to be speedy and efficacious, was rendered more perfect by enactments allowing the thing taken to be sold. Blackstone notes that the law of distresses in this respect "has been greatly altered within a few years last past." The legislature, in fact, converted an ancient right of personal redress into a powerful remedy for the exclusive benefit of a single class of creditors, viz. landlords. Now that the relation of landlord and tenant in England has come to be regarded as purely a matter of contract, the language of the law-books seems to be singularly inappropriate. The defaulting tenant is a "wrong-doer," the landlord is the "injured party," any attempt to defeat the landlord's remedy by carrying off distrainable goods is denounced as "fraudulent and knavish." The operation of the law has, as we shall point out,

been mitigated in some important respects, but it still remains an almost unique specimen of one-sided legislation.

At common law distress was said to be incident to *rent service*, and by particular reservation to rent charges; but by 4 Geo. II. c. 28 it was extended to *rent seck*, *rents of assise* and chief rents (see RENT). It is therefore a general remedy for rent certain in arrear. All personal chattels are distrainable with the following exceptions—(1) things in which there can be no property, as animals *ferae naturae*; (2) ledgers, daybooks, title-deeds, &c.; (3) things delivered to a person following a public trade, as a horse sent to be shod, &c., (4) things already in the custody of the law; (5) things which cannot be restored in as good a plight as when distrained, that is, perishable articles; (6) fixtures; (7) beasts of the plough and instruments of husbandry while there is other sufficient distress to be found; (8) instruments of a man's trade or profession in actual use at the time the distress is made. If not in actual use they are only privileged in case there is other sufficient distress upon the premises. These exceptions, it will be seen, imply that the thing distrained is to be held as a pledge merely—not to be sold. They also imply that in general any chattels found on the land in question are to be available for the benefit of the landlord, whether they belong to the tenant or not. This principle worked with peculiar harshness in the case of lodgers, whose goods might be seized and sold for the payment of the rent due by their landlord to his superior landlord. By the Lodgers' Goods Protection Act 1871, however, where a lodger's goods have been seized by the superior landlord the lodger may serve him with a notice stating that the intermediate landlord has no interest in the property seized, but that it is the property or in the lawful possession of the lodger, and setting forth the amount of the rent due by the lodger to his immediate landlord. On payment or tender of such rent the landlord cannot proceed with the distress against the goods in question. By the Law of Distress Amendment Act 1908 this protection was extended to under tenants liable to pay rent by equal quarterly instalments, as well as to any person whatsoever who is not a tenant of the premises or any part thereof nor has any beneficial interest therein. The act, however, excludes certain goods, particularly goods belonging to the husband or wife of the tenant whose rent is in arrear, goods comprised in any bill of sale, hire purchase agreement or settlement made by the tenant, goods in the possession or disposition of a tenant by the consent and permission of the true owner under such circumstances as to make the tenant reputed owner, goods of the partner of an immediate tenant, and goods (not being goods of a lodger) upon premises where any trade or business is carried on in which both the immediate tenant and the under tenant have an interest. The act does not apply where an under tenancy has been created in breach of a covenant or agreement between the landlord and his immediate tenant. The Law of Distress Amendment Act 1888 also absolutely exempted from distress the tools and implements of trade and wearing apparel and bedding of a tenant and his family to the value of five pounds, and the Law of Distress Amendment Act 1895 gave power to a court of summary jurisdiction to direct that such goods, when distrained upon, should be restored if not sold, or, if sold, to order their value to be paid by the persons who levied the distress or directed it to be levied. Originally the landlord could only seize things actually on the premises, so that the remedy might be defeated by the things being taken away. But by an act of 1710, and by the Distress for Rent Act 1737, he may follow things fraudulently or clandestinely removed off the premises within thirty days after their removal, unless they have been in the meantime bona fide sold for a valuable consideration. The sixth exception mentioned above was held to extend to sheaves of corn; but by an act of 1690 corn, when reaped, as well as hay, was made subject to distress. That act was modified by the Landlord and Tenant Act 1851, under which growing crops seized by the sheriff and sold under an execution are liable to distress for rent which becomes due after the seizure and sale, if there is no other sufficient distress on the premises.

Excessive or disproportionate distress exposes the distrainer to an action, and any irregularity formerly made the proceedings

void *ab initio*, so that the remedy was attended with considerable risk. The Distress for Rent Act 1737, before alluded to, in the interests of landlords, protected distresses for rent from the consequences of irregularity. In all cases of distress for rent, if the owner do not within five days (by the Law of Distress Amendment Act 1888, fifteen days, if the tenant make a request in writing to the person levying the distress and also give security for any additional cost that may be occasioned by such extension of time) replevy the same with sufficient security, the thing distrained may be sold towards satisfaction of the rent and charges, and the surplus, if any, must be returned to the owner. To "replevy" is when the person distrained upon applies to the proper authority (the registrar of the county court) to have the thing returned to his own possession, on giving security to try the right of taking it in an action of replevin.

Duties and penalties imposed by act of parliament (e.g. payment of rates and taxes) are sometimes enforced by distress.

DISTRIBUTION (Lat. *distribuere*, to deal out), a term used in various connexions with the general meaning of spreading out. In law, the word is used for the division of the personal estate of an intestate among the next-of-kin (see *INTESTACY*). The important scientific question as to the distribution of plants and animals on the earth is treated under *PLANTS: Distribution*, and *ZOOLOGICAL DISTRIBUTION*. In economics the word is used generally for the transference of commodities from person to person or from place to place, or the dividing up of large quantities of commodities into smaller quantities; and in a more technical sense, for the division of the product of industry amongst the various members or classes of the community. The theory of economic distribution, i.e. the causes which determine rent, wages, profits and interest, forms an important subject-matter in all text-books. Among recent works, see E. Cannan's *History of Theories of Production and Distribution, 1776-1848* (1893), J. R. Compton's *Distribution of Wealth* (1893), and H. J. Davenport's *Value and Distribution* (Chicago, 1908).

DISTRIC, a word denoting in its more general sense, a tract or extent of a country, town, &c., marked off for administrative or other purposes, or having some special and distinguishing characteristics. The medieval Latin *districtus* (from *distringere*, to distract) is defined by Du Cange as *Territorium feudis, seu tractus, in quo Dominus vassallos et tenentes suos distringere potest; and as justitiarum exercendae in eo tractus facultas*. It was also used of the territory over which the feudal lord exercised his jurisdiction generally. It may be noted that *distringere* had a wider significance than "to distract" in the English legal sense (see *DISTRESS*). It is defined by Du Cange as *compellere ad aliquid faciendum per multam, poenam, vel capto pignore*. In English usage, apart from its general application in such forms as postal district, registration district and the like, "district" has specific usages for ecclesiastical and local government purposes. It is thus applied to a division of a parish under the Church Building Acts, originally called a "perpetual curacy," and the church serving such a division is properly a "district chapel." Under the Local Government Act of 1894 counties are divided for the purposes of the act into urban and rural districts. In British India the word is used to represent the *sillah*, an administrative subdivision of a province or presidency. In the United States of America the word has many administrative, judicial and other applications. In South Carolina it was used instead of "county" for the chief division of the state other than in the coast region. In the Virginias, Tennessee, Georgia, Kentucky and Maryland it answers to "township" or precinct, elsewhere the principal subdivision of a county. It is used for an electoral "division," each state being divided into Congressional and senatorial districts; and also for a political subdivision ranking between an unorganized and an organized Territory—e.g., the District of Columbia and Alaska.

DISTYLE (from Gr. *di-*, two, and *stylos*, column), the architectural term given to a portico which has two columns between antae, known as *distyle-in-antis* (see *TEMPLE*).

DITHYRAMSCHEN, or **DITMARSH** (in the oldest form of the name *Thialmaresgaho*, Dietmar's Gau), a territory between the Eider, the Elbe and the North Sea, forming the western part of

the old duchy of Holstein, and now included in the Prussian province of Schleswig-Holstein. It contains about 550 sq. m. with 90,000 inhabitants. The territory consists to the extent of one half of good pasture land, which is preserved from inroads of the sea by banks and dams, the other half being mostly waste. It was originally colonized mainly from Friesland and Saxony. The district was subjugated and Christianized by Charlemagne in 804, and ranked as a separate *Gau*, included perhaps in the countship of Stade, or *Comitatus utriusque ripae*. From the same century, according to one opinion, or from the year 1182, when the countship was incorporated with their see, according to another, the archbishops of Bremen claimed supremacy over the land; but the inhabitants, who had developed and consolidated a systematic organism for self-government, made obstinate resistance, and rather attached themselves to the bishop of Schleswig. Ditmarsken, to use the Scandinavian form of the name, continued part of the Danish dominions till the disastrous battle of Bornhöved in 1227, when its former independence was regained. The claims of the archbishop of Bremen were now so far recognized that he exercised the royal rights of *Heerbann* and *Blutbann*,¹ enjoyed the consequent emoluments, and was represented first by a single *advocatus*, or *Vogt*, and afterwards by one for each of the five *Döffts*, or marks, into which the land was divided after the establishment of Meldorf. The community was governed by a *Landraih* of forty-eight elective consuls, or twelve from each of the four marks; and even in the 14th century the power of the episcopal *advocati* was so slight that a chronicler quoted by Conrad von Maurer says, *De Ditmarschen lesen sunder Heren und Hovedt unde dohn wadt se willen*, "the Ditmarschen live without lord and head, and do what they will." In 1319 and in 1404 they succeeded in defeating the invasions of the Holstein nobles; and though in 1474 the land was nominally incorporated with the duchy by the emperor Frederick III., the attempt of the Danish king Hans and the duke of Gottorp to enforce the decree in 1500 resulted only in their complete rout in the marshes of the Dussend-Düwels-Warf. During the early part of the century which began with such prestige for Ditmarsh, it was the scene of violent internal conflict in regard to the religious questions of the time; and, thus weakened, it was obliged in 1559 to submit to partition among its three conquerors—King Frederick II. of Denmark and Dukes John and Adolphus. A new division took place on Duke John's death in 1581, by which Frederick obtained South Ditmarsh, with its chief town of Meldorf, and Adolphus obtained North Ditmarsh, with its chief town of Heide; and this arrangement continued till 1773, when all the Gottorp possessions were incorporated with the Danish crown.

See Dahlmann's edition of Neocorus, *Chronik von Dithmarschen* (Kiel, 1827), and *Geschichte Dänemarks (1840-1844)*: Michelsen, *Urkundenbuch zur Geschichte des Landes Dithmarschen (1834)*, *Sammlung alldithmarscher Rechtsquellen (1842)*, and *Dithmarschen im Verhältnis zum bremischen Erbstift*; Kolster, *Geschichte Dithmarschens, nach F. R. Dahlmanns Vorlesungen (1873)*.

DITHYRAMBIC POETRY, the description of poetry in which the character of the dithyramb is preserved. It remains quite uncertain what the derivation or even the primitive meaning of the Greek word *δῆθύραμβος* is, although many conjectures have been attempted. It was, however, connected from earliest times with the choral worship of Dionysus. A dithyramb is defined by Grote as a round choric dance and song in honour of the wine-god. The earliest dithyrambic poetry was probably improvised by priests of Bacchus at solemn feasts, and expressed, in disordered numbers, the excitement and frenzy felt by the worshippers. This element of unrestrained and intoxicated vehemence is prominent in all poetry of this class. The dithyramb was traditionally first practised in Naxos; it spread to other islands, to Boeotia and finally to Athens. Arion is said to have introduced it at Corinth, and to have allied it to the worship of Pan. It was thus "merged," as Professor G. G. Murray says, "into the Satyr-choir of wild mountain-goats" out of which sprang the earliest form of tragedy. But when tragic drama had so far developed as to be quite independent, the dithyramb did not, on

¹ That is, the right of claiming military service, and the right of bringing capital offenders to justice.

that account, disappear. It flourished in Athens until after the age of Aristotle. So far as we can distinguish the form of the ancient Greek dithyramb, it must have been a kind of irregular wild poetry, not divided into strophes or constructed with any evolution of the theme, but imitative of the enthusiasm created by the use of wine, by what passed as the Dionysiac delirium. It was accompanied on some occasions by flutes, on others by the lyre, but we do not know enough to conjecture the reasons of the choice of instrument. Pindar, in whose hands the ode took such magnificent completeness, is said to have been trained in the elements of dithyrambic poetry by a certain Lasus of Hermione. Ion, having carried off the prize in a dithyrambic contest, distributed to every Athenian citizen a cup of Chian wine. In the opinion of antiquity, pure dithyrambic poetry reached its climax in a lost poem, *The Cyclops*, by Philoxenus of Cythera, a poet of the 4th century B.C. After this time, the composition of dithyrambs, although not abandoned, rapidly declined in merit. It was essentially a Greek form, and was little cultivated, and always without success, by the Latins. The dithyramb had a spectacular character, combining verse with music. In modern literature, although the adjective "dithyrambic" is often used to describe an enthusiastic movement in lyric language, and particularly in the ode, pure dithyrambs have been extremely rare. There are, however, some very notable examples. The *Baccho in Toscana* of Francesco Redi (1626-1698), which was translated from the Italian, with admirable skill, by Leigh Hunt, is a piece of genuine dithyrambic poetry. *Alexander's Feast* (1698), by Dryden, is the best example in English. But perhaps more remarkable, and more genuinely dithyrambic than either, are the astonishing improvisations of Karl Mikael Bellman (1740-1795), whose Bacchic songs were collected in 1791 and form one of the most remarkable bodies of lyrical poetry in the literature of Sweden. (E. G.)

DITTERS BACH, a town of Germany, in the Prussian province of Silesia, 3 m. by rail S.E. from Waldenburg and 50 m. S.W. from Breslau. It has coal-mines, bleach-fields and match factories. Population (1905) 9371.

DITTSERDORF, KARL DITTSER VON (1739-1799), Austrian composer and violinist, was born in Vienna on the 2nd of November 1739, his father's name being Ditters. Having shown as a child marked talent for the violin, he was allowed to play in the orchestras of St Stephen's and the *Schottenkirche*, where he attracted the attention of a notable patron of music, Prince Joseph Frederick of Hildburghausen (1702-1787), who is also remembered as a soldier for his disastrous leading of the forces of the Empire at Rossbach. The prince gave the boy, now eleven years old, a place in his private orchestra—the first of the kind established in Vienna,—and also saw to it that he received an excellent general education. The Seven Years' War proved disastrous to both music and morals; and young Ditters, who had fallen into evil ways, fled from Hildburghausen, whither he had gone with the prince, to avoid the payment of his gambling debts. His patron generously forgave and recalled him, but soon afterwards gave up his orchestra at Vienna. Ditters now obtained a place in the Vienna opera; but he was not satisfied, and in 1761 eagerly accepted an invitation to accompany Gluck, whose acquaintance, as well as that of Haydn, he had made while in the service of the prince, on a professional journey to Italy. His success as a violinist on this occasion was equal to that of Gluck as composer; and on his return to Vienna he was recognized as the superior of Antonio Lolli, who as virtuoso had hitherto held the palm. In 1764 he was again associated with Gluck in the musical part of the ceremonies at Frankfurt, attending the coronation of the archduke Joseph as King of the Romans. His next appointment was that of conductor of the orchestra of the bishop of Grosswardein, a Hungarian magnate, at Pressburg. He set up a private stage in the episcopal palace, and wrote for it his first "opera buffa," *Amore in musica*. His first oratorio, *Isacco figura del Redentore*, was also written during this time; but the scandal of performances of light opera by the bishop's company, even on fast days and during Advent, outweighed this pious effort; the empress Maria Theresa sharply

called the worldly prelate to order; and he, in a huff, dismissed his orchestra (1769). After a short interlude, Ditters was again in the service of an ecclesiastical patron, count von Schafgotsch, prince bishop of Breslau, at his estate of Johannesberg in Silesia. Here he displayed so much skill as a sportsman, that the bishop procured for him the office of forester (*Forstmeister*) of the principality of Neisse. He had already, by the same influence, been made knight of the Golden Spur (1770). At Johannesberg Ditters also produced a comic opera, *Il Viaggiatore americano*, and an oratorio, *David*. The title rôle of the latter was taken by a pretty Italian singer, Signora Nicolini, whom Ditters married. In 1773 he was ennobled as Karl von Dittersdorf, and at the same time was appointed administrator (*Amishauptmann*) of Freyenwaldau, an office which he performed by deputy. In the same year his oratorio *Ester* was produced in Vienna. During the War of Bavarian Succession the prince bishop's orchestra was dissolved, and Dittersdorf employed himself in his office at Freyenwaldau; but after the peace of Tetschen (1779) he again became conductor of the reconstituted orchestra. From this time forward his output was enormous. In 1780 ten months sufficed for the production of his *Giobbe* (Job) and four operas, three of which were successful; and besides these he wrote a large number of "characterized symphonies," founded on the *Melamorphoses* of Ovid. He was now at the height of his fame, and spent the fortune which it brought him in much luxury. But after a time his patron fell on evil days, the famous orchestra had to be reduced, and when the bishop died in 1795 his successor dismissed the composer with a small money gift. Poor and broken in health, he accepted the asylum offered to him by Ignaz Freiherr von Stülflried, on his estate near Neuhaus in Bohemia, where he spent what strength was left him in a feverish effort to make money by the composition of operas, symphonies and pianoforte pieces. He died on the 1st of October 1799, praying "God's reward" for whoever should save his family from starvation. On his death-bed he dictated to his son his *Lebensbeschreibung* (autobiography).

Dittersdorf's chief talent was for comic opera and instrumental music in the *sonata* forms. In both of these branches his work still shows signs of life, and it is of great historical interest, since he was not only an excellent musician and a friend of Haydn but also a thoroughly popular writer, with a lively enough musical wit and sense of effect to embody in an amusing and fairly artistic form exactly what the best popular intelligence of the times saw in the new artistic developments of Haydn. Thus, while in the amiable monotony and diffuseness of Boccherini we may trace Haydn as a force tending to disintegrate the polyphonic suite-forms of instrumental music, in Dittersdorf on the other hand we see the popular conception of the modern *sonata* and dramatic style. Yet, with all his popularity, the reality of his progressive outlook may be gauged from the fact that, though he was at least as famous a violinist as Boccherini was a violoncellist, there is in his string quartets no trace of that tendency to sacrifice the ensemble to an exhibition of his own playing which in Boccherini's chamber music puts the violoncello into the same position as the first violin in the chamber music of Spohr. In Dittersdorf's quartets (at least six of which are worthy of their survival at the present day) the first violin leads indeed, but not more than is inevitable in such unsophisticated music where the normal place for melody is at the top. The appearance of greater vitality in the texture of Boccherini's quintets is produced merely by the fact that, his special instrument being the violoncello, his displays of brilliance inevitably occur in the inner parts. Six of Dittersdorf's symphonies on the *Melamorphoses* of Ovid were republished in 1890, the centenary of his death. In them we have an amusing and sometimes charming illustration of the way in which at transitional periods music, as at the present day, is ready to make crutches of literature. The end of the representation of the conversion of the Lycian peasants into frogs is prophetically and ridiculously Wagnerian in its ingenious expansion of rhythm and eminently expert orchestration. Every external feature of Dittersdorf's style seems admirably apt for success in German comic opera on a small scale; and an occasional experimental

performance at the present day of his *Doktor und Apotheker* is not less his due than the survival of his best quartets.

See his *Lebensbeschreibung*, published at Leipzig, 1801 (English translation by A. D. Coleridge, 1896); an article in the *Rivista musicale*, vi. 727; and the article "Dittersdorf" in Grove's *Dictionary of Music and Musicians*.

DITTO (from the Lat. *dictum*, something said, Ital. *detto*, aforesaid), that which has been said before, the same thing. The word is frequently abbreviated into "do." In accounts, "ditto" is indicated by two dots or a dash under the word or figure that would otherwise be repeated. A "suit of dittos," a trade or slang phrase, is a suit in which coat, trousers and waistcoat are all of the same material.

DITTON, HUMPHRY (1675-1715), English mathematician, was born at Salisbury on the 29th of May 1675. He studied theology, and was for some years a dissenting minister at Tonbridge, but on the death of his father he devoted himself to the congenial study of mathematics. Through the influence of Sir Isaac Newton he was elected mathematical master in Christ's hospital. He was author of the following memoirs and treatises:—"Of the Tangents of Curves, &c.," *Phil. Trans.* vol. xiii.; "A Treatise on Spherical Catoptrics," published in the *Phil. Trans.* vol. xxiv., from which it was copied and reprinted in the *Acta Eruditorum* (1707), and also in the *Memoirs of the Academy of Sciences at Paris; General Laws of Nature and Motion* (1705), a work which is commended by Wolfius as illustrating and rendering easy the writings of Galileo and Huygens, and the *Principia* of Newton; *An Institution of Fluxions, containing the First Principles, Operations, and Applications of that admirable Method, as invented by Sir Isaac Newton* (1706). In 1709 he published the *Synopsis Algebraica* of John Alexander, with many additions and corrections. In his *Treatise on Perspective* (1712) he explained the mathematical principles of that art; and anticipated the method afterwards elaborated by Brook Taylor. In 1714 Ditton published his *Discourse on the Resurrection of Jesus Christ*; and *The New Law of Fluids, or a Discourse concerning the Ascent of Liquids in exact Geometrical Figures, between two nearly contiguous Surfaces*. To this was annexed a tract ("Matter not a Cogitative Substance") to demonstrate the impossibility of thinking or perception being the result of any combination of the parts of matter and motion. There was also added an advertisement from him and William Whiston concerning a method for discovering the longitude, which it seems they had published about half a year before. Although the method had been approved by Sir Isaac Newton before being presented to the Board of Longitude, and successfully practised in finding the longitude between Paris and Vienna, the board determined against it. This disappointment, aggravated as it was by certain lines written by Dean Swift, affected Ditton's health to such a degree that he died in the following year, on the 15th of October 1715.

DIU, an island and town of India, belonging to Portugal, and situated at the southern extremity of the peninsula of Kathiawar. Area of district, 20 sq. m. Pop. (1900) 14,614. The anchorage is fairly protected from the sea, but the depth of water is only 3 to 4 fathoms. The channel between the island on Diu and the mainland is navigable only by fishing boats and small craft. The town is well fortified on the old system, being surrounded by a wall with towers at regular intervals. Many of the inhabitants are the well-known Banyan merchants of the east coast of Africa and Arabia. Native spirits are distilled from the palm, salt is made and fish caught. The trade of the town, however, is decayed. There are remains of several fine ancient buildings. The cathedral or *Sé Matriz*, dating from 1601, was formerly a Jesuit college. The mint, the arsenal and several convents (now ruined or converted to other uses) are also noteworthy. The Portuguese, under treaty with Bahadur Shah of Gujarat, built a fort here in 1535, but soon quarrelled with the natives and were besieged in 1538 and 1545. The second siege is one of the most famous in Indo-Portuguese history, and is the subject of an epic by Jeronymo Corte Real (q.v.).

See R. S. Whiteway, *Rise of the Portuguese Power in India* (1898).

DIURETICS (from Gr. *dû*, through, and *ôpôis*, pass urine),

the name given to remedies which, under certain conditions, stimulate an increased flow of urine. Their mode of action is various. Some are absorbed into the blood, carried to the secretory organs (the kidneys), and stimulate them directly, causing an increased flow of blood; others act as stimulants through the nervous system. A second class act in congested conditions of the kidneys by diminishing the congestion. Another class, such as the saline diuretics, are effectual by virtue of their osmotic action. A fourth class are diuretic by increasing the blood pressure within the vessels in general, and the Malpighian tufts in particular,—some, as digitalis, by increasing the strength of the heart's contractions, and others, as water, by increasing the amount of fluid circulating in the vessels. Some remedies, as mercury, although not diuretic themselves, when prescribed along with those which have this action, increase their effect. The same remedy may act in more than one way, e.g. alcohol, besides stimulating the secretory organs directly, is a stimulant to the circulation, and thus increases the pressure within the vessels. Diuretics are prescribed when the quantity of urine is much diminished, or when, although the quantity may be normal, it is wished to relieve some other organ or set of organs of part of their ordinary work, or to aid in carrying off some morbid product circulating in the blood, or to hasten the removal of inflammatory serous exudations, or of dropsical collections of fluid. Caffeine, which is far the best true diuretic, acts in nearly every way mentioned above. Together with digitalis it is the most efficient remedy for cardiac dropsy. A famous diuretic pill, known as Guy's pill, consists of a grain each of mercurial pill, digitalis leaves and squill, made up with extract of henbane. Digitalis, producing its diuretic effect by its combined action on heart, vessels and kidneys, is much used in the oedema of mitral disease, but must be avoided in chronic Bright's disease, as it increases the tension of the pulse, already often dangerously high. Turpentine and cantharides are not now recommended as diuretics, as they are too irritating to the kidneys.

DIURNAL MOTION, the relative motion of the earth and the heavens, which results from the rotation of our globe on its axis in a direction from west toward east. The actual motion consists in this rotation. But the term is commonly applied to the resultant apparent revolution of the heavens from east to west, the axis of which passes through the celestial poles, and is coincident in direction with the axis of the earth.

DIVAN (Arabic *dīwān*), a Persian word, derived probably from Aramaic, meaning a "counting-house, office, bureau, tribunal"; thence, on one side, the "account-books and registers" of such an office, and, on another, the "room where the office or tribunal sits"; thence, again, from "account-book, register," a "book containing the poems of an author," arranged in a definite order (alphabetical according to the rhyme-words), perhaps because of the saying, "Poetry is the register (*dīwān*) of the Arabs," and from "bureau, tribunal," "a long seat, formed of a mattress laid against the side of the room, upon the floor or upon a raised structure or frame, with cushions to lean against" (Lane, *Lexicon*, 930 f.). All these meanings existed and exist, especially "bureau, tribunal," "book of poems" and "seat"; but the order of derivation may have been slightly different. The word first appears under the caliphate of Omar (A.D. 634-644). Great wealth, gained from the Moslem conquests, was pouring into Medina, and a system of business management and administration became necessary. This was copied from the Persians and given the Persian name, "divan." Later, as the state became more complicated, the term was extended over all the government bureaux. The divan of the Sublime Porte was for long the council of the empire, presided over by the grand vizier.

See Von Kremer, *Culturgeschichte des Orients*, i. 64, 198.

(D. B. MA.)

¹ The divan in this sense has been known in Europe certainly since about the middle of the 18th century. It was fashionable, roughly speaking, from 1820 to 1850, wherever the romantic movement in literature penetrated. All the boudoirs of that generation were garnished with divans; they even spread to coffee-houses, which were sometimes known as "divans" or "Turkish divans"; and a "cigar divan" remains a familiar expression.

down together, each cylinder supplies air independently of the other; and when it is required to send one diver into deep water, the two cylinders are connected and the full volume of air from both is delivered to the one man. The same duty is also performed by a four-cylinder single-acting pump. Smaller pumps, having one double-acting or two single-acting cylinders, are also used for shallow water work.

In most cases these air pumps are worked by manual power; this method of working is rendered necessary by the fact that the machines are usually placed in small boats from which the divers work and on which other motive power is not available. In cases, however, where steam or electric power is available the pumps are sometimes worked by their means—more particularly on harbour and dock works. In such instances the air is not delivered direct from the pump to the diver, but is delivered into an intermediate steel receiver to which the diver's air pipe is connected, the object

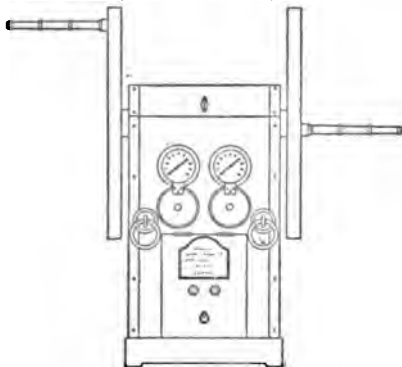

FIG. 2.—Pump in chest, ready for work.

being to ensure a reserve supply of air in case of a breakdown of the pump. Some of these combinations of pumps and motors are so arranged that, in the event of an accident to the motor, the pump can be thrown out of gear with it, and be immediately worked by hand power. Each pump is fitted with a gauge (or gauges), indicating not only the pressure of air which the pump is supplying, but also the depth of water at which the diver is working. The cylinders are water-jacketed to ensure the air delivered to the diver being cool, the water being drawn in and circulated round the cylinders by means of a small metal pump worked from an eccentric on the main crank-shaft. Filters are sometimes attached to the suction and delivery sides of the pumps to ensure the inlet of air being free from dirt, and the discharge of air free from dirt and oil.

Helmet.—The helmet and breastplate (fig. 3) are made from highly polished tinned copper, with gun-metal valves and other fittings. The helmet is provided with a non-return air inlet valve to which the diver's air pipe is connected; the air when it lifts the inlet valve passes through three conduits—one having its outlet over the front glass, the others their outlets over the side glasses. In this way the diver gets the air fresh as it enters the helmet, and at the same time it prevents condensation of his breath on the glasses and keeps them clear. There is a regulating air outlet valve by which the diver adjusts his supply of air according to his requirements in different depths of water; the valve is usually made to be adjusted by hand, but sometimes it is so constructed as to be operated by the diver knocking his head against it, the spindle being extended through to the inside of the helmet and fitted at its inner extremity with a button or disk. By unscrewing the valve, the diver allows air to escape, and thus the dress is deflated; by screwing it up the air is retained and the dress inflated. Thus the diver can control his specific gravity and rise or sink at will. In case by any chance the diver should inflate the dress inadvertently, and wish to get rid of the superfluous air quickly, he can do so by opening an emergency cock, which is fitted on the helmet. Plate glasses in gun-metal frames are also fitted to the helmet, two, one on each side, being permanently fixed, while one in front is made either to screw in and out, or to work on a hinged joint like a ship's scuttle; the side glasses are usually protected by metal cross-bars, as is also sometimes the front glass. Some divers prefer unprotected glasses at the side of the helmet, instead of protected oval ones.

The breastplate is fitted on its outer edge with metal screws and bands. The disposition of the screws corresponds with that of the holes in the india-rubber collar of the diving dress described below. There are other methods of making a watertight joint between the diver's breastplate and the diving dress, but, as these are only mechanical differences, it will suffice to describe the Siebe-Gorman apparatus, as exclusively adopted by the British government.

Whatever the shape or design of the helmet or dress, Siebe's principle is the one in universal use to-day.

The metal tabs are for carrying the diver's lead weights, which are fitted with suitable clips; the hooks—one on each side of the helmet—are for keeping the ropes attached to the back weight in position. The helmet and breastplate are fitted at their lower and upper parts respectively with gun-metal segmental neck rings, which make it possible to connect these two main parts together by one-eighth of a turn, a catch at the back of the helmet preventing any chance of unscrewing. The small eyes at the top of the helmet are for securing the diver's air pipe and life line in position and preventing them from swaying.

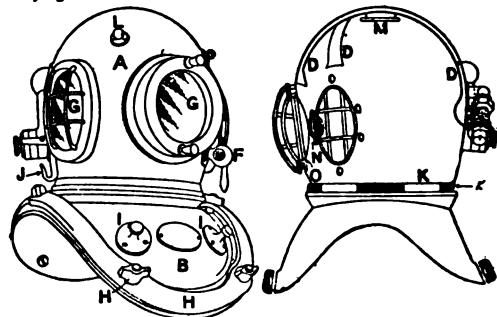

Front view of Helmet.

Side sectional view of Helmet.

- A, Helmet.
- B, Breastplate.
- F, Emergency cock.
- G, Glasses in frames.
- H, Metal screws and bands.
- J, Metal tabs.
- K, Segmental neck rings.
- D, Air conduits.
- M, Telephone receiver.
- N, Transmitter.
- O, Contact piece to ring bell.
- I, Hooks for keeping weight ropes in position.
- L, Eyes to which air pipe and life line are secured.

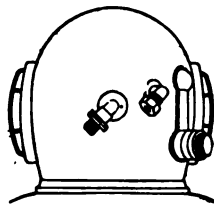

Back view of Helmet.

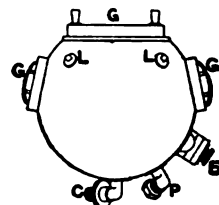

Plan of Helmet.

- C, Air inlet valve.
- E, Regulating outlet valve.
- G, Glasses in frames.
- L, Eyes to which air pipe and life line are secured.
- P, Connexion for telephone cable.

FIG. 3.

The *Diving Dress* is a combination suit which envelops the whole body from feet to neck. It is made of two layers of tanned twill with pure rubber between, and is fitted at the neck with a vulcanized india-rubber collar, or band, with holes punched in it corresponding to the screws in the breastplate. This collar, when clamped tightly between the bands and the breastplate by means of the nuts, ensures a watertight joint. The sleeves of the dress are fitted with vulcanized india-rubber cuffs, which, fitting tightly round the diver's wrists, prevent the ingress of water at these parts also.

Boots.—These are generally made with leather uppers, beechwood inner soles and leaden outer soles, the latter being secured to the others by copper rivets. Heavy leather straps with brass buckles secure the boot to the foot. Each boot weighs about 16 lb. Sometimes the main part of the boot-golosh, toe and heel, are in one brass casting, with leather upper part, heavy straps and brass buckles.

Lead Weights.—These weigh 40 lb each, and the diver wears one on his back, another on his chest. These weights and the heavy boots ensure the diver's equilibrium when under water.

Belt and Knife and Small Tools.—Every diver wears a heavy waist-belt in which he carries a strong knife in metal case, and sometimes other small tools.

Air Pipe.—The diver's air pipe is of a flexible, non-collapsible description, being made of alternate layers of strong canvas and vulcanized india-rubber, with steel or hard drawn metal wire embedded. At the ends are fitted gun-metal couplings, for connecting the pipe with the diver's pump and helmet.

Signal Line.—The diver's signal line (sometimes called life line) consists of a length of reverse laid Manila rope. In cases where the telephone apparatus is not used, the diver gives his signals by means of a series of pulls on the signal line in accordance with a prearranged code.

Telephonic Apparatus.—Without doubt one of the most useful adjuncts to the modern diving apparatus is the loud-sounding telephone (fig. 4), introduced by Siebe, Gorman & Co., which enables the diver to communicate viva voce with his attendant, and vice versa. In the British navy the type of submarine telephonic apparatus used is the Graham-Davis system. This is made on two plans, (1) a single set of instruments, for communication between one diver and his attendant direct, (2) an intercommunication set which is used where two divers are employed. With this type the attendant can speak to No. 1 or No. 2 diver separately, or with both at the same time, and vice versa; and No. 1 can be put in communication with No. 2 whilst they are under water, the attendant at the surface being able to hear what the men are saying. The advantages of such a system are obvious. It is more particularly useful where two divers are working one either side of a ship, or where the divers may be engaged upon the same piece of work, but out of sight of one another, or out of touch. It would prove its utility in a marked degree in cases where a diver gets into difficulties; a second diver sent down to his assistance could receive and give verbal directions and thus greatly expedite the work of rescue.

The telephone instruments in the helmet consist of one or more loud-sounding receivers placed either in the crown of the helmet, or one on each side in close proximity to the diver's ears. A transmitter of a special watertight pattern is placed between the front glass and one of the side glasses, and a contact piece, which, when the diver presses his chin against it, rings a bell at the surface, is fitted immediately below the front glass. A buzzer is sometimes fixed in the helmet to call the diver's attention when the attendant wishes to speak, but as a rule the voice is transmitted so loudly that this device is unnecessary. A connexion, through which the insulated wires connecting the instruments pass, terminates in contact pieces, and the telephone cable, embedded in the diver's signal line, is connected with it. The other end of the signal line is connected to a battery box at the surface. This box contains, besides the cells, a receiver and transmitter for the attendant, an electric bell, a terminal box, and a special switch, by means of which various communications between diver, or divers, and attendant are made. If, as is sometimes the case, the diver happens to be somewhat deaf, he can, whilst he is taking a message, stop the vibration of the outlet valve and the noise made by the escaping air, by merely pressing his finger on a spindle which passes through the disk of the valve, and thus momentarily ensure absolute silence.



FIG. 4.—Diver's Telephone Communication with the Surface.
Q, Battery, with switch and bell in case.
R, Attendant's receiver and transmitter.

Speaking Tube.—The rubber speaking tube which was the forerunner of the telephonic apparatus is now practically obsolete, though it is still used in isolated cases.

Submarine Electric Lamps.—Various forms of submarine lamps are used, from a powerful arc light to a self-contained hand lamp, the former giving about 2000 or 3000 candle-power, and requiring a steam-driven dynamo to supply the necessary current, the latter (fig. 5) giving a light of about 10 candle-power and having its own batteries, so that the diver carries both the light and its source in his hand. These submarine lamps are all constructed on the same principle, having the incandescent lamps, or carbons as the case may be, enclosed in a strong glass globe, the mechanism and connexions being fitted in a metal case above the globe, which is flanged and secured watertight to the case.

Self-contained Diving Dress.—The object of the self-contained diving dress is to make the diver independent of air supply from the surface. The dress, helmet, boots and weights are of the ordinary pattern already described, but instead of obtaining his air supply by means of pumps and pipes, the diver is equipped with a knapsack consisting of a steel cylinder containing oxygen compressed to a pressure of 120 atmospheres (= about 1800 lb) to the square inch, and chambers containing caustic soda or caustic potash. The helmet is connected to the chambers by tubes, and the oxygen

cylinder is similarly connected to the chambers. The breath exhaled by the diver passes through a valve into the caustic soda, which absorbs the carbonic acid, and it is then again inhaled through another valve. This process of regeneration goes on automatically, the requisite amount of oxygen being restored to the breathed air in its passage through the chambers. This type of apparatus has been used for shallow water work, but the great majority of divers prefer the apparatus using pumps as the source of the air supply.

An emergency dress, using this self-contained system for breathing, has been designed by Messrs Fleuss and Davis, of the firm of Siebe, Gorman & Co., primarily as a life-saving apparatus, for enabling men to escape from disabled submarine boats.

The helmet diver is indispensable in connexion with harbour and dock construction, bridge-building, pearl and sponge fishing, wreck

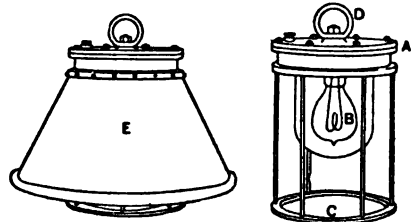

FIG. 5.—Submarine Electric Lamp, with and without Reflector.

- A, Metal case containing electrical fittings.
- B, Glass globe and incandescent lamp.
- C, Stand, which also protects the globe.
- D, Ring for suspending lamp.
- E, Reflector.

raising and the recovery of sunken cargo and treasure. Every ship in the British navy carries one set or more of diving apparatus, for use in case of emergency, for clearing fouled propellers, cleaning valves or ship's hull below the water line, repairing hulls if necessary, and recovering lost anchors, chains, torpedoes, &c.

Greatest Depths attained.—The greatest depth at which useful work has been performed by a diver is 182 ft. From this depth a Spanish diver, Angel Erostarbe, recovered 9000 in silver bars from the wreck of the steamer "Skyro," sunk off Cape Finisterre; Alexander Lambert succeeded in salvaging 70,000 from the Spanish mail steamer "Alphonso XII," sunk in 162 ft. of water off Las Palmas, Grand Canary; W. Ridyard recovered £50,000 in silver dollars from the "Hamilton Mitchell," sunk off Leuconna Reef, China, in 150 ft. There are individual cases where much larger sums have been recovered, but those mentioned are particularly notable by reason of the great depth involved and stand out as the greatest depths at which good work has been done. The sponge fishers of the Mediterranean work at a maximum depth of about 150 ft., and the pearl divers of Australia at 120 ft. But submarine operations on the great majority of the harbour and dock works of the world are conducted at a depth of from 30 to 60 ft.

The weighted tools employed by divers differ very little from those used by the workmen on *terra firma*. Pneumatic tools, worked by compressed air conveyed from the surface through flexible tubes, are great aids, particularly in rock removal work. With the rock drill the diver bores a number of holes to a given depth, inserts in these the charges of dynamite or other explosive used, attaches one end of a wire to a detonator which is inserted in the charge, and then comes to the surface. The boat from which he works is then moved away from the scene of operations, paying out the wire attached to the detonators, and when at a safe distance the free end of the wire is connected to a magnet explosive machine, which is then set in motion.

A complete set of diving apparatus costs from £75 to £200, varying with the depth of water for which it is required.

The pay of a diver depends upon the nature of the work upon which he is engaged, and also upon the depth of the water. On harbour and dock work the average wage is 2s. to 2s. 6d. per hour; on wreck work from 3s. to 5s. an hour, according to depth; on treasure and cargo recovery so much per day, with a percentage on the value recovered, generally about 5%. The pearl fishers of Australia get so much per ton of shell, and the sponge fishers are also paid by results.

A problem which has been exercising the minds of those engaged in submarine work is the greatest depth at which it is possible to work, for, as is well known, many a fine vessel with valuable cargo and treasure is lying out of reach of the diver owing to the pressure which he would have to sustain were he to attempt to reach her. Mr Leonard Hill, and Drs Greenwood and J. J. R. Macleod conducted experiments in conjunction with Messrs Siebe, Gorman & Co., with a view to solving this problem, and their efforts have been attended with some considerable success. Dr J. S. Haldane has also carried out practical experiments for the British Admiralty, and under his supervision two naval officers have succeeded in reaching the unprecedented depth of 210 ft., at which depth the pressure is about 90 lb to the square inch.

Diving Bells.—Every one is familiar with the experiment of placing an inverted tumbler in a bowl of water, and seeing the water excluded from the tumbler by the air inside it. Perhaps it was to some such experiment as this that the conception of the diving bell was due. As is well known, the pressure of water increases with the depth, and for all practical purposes this pressure can be taken at $4\frac{1}{2}$ lb to every 10 ft. The following table shows the pressure at different depths below the surface of the water:—

Depth.	Pressure.
20 ft.	8 $\frac{1}{2}$ lb to the sq. in.
40 "	17 "
60 "	25 $\frac{1}{2}$ "
120 "	52 "
160 "	69 $\frac{1}{2}$ "
200 "	87 "

If a diving bell is sunk to a depth of, say, 33 ft., the air inside it will be compressed to about half its original volume, and the bell itself will be about half filled with water. But if a supply of air be maintained at a pressure equal to the depth of water at which the bell is submerged, not only will the water be kept down to the cutting edge, but the bell will be ventilated and it will be possible for its occupants to work for hours at a stretch.

Tradition gives Roger Bacon, in 1250, the credit for being the originator of the diving bell, but actual records are lost in antiquity. Of the records preserved to us, probably one of the most trustworthy is an account given in Kaspar Schott's work, *Technica curiosa*, published in the year 1604, which quoted from one John Taisnier, who was in the service of Charles V. This account describes an experiment which took place at Toledo, Spain, in the year 1538, before the emperor and some thousands of spectators, when two Greeks descended into the water in a large "kettle," suspended by ropes, with its mouth downwards. The "kettle" was equiposed by lead fixed round its mouth. The men came up dry, and a lighted candle, which they had taken down with them, was still burning.

Francis Bacon, in the *Novum Organum*, lib. ii., makes the following reference to a machine, or reservoir, of air to which labourers upon wrecks might resort whenever they required to take breath:—

"A hollow vessel, made of metal, was let down equally to the surface of the water, and thus carried with it to the bottom of the sea the whole of the air which it contained. It stood upon three feet—like a tripod—which were in length something less than the height of a man, so that the diver, when he was no longer able to contain his breath, could put his head into the vessel, and having filled his lungs again, return to his work."

But it was to Dr Edmund Halley, secretary of the Royal Society, that undoubtedly the honour is due of having invented the first really practical diving bell. This is described in the *Philosophical Transactions*, 1717, in a paper on "The Art of Living Under Water by means of furnishing air at the bottom of the sea in any ordinary depth." Halley's bell was constructed of wood, and was covered with lead, which gave it the necessary sinking weight, and was so distributed as to ensure that it kept a perpendicular position when in the water. It was in the form of a truncated cone, 3 ft. in diameter at the top, 5 ft. at the bottom and 8 ft. high. In the roof a lens was introduced for admitting light, and also a tap to let out the vitiated air. Fresh air was supplied to the bell by means of two lead-lined barrels,

each having a bung-hole in the top and bottom. To the hole in the top was fixed a leathern tube, weighted in such a manner that it always fell below the level of the bottom of the barrel so that no air could escape. When, however, the tube was turned up by the attendant in the bell, the pressure of the water rising through the hole in the bottom of the barrel, forced the air through the tube at the top and into the diving bell. These barrels were raised and lowered alternately, with such success that Halley says that he, with four others, remained at the bottom of the sea, at a depth of 9 to 10 fathoms, for an hour and a half at a time without inconvenience of any sort.

This type of bell was used by John Smeaton in repairing the foundations of Hexham Bridge in 1778, but instead of weighted

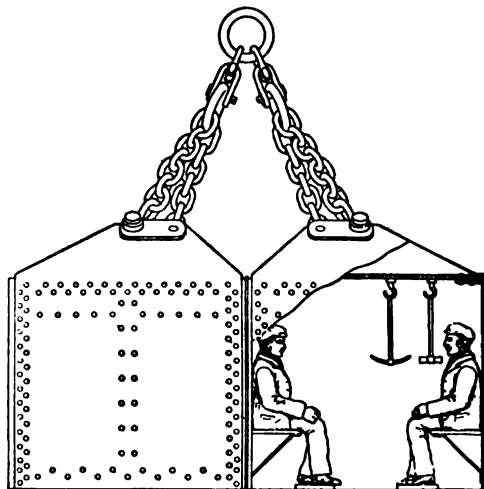

FIG. 6.—Ordinary Diving Bell.

barrels, he introduced a force pump for supplying the necessary air. To Smeaton too we are indebted for the first diving bell plant in the form with which we are familiar to-day, that celebrated engineer having designed a square bell of iron, for use on the Ramsgate harbour works, in 1788. This bell, which measured 4 $\frac{1}{2}$ ft. in length, 3 ft. in width and 4 $\frac{1}{2}$ ft. in height, and weighed 2 $\frac{1}{2}$ tons, was made sufficiently heavy to sink by its own weight. It afforded room enough for two men to work, and was supplied with air by a force pump worked from a boat at the surface.

Though the diving bell has been largely superseded by the modern diving apparatus, it is still used on certain classes of work the magnitude of which justifies the expense entailed, for it is not only a question of the cost of the bell, but of the powerful steam-driven crane which is needed to lower and raise it, and also of the gantry on which the crane travels. Sometimes a barge or other vessel is used for working the bell.

At the present day, two types of diving bell are employed—the ordinary bell, and the air-lock bell, which, however, is not so largely used.

On the new national harbour works at Dover, four large diving bells of the ordinary type (fig. 6) were employed. These bells, in each of which from four to six men descended at a time, consisted of steel chambers, open at the bottom, measuring 17 ft. long by 10 $\frac{1}{2}$ ft. wide by 7 ft. high, and each weighed 35 tons. The ballast, which at once gives the necessary sinking weight to the bell and maintains its equilibrium, consisted of slabs of cast iron bolted to the walls of the bell, inside. Each bell was fitted with lead-sounding telephonic apparatus, by means of which the occupants could communicate either with the men attending the crane or the men looking after the air compressors at the surface. Electric lamps, supplied with current by a dynamo in the compressor room, gave the necessary light inside the bell. Seats and foot rails were provided for the men, and there were racks and hooks for the various tools. Suspended from the roof was an iron skip into which the men threw the

excavated material, which was emptied out when the bell was brought to the surface. Air was supplied to the bells by means of steam-driven compressors worked in a house erected on the gantry. The air was delivered into a steel air receiver, and thence it passed through a flexible tube connected to a gun-metal inlet valve in the roof of the diving bell; the pressure of air was regulated according to the depth at which the bell happened to be working. The maximum depth on the Dover works was between 60 and 70 ft.,—about 25-30 lb to the square inch. A bell was lowered by means of powerful steam-driven cranes, travelling on a gantry, to within a few feet of the water, and the men entered it from a boat. The bell then continued its descent to the bottom, where the men, with pick and shovel, levelled the sea bed ready to receive the large concrete blocks, weighing from

closing the door after them. When returning to the surface they reverse the operation. It can readily be imagined that, owing to its unwieldy character, the employment of the air-lock bell is resorted to only in those cases where the nature of the sea bed necessitates its remaining on a given spot for some considerable time, as for instance in the excavation of hard rock to a given depth.

An air-lock bell supplied to the British Admiralty, for use in connexion with the laying of moorings at Gibraltar, has a working chamber measuring 15 ft. long by 104 ft. wide, by 74 ft. high, and a shaft 37½ ft. high by 3 ft. in diameter. It is built of steel plates, with cast-iron ballast, and its total weight is about 46 tons. The bell is electrically lighted, and is fitted with telephonic apparatus communicating with the air-compressor room and lifting-winch room. It is worked through a well in the centre of a specially constructed steel barge 85 ft. long by 40 ft. beam, having a draught of 7 ft. 6 in. The wire ropes, for lowering and raising the bell, work over pulleys which are carried on a superstructure erected over the well. Two sets of air compressors are fitted on the barge—one set for supplying air to the bell, the other set for working a pneumatic rock drill inside the bell. The greatest depth at which this particular bell will work is 40 ft. The cost of the whole plant, including barge, was about £14,000.

The diving dress has, however, to a great extent supplanted the diving bell. This is due not only to the heavier cost of the latter, but more particularly to the greater mobility of the helmet diver. Bell divers are naturally limited to the area which their bell for the time being covers, whereas helmet divers can be distributed over different parts of a contract and work entirely independently of one another. The use of the diving bell is, therefore, practically limited to the work of levelling the sea bed, and the removal of rock.

See also the article CAISSON DISEASE as regards the physiological effects of compressed air. (R. H. D. 5)

DIVES-SUR-MER, a small port and seaside resort of north-western France on the coast of the department of Calvados, on the Dives, 15 m. N.E. of Caen by road. Pop. (1906) 3286. Dives is celebrated as the harbour whence William the Conqueror sailed to England in 1066. In the porch of its church (14th and 15th centuries) a tablet records the names of some of his companions. The town has a picturesque inn, adapted from a building dating partly from the 16th century, and market buildings dating from the 14th to the 16th centuries. The coast in the vicinity of Dives is fringed with small watering-places, those of Cabourg (to the west) and of Beuzeval and Houlgate (to the east) being practically united with it. There are large metallurgical works with electric motive power close to the town.

DIVIDE, a word used technically as a noun in America and the British colonies for any high ridge between two valleys, forming a water-parting; a dividing range. For special senses of the verb "to divide" (Lat. *di-videre*, the latter part of the word coming from a root seen in Lat. *vidua*, Eng. "widow"), meaning generally to split up in two or more parts, see **DRIVISION**. In a parliamentary sense, to divide (involving a separation into two sides, Aye and No) is to take the sense of the House by voting on the subject before it.

DIVIDEND (Lat. *dividendum*, a thing to be divided), the net profit periodically divisible among the proprietors of a joint-stock company in proportion to their respective holdings of its capital. Dividend is not interest, although the word dividend is frequently applied to payments of interest; and a failure to pay dividends to shareholders does not, like a failure to pay interest on borrowed money, lay a company open to being declared bankrupt. In bankruptcy a dividend is the proportionate share of the proceeds of the debtor's estate received by a creditor. In England, the Companies Act 1862 provided that no dividend should be payable except out of the profits arising from the business of the company, but, in the case of companies incorporated by special act of parliament for the construction of railways and other public works which cannot be completed for a considerable time, it is sometimes provided that interest may during construction be paid to the subscribers for shares out of capital. Dividends (excluding occasional distributions in the form of shares) are ordinarily payable in cash. Most companies divide their capital into at least two classes, called "preference" shares and "ordinary" shares, of which the former are entitled out of the profits of the company to a preferential dividend at a fixed rate, and the latter to whatever remains after payment of the preferential dividend and any fixed charges. Before, however, a dividend is paid, a part of the profits is often carried to a "reserve

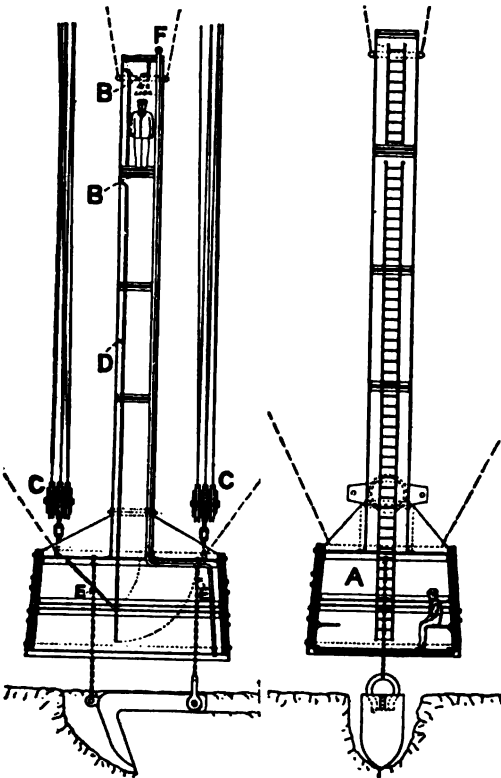

Fig. 7.—Air-lock Diving Bell.

- A, Working chamber.
- B, Air-lock.
- C, Pulleys and wire ropes for lowering and raising bell.
- D, Iron ladder.
- E, Tackles suspended from roof for raising and lowering objects.
- F, Air supply pipe.

30 to 42 tons apiece. Having completed one section, the bell was moved along to another. The concrete blocks were then lowered and placed in position by helmet divers. The bell divers, clad in thick woollen suits and watertight thigh boots, worked in shifts of about three hours each, and were paid at the rate of from 1s. to 15d. per hour.

The cost of an ordinary diving bell, including air compressor, telephonic apparatus and electric light, is from £600 to £1500, according to size.

The *Air-lock Diving Bell* (fig. 7) comprises an iron or steel working chamber similar to the ordinary diving bell, but with the addition of a shaft attached to its roof. At the upper end of the shaft is an air-tight door, and about 8 ft. below this is another similar door. When the bell divers wish to enter the bell, they pass through the first door and close it after them, and then open a cock or valve and gradually let into the space between the two doors compressed air from the working chamber in order to equalize the pressure; they then open the second door and pass down into the working chamber,

fund." The dividend on preference shares is either "cumulative" or contingent on the profits of each separate year or half year. When cumulative, if the profits of any one year are insufficient to pay it in full, the deficiency has to be made good out of subsequent profits. A cumulative preferential dividend is sometimes said to be "guaranteed," and preferential dividends payable by all English companies registered under the Companies Acts 1862 to 1908 are cumulative unless stipulated to be otherwise. Certain public companies are forbidden by parliament to pay dividends in excess of a prescribed maximum rate, but this restriction has been happily modified in some instances, notably in the case of gas companies, by the institution of a sliding scale, under which a gas company may so regulate the price of gas to be charged to consumers that any reduction of an authorized standard price entitles the company to make a proportionate increase of the authorized dividend, and any increase above the standard price involves a proportionate decrease of dividend. Dividends are usually declared yearly or half-yearly; and before any dividend can be paid it is, as a rule, necessary for the directors to submit to the shareholders, at a general meeting called for the purpose, the accounts of the company, with a report by the directors on its position and their recommendation as to the rate of the proposed dividend. The articles of association of a company usually provide that the shareholders may accept the director's recommendation as to dividend or may declare a lower one, but may not declare a higher one than the directors recommend. Directors frequently have power to pay on account of the dividend for the year, without consulting the shareholders, an "interim dividend," which on ordinary shares is generally at a much lower rate than the final or regular dividend. An exceptionally high dividend is often distributed in the shape of a dividend at the usual rate supplemented by an additional dividend or "bonus." Payment of dividends is made by means of cheques sent by post, called "dividend warrants." All dividends are subject to income-tax, and by most companies dividends are paid "less income-tax," in which case the tax is deducted from the amount of dividend payable to each proprietor. When paid without such deduction a dividend is said to be "free of income-tax." In the latter case, however, the company has to make provision for payment of the tax before declaring the dividend, and the amount of its divisible profits and the rate of dividend which it is able to declare are consequently to that extent reduced. In respect of consols and certain other securities, holders of amounts of less than £1,000 may instruct the Bank of England or Bank of Ireland to receive and invest their dividends. With few exceptions, the prices of securities dealt in on the London Stock Exchange include any accruing dividend not paid up to the date of purchase. At a certain day, after the dividend is declared, the stock or share is dealt in on the Stock Exchange, as *ex dividend* (or "x. d."), which means that the current dividend is paid not to the buyer but to the previous holder, and the price of the stock is lower to that extent. The expression "cum dividend" is used to signify that the price of the security dealt in includes a dividend which, in the absence of any stipulation, might be supposed to belong to the seller of the security. On the New York Stock Exchange the invariable practice is to sell stock with the "dividend on" until the company's books are closed, after which it is usually sold "ex dividend." (S. D. H.)

DIVIDIVI, the native and commercial name for the astringent pods of *Caesalpinia coriaria*, a leguminous shrub of the suborder *Caesalpinieae*, which grows in low marshy tracts in the West Indies and the north of South America. The plant is between 20 and 30 ft. in height, and bears white flowers. The pods are flattened, and curl up in drying; they are about $\frac{1}{2}$ in. broad, from 2 to 3 in. long and of a rich brown colour. Dividivi was first brought to Europe from Caracas in 1768. It contains about 30% of ellagitanic acid, whence its value in leather manufacture.

DIVINATION, the process of obtaining knowledge of secret or future things by means of oracles, omens or astrology. The root of the word, *divus* (god) or *divus*, indicates the supposed source of the soothsayer's information, just as the equivalent Greek term, *μῦθος*, indicates the spiritual source of the utterances of the seer,

μῦθος. In classical times the view was, in fact, general, as may be seen by Cicero's *De divinatione*, that not only oracles but also omens were signs sent by the gods; even the astrologer held that he gained his information, in the last resort, from the same source. On the side of the Stoics it was argued that if divination was a real art, there must be gods who gave it to mankind; against this it was argued that signs of future events may be given without any god.

Divination is practised in all grades of culture; its votaries range from the Australian black to the American medium. There is no general agreement as to the source of the information; commonly it is held that it comes from the gods directly or indirectly. In the Bornean cult of the hawk it seems that the divine bird itself was regarded as having a foreknowledge of the future. Later it is regarded as no more than a messenger. Among the Australian blacks, divination is largely employed to discover the cause of death, where it is assumed to be due to magic; in some cases the spirit of the dead man is held to give the information, in others the living magician is the source of the knowledge. We find moreover as emi-scientific conception of the basis of divination; the whole of nature is linked together; just as the variations in the height of a column of mercury serve to foretell the weather, so the flight of birds or behaviour of cattle may help to prognosticate its changes; for the uncultured it is merely a step to the assumption that animals know things which are hidden from man. Haruspication, or the inspection of entrails, was justified on similar grounds, and in the case of omens from birds or animals, no less than in astrology, it was held that the facts from which inferences were drawn were themselves in part the causes of the events which they foretold, thus fortifying the belief in the possibility of divination.

From a psychological point of view divinatory methods may be classified under two main heads: (A) autoscopic, which depend simply on some change in the consciousness of the soothsayer; (B) heteroscopic, in which he looks outside himself for guidance and perhaps infers rather than divines in the proper sense.

(A) Autoscopic methods depend on (i.) sensory or (ii.) motor automatisms, or (iii.) mental impressions, for their results. (i.) *Crystal-gazing* (*q.v.*) is a world-wide method of divining, which is analogous to dreams, save that the vision is voluntarily initiated, though little, if at all, under the control of the scryer. Corresponding to crystal-gazing we have *shell-hearing* and similar methods, which are, however, less common; in these the information is gained by hearing a voice. (ii.) The divining rod (*q.v.*) is the best-known example of this class; divination depending on automatic movements of this sort is found at all stages of culture; in Australia it is used to detect the magician who has caused the death of a native; in medieval and modern times water-divining or *dowsing* has been largely and successfully used. Similar in principle is *coscinomancy*, or divining by a sieve held suspended, which gives indications by turning; and the equally common divination by a suspended ring, both of which are found from Europe in the west to China and Japan in the east. The ordeal by the Bible and key is equally popular; the book is suspended by a key tied in with its wards between the leaves and supported on two persons' fingers, and the whole turns round when the name of the guilty person is mentioned. Confined to higher cultures on the other hand, for obvious reasons, is divination by automatic writing, which is practised in China more especially. The sand divination so widely spread in Africa seems to be of a different nature. *Trance speaking*, on the other hand, may be found in any stage of culture and there is no doubt that in many cases the procedure of the magician or shaman induces a state of auto-hypnotism; at a higher stage these utterances are termed oracles and are believed to be the result of inspiration (*q.v.*). (iii.) Another method of divination is by the aid of mental impressions; observation seems to show that by some process of this sort, akin to clairvoyance (*q.v.*), fortunes are told successfully by means of palmistry or by laying the cards; for the same "lie" of the cards may be diversely interpreted to meet different cases. In other cases the impression is involuntary or less consciously sought, as in dreams (*q.v.*), which, however, are sometimes induced, for

purposes of divination, by the process known as incubation or temple sleep. Dreams are sometimes regarded as visits to or from gods or the souls of the dead, sometimes as signs to be interpreted symbolically by means of dream-books, which are found not only in Europe but in less cultured countries like Siam.

(B) In heteroscopic divination the process is rather one of inference from external facts. The methods are very various. (i.) The casting of lots, *sortilege*, was common in classical antiquity; the Homeric heroes prayed to the gods when they cast lots in Agamemnon's leather cap, and Mopsus divined with sacred lots when the Argonauts embarked. Similarly dice are thrown for purposes of *sortilege*; the *astragali* or knucklebones, used in children's games at the present day, were implements of divination in the first instance. In Polynesia the coco-nut is spun like a tectotum to discover a thief. Somewhat different are the omens drawn from books; in ancient times the poets were often consulted, more especially Virgil, whence the name *sortes virgilianae*, just as the Bible is used for drawing texts in our own day, especially in Germany. (ii.) In *haruspication*, or the inspection of entrails, in *scapulomancy* or divination by the spear-bone or shoulder-blade, in divination by footprints in ashes, found in Australia, Peru and Scotland, the voluntary element is prominent, for the diviner must take active steps to secure the conditions necessary to divination. (iii.) In the case of *augury* and *omens*, on the other hand, that is not necessary. The behaviour and cries of birds, and *augury* or meeting with ominous animals, &c., may be voluntarily observed, and opportunities for observation made; but this is not necessary for success. (iv.) In *astrology* we have a method which still finds believers among people of good education. The stars are held, not only to prognosticate the future but also to influence it; the child born when Mars is in the ascendant will be war-like; Venus has to do with love; the sign of the Lion presides over places where wild beasts are found. (v.) In other cases the tie that binds the subject of divination with the omen-giving object is sympathy. The name of the life-index is given to a tree, animal or other object believed to be so closely united by sympathetic ties to a human being that the fate of the latter is reflected in the condition of the former. The Polynesians set up sticks to see if the warriors they stood for were to fall in battle; on Hallow'e'en in our own country the behaviour of nuts and other objects thrown into the fire is held to prognosticate the lot of the person to whom they have been assigned. Where, as in the last two cases, the sympathetic bond is less strong, we find symbolical interpretation playing an important part.

Sympathy and symbolism, association of ideas and analogy, together with a certain amount of observation, are the explanation of the great mass of heteroscopic divinatory formulae. But where autoscopic phenomena play the chief part the question of the origin of divination is less simple. The investigations of the Society for Psychical Research show that premonitions, though rare in our own day, are not absolutely unknown. Pseudo-premonitions, due to hallucinatory memory, are not unknown; there is also some ground for holding that crystal-gazers are able to perceive incidents which are happening at a distance from them. Divination of this sort, therefore, may be due to observation and experiment of a rude sort, rather than to the unchecked play of fancy which resulted in heteroscopic divination.

See also the articles *AUGURS*, *ORACLE*, *ASTROLOGY*, *OMEN*, &c. **AUTHORITIES**.—Bouché Leclercq, *Histoire de la divination dans l'antiquité*; Tylor, *Primitive Culture*, *passim*; Maury, "La Magie et l'astrologie," *Journ. Anth. Inst.* i. 163, v. 436; *Folklore*, iii. 193; Eliot, *Talk-speaking Peoples*, p. 202; *Dictionnaire encyclopédique des sciences médicales*, xxx. 24-96; *Journ. of Philology*, xiii. 273, xiv. 113; Deubner, *De incubatione*; Lenormant, *La Divination, et la science de privages chez les Chaldéens*; Skeat, *Malay Magic*; J. Johnson, *Yoruba Heathenism* (1899). (N. W. T.)

DIVINING-ROD. As indicated in the article *MAGIC*, *Rhabdomancy*, or the art of using a divining-rod for discovering something hidden, is apparently of immemorial antiquity, and the Roman *virgula divina*, as used in taking auguries by means of casting bits of stick, is described by Cicero and Tacitus (see also *DIVINATION*); but the special form of *virgula furcata*, or forked

twig of hazel or willow (see also *HAZEL*), described by G. Agricola (*De re metallica*, 1546), and in Sebastian Munster's *Cosmography* in the early part of the 16th century, used specially for discovering metallic lodes or water beneath the earth, must be distinguished from the general superstition. The "dowsing" or divining-rod, in this sense, has a modern interest, dating from its use by prospectors for minerals in the German (Harz Mountains) mining districts; the French chemist M. E. Chevreul¹ assigns its first mention to Basil Valentine, the alchemist of the late 15th century. On account of its supposed magical powers, it may be taken perhaps as an historical analogue to such fairy wands as the *caduceus* of Mercury, the golden arrow of Herodotus's "Abaris the Hyperborean," or the medieval witch's broomstick. But the existence of the modern water-finder or dowser makes the divining-rod a matter of more than mythological or superstitious interest. The *Schlagruthe* (striking-rod), or forked twig of the German miners, was brought to England by those engaged in the Cornish mines by the merchant venturers of Queen Elizabeth's day. Professor W. F. Barrett, F.R.S., the chief modern investigator of this subject, regards its employment, dating as it does from the revival of learning, as based on the medieval doctrine of "sympathy," the drooping of trees and character of the vegetation being considered to give indications of mineral lodes beneath the earth's surface, by means of a sort of attraction; and such critical works as Robert Boyle's (1663), or the *Mineralogia Cornubiensis* of Pryce (1778), admitted its value in discovering metals. But as mining declined in Cornwall, the use of the dowser for searching for lodes almost disappeared, and was transferred to water-finding. The divining-rod has, however, also been used for searching for any buried objects. In the south of France, in the 17th century, it was employed in tracking criminals and heretics. Its abuse led to a decree of the Inquisition in 1701, forbidding its employment for purposes of justice.

In modern times the professional dowser is a "water-finder," and there has been a good deal of investigation into the possibility of a scientific explanation of his claims to be able to locate underground water, where it is not known to exist, by the use of a forked hazel-twig which, twisting in his hands, leads him by its directing-power to the place where a boring should be made. Whether justified or not, a widespread faith exists, based no doubt on frequent success, in the dowser's power; and Professor Barrett (*The Times*, January 21, 1905) states that "making a liberal allowance for failures of which I have not heard, I have no hesitation in saying that where fissure water exists and the discovery of underground water sufficient for a domestic supply is a matter of the utmost difficulty, the chances of success with a good dowser far exceed mere lucky hits, or the success obtained by the most skilful observer, even with full knowledge of the local geology." Is this due to any special faculty in the dowser, or has the twig itself anything to do with it? Held in balanced equilibrium, the forked twig, in the dowser's hands, moves with a sudden and often violent motion, and the appearance of actual life in the twig itself, though regarded as mere stage-play by some, is popularly associated with the cause of the water-finder's success. The theory that there is any direct connexion ("sympathy" or electrical influence) between the divining-rod and the water or metal, is however repudiated by modern science. Professor Barrett, who with Professor Janet and others is satisfied that the rod twists without any intention or voluntary deception on the part of the dowser, ascribes the phenomenon to "motor-automatism" on the part of the dowser (see *AUTOMATISM*), a reflex action excited by some stimulus upon his mind, which may be either a subconscious suggestion or an actual impression (obscure in its nature) from an external object or an external mind; both sorts of stimulus are possible, so that the dowser himself may make false inferences (and fail) by supposing that the stimulus is an external object (like water). The divining-rod being thus "an indicator of any sub-conscious suggestion or impression," its indications, no doubt, may be fallacious; but Professor Barrett, basing his conclusions upon observed successes and their greater proportion to failures than anything that

¹ *La Baguette divinatoire* (Paris, 1845).

chance could produce, advances the hypothesis that some persons (like the professional dowisers) possess "a genuine super-normal perceptive faculty," and that the mind of a good dowiser, possessing the idiosyncrasy of motor-automatism, becomes a blank or *tabula rasa*, so that "the faintest impression made by the object searched for creates an involuntary or automatic motion of the indicator, whatever it may be." Like the "homing instinct" of certain birds and animals, the dowiser's power lies beneath the level of any conscious perception; and the function of the forked twig is to act as an index of some material or other mental disturbance within him, which otherwise he could not interpret.

It should be added that dowisers do not always use any rod. Some again use a willow rod, or withy, others a hazel-twig (the traditional material), others a beech or holly twig, or one from any other tree; others even a piece of wire or watch-spring. The best dowisers are said to have been generally more or less illiterate men, usually engaged in some humble vocation.

Sir W. H. Preece (*The Times*, January 16, 1905), repudiating as an electrician the theory that any electric force is involved, has recorded his opinion that water-finding by a dowiser is due to "mechanical vibration, set up by the friction of moving water, acting upon the sensitive ventral diaphragm of certain exceptionally delicately framed persons." Another theory is that water-finders are "exceptionally sensitive to hygrometric influences." In any case, modern science approaches the problem as one concerning which the facts have to be accepted, and explained by some natural, though obscure, cause.

See for further details Professor Barrett's longer discussion in parts 32 (1897) and 38 (1900) of the *Proceedings of the Society for Psychical Research*.

DIVISION (from Lat. *dividere*, to break up into parts, separate), a general term for the action of breaking up a whole into parts. Thus, in political economy, the phrase "division of labour" implies the assignment to particular workmen of the various portions of a whole piece of work; in mathematics division is the process of finding how many times one number or quantity, the "divisor" is contained in another, the "dividend" (see ARITHMETIC and ALGEBRA); in the musical terminology of the 17th and 18th centuries, the term was used for rapid passages consisting of a few slow notes amplified into a florid passage, *i.e.* into a larger number of quick ones. The word is used also in concrete senses for the parts into which a thing is divided, *e.g.* a division of an army, an administrative or electoral division; similarly, a "division" is taken in a legislative body when votes are recorded for and against a proposed measure.

In logic, division is a technical term for the process by which a genus is broken up into its species. Thus the genus "animal" may be divided, according to the habitat of the various kinds, into animals which live on land, those which live in water, those which live in the air. Each of these may be subdivided according to whether their constituent members do or do not possess certain other qualities. The basis of each of these divisions is called the *fundamentum divisionis*. It is clear that there can be no division in respect of those qualities which make the genus what it is. The various species are all alike in the possession of the generic attributes, but differ in other respects; they are "variations on the same theme" (Joseph, *Introduction to Logic*, 1906); each one has the generic, and also certain peculiar, qualities (*differentiæ*), which latter distinguish them from other species of the same genus. The process of division is thus the obverse of classification (*q.v.*); it proceeds from genus to species, whereas classification begins with the particulars and rises through species to genus. In the exact sciences, and indeed in all argument both practical and theoretical, accurate division is of great importance. It is governed by the following rules. (1) *Division must be exhaustive*; all the members of the genus must find a place in one or other of the species; a captain who selects for his team skilful batsmen and bowlers only is guilty of an incomplete division of the whole function of a cricket team by omitting to provide himself with good fielders. Rectilinear figures cannot be divided into triangles and quadrilaterals because there are rectilinear figures which have more than four sides. On the other hand, triangles can be

divided into equilateral, isosceles and scalene, since no other kind of triangle can exist. (2) *Division must be exclusive*, that is, each species must be complete in itself and not contain members of another species. No member of a genus must be included in more than one of the species. (3) In every division there must be but one principle (*fundamentum divisionis*). The members of a genus may differ from one another in many respects, *e.g.* books may be divided according to external form into quarto, octavo, &c., or according to binding into calf, cloth, paper-backed and so on. They cannot, however, be divided logically into quarto, paper-backed, novels and remainders. When more than one principle is used in a division it is called "cross division." (4) *Division must proceed gradually* ("Divisio non facit saltum"), *i.e.* the genus must be resolved into the next highest ("proximate") species. To go straight from a *summum genus* to very small species is of no scientific value.

It is to be observed that logical division is concerned exclusively with universals or concepts; division is of genus and species, not of particulars. Two other kinds of division are recognized:—*metaphysical division*, the separation in thought of the various qualities possessed by an individual thing (a piece of lead has weight, colour, &c.), and *physical division or partition*, the breaking up of an object into its parts (a watch is thought of as being composed of case, dial, works, &c.). Logical division is closely allied with logical definition (*q.v.*).

DIVORCE (Lat. *divortium*, derived from *dis-*, apart, and *vertere*, to turn), the dissolution, in whole or in part, of the tie of marriage. It includes both the complete abrogation of the marriage relation known as a divorce *a vinculo matrimonii*, which carries with it a power on the part of both parties to the marriage to remarry other persons or each other, and also that incomplete severance not involving powers to remarry, which was formerly known as divorce *a mensa et thoro*, and has in England been termed "judicial separation." Less strictly, divorce is commonly understood to include judicial declarations of nullity of marriage, which, while practically terminating the marriage relation, proceed in law on the basis of the marriage never having been legally established.

The conditions under which, in different communities, divorce has at different times been permitted, vary with the aspects in which the relation of marriage (*q.v.*) has been regarded. When marriage has been deemed to be the acquisition by the husband of property in the wife, or when it has been regarded as a mere agreement between persons capable both to form and to dissolve that contract, we find that marriage has been dissoluble at the will of the husband, or by agreement of the husband and wife. Yet even in these cases the interest of the whole community in the purity of marriage relations, in the pecuniary bearings of this particular contract, and the condition of children, has led to the imposition of restrictions on, and the attachment of conditions to, the termination of the obligations consequent on a marriage legally contracted. But the main restrictions on liberty of divorce have arisen from the conception of marriage entertained by religions, and especially by one religion. Christianity has had no greater practical effect on the life of mankind than in its belief that marriage is no mere civil contract, but a vow in the sight of God binding the parties by obligations of conscience above and beyond those of civil law. Translating this conception into practice, Christianity not only profoundly modified the legal conditions of divorce as formulated in the Roman civil law, but in its own canon law defined its own rule of divorce, going so far as in the Western (at least in its unreformed condition), though not the Eastern, branch of Christendom to forbid all complete divorces, that is to say, all dissolutions of marriage carrying with them the right to remarry.

HISTORY

The Roman Law of Divorce before Justinian.—The history of divorce, therefore, practically begins with the law of Rome. It took its earliest colour from that conception of the *patria potestas*, or the power of the head of the family over its members, which enters so deeply into the jurisprudence of ancient Rome. The

wife was transferred at marriage to the authority of her husband, *in manus*, and consequently became so far subject to him that he could, at his will, renounce his rule over her, and terminate his companionship, subject at least to an adjustment of the pecuniary rights which were disturbed by such action. So clearly was the power of the husband derived from that of the father, that for a long period a father, in the exercise of his *poteestas*, could take his daughter from her husband against the wishes of both. It may be presumed that this power, anomalous as it appears, was not unexercised, as we find that a constitution of Antoninus Pius prohibited a father from disturbing a harmonious union, and Marcus Aurelius afterwards limited this prohibition by allowing the interference of a father for strong and just cause—*magna et justa causa interveniente*. Except in so far as it was restrained by special legislation, the authority of a husband in the matter of divorce was absolute. As early indeed, however, as the time of Romulus, it is said that the state asserted its interest in the permanence of marriage by forbidding the repudiation of wives unless they were guilty of adultery or of drinking wine, on pain of forfeiture of the whole of an offender's property, one-half of which went to the wife, the other to Ceres. But the law of the XII. Tables, in turn, allowed freedom of divorce. It would appear, however, that the sense of the community was so far shocked by the inhumanity of treating a wife as mere property, or the risk of regarding marriage as a mere terminable contract, that, without crystallizing into positive enactment, it operated to prevent the exercise of so harsh and dangerous a power. It is said that for 500 years no husband took advantage of his power, and it was then only by an order of a censor, however obtained, that Spurius Carvilius Ruga repudiated his wife for barrenness. We may, however, be permitted to doubt the genuineness of this censorial order, or at least to conjecture the influence under which the censor was induced to intervene, when we find that in another instance, that of L. Antonius, a censor punished an unjust divorce by expulsion from the senate, and that the exercise of their power by husbands increased to a great and alarming extent. Probably few of the admirers of the greatest of Roman orators have not regretted his summary and wholly informal repudiation of Terentia. At last the *lex Julia de adulteriis*, while recognizing a power of divorce both in the husband and in the wife, imposed on it, in the public interest, serious restrictions and consequences. It required a written bill of divorce (*libellus repudiis*) to be given in the presence of seven witnesses, who must be Roman citizens of age, and the divorce must be publicly registered. The act was, however, purely an act of the party performing it, and no idea of judicial interference or contract seems to have been entertained. It was not necessary for either husband or wife giving the bill to acquaint the other with it before its execution, though it was considered proper to deliver the bill, when made, to the other party. In this way a wife could divorce a lunatic husband, or the *paterfamilias* of a lunatic wife could divorce her from her husband. But the *lex Julia* was also the first of a series of enactments by which pecuniary consequences were imposed on divorce both by husbands and wives, whether the intention was to restrain divorce by penalties of this nature, or to readjust pecuniary relations settled on the basis of marriage and disturbed by its rupture. It was provided that if the wife was guilty of adultery, her husband in divorcing her could retain one-sixth of her *dos*, but if she had committed a less serious offence, one-eighth. If the husband was guilty of adultery, he had to make immediate restitution of her dowry, or if it consisted of land, the annual proceeds for three years; if he was guilty of a less serious offence, he had six months within which to restore the *dos*. If both parties were in fault, no penalty fell on either. The *lex Julia* was followed by a series of acts of legislation extending and modifying its provisions. The legislation of Constantine, A.D. 331, specified certain causes for which alone a divorce could take place without the imposition of pecuniary penalties. There were three causes for which a wife could divorce her husband with impunity: (1) murder, (2) preparation of poisons, (3) violation of tombs; but if she divorced him for any other cause, such as drunkenness, or gambling or immoral society, she forfeited her dowry and incurred the further

penalty of deportation. There were also three causes for which a husband could divorce his wife without incurring any penalty: (1) adultery, (2) preparation of poisons, (3) acting as a procurator. If he divorced her for any other cause, he forfeited all interest in her dowry; and if he married again, the first wife could take the dowry of the second.

In A.D. 421 the emperors Honorius and Theodosius enacted a law of divorce which introduced limitations on the power of remarriage as an additional penalty in certain cases. As regards a wife: (1) if she divorced her husband for grave reasons or crime, she retained her dowry and could remarry after five years; (2) if she divorced him for criminal conduct or moderate faults, she forfeited her dowry, became incapable of remarriage, and liable to deportation, nor could the emperor's prerogative of pardon be exerted in her favour. As regards a husband: if he divorced his wife (1) for serious crime, he retained the dowry and could remarry immediately; (2) for criminal conduct, he did not retain the dowry, but could remarry; (3) for mere dislike, he forfeited the property brought into the marriage and could not remarry.

In A.D. 449 the law of divorce was rendered simpler and certainly more facile by Theodosius and Valentinian. It was provided that a wife could divorce her husband without incurring any penalty if he was convicted of any one of twelve offences: (1) treason, (2) adultery, (3) homicide, (4) poisoning, (5) forgery, (6) violating tombs, (7) stealing from a church, (8) robbery, (9) cattle-stealing, (10) attempting his wife's life, (11) beating his wife, (12) introducing immoral women to his house. If the wife divorced her husband for any other cause, she forfeited her dowry, and could not marry again for five years. A husband could divorce his wife without incurring a penalty for any of these reasons except the last, and also for the following reasons: (1) going to dine with men other than her relations without the knowledge or against the wish of her husband; (2) going from home at night against his wish without reasonable cause; (3) frequenting the circus, theatre or amphitheatre after being forbidden by her husband. If a husband divorced his wife for any other reason, he forfeited all interest in his wife's dowry, and also any property he brought into the marriage.

The above sketch of the legislation prior to the time of Justinian, while it indicates a desire to place the husband and wife on something like terms of equality as regards divorce, indicates also, by its forbidding remarriage and by its pecuniary provisions in certain cases, a sense in the community of the importance in the public interest of restraining the violation of the contract of marriage. But to the Roman marriage was primarily a contract, and therefore side by side with this legislation there always existed a power of divorce by mutual consent. We must now turn to those principles of the Christian religion which, in combination with the legislation above described, produced the law formulated by Justinian.

The Christian View of Divorce.—The Christian law of divorce as enunciated by its Founder was expressed in a few words, but these, unfortunately, by no means of agreed interpretation. To appreciate them it is necessary to consider the enactment of the Mosaic law, which also was expressed in few words, but of a meaning involved in much doubt. The phrase in Deut. xxiv. 1-4, which is translated in the Authorized Version "some uncleanness," but in the Revised Version, "some unseemly thing," and which is the only cause stated to justify the giving of a "bill of divorcement," was limited by the school of Shammai to moral delinquency, but was extended by the rival school of Hillel to causes of trifling importance or even to motives of caprice. The wider interpretation would seem to be supported by the words of Christ (Matt. v. 31), who, in indicating His own doctrine in contradistinction to the law of Moses, said, "Whosoever shall put away his wife, saving for the cause of fornication (*porneitas*), causeth her to commit adultery; and whosoever shall marry her that is divorced committeth adultery." The meaning of these words of Christ Himself has been involved in controversy, which perhaps was nowhere carried on with greater acuteness or unde-

more critical conditions than within the walls of the British parliament during the passage of the Divorce Act of 1857. That they justify divorce of a complete kind for moral delinquency of some nature is supported by the opinion probably of every competent scholar. But scholars of eminence have sought to restrict the meaning of the *λόγος τροπέας* to antenuptial incontinence concealed from the husband, and to exclude adultery. The effect of this view commends itself to the adherents of the Church of Rome, because it places the right to separation between husband and wife, not on a cause supervening after a marriage, which that Church seeks to regard as absolutely indissoluble, but on invalidity in the contract of marriage itself, and which may therefore render the marriage liable to be declared void without impugning its indissoluble character when rightly contracted. The narrower view of the meaning of *τροπέας* has been maintained by, among others, Dr Döllinger (*First Ages of the Church*, ii. 226); but those who will consider the arguments of Professor Conington in reply to Dr Döllinger (*Contemp. Review*, May 1866) will probably assign the palm to the English scholar. A more general view points in the same direction. It is quite true that under the Mosaic law antenuptial incontinence was, as was also adultery, punishable with death. But when we consider the effect of adultery not only as a moral fault, but as violating the solemn contract of marriage and vitiating its objects, it is inconceivable that Christ, in employing a term of general import, intended to limit it to one kind, and that the less serious, of incontinence.

Effect of Christianity on the Law of Rome.—The modification in the civil law of Rome effected by Justinian under the joint influence of the previous law of Rome and that of Christianity was remarkable. Gibbon has summed up the change effected in the law of Rome with characteristic accuracy: "The Christian princes were the first who specified the just causes of a private divorce; their institutions from Constantine to Justinian appear to fluctuate between the customs of the empire and the wishes of the Church; and the author of the Novels too frequently reforms the jurisprudence of the Code and Pandects." Divorce by mutual consent, hitherto, as we have seen, absolutely free, was prohibited (Nov. 117) except in three cases: (1) when the husband was impotent; (2) when either husband or wife desired to enter a monastery; and (3) when either of them was in captivity for a certain length of time. It is obvious that the two first of these exceptions might well commend themselves to the mind of the Church, the former as being rather a matter of nullity of marriage than of divorce, the latter as admitting the paramount claims of the Church on its adherents, and not inconsistent with the spirit of the words of St Paul himself, who clearly contemplated a separation between husband and wife as allowable in case either of them did not hold the Christian faith (1 Cor. vii. 12). At a later period Justinian placed a further restriction or even prohibition on divorce by consent by enacting that spouses dissolving a marriage by mutual consent should forfeit all their property, and be confined for life in a monastery, which was to receive one-third of the forfeited property, the remaining two-thirds going to the children of the marriage. The cause stated for this remarkable alteration of the law, and the abandonment of the conception of marriage as a civil contract *ut non Dei iudicium contemnatur* (Nov. 134), indicates the influence of the Christian idea of marriage. That influence, however, did not long continue in its full force. The prohibitions of Justinian on divorce by consent were repealed by Justin (Nov. 140), his successor. "He yielded," says Gibbon, "to the prayers of his unhappy subjects, and restored the liberty of divorce by mutual consent; the civilians were unanimous, the theologians were divided, and the ambiguous word which contains the precept of Christ is flexible to any interpretation that the wisdom of a legislature can demand." It was difficult, the enactment stated, "to reconcile those who once came to hate each other, and who, if compelled to live together, frequently attempted each other's lives."

Justinian further re-enacted, with some modifications, the power of divorce by a husband or wife against the will of the other. Divorce by a wife was allowed in five cases (Nov. 117): (1) the

husband being party or privy to conspiracy against the state; (2) attempting his wife's life, or failing to disclose to her plots against it; (3) attempting to induce his wife to commit adultery; (4) accusing his wife falsely of adultery; (5) taking a woman to live in the house with his wife, or, after warning, frequenting a house in the same town with any woman other than his wife. If a wife divorced her husband for one of these reasons, she recovered her dowry and any property brought into the marriage by her husband for life with reversion to her children, or if there were no children, absolutely. But if she divorced him for any other reason, the provisions of the enactment of Theodosius and Valentinian were to apply. A husband was allowed to divorce his wife for any one of seven reasons: (1) failure to disclose to her husband plots against the state; (2) adultery; (3) attempting or failing to disclose plots against her husband's life; (4) frequenting dinners or balls with other men against her husband's wishes; (5) remaining from home against the wishes of her husband except with her parents; (6) going to the circus, theatre or amphitheatre without the knowledge or contrary to the prohibition of her husband; (7) procuring abortion. If the husband divorced his wife for any one of these reasons he retained the dowry absolutely, or if there were children, with reversion to them. If he divorced her for any other reason, the enactments of Theodosius and Valentinian applied. In any case of a divorce, if the father or mother of either spouse had advanced the dowry and it would be forfeited by an unreasonable divorce, the consent of the father or mother was necessary to render the divorce valid.

Effect of Divorce on Children in the Law of Rome.—The custody of the children of divorced parents was dealt with by the Roman law in a liberal manner. A constitution of Diocletian and Maximian left it to the judge to determine in his discretion to which of the parents the children should go. Justinian enacted that divorce should not impair the rights of children either as to inheritance or maintenance. If a wife divorced her husband for good cause, and she remained unmarried, the children were to be in her custody, but to be maintained by the father; but if the mother was in fault, the father obtained the custody. If he was unable, from want of means, to support them, but she was able to do so, she was obliged to take them and support them. It is interesting to compare these provisions as to children with the practice at present under English law, which in this respect reflects so closely the spirit of the law of Rome.

The Canon Law of Divorce.—The canon law of Rome was based on two main principles: (1) That there could be no divorce *a vinculo matrimonii*, but only *a mensa et thoro*. The rule was stated in the most absolute terms: "*Quamdiu vivit vir licet adulter sit, licet sodomita, licet flagitiis omnibus cooperatus, et ab uxore propter hæc scelera derelictus, maritus ejus reputatur, cui alterum vivum accipere non licet*" (Caus. 32, Quaest. 7, c. 7). (2) That no divorce could be had at the will of the parties, but only by the sentence of a competent, that is to say, an ecclesiastical, court. In this negation of a right to divorce *a vinculo matrimonii* lies the broad difference between the doctrines of the Eastern and Western Churches of Christendom. The Greek Church, understanding the words of Christ in the broader sense above mentioned, has always allowed complete divorce with a right to remarry for the cause of adultery. And it is said that the form at least of an anathema of the council of Trent was modified out of respect to difference on the part of the Greek Church (see Pothier 5. 6. 21). The papal canon law allowed a divorce *a mensa et thoro* for six causes: (1) adultery or unnatural offences; (2) impotency; (3) cruelty; (4) infidelity; (5) entering into religion; (6) consanguinity. The Church, however, always assumed to itself the right to grant licences for an absolute divorce; and further, by claiming the power to declare marriages null and void, though professedly this could be done only in cases where the original contract could be said to be void, it was, and is to this day, undoubtedly extended in practice to cases in which it is impossible to suppose the original contract really void, but in which a complete divorce is on other grounds desirable.

DIVORCE IN ENGLAND

In England the law of divorce, originally based on the canon law of Rome, underwent some, though little, permanent change at the Reformation, but was profoundly modified by the exercise of the power of the state through legislation. From the canon law was derived the principle that divorce could legally take place only by sentence of the court, and never at the will of the parties. Complete divorce has never been governed by any other principle than this; and in so far as an incomplete divorce has become practicable at the will of the parties, it has been by the intervention of civil tribunals and contrary to the law of the ecclesiastical courts. Those courts adopted as ground for divorce *a mensa et thoro* the main grounds allowed by Roman canon law, adultery and cruelty (Ayliffe, 22; Co. Lit. 102; 2 Salk. 162; Godolphin Abridg. 495). The causes of heresy and of entering into religion, if ever they were recognized in England, ceased to exist at the Reformation.

The principles upon which the English ecclesiastical courts proceeded in divorce *a mensa et thoro* are those which are still in force, and which (with some modification by statutory enactment) have been administered by judicial tribunals down to the present day. The courts by which the ecclesiastical law, and therefore the law of divorce, was administered were, until 1857, the courts of the various dioceses, including that of the archbishop of Canterbury, known as the Court of Arches, and that of the archbishop of York, known as the Consistory Court of York; but by statute a suitor was prevented from taking proceedings in any court except that determined by the residence of the person against whom proceedings were taken (23 Hen. VIII. c. 9). From these courts an appeal lay to delegates appointed in each case by the crown, until the establishment of the judicial committee of the privy council in 1836, when the appeal was given to the crown as advised by that body.

The proof of adultery (to which Isidore in his *Book of Etymologies* gives the fanciful derivation of "*ad alterius thorum*") was not by the canon law as received in England restricted by the operation of arbitrary rules. It was never, for example, required, as by the law of Mahomet, that the act should have been actually seen by competent witnesses, nor even that the case should be based on any particular kind of proof. It was recognized that the nature of the offence almost inevitably precluded direct evidence. One rule, however, appears to have commended itself to the framers of the canon law as too general in its application not to be regarded as a principle. The mere confession of the parties was not regarded as a safe ground of conviction; and this rule was formulated by a decretal epistle of Pope Celestine III., and, following it, by the 105th of the Canons of 1604. This rule has now been abrogated; and no doubt it is wiser not to fetter the discretion of the tribunal charged with the responsibility of deciding particular cases, but experience of divorce proceedings tends to confirm the belief that this rule of the canon law was founded on an accurate appreciation of human nature.

Although, therefore, with the above exception, no strict rules of the evidence necessary to establish adultery have ever been established in the English courts, experience has indicated, and in former days judges of the ecclesiastical courts often expressed, the lines upon which such proof may be expected to proceed. It is necessary and sufficient, in general, to prove two things—first the guilty affection towards each other of the persons accused, and, secondly, an opportunity or opportunities of which, if so minded, their passion may have been gratified. It is obvious that any strong proof on either of these points renders strict proof on the other less needful; but when proof on both is afforded, the common sense of a tribunal, acting with a knowledge of human nature, may be trusted to draw the inevitable conclusion.

The definition of cruelty accepted by the ecclesiastical courts as that of the canon law is the same as that which prevails at the present time; and the view of the law taken by the House of Lords in *Russell v. Russell* (1897 App. Cas. 395) was expressly based on the view of cruelty taken by the authorities of the ecclesiastical law. The best definition by older English writers

is probably to be found in Clarke's *Praxis* (p. 144): "Si maritus fuerit erga uxorem crudelis et ferax ac mortem comminatus et machinatus fuerit, vel eam inhumaniter verbis et verberibus tractaverit, et aliquando venenum loco potus paraverit vel aliquod simile commiserit, propter quod sine periculo vitæ cum marito cohabitare ut obsequia conjugalia impendere non audeat . . . consimili etiam causa competit viro contra mulierem." Lord Stowell, probably the greatest master of the civil and canon law who ever sat in an English court of justice, has in one of his most famous judgments (*Evans v. Evans*, 1790, 1 Hagg. *Consist.* 35) echoed the above language in words often quoted, which have constituted the standard exposition of the law to the present day. "In the older cases," he said, "of this sort which I have had the opportunity of looking into, I have observed that the danger of life, limb or health is usually insisted as the ground upon which the court has proceeded to a separation. This doctrine has been repeatedly applied by the court in the cases which have been cited. The court has never been driven off this ground. It has always been jealous of the inconvenience of departing from it, and I have heard no one case cited in which the court has granted a divorce without proof given of a reasonable apprehension of bodily hurt. I say an apprehension, because assuredly the court is not to wait till the hurt is actually done; but the apprehension must be reasonable: it must not be an apprehension arising from an exquisite and diseased sensibility of mind. Petty vexations applied to such a constitution of mind may certainly in time wear out the animal machine, but still they are not cases of legal relief; people must relieve themselves as well as they can by prudent resistance, by calling in the succours of religion and the consolation of friends; but the aid of courts is not to be resorted to in such cases with any effect." The risk of personal danger in cohabitation constituted, therefore, the foundation of legal cruelty. But this does not exclude such conduct as a course of persistent ill-treatment, though not amounting to personal violence, especially if such ill-treatment has in fact caused injury to health. But the person complaining must not be the author of his or her own wrong. If, accordingly, one of the spouses by his or her conduct is really the cause of the conduct complained of, recourse to the court would be had in vain, the true remedy lying in a reformation of the real cause of the disagreement.

In addition to a denial of the charge or charges, the canon law allowed three grounds of answer: (1) *Compensatio criminis*, a set-off of equal guilt or recrimination. This principle is no doubt derived from the Roman law and it had the effect of refusing to one guilty spouse the remedy of divorce against the other although equally guilty. It was always accepted in England, although not in other countries, such as France and Scotland, which also followed the canon or civil law. In strictness, recrimination applied to a similar offence having been committed by the party charging that offence. But a decision (1888) of the English courts shows that a wife who had committed adultery could not bring a suit against her husband for cruelty (*Osway v. Osway* 13 P. D. 141). (2) *Condonatio*. If the complaining spouse has, in fact, forgiven the offence complained of, that constitutes a conditional bar to any proceedings. The main and usual evidence of such forgiveness is constituted by a renewal of marital intercourse, and it is difficult—perhaps impossible—to imagine any case in which such intercourse would not be held to establish condonation. But condonation may be proved by other acts, or by words, having regard to the circumstances of each case. Condonation is, however, always presumed to be conditional on future good behaviour, and misconduct even of a different kind revives the former offence. (3) *Connivance* constitutes a complete answer to any charge. Nor need the husband be the active agent of the misconduct of the wife. Indifference or neglect imputable to a corrupt intention are sufficient. It will be seen presently that modern statute law has gone further in this direction. It is to be added that the connivance need not be of the very act complained of, but may be of an act of a similar kind. A learned judge, recalling the classical anecdote of Mæcenæ and Galba, said, "A husband is not permitted to say *non omnibus dormio*." The

ecclesiastical courts also considered themselves bound to refuse relief if there was shown to be *collusion* between the parties. In its primary and most general sense collusion was understood to be an agreement between the parties for the purpose of deceiving the court by false or fictitious evidence; for example, an agreement to commit, or appear to commit, an act of adultery. Collusion, however, is not limited to the imposing of other than genuine evidence on the court. It extends to an agreement to withhold any material evidence; and indeed is carried further, and held to extend to any agreement which may have the effect of concealing the real and complete truth from the court (see *Churchward v. Churchward*, 1894, p. 161). This doctrine was of considerable importance even in the days when only divorces *a mensa et thoro* were granted, because at that time the parties were not permitted to separate by consent. At the present day it has become, with regard to divorce *a vinculo matrimonii*, a rule of greater and of more far-reaching importance.

The canon law as accepted in England, while allowing divorces of the nature and for the causes above mentioned, actively interfered to prevent separation between husband and wife in any other manner. A suit known as a suit for restitution of conjugal rights could be brought to compel cohabitation; and on evidence of the desertion of either spouse, the court ordered a return to the matrimonial home, though it carried no further its authority as to the matrimonial relations within the home. To this suit an agreement between the parties constituted no answer. But an answer was afforded by any conduct which would have supported a decree of divorce *a mensa et thoro*. It is a question whether, indeed, the ecclesiastical courts would not have gone further, and refused a decree of restitution of conjugal rights on grounds which might appear adequate to justify such refusal, though not sufficient on which to ground a decree of divorce. The view of the court of appeal and the House of Lords has given some colour to this opinion, and certainly the court of appeal has held, although perhaps somewhat hastily, that the effect of a modern statute has been to allow the court to refuse restitution of conjugal rights for causes falling short of what would constitute ground for divorce (*Russell v. Russell*, 1895, p. 315).

The ecclesiastical courts provided for the pecuniary rights of the wife by granting to her alimony during the progress of the suit, and a proper allowance after its termination in cases in which she was successful. Such payments were dependent on the pecuniary means, or *faculties*, as they were termed, of the husband, and were subject to subsequent increase or diminution in proper cases. But the ecclesiastical courts did not deal with the custody of the children of the marriage, it being probably considered that that matter could be determined by the common law rights of the father, or by the intervention of the court of chancery.

The canon law fixed no period of limitation, either in respect of a suit for divorce or for restitution of conjugal rights; but, as regards at least suits for divorce, any substantial delay might lead to the imputation of acquiescence or even condonation. To that extent, at least, the maxim *vigilantibus non dormientibus jura subveniunt* applied.

It is remarkable that desertion by either party to a marriage, except as giving rise to a suit for restitution, was not treated as an offence by canon law in England. It formed no ground for a suit for divorce, and constituted no answer to such a suit by way of recrimination. It might indeed deprive a husband of his remedy if it amounted to connivance, or perhaps even if it amounted only to culpable neglect.

The canon law, as administered in England, has kept clear the logical distinction which exists between dissolving a marriage and declaring it null and void. The result has been that, in England at least, the two proceedings have never been allowed to pass into one another, and a complete divorce has not been granted on pretence of a cause really one for declaring the marriage void *ab initio*. But for certain causes the courts were prepared to declare a marriage null and void on the suit of either party. There is, indeed, a distinction to be drawn between a marriage void or only voidable, though in both cases it became the subject of a similar declaration. It was void in the cases of incapacity of the parties

to contract it, arising from want of proper age, or consanguinity, or from a previous marriage, or from absence of consent, a state of things which would arise if the marriage were compelled by force or induced by fraud as to the nature of the contract entered into or the personality of the parties. It is to be remarked that, in England at least, the idea of fraud as connected with the solemnization of marriage has been kept within these narrow limits. Fraud of a different kind, such as deception as to the property or position of the husband or wife, or antecedent impurity of the wife, even if resulting in a concealed pregnancy, has not in England (though the last-mentioned cause has in other countries) been held a ground for the vitiation of a marriage contract. A marriage was voidable, and could be declared void, on the ground of physical incapacity of either spouse, the absence of intercourse between the parties after a sufficient period of opportunity being almost, if not quite, conclusive on this subject.

With regard to one cause of nullity the legislation interfered from consideration, it is said, of a case of special hardship. Before the Marriage Act of 1835 marriages within the prohibited degrees of consanguinity and affinity were only voidable by a decree of the court, and remained valid unless challenged during the lifetime of both the parties. But this act, while providing that no previous marriage between persons within the prohibited degrees should be annulled by a decree of the ecclesiastical court pronounced in a suit depending at the time of the passing of the act, went on to render all such marriages thereafter contracted in England "absolutely null and void to all intents and purposes whatever."

Another suit was allowed by the ecclesiastical courts which should be mentioned, although its bearing on divorce is indirect. This was the suit for *jactitation of marriage*, which in the case of any person falsely asserting his or her marriage to another, allowed such person to be put to perpetual silence by an order of the court. This suit, which has been of rare occurrence (though there was an instance, *Thompson v. Rourke*, in 1892), does not appear to have been used for the purpose of determining the validity of a marriage. The legislature, has, however, in the Legitimacy Declaration Act of 1858, provided a ready means by which the validity of marriages and the legitimacy of children can be determined, and the procedure provided has repeatedly been utilised.

It should be added, as a matter closely akin to the proceedings in the ecclesiastical courts, that the common law took cognizance of one phase of matrimonial relations by allowing an action by the husband against a paramour, known as an action for criminal conversation. In such an action a husband could recover damages estimated according to the loss he was supposed to have sustained by the seduction and loss of his wife, the punishment of the seducer not being altogether excluded from consideration. Although this action was not unfrequently (and indeed, for the purposes of a divorce, necessarily) brought, it was one which naturally was regarded with disfavour.

Effect of the Reformation.—Great as was the indirect effect of the Reformation upon the law of divorce in England, the direct effect was small. It might, indeed, have been supposed that the disappearance of the sacramental idea of marriage entertained by the Roman Church would have ushered in the greater freedom of divorce which had been associated with marriage regarded as a civil contract. And to some extent this was the case. It was for some time supposed that the sentences of divorce pronounced by the ecclesiastical courts acquired the effect of allowing remarriage, and such divorces were in some cases granted. In *Lord Northampton's* case in the reign of Edward VI. the delegates pronounced in favour of a second marriage after a divorce *a mensa et thoro*. It was, however, finally decided in *Foljambe's* case, in the 44th year of Elizabeth, that a marriage validly contracted could not be dissolved for any cause. But the growing sense of the right to a complete divorce for adequate cause, when no longer any religious law to the contrary could be validly asserted, in time compelled the discovery of a remedy. The commission appointed by Henry VIII. and Edward VI. to reform the ecclesiastical law drew up the elaborate report known

as the *Reformatio Legum*, and in this they recommended that divorces *a mensa et thoro* should be abolished, and in their place complete divorce allowed for the causes of adultery, desertion and cruelty. These proposals, however, never became law. In 1669 a private act of parliament was granted in the case of Lord de Roos, and this was followed by another in the case of the duke of Norfolk in 1692. Such acts were, however, rare until the accession of the House of Hanover, only five acts passing before that period. Afterwards their number considerably increased. Between 1715 and 1775 there were sixty such acts, in the next twenty-five years there were seventy-four, and between 1800 and 1850 there were ninety. In 1829 alone there were seven, and in 1830 nine.

The jurisdiction thus assumed by parliament to grant absolute divorces was exercised with great care. The case was fully investigated before a committee of the House of Lords, and not only was the substance of justice so secured, but the House of Lords further required that application to parliament should be preceded by a successful suit in the ecclesiastical courts resulting in a decree of divorce *a mensa et thoro*, and in the case of a husband being the applicant, a successful action at common law and the recovery of damages against the paramour. In this way, and also, if needful, on its own initiative, the House of Lords provided that there should be no connivance or collusion. Care was also taken that a proper allowance was secured to the wife in cases in which she was not the offending party. This procedure is still pursued in the case of Irish divorces.

It is obvious, however, that the necessity for costly proceedings before the Houses of Parliament imposed great hardship on the mass of the population, and there can be little doubt that this hardship was deeply felt. Repeated proposals were made to parliament with a view to reform of the law, and more than one commission reported on the subject. It is said that the final impetus was given by an address to a prisoner by Mr Justice Maule. The prisoner's wife had deserted him with her paramour, and he married again during her lifetime. He was indicted for bigamy, and convicted, and Mr Justice Maule sentenced him in the following words:—"Prisoner at the bar: You have been convicted of the offence of bigamy, that is to say, of marrying a woman while you had a wife still alive, though it is true she has deserted you and is living in adultery with another man. You have, therefore, committed a crime against the laws of your country, and you have also acted under a very serious misapprehension of the course which you ought to have pursued. You should have gone to the ecclesiastical court and there obtained against your wife a decree *a mensa et thoro*. You should then have brought an action in the courts of common law and recovered, as no doubt you would have recovered, damages against your wife's paramour. Armed with these decrees, you should have approached the legislature and obtained an act of parliament which would have rendered you free and legally competent to marry the person whom you have taken on yourself to marry with no such sanction. It is quite true that these proceedings would have cost you many hundreds of pounds, whereas you probably have not as many pence. But the law knows no distinction between rich and poor. The sentence of the court upon you, therefore, is that you be imprisoned for one day, which period has already been exceeded, as you have been in custody since the commencement of the assizes." The grave irony of the learned judge was felt to represent truly a state of things well-nigh intolerable, and a reform in the law of divorce was felt to be inevitable. The hour and the man came in 1857, the man in the person of Sir Richard Bethell (afterwards Lord Westbury), then attorney-general.

The Act of 1857.—Probably few measures have been conceived with such consummate skill and knowledge, and few conducted through parliament with such dexterity and determination. The leading opponent of the measure was Mr Gladstone, backed by the zeal of the High Church party and inspired by his own matchless subtlety and resource. But the contest proved to be unequal, and after debates in which every line, almost every word, of the measure was hotly contested, especially in the House of

Commons, the measure emerged substantially as it had been introduced. Not the least part of the merit and success of the act of 1857 is due to the skill which, while effecting a great social change, did so with the smallest possible amount of innovation. The act (which came into operation on the 1st of January 1858) embodied two main principles: 1. The constitution of a lay court for the administration of all matters connected with divorce. 2. The transfer to that court, with as little change as possible, of the powers exercised in matrimonial matters by (a) the House of Lords, (b) the ecclesiastical courts, (c) the courts of common law.

The Constitution of the Court.—The new court, termed "The Court for Divorce and Matrimonial Causes," was constituted by the lord chancellor, the chiefs and the senior puisne judges of the three courts of common law, and the judge of the court of probate (which was also established in 1857), but the functions of the court were practically entrusted to the judge of the court of probate, termed the "Judge Ordinary," who thus in matters of probate and divorce became the representative of the former ecclesiastical jurisdiction. The judge ordinary was empowered either to sit alone or with one or more of the other judges to constitute a full court. The parties to a suit obtained the right of trial by jury of all disputed questions of fact; and the rules of evidence of the common law courts were made to apply. An appeal to the full court was given in all matters, which the judge ordinary was enabled to hear sitting alone.

1. To this court were transferred all the powers of the ecclesiastical courts with regard to suits for divorce *a mensa et thoro*, to which the name was given of suits for "judicial separation," nullity, restitution of conjugal rights, and jactitation of marriage, and in all such proceedings it was expressly enacted (sec. 22) that the court should act on principles and rules as nearly as possible conformable to the principles and rules of the ecclesiastical courts. Judicial separation could be obtained by either husband or wife for adultery, or cruelty, or desertion continued for two or more years.

2. There were also transferred to the court powers equivalent to those exercised by the legislature in granting absolute divorce. The husband could obtain a divorce for adultery, the wife could obtain a divorce for adultery coupled with cruelty or desertion for two or more years, and also for incestuous or bigamous adultery, or rape, or unnatural offences. The same conditions as had been required by the legislature were insisted on. A petition for dissolution (sec. 30) was to be dismissed in case of connivance, condonation or collusion; and further, the court had power, though it was not compelled, to dismiss such petition if the petitioner had been guilty of adultery, or if there had been unreasonable delay in presenting or prosecuting the petition, or if the petitioner had been guilty of cruelty or desertion without reasonable excuse, or of wilful neglect or misconduct conducing to the adultery. The exercise of these discretionary powers of the court, just and valuable as they undoubtedly are, has been attended with some difficulty. But the view of the legislature has on the whole been understood to be that the adultery of a petitioner should not constitute a bar to his or her proceeding, if it has been caused by the misconduct of the respondent, and that cruelty should not constitute such a bar unless it has caused or contributed to the misconduct of the respondent. But the court, while regarding its powers as those of a judicial and not an arbitrary discretion, has declined to fetter itself by any fixed rule of interpretation or practice.

It is to be observed that this act assigned a new force to desertion. The ecclesiastical law regarded it only as suggestive of connivance or culpable neglect. But the act of 1857 made it (1) a ground of judicial separation if continued for two years, (2) a ground in part of dissolution of marriage if continued for the same period, (3) a bar, in the discretion of the court, to a petition for dissolution, though it was not made in a similar way any bar to a suit for judicial separation. It is also to be observed that the act was confined to causes of divorce recognized by the ecclesiastical law as administered in England. It did not either extend the causes of a suit for nullity by adding such grounds as

antenuptial incontinence, even if accompanied with pregnancy, nor did it borrow from the civil law of Rome either lunacy or crime as grounds for divorce.

Much comment has been made on the different grounds on which divorce is allowed to a husband and to a wife,—it being necessary to prove infidelity in both cases, but a wife being compelled to show either an aggravation of that offence or an addition to it. Opinions probably will always differ whether the two sexes should be placed on an equality in this respect, abstract justice being invoked, and the idea of marriage as a mere contract pointing in one direction, and social considerations in the other. But the reason of the legislature for making the distinction is clear. It is that the wife is entitled to an absolute divorce only if her reconciliation with her husband is neither to be expected nor desired. This was no doubt the view taken by the House of Lords. In 1801 a Mrs Addison claimed an absolute divorce on the ground of her husband's incest with her sister. The matter was long debated, but Lord Thurlow, who appeared in the House of Lords for the last time in order to support the bill, turned the scale by arguing that it was improper that the wife should under such circumstances return to her husband (see Campbell, *Lives of the Chancellors*, vii. 145). "Why do you," he said, "grant to the husband a divorce for the adultery of the wife? Because he ought not to forgive her, and separation is inevitable. Where the wife cannot forgive, and separation is inevitable by reason of the crime of the husband, the wife is entitled to the like remedy."

The act (sec. 32) provided, in case of dissolution, for maintenance of the wife by the husband on principles similar to those recognized by the ecclesiastical courts, and (sec. 45) for the settlement of the property of a guilty wife on her husband or children; but this enactment was imperfect, as provision was made only for a settlement and not for payment of an allowance, and none was made for altering settlements made in view of or in consequence of a marriage. The act (sec. 35) provides also in all divorce proceedings, and also in those of nullity, for provision for the custody, maintenance and education of children by the court: provisions of great value, which were unfortunately for some time limited by an erroneous view of the court that the age of the children to which such provisions applied should be considered limited to sixteen. The act of 1857 also transferred to the new court the powers exercised by the common law courts in the action for criminal conversation. It was made obligatory to join an alleged adulterer in the suit, and damages (sec. 33) might be claimed against him, and he might be ordered to pay the cost of the proceedings (sec. 34), the extent depending upon the circumstances of each case.¹

The act of 1857 in one respect went beyond a transfer of the powers exercised by the ecclesiastical courts or the legislature. It provided (sec. 21) that a wife deserted by her husband might apply to a magistrate in petty sessions and obtain an order which had the effect of protecting her earnings and property, and during the currency of such order of protection a wife was to be in the same position as if she had obtained an order for judicial separation. The effect of this section appears to have been small; but the Summary Jurisdiction (Married Women) Act 1895 has afforded a cheap and speedy remedy to all classes.

The framers of the act of 1857 were careful to avoid offending the scruples of clergymen who disapproved of the complete dissolution of marriage by a lay court. It was provided (secs.

57 and 58) that no clergyman should be compelled to solemnize the marriage of any person whose former marriage had been dissolved on the ground of his or her adultery, but should permit any other clergyman to solemnize the marriage in any church or chapel in which the parties were entitled to be married. It is to be feared that this concession, ample as it appears, has not allayed conscientious objections, which are perhaps from their nature insuperable. The act made no provision as to the name to be borne by a wife after a divorce; and this omission led to litigation in the case of a peer's wife, in *Cowley v. Cowley*, in which Lady Cowley was allowed to retain her status.

Modifications of the Act of 1857—Subsequent legislation has made good many of the defects of the act of 1857. In 1859 power was given to the court, after a decree of dissolution or of nullity of marriage, to inquire into the existence of ante- and post-nuptial settlements, and to make orders with respect to the property settled either for the benefit of children of the marriage or their parents; and a subsequent act (41 & 42 Vict. c. 19, s. 3) removed a doubt which was entertained whether these powers could be exercised if there were no children of the marriage. In 1860 a very important change was made, having for its object a practical mode of preventing divorces in cases of connivance and collusion or of misconduct of the petitioner. It was provided that a claim of dissolution (a provision afterwards extended to decrees of nullity) should in the first instance be a decree *nisi*, which should not be made absolute until the expiration of a period then fixed at not less than three, but by subsequent legislation enlarged to not less than six, months. During the interval which elapsed between the decree *nisi* and such decree being made absolute, power was given to any person to intervene in the suit and show cause why the decree should not be made absolute, by reason of the same having been obtained by collusion, or by reason of material facts not brought before the court; and it was also provided that, at any time before the decree was made absolute, the queen's proctor, if led to suspect that the parties were acting in collusion for the purpose of obtaining a divorce contrary to the justice of the case, might under the direction of the attorney-general intervene and allege such case of collusion. This enactment (extended in the year 1873 to suits for nullity) was ill drawn and unskillfully conceived. The power given to any person whomsoever to intervene is no doubt too wide, and practically has had little or no useful effect as employed by friends or enemies of parties to a suit. The limitation in terms of the express power of the queen's proctor to intervene in cases of collusion was undoubtedly too narrow. But the queen's proctor, or the official by whom that officer was afterwards represented, has in practice availed himself of the general authority given to any person to show cause why a decree *nisi* should not be made absolute, and has thus been enabled to render such important service to the administration of justice that it is difficult to imagine the due execution of the law of divorce by a court without such assistance. By the Matrimonial Causes Act 1866 power was given to the court to order an allowance to be paid by a guilty husband to a wife on a dissolution of marriage. This act also can hardly be considered to have been drawn with sufficient care, inasmuch as while it provides that if the husband's means diminish, the allowance may be diminished or suspended, it makes no corresponding provision for increase of the allowance if the husband's means increase; nor, apparently, does it permit of an allowance in addition to, but only in substitution for, a settlement. The act makes no provision for allowance to a guilty wife, and it certainly is a serious defect that the power to grant an allowance does not extend to cases of nullity. In 1868 an appeal to the House of Lords was given in cases of decree for dissolution or nullity of marriage.

The great changes effected by the Judicature Acts included the court for divorce and matrimonial causes. Under their operation a division of the high court of justice was constituted, under the designation of the probate division and admiralty division, to which was assigned that class of legal administration governed mainly by the principles and practice of the canon and civil law. The division consists of a president, and a justice of the high

¹ In *Constantinidi v. Constantinidi and Lanez* (1903), in which both parties were guilty of misconduct, it was held by Sir Francis Jeune (Lord St Helier) that where a wife has by her misconduct broken up the home (the husband's misconduct not having conducted to the wife's adultery) the court would exercise its discretion in favour of the husband petitioner, and, further, the wife being a rich woman, it was justifiable to give her husband a portion of her income, in order to preserve to him the position he would have occupied as her husband, the broad principle being that a guilty respondent should not be allowed to profit by divorce. But further litigation concerning this case occurred as to the variation of the marriage settlements in favour of the husband, and the decision of the court of appeal in July 1905 considerably modified the decision of Sir Francis Jeune.—*Ed. E. B.*

court, with registrars representing each branch of the jurisdiction. Appeals lie to the court of appeal, and thence to the House of Lords.

In 1884 the legislature interfered to prevent imprisonment being the result of disobedience to an order for restitution of conjugal rights. That mode of enforcing the order of the court was abolished, and the matter was left to a proper adjustment of the pecuniary relations of the husband and wife; and a respondent disobeying such an order was held to be guilty of desertion without reasonable cause, such desertion having further given to it a similar effect to that assigned to desertion for two years or upwards. The effect of this provision has been that the suit for restitution of conjugal rights is most frequently brought for the purpose of shortening the time within which a wife can obtain a decree for dissolution of marriage.

Proceedings in the divorce court have shown the improvement in the law of evidence which has been effected with regard to other legal proceedings. The act of 1857 made an inroad on the former law, which prohibited evidence being given by parties interested in the proceedings, by allowing a petitioner (sec. 43) to be called and examined by order of the court, absolving such petitioner, however, from the necessity of answering any question tending to show that he or she had been guilty of adultery. In the next year power was given to the court to dismiss any person, with whom a party to the suit was alleged to have committed adultery, from the suit if there should not appear to be sufficient evidence against him or her, the object being to allow such person to give evidence; and in 1859 it was provided that, on a petition by a wife for a divorce on the grounds of cruelty or desertion with adultery, the husband and wife could be competent and compellable witnesses as to the cruelty or desertion. A few years later, however, in 1869, the subject was finally dealt with by repealing all previous rules which limited the powers to give evidence on questions of adultery with the safeguard that no witness in any proceeding can be asked or bound to answer any question tending to show that he or she has been guilty of adultery, unless in the same proceeding such witness shall have given evidence in disproof of his or her alleged adultery. It has been held that the principles of these enactments apply to interrogatories as well as to evidence given in court.

It is a most remarkable omission in the act of 1857, especially when we remember the high legal authority from whom it proceeded, that the act nowhere defines the class of persons with regard to whom the jurisdiction of the court should be exercised. This omission has given rise to a misapprehension of the law which, though now set at rest, prevailed for a considerable period, and has undoubtedly led to the granting of divorce in several cases in which it could not legally be given. It was supposed that the court could grant a dissolution of marriage to all persons who had anything more than a casual and fleeting residence within the jurisdiction of the court; and this view, although its correctness was doubted by Lord Penzance, the judge of the divorce court, was upheld by a majority of the judges of the court of appeal in the case of *Niboyet v. Niboyet* (4 P. D. 1). It was supposed that such residence gave what was termed a matrimonial domicile. But this view was undoubtedly erroneous as regards dissolution of marriage, although probably correct as regards judicial separation, and the true view is no doubt that indicated with great learning and ability by Lord Watson in a judgment given by him in the privy council in the case of *Le Mesurier v. Le Mesurier* (1895, App. Cas. 517), that the only true test of jurisdiction for a decree of divorce altering the status of the parties to a marriage is to be found in the domicile of the spouses—that is to say, of the husband, as the domicile of a wife follows that of her husband—at the time of the divorce. Domicile means a person's permanent home, the place at which he resides with no intention of making his home elsewhere, and, if he leaves it, with the intention of returning to it.

It is now also clearly recognized as the law of England that the English courts will not recognize a divorce purporting to be made by a foreign tribunal with regard to persons domiciled in England. For a considerable time doubt appears to have clouded the law

on this subject. In a famous case known as *Lolley's case*, decided in 1812, the judges of England (the point arose in connexion with a criminal charge) unanimously held "that no sentence or act of any foreign country or any state could dissolve an English marriage *a vinculo matrimonii* for grounds on which it was not liable to be dissolved *a vinculo matrimonii* in England." This case has been frequently understood as deciding that a marriage celebrated in England cannot be dissolved elsewhere, and on this point the courts of Scotland differ from the view supposed to be taken by the English judges. But the matter has been fully explained in one of the most masterly of Lord Hennen's judgments (*Harvey v. Fairnie*, 5 P. D. 154), afterwards upheld by the House of Lords in 1882 (8 App. Cas. 43); and it is now clear that while the parties are domiciled in this country no decree of any foreign court dissolving their marriage will be recognized here, unless it proceed on the grounds on which a divorce may be obtained in this country, and even the exception just mentioned appears to rest rather on reasoning and principle than on the authority of any decided case. This principle received the highest sanction in the prosecution of Earl Russell for bigamy before the House of Lords (1901), in which it was held that, where a divorce had been refused him in England, an American divorce would not relieve a man from the guilt of marrying again.

Summary Proceedings for Separation.—The legislature has sought to extend the relief afforded by the courts in matrimonial causes by a procedure fairly to be considered within the reach of all classes. In 1895 an act was passed which re-enacted in an improved form the provisions of an act of 1878 of similar effect. By the act of 1895 power was given to a married woman whose husband (1) has been guilty of an aggravated assault upon her within the Offences against the Person Act 1861, or (2) convicted on indictment of an assault on her and sentenced to pay a fine of more than £5 or to imprisonment for more than two months, or (3) shall have deserted her, or (4) been guilty of persistent cruelty to her or wilful neglect to maintain her or her infant children, and by such cruelty or neglect shall have caused her to leave and live apart from him, to apply to a court of summary jurisdiction and to obtain an order containing all or any of the following provisions:—(1) that the applicant be not forced to cohabit with her husband, (2) that the applicant have the custody of any children under sixteen years of age, (3) that the husband pay to her an allowance not exceeding £2 a week. The act provides that no married woman guilty of adultery should be granted relief, but with the very important proviso, altering as it does the rule of the common law, that the husband has not condoned or connived at, or by wilful neglect or misconduct conducted to, such adultery. The provisions of this act¹ have been largely put in force, and no doubt to the great advantage of the poorer classes of the community. It will be observed that the act is unilateral, and affords no relief to a husband against a wife; and the complaint is often heard that no misconduct of the wife, except adultery, relieves the husband from the necessity of maintaining her and allowing her to share his home, unless he can obtain access to the high court.²

Separation Deeds.—Although nothing in the development of the law of divorce has tended to give to married persons the right absolutely to dissolve their marriage by consent, and, on the contrary, any such agreement would be held to be strong evidence of collusion, the view of the Church expressed in the ecclesiastical law has been entirely departed from as regards agreements for separation. Such agreements were embodied in deeds, and usually contained mutual covenants not to sue in the ecclesiastical courts for restitution of conjugal rights. The ecclesiastical

¹ It is to be noted that by a decision of the court of appeal in *Harriman v. Harriman* in 1909, where a wife has been deserted by her husband and has obtained a separation order within two years from the time when the desertion commenced, she loses her right to plead desertion under the Matrimonial Causes Act 1857, and is therefore not entitled to a divorce after two years' desertion, upon proof of adultery. See also *Dodd v. Dodd*, 1906, 22 T. L. R. 464.

² In 1909 a Royal Commission was appointed to inquire into the law of divorce, with special reference to the position of the poorer classes.

courts, however, wholly disregarded such agreements, and considered them as affording no answer to a suit for restitution of conjugal rights. For a considerable period the court of chancery refused to enforce the covenant in such deeds by restraining the parties from proceeding to the ecclesiastical courts. But at last a memorable judgment of Lord Westbury (1861) asserted the right (*Hunt v. Hunt*, 4 De G. F. & J. 221; see also *Marshall v. Marshall*, 5 P. D. 19) of the court of chancery to maintain the claim of good faith in this as in other cases, and restrained a petitioner from suing in the ecclesiastical court contrary to his covenant. Thereafter these deeds became common, and no doubt often afford a solution of matrimonial difficulties of very great value. When the courts of the country became united under the Judicature Acts, it became practicable to set up in the divorce division a separation deed in answer to a suit for restitution of conjugal rights without the necessity of recourse to any other tribunal.

Statistics.—The statistics of divorce in England have for some years been regularly published in the volumes of judicial statistics published annually by the Home Office.

The number of petitions for divorce (including in the term both divorce *a mensa et thoro* and divorce *vinculo*) for the years from 1858 to 1905 inclusive are as follows:—

1858	326	1874	469	1890	644
1859	291	1875	451	1891	632
1860	272	1876	536	1892	629
1861	236	1877	551	1893	645
1862	248	1878	632	1894	652
1863	298	1879	555	1895	683
1864	297	1880	615	1896	772
1865	284	1881	589	1897	772
1866	279	1882	481	1898	750
1867	294	1883	561	1899	727
1868	303	1884	647	1900	698
1869	351	1885	541	1901	848
1870	351	1886	708	1902	987
1871	384	1887	662	1903	914
1872	374	1888	680	1904	822
1873	416	1889	654	1905	844

It is probably impossible to account for the variations which the above table discloses. It was no doubt natural that the year immediately succeeding the passing of the act which originated facilities for divorces *a vinculo* should exhibit a larger number of divorces than its successors for a considerable period. But there does not appear to be any adequate cause for the comparative increase which seems to have prevailed in the decade between 1878 and 1888, unless it be found in the increase of marriages which culminated in 1873 and 1883, falling after each of those years. The number of marriages again rose high in 1891 and 1892, and this may account for the increased number of divorces in 1896 and the following years. But it may certainly be said with confidence that as compared with the growth of population the number of divorces in England has shown no alarming increase.

The total number of petitions in matrimonial causes presented by husbands exceed those presented by wives, but in no marked degree. This excess would seem to be due to the fact that the larger number of petitions for dissolution presented by husbands, owing no doubt to the difference in the law affecting the two sexes, is not entirely counterbalanced by the much larger number of petitions for judicial separation presented by wives. The following figures for various years may be taken as typical:—

	1895	1896	1897	1898	1899	1905
Petitions for Dissolution—						
Presented by husbands	353	393	414	401	383	429
Presented by wives	220	280	269	243	262	323
Petitions for Judicial Separation—						
Presented by husbands	4	3	2	4	4	5
Presented by wives	106	96	96	102	78	87
Totals—						
Presented by husbands	357	396	416	405	387	434
Presented by wives	326	376	365	345	340	410

Speaking generally, it may be said that about 70% of the petitions presented are successful and result in decrees. This percentage has a tendency, however, to rise.

Attempts have been made to ascertain the classes which supply the petitioners for divorce, but this cannot be done with such certainty as to warrant any but the most general conclusions. It may, however, safely be said that while all classes, professions and occupations are represented, it is certainly not those highest in the

scale that are the largest contributors. The principles of the act of 1857 have beyond question been justified by the relief required by and afforded to the general community.

OTHER EUROPEAN COUNTRIES

We may now turn to the law of divorce as administered in the other countries of the modern world. On the main question whether marriage is to be considered indissoluble they will be found to range themselves on one side or the other according to the influence upon them of the Church of Rome and its canon law.

In *Scotland* it has long been the law that marriage can be dissolved at the instance of either party by judicial sentence on the grounds of adultery or of desertion, termed non-adherence, and the spouses could in such case remarry, except with the paramour, —at all events if the paramour was named in the decree (and the name is sometimes omitted for that reason). A divorce *a mensa et thoro* could also be granted for cruelty. By the Court of Session Act 1830, the jurisdiction in divorce was transferred from a body of commissaries to the court of session.

By the law of *Holland* complete divorce could be granted by judicial sentence on the grounds of adultery or of wilful and malicious desertion, to which were added unnatural offences and imprisonment for life, and such divorce gave the power of remarriage, except with the person with whom adultery was proved to have been committed, but there would seem to be a doubt whether this power extended to the guilty party (Voet, *De divorciis*, lit. 24, tit. 2). Divorce *a mensa et thoro* could be granted on the grounds allowed by the canon law.

The Code of *Prussia* of 1794 contained elaborate provisions which gave great facility of divorce. A complete divorce could be obtained by judicial sentence for the following causes:— (1) Adultery or unnatural offences; and adultery by a husband formed no bar to his obtaining a divorce against his wife for adultery; and even an illicit intimacy, from which a presumption of adultery might arise, was held sufficient for a divorce. (2) Wilful desertion. (3) Obstinate refusal of the rights of marriage, which was considered as equivalent to desertion. (4) Incapacity to perform the duties of marriage, even if arising subsequently to the marriage; and the same effect was assigned to other incurable bodily defects that excited disgust and horror. (5) Lunacy, if after a year there was no reasonable hope of recovery. (6) An attempt on the life of one spouse by the other, or gross and unlawful attack on the honour or personal liberty. (7) Incompatibility of temper and quarrelsome disposition, if rising to the height of endangering life or health. (8) Opprobrious crime for which either spouse has suffered imprisonment, or a knowingly false accusation of such crime by one spouse of the other. (9) If either spouse by unlawful transactions endangers the life, honour, office or trade of the other, or commences an ignominious employment. (10) Change of religion. In addition to these causes, marriages, when there were no children, could be dissolved by mutual consent if there be no reason to suspect levity, precipitation or compulsion; and a judge had also power to dissolve a marriage in cases in which a strongly rooted dislike appeared to him to exist. In all cases of divorce, but sometimes subject to the necessity of obtaining a licence, remarriage was permissible (see Burge, *Commentaries on Colonial and Foreign Law*, vol. i. 649).

Before 1876 only a divorce *a vinculo* could be obtained in some of the German states, especially if the petitioner were a Roman Catholic. The only relief afforded was a "perpetual separation." By the Personal Status Act 1875 perpetual separation orders were abolished and divorce decrees allowed in cases where the petitioners would, under the former law, have been entitled to a perpetual separation order. However, two Drafting Commissions under the act declined to alter the new rule, but under pressure from the Roman Catholic party the Reichstag passed a law introducing a modified separation order, termed "dissolution of the conjugal community" (*Aufhebung der ehelichen Gemeinschaft*). This order can be converted into a dissolution of the marriage at the option of either party. Under the Civil Code of 1900 a petitioner can obtain a divorce or judicial

separation on "absolute" or "relative" grounds. In the former case if the facts are established the petitioner is entitled to the relief prayed for; in the latter case, it is left to judicial discretion. The absolute grounds are adultery, bigamy, sodomy, a marriage at the suit of the other, without, in the case of adultery by the husband, the aggravation of introduction of the concubine into the home required by the Code; (2) violence (*excess*) or cruelty (*services*); (3) *injures graves*; and (4) *peine afflictive et infamante*. *Excess* is defined by Locié as "a generic expression comprising all acts tending to compromise the safety of the person, without distinction as to their object or motive, premeditation as well as furious anger, attempts upon life as well as serious wounding." *Services* are acts of ill-treatment less grave in character, which, while not endangering life, render existence in common intolerable (Kelly's *French Law of Marriage*, p. 122). *Injures graves*, as to which the courts have considered themselves entitled to exercise a wide discretion, have been defined as acts, writings or words which reflect upon the honour or the reputation of the party against whom they are directed. The courts have held that retraction at the trial does not relieve the party from the consequences of an *injure grave*, and that publicity is an aggravating but not a necessary element. A letter from one spouse to the other may constitute an *injure* and the courts have further held themselves at liberty to consider letters written after divorce proceedings have been commenced. *Injures graves* have also been considered to include material injuries, and among these have been classed habitual and groundless refusal of matrimonial rights, communication of disease and refusal to consent to a religious ceremony of marriage. Habitual but not occasional drunkenness has also been held to fall within the definition of an *injure grave*. *Peine afflictive et infamante* signifies a legal punishment involving corporal confinement and moral degradation.¹

By the law of Denmark, according to the Code of King Christian the Fifth, complete divorce could be obtained for incest; for leprosy, whether contracted before or after marriage; for transportation for crime or flight from justice, after three years, though not for crime itself; and for exile not arising from crime, after seven years.

In Sweden complete divorce is granted by judicial sentence for adultery, and in Russia for that cause and also for incompatibility of temper (Ayliffe, Par. 49). On the other hand, in Spain marriage is indissoluble, and the ecclesiastical courts have retained their exclusive cognizance of matrimonial causes. In Italy certain articles of the Civil Code deal with separation, voluntary and judicial, but divorce is not allowed in any form.

In France the law of divorce has had a chequered history. Before the Revolution the Roman canon law prevailed, marriage was considered indissoluble, and only divorce *a mensa et thoro*, known as *la séparation d'habitation*, was permitted; though it would appear that in the earliest age of the monarchy divorce *a vinculo matrimonii* was allowed. *La séparation d'habitation* was granted at the instance of a wife for cruelty by her husband or false accusation of a capital crime, or for habitual treatment with contempt before the inmates of the house; but a wife could not obtain a separation for adultery by her husband, although he had his remedy in case of adultery by his wife. In every case the sentence of a judicial tribunal, which took precautions against collusion, was necessary. But the Revolution may be said to have swept away marriage among the institutions which it overwhelmed, and by the law of the 20th of September 1792 so great facility was given for divorce *a vinculo matrimonii* as practically to terminate the obligations of marriage. A reaction came with the Code Napoléon, yet even under that system of law divorce remained comparatively easy. Mutual consent, expressed in the manner and continued for a period specified by the law, was cause for a divorce (the principle of the Roman law being adopted on this point), but such consent could not take place unless the husband was twenty-five years of age and the wife twenty-one, unless they had been married for two years, nor after twenty years of marriage, nor after the wife had completed her forty-fifth year; and further, the approval of the parents of both parties was required. In case of divorce by consent, the law required that a proper agreement should be made for the maintenance of the wife and the custody of the children. A husband could obtain a divorce *a vinculo matrimonii* for adultery, but the wife had no such power unless the husband had brought his mistress to the home. Both husband and wife could claim divorce on the ground of outrage, or grievous bodily injury, or condemnation for an infamous crime. If the divorce was for adultery, the erring party could not marry the partner of his or her guilt. A divorce *a mensa et thoro* could be obtained on the same grounds as a divorce *a vinculo*, but not by mutual consent; and if the divorce *a mensa et thoro* continued in force for three years, the defendant party could claim a divorce *a vinculo*. On the restoration of royalty in 1816 divorce *a vinculo* was abolished, and pending suits for divorce *a vinculo* were converted into suits for separation only.

Divorce in France, after the repeal of the provisions respecting it in the Code Napoléon in 1816, was re-enacted by a law of the 27th of July 1884, the provisions of which were simplified by

laws of 1886 and 1907. But a wide departure was made by these laws from the terms of the Code Napoléon. Divorce by consent disappeared, and the following became the causes for which divorce was allowed: (1) Adultery by either party to the marriage at the suit of the other, without, in the case of adultery by the husband, the aggravation of introduction of the concubine into the home required by the Code; (2) violence (*excess*) or cruelty (*services*); (3) *injures graves*; and (4) *peine afflictive et infamante*. *Excess* is defined by Locié as "a generic expression comprising all acts tending to compromise the safety of the person, without distinction as to their object or motive, premeditation as well as furious anger, attempts upon life as well as serious wounding." *Services* are acts of ill-treatment less grave in character, which, while not endangering life, render existence in common intolerable (Kelly's *French Law of Marriage*, p. 122). *Injures graves*, as to which the courts have considered themselves entitled to exercise a wide discretion, have been defined as acts, writings or words which reflect upon the honour or the reputation of the party against whom they are directed. The courts have held that retraction at the trial does not relieve the party from the consequences of an *injure grave*, and that publicity is an aggravating but not a necessary element. A letter from one spouse to the other may constitute an *injure* and the courts have further held themselves at liberty to consider letters written after divorce proceedings have been commenced. *Injures graves* have also been considered to include material injuries, and among these have been classed habitual and groundless refusal of matrimonial rights, communication of disease and refusal to consent to a religious ceremony of marriage. Habitual but not occasional drunkenness has also been held to fall within the definition of an *injure grave*. *Peine afflictive et infamante* signifies a legal punishment involving corporal confinement and moral degradation.¹

In addition to its recognition of full divorce, the French law recognizes separation of two kinds, one *séparation de biens* and the other *séparation de corps*. The effect of *séparation de biens* is merely to put an end to the community of goods between the spouses. It necessarily follows, but may be decreed independently of *séparation de corps*. The grounds of *séparation de corps* are the same as those for a divorce; and if a *séparation de corps* has existed for three years, it may be turned into a divorce upon the application of either party to the court.

Until 1893 a wife *séparée de corps* obtained only the capacity attaching to a concomitant *séparation de biens*; that is to say, she recovered the enjoyment and management of her separate property, but could not deal with real property, nor take legal proceedings, without the sanction of her husband or of the court. But by a law of the 6th of February 1893 a wife *séparée de corps* obtains "the full exercise of her civil capacity, so that she shall not need to resort to the authority of her husband or of the court." In case of reconciliation, the wife returns to the limited capacity of a wife *séparée de biens*, and after the prescribed notification of such change of status it becomes binding on third persons.

The provisions of French law with regard to the custody of the children of a dissolved marriage, and with regard to property, do not differ materially from those prescribed by the English acts. The custody of children is given to the party who has obtained the divorce, unless the court, on the application of the family, or the *ministère public*, consider it better, in the interests of the children, that custody should be given to the other party or a third person; but in every case the right of both father and mother to supervise the maintenance and education of the children, and their liability to contribute to their support, are continued.

¹ It is interesting to observe how, according to the latest decisions of the House of Lords, cruelty, according to English law, includes some but not others of the forms of injury for which, under the term of *injures graves*, the French law affords a remedy. It may well be doubted whether the view taken by the minority of the peers in *Russell v. Russell*, which would have included in the definition of cruelty all, or nearly all, of that which the French law deems either *services* or *injures graves*, would not have better satisfied both the principles of English jurisprudence and the feelings of modern life.

The law in France as to property on a divorce has been accurately stated as follows:—

"Divorce in France effects a dissolution of the matrimonial régime of property as well as of the marriage itself. The decree appoints a notary, who is charged with the settlement of the pecuniary interests of the parties. By a stereotyped form of procedure the appointment is made invariably for the purpose of liquidating *le commissariat*; *opon existit entre les époux*, irrespective of whether the rights really was that of community or another. In the case of aliens, therefore, married under the rule of separate property, it is necessary carefully to set this out in the notarial deed of liquidation, in order to defeat the presumption which might be raised by the wording of the decree that a community really did exist. The party against whom the divorce has been pronounced loses the benefit of all settlements made upon him or her by the other party, either by the marriage contract or since the marriage. On the other hand, the party in whose favour the divorce has been pronounced preserves the benefit of all settlements made in his or her favour by the unsuccessful party. If no such settlements were made, or if those made appear inadequate to ensure the subsistence of the successful party, the court may grant him or her permanent alimony out of the property of the other party, not to exceed one-third of the income, and revocable in case it ceases to be necessary" (Kelly, p. 130).

On a divorce both parties are at liberty to remarry. The husband could remarry at once; but the wife (art. 296 of the Code) was only allowed to remarry after an interval of ten months. By the act of 1907, this article was abolished, and the wife allowed to remarry as soon as the judgment or decree granting the divorce has been entered, providing 300 days have elapsed since the first judgment was pronounced. A divorced husband may remarry his divorced wife, but if he does so, he cannot be again divorced, except on the ground of a sentence to a *peine afflictive et infamante* passed on one of them since their remarriage. There is, however, this limitation on the power of remarriage of divorced persons, that the party to the marriage against whom the decree has been pronounced is not allowed to marry the person with whom his or her guilt has been established. Such person, however, has no such rights as are recognized in him or her according to English law, and cannot take any part in the proceedings. But his or her name is referred to in the proceedings only by an initial; and French law goes even further in the avoidance of publicity, inasmuch as the publication of divorce proceedings in the press is forbidden, under heavy penalties.

By a law of the 6th of February 1893 French jurisprudence, more complete at least, and perhaps wiser, than English, dealt with a matter previously in controversy, and decided that after a divorce the wife shall resume her maiden name, and may not continue to use the name of her divorced husband nor may the husband, for business or other purposes, continue to use the name of his wife.

By the law of 1886 the special procedure in divorce previously in force under the Code and under the law of 1884 was abolished, and it was provided that matrimonial causes should be tried according to the ordinary rules of procedure. The action therefore, when brought, follows the methods of procedure common to other civil proceedings. But there still remain certain necessary preliminaries to an action of divorce. A petition must be presented by a petitioner in person to the president of the court sitting in chambers, with the object of a reconciliation being effected. This is known as the *première comparation*. If the petitioner still determines to proceed, there follows the *secondé comparation*, on which occasion both parties appear before the president. If the president fails to effect a reconciliation, he makes an order permitting the petitioner to proceed, and deals with the matters necessary to be dealt with *pendente lite*, such matters being (1) separate residence, (2) alimony, (3) possession of personal effects, (4) custody of children. As regards residence, the wife is compelled to adhere during the proceedings to the residence assigned to her, but no similar restriction is placed on the husband. Alimony *pendente lite* is in the discretion of the court, having regard to the means of the parties, and includes a proper provision for costs. As regards the custody of children, the Code and the law of 1884 gave it to the husband, unless the court otherwise orders, but the law of 1886 leaves the matter wholly in the discretion of the court.

There are certain technical rules of evidence on the trial of

a divorce action. It is a general principle of the French law of evidence that documentary evidence is the best evidence, and oral testimony only secondary. In divorce cases adultery *flagrante delicto* can be proved by the official certificate of the commissary of police. Letters between the husband and wife are admissible in evidence. As to letters between the parties and third persons, the law, which has been doubtful, now appears to be that the wife may produce only such letters from third parties to her husband as have come into her possession accidentally, and without any ruse or artifice on her part; but the husband may put in evidence any letters written to or by his wife which he has obtained by any, short of criminal, means. If the documents put in evidence are not sufficient to satisfy the court, there follows an investigation by means of witnesses, termed an *enquête*. A schedule of allegations is drawn up, and a judge, termed a *juge-commissaire*, is specially appointed to conduct the inquiry. Relatives and servants, though not competent witnesses in ordinary civil actions, are so in divorce proceedings. Cross petitions may be entered; the substantiation of a cross petition, however, does not have the effect, in some cases given to it by English law, of barring a divorce, but a divorce may be, and often is, granted in favour of and against both parties *pour torts réciproques*. When a case comes on for trial, it is in the power of the court to order an adjournment for a period not exceeding six months, which is termed a *temps d'épreuve*, in order to afford an opportunity for reconciliation. It is said, however, that this power is seldom exercised. An appeal may be brought against a decree of divorce within two months; and a decree made on appeal is subject to revision by the court of cassation within two months. Both references to the court of appeal and the court of cassation operate as a stay of execution. A decree must, by the law of 1886, be transcribed on the register of marriages within two months from its date, and failing this transcription, the decree is void. The transcription must be made at the place of celebration of the marriage, or, if the parties are married abroad, at the place where the parties were last domiciled in France. If the parties, after having married abroad, return to France, it has been provided, by a circular of the *Procureur de la République* in 1887, that the transcription may be made at the place of their actual domicile at the time of action brought, a rule which has been held to apply to the divorce of aliens in France. The effect of transcription does not relate back to the date of the decree.

Opinions may differ as to the relative merits of the English and French law relating to divorce. But it cannot be denied that the French law presents a singularly complete and well-considered system, and one which, obviously with the English system in view, has endeavoured to graft on it provisions supplementing its omissions, and modifying certain of its terms in accordance with the light afforded by experience and the changed feelings of the modern world. The effect of the laws of 1884 and 1886 in France has been great. The act of 1907 dealing with divorce, coupled with that of the 21st of July of the same year dealing with marriage, may also be said to mark an epoch in the laws relating to women. During the five years from 1884 to 1888 the courts granted divorces in 21,064 cases, rejecting applications for divorce in 1524. In addition, there were 12,242 applications for judicial separation, of which 70,739 were granted. A distinguished French writer, the author of a work of singular completeness and accuracy on the judicial system of Great Britain has compared these figures with the corresponding result of the English act of 1857. His conclusion is expressed in these words: "On voit qu'en cinq années nos tribunaux ont prononcé trois fois plus de divorces que la haute cour d'Angleterre n'en a prononcé en trente ans. Je n'insiste pas sur les conclusions morales à tirer de ce rapprochement." (Comte de Franqueville, *Le Système judiciaire de la Grande-Bretagne*, ii. p. 171.) It is, however, practically impossible to compare the number of divorces in France and in England with exact justice, because, as will have been seen above, the causes of divorce in France materially exceed those recognized by English law; and the absence in France of any official performing the functions assigned to the king's proctor in England cannot but have great influence on the number of applications for divorce, as well as on their results. (St H.)

UNITED STATES

According to American practice, divorce is the termination by proper legal authority, sometimes legislatively but usually judicially, of a marriage which up to the time of the decree was legal and binding. It is to be distinguished from a decree of

nullity of marriage, which is simply a legal determination that no legal marriage has ever existed between the two parties. It is also to be distinguished from a decree of separation, which permits or commands the parties to live apart, but does not completely and for all purposes sever the marriage tie. The matrimonial law of England, as at the time of the declaration of independence, forms part of the common law of the United States. But as no ecclesiastical courts have ever existed there, the law must be considered to have been inoperative. There is no Federal jurisdiction in divorce, and it is a question for the law of each separate state; and though it is competent to Congress to authorize divorces in the Territories, still it appears that this subject like others is usually left to the territorial legislature. In the different states, and in England, divorces were at first granted by the legislatures, whether directly or by granting special authority to the tribunals to deal with particular cases. This practice fell into general disrepute, and by the constitution of some states such divorces are expressly prohibited.

Upon the subject of divorce in the United States, and, to some extent, in foreign countries, a careful investigation was made by the American Bureau of Labour, and its report covered the years 1867 to 1886; a further report for the period 1887 to 1906 has also been published by the Federal Census Bureau. The number of divorces was in 1886 over 25,000, and in 1906 was over 72,000, about double the number reported for that year from all the rest of the Christian world. As divorce presupposes a legal marriage, the amount of divorce, or the divorce-rate, is best stated as the ratio between the number of divorces decreed during a year and the number of subsisting marriages or married couples. The usual basis is 100,000 married couples. In 1898-1902 the divorce-rate was 200 divorces (400 people) to 100,000 married couples. This is equivalent to more than one divorce annually to each 1400 people. The several states differ in divorce-rate, from South Carolina, with no provision for legal divorce, to Montana and Washington, where the rate is two and a half times the average for the country. In general the rate is about the same in the North as in the South, but greater in the Central states than in the East, and in the Western than in the Central states; but to this rule the New England states, Louisiana, New Mexico and Arizona are exceptions. The New England states have a higher rate than their geographical position would lead one to expect, and the other three, owing doubtless, in part at least, to the influence of the Roman Catholic Church, have a lower rate than the states about them. The several state groups had in 1900 the following divorce-rates per 100,000: South Atlantic, 196; North Atlantic, 200; South Central, 358; North Central, 510; Western, 712. The divorce-rate in the United States increased rapidly and steadily in forty years from 27 in 1867 to 86 in 1906. But distinct tendencies are traceable in different regions. In the North Atlantic group the rate rose by 58%, in the North Central by 158%, in the Western by 223%, in the South Atlantic by 437%, and in the South Central by 685%. The great increase in the South was mainly due to the spread of divorce among the emancipated negroes. Each state determines for itself the causes for which divorce may be granted, and no general statement is therefore possible.

The ground pleaded for a divorce is seldom an index to the motives which caused the suit to be brought. This is determined by the character of the law rather than by the state of mind of the parties; and so far as the individuals are concerned, the ground alleged is thus a cloak rather than a clue or revelation. Still those causes which have been enacted into law by the various state legislatures do indicate the pleas which have been endorsed by the social judgment of the respective communities. In the United States exclusive of Alaska and the recent insular accessions there are forty-nine different jurisdictions in the matter of divorce. Six out of every seven allow divorce for desertion, adultery or cruelty; and of the 945,625 divorces reported with their causes during the twenty years 1887-1906 nearly 78% were granted for some one of these three causes, viz. 30% for desertion, 22% for adultery, and 16% for cruelty. Probably nearly 9% more were for some combination of these causes. Three other grounds for divorce are admitted as legal in many or most American states, viz.

imprisonment in 39, habitual drunkenness in 38, and neglect to provide in 22. About 98% of American divorces are granted on some one or more of these six grounds. In general the legislation on the subject of the causes allowed for divorce is most restrictive in the states on the Atlantic coast, from New York to South Carolina inclusive, and is least so in the Western states. The slight expense of obtaining a divorce in many of the states, and the lack of publicity which is given to the suit, are also important reasons for the great number of decrees issued. The importance of the former consideration is reflected in the fact that the divorce-rate for the United States as a whole shows clearly, in its fluctuations, the influences of good and bad times. When times are good and the income of the working and industrial classes likely to be assured, the divorce-rate rises. In periods of industrial depression it falls, fluctuating thus in the same way and probably for the same reason that the marriage-rate in industrial communities fluctuates. In two-thirds of the divorce suits the wife is the plaintiff, and the proportion slightly increased in the forty years. In the Northern states the percentage issued to wives (1887-1906) was 71, while in the Southern states it was only 56. But where both parties desire a decree, and each has a legal ground to urge, a jury will usually listen more favourably to a woman's suit.

Divorce is probably especially frequent among the native population of the United States, and among these probably more common in the city than in the country. This statement cannot be established absolutely, since statistics afford no means of distinguishing the native from the foreign-born applicants. It is, however, the most obvious reason for explaining the fact that, while in Europe the city divorce-rate is from three to five times as great as that of the surrounding country, the difference in the United States between the two regions is very much less. In other words, the great number of foreigners in American cities probably tends to obscure by a low divorce-rate the high rate of the native population. Divorce is certainly more common in the New England states than in any others on the Atlantic coast north of Florida, and it is not unlikely that wherever the New England families have gone divorce is more frequent than elsewhere. For example, it is much more common in the northern counties of Ohio settled largely from New England than in the southern counties settled largely from the Middle Atlantic states.

There are two statements frequently made regarding divorce in the United States which do not find warrant in the statistics on the subject. The first is, that the real motive for divorce with one or both parties is the desire for marriage to a third person. The second is, that a very large proportion of divorces are granted to persons who move from one jurisdiction to another in order to avail themselves of lax divorce laws. On the first point the American statistics are practically silent, since, in issuing a marriage licence to parties one or both of whom have been previously divorced, no record is generally made of the fact. In Connecticut, however, for a number of years this information was required; and, if the statements were trustworthy, the number of persons remarrying each year was about one-third the total number of persons divorcing, which is probably a rate not widely different from that of widows and widowers of the same age. Foreign figures for Switzerland, Holland and Berlin indicate that in those regions the proportion of the divorced who remarry speedily is about the same as that of widows and widowers. What statistical evidence there is on the subject therefore tends to discredit this popular opinion. The evidence on the second point is more conclusive, and has gone far towards decreasing the demand for a constitutional amendment allowing a federal marriage and divorce law. About four-fifths of all the divorces granted in the United States were issued to parties who were married in the state in which the decree of divorce was later made; and when from the remaining one-fifth are deducted those in which the parties migrated for other reasons than a desire to obtain an easy divorce, the remainder would constitute a very small, almost a negligible, fraction of the total number.

It is difficult, perhaps impossible, to say how far the frequency of divorce in the United States has been or is a social injury; how far it has weakened or undermined the ideal of marriage as a lifelong

union between man and woman. In this respect the question is very like that of illegitimacy; and as the most careful students of the latter subject agree that almost no trustworthy inference regarding the moral condition of a community can be derived from the proportion of illegitimate children born, so one may say regarding the prevalence of divorce that from this fact almost no inferences are warranted regarding the moral or social condition of the population. It is by no means impossible, for example, that the spread of divorce among the negro population in the South marks a step in advance from the condition of largely unregulated and illegal unions characteristic of the race immediately after the war. The prevalence of divorce in the United States among the native population, in urban communities, among the New England element, in the middle classes of society, and among those of the Protestant faith, indicates how closely this social phenomenon is interlaced with much that is characteristic and valuable in American civilization. In this respect, too, the United States perhaps represent the outcome of a tendency which has been at work in Europe at least since the Reformation. Certainly the divorce-rate is increasing in nearly every civilized country. Decrees of nullity of marriage and decrees of separation not absolutely terminating the marriage relation are relatively far less prevalent than they were in the medieval and early modern period, and many persons who under former conditions would have obtained relief from unsatisfactory unions through one or the other of these avenues now resort to divorce. The increasing proportion of the community who have an income sufficient to pay the requisite legal fees is also a factor of great importance. The belief in the family as an institution ordained of God, decreed to continue "till death us do part," and in its relations typifying and perpetuating many holy religious ideas, probably became weakened in the United States during the 19th century, along with a weakening of other religious conceptions; and it is yet to be determined whether a substitute for these ideas can be developed under the guidance of the motive of social utility or individual desire. In this respect the United States is, as Mr Gladstone once wrote, a *tribus praeorgata*, but one who knows anything of the family and home life of America will not readily despond of the outcome.

The great source of American statistical information is the governmental report of over 1000 pages, *A Report on Marriage and Divorce in the United States 1807 to 1886, including an Appendix relating to Marriage and Divorce in Certain Countries of Europe*, by Carroll D. Wright, Commissioner of Labour; together with the former report for 1887 to 1906. The statistics contained in the former volume have been analysed and interpreted in W. F. Willcox's *The Divorce Problem: A Study in Statistics* (Columbia University, New York, 1891, 1897). Further interpretations are contained in an article in the *Political Science Quarterly* for March 1893, entitled "A Study in Vital Statistics." The best legal treatise is probably Bishop on *Marriage, Divorce, and Judicial Separation*. See also J. P. Lichtenberger, *Divorce: A Study in Social Causation* (New York, 1909). (W. F. W.)

DIWANIEH, a small town in Turkish Asia, about 40 m. below Hillah, on both banks of the Euphrates (31° 58' 47" N., 44° 58' 18" E.), which is here spanned by a floating bridge. Formerly a military post for the control of the Affech territory, and a telegraph station, it was in 1893 made the capital of the sanjak, instead of Hillah, on account of its more strategical position. This transfer of the seat of government represented a step in the development of Turkish control over the central regions of Irak.

DIX, DOROTHEA LYNDE (1802-1887), American philanthropist, was born at Hampden, Maine, on the 4th of April 1802. Her parents were poor and shiftless, and at an early age she was taken into the home in Boston of her grandmother, Dorothea Lynde, wife of Dr Elijah Dix. Here she was reared in a distinctly Puritanical atmosphere. About 1821 she opened a school in Boston, which was patronized by the well-to-do families; and soon afterwards she also began teaching poor and neglected children at home. But her health broke down, and from 1824 to 1830 she was chiefly occupied with the writing of books of devotion and stories for children. Her *Conversations on Common Things* (1824) had reached its sixtieth edition by 1860. In 1831 she established in Boston a model school for girls, and conducted

this successfully until 1836, when her health again failed. In 1841 she became interested in the condition of gaols and almshouses, and spent two years in visiting every such institution in Massachusetts, investigating especially the treatment of the pauper insane. Her memorial to the state legislature dealing with the abuses she discovered resulted in more adequate provision being made for the care and treatment of the insane, and she then extended her work into many other states. By 1847 she had travelled from Nova Scotia to the Gulf of Mexico, and had visited 18 state penitentiaries, 300 county gaols and houses of correction, and over 500 almshouses. Her labours resulted in the establishment of insane asylums in twenty states and in Nova Scotia and Newfoundland, and in the founding of many additional gaols and almshouses conducted on a reformed plan. In 1853 she secured more adequate equipment for the life-saving service on Sable Island, then rightly called "the graveyard of ships." In 1854 she secured the passage by Congress of a bill granting to the states 12,250,000 acres of public lands, to be utilized for the benefit of the insane, deaf, dumb and blind; but the measure was vetoed by President Pierce. After this disappointment she went to England for rest, but at once became interested in the condition of the insane in Scotland, and her report to the home secretary opened the way for sweeping reforms. She extended her work into the Channel Islands, and then to France, Italy, Austria, Greece, Turkey, Russia, Sweden, Norway, Denmark, Holland, Belgium and a part of Germany. Her influence over Arinori Mori, the Japanese *chargé d'affaires* at Washington, led eventually to the establishment of two asylums for the insane in Japan. At the outbreak of the Civil War she offered her services to the Federal government and was appointed superintendent of women nurses. In this capacity she served throughout the war, without a day's furlough; and her labours on behalf of defectives were continued after the war. After a lingering illness of six years she died at Trenton, New Jersey, on the 17th of July 1887.

See Francis Tiffany, *Life of Dorothea Lynde Dix* (Boston, 1892).

DIX, JOHN ADAMS (1798-1879), American soldier and political leader, was born at Boscawen, New Hampshire, on the 24th of July 1798. He studied at Phillips Exeter Academy in 1810-1811 and at the College of Montreal in 1811-1812, and as a boy took part in the War of 1812, becoming a second lieutenant in March 1814. In July 1828, having attained the rank of captain, he resigned from the army, and for two years practised law at Cooperstown, New York. In 1830-1833 he was adjutant-general of New York. He soon became prominent as one of the leaders of the Democratic party in the state, and for many years was a member of the so-called "Albany Regency," a group of Democrats who between about 1820 and 1850 exercised a virtual control over their party in New York, dictating nominations and appointments and distributing patronage. From 1833 to 1839 he was secretary of state and superintendent of schools in New York, and in this capacity made valuable reports concerning the public schools of the state, and a report (1836) which led to the publication of the *Natural History of the State of New York* (1842-1866). In 1842 he was a member of the New York assembly. In 1841-1843 he was editor of *The Northern Light*, a literary and scientific journal published in Albany. From 1845 to 1849 he was a United States senator from New York; and as chairman of the committee on commerce was author of the warehouse bill passed by Congress in 1846 to relieve merchants from immediate payment of duties on imported goods. In 1848 he was nominated for governor of New York by the Free Soil party, but was defeated by Hamilton Fish. His acceptance of the nomination, however, earned him the enmity of the southern Democrats, who prevented his appointment by Pierce as secretary of state and as minister to France in 1853. In this year Dix was for a few weeks assistant U.S. treasurer in New York city. In May 1860 he became postmaster of New York city, and from January until March 1861 he was secretary of the treasury of the United States, in which capacity he issued (January 29, 1861) to a revenue officer at New Orleans a famous order containing the words, "if any one attempts to haul down the American flag,

shoot him on the spot." He rendered important services in hurrying forward troops in 1861, was appointed major-general of volunteers in June 1861, and during the Civil War commanded successively the department of Maryland (July 1861–May 1862), Fortress Monroe (May 1862–July 1863), and the department of the East (July 1863–July 1865). He was minister to France from 1866 to 1869, and in 1872 was elected by the Republicans governor of New York, but was defeated two years later. He had great energy and administrative ability, was for a time president of the Chicago & Rock Island and of the Mississippi & Missouri railways, first president of the Union Pacific in 1863–1868, and for a short time in 1872 president of the Erie. He died in New York city on the 21st of April 1879. Among his publications are *A Winter in Madeira and a Summer in Spain and Florence* (1850), and *Speeches and Occasional Addresses* (1864). He wrote excellent English versions of the *Dies irae* and the *Stabat mater*.

His son, MORGAN DIX (1827–1908), graduated at Columbia in 1848 and at the General Theological Seminary in 1852, and was ordained deacon (1852) and priest (1853) in the Protestant Episcopal church. In 1855–1859 he was assistant minister, and in 1859–1862 assistant rector, of Trinity Church, New York city, of which he was rector from 1862 until his death. He published sermons and lectures; *A History of the Parish of Trinity Church, New York City* (4 vols., 1898–1905); and a biography of his father, *Memoirs of John Adams Dix* (2 vols., New York, 1883).

DIXON, GEORGE (1755?–1800), English navigator. He served under Captain Cook in his third expedition, during which he had an opportunity of learning the commercial capabilities of the north-west coast of North America. After his return from Cook's expedition he became a captain in the royal navy. In the autumn of 1785 he sailed in the "Queen Charlotte," in the service of the King George's Sound Company of London, to explore the shores of the present British Columbia, with the special object of developing the fur trade. His chief discoveries were those of Queen Charlotte's Islands and Sound (the latter only partial), Port Mulgrave, Norfolk Bay, and Dixon's Entrance and Archipelago. After visiting China, where he disposed of his cargo, he returned to England (1788), and published (1790) *A Voyage round the World, but more particularly to the North-West Coast of America*, the bulk of which consists of descriptive letters by William Baresford, his supercargo. His own contribution to the work included valuable charts and appendices. He is usually, though not with absolute certainty, identified with the George Dixon who was author of *The Navigator's Assistant* (1792) and teacher of navigation at Gosport.

DIXON, HENRY HALL (1822–1870), English sporting writer over the *nom de plume* "The Druid," was born at Warwick Bridge, Cumberland, on the 16th of May 1822, and was educated at Rugby and at Trinity College, Cambridge, where he graduated in 1846. He took up the profession of the law, but, though called to the bar in 1853, soon returned to sporting journalism, in which he had already made a name for himself, and began to write regularly for the *Sporting Magazine*, in the pages of which appeared three of his novels, *Post and Paddock* (1856), *Silk and Scarlet* (1859), and *Scott and Sebright* (1862). He also published a legal compendium entitled *The Law of the Farm* (1858), which ran through several editions. His other more important works were *Field and Fern* (1865), giving an account of the herds and flocks of Scotland, and *Saddle and Sirloin* (1870), treating in the same manner those of England. He died at Kensington on the 16th of March 1870.

See Hon. Francis Lawley, *Life and Times of "The Druid"* (London, 1895).

DIXON, RICHARD WATSON (1833–1900), English poet and divine, son of Dr James Dixon, a Wesleyan minister, was born on the 5th of May 1833. He was educated at King Edward's school, Birmingham, and on proceeding to Pembroke College, Oxford, became one of the famous "Birmingham group" there who shared with William Morris and Burne-Jones in the Pre-Raphaelite movement. He took only a second class in moderations in 1854, and a third in *Literae Humaniores* in 1856; but in

1858 he won the Arnold prize for an historical essay, and in 1863 the English Sacred Poem prize. He was ordained in 1858, was second master of Carlisle high school, 1863–1868, and successively vicar of Hayton, Cumberland, and Warkworth, Northumberland. He became minor canon and honorary librarian of Carlisle in 1868, and honorary canon in 1874, he was proctor in convocation (1890–1894), and received the honorary degree of D.D. from Oxford in 1899. He died at Warkworth on the 23rd of January 1900. Canon Dixon's first two volumes of verse, *Christ's Company* and *Historical Odes*, were published in 1861 and 1863 respectively; but it was not until 1883 that he attracted conspicuous notice with *Mano*, an historical poem in *tersa rima*, which was enthusiastically praised by Mr Swinburne. This success he followed up by three privately printed volumes, *Odes and Elogues* (1884), *Lyrical Poems* (1886), and *The Story of Eudocia* (1888). Dixon's poems were during the last fifteen years of his life recognized as scholarly and refined exercises, touched with both dignity and a certain severe beauty, but he never attained any general popularity as a poet, the appeal of his poetry being directly to the scholar. A great student of history, his studies in that direction colour much of his poetry. The romantic atmosphere is remarkably preserved in *Mano*, a successful metrical exercise in the difficult *tersa rima*. His typical poems have charm and melody, without introducing any new note or variety of rhythm. He is contemplative, sober and finished in literary workmanship, a typical example of the Oxford school. Pleasant as his poetry is, however, he will probably be longest remembered by the work to which he gave the best years of his life, his *History of the Church of England from the Abolition of the Roman Jurisdiction* (1878–1902). At the time of his death he had completed six volumes, two of which were published posthumously. This fine work, covering the period from 1529 to 1570, is built upon elaborate research, and presents a trustworthy and unprejudiced survey of its subject.

Dixon's *Selected Poems* were published in 1909 with a memoir of the author by Robert Bridges.

DIXON, WILLIAM HEPWORTH (1821–1879), English author and traveller, was born at Great Ancoats, Manchester, on the 30th of June 1821, a member of an old Lancashire family. Beginning life as a clerk at Manchester, he decided, in 1846, to take up literature as a career. After gaining some journalistic experience at Cheltenham he settled in London, on the recommendation of Douglas Jerrold, and contributed to the *Athenaeum* and *Daily News*. His series of papers—"The Literature of the Lower Orders"—in the last-named journal, and a further series, "London Prisons," were widely noticed. In 1849 appeared his *John Howard and the Prison World of Europe*, which proved a great popular success. These were followed by a *Life of William Penn* (1851), in which he replied to Maccaulay's attack on Penn; *Life of Blake* (1852); and *Personal History of Lord Bacon* (1861), supplemented by *The Story of Lord Bacon's Life* (1862). From 1853 to 1869 he was editor of the *Athenaeum*. In 1863 he visited the East, and on his return helped to found the Palestine Exploration Fund, and published (1865) *The Holy Land*. In 1866 he travelled through the United States, publishing, in 1867, *New America*, and, the following year, *Spiritual Wives*, two supplementary volumes. In the autumn of 1867 he journeyed through the Baltic Provinces, publishing an account of his trip in *Free Russia* (1870). In 1871 he was in Switzerland, and in 1872 in Spain, where he wrote the greater part of his *History of Two Queens*. In 1874 he revisited the United States, giving the impressions of his tour in *The White Conquest* (1875). His other works, besides some fiction, were *British Cyprus* (1879) and *Royal Windsor*. He died on the 26th of December 1879. His daughter, Ella N. Hepworth Dixon, became known as a journalist and novelist.

DIXON, a city and the county seat of Lee county, Illinois, U.S.A., on the Rock river, in the N.W. part of the state. Pop. (1890) 5161; (1900) 7917 (879 foreign-born); (1910) 7216. It is served by the Chicago & North-Western and the Illinois Central railways, and is connected with Sterling by an electric line; freight is shipped over the Hennepin Canal. The city

has two parks of 159 and 6 acres respectively, and there is a Chautauqua Park, where an annual Chautauqua Assembly is held. Dixon is the seat of the Northern Illinois normal school (incorporated in 1884), and of the Rock River military academy. The river furnishes water power for the street railways, electric lighting and a number of manufacturing establishments. Among the manufactures are condensed milk, boxes, wire screens and wire cloth, lawn mowers, gas engines, cement, agricultural implements, shoes and wagons. The place was laid out in 1835 by John Dixon (1784-1876), the first white settler of Lee county. A bronze tablet in the Howells Building, at the intersection of First and Peoria Streets, marks the site of his cabin, and in the city cemetery a granite shaft has been erected to his memory. Dixon was chartered as a city in 1859.

DIZFUL, or **DIZ-PUL** ("fort-bridge"), a town of Persia, in the province of Arabistan, 36 m. N.W. of Shushter, in 32° 25' N., 48° 28' E. Pop. about 25,000. It has post and telegraph offices. It is situated on the left bank of the Dizful river, a tributary of the Karun, crossed by a fine bridge of twenty-two arches, 430 yds. in length, constructed on ancient foundations. Dizful is the chief place of a small district of the same name and the residence of the governor of Arabistan during the winter months. The district has twelve villages and a population of about 35,000 (5000 Arabs of the Ali i Kethlr tribe), and pays a yearly tribute of about £6000. The city was formerly known as Andamish, and in its vicinity are many remains of ancient canals and buildings which afford conclusive proof of former importance. 16 m. S.W. are the ruins of Susa, and east of them and half-way between Dizful and Shushter stood the old city of Junday Shapur.

DJAKOVO (sometimes written *Djakovar*, Hungarian *Diakonőr*), a city of Croatia-Slavonia, Hungary; in the county of Virovitica, 100 m. E. by S. of Agram. Pop. (1900) 6824. Djakovo is a Roman Catholic episcopal see, whose occupant bears the title "Bishop of Bosnia, Slavonia and Sirmium." During the life of Bishop Strossmayer (1815-1905) it was one of the chief centres of religious and political activity among the Croats. The cathedral, a vast basilica built of brick and white stone, with a central dome and two lofty spires above the north entrance, was founded in 1866 and consecrated in 1882. Its style is Romanesque, chosen by Strossmayer as symbolical of the position of his country midway between east and west. The interior is magnificently decorated with mosaics, mural paintings and statuary, chiefly the work of local artists. Other noteworthy buildings are the nunnery, ecclesiastical seminary and episcopal palace. Djakovo has a thriving trade in agricultural produce. Many Roman remains have been discovered in the neighbourhood, but the earliest mention of the city is in 1244, when Béla IV. of Hungary confirmed the title-deeds of its owners, the bishops of Bosnia.

For a full description of the cathedral, in Serbo-Croatian and French, see the finely illustrated folio *Stolna Crkva u Djakovu*, published by the South Slavonic Academy (Agram, 1900).

DLUGOSZ, JAN [JOHANNES LONGINUS] (1415-1480), Polish statesman and historian, was the son of Jan Dlugosz, burgrave of Bozennica. Born in 1415, he graduated at the university of Cracow and in 1431 entered the service of Bishop Zbygniew Olesnicki (1380-1455), the statesman and diplomatist. He speedily won the favour of his master, who induced him to take orders and made him his secretary. His preference was rapid. In 1436 we find him one of the canons of Cracow and the administrator of Olesnicki's vast estates. In 1440, on returning from Hungary, whither his master had escorted King Wladislaus II., Dlugosz saved the life of Olesnicki from robbers. The prelate now employed Dlugosz on the most delicate and important political missions. Dlugosz brought Olesnicki the red hat from Rome in 1449, and shortly afterwards was despatched to Hungary to mediate between Hunyadi and the Bohemian condottiere Giskra, a difficult mission which he most successfully accomplished. Both these embassies were undertaken contrary to the wishes of King Casimir IV., who was altogether opposed to Olesnicki's ecclesiastical policy. But though he thus sacrificed his own prospects to the cardinal's good pleasure, Dlugosz was far too sagacious to approve of the provocative attitude of Olesnicki, and

frequently and fearlessly remonstrated with him on his conduct. In his account, however, of the quarrel between Casimir and Olesnicki concerning the question of priority between the cardinal and the primate of Poland he warmly embraced the cause of the former, and even pronounced Casimir worthy of dethronement. Such outbursts against Casimir IV. are not infrequent in Dlugosz's *Historia Polonica*, and his strong personal bias must certainly be taken into consideration in any critical estimate of that famous work. Yet as a high-minded patriot Dlugosz had no sympathy whatever with Olesnicki's opposition to Casimir's Prussian policy, and steadily supported the king during the whole course of the war with the Teutonic knights. When Olesnicki died in 1455 he left Dlugosz his principal executor. The office of administering the cardinal's estate was a very ungrateful one, for the family resented the liberal benefactions of their kinsman to the Church and the university, and accused Dlugosz of exercising undue influence, from which charge he triumphantly vindicated himself. It was in the year of his patron's death that he began to write his *Historia Polonica*. This great book, the first and still one of the best historical works on Poland in the modern sense of the word, was only undertaken after mature consideration and an exhaustive study of all the original sources then available, some of which are now lost. The principal archives of Poland and Hungary were ransacked for the purpose, and in his account of his own times Dlugosz's intimate acquaintance with the leading scholars and statesmen of his day stood him in good stead. The style is modelled on that of Livy, of whom Dlugosz was a warm admirer. As a proof of the thoroughness and conscientiousness of Dlugosz it may be mentioned that he learned the Cyrillic alphabet and took up the study of Ruthenian, "in order that this our history may be as plain and perfect as possible." The first of the numerous imprints of the *Historia Polonica* appeared in 1614, the first complete edition in 1711.

Dlugosz's literary labours did not interfere with his political activity. In 1467 the generous and discerning Casimir IV. entrusted Dlugosz with the education of his sons, the eldest of whom, Wladislaus, at the urgent request of the king, he accompanied to Prague when in 1471 the young prince was elected king of Bohemia. Dlugosz refused the archbishopric of Prague because of his strong dislike of the land of the Hussites; but seven years later he accepted the archbishopric of Lemberg. His last years were devoted to his history, which he completed in 1479. He died on the 10th of May 1480, at Piatek.

See Aleksander Semkowicz, *Critical Considerations of the Polish Works of Dlugosz* (Pol.; Cracow, 1874); Michael Bobrzynski and Stanislaw Smolka, *Life of Dlugosz and his Position in Literature* (Pol.; Cracow, 1893). (R. N. B.)

DMITRIEV, IVAN IVANOVICH (1760-1837), Russian statesman and poet, was born at his father's estate in the government of Simbirsk. In consequence of the revolt of Pugachev the family had to flee to St Petersburg, and there Ivan was entered at the school of the Semenov Guards, and afterwards obtained a post in the military service. On the accession of Paul to the imperial throne he quitted the army with the title of colonel, and his appointment as procurator for the senate was soon after renounced for the position of privy councillor. During the four years from 1810 to 1814 he served as minister of justice under the emperor Alexander; but at the close of this period he retired into private life, and though he lived more than twenty years, he never again took office, but occupied himself with his literary labours and the collection of books and works of art. In the matter of language he sided with Karamsin, and did good service by his own pen against the Old Slavonic party. His poems include songs, odes, satires, tales, epistles, &c., as well as the fables—partly original and partly translated from Fontaine, Florian and Arnault—on which his fame chiefly rests. Several of his lyrics have become thoroughly popular from the readiness with which they can be sung; and a short dramatic-epic poem on Yermak, the Cossack conqueror of Siberia, is well known.

His writings occupy three volumes in the first five editions; in the 6th (St Petersburg, 1823) there are only two. His memoirs, to which he devoted the last years of his life, were published at Moscow in 1866.

DNEIPEP, one of the most important rivers of Europe (the *Borysthenes* of the Greeks, *Danapris* of the Romans, *Usior Usu* of the Turks, *Eksi* of the Tatars, *Elice* of Visconti's map (1381), *Lerene* of Contarini (1437), *Luosen* of Baptista of Genoa (1514), and *Lussem* in the same century). It belongs entirely to Russia, and rises in the government of Smolensk, in a swampy district (alt. 930 ft.) at the foot of the Valdai Hills, not far from the sources of the Volga and the Dvina, in 55° 52' N. and 33° 41' E. Its length is about 1410 m. and it drains an area of 202,140 sq. m. In the first part of its course, which may be said to end at Dorogobuzh, it flows through an undulating country of Carboniferous formation; in the second it passes west to Orsha, south through the fertile plain of Chernigov and Kiev, and then southeast across the rocky steppe of the Ukraine to Ekaterinoslav. About 45 m. S. of this town it has to force its way across the same granitic offshoot of the Carpathian mountains which interrupts the course of the Dniester and the Bug, and for a distance of about 25 m. rapid succeeds rapid. The fall of the river in that distance is 155 ft. The Dnieper, having got clear of the rocks, continues south-west through the grassy plains of Kherson and Taurida, and enters the Black Sea, or rather a *liman* or bay of the Black Sea, by a considerable estuary in 46° 30' N. and 32° 20' E. On this ramifying *liman*, into which the Bug also pours its waters, stand Nikolaiev and the fortified town of Ochakov. Navigation extends as far up as Dorogobuzh, where the depth is about 12 ft., and rafts are floated down from the higher reaches. The banks are generally high, more particularly the left bank. About the town of Smolensk the breadth is 455 ft., at the confluence of the Pripet 1400, and in some parts of the Ekaterinoslav district more than 1½ m. In the course above the rapids the channel varies very greatly in nature and depth, and it is not infrequently interrupted by shallows. The rapids, or *porogs*, form a serious obstacle to navigation; it is only for a few weeks when the river is in flood that they are passable, and even then the venture is not without risk and can only be undertaken with the assistance of special pilots. It is from these falls that the Cossacks of the Ukraine came to be known as Zaporogian Cossacks. As early as 1732 an attempt was made to improve the channel. A canal, which ultimately proved too small for use, was constructed at Nenasitets in 1780 at private expense; blastings were carried out in 1798 and 1799 at various parts; in 1805 a canal was formed at Kaindatski, and the channel straightened at Sursk; by 1807 a new canal was completed at Nenasitets; in 1833 a passage was cleared through the Staro-kaindatski porog; and in the period 1843 to 1853 numerous ameliorations were effected. The result has been not only to diminish greatly the dangers of the natural channel, but also to furnish a series of artificial canals by which vessels can make their way when the river is low. Of the tributaries of the Dnieper the following are navigable,—the Berezina and the Pripet from the right, and the Sozh and the Desna from the left. By means of the Dnieper-Bug (King's) canal, and the Berezina and Oginski canals, this river has a sort of water connexion with the Baltic Sea. In the estuary the fisheries give employment to large numbers of people. At Kiev the river is free from ice on an average of 234 days in the year, at Ekaterinoslav 270 and at Kherson 277. (P. A. K.; J. T. Bk.)

DNEIESTER (*Tyras* and *Danaster* or *Danastiris* of classical authors, *Nistrid* of the Rumanians, and *Turla* of the Turks), a river of south-eastern Europe belonging to the basin of the Black Sea. It rises on the northern slope of the Carpathian mountains in Austrian Galicia, and belongs for the first 350 m. of its course to Austrian, for the remaining 515 m. to Russian, territory. It drains an area of 29,670 sq. m., of which 16,500 sq. m. belong to Russia. It is excessively meandering, and the current in most parts even during low water is decidedly rapid as compared with Russian rivers generally, the mean rate being calculated at 1½ m. per hour. The average width of the channel is from 500 to 750 ft., but in some places it attains as much as 1400 ft.; the depth is various and changeable. The principal interruption in the navigable portion of the river, besides a sprinkling of rocks in the bed and the somewhat extensive shallows, is occasioned by a granitic spur from the Carpathians, which gives rise to the Yampol

Rapids. For ordinary river craft the passage of these rapids is rendered possible, but not free from danger, by a natural channel on the left side, and by a larger and deeper artificial channel on the right; for steamboats they form an insuperable barrier. The river falls into the sea by several arms, passing through a shallow *liman* or lagoon, a few miles S.W. of Odessa. There are two periodical floods,—the earlier and larger caused by the breaking up of the ice, and occurring in the latter part of February or in March; and the later due to the melting of the snows in the Carpathians, and taking place about June. The spring flood raises the level of the water 20 ft., and towards the mouth of the river submerges the gardens and vineyards of the adjacent country. In some years the general state of the water is so low that navigation is possible only for three or four weeks, while in other years it is so high that navigation continues without interruption; but in recent years considerable improvements have been effected at government expense. In consequence the traffic has increased, the Dniester tapping regions of great productiveness, especially in cereals and timber, namely, Galicia, Podolia and Bessarabia. Steamboat traffic was introduced in the lower reaches in 1840. The fisheries of the lower course and of the estuary are of considerable importance; and these, together with those of the lakes which are formed by the inundations, furnish a valuable addition to the diet of the people in the shape of carp, pike, tench, salmon, sturgeon and eels. Its tributaries are numerous, but not of individual importance, except perhaps the Sereth in Galicia. (P. A. K.; J. T. Bk.)

DOAB, **DUAB** or **DOOAB**, a name, like the Greek *Meopotamia*, applied in India, according to its derivation (*do*, two, and *ab*, river), to the stretch of country lying between any two rivers, as the Bari Doab between the Sutlej and the Ravi, the Rechna Doab between the Ravi and the Chenab, the Jech Doab between the Chenab and Jhelum, and the Sind Sagar Doab between the Jhelum and the Indus, but frequently employed, without any distinctive adjunct, as the proper name for the region between the Ganges and its great tributary the Jumna. In like manner the designation of Doab canal is given to the artificial channel which breaks off from the Jumna near Fyzabad, and flows almost parallel with the river till it reunites with it at Delhi.

DOANE, GEORGE WASHINGTON (1799-1859), American churchman, Protestant Episcopal bishop of New Jersey, was born in Trenton, New Jersey, on the 27th of May 1799. He graduated at Union College, Schenectady, New York, in 1818, studied theology and, in 1821, was ordained deacon and in 1823 priest by Bishop Hobart, whom he assisted in Trinity church, New York. With George Upfold (1796-1872), bishop of Indiana from 1849 to 1872, Doane founded St Luke's in New York City. In 1824-1828 he was professor of belles-lettres in Washington (now Trinity) College, Hartford, Connecticut, and at this time he was one of the editors of the *Episcopal Watchman*. He was assistant in 1828-1830 and rector in 1830-1832 of Christ church, Boston, and was bishop of New Jersey from October 1832 to his death at Burlington, New Jersey, on the 27th of April 1859. The diocese of New Jersey was an unpromising field, but he took up his work there with characteristic vigour, especially in the foundation of St Mary's Hall (1837, for girls) and Burlington College (1846) as demonstrations of his theory of education under church control. His business management of these schools got him heavily into debt, and in the autumn of 1852 a charge of lax administration came before a court of bishops, who dismissed it. The schools showed him an able and wise disciplinarian, and his patriotic orations and sermons prove him a speaker of great power. He belonged to the High Church party and was a brilliant controversialist. He published *Songs by the Way* (1824), a volume of poems; and his hymns beginning "Softly now the light of day" and "Thou art the Way" are well known.

See *Life and Writings of George Washington Doane* (4 vols., New York, 1860-1861), edited by his son, William Crosswell Doane (b. 1832), first bishop of Albany.

DOBBS FERRY, a village of Westchester county, New York, on the E. bank of the Hudson river 2 m. N. of Yonkers. Pop. (1890) 2083; (1900) 2888; (1910 U. S. census) 3455. Dobbs

Ferry is served by the Hudson River division of the New York Central railway. There are many fine country places, two private schools—the Mackenzie school for boys and the Misses Masters' school for girls—and the children's village (with about thirty cottages) of the New York juvenile asylum. The name of the village was derived from a Swede, Jeremiah Dobbs, whose family probably moved hither from Delaware, and who at the beginning of the last quarter of the 18th century had a skiff ferry, which was kept up by his family for a century afterwards. Because Dobbs Ferry had been a part of Philips Manor all lands in it were declared forfeit at the time of the War of American Independence (see YONKERS), and new titles were derived from the commissioners of forfeitures. The position of the village opposite the northernmost end of the Palisades gave it importance during the war. The region was repeatedly raided by camp followers of each army; earthworks and a fort, commanding the Hudson ferry and the ferry to Paramus, New Jersey, were built; the British army made Dobbs Ferry a rendezvous, after the battle of White Plains, in November 1776, and the continental division under General Benjamin Lincoln was here at the end of January 1777. The American army under Washington encamped near Dobbs Ferry on the 4th of July 1781, and started thence for Yorktown in the following month. In the Van Brugh Livingston house on the 6th of May 1783, Washington and Governor George Clinton met General Sir Guy Carleton, afterwards Lord Dorchester, to negotiate for the evacuation by the British troops of the posts they still held in the United States. In 1873 the village was incorporated as Greenburgh, from the township of the same name which in 1788 had been set apart from the manor of Philipsburgh; but the name Dobbs Ferry was soon resumed.

DOBELL, SYDNEY THOMPSON (1824-1874), English poet and critic, was born on the 5th of April 1824 at Cranbrook, Kent. His father was a wine merchant, his mother a daughter of Samuel Thompson (1766-1837), a London political reformer. The family moved to Cheltenham when Dobell was twelve years old. He was educated privately, and never attended either school or university. Herefers to this in some lines on Cheltenham College in imitation of Chaucer, written in his eighteenth year. After a five years' engagement he married, in 1844, Emily Fordham, a lady of good family. An acquaintance with Mr (subsequently Sir James) Stansfeld and with the Birmingham preacher-politician, George Dawson (1821-1876), which afterwards led to the foundation of the Society of the Friends of Italy, fed the young enthusiast's ardour for the liberalism of the day. Meanwhile, Dobell wrote a number of minor poems, instinct with a passionate desire for political reform. *The Roman* appeared in 1850, under the *nom de plume* of "Sydney Yendys." Next year he travelled through Switzerland with his wife; and after his return he formed friendships with Robert Browning, Philip Bailey, George MacDonald, Emanuel Deutsch, Lord Houghton, Ruskin, Holman Hunt, Mazzini, Tennyson and Carlyle. His second long poem, *Bolder*, appeared in 1854. The three following years were spent in Scotland. Perhaps his closest friend at this time was Alexander Smith, in company with whom he published, in 1855, a number of sonnets on the Crimean War, which were followed by a volume on *England in Time of War*. Although by no means a rich man he was always ready to help needy men of letters, and it was through his exertions that David Gray's poems were published. In 1869 a horse, which he was riding, fell and rolled over with him. His health, which had for several years necessitated his wintering abroad, was seriously affected by this accident, and he was from this time more or less of an invalid, until his death on the 22nd of August 1874.

As a poet Dobell belongs to the "spasmodic school," as it was named by Professor Aytoun, who parodied its style in *Firmilian*. The epithet, however, was first applied by Carlyle to Byron. The school includes George Gilfillan, Philip James Bailey, John Stanyan Bigg (1826-1865), Dobell, Alexander Smith, and, according to some critics, Gerald Massey. It was characterized by an under-current of discontent with the mystery of existence, by vain effort, unrewarded struggle, sceptical unrest, and an

uneasy straining after the unattainable. It thus faithfully reflected a certain phase of 19th century thought. The productions of the school are marked by an excess of metaphor and a general extravagance of language. On the other hand, they exhibit freshness and originality often lacking in more conventional writings. Dobell's poem, *The Roman*, dedicated to the interests of political liberty in Italy, is marked by pathos, energy and passionate love of freedom, but it is overlaid with monologue, which is carried to a dreary excess in *Bolder*, relieved though the latter is by fine descriptive passages, and by some touching songs. Dobell's suggestive, but too ornate prose writings were collected and edited with an introductory note by Professor J. Nichol (*Thoughts on Art, Philosophy and Religion*) in 1876. In his religious views Dobell was a Christian of the Broad Church type; and socially he was one of the most amiable and true-hearted of men. His early interest in the cause of oppressed nationalities, shown in his friendship with Kossuth, Emanuel Deutsch and others, never lessened, although his views of home politics underwent some change from the radical opinions of his youth. In Gloucestershire Dobell was well known as an advocate of social reform, and he was a pioneer in the application of the co-operative system to private enterprise.

The standard edition of his poems (1875) by Professor Nichol includes a memoir.

DÖBELN, a town of Germany, in the kingdom of Saxony, on the (Freiberg) Mulde, two arms of which embrace the town as an island, 35 m. S.E. from Leipzig by rail, and at the junction of lines to Dresden, Chemnitz, Riesa and Oschatz. Pop. (1905) including the garrison, 18,907. It has two Evangelical churches, of which the Nikolai-kirche, dating in its present form from 1485, is a handsome edifice; a mediæval town hall, a former Benedictine nunnery and a monument to Luther. There are an agricultural and a commercial school. The industries include wool-spinning, iron-founding, carriage, agricultural implement, and metal-printing and stamping works.

DOBERAN, or **DOBEREAN**, a town of Germany, in the grand-duchy of Mecklenburg-Schwerin, about 2 m. from the shores of the Baltic and 7 W. of Rostock by rail. Pop. 5000. Besides the ruins of a Cistercian abbey founded by Pribislaus, prince of Mecklenburg, in 1173, and secularized in 1552, it possesses an Evangelical Gothic church of the 14th century, one of the finest in north Germany, a grand-ducal palace, a theatre, an exchange and a concert hall. Owing to its delightful situation amid beech forests and to its chalybeate waters, Doberan has become a favourite summer resort. Numerous villa residences have been erected and promenades and groves laid out. In 1793 Duke Frederick Francis caused the first seaside watering-place in Germany to be established on the neighbouring coast, 4 m. distant, at the spot where the Heiligen-Damm, a great bank of rocks about 1000 ft. broad and 15 ft. high, stretches out into the sea and forms an excellent bathing ground. Though no longer so popular as in the early part of the 19th century, it is still frequented, and is connected with Doberan by a tramway.

DÖBEREINER, JOHANN WOLFGANG (1780-1849), German chemist, was born near Hof in Bavaria on the 15th of December 1780. After studying pharmacy at Münchenberg, he started a chemical manufactory in 1803, and in 1810 was appointed professor of chemistry, pharmacy and technology at Jena, where he died on the 24th of March 1849. The Royal Society's *Catalogue* enumerates 171 papers by him on various chemical topics, but his name is best known for his experiments on platinum in a minute state of division and on the oxidation products of alcohol. In 1822 he showed that when a mass of platinum black, supplied with alcohol by a wick is enclosed in a jar to which the air has limited access, acetic acid and water are produced; this experiment formed the basis of the Schützenbach Quick Vinegar Process. A year later he noticed that spongy platinum in presence of oxygen can bring about the ignition of hydrogen, and utilized this fact to construct his "hydrogen lamp," the prototype of numerous devices for the self-ignition of coal-gas burners. He studied the formation of aldehyde from

alcohol by various methods, also obtaining its crystalline compound with ammonia, and he was the discoverer of furfural. An early observation of the diffusion of gases was recorded by him in 1823 when he noticed the escape of hydrogen from a cracked jar, attributing it to the capillary action of fissures. His works included treatises on pneumatic chemistry (1821-1825) and the chemistry of fermentation (1822).

A correspondence which he carried on with Goethe and Charles August, grand-duke of Saxe-Weimar, was collected and published at Weimar by Schade in 1856.

DOBREE, PETER PAUL (1782-1825), English classical scholar and critic, was born in Guernsey. He was educated at Reading school under Richard Valpy and at Trinity College, Cambridge, where he was elected fellow. He was appointed regius professor of Greek in 1823, and died in Cambridge on the 24th of September 1825. He was an intimate friend of Porson, whom he took as his model in textual criticism, although he showed less caution in conjectural emendation. After Porson's death (1808) Dobree was commissioned with Monk and Blomfield to edit his literary remains, which had been bequeathed to Trinity College. Illness and a subsequent journey to Spain delayed the work until 1820, when Dobree brought out the *Plutus* of Aristophanes (with his own and Porson's notes) and all Porson's *Aristophanica*. Two years later he published the *Lexicon* of Póthius from Porson's transcript of the Gale MS. in Trinity College library, to which he appended a *Lexicon rhetoricum* from the margin of a Cambridge MS. of Harpocration. James Scholefield, his successor in the Greek professorship, brought out selections from his notes (*Adversaria*, 1831-1833) on Greek and Latin authors (especially the orators), and a reprint of the *Lexicon rhetoricum*, together with notes on inscriptions (1834-1835). The latest edition of the *Adversaria* is by William Wagner (in Bohn's *Collegiate Series*, 1883).

An appreciative estimate of Dobree as a scholar will be found in J. Bale's *Scholica hypomnemata*, ii. (1839) and in the *Philological Museum*, i. (1832) by J. C. Hare.

DÖBRENTEI, GABOR [GABRIEL] (1786-1851), Hungarian philologist and antiquary, was born at Nagyszöllös in 1786. He completed his studies at the universities of Wittenberg and Leipzig, and was afterwards engaged as a tutor in Transylvania. At this period he originated and edited the *Erdélyi Múzeum*, which, notwithstanding its important influence on the development of the Magyar language and literature, soon failed for want of support. In 1820 Döbrentei settled at Pest, and there he spent the rest of his life. He held various official posts, but continued zealously to pursue the studies for which he had early shown a strong preference. His great work is the *Ancient Monuments of the Magyar Language* (*Régi Magyar Nyelvmélték*), the editing of which was entrusted to him by the Hungarian Academy. The first volume was published in 1838 and the fifth was in course of preparation at the time of his death. Döbrentei was one of the twenty-two scholars appointed in 1825 to plan and organize, under the presidency of Count Teleki, the Hungarian Academy. In addition to his great work he wrote many valuable papers on historical and philological subjects, and many biographical notices of eminent Hungarians. These appeared in the Hungarian translation of Brockhaus's *Conversations-Lexikon*. He translated into Hungarian *Macbeth* and other plays of Shakespeare, Sterne's letters from Yorick to Eliza (1828), several of Schiller's tragedies, and Molière's *Avare*, and wrote several original poems. Döbrentei does not appear to have taken any part in the revolutionary movement of 1848. He died at his country house, near Pest, on the 28th of March 1851.

DOBRIČH, or **HAJOLUPAZARJIK**, the principal town in the Bulgarian Dobrudja. Pop. (1901) 13,436. The town is noted for its *panais* or great fair, chiefly for horses and cattle, held annually in the summer, which formerly attracted a large concourse from all parts of eastern Europe, but has declined in importance.

DOBRIZHOFER, MARTIN (1717-1791), Austrian Roman Catholic missionary, was born at Gratz, in Styria. He joined the Society of Jesus in 1736, and in 1749 proceeded to Paraguay,

where for eighteen years he worked devotedly first among the Guaranis, and then among the Abipones. Returning to Europe on the expulsion of the Jesuits from South America, he settled at Vienna, obtained the friendship of Maria Theresa, survived the extinction of his order, composed the history of his mission, and died on the 17th of July 1791. The lively if rather garrulous book on which his title to remembrance rests, appeared at Vienna in 1784, in the author's own Latin, and in a German translation by Professor Kraill of the university of Pest. Of its contents some idea may be obtained from its extended title:—*Historia de Abiponibus, Equestri Bellicosaque Paraguariae Natione, locupletata Copiosis Barbararum Gentium, Urbium, Fluminum, Ferarum, Amphibiorum, Insectorum, Serpensium praecipuarum, Piscium, Avium, Arborum, Plantarum aliarumque ejusdem Provinciae Proprietatum Observationibus*. In 1822 there appeared in London an anonymous translation sometimes ascribed to Southey, but really the work of Sara Coleridge, who had undertaken the task to defray the college expenses of one of her brothers. A delicate compliment was paid to the translator by Southey in the third canto of his *Tale of Paraguay*, the story of which was derived from the pages of Dobrizhoffer's narrative:—

"And if he could in Merlin's glass have seen
By whom his tomes to speak our tongue were taught,
The old man would have felt as pleased, I ween,
As when he won the ear of that great Empress Queen."

DOBROWSKY, JOSEPH (1753-1820), Hungarian philologist, was born of Bohemian parentage at Gjermet, near Raab, in Hungary. He received his first education in the German school at Bischofteinitz, made his first acquaintance with Bohemian at the Deutschbrod gymnasium, studied for some time under the Jesuits at Klattau, and then proceeded to the university of Prague. In 1772 he was admitted among the Jesuits at Brünn; but on the dissolution of the order in 1773 he returned to Prague to study theology. After holding for some time the office of tutor in the family of Count Nostitz, he obtained an appointment first as vice-rector, and then as rector, in the general seminary at Hradisch; but in 1790 he lost his post through the abolition of the seminaries throughout Austria, and returned as a guest to the house of the count. In 1792 he was commissioned by the Bohemian Academy of Sciences to visit Stockholm, Abo, Petersburg and Moscow in search of the manuscripts which had been scattered by the Thirty Years' War; and on his return he accompanied Count Nostitz to Switzerland and Italy. His reason began to give way in 1795, and in 1801 he had to be confined in a lunatic asylum; but by 1803 he had completely recovered. The rest of his life was mainly spent either in Prague or at the country seats of his friends Counts Nostitz and Czernin; but his death took place at Brünn, whither he had gone in 1828 to make investigations in the library. While his fame rests chiefly on his labours in Slavonic philology his botanical studies are not without value in the history of the science.

The following is a list of his more important works, *Fragmentum Pragense evangelii S. Marci, vulgo autographi* (1778); a periodical for Bohemian and Moravian Literature (1780-1787); *Scriptores rerum Bohemicarum* (2 vols., 1783); *Geschichte der böhm. Sprache und ältern Literatur* (1792); *Die Bildungsmittel der slav. Sprache* (1799); a *Deutsch-böhm. Wörterbuch* compiled in collaboration with Leschka-Puchmayer and Hanka (1802-1821); *Entwurf eines Pflanzensystems nach Zahlen und Verhältnissen* (1802); *Glagolitsa* (1807); *Lehrgebäude der böhm. Sprache* (1809); *Institutiones linguae slavicae dialecti veteris* (1822); *Entwurf zu einem allgemeinen Etymologikon der slav. Sprachen* (1813); *Slowanka zur Kenntniss der slav. Literatur* (1814); and a critical edition of Jordanes, *De rebus Geticis*, for Pertz's *Monumenta Germaniae historica*. See Palacky, *J. Dobrowskys Leben und gelehrtes Wirken* (1833).

DOBRUDJA (Bulgarian *Dobričh*, Rumanian *Dobrogea*), also written **DOBRUDSCHA**, and **DOBRUJA**, a region of south-eastern Europe, bounded on the north and west by the Danube, on the east by the Black Sea, and on the south by Bulgaria. Pop. (1900) 267,808; area, 6000 sq. m. The strategic importance of this territory was recognized by the Romans, who defended it on the south by "Trajan's Wall," a double rampart, drawn from Constantza, on the Black Sea, to the Danube. In later times it was utilized by Russians and Turks, as in the wars of 1828, 185-

and 1878, when it was finally wrested from Turkey. By the treaty of Berlin, in 1878, the Russians rewarded their Rumanian allies with this land of mountains, fens and barren steppes, peopled by Turks, Bulgarians, Tatars, Jews and other aliens; while, to add to the indignation of Rumania, they annexed instead the fertile country of Bessarabia, largely inhabited by Rumans. After 1880, however, the steady decrease of aliens, and the development of the Black Sea ports, rendered the Dobrudja a source of prosperity to Rumania.

DOBSINA (Ger. *Dobschau*), a town of Hungary, 165 m. N.E. of Budapest by rail. Pop. (1900) 5109. It is situated in the county of Gömör, at the foot of the Radzim (3200 ft. high) in the central Carpathians, and lies to the south of the beautiful Straczena valley, watered by the river Gölnitz, and enclosed on all sides by mountains. In the vicinity are mines of iron, cobalt, copper and mercury, some of them being very ancient. But the most remarkable feature is a large cavern some 3½ m. N.W., in which is an icefield nearly 2 acres in extent, containing formations which are at once most curious and strikingly beautiful. This cavern, which lies in the above-mentioned Straczena valley, was discovered in 1870. The place was founded in the first half of the 14th century by German miners.

DOBSON, HENRY AUSTIN (1840—), English poet and man of letters, was born at Plymouth on the 18th of January 1840, being the eldest son of George Clarisse Dobson, a civil engineer, and on his grandmother's side of French descent. When he was about eight years old the family moved to Holyhead, and his first school was at Beaumaris, in the Isle of Anglesea. He was afterwards educated at Coventry, and the Gymnase, Strassburg, whence he returned at the age of sixteen with the intention of becoming a civil engineer. He had a taste for art, and in his earlier years at the office continued to study it at South Kensington, at his leisure, but without definite ambition. In December 1856 he entered the Board of Trade, gradually rising to a principalship in the harbour department, from which he withdrew in the autumn of 1901. He married in 1868 Frances Mary, daughter of Nathaniel Beardmore of Broxbourne, Herts, and settled at Ealing. His official career was industrious though uneventful, but as poet and biographer he stands among the most distinguished of his time. The student of Mr Austin Dobson's work will be struck at once by the fact that it contains nothing immature: there are no *juvenilia* to criticize or excuse. It was about 1864 that Mr Dobson first turned his attention to composition in prose and verse, and some of his earliest known pieces remain among his best. It was not until 1868 that the appearance of *St Paul's*, a magazine edited by Anthony Trollope, afforded Mr Dobson an opportunity and an audience; and during the next six years he contributed to its pages some of his favourite poems, including "Tu Quoque," "A Gentleman of the Old School," "A Dialogue from Plato," and "Unc Marquise." Many of his poems in their original form were illustrated—some, indeed, actually written to support illustrations. By the autumn of 1873 Mr Dobson had produced sufficient verse for a volume, and put forth his *Vignettes in Rhyme*, which quickly passed through three editions. During the period of their appearance in the magazine the poems had received unusual attention, George Eliot, among others, extending generous encouragement to the anonymous author. The little book at once introduced him to a larger public. The period was an interesting one for a first appearance, since the air was full of metrical experiment. Swinburne's bold and dithyrambic excursions into classical metre had given the clue for an enlargement of the borders of English prosody; and, since it was hopeless to follow him in his own line without necessary loss of vigour, the poets of the day were looking about for fresh forms and variations. It was early in 1876 that a small body of English poets lit upon the French forms of Theodore de Banville, Marot and Villon, and determined to introduce them into English verse. Mr Austin Dobson, who had already made successful use of the triolet, was at the head of this movement, and in May 1876 he published in *The Prodigals* the first original ballade written in English. This he followed by English versions of the rondel, rondeau and villanelle. An article in the *Cornhill Magazine* by

Mr Edmund Gosse, "A Plea for Certain Exotic Forms of Verse," appearing in July 1877, simultaneously with Mr Dobson's second volume, *Proverbs in Porcelain*, drew the general eye to the possibilities and achievements of the movement. The experiment was extremely fortunate in its introduction. Mr Dobson is above all things natural, spontaneous and unaffected in poetic method; and in his hands a sheaf of metrical forms, essentially artificial and laborious, was made to assume the colour and bright profusion of a natural product. An air of pensive charm, of delicate sensibility, pervades the whole of these fresh revivals, and it is perhaps this personal touch of humanity which has given something like stability to one side of a movement otherwise transitory in influence. The fashion has faded, but the flowers of Mr Dobson's French garden remain bright and scented.

In 1883 Mr Dobson published *Old-World Idylls*, a volume which contains some of his most characteristic work. By this time his taste was gradually settling upon the period with which it has since become almost exclusively associated; and the spirit of the 18th century is revived in "The Ballad of Beau Brocade" and in "The Story of Rosina," as nowhere else in modern English poetry. In "Beau Brocade," indeed, the pictorial quality of his work, the dainty economy of eloquent touches, is at its very best: every couplet has its picture, and every picture is true and vivacious. The touch has often been likened to that of Randolph Caldecott, with which it has much in common; but Mr Dobson's humour is not so "rollicking," his portraiture not so broad, as that of the illustrator of "John Gilpin." The appeal is rather to the intellect, and the touches of subdued pathos in the "Gentleman" and "Gentlewoman of the Old School" are addressed directly to the heart. We are in the 18th century, but see it through the glasses of to-day; and the soft intercepting sense of change which hangs like a haze between ourselves and the subject is altogether due to the poet's sympathy and sensibility. *At the Sign of the Lyre* (1885) was the next of Mr Dobson's separate volumes of verse, although he has added to the body of his work in a volume of *Collected Poems* (1897). *At the Sign of the Lyre* contains examples of all his various moods. The admirably fresh and breezy "Ladies of St James's" has precisely the qualities we have traced in his other 18th-century poems; there are ballades and rondeaus, with all the earlier charm; and in "A Revolutionary Relic," as in "The Child Musician" of the *Old-World Idylls*, the poet reaches a depth of true pathos which he does not often attempt, but in which, when he seeks it, he never fails. At the pole opposite to these are the light occasional verses, not untouched by the influence of Præd, but also quite individual, buoyant and happy. But the chief novelty in *At the Sign of the Lyre* was the series of "Fables of Literature and Art," founded in manner upon Gay, and exquisitely finished in scholarship, taste and criticism. It is in these perhaps, more than in any other of his poems, that we see how with much felicity Mr Dobson interpenetrates the literature of fancy with the literature of judgment. After 1885 Mr Dobson was engaged principally upon critical and biographical prose, by which he has added very greatly to the general knowledge of his favourite 18th century. His biographies of *Fielding* (1883), *Bewick* (1884), *Sterle* (1886), *Goldsmith* (1888), *Walpole* (1890) and *Hogarth* (1879-1898) are studies marked alike by assiduous research, sympathetic presentation and sound criticism. It is particularly noticeable that Mr Dobson in his prose has always added something, and often a great deal, to our positive knowledge of the subject in question, his work as a critic never being solely aesthetic. In *Four Frenchwomen* (1890), in the three series of *Eighteenth-Century Vignettes* (1892-1894-1896), and in *The Paladin of Philanthropy* (1899), which contain unquestionably his most delicate prose work, the accurate detail of each study is relieved by a charm of expression which could only be attained by a poet. In 1901 he collected his hitherto unpublished poems in a volume entitled *Carmina Volupta*. Possessing an exquisite talent of defined range, Mr Austin Dobson may be said in his own words to have "held his pen in trust for Art" with a service sincere and distinguished.

DOBSON, WILLIAM (1610-1646), English portrait and historical painter, was born in London. His father was master of the alienation office, but by improvidence had fallen into reduced circumstances. The son was accordingly bound an apprentice to a stationer and picture dealer in Holborn Bridge; and while in his employment he began to copy the pictures of Titian and Van Dyck. He also took portraits from life under the advice and instruction of Francis Cleyn, a German artist of considerable repute. Van Dyck, happening to pass a shop in Snow Hill where one of Dobson's pictures was exposed, sought out the artist, and presented him to Charles I., who took Dobson under his protection, and not only sat to him several times for his own portrait, but caused the prince of Wales, Prince Rupert and many others to do the same. The king had a high opinion of his artistic ability, styled him the English Tintoretto, and appointed him serjeant-painter on the death of Van Dyck. After the fall of Charles, Dobson was reduced to great poverty, and fell into dissolute habits. He died at the early age of thirty-six. Excellent examples of Dobson's portraits are to be seen at Blenheim, Chatsworth and several other country seats throughout England. The head in the "Decollation of St John the Baptist" at Wilton is said to be a portrait of Prince Rupert.

DOCTAE, a name applied to those thinkers in the early Christian Church who held that Christ, during his life, had not a real or natural, but only an apparent (*doctae*, to appear) or phantom body. Other explanations of the *doctae* or appearance have, however, been suggested, and, in the absence of any statement by those who first used the word of the grounds on which they did so, it is impossible to determine between them with certainty. The name Doctae is first used by Theodoret (*Ep.* 82) as a general description, and by Clement of Alexandria as the designation of a distinct sect,¹ of which he says that Julius Cassianus was the founder. Docetism, however, undoubtedly existed before the time of Cassianus. The origin of the heresy is to be sought in the Greek, Alexandrine and Oriental philosophizing about the imperfection or rather the essential impurity of matter. Traces of a Jewish Docetism are to be found in Philo; and in the Christian form it is generally supposed to be combated in the writings of John,² and more formally in the epistles of Ignatius.³ It differed much in its complexion according to the points of view adopted by the different authors. Among the Gnostics and Manichaeans it existed in its most developed type, and in a milder form it is to be found even in the writings of the orthodox teachers. The more thoroughgoing Docetae assumed the position that Christ was born without any participation of matter; and that all the acts and sufferings of his human life, including the crucifixion, were only apparent. They denied accordingly, the resurrection and the ascent into heaven. To this class belonged Dositheus, Saturninus, Cerdo, Marcion and their followers, the Ophites, Manichaeans and others. Marcion, for example, regarded the body of Christ merely as an "umbra," a "phantasma." His denial (due to his abhorrence of the world) that Jesus was born or subjected to human development, is in striking contrast to the value which he sets on Christ's death on the cross. The other, or milder school of Docetae, attributed to Christ an ethereal and heavenly instead of a truly human body. Amongst these were Valentinus, Bardesanes, Basilides, Tatian and their followers. They varied considerably in their estimation of the share which this body had in the real actions and sufferings of Christ. Clement and Origen, at the head of the Alexandrian school, took a somewhat subtle view of the Incarnation, and Docetism pervades their controversies with the Monarchians. Hilary especially illustrates the prevalence of naive Docetic views as regards the details of the Incarnation. Docetic tendencies

¹ Not a distinct sect, but a continuous type of Christology. Hippolytus, however (*Philosophumena*, viii. 8-11), speaks of a definite party who called themselves Docetae.

² *Ep.* iv. 2, ii. 22, v. 6, 20; *2 Ep.* 7, cf. Jerome (*Dial. adv. Lucifer.* § 23 "Apoetolia adhuc in saeculo superstitibus, adhuc apud Iudaeam Christi sanguine recenti, phantasma Domini corpus aserebatur").

³ *Ad Trall.* 9 l., *Ad Smyrn.* 2, 4, *Ad Ephes.* 7. Cf. Polycarp., *Ad Phil.* 7.

have also been developed in later periods of ecclesiastical history, as for example by the Priscillianists and the Bogomils, and also since the Reformation by Jacob Boehme, Menno Simons and a small fraction of the Anabaptists. Docetism springs from the same roots as Gnosticism, and the Gnostics generally held Docetic views (see Gnosticism).

DOCHMIAC (from Gr. *δοχμή*, a hand's breadth), a form of verse, consisting of *dochmisi* or pentasyllabic feet (usually 0...0-).

DOCK, a word applied to (1) a plant (see below), (2) an artificial basin for ships (see below), (3) the fleshy solid part of an animal's tail, and (4) the railed-in enclosure in which a prisoner is placed in court at his trial. Dock (1) in O.E. is *docca*, represented by Ger. *Dochea-blatter*, O.Fr. *docque*, Gael. *dogha*; Skeat compares Gr. *δαίνας*, a kind of parsnip. Dock (2) appears in Dutch (*dok*) and English in the 16th century; thence it was adopted into other languages. It has been connected with Med. Lat. *doga*, cap, Gr. *δοχή*, receptacle, from *δέχεσθαι*, to receive. Dock (3), especially used of a horse or dog, appears in English in the 14th century; a parallel is found in Icel. *doche*, stumpy tail, and Ger. *Doche*, bundle, skein, is also connected with it. This word has given the verb "to dock," to cut short, curtail, especially used of the shortening of an animal's tail by severing one or more of the vertebrae. The English Kennel Club (Rules, 1905, revised 1907) disqualifies from prize-winning dogs whose tails have been docked; several breeds are, however, excepted, e.g. varieties of terriers and spaniels, poodles, &c., and such foreign dogs as may from time to time be determined by the club. The prisoners' dock (4) is apparently to be referred to Flem. *dok*, pen or hutch. It was probably first used in thieves' slang; according to the *New English Dictionary* it was known after 1610 in "bail-dock," a room at the corner of the Old Bailey left open at the top, "in which during the trials are put some of the malefactors" (*Scots. Mag.*, 1753).

DOCK, in botany, the name applied to the plants constituting the section *Lappalum* of the genus *Rumex*, natural order Polygonaceae. They are biennial or perennial herbs with a stout root-stock, and glabrous linear-lanceolate or oblong-lanceolate leaves with a rounded, obtuse or hollowed base and a more or less wavy or crisped margin. The flowers are arranged in more or less crowded whorls, the whole forming a denser or looser panicle; they are generally perfect, with six sepals, six stamens and a three-sided ovary bearing three styles with much-divided stigmas. The fruit is a triangular nut enveloped in the three enlarged leathery inner-sepals, one or all of which bear a tubercle. In the common or broad-leaved dock, *Rumex obtusifolius*, the flower-stem is erect, branching, and 18 in. to 3 ft. high, with large radical leaves, heart-shaped at the base, and more or less blunt; the other leaves are more pointed, and have shorter stalks. The whorls are many-flowered, close to the stem and mostly leafless. The root is many-headed, black externally and yellow within. The flowers appear from June to August. In autumn the whole plant may become of a bright red colour. It is a troublesome weed, common by roadsides and in fields, pastures and waste places throughout Europe. The great water dock, *R. hydro-lappalum*, believed to be the *herba britannica* of Pliny (*Nat. Hist.* xxv. 6), is a tall-growing species; its root is used as an antiscorbutic. Other British species are *R. crispus*; *R. conglomeratus*, the root of which has been employed in dyeing; *R. sanguineus* (bloody dock, or bloodwort); *R. palustris*; *R. pulcher* (fiddle dock), with fiddle-shaped leaves; *R. maritimus*; *R. aquaticus*; *R. pratensis*. The naturalized species, *R. alpinus*, or "monk's rhubarb," was early cultivated in Great Britain, and was accounted an excellent remedy for ague, but, like many other such drugs, is now discarded.

DOCK, in marine and river engineering. Vessels require to lie afloat alongside quays provided with suitable appliances in sheltered sites in order to discharge and take in cargoes conveniently and expeditiously; and a basin constructed for this purpose, surrounded by quay walls, is known as a dock. The term is specially applied to basins adjoining tidal rivers, or close to the sea-coast, in which the water is maintained at a fairly uniform level by gates, which are closed when the tide begi-

fall, as exemplified by the Liverpool and Havre docks (figs. 1 and 2). Sometimes, however, at ports situated on tidal rivers near their tidal limit, as at Glasgow (fig. 3), Hamburg and

Low-lying land adjoining a tidal river or estuary frequently provides suitable sites for docks; for the position, being more or less inland, is sheltered; the low level reduces the excavation



FIG. 1.—Liverpool Docks, North End.

Rouen, and at some ports near the sea-coast, such as Southampton (fig. 4) and New York, the tidal range is sufficiently moderate for dock gates to be dispensed with, and for open basins and river quays to serve for the accommodation of vessels. For ports

required for forming the docks, and enables the excavated materials to be utilized in raising the ground at the sides for quays; and the river furnishes a sheltered approach channel. Notable instances of these are the

Shes for Docks.

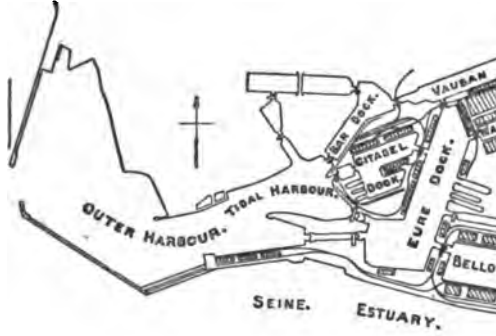

FIG. 2.—Havre Docks and Outer Harbour.

established on the sea-coast of tideless seas, such as the Mediterranean, on account of the rivers being barred by deltas at their outlets, like the Rhone and the Tiber, and thus rendered inaccessible, open basins, provided with quays and protected by

breakwaters, furnish the necessary commercial requirements for sea-going vessels, as for example at Marseilles (fig. 5), Genoa, Naples and Trieste. These open basins, however, are precisely the same as closed docks, except for the absence of dock gates; and the accommodation for shipping at the quays round basins in river ports is so frequently supplemented by river quays, that closed docks, open basins and river quays are all naturally included in the general consideration of dock works.

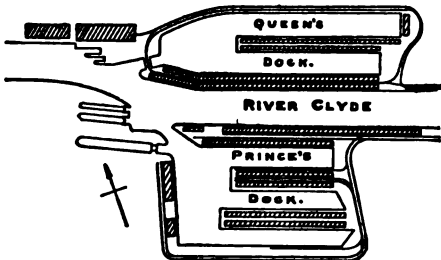

FIG. 3.—Glasgow Docks.

breakwaters, furnish the necessary commercial requirements for sea-going vessels, as for example at Marseilles (fig. 5), Genoa, Naples and Trieste. These open basins, however, are precisely the same as closed docks, except for the absence of dock gates; and the accommodation for shipping at the quays round basins in river ports is so frequently supplemented by river quays, that closed docks, open basins and river quays are all naturally included in the general consideration of dock works.

docks of the ports of London, Liverpool, South Wales, Southampton, Hull, Belfast, St Nazaire, Rotterdam, Antwerp and Hamburg. Sometimes docks are partially formed on foreshores reclaimed from estuaries, as at Hull, Grimsby, Cardiff, Liverpool, Leith and Havre; whilst at Bristol, a curved portion of the river Avon was appropriated for a dock, and a straight cut made for the river. By carrying docks across sharp bends of tidal rivers, upper and lower entrances can be provided, thereby conveniently separating the inland and sea-going traffic; and of this the London, Surrey Commercial, West India, and Victoria and Albert docks are examples on the Thames and Chatham dockyard on the Medway. Occasionally, when a small tidal river

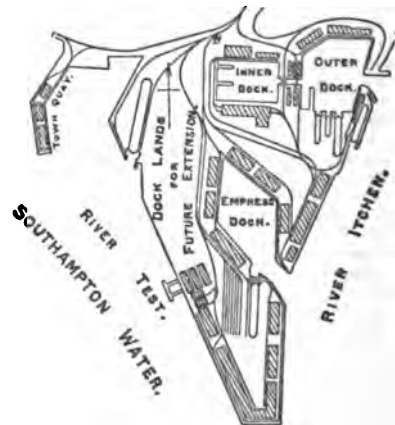

FIG. 4.—Southampton Docks and River Quays.

docks alongside, formed on foreshores adjoining the sea-coast, are provided with a sheltered entrance direct from the sea,

as exemplified by the Sunderland docks adjacent to the mouth of the river Wear, and the Havre docks at the outlet of the Seine estuary (fig. 2). Some old ports, originally established on sandy coasts where a creek, maintained by the influx and efflux of the tide from low-lying spaces near the shore, afforded some shelter and an outlet to the sea across the beach, have had their access improved by parallel jetties and dredging; and docks have been readily formed in the low-lying land only

of suction dredgers in sand (see DREDGE), together with the increasing draught of vessels, has resulted in a considerable increase being made in the available depth of rivers and channels leading to docks, and has necessitated the making of due allowance for the possibility of a reasonable improvement in determining the depth to be given to a new dock. On the other hand, there is a limit to the deepening of an approach channel, depending upon its length, the local conditions as regards

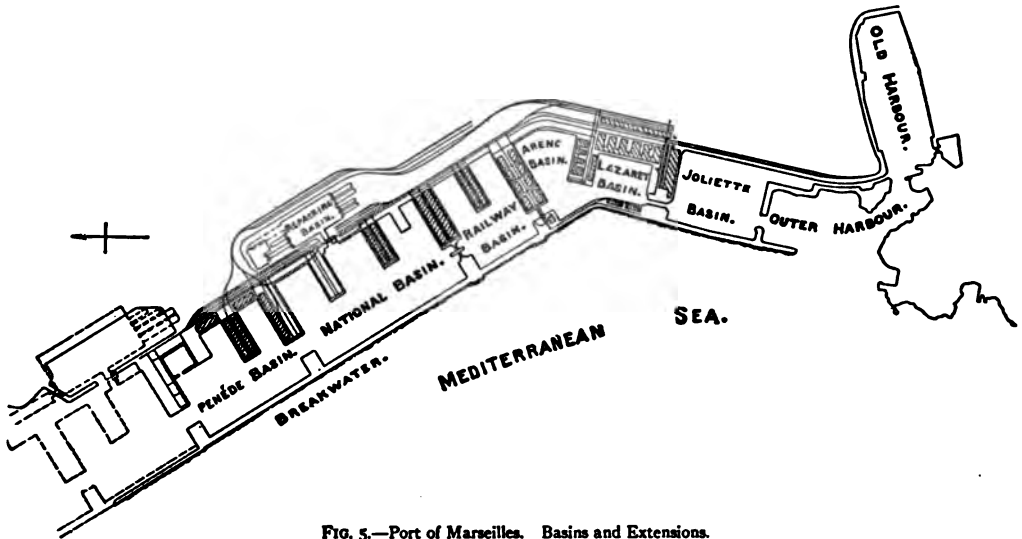

FIG. 5.—Port of Marseilles. Basins and Extensions.

separated by sand dunes from the sea, as at Calais, Dunkirk (fig. 6) and Ostend (see HARBOUR). In sheltered places on the sea-coast, docks have sometimes been constructed on low-lying land bordering the shore, with direct access to the sea, as at Barrow and Hartlepool; whilst at Mediterranean ports open basins have been formed in the sea, by establishing quays along the foreshore, from which wide, solid jetties, lined with quay walls, are carried into the sea at intervals at right angles to the shore, being sheltered by an outlying breakwater parallel to the coast, and reached at each end through the openings left between the projecting jetties and the breakwater, as at Marseilles (fig. 5) and Trieste, and at the extensions at Genoa (see HARBOUR) and Naples. Where, however, the basins are formed within the partial protection of a bay, as in the old ports of Genoa and Naples, the requisite additional shelter has been provided by converging breakwaters across the opening of the bay; and an entrance to the port is left between the breakwaters. The two deep arms of the sea at New York, known as the Hudson and East rivers, are so protected by Staten Island and Long Island that it has been only necessary to form open basins by projecting wide jetties or quays into them from the west and east shores of Manhattan Island, and from the New Jersey and Brooklyn shores, at intervals, to provide adequate accommodation for Atlantic liners and the sea-going trade of New York.

The accessibility of a port depends upon the depth of its approach channel, which also determines the depth of the docks or basins to which it leads; for it is useless to give a depth to a dock much in excess of the depth down to which there is a prospect of carrying the channel by which it is reached. The great augmentation, however, in the power and capacity for work of modern dredgers, and especially

silting, and the resources and prospects of trade of the port, for every addition to the depth generally involves a corresponding increase in the cost of maintenance.

At tidal ports the available depth for vessels should be reckoned from high water of the lowest neap tides, as the standard which is certain to be reached at high tide; and the period during which docks can be entered at each tide depends upon the nature of the approach channel, the extent of the tidal range and

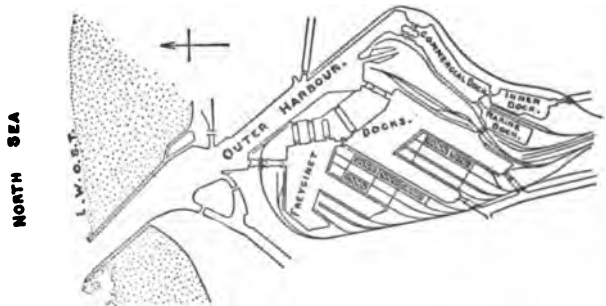

FIG. 6.—Dunkirk Docks and Jetty Channel.

the manner in which the entrance to the docks is effected. Thus where the tidal range is very large, as in the Severn estuary, the approach channels to some of the South Wales ports are nearly dry at low water of spring tides, and it would be impossible to make these ports accessible near low tide; whereas at high water, even of neap tides, vessels of large draught can enter their docks. At Liverpool, with a rise of 31 ft. at equinoctial spring tides, owing to the deep channel between Liverpool and Birkenhead and into the outer estuary of the Mersey in Liverpool

Bay, maintained by the powerful tidal scour resulting from the filling and emptying of the large inner estuary, access to the river by the largest vessels has been rendered possible, at any state of the tide, by dredging a channel through the Mersey bar; but the docks cannot be entered till the water has risen above half-tide level, and the gates are closed directly after high water.

A large floating landing-stage, however, about half a mile in length, in front of the centre of the docks, connected with the shore by several hinged bridges and rising and falling with the tide, enables Atlantic liners to come alongside and take on board or disembark their passengers at any time.

Comparatively small tidal rivers offer the best opportunity of a considerable improvement in the approach channel to a port; for they

can be converted into artificially deep channels by dredging, and their necessary maintenance is somewhat aided by the increased influx and efflux of tidal water due to the lowering of the low-water line by the outflow of the ebb tide being facilitated by the deepening. Thus systematic, continuous dredging

carried across an estuary to deep water requires constant dredging to maintain its depth. Occasionally, extensive draining works and dredging have to be executed to form an adequately deep channel through a shifting estuary and shallow river to a port, as for instance on the Weser to Bremerhaven and Bremen, on the Seine to Honfleur and Rouen, on the Tees to Middlesborough and Stockton, on the Ribble to Preston, on the Maas to Rotterdam and on the Nervion to Bilbao (see RIVER ENGINEERING). Southampton possesses the very rare combination of advantages of a well-sheltered and fairly deep estuary, a rise of only 12 ft. at spring tides, and a position at the head of Southampton Water at the confluence of two rivers (fig. 4), so that, with a moderate amount of dredging and the construction of quays along the lower ends of the river with a depth of 35 ft. in front of them at low water, it is possible for vessels of the largest draught to come alongside or leave the quays at any state of the tide. This circumstance has enabled Southampton to attract some of the Atlantic steamers formerly running to Liverpool.

Ports on tideless seas have to be placed where deep water approaches the shore, and where there is an absence of littoral drift. The basins of such ports are always accessible for vessels of the draught they provide for; but they require most efficient protection, and, unlike tidal ports, they are not able to exceptional occasions to admit a vessel of larger draught than the basins have been formed to accommodate. Occasionally, an old port whose approach channel has become inadequate for modern vessels, or from which the sea has receded, has been provided with deep access from the sea by a ship canal, as exemplified by Amsterdam and Bruges; whilst Manchester has become a seaport by similar works (see MANCHESTER SHIP CANAL). In such cases, however, perfectly sheltered open basins are formed inland at the head of the ship canal, in the most convenient available site; and the size of vessels that can use the port depends wholly on the dimensions and facility of access of the ship canal.

Docks require to be so designed that they may provide the maximum length of quays in proportion to the water area consistent with easy access for vessels to the quays; but often the space available does not admit of the adoption of the best forms, and the design has to be made as suitable as practicable under the existing conditions.

Design of Docks.

On this account, and owing to the small size of vessels in former times, the docks of old ports present a great variety in size and arrangement, being for the most part narrow and small, forming a sort of string of docks communicating with one another, and provided with locks or entrances at suitable points for their common use, as noticeable in the older London and Liverpool docks. Though narrow timber jetties were introduced in some of the wider London docks for increasing the length of quays by placing vessels alongside them, no definite arrangement of docks was adopted in carrying out the large Victoria and Albert docks between 1850 and 1880; whilst the Victoria dock was made wide with solid quays, provided with warehouses, projecting from the northern quay wall, thereby affording a large accommodation for vessels lying end on to the north quay, the Albert dock subsequently constructed was given about half the width of the earlier dock, but made much longer, so that vessels lie alongside the north and south quays in a long line. This change of form, however, was probably dictated by the advantage of stretching across the remainder of the wide bend, in order to obtain a second entrance in a lower reach of the river. The Tilbury docks, the latest and lowest docks

on the Thames, were constructed on the most approved modern system, consisting of a series of branch docks separated by wide, well-equipped solid quays, and opening straight into a main dock or basin communicating with the entrance lock, in which vessels can turn on entering or leaving the docks (fig. 7). The most recently constructed Liverpool docks, also, at the northern end have been given this form; and the older docks adjoining them to the south have been transformed by reconstruction into a similar series of branch docks opening into a dock alongside the river wall, leading to a half-tide basin or river entrances (fig. 1).

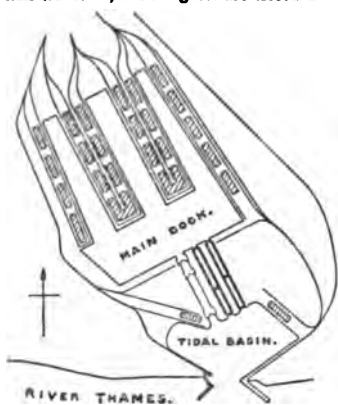

FIG. 7.—Tilbury Docks

can be converted into artificially deep channels by dredging, and their necessary maintenance is somewhat aided by the increased influx and efflux of tidal water due to the lowering of the low-water line by the outflow of the ebb tide being facilitated by the deepening. Thus systematic, continuous dredging

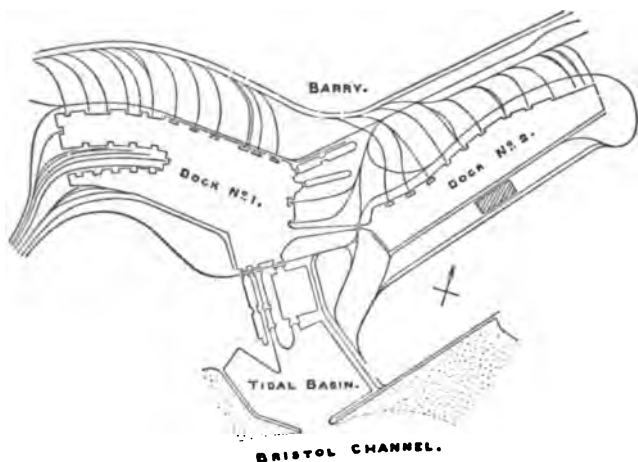

FIG. 8.—Barry Docks.

in the Tyne and the Clyde has raised the Tyne ports and Glasgow into first-class ports. In large tidal rivers and estuaries, docks should be placed alongside a concave bank which the deep navigable channel hugs, as effected at Hull and Antwerp, or close to a permanently deep channel in an estuary, such as chosen for Garston and the entrance to the Manchester ship canal at Eastham in the inner Mersey estuary, and for Grimsby and the authorized Illingham dock in the Humber estuary; for a channel

The Manchester and Salford docks were laid out on a precisely similar system, which was also adopted for the most recent docks at Dunkirk (fig. 6) and Prince's dock at Glasgow (fig. 3), and at some of the principal Rhine ports; whilst the Alexandra dock at Hull resembles it in principle. The basins in tideless seas have naturally been long formed in accordance with this system (fig. 5). The Barry docks furnish an example of the special arrangements for a coal-shipping port, with numerous coal-tips served by sidings (fig. 8).

Tidal basins, as they are termed, are generally interposed in the docks of London between the entrance locks and the docks, with the object of facilitating the passage of vessels out of and into the docks before and after high water, by lowering the water in the basin as soon as the tide has risen sufficiently, and opening the lock gates directly a level has been formed with the tide in the river. Then the vessels which have collected in the basin, when level with the dock, are readily passed successively into the river. The incoming vessels are next brought into the basin, and the gates are closed; and the water in the basin having been raised to the level in the dock, the gates shutting off the basin from the dock when the water was lowered are opened, and the vessels are admitted to the dock. In this manner, by means of an inner pair of gates, the basin can be used as a large lock without unduly altering the water-level in the dock, and saves the delay of locking most of the vessels out and in, the lock being only used for the smaller vessels leaving early or coming in late on the tide. Similar tidal basins have also been provided at Cardiff, Penarth, Barry (fig. 8), Sunderland, Antwerp and other docks.

The large half-tide docks introduced at the most modern Liverpool docks (fig. 1) serve a similar purpose as tidal basins; but being much larger, and approached by entrances instead of locks, the exit and entrance of vessels are effected by lowering their water-level on a rising tide, and opening the gates, which are then closed at high water to prevent the lowering of the water-level in the dock, and to avoid closing the gates against a strong issuing current.

The tidal basins outside the locks at Tilbury and Barry are quite open to the tide, and have been carried down to 24 ft. and 16 ft. respectively below low water of spring tides, in order to afford vessels a deep sheltered approach to the lock in each case, available at or near low water (figs. 7 and 8). Such basins, however, open to a considerable tidal range where the water is densely charged with silt, are exposed to a large deposit in the fairly still water, and their depth has to be constantly maintained by sluicing or dredging.

Where the range of tide is moderate, or on large inland rivers, docks or basins are usefully supplemented by river quays, which though subject to changes in the water-level, and exposed to currents in the river, are very convenient for access, and are sometimes very advantageously employed in regulating a river and keeping up its banks when deepened by dredging. Generally 10 to 12 ft. is the limit of the tidal range convenient for the adoption of open basins and river quays; but the banks of the Tyne have been utilized for quays, jetties and coal-tips, with a somewhat larger maximum tidal range; and a long line of quays stretching along the right bank of the Scheldt in front of Antwerp, constructed so as to regulate this reach of the river, accommodates a large sea-going traffic, with a rise at spring tides of 15 ft.

When a dock has to be formed on land, the excavation is effected by men with barrows and powerful steam navvies, loading into wagons drawn in trains by locomotives to the place of deposit, usually to raise the land at the sides for forming quays. Directly the underground water-level is reached, the water has to be removed from the excavations by pumps raising the inflowing water from sumps, lined with timber, sunk down below the lowest foundations at suitable positions, so that the lower portions of the dock walls and sills of the lock or entrance may be built out of water. A cofferdam has to be constructed extending out from the bank of the river or approach channel in front of the site of the proposed entrance or lock, so that the excavations for the entrance to the dock may be pushed forwards, and the lock or entrance built under its protection. Sometimes the lowest portion of the excavation for the dock can be accomplished economically by dredging, after the dock walls and lock have been completed and the water admitted.

Where a dock is partially or wholly constructed on reclaimed land, the reclamation bank for enclosing the site and excluding the tide has to be undertaken first by tipping an embankment from each end with wagons, protected and consolidated along its outer toe by rubble stone or chalk. When the ends of the embankments are approaching one another, it is essential to connect them by a long low bank of selected materials brought up gradually in successive layers, and retaining the water in the enclosure to the level of this bank, so that the influx and efflux of the tide, filling and emptying the reclaimed area, may take place over a long length, and in smaller volume as the low bank is raised. In this way a reduction is effected of the tidal current in and out, which in the case of a large enclosure and a considerable tidal range, would create such a scour in the narrowing gap between two high embankments as to wash away their ends and prevent the closing of the gap. Occasionally the final closure is effected by lowering timber panels in grooves between

a series of piles driven down at intervals across the gap. On the closing of the reclamation bank the water is pumped out; and the excavation is carried on in the ordinary manner. It is very important that such an embankment should be carried well above the level of the highest tide which might be raised by a high wind; and in exposed sites, the outer slope of the bank should be protected by pitching from the action of waves, for any overtopping or erosion of the bank might result in a large breach through it, and the flooding of the works inside.

Docks are generally surrounded by walls retaining the quays, alongside which vessels lie for discharging and taking in cargoes. In order to ascertain the nature of the strata upon which these walls have to be founded, borings are taken at the **Foundations for dock walls.** outset to the requisite depth at intervals near the line of the walls, but inside the dock area if the piercing of the quicksand is anticipated, as in excavating for the foundations, these holes might give rise to the outflow, under pressure, of underlying quicksand into the foundations. As docks are generally formed near rivers or estuaries, these strata are commonly alluvial; but being situated at some depth below the surface, they are usually fairly hard. When they consist of gravel, clay or firm sand, the walls can be founded on the natural bottom excavated a few feet below the bottom of the dock, their weight being somewhat distributed by making them rest on a broad bed of concrete filling up the excavation at the bottom. When, however, fine sand or silt charged with water, or quicksand is met with at the required depth, the necessary pumping and excavation for the foundations might occasion the influx of sand or silt with the water into the excavations, leading to settlement and slips; or the soft stratum might be too thick to remove. The wall may then be founded on bearing piles driven down to a solid stratum, and having their tops joined together by walings and planking, or by a layer of concrete, upon which the wall is built. Or the soft stratum can be enclosed with a double row of sheet piling along the front and back of the line of wall, by which it sometimes becomes sufficiently confined and consolidated to sustain the weight of the wall on a broad foundation of concrete; or it can be excavated without any danger of sand or silt running in from outside; whilst sheet piling at the back relieves the wall to some extent from the pressure of the earth behind it, and in front retains the wall from sliding forwards. Firmer foundations have been obtained by sinking brick, concrete or masonry wells through soft ground to a solid stratum, upon which the dock wall is built. Clusters of small concrete cylinders, in sets of three in front, and a line of double cylinders at the back, were used for the foundations of the walls of Prince's dock at Glasgow. Wells of rubble masonry were sunk in the silty fore-shore of the Seine estuary for the walls of the Bellot docks at Havre; and they served as piers, connected by arches, for the foundations of a continuous dock wall above, being carried down to a considerable depth through alluvium at the St Nazaire, Bordeaux and Rochefort docks. These well foundations, derived from the old Indian system, are built up upon a curb, sometimes furnished with a cutting edge underneath, and gradually sunk by excavating inside; and eventually the central hollow is filled up solid with concrete or masonry.

The walls round a dock serve as retaining walls to keep up the quays; and though they have the support of the water in front of them when the docks are in use, they have to sustain the full pressure of the filling at the back on the completion of the dock before the water is admitted. They have, accordingly, to be increased in thickness downwards to support the pressure increasing with the depth. This pressure, with perfectly dry material, **Dock walls.** would be represented by the weight of half the prism of filling between the natural slope of the material behind and the back of the wall; but the pressure is often increased by the accumulation of water at the back, which, with fine silt backing, is liable to exert a sort of fluid pressure against the wall proportionate to the density of the mixture of silt and water. The increase of thickness towards the base used formerly to be effected by a batter on the face, as well as by steps out at the back; but the vertical form now given to the sides of large vessels necessitates a corresponding fairly vertical face for the wall, to prevent the upper part of the vessel being kept unduly away from the quay. Examples of the most modern types of dock walls are given in figs. 9 to 12.

The height of a dock wall depends upon the depth of water always available for vessels, at tideless sea-ports and at ports removed from tidal influences, such as Manchester, Bruges and the ports on the Rhine; this depth should not be less than 28 to 30 ft. for large sea-going vessels, together with a margin of 5 to 8 ft. above the normal water-level for the quays, and the foundations below. At tidal ports, however, an addition has to be made equal to the difference in height between the high-water levels of spring and neap tides; so that at ports with a large tidal range, such as the South Wales ports on the Severn estuary and Liverpool, specially high dock walls are necessary. Under normal conditions, a dock wall should



FIG. 9.—Havre Bellot Dock Wall.

be given a width at a height half-way between dock-bottom and quay-level, equal to one-third of its height above dock-bottom, and a width of half this height at dock-bottom.

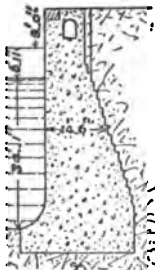

FIG. 10.—Liverpool Dock Wall.

labour. Such walls require to be given a facing of stronger concrete, or of blue bricks, as at Tilbury, to guard against abrasion by vessels, chains and ropes; and dock walls are commonly provided at the top with granite or other hard stone coping where the wear is greatest. The foundations for dock walls are excavated in a trench below dock-bottom, only lined with timbering where the faces of the trench cannot stand for a short time without support, and with sheet piling through very unstable silt or sand; and the trench is conveniently filled up solid with concrete, carried out in short lengths in untrustworthy ground. To reduce the amount of filling behind the wall, the excavation at the back above dock-bottom, preparatory for the trench, is given as steep a slope as practicable, supported sometimes towards the base by timbering and struts; but occasionally the wall is built within a timbered trench carried down to the required depth, before the excavation for the dock in front of it has been executed, as effected at Tilbury. The filling at the back is thus reduced to a minimum, and the lower portion of the excavation can be accomplished by dredging, if expedient, after the admission of the water, the

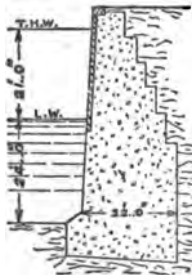

FIG. 11.—Tilbury Basin Wall.

dock wall in this way being exposed to the least possible pressure behind. The walls of open basins are often constructed out of water precisely like dock walls, as in the case of the basins forming the Manchester, Bruges and Glasgow docks; and basin walls open to the tide, as at Glasgow and in the tidal basin outside Tilbury docks (fig. 7), differ only from dock walls in being exposed to variations in the pressure at the back resulting from the lowering of the water-level in front, which is, indeed, shared to some extent by the walls round closed docks where the difference in the high-water levels of springs and neaps is considerable. The walls, however, round basins in tideless seas, such as Marseilles, occasionally those inside along rivers, and especially quay walls alongside rivers, have to be constructed under water.

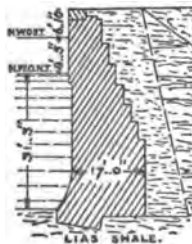

FIG. 12.—Barry Dock Wall.

reached sea-level, and then building a solid masonry quay wall out of water on the top up to quay-level, faced with ashlar (fig. 13), the wall being backed by rubble for some distance behind up to the water-level. The same system was employed for the quay walls at Trieste, and at Genoa and other Italian ports. A quay wall inside Marmagao harbour, on the west coast of India, was erected on a foundation layer of rubble by the sloping-block system, to provide against unequal settlement on the soft bottom (see **BREAK-WATER**). The quay walls alongside the river Liffey, and the

adjacent basins below Dublin, were erected under water by building rubble-concrete blocks of 360 tons on staging carried out into the water, from which they were lifted one by one by a powerful floating derrick, which conveyed the block to the site, and deposited it on a levelled bottom at low tide in a depth of 28 ft., raising the wall a little above low water. After a row of these blocks had been laid, and connected together by filling the grooves formed at the sides and the interstices with concrete, a continuous masonry wall faced with ashlar was built on the top out of water. A quay wall was built up to a little above low water on a similar principle at Cork, with three smaller blocks as a foundation, in lengths of 8 ft. Cylindrical well foundations have been extensively used for the foundations of the quay walls along the Clyde, formerly made of brick, but subsequently of concrete, sunk through a considerable variety of alluvial strata, but mostly sand and gravel fully charged with water. Compressed air in bottomless caissons has been increasingly employed in recent years for carrying down the subaqueous foundations of river quay walls, through alluvial deposits, to a solid stratum. About 1880, a long line of river quays was commenced in front of Antwerp, extending in the central portion a considerable distance out into the Scheldt, with the object of regulating the width of the river simultaneously with the provision of deep quays for sea-going vessels; and the quay wall was erected, out of water, on the flat tops of a series of wrought-iron caissons, 82 ft. long and 29½ ft. wide, constructed on shore, floated out one by one to their site in the river between two barges, and gradually lowered as the wall was built up inside a plate-iron enclosure round the roof of the caisson, which was eventually sunk by aid of compressed air through the bed of the river to a compact stratum (fig. 14). The weight of the wall counteracted the tendency of the caisson and the enclosure above it to float; and the caisson, furnished with seven circular wrought-iron shafts, provided with air-locks at the top for the admission of men and materials and for the removal of the excavations, was gradually carried down by excavating inside the working chamber at the bottom, 6½ ft. high, till a good foundation was reached. The working chamber was then filled with concrete through some of the shafts, the plate-iron sides of the upper enclosure were removed to be used for another length of wall, the shafts were drawn out and the hollows left by them filled with concrete, the apertures between adjacent lengths were closed at each face with wooden panels and filled with concrete, and a continuous quay wall was completed above. The most recent quay walls constructed in the old harbour

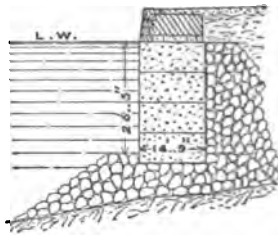

FIG. 13.—Marseilles Quay Wall.

at a similar principle at Cork, with three smaller blocks as a foundation, in lengths of 8 ft. Cylindrical well foundations have been extensively used for the foundations of the quay walls along the Clyde, formerly made of brick, but subsequently of concrete, sunk through a considerable variety of alluvial strata, but mostly sand and gravel fully charged with water. Compressed air in bottomless caissons has been increasingly employed in recent years for carrying down the subaqueous foundations of river quay walls, through alluvial deposits, to a solid stratum. About 1880, a long line of river quays was commenced in front of Antwerp, extending in the central portion a considerable distance out into the Scheldt, with the object of regulating the width of the river simultaneously with the provision of deep quays for sea-going vessels; and the quay wall was erected, out of water, on the flat tops of a series of wrought-iron caissons, 82 ft. long and 29½ ft. wide, constructed on shore, floated out one by one to their site in the river between two barges, and gradually lowered as the wall was built up inside a plate-iron enclosure round the roof of the caisson, which was eventually sunk by aid of compressed air through the bed of the river to a compact stratum (fig. 14). The weight of the wall counteracted the tendency of the caisson and the enclosure above it to float; and the caisson, furnished with seven circular wrought-iron shafts, provided with air-locks at the top for the admission of men and materials and for the removal of the excavations, was gradually carried down by excavating inside the working chamber at the bottom, 6½ ft. high, till a good foundation was reached. The working chamber was then filled with concrete through some of the shafts, the plate-iron sides of the upper enclosure were removed to be used for another length of wall, the shafts were drawn out and the hollows left by them filled with concrete, the apertures between adjacent lengths were closed at each face with wooden panels and filled with concrete, and a continuous quay wall was completed above. The most recent quay walls constructed in the old harbour

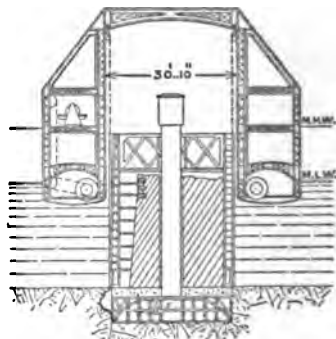

FIG. 14.—Antwerp Quay Wall, founded by compressed air.

at a similar principle at Cork, with three smaller blocks as a foundation, in lengths of 8 ft. Cylindrical well foundations have been extensively used for the foundations of the quay walls along the Clyde, formerly made of brick, but subsequently of concrete, sunk through a considerable variety of alluvial strata, but mostly sand and gravel fully charged with water. Compressed air in bottomless caissons has been increasingly employed in recent years for carrying down the subaqueous foundations of river quay walls, through alluvial deposits, to a solid stratum. About 1880, a long line of river quays was commenced in front of Antwerp, extending in the central portion a considerable distance out into the Scheldt, with the object of regulating the width of the river simultaneously with the provision of deep quays for sea-going vessels; and the quay wall was erected, out of water, on the flat tops of a series of wrought-iron caissons, 82 ft. long and 29½ ft. wide, constructed on shore, floated out one by one to their site in the river between two barges, and gradually lowered as the wall was built up inside a plate-iron enclosure round the roof of the caisson, which was eventually sunk by aid of compressed air through the bed of the river to a compact stratum (fig. 14). The weight of the wall counteracted the tendency of the caisson and the enclosure above it to float; and the caisson, furnished with seven circular wrought-iron shafts, provided with air-locks at the top for the admission of men and materials and for the removal of the excavations, was gradually carried down by excavating inside the working chamber at the bottom, 6½ ft. high, till a good foundation was reached. The working chamber was then filled with concrete through some of the shafts, the plate-iron sides of the upper enclosure were removed to be used for another length of wall, the shafts were drawn out and the hollows left by them filled with concrete, the apertures between adjacent lengths were closed at each face with wooden panels and filled with concrete, and a continuous quay wall was completed above. The most recent quay walls constructed in the old harbour

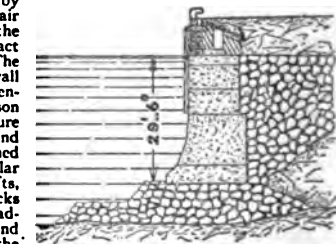

FIG. 15.—Caracciolo Jetty Quay Wall, Genoa.

at a similar principle at Cork, with three smaller blocks as a foundation, in lengths of 8 ft. Cylindrical well foundations have been extensively used for the foundations of the quay walls along the Clyde, formerly made of brick, but subsequently of concrete, sunk through a considerable variety of alluvial strata, but mostly sand and gravel fully charged with water. Compressed air in bottomless caissons has been increasingly employed in recent years for carrying down the subaqueous foundations of river quay walls, through alluvial deposits, to a solid stratum. About 1880, a long line of river quays was commenced in front of Antwerp, extending in the central portion a considerable distance out into the Scheldt, with the object of regulating the width of the river simultaneously with the provision of deep quays for sea-going vessels; and the quay wall was erected, out of water, on the flat tops of a series of wrought-iron caissons, 82 ft. long and 29½ ft. wide, constructed on shore, floated out one by one to their site in the river between two barges, and gradually lowered as the wall was built up inside a plate-iron enclosure round the roof of the caisson, which was eventually sunk by aid of compressed air through the bed of the river to a compact stratum (fig. 14). The weight of the wall counteracted the tendency of the caisson and the enclosure above it to float; and the caisson, furnished with seven circular wrought-iron shafts, provided with air-locks at the top for the admission of men and materials and for the removal of the excavations, was gradually carried down by excavating inside the working chamber at the bottom, 6½ ft. high, till a good foundation was reached. The working chamber was then filled with concrete through some of the shafts, the plate-iron sides of the upper enclosure were removed to be used for another length of wall, the shafts were drawn out and the hollows left by them filled with concrete, the apertures between adjacent lengths were closed at each face with wooden panels and filled with concrete, and a continuous quay wall was completed above. The most recent quay walls constructed in the old harbour

at Genoa were founded under water on a rubble mound in a similar manner by the aid of compressed air (fig. 15). Quay walls also on the Clyde have been founded on caissons, consisting of a bottomless steel structure, surmounted by a brick superstructure having hollows filled with concrete, in lengths of 80 ft. and 27 ft., and widths of 18 ft. and 21 ft. respectively, carried down by means of compressed air from 54 to 70 ft. below quay-level, on the top of which a continuous wall of concrete, faced with brickwork,

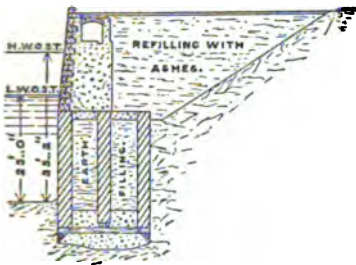

FIG. 16.—Glasgow River Quay Wall.

and having a granite coping, was built up from near low-water level (fig. 16). In many cases where soft strata extend to considerable depths, river quays and basin walls have been constructed by building a light quay wall upon a series of bearing and raking piles driven into, and if possible through, the soft alluvium. Thus the walls along the Seine, and round the basins at Rouen, were built upon bearing piles carried down through the alluvial bed of the river to the chalk. The lower portion of the quay wall was constructed of concrete faced with brickwork within water-tight timber caissons, resting upon the piles at a depth of 9½ ft. below low water; and upon this a rubble wall faced with bricks was erected from low water to quay-level, backed by rubble stone laid on a timber flooring supported by piles, together with chalk, to form a quay right back to the top of the slope of the bank of the deepened river (fig. 17). The quay walls of the open basins bordering the Hudson river at New York have had, in certain parts, to be founded on bearing piles combined with raking piles, driven into a thick bed of soft silt where no firm stratum could be reached, and where, therefore, the weight could only be borne by the adherence of the long piles in the silt. Before driving the piles, however, the silt round the upper part of the piles and under the quay wall was consolidated by depositing small stones in a trench dredged to a depth of 30 ft. below low water; the piles were driven through these stones, and were further kept in place by a long toe of rubble stone in front and a backing of rubble stone behind carried nearly up to quay-level, behind which a light filling of ashes and earth was raised to quay-level. The slight quay wall resting upon the front rows of bearing piles was carried up under water by 70-ton concrete blocks deposited by means of a floating derrick; and the upper part of the wall was built of concrete faced with ashlar masonry (fig. 18). The basin and quay walls at Bremen, Bremerhaven and Hamburg were built on a series of bearing and raking piles driven down to a firm stratum, the wall being begun a few feet below low water. At Southampton, ferro-concrete piles were employed in constructing the deep quays; and a wharfing of timber pilework has been frequently used for river quays.

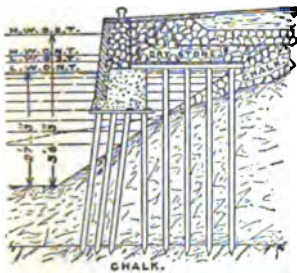

FIG. 17.—Rouen Quay Wall.

Where the increase of trade is moderate and the conditions of the traffic permit, and also at coal-shipping ports, economy in construction is obtained by giving sloping sides to a portion of a dock in place of dock walls, the slope being pitched where necessary with stone; and the length of the slope projecting into a dock is sometimes reduced by substituting sheet piling for the slope at the toe up to a certain height. By this arrangement jetties can be carried out across the slope as required, enabling vessels to lie against their ends; and coal-tips are very conveniently extended out across the slope at suitable intervals (fig. 8).

As dock walls, especially before the admission of water into the dock, constitute high retaining walls, not infrequently founded upon soft or slippery strata, and backed up with the excavated materials from alluvial beds, into which water is liable to percolate, they are naturally exposed under unfavourable conditions to the danger of failure. A dock wall erected on unsatisfactory foundations is liable, where the bottom is soft, to

settle down at its toe, owing to the pressure at the back, and to fall forwards into the dock, as occurred at Belfast; or where the silty bottom slips forward under the weight of the backing, the wall may follow the slip at the bottom and settle down at the back, falling to some extent backwards, as exemplified by the failure of the Empress basin wall at Southampton. The most common form, however, of failure is the sliding forwards of a dock wall, with little or no subsidence, on a silty or slippery stratum under the pressure imposed by the backing. Thus the Kidderpur dock walls furnish an instance of sliding forwards on muddy silt, and part of the South West India dock walls on two underlying, detached, slippery seams of London clay.

To avoid these failures with untrustworthy foundations, great care has to be exercised in selecting the best hard material available, unaffected by water, for the backing, which should be brought up in thin, horizontal layers carefully consolidated; and where there is a possibility of water accumulating at the back, pipes should be introduced at intervals near the bottom right through the wall in building it, and rubble stone deposited close to the back of the wall, so as to carry off any water from behind, these pipes being stopped up just before the water is let into the dock. These precautions, moreover, are assisted by reducing the amount of backing to a minimum in the construction of the wall, best effected by building the wall inside a timbered trench. The liability to slide forwards can be obviated by carrying down the foundations of the wall sufficiently below dock-bottom to provide an efficient buttress of earth in front of the wall, and also by making the base of the wall slope down

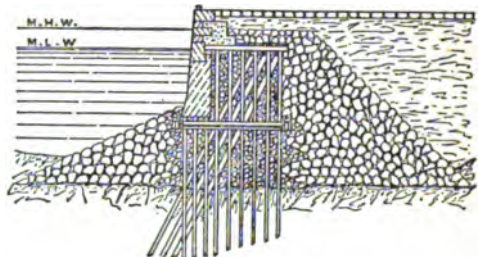

FIG. 18.—New York Quay Wall, Hudson river.

towards the back, thereby forcing the wall in sliding forwards to mount the slope, or to push forward a larger mass of earth; whilst a row of sheet piling in front of the foundations offers a very effectual impediment to a forward movement, and, in combination with bearing piles, prevents settlement at the toe in soft ground. In very treacherous foundations it may be advisable to defer the completion of the backing till after the admission of the water; but the additional stability given to a retaining wall or reservoir dam by an ample batter in front, is precluded in dock walls by the modern requirements of vessels.

Silt accumulates in docks where the lowering of the water-level by locking, the drawing down of half-tide basins, and the raising of the water at spring tides, involve the admission of considerable volumes of tidal water heavily charged with silt, which is deposited in still water and has to be periodically removed by dredging. To avoid this, the water is sometimes replenished from some clear inland source, an arrangement adopted at some of the South Wales ports opening into the muddy Severn estuary, and at the Alexandria dock, Hull, to exclude the silty waters of the Humber. At the Kidderpur docks on the Hglti, the water from the river for replenishing the docks is conducted by a circuitous canal, in which it deposits its burden of silt before it is pumped into the docks.

In order to deal expeditiously with the cargoes and goods brought into and despatched from docks, numerous sidings communicating with the railways of the district are arranged along the quays, which are also provided with steam, hydraulic or electric travelling cranes at intervals alongside the docks, basins or river, for discharging or loading vessels, and with sheds and warehouses for the storage of merchandise, &c., the arrangements depending largely upon the special trade of the port. Though different sources of power are sometimes made use of at different parts of the same port, as for example at Hamburg, where the numerous cranes are worked by steam, hydraulic power or most recently by electricity, and a few by gas engines, it is generally most convenient to work the various installations by one form of power from a central station. Water-pressure has been very commonly used

Maintenance of depth.

Equipment on quays.

as the motive power at docks, being generated by a steam-engine and stored up by one or more accumulators, from which the water is transmitted under pressure through strong cast-iron pipes to the hydraulic engines which actuate the cranes, lifts, coal-tips, capstans, swing-bridges and gate machinery throughout the docks (see POWER TRANSMISSION: *Hydraulic*). The intermittent working of the machinery in docks results in a considerable variation in the power needed at different times; but economical working is secured by arranging that when the accumulators are full, steam is automatically shut off from the pumping engines, but is supplied again as soon as water is drawn off. Electricity affords another means for the economical transmission of power to a distance suited for intermittent working; as far back as 1902 it was being adopted at Hamburg as the source of power for the machinery of the extensive additional basins then recently opened for traffic.

At ports where the principal trade is the export of coal from neighbouring collieries, special provision has to be made for its rapid shipment. Coal-tips, accordingly, are erected at the sides of the dock in these ports, with sidings on the quays at the back for receiving the trains of coal trucks, from which two lines of way diverge to each coal-tip, one serving for the conveyance of the full wagons one by one to the tip, after passing over a weigh-bridge, and the other for the return of the empty wagons to the siding where the empty train is made up for returning to the colliery (fig. 8). Each full wagon is either run at a low level upon a cradle at the tip, then raised on the cradle within a wrought-iron lattice tower to a suitable height, and lastly, tipped up at the back for discharging the coal; or it is brought along a high-level road on to a cradle raised to this level on the tower, and tipped up at this or some slightly modified level. The coal is discharged down an adjustable iron shoot, gradually narrowed so as to check the fall; and on first discharging into the hold of a vessel, an anti-breakage box is suspended below the mouth of the shoot. When full, this is lowered to the bottom of the hold and emptied, thereby gradually forming a cone of coal upon which the coal can be discharged directly from the shoot without danger of breakage. Other contrivances are also adopted with the same object.

In designing dock works, it is expedient to make provision, as far as possible, for future extensions as the trade of the port increases. Generally this can be effected alongside tidal rivers and estuaries by utilizing sites lower down the river, as carried out on the Thames for the port of London, or reclaiming unoccupied foreshores of an estuary, as adopted for extensions of the ports of Liverpool, Hull and Havre. At ports on the sea-coast of tideless seas, it is only necessary to extend the outlying break-water parallel to the shore line, and form additional basins under its shelter, as at Marseilles (fig. 5) and Genoa (see HARBOURS). Quays also along rivers furnish very valuable opportunities of readily extending the accommodation of ports. Ports, however, established inland like Manchester, though extremely serviceable in converting an inland city into a seaport, are at the disadvantage of having to acquire very valuable land for any extensions that may be required; but, nevertheless, some compensation is afforded by the complete shelter in which the extensions can be carried out, when compared with Liverpool, where the additions to the docks can only be effected by troublesome reclamation works along the foreshore to the north, in increasingly exposed situations.

Dock Entrances and Locks.—The size of vessels which a port can admit depends upon the depth and width of the entrance to the docks; for, though the access of vessels is also governed by the depth of the approach channel, this channel is often capable of being further deepened to some extent by dredging; whereas the entrance, formed of solid masonry or concrete, cannot be adapted, except by troublesome and costly works sometimes amounting to reconstruction, to the increasing dimensions of vessels. Accordingly, in designing new dock works with entrances and locks, it is essential to look forward to the possible future requirements of vessels. The necessity for such forethought is illustrated by the rapid increase which has taken place in the size of the largest ocean liners. Thus the "City of Rome," launched in 1881, is 560 ft. long, and 52½ ft. beam, and has a maximum recorded draught of 27½ ft.; the "Campania" and "Lucania," in 1893, measure 600 ft. by 65 ft.; the "Oceanic,"

in 1899, 685½ ft. by 68½ ft., with a maximum draught of 31½ ft.; the "Baltic," in 1903, 709 ft. by 75 ft., with a maximum draught of 31½ ft.; and the "Lusitania" and "Mauritania," launched in 1906, 787½ ft. by 88 ft.

The width and depth of access to docks are of more importance than the length of locks; for docks which are reached through entrances with a single pair of gates have to admit vessels towards high water when the water-level in the dock is the same as in the approach channel, or through a half-tide basin drawn down to the level of the water outside, and are therefore accessible to vessels of any length, provided the width of the entrance and depth over the sill are adequate; whilst at docks which are entered through locks, vessels which are longer than the available length of the lock can get in at high water when both pairs of gates of the lock are open. Open basins are generally given an ample width of entrance, and river quays also are always accessible to the longest and broadest vessels; but in a tidal river the available depth has to be reckoned from the lowest low water of spring tides, instead of from the lowest high water of neap tides, if the vessels in the open basins and alongside the river quays have to be always afloat.

Many years ago the Canada lock at Liverpool, the outer North lock at Birkenhead, the Ramsden lock and entrance at Barrow-in-Furness, and the Eure entrance at Havre, were given a width of 100 ft. Probably this was done with the view of admitting paddle steamers, since subsequent entrances at Liverpool were given widths of 80 and 65 ft.; whereas none of the locks in the port of London has been made wider than 80 ft., which has been the standard maximum width since the completion of the Victoria dock in 1866. The widest locks at Cardiff are 80 ft., and the entrance to the Barry docks is the same; but the lock of the Alexandra dock, Hull, opened in 1885, was made 85 ft. wide. At Liverpool, where the access to the docks is mainly through entrances, on account of the small width between the river and the high ground rising at the back, and where ample provision has to be made for the largest Atlantic liners, though the entrances to the Langton dock, completed in 1881, leading to the latest docks at the northern end were made 65 ft. wide, with their sills 3 ft. below low water of spring tides and 20½ ft. below high water of the lowest neap tides, the two new entrances to the deepened Brunswick dock near the southern end, giving access to the adjacent reconstructed docks, completed in 1906, were made 80 and 100 ft. wide, with sills 28 ft. below high water of the lowest neap tides. Moreover, the three new entrances to the new Sandon half-tide dock, completed in 1906, communicating with the reconstructed line of docks to the south of the Canada basin, and with the latest northern extensions of the Liverpool docks, were made 40 ft. wide with a depth over the sill of 24½ ft., and 80 and 100 ft. wide on each end of the central entrance, with sills 39 ft. below high water of the lowest neap tides, each entrance being provided with two pairs of gates, in case of any accident occurring to one pair, according to the regular custom at Liverpool. Powers were also obtained in 1906 for the construction of a half-tide dock and two branch docks to the north of the Hornby dock, which are to be reached from the river by two entrances designed to be 130 ft. wide, with sills 38½ ft. below high water of the lowest neap tides, so as to meet fully the assumed future increase in the beam and draught of the largest vessels; whilst the authorized extension of the river wall northwards will enable additional docks to be constructed in communication with these entrances when required.

Though, with the exception of Southampton and Dover, other British ports do not aim, like Liverpool, at accommodating the largest Atlantic liners at all times, the depths of the sills at the principal ports have been increased in the most recent extensions. Thus at the port of London the sills of the first lock of the Albert dock were 26½ ft. below high water of neap tides, and of the second lock adjoining, 32½ ft. deep; whilst the sills of the lock of the Tilbury docks are 40½ ft. below high water of neap tides. Moreover, in spite of the great range of tide at the South Wales ports on the Severn estuary, the available depth at high water of neap tides of 25 ft. at the Roath lock Cardiff, was increased

in the lock of the new dock to 31½ ft.; the depth at the entrance to the Barry docks, opened in 1889, was 29½ ft., but at the lock opened in 1896 was made 41½ ft.; whilst a depth of 34 ft. has been proposed for the new lock of the Alexandra dock extension at Newport, nearly 10 ft. deeper than the existing lock sills there. Similar improvements in depth have also been made or designed at other ports to provide for the increasing draught of vessels.

The length of locks has also been increased, from 550 ft. at the Albert dock, to 700 ft. at Tilbury in the port of London, from 300 ft. to 550 ft. at Hull, and from 350 ft. to 660 ft. at Cardiff. The lock at the Barry docks is 647 ft. long, though only 65 ft. wide. A lock constructed in connexion with the improvement works at Havre, carried out in 1896-1907, was given an available length of 805 ft. and a width of 98½ ft., with a depth over the sills of 34½ ft. at high water of neap tides.

Entrances with a single pair of gates, closing against a raised sill at the bottom and meeting in the centre, have to be made long

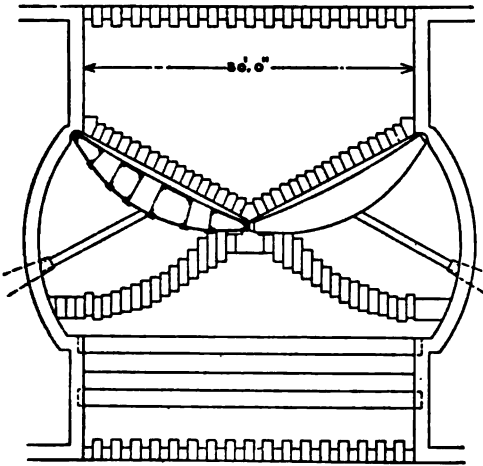

FIG. 19.—Barry Docks, Entrance.

enough to provide a recess in each side wall at the back to receive the gates when they are opened, and to form a buttress in front on each side to bear the thrust of the gates when closed against a head of water inside. A masonry floor is laid on the bottom in continuation of the sill, serving as an apron against erosion by water leaking between or under the gates, and by the current through the sluiceways in the gates, when opened for scouring the entrance channel or to assist in lowering the water in a half-tide dock for opening the gates (fig. 19). A sluiceway in each side wall, closed by a vertical sluice-gate, generally provided in duplicate in case of accidents and worked by a machine actuated by hydraulic pressure, enables the half-tide basin to be brought down to the level of the approach channel outside with a rising tide, so that vessels may be brought into or passed out of the basin towards high water. The advantages of these entrances are, that they occupy comparatively little room where the space is limited, and are much less costly than locks; whilst in conjunction with a half-tide basin they serve the same purpose as a lock with a rising tide. Vessels also pass more readily through the short entrances than through locks; and as entrances are only used towards high water, their sills need not be placed so low as the outer sills of locks to accommodate vessels of large draught. On the other hand, they are accessible for a more limited period at each tide than locks; and they do not allow of the exclusion of silt-bearing tidal water, and therefore necessitate a greater amount of dredging in the docks, and especially in half-tide basins, for maintenance. Entrances, however, at large ports are frequently supplemented by the addition of a lock at some convenient site, rendering the ports accessible for the smaller class of vessels for some time before and after high water, as for instance at Liverpool, Barry, Havre and St Nazaire. A small basin with an entrance at each end—an arrangement often adopted—is in reality, for all practical purposes, a lock with a very

large lock-chamber. An entrance or passage with gates has also to be provided at the inner end of a large half-tide basin like the basins adopted at Liverpool, to shut off the half-tide basin from the docks to which it gives access, and maintain their water-level when the water is drawn down in the basin to admit vessels before high tide.

Reverse gates pointing outwards are sometimes added in passages to docks and at entrances, to render the water-level in one set of docks independent of adjacent docks, to exclude silty tidal water and very high tides, and also to protect the gates of outer entrances in exposed situations from swell, which might force them open slightly and lead to a damaging shock on their closing again.

Locks differ from entrances in having a pair of gates with arrangements similar to an entrance at each end, separated from one another by a lock-chamber, which should be large enough to receive the longest and broadest vessel coming regularly to the port. These dock locks are similar in principle to locks on canals and canalized rivers, but are on a much larger scale. The lock-chamber has its water raised or lowered in proportion to the difference in level between the water-level in the dock and the water in the entrance channel, by passing water, when the gates are closed at both ends, from the dock into the lock-chamber or from the lock-chamber into the entrance channel, through large sluiceways in the side walls, controlled, as at entrances, by vertical sluice-gates. In this way the vessel is raised or lowered in the chamber, till, when a level has been reached, the intervening pair of gates is opened and the vessel is passed into the dock or out to the channel. Generally the upper and lower sills of a lock are at the same level, a foot or two higher than dock-bottom; and the depth at which they are laid is governed by the same considerations as the sill of an entrance. Vessels longer than the available length between the two pairs of gates can be admitted close to high water, when the water in the dock and outside is at the same level, and both pairs of gates can be opened. When the range of tide at a port is large, and the depth in the approach channel is sufficient to allow vessels to come up or go out some time before and after high water, and also where the water in the dock is kept up to a high level from an inland source to exclude very silty tidal water, it is expedient to reduce the cost of construction by limiting the depth of the excavations for the dock, and consequently also the height of the dock walls, to what is necessary to provide a sufficient depth of water below high water of the lowest neap tides, or below the water-level to which the water in the dock is always maintained, for the vessels of largest draught frequenting the port, or those which may be reasonably expected in the near future. The upper sill of the lock is then determined by the level of dock-bottom; but the lower sill is taken down approximately to the depth of the bottom of the approach channel, or to the depth to which it can be carried by dredging, so as to enable the lock to admit or let out at any time all vessels which can navigate the approach channel. Thus, for instance, the outer and intermediate sills of the lock at the Barry docks are 9 ft. lower than the upper sill.

The foundations for the sill and side walls at each end of a lock, and also for the side walls and invert commonly enclosing the lock-chamber at the sides and bottom, are generally constructed simultaneously with the dock works, under shelter of a cofferdam across the entrance channel, and in the excavations kept dry by means of pumps. The foundations under the sills and adjacent side walls are carried down to a lower level than the rest, and if possible to a water-tight stratum, to prevent infiltration of water under them owing to the water-pressure on the upper side of the gates; or sometimes one or two rows of sheet piling have been driven across the lock under the sills to an impermeable stratum, to stop any flow. The foundations for the sills consist usually of concrete deposited in a trench extended out under the adjoining side walls. The sill, projecting generally about 2 ft. above the adjacent gate floor over which the gates turn, is built of granite; and the same material is also used for the hollow quoins in which the heelpost, or pivot, of the dock gates turns, and which, together with the sills, are exposed to considerable wear. The side walls of the lock-chamber are very similar in construction to the dock walls; but they are strengthened against the loss of water-pressure in front of them when the water is lowered in the chamber by an inverted arch of masonry, brickwork or concrete, termed an "invert," laid across the bottom of the chamber along its whole length, against which the toe of each side wall abuts and effectually prevents any forward movement. The side walls also, alongside the gates at each end, are abut against a thick level gate floor and apron, and, moreover, are considerably widened to provide space for the sluiceways and gate machines.

The new Florida lock (fig. 20), forming the main entrance through the new approach harbour and tidal harbour to the Eure dock and other docks of the port of Havre, is the largest lock hitherto constructed. It has an available length of chamber between the gates of 805 ft., a width of 98½ ft., and depths over the sills of 15½ ft. at the lowest low water of spring tides, 23½ ft. at low water of neap tides, 35 ft. at high water of neap tides, and 40½ ft. at high water of spring tides. Owing to the alluvial stratum at the site of the lock close to the Seine estuary, of which it is doubtless at one time formed part, the foundations for the sill and side walls or heads at each end of the lock were executed by aid of compressed air. The foundations for these heads were carried down to an impermeable stratum by means of two bottomless caissons, filled eventually with concrete, 213½ ft.

Locks at docks.

long across the lock and 105 ft. wide in the line of the lock at the upper end, and 206½ ft. long and 116½ ft. wide at the lower end, to a depth of 18 ft. below the sill at the upper end, and 41 ft. at the lower end, owing to the dip down seawards and southward of the water-tight stratum. These caissons were provided for their sinkage with temporary dams of masonry closing the opening of the lock at the extremities of each caisson, enabling the gates to be subsequently erected under their shelter. The junctions between the foundations

the side walls, 67½ ft. apart, and provide for the filling and emptying of the chamber.

The gates closing the entrances and locks at docks are made of wood or of iron. In iron gates, the heelpost, or a vertical closing strip attached to the outer side of the gate close to the heelpost, the meeting-post at the end of each gate closing against each other when the gates are shut, and the sill piece fitting against the sill are generally made of wood. Wooden gates consist of

Dock gates.

Longitudinal Section, Lower End.

Cross Section on AB.

Longitudinal Section, Upper End.

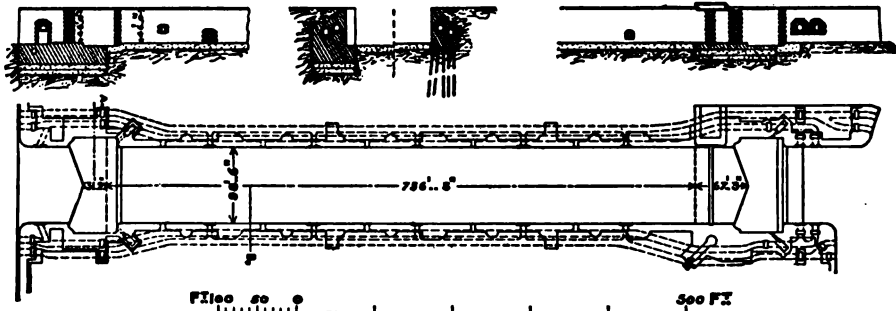

FIG. 20.—Florida Lock, Havre Docks, Sections and Plan.

of the heads and the adjacent foundations were effected by small movable caissons carried down in recesses provided in the buried caissons. The connexions with the adjacent quay walls were accomplished by two supplementary side caissons at the end of each head; and the north side wall of the lock was founded by means of seven bottomless caissons sunk by aid of compressed air, on account of the proximity of the tidal harbour on that side. The south side wall was founded for a length of about 200 ft. at its western end in an excavated trench kept dry by pumping; but the greater portion

a series of horizontal framed beams, made thicker and put closer together towards the bottom to resist the water-pressure increasing with the depth, fastened to the heelpost and meeting-post at the two ends and to intermediate uprights, and supporting water-tight planking on the inner face (fig. 21). Iron gates have generally an outer as well as an inner skin of iron plates braced vertically and horizontally by plate-iron ribs, the horizontal ribs being placed nearer together and the plates made thicker towards the bottom (figs. 22 and 23). Greenheart is the wood used for gates exposed to salt water, as it resists the attack of the teredo in temperate climates.

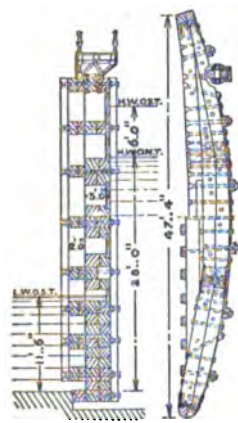

FIG. 21.—Wooden Dock Gate.

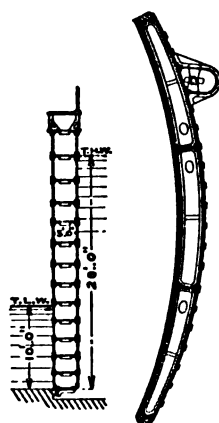

FIG. 22.—Iron Segmental Dock Gate.

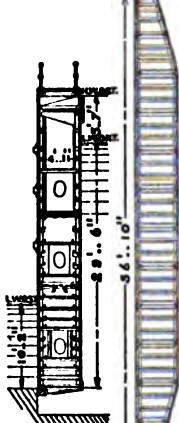

FIG. 23.—Straight Iron Dock Gate.

was founded in a dredged trench in which bearing piles were driven under water, on which the masonry was built in successive layers, about 3½ ft. thick, in a movable caisson 93½ ft. long and 37½ ft. wide; whilst a bottomless caisson, left in the work, was employed for founding about 100 ft. of wall at the eastern end. The bed of concrete also, 10 ft. thick, forming the floor of the chamber, was carried out for 82 ft. at the western end in the open air, and the remainder in the same movable caisson as used for the south wall. Two sluiceways on each side running the whole length of the lock, differing 6½ ft. in level, communicate with the lock-chamber through openings in

heel-posts, of about one-fourth the width. With straight gates, the stresses consist, first of a transverse stress due to the water-pressure against the gate, which increases with the head of water and length of the gate; and secondly, of a compressive stress along the gate, resulting from the pressure of the other gate against its meeting-post, which is equal to half the water-pressure on the gate multiplied by the tangent of half the angle between the closed gates, varying inversely with the rise. Though an increase in the rise reduces this stress, it increases the length of the gate and the transverse stress, and also the length of the lock. By curving the gates

As cellular iron gates are made water-tight, and have to be ballasted with enough water to prevent their flotation, or are provided with air chambers below and are left open to the rising tide on the outer side above, the gates are light in the water and are easily moved; whereas greenheart gates with their fastenings are considerably heavier than water, so that a considerable weight has to be moved when the water is somewhat low in the dock and the gates therefore only partially immersed. On the other hand, wooden gates are less liable than iron gates to be seriously damaged if run into by a vessel.

Dock gates are sometimes made straight, closing against a straight sill (figs. 20 and 23); and occasionally they are made segmental with the inner faces forming a continuous circular arc and closing against a sill corresponding to the outer curves of the gates (fig. 22), or by means of a projecting sill piece against a straight sill (fig. 21). More frequently the gates, curved on both faces, meet at an angle forming a Gothic arch in plan, and close by aid of a projecting piece against a straight sill, which in the Barry entrance gates is modified by making the outer faces nearly straight (fig. 19), giving an unusual width to the centre of the gates. The pressures produced by a head of water against these gates when closed depends not only on the form of the gates, but also upon the projection given to the angle of the sill in proportion to the width of the lock, which is known as the rise, and is generally placed at a distance along the centre line of the lock, from a line joining the centres of the

suitably, the transverse stress is reduced and the longitudinal compressive stress is augmented, till at last, when the gates form a horizontal segmental arch, the stresses become wholly compressive and uniform in each horizontal section, increasing with the depth;

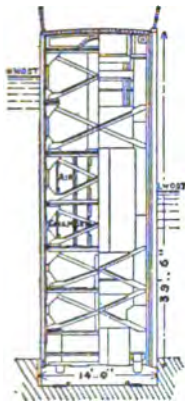

FIG. 24.—Sliding Caisson.

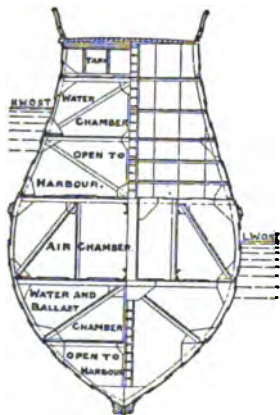

FIG. 25.—Ship Caisson.

and the total stress is equal to the pressure on a unit of surface multiplied by the radius of curvature. Though the water-pressure is most uniformly and economically borne by cylindrical gates, they are longer, and encroach more upon the lines of quay with their curved recesses than straighter gates; and, consequently, Gothic-arched gates are often preferred. Straight gates afford the greatest simplicity in construction.

Gates in wide entrances or locks are generally supported towards their outer end by a roller running along a cast-iron roller-path on the gate floor (figs. 19, 21 and 22), as well as by the heelpost, fitted over a steel pivot at the bottom, and tied back against the hollow quoins at the top by anchor straps and bolts, on which the gate turns. In some cases, by placing the water ballast in iron gates close to the heelpost, a roller has been dispensed with, even, for instance, at the wide entrance at Havre (fig. 23). The gates are opened and closed, either by an opening and a closing chain for each gate, fastened on either side and worked from opposite side walls by hydraulic power, or by a single hydraulic piston or bar hinged to the inner side of each gate (figs. 19 and 20). The latter system has the advantages of being simpler and occupying less space in the side walls, of avoiding the slight loss of available depth over the sill due to the two closing chains crossing on the sill when the gates are open, and especially of keeping the gates closed against a swell in exposed sites.

A sliding or rolling caisson is occasionally placed across each end of a lock in place of a pair of dock gates, being drawn back into a recess at the side for opening the lock. As a caisson chamber has to be covered over to provide a continuous quay or roadway on the top, a lowering platform is supplied to enable the caisson to pass under the small girders spanning the top of the chamber, or the caisson is sunk down sufficiently (fig. 24). The caisson is furnished with an air chamber to give it flotation, which is adjusted by ballast according to the depth of water. The advantages of a caisson, as compared with a pair of gates, are that the gate recesses, gate floor, hollow quoins and arrangements for working in the side walls are dispensed with, so that the lock can be made shorter, and the work at each head is rendered less complicated. The caisson itself also serves as a very strong movable bridge, and therefore is often preferred at dockyards to dock gates. By improvements in the hauling machinery, a caisson can open or close a lock as quickly as dock gates; the caissons at

Zeebrugge lock, at the entrance to the Bruges ship canal, are drawn across the lock or into their chamber by electricity in two minutes. A caisson is specially useful in cases where there may be a head of water on either side, as then it takes the place of two pairs of gates pointing in opposite directions, or for closing an entrance against a current. A caisson, however, requires a much larger amount of material than a pair of dock gates, and a considerable width on one side for its chamber, so that under ordinary conditions gates are generally used at docks.

A ship caisson, so called from its presenting some resemblance in section to the hull of a vessel, occupies too much time in being towed, floated into position, and sunk into grooves at the bottom and sides of an entrance for closing it, and then refloated and towed away for opening the entrance again, to be used at entrances and locks to docks (fig. 25). Being, however, simple in construction, taking up little space, and requiring no chamber or machinery for moving it, this form of caisson is generally used for closing the entrance to a graving dock, where it remains for several days in place during the execution of repairs to a vessel in the dock. A ship caisson only requires the admission of sufficient water to sink it when in position across the entrance to a graving dock; and this water has to be pumped out before it can be floated, and removed to some vacant position in the neighbouring dock till it is again required. Like a sliding or rolling caisson, it provides a bridge for crossing over the entrance of the graving dock when in position.

Graving Docks.—Provision has to be made at ports for the repairs of vessels frequenting them. The simplest arrangement is a timber gridiron, on which a vessel settles with a falling tide, and can then be inspected and slightly cleaned and repaired till the tide floats it again. Inclined slipways are sometimes provided, up which a vessel resting in a cradle on wheels can be drawn out of the water; and they are also used for shipbuilding, the vessel when ready for launching being allowed to slide down them into the water. Graving or dry docks, however, opening out of a dock, are the usual means provided for enabling the cleaning and repairs of vessels to be carried out.

A graving dock consists of an enclosure, surrounded by side walls stepped on the face, and paved at the bottom with a thick floor

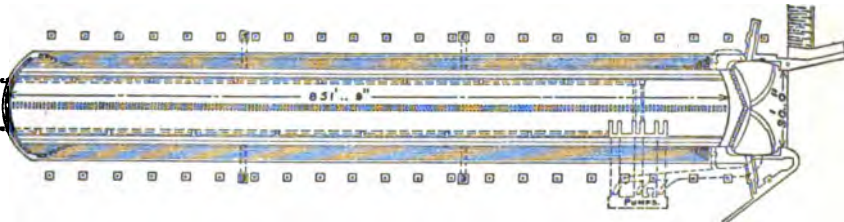

FIG. 26.—Plan of Southampton Graving Dock.

sloping slightly down from the centre to drains along the sides, long enough to receive the longest vessel likely to come to the port. Its entrance, at the end adjoining the dock, is just wide enough to admit the vessel of greatest beam, and deep enough over the sill to receive the vessel of greatest draught, when light, at the lowest water-level of the dock (figs. 26 and 27). Graving docks are constructed of

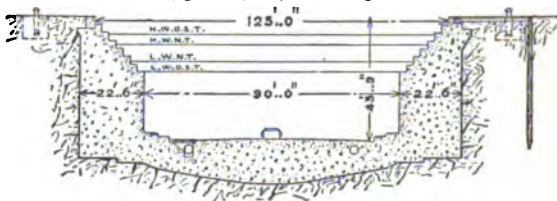

FIG. 27.—Cross Section of Southampton Graving Dock.

masonry, brickwork or concrete, or formerly in America of timber they should be founded on a solid impervious stratum, or, where that is impracticable, they should be built upon bearing piles and enclosed within sheet piling, to prevent settlement and the infiltration of water under pressure below the dock. Keel blocks are laid along the centre line of the dock, for the keel of the vessel to rest on when the water is pumped out; and the vessel is further supported on each side by timber shores supported on the steps or "altars" of the side walls, which are lined with granite or other hard stone, or

blue bricks, or, when constructed of concrete, with a facing of stronger concrete, to enable these altars to withstand the wear and shocks to which they are subjected. Steps and slides are provided at convenient places at the sides to give access for men and materials to the bottom of the dock; and culverts and drains lead the water to pumps for removing the water from the dock when the entrance has been closed, and to keep it dry whilst a vessel is under repair. Culverts in the side walls of the entrance enable water to be admitted for filling the dock to let the vessel out. Graving docks are generally closed by ship caissons; but where they open direct on to a tidal river, and there is some exposure, gates are adopted, or sometimes sliding caissons.

The dimensions of graving docks vary considerably with the nature of the trade and the date of construction; and sometimes an intermediate entrance is provided to accommodate two smaller vessels. The sizes of some of the largest graving docks are as follows: Liverpool, Canada dock, 925½ ft. long, 94 ft. width of entrance, and 29 ft. depth at the ordinary water-level in the dock; Southampton, 85½ ft. by 90 ft., and 29½ ft. depth at high-water neaps (figs. 26 and 27); Tilbury, 875 ft. by 70 ft. by 31½ ft.; and Glasgow, 880 ft. by 80 ft. by 26½ ft.

Floating Dry Docks.—Where there is no site available for a graving dock, or the ground is very treacherous, floating dry docks, built originally of wood, but more recently of iron or steel, have occasionally been resorted to. The first Bermuda dock towed across the Atlantic in 1869, and the new dock launched in 1902, 545 ft. by 100 ft., are notable examples. Water is admitted into the pontoon at the bottom to sink the dock sufficiently to admit a vessel at its open end; and then the water is pumped out of compartments in the pontoon till the vessel is raised out of water. It is only necessary to find a sheltered site, with a sufficient depth of water, for conducting the operations. (L. F. V.-H.)

DOCKET (perhaps from "dock," to curtail or cut short, with the diminutive suffix *et*, but the origin of the word is obscure; it has come into use since the 15th century), in law, a brief summary or digest of a case, or a memorandum of legal decisions; also the alphabetical list of cases down for trial, or of suits pending. Such cases are said to be "on the docket." In commercial use, a docket is a warrant from the custom-house, stating that the duty on goods entered has been paid, or the label fastened to goods, showing their destination, value, contents, &c., and, generally, any indorsement on the back of a document, briefly setting out its contents.

DOCK WARRANT, in law, a document by which the owner of a marine or river dock certifies that the holder is entitled to goods imported and warehoused in the docks. In the Factors Act 1889 it is included in the phrase "document of title" and is defined as any document or writing, being evidence of the title of any person therein named . . . to the property in any goods or merchandise lying in any warehouse or wharf and signed or certified by the person having the custody of the goods. It passes by indorsement and delivery and transfers the absolute right to the goods described in it. A dock warrant is liable to a stamp duty of threepence, which may be denoted by an adhesive stamp, to be cancelled by the person by whom the instrument is executed or issued.

DOCKYARDS. In the fullest meaning of the word, a "dockyard" (or "navy yard" in America) is a government establishment where warships of every kind are built and repaired, and supplied with the men and stores required to maintain them in a state of efficiency for war. Thus a dockyard in this extended sense would include slips for building ships, workshops for manufacturing their machinery, dry docks for repairing them, stores of arms, ammunition, coal, provisions, &c., with basins in which they may lie while being supplied with such things, and an establishment for providing the *personnel* necessary for manning them. But in practice few, if any, existing dockyards are of so complete a nature; many of them, for instance, do not undertake the building of ships at all, while others are little more than harbours where a ship may replenish her stores of coal, water and provisions and carry out minor repairs. Private firms are relied upon for the construction of many ships down to an advanced stage, the government dockyards completing and equipping them for commission.

Great Britain.—Previous to the reign of Henry VIII., the kings of England had neither naval arsenals nor dockyards, nor any regular establishment of civil or naval officers to provide ships of war, or to man them. There are, however, strong evi-

dences of the existence of dockyards, or of something answering thereto, at very early dates, at Rye, Shoreham and Winchelsea. In November 1243 the sheriff of Sussex was ordered to enlarge the house at Rye in which the king's galleys were kept, so that it might contain seven galleys. In 1238 the keepers of some of the king's galleys were directed to cause those vessels to be beamed, and a house to be built at Winchelsea for their safe custody. In 1254 the bailiffs of Winchelsea and Rye were ordered to repair the buildings in which the king's galleys were kept at Rye. At Portsmouth and at Southampton there seem to have been at all times depôts for both ships and stores, though there was no regular dockyard at Portsmouth till the middle of the 16th century. It would appear, from a curious poem in Hakluyt's *Collection* called "The Policie of Keeping the Sea," that Littlehampton, unfit as it now is, was the port at which Henry VIII. built

"his great *Dromions*
Which passed other great shippes of the commons."

The "dromion," "dromon," or "dromedary" was a large warship, the prototype of which was furnished by the Saracens. Roger de Hoveden, Richard of Devizes and Peter de Longtoft celebrate the struggle which Richard I., in the "Trench the Mer," on his way to Palestine, had with a huge dromon.—"a marvellous ship! a ship than which, except Noah's ship, none greater was ever read of." This vessel had three masts, was very high out of the water, and is said to have had 1500 men on board. It required the united force of the king's galleys, and an obstinate fight, to capture the dromon.

The foundation of a regular British navy, by the establishment of dockyards, and the formation of a board, consisting of certain commissioners for the management of its affairs, was first laid by Henry VIII., and the first dockyard erected during his reign was that of Woolwich. Those of Portsmouth, Deptford, Chatham and Sheerness followed in succession. Plymouth was founded by William III. Pembroke was established in 1814, a small yard having previously existed at Milford.

The most important additions yet made at any one period to the dockyard and harbour works required to meet the necessities of the British fleet were those sanctioned by the Naval Works Acts of 1895 and subsequent years, the total estimated cost, as stated in the act of 1890, being over 2½ millions sterling. The works proposed under these acts were classified under three heads, viz. (a) the enclosure and defence of harbours against torpedo attacks; (b) adapting naval ports to the present needs of the fleet; (c) naval barracks and hospitals. Under the first heading were included the defensive harbours at Portland, Dover and Gibraltar. Under heading (b) were included the deepening of harbours and approaches, the dockyard extensions at Gibraltar, Keyham (Devonport), Simons Bay, and Hong-Kong, with sundry other items. Under heading (c) were included the naval barracks at Chatham, Portsmouth and Keyham; the naval hospitals at Chatham, Haslar and Haulbowline; the colleges at Keyham and Dartmouth; and other items.

Great Britain possesses dockyards at Portsmouth, Devonport, Chatham, Malta and Gibraltar, each in charge of an admiral-superintendent, and at Sheerness and Pembroke in charge of a captain-superintendent, together with establishments at Ascension, Bermuda, Simons Town (Cape of Good Hope), Queenstown (Haulbowline), Hong-Kong, Portland, Sydney and Weihaiwei. The Indian Government has dockyards at Bombay and Calcutta. The medical establishments include Ascension, Bermuda, Cape of Good Hope, Chatham, Dartmouth, Deal, Gibraltar, Haslar, Haulbowline, Hong-Kong, Malta, Osborne, Plymouth, Portland, Portsmouth, Sheerness, Sydney, Yarmouth, Yokohama and Weihaiwei.

The arrangements for the administrative control of the dockyards have varied with those adopted for the regulation of the navy as a whole. (See ADMIRALTY ADMINISTRATION; and NAVY: History.) At the present time, whether at home or abroad, they lie within the province of the controller of the navy (the third lord of the board of admiralty); and the director of dockyards, whose office, replacing that of surveyor of dockyards was created in

December 1885, is responsible to the controller for the building of ships, boats, &c., in dockyards, and for the maintenance and repair of ships and boats, and of all steam machinery in ships, boats, dockyards and factories. The director of naval construction, who is also deputy-controller, is responsible, not only for the design of ships, but for their construction, in the sense that he approves great numbers of working drawings of structural parts prepared at the dockyards. But the director of dockyards is the admiralty official under whose instructions the work goes on, involving the employment and supervision of an army of artisans and labourers. Instructions, therefore, emanate from the admiralty, but the details lie with the dockyard officials, and in practice there is a considerable decentralization of duties.

The chief function of a dockyard is the building and maintaining of ships in efficiency. The constructive work is carried out under the care of the chief constructor of the yard, in accordance with plans sent down from the admiralty. The calculations for displacement, involving the draught of water forward and aft, have already been made, and, in order to ensure accuracy in the carrying out of the design, an admirable system has been devised for weighing everything that is built into the new ships or that goes on board; and it is astonishing how very closely the actual displacement approximates to that which was intended, particularly when the tendency of weights to increase, in perfecting a ship for commission, is considered.

The ship having been built to her launching weight, the duty of putting her into the water devolves upon the chief constructor of the yard, and failures in this matter are so extremely rare that it may almost be said they do not occur. As soon as the ship is water-borne the responsibility falls upon the king's harbour master, who has charge of her afloat and of moving her into the fitting basins. When the ship has been brought alongside the wharf, the responsibility of the chief constructor of the yard is resumed, and the ship is carried forward to completion by the affixing of armour plating (if that has not been done before launching), the mounting of guns, the instalment of engines, boilers, and electrical and hydraulic gear, and the fitting of cabins for officers, mess places for men, and storerooms, and a vast volume of other work unnecessary to be specified. In regard to the complicated details of guns and torpedoes, the captains of the gunnery and torpedo schools have a function of supervision. The captain of the fleet reserve also closely watches the work, because, when the heads of all departments have reported the ship to be ready, she has to be inspected by the commander-in-chief at the port, and then passed into the fleet reserve as ready for sea, and there the captain of the fleet reserve is responsible for her efficiency. Other important officers of a dockyard are the chief engineer; the superintendent civil engineer, who has charge of the work involved in keeping all buildings, docks, basins, caissons, roads, &c., in repair; the naval store officer, who has charge of most of the stores in the dockyard; and the cashier of the yard, whose name sufficiently expresses his duties.

The system of conducting business at the dockyards is analogous to that which prevails at the admiralty. There is personal communication between the officers responsible for the work, and facilities are afforded for coming to rapid decisions upon matters that are in hand, and the operations are conducted with an ease which contributes much to efficiency. In 1844 the custom was introduced of all the principal officers of the dockyard meeting at the superintendent's office at 9.30 A.M. every day, to hear the orders from the admiralty and discuss the work of the day. But this system of "readings" was abolished at the beginning of 1906, the naval establishments inquiry committee considering that the assembling of the officials was unnecessary since the communications after reception are copied and sent to the departments concerned.

The police force necessary in a dockyard is in some cases supplied from the London metropolitan police, and is under the orders of the superintendent of the yard for duties connected with it, and under the commissioner of police for the discipline and disposition of the force. The charges are, of course, paid by the admiralty, and the system answers well.

United States.—The shore stations under control of the Navy Department (see also ADMIRALTY ADMINISTRATION), and collectively known as naval stations, are under different names according to their nature. Of those called *Navy Yards*, and intended for the general purpose of sources of supply and for repairs of ships, there are within the United States eight in number. Two of them are on the Pacific coast, situated on Puget Sound; at Bremerton, Washington; and at Mare Island, near San Francisco. The other six are on the Atlantic coast, and are situated at Portsmouth, N.H.; Boston, Mass.; Brooklyn, N.Y., Philadelphia, Pa.; Washington, D.C.; and Norfolk, Va. There are also naval stations at Port Royal and Charleston, S.C.; Key West and Pensacola, Fla.; New Orleans, La.; Guantanamo, Cuba; Culebra and San Juan, Porto Rico; Honolulu, H.I.; Cavite, P.I.; Tutuila, Samoa; and Island of Guam, in the Ladrones Islands. The floating dock Dewey, having a lifting capacity of 18,500 gross tons with a free-board of 2 ft., was stationed in the Philippine Islands in 1906.

Besides these, there are important naval stations established for special purposes, which in some cases are also available for ports of supply and for repairs. These are: the U.S. Naval Academy, Annapolis, Md., for the instruction of naval cadets; the training stations at Newport, R.I., and Yerba Buena Island, Cal., for the instruction of apprentices; the proving ground at Indian Head, Md., on the Potomac river, where all government-built ordnance is tested; the War College at Newport, R.I., for the instruction of officers; the torpedo station at Newport, for the instruction of officers and men in torpedoes, electricity and submarine diving; the naval observatory at Washington; and the marine post at Sitka, Alaska. Coaling depôts have been established at Honolulu, Pago Pago, Samoan Islands, and at Manila, P.I. Naval hospitals are located at the Portsmouth, Boston, New York, Philadelphia, Washington, Norfolk and Mare Island yards; at Las Animas, Colo.; at Newport, R.I.; Cañacao, P.I.; Sitka, Alaska; and Yokohama, Japan.

The commandant of a navy yard and station, who is usually a rear-admiral, is its commander-in-chief. His official assistants are called heads of departments. The captain of the yard, who is next in succession to command, has general charge of the water front and the ships moored there, and of the police of the navy yard; it is his duty to keep the commandant informed as to the nature and efficiency of all work in progress. The equipment officer has charge of anchors, chains, rigging, sails and the electric generating plant. The other heads of departments are the ordnance officer, the naval constructor, the engineering officer, the general storekeeper, the paymaster of the yard, the surgeon and the civil engineer. The clerks and draughtsmen employed by these officers are appointed under civil service rules, and their employment is continuous so long as funds are available. The foremen are selected by competitive examination, and their number is fixed. In the employment of mechanics and labourers, veterans are given preference, after which follow persons previously employed who have displayed especial efficiency and good conduct. The rates of wages are determined semi-annually by a board of officers, who ascertain the wages paid by private establishments in the vicinity of the navy yard. Eight hours constitute the legal work day. When emergencies necessitate longer hours the workmen are paid at the ordinary rate plus 50%.

The nature and extent of work to be performed upon naval vessels is determined by the secretary of the navy; the commandant then issues the necessary orders. The material required is obtained by a system of requisitions, which provide for the purchase from the lowest bidder after open competition. Heads of departments initiate the purchase of materials which are peculiar to their own work; ordinary commercial articles, however, are usually carried in a special stock called the "Naval Supply Fund," which may be drawn upon by any head of department. All materials are inspected, both as to quantity and quality, by a board of inspectors consisting of three officers.

France.—The French coast is divided into five naval arrondissements, which have their headquarters at the five naval ports of

which Cherbourg, Brest and Toulon are the most important. Lorient and Rochefort being of lesser degree. All are building and fitting-out yards. Corsica, which has naval stations at Ajaccio, Porto Vecchio, Bonifacio and other places, is a dependency of the arsenal at Toulon. On the African coast there are docking facilities in Algeria. Bizerta, the Tunisian port, has been made a naval base by the deepening and fortifying of the canal which is the approach to the inner lake. There are arsenals also at Saigon and Hai-phong, and an establishment at Diego Suarez.

The subsidiary establishments in France are the gun foundry at Ruelle; the steel and iron works at Guéringy, where anchors, chains and armour-plate are made; and the works at Indret, on an island in the lower Loire, where machinery is constructed. There are many private shipbuilding establishments in the country, the most important being the Forges et Chantiers de la Méditerranée at La Seyne, on the lesser roadstead at Toulon where many French and foreign warships of the largest classes have been built. The same company has a building yard at Havre. Other establishments are the Ateliers et Chantiers de la Loire, at Saint Nazaire; the Normand Yard, at Havre; and the Chantiers de la Gironde, near Bordeaux.

Each of the arrondissements above mentioned is divided into sous-arrondissements, having their centres in the great commercial ports, but this arrangement is purely for the embodiment of the men of the Inscription Maritime, and has nothing to do with the dockyards as naval arsenals. In each arrondissement the vice-admiral, who is naval prefect, is the immediate representative of the minister of marine, and has full direction and command of the arsenal, which is his headquarters. He is thus commander-in-chief, as also governor-designate for time of war, but his authority does not extend to ships belonging to organized squadrons or divisions. The naval prefect is assisted by a rear-admiral as chief of the staff (except at Lorient and Rochefort, where the office is filled by a captain), and a certain number of officers, the special functions of the chief of the staff having relation principally to the efficiency and personnel of the fleet, while the "major-general," who is usually a rear-admiral, is concerned chiefly with the matériel. There are also directors of stores, of naval construction, of the medical service and of the submarine defences (which are concerned with torpedoes, mines and torpedo-boats), as well as of naval ordnance and works. The prefect directs the operations of the arsenal, and is responsible for its efficiency and for that of the ships which are there in reserve. In regard to the constitution and maintenance of the naval forces, the administration of the arsenals is divided into three principal departments, the first concerned with naval construction, the second with ordnance, including gun-mountings and small-arms, and the third with the so-called submarine defences, dealing with all torpedo matériel.

Germany.—With the expansion of the German navy considerable additions have been made to the two principal dockyards. These are Wilhelmshaven, the naval headquarters on the North Sea, and Kiel, the headquarters on the Baltic, Danzig being an establishment of lesser importance, and Kiao-chau an undeveloped base in the Shantung peninsula, China. The chief official at each home dockyard is the superintendent (*Oberverwalter*), who is a rear-admiral or senior captain directly responsible to the naval secretary of state. Under the superintendent's orders are the chief of the *Ausrüstung* department, the captain of the fleet reserve, the directors of ordnance, torpedoes, navigation, naval construction, engineering and harbour works, with some other officers. The chiefs of the constructive and engineering departments are responsible for the building of ships and machinery, and for the maintenance of the hulls and machinery of existing vessels; while the works department has charge of all work on the quays, docks, &c., in the dockyard and port. A great advance has been made in increasing the efficiency and capabilities of the imperial dockyards by introducing a system of continuous work in the building of new ships and effecting alterations in others, and German material is exclusively used. The Schichau Works at Elbing and Danzig, the Vulkan Yard at Bredow, near Stettin, the Weser Company at Bremen, and the establishment of Blohm and Voss at Hamburg, are important establishments which have built many vessels for the German navy, as well as for foreign states.

Italy.—The principal Italian state dockyards are Spezia, Naples and Venice, the first named being by far the most important. It covers an area, including the water spaces, of 629 acres, and there are five dry docks, three being 433 ft. long and 105 ft. wide, and two 361 ft. long and 98 ft. 6 in. wide. The dockyard is very completely equipped with machinery of the best British, German and Italian makes, and it has built several of the finest Italian ships. The number of hands employed in the yard averages 4000. There are two building slips, and for smaller vessels there are two in the neighbouring establishment of San Bartolommeo (which is the headquarters for submarine mining), and one at San Vito, where is a Government gun factory. Castellammare di Stabia is subsidiary to Naples. A large dry dock has been built at Taranto. There is a small naval establishment at Maddalena Island on the Strait of Bonifacio. The Italian Government has no gun or torpedo factories, nearly all the ordnance coming from the Armstrong factory at Pozzuoli near Naples, and the torpedoes from the Schwarzkopf factory at Venice, while armour-plates are produced at the important works at Terni. Machinery is supplied by the firms of Ansaldo, Odero, Orlando, Guppy & Hawthorn and Pattison. The

three establishments first named have important shipbuilding yards, and have constructed vessels for the Italian and foreign navies. The Orlando Yard at Leghorn is Government property, but is leased by the firm, and possesses five building slips.

Austria-Hungary.—The naval arsenal is on the well-protected harbour of Pola, in Istria, which is the headquarters of the national navy, and includes establishments of all kinds for the maintenance of the fleet. There are large building and docking facilities, and a number of warships have been built there. There is a construction yard also at Trieste. A new coaling and torpedo station is at Teodo, large magazines and stores are at Vallelunga, and the mining establishment is at Focella. The shipbuilding branch of the navy is under the direction of a chief constructor (*Oberster-Ingenieur*), assisted by seven constructors, of whom two are of the first class. The engineering and ordnance branches are similarly organized.

Spain.—The Spanish dockyards are of considerable antiquity, but of diminishing importance. There is an establishment at Ferrol, another at Cartagena, and a third at Cadiz. They are well equipped in all necessary respects, but are not provided with continuous work. A recent arrangement is the specialization of the yards, Ferrol being designed for larger, and Cartagena for smaller, building work. The ordnance establishment is at Carraca.

Russia.—In Russia the naval ports are of two classes. The most important are Kronstadt, St Petersburg and Nikolayev. Of lesser importance are Reval, Sveaborg, Sevastopol, Batum, Baku and Vladivostok. The administration of the larger ports, except St Petersburg, which is under special regulations, is in the hands of vice-admirals, who are commanders-in-chief, while the smaller ports are under the direction of rear-admirals. All are directly under the minister of marine, except that the Black Sea ports and Astrabad, on the Caspian, are subordinate to the commander-in-chief at Nikolayev. Sevastopol has grown in importance, and became mainly a naval harbour, the commercial harbour being removed to Theodosia. The Russian government has also proposed to remodel the harbour works at St Petersburg and Kronstadt. The Emperor Alexander III. Port at Libau, on the Baltic, is in a region less liable to be icebound in the winter. There are no strictly private yards for the building of large vessels in Russia, except that of the Black Sea Company at Nikolayev. Messrs Creighton build torpedo-boats at Åbo in Finland, and the admiralty has steel works at Ijora, where some torpedo-boats have been built. Other ordnance and steel works are at Obukhov and Putilov.

Japan.—The principal Japanese dockyard, which was established by the Shogunate in 1866, is Yokosuka. French naval constructors and engineers were employed, and several wooden ships were built. The Japanese took the administration into their own hands in 1875, and built a number of vessels of small displacement in the yard. The limit of size was about 5000 tons, but the establishment has been enlarged so that vessels of the first class may be built there. There is a first-class modern dry dock which will take the largest battleship. Shipbuilding would be undertaken to a larger extent but for the fact that nearly all material has to come from abroad. Down to 1905 all the important vessels of the Japanese navy were built in Great Britain, France, Germany and the United States, but at the end of that year a first-class cruiser of 13,500 tons (the "Tsukuba") was launched from the important yard at Kure. There are other yards at Sasebo and Mairuru.

DOCTOR (Lat. for "teacher"), the title conferred by the highest university degree. Originally there were only two degrees, those of bachelor and master, and the title doctor was given to certain masters as a merely honorary appellation. The process by which it became established as a degree superior to that of master cannot be clearly traced. At Bologna it seems to have been conferred in the faculty of law as early as the 12th century. Paris conferred the degree in the faculty of divinity, according to Antony Wood, some time after 1150. In England it was introduced in the 13th century; and both in England and on the continent it was long confined to the faculties of law and divinity. Though the word is so commonly used as synonymous with "physician," it was not until the 14th century that the doctor's degree began to be conferred in medicine. The tendency since has been to extend it to all faculties; thus in Germany, in the faculty of arts, it has replaced the old title of *magister*. The doctorate of music was first conferred at Oxford and Cambridge.

Doctors of the Church are certain saints whose doctrinal writings have obtained, by the universal consent of the Church or by papal decree, a special authority. In the case of the great schoolmen a characteristic qualification was added to the title doctor, e.g. "angelicus" (Aquinas), "mellificus" (Bernard). The doctors of the Church are: for the East, SS. Athanasius, Gregory of Nazianzus, Basil the Great, John Chrysostom; for the West, SS. Hilary, Ambrose, Jerome, Augustine, Gregory the

Great. Anselm, Bernard, Bonaventura and Thomas Aquinas. To these St Alphonso dei Liguori was added by Pope Pius IX.

DOCTORS' COMMONS, the name formerly applied to a society of ecclesiastical lawyers in London, forming a distinct profession for the practice of the civil and canon laws. Some members of the profession purchased in 1567 a site near St Paul's, on which at their own expense they erected houses (destroyed in the great fire, but rebuilt in 1672) for the residence of the judges and advocates, and proper buildings for holding the ecclesiastical and admiralty courts. In 1768 a royal charter was obtained by virtue of which the then members of the society and their successors were incorporated under the name and title of "The College of Doctors of Law exercent in the Ecclesiastical and Admiralty Courts." The college consisted of a president (the dean of Arches for the time being) and of those doctors of law who, having regularly taken that degree in either of the universities of Oxford or Cambridge, and having been admitted advocates in pursuance of the rescript of the archbishop of Canterbury, were elected fellows in the manner prescribed by the charter. There were also attached to the college thirty-four proctors, whose duties were analogous to those of solicitors. The judges of the archiepiscopal courts were always selected from this college. By the Court of Probate Act 1857 the college was empowered to sell its real and personal estate and to surrender its charter, and it was enacted that on such surrender the college should be dissolved and the property thereof belong to the then existing members as tenants in common for their own use and benefit. The college was accordingly dissolved, and the various ecclesiastical courts which sat at Doctors' Commons (the Court of Arches, the Prerogative Court, the Faculty Court and the Court of Delegates) are now open to the whole bar.

DOCTRINAIRES, the name given to the leaders of the moderate and constitutional Royalists in France after the second restoration of Louis XVIII. in 1815. The name, as has often been the case with party designations, was at first given in derision, and by an enemy. In 1816 the *Nain jaune réfugié*, a French paper published at Brussels by Bonapartists and Liberal exiles, began to speak of M. Royer-Collard as the "doctrinaire" and also as *le père Royer-Collard de la doctrine chrétienne*. The *pères de la doctrine chrétienne*, popularly known as the "doctrinaires," were a French religious order founded in 1592 by César de Bus. The choice of a nickname for M. Royer-Collard does credit to the journalistic insight of the contributors to the *Nain jaune réfugié*, for he was emphatically a man who made it his business to preach a doctrine and an orthodoxy. The popularity of the name and its rapid extension to M. Royer-Collard's colleagues is the sufficient proof that it was well chosen and had more than a personal application. These colleagues came, it is true, from various quarters. The duc de Richelieu and M. de Serre had been Royalist émigrés during the revolutionary and imperial epoch. MM. Royer-Collard himself, Lainé, and Maine de Biran had sat in the revolutionary Assemblies. MM. Pasquier, Beugnot, de Barante, Cuvier, Mounier, Guizot and Decazes had been imperial officials. But they were closely united by political principle, and also by a certain similarity of method. Some of them, notably Guizot and Maine de Biran, were theorists and commentators on the principles of government. M. de Barante was an eminent man of letters. All were noted for the doctrinal coherence of their principles and the dialectical rigidity of their arguments. The object of the party as defined by M. (afterwards the duc) Decazes was to "nationalize the monarchy and to royalize France." The means by which they hoped to attain this end were a loyal application of the charter granted by Louis XVIII., and the steady co-operation of the king with the moderate Royalists to defeat the extreme party known as the Ultras, who aimed at the complete undoing of the political and social work of the Revolution. The Doctrinaires were ready to allow the king a large discretion in the choice of his ministers and the direction of national policy. They refused to allow that ministers should be removed in obedience to a hostile vote in the chamber. Their ideal in fact was a combination of a king who frankly accepted the results

of the Revolution, and who governed in a liberal spirit, with the advice of a chamber elected by a very limited constituency, in which men of property and education formed, if not the whole, at least the very great majority of the voters. Their views were set forth by Guizot in 1816 in his treatise *Du gouvernement représentatif et de l'état actuel de la France*. The chief organs of the party in the press were the *Indépendant*, renamed the *Constitutionnel* in 1817, and the *Journal des débats*. The supporters of the Doctrinaires in the country were chiefly ex-officials of the empire,—who believed in the necessity for monarchical government but had a lively memory of Napoleon's tyranny and a no less lively hatred of the *ancien régime*,—merchants, manufacturers and members of the liberal professions, particularly the lawyers. The history of the Doctrinaires as a separate political party began in 1816 and ended in 1830. In 1816 they obtained the co-operation of Louis XVIII., who had been frightened by the violence of the Ultras in the *Chambre introuvable* of 1815. In 1830 they were destroyed by Charles X. when he took the Ultra prince de Polignac as his minister and entered on the conflict with Liberalism in France which ended in his overthrow. During the revolution of 1830 the Doctrinaires became absorbed in the Orléanists, from whom they had never been separated on any ground of principle (see FRANCE: History).

The word "doctrinaire" has become naturalized in English terminology, as applied, in a slightly contemptuous sense, to a theorist, as distinguished from a practical man of affairs.

See Duvergier de Hauranne, *Histoire du gouvernement parlementaire en France* (Paris, 1857-1871), vol. iii.

DOCUMENT, strictly, in law, that which can serve as evidence or proof, and is written or printed, or has an inscription or any significance that can be "read"; thus a picture, authenticated photograph, seal or the like would furnish "documentary evidence." More generally the word is used for written or printed papers that provide information or evidence on a subject. The Latin *documentum*, from which the word is derived, meant, in classical times, a lesson, example or proof (*docere*, to teach), and only in medieval Latin came to be applied to an *instrumentum*, or record in writing. The classical Latin use is found in English; thus Jeremy Taylor (Works, ed. 1835, i. 815) speaks of punishment being a "single and sudden document if instantly inflicted" (see DIPLOMACY; and EVIDENCE).

DODD, WILLIAM (1720-1777), English divine, was born at Bourne in Lincolnshire in May 1720. He was admitted a sizar of Clare Hall, Cambridge, in 1745, and took the degree of B.A. in 1750, being fifteenth wrangler. On leaving the university he married a young woman of a more than questionable reputation, whose extravagant habits helped to ruin him. In 1751 he was ordained deacon, and in 1753 priest, and he soon became a popular and celebrated preacher. His first preferment was the lectureship of West-Ham and Bow. In 1754 he was also chosen lecturer of St Olave's, Hart Street; and in 1757 he took the degree of M.A. at Cambridge, subsequently becoming LL.D. He was a strenuous supporter of the Magdalen hospital, founded in 1758, and soon afterwards became preacher at the chapel of that charity. In 1763 he obtained a prebend at Brecon, and in the same year he was appointed one of the king's chaplains,—soon after which the education of Philip Stanhope, afterwards earl of Chesterfield, was committed to his care. In 1768 he had a fashionable congregation and was held in high esteem, but indiscreet ambition led to his ruin. On the living of St George's, Hanover Square, becoming vacant in 1774, Mrs Dodd wrote an anonymous letter to the wife of the lord chancellor, offering three thousand guineas if, by her assistance, Dodd were promoted to the benefice. This letter having been traced, a complaint was immediately made to the king, and Dodd was dismissed from his office as chaplain. After residing for some time at Geneva and Paris, he returned to England in 1776. He still continued to exercise his clerical functions, but his extravagant habits soon involved him in difficulties. To meet his creditors he forged a bond on his former pupil Lord Chesterfield for £4200, and actually received the money. He was detected, committed to prison, tried at the Old Bailey, found guilty, and sentenced to

death; and, in spite of numerous applications for mercy, he was executed at Tyburn on the 27th of June 1777. Samuel Johnson was very zealous in pleading for a pardon, and a petition from the city of London received 23,000 signatures. Dr Dodd was a voluminous writer and possessed considerable abilities, with but little judgment and much vanity. He wrote one or two comedies, and his *Beauties of Shakespeare*, published in 1752, was long a well-known work; while his *Thoughts in Prison*, a poem in blank verse, written between his conviction and execution, naturally attracted much attention. He published a large number of sermons and other theological works, including a *Commentary on the Bible* (1765-1770). A list of his fifty-five writings and an account of the writer is included in the *Thoughts in Prison*.

See also P. Fitzgerald, *A Famous Forgery* (1865).

DODDER (Frisian *dodd*, a bunch; Dutch *dot*, ravelled thread), the popular name of the annual, leafless, twining, parasitic plants

forming the genus *Cuscuta*, formerly regarded as representing a distinct natural order Cuscutaceae, but now generally ranked as a tribe of the natural order Convolvulaceae. The genus contains nearly 100 species and is widely distributed in the temperate and warmer parts of the earth. The slender thread-like stem is white, yellow, or red in colour, bears no leaves, and attaches itself by suckers to the stem or leaves of some other plant round which it twines and from which it derives its nourishment. It bears clusters of small flowers with a four- or five-toothed calyx, a cup-shaped corolla with four or five stamens inserted on its tube, and sometimes a ring of scales below the stamens; the two-

colled ovary becomes when ripe a capsule splitting by a ring just above the base. The seeds are angular and contain a thread-like spirally coiled embryo which bears no cotyledons. On coming in contact with the living stem of some other plant the seedling dodder throws out a sucker, by which it attaches itself and begins to absorb the sap of its foster-parent; it then soon ceases to have any connexion with the ground. As it grows, it throws out fresh suckers, establishing itself firmly on the host-plant (fig. 2). After making a few turns round one stem the dodder finds its way to another, and thus it continues twining and branching till it resembles "fine, closely-tangled, wet catgut." The injury done to flax, clover, hop and bean crops by species of dodder is often very great. *C. europaea*, the greater dodder (fig. 1) is found parasitic on nettles, thistles, vetches and the hop; *C. Epilinum*, on flax; *C. Epithymum*, on furze, ling

and thyme. *C. Trifolii*, the Clover Dodder, is perhaps a subspecies of the last mentioned.

DODDRIDGE, PHILIP (1702-1751), English Nonconformist divine, was born in London on the 26th of June 1702. His father, Daniel Doddridge, was a London merchant, and his mother the orphan daughter of the Rev. John Bauman, a Lutheran clergyman who had fled from Prague to escape religious persecution, and had held for some time the mastership of the grammar school at Kingston-upon-Thames. Before he could read, his mother taught him the history of the Old and New Testament by the assistance of some blue Dutch chimney-tiles. He afterwards went to a private school in London, and in 1712 to the grammar school at Kingston-upon-Thames. About 1715 he was removed to a private school at St Albans, where he was much influenced by the Presbyterian minister, Samuel Clarke. He declined offers which would have led him into the Anglican ministry or the bar, and in 1719 entered the very liberal academy for dissenters at Kibworth in Leicestershire, taught at that time by the Rev. John Jennings, whom Doddridge succeeded in the ministry at that place in 1723, declining overtures from Coventry, Pershore and London (Haberdashers' Hall). In 1729, at a general meeting of Nonconformist ministers, he was chosen to conduct the academy established in that year at Market Harborough. In the same year he received an invitation from the independent congregation at Northampton, which he accepted. Here he continued his multifarious labours; but the church seems to have decreased, and his many engagements and bulky correspondence interfered seriously with his pulpit work, and with the discipline of his academy, where he had some 200 students to whom he lectured on philosophy and theology in the mathematical or Spinozistic style. In 1751 his health, which had never been good, broke down, and he sailed for Lisbon on the 30th of September of that year; but the change was unavailing, and he died there on the 26th of October. His popularity as a preacher is said to have been chiefly due to his "high susceptibility, joined with physical advantages and perfect sincerity." His sermons were mostly practical in character, and his great aim was to cultivate in his hearers a spiritual and devotional frame of mind. He laboured for the attainment of a united Nonconformist body, which should retain the cultured element without alienating the uneducated. His principal works are, *The Rise and Progress of Religion in the Soul* (1745), which best illustrates his religious genius, and has been widely translated; *The Family Expositor* (6 vols., 1739-1756), *Life of Colonel Gardiner* (1747); and a *Course of Lectures on Pneumatology, Ethics and Divinity* (1763). He also published several courses of sermons on particular topics, and is the author of many well-known and justly admired hymns, e.g. "O God of Bethel, by whose hand." In 1736 both the universities at Aberdeen gave him the degree of D.D.

See *Memoirs*, by Rev. Job Orton (1766); *Letters to and from Dr Doddridge*, by Rev. Thomas Stedman (1790); and *Correspondence and Diary*, in 5 vols., by his grandson, John Doddridge Humphreys (1829). The best life is Stanford's *Philip Doddridge* (1880). Doddridge's academy is now represented by New College, Hampstead, in the library of which there is a large collection of his manuscripts.

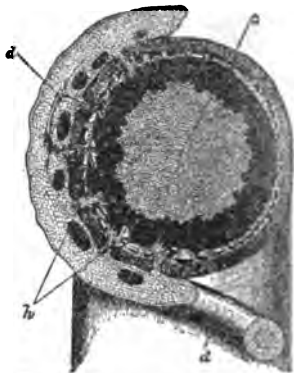

FIG. 2.—*Cuscuta glomerata*. Section through union between parasite and host. *c*, stem of host. *d*, stem of *Cuscuta*. *h*, haustoria. (After Dodel-Port.)



FIG. 1.—*Cuscuta europaea*, Dodder.

1. Flower removed from 2, Calyx.
2. Ovary cut across.
3. Fruit enveloped by a persistent corolla.
4. Seed.
5. Embryo.
6. Embryo. 1-6 enlarged.

colled ovary becomes when ripe a capsule splitting by a ring just above the base. The seeds are angular and contain a thread-like spirally coiled embryo which bears no cotyledons. On coming in contact with the living stem of some other plant the seedling dodder throws out a sucker, by which it attaches itself and begins to absorb the sap of its foster-parent; it then soon ceases to have any connexion with the ground. As it grows, it throws out fresh suckers, establishing itself firmly on the host-plant (fig. 2). After making a few turns round one stem the dodder finds its way to another, and thus it continues twining and branching till it resembles "fine, closely-tangled, wet catgut." The injury done to flax, clover, hop and bean crops by species of dodder is often very great. *C. europaea*, the greater dodder (fig. 1) is found parasitic on nettles, thistles, vetches and the hop; *C. Epilinum*, on flax; *C. Epithymum*, on furze, ling

DODDS, ALFRED AMÉDÉE (1842-), French general, was born at St Louis, Senegal, on the 6th of February 1842; his father's family was of Anglo-French origin. He was educated at Carcassonne and at St Cyr, and in 1864 joined the marine infantry as a sub-lieutenant. He was promoted captain for his services during the disturbances in Réunion in 1868-69, in the course of which he was wounded. He served as a company commander in the Franco-German War, was taken prisoner at Sedan but escaped, and took part in the campaigns of the Loire and of the East. In 1872 he was sent to West Africa, and, except when on active service in Cochinchina (1878) and Tong-King (1883), he remained on duty in Senegal for the next twenty years, taking a prominent part in the operations which brought the countries of the Upper Senegal and Upper Niger under French rule. He led the expeditions against the Boal and Kayor (1880), the Serreres (1890) and the Futa (1891), and from 1888 to 1891 was colonel commanding the troops in Senegal. At the close of 1891 he returned to France to command the eighth marine infantry at Toulon. In April 1892 Dodds was selected to command the expeditionary force in Dahomey; he occupied Abomey, the hostile capital, in November, and in a second campaign (1894) he completed the subjugation of the country. He was then appointed inspector-general of the marine infantry, and after a tour of the French colonies was given the command of the XX. (Colonial) Army Corps, subsequently becoming inspector-general of colonial troops and a member of the *Conseil supérieur de guerre*.

DODECAHEDRON (Gr. δώδεκα, twelve, and ἕρπα, a face or base), in geometry, a solid enclosed by twelve plane faces. The "ordinary dodecahedron" is one of the Platonic solids (see POLYHEDRON). The Greeks discovered that if a line be divided in extreme and mean proportion, then the whole line and the greater segment are the lengths of the edge of a cube and dodecahedron inscriptible in the same sphere. The "small stellated dodecahedron," the "great dodecahedron" and the "great stellated dodecahedron" are Kepler-Poinsot solids; and the "truncated" and "snub dodecahedra" are Archimedean solids (see POLYHEDRON): In crystallography, the regular or ordinary dodecahedron is an impossible form since the faces cut the axes in irrational ratios; the "pentagonal dodecahedron" of crystallographers has irregular pentagons for faces, while the geometrical solid, on the other hand, has regular ones. The "rhombic dodecahedron," one of the geometrical semiregular solids, is an important crystal form. Many other dodecahedra exist as crystal forms, for which see CRYSTALLOGRAPHY.

DODECASTYLE (Gr. δώδεκα, twelve, and στῦλος, column), the architectural term given to a temple where the portico has twelve columns in front, as in the portico added to the temple of Demeter at Eleusis, designed by Philo, the architect of the arsenal at the Peiraus.

DÖDERLEIN, JOHANN CHRISTOPH WILHELM LUDWIG (1791-1863), German philologist, was born at Jena on the 19th of December 1791. His father, Johann Christoph Döderlein, professor of theology at Jena, was celebrated for his varied learning, for his eloquence as a preacher, and for the important influence he exerted in guiding the transition movement from strict orthodoxy to a freer theology. Ludwig Döderlein, after receiving his preliminary education at Windsheim and Schulpforta (Pforta), studied at Munich, Heidelberg, Erlangen and Berlin. He devoted his chief attention to philology under the instruction of such men as F. Thiersch, G. F. Creuzer, J. H. Voss, F. A. Wolf, August Böckh and P. K. Buttmann. In 1815, soon after completing his studies at Berlin, he accepted the appointment of ordinary professor of philology in the academy of Bern. In 1819 he was transferred to Erlangen, where he became second professor of philology in the university and rector of the gymnasium. In 1827 he became first professor of philology and rhetoric and director of the philological seminary. He died on the 9th of November 1863. Döderlein's most elaborate work as a philologist was marred by over-subtlety, and lacked method and clearness. He is best known by his *Lateinische Synonymen und Etymologien* (1826-1838), and his *Homerisches Glossarium*

(1850-1858). To the same class belong his *Lateinische Wortbildung* (1838), *Handbuch der lateinischen Synonymik* (1839), and the *Handbuch der lateinischen Etymologie* (1841), besides various works of a more elementary kind intended for the use of schools and gymnasia. Most of the works named have been translated into English. To critical philology Döderlein contributed valuable editions of Tacitus (*Opera*, 1847; *Germania*, with a German translation) and Horace (*Epistolae*, with a German translation, 1856-1858; *Satirae*, 1860). His *Reden und Aufsätze* (Erlangen, 1843-1847) and *Öffentliche Reden* (1860) consist chiefly of academic addresses dealing with various subjects in pedagogy and philology.

DODGE, THEODORE AYRAULT (1842-1909), American soldier and military writer, was born at Pittsfield, Massachusetts, on the 28th of May 1842. He received a military education in Germany and subsequently studied at Heidelberg and London University, returning to the United States in 1861. At the outbreak of the Civil War he at once enlisted in the federal army, and he soon rose to commissioned rank. He served in the Army of the Potomac until Gettysburg, where he lost a leg. Incapacitated for further active service, he continued to be employed in administrative posts to the end of the war, and for several years thereafter he served at army headquarters, becoming captain in 1866 and brevet lieutenant-colonel in 1867. He retired in 1870. His works include *The Campaign of Chancellorsville* (1881), *A Bird's Eye View of our Civil War* (1882, later edition 1897), a complete, accurate and remarkably concise account of the whole war, *Patroclus and Penelope, a Chat in the Saddle* (1883), *Great Captains* (1886), a series of lectures, *Riders of Many Lands* (1893), and a series of large illustrated volumes entitled *A History of the Art of War*, being lives of "Great Captains," including *Alexander* (2 vols., 1888), *Hannibal* (2 vols., 1889), *Caesar* (2 vols., 1892), *Gustavus Adolphus* (2 vols., 1896) and *Napoleon* (4 vols., 1904-1907). He died in France, at Versailles, on the 26th of October 1909.

DODGSON, CHARLES LUTWIDGE ["LEWIS CARROLL"] (1832-1898), English mathematician and author, son of the Rev. Charles Dodgson, vicar of Daresbury, Cheshire, was born in that village on the 27th of January 1832. The literary life of "Lewis Carroll" became familiar to a wide circle of readers, but the private life of Charles Lutwidge Dodgson was retired and practically uneventful. After four years' schooling at Rugby, Dodgson matriculated at Christ Church, Oxford, in May 1850; and from 1852 till 1870 held a studentship there. He took a first class in the final mathematical school in 1854, and the following year was appointed mathematical lecturer at Christ Church, a post he continued to fill till 1881. In 1861 he was ordained deacon, but he never took priest's orders, possibly because of a stammer which prevented reading aloud. His earliest publications, beginning with *A Syllabus of Plane Algebraical Geometry* (1860) and *The Formulae of Plane Trigonometry* (1861), were exclusively mathematical; but late in the year 1865 he published, under the pseudonym of "Lewis Carroll," *Alice's Adventures in Wonderland*, a work that was the outcome of his keen sympathy with the imagination of children and their sense of fun. Its success was immediate, and the name of "Lewis Carroll" has ever since been a household word. A dramatic version of the "Alice" books by Mr Savile Clarke was produced at Christmas, 1886, and has since enjoyed many revivals. Mr Dodgson was always very fond of children, and it was an open secret that the original of "Alice" was a daughter of Dean Liddell. *Alice* was followed (in the "Lewis Carroll" series) by *Phantasmagoria*, in 1869; *Through the Looking-Glass*, in 1871; *The Hunting of the Snark* (1876); *Rhyme and Reason* (1883); *A Tangled Tale* (1885); and *Sylvie and Bruno* (in two parts, 1889 and 1893). He wrote skits on Oxford subjects from time to time. *The Dynamics of a Particle* was written on the occasion of the contest between Gladstone and Mr Gathorne Hardy (afterwards earl of Cranbrook); and *The New Belfry* in ridicule of the erection put up at Christ Church for the bells that were removed from the Cathedral tower. While "Lewis Carroll" was delighting children of all ages, C. L. Dodgson periodically published mathematical works—*An Elementary Treatise on Determinants* (1867);

Euclid, Book V., proved Algebraically (1874); *Euclid and his Modern Rivals* (1879), the work on which his reputation as a mathematician largely rests; and *Curiosa Mathematica* (1888). Throughout this dual existence Mr Dodgson pertinaciously refused to acquiesce in being publicly identified with "Lewis Carroll." Though the fact of his authorship of the "Alice" books was well known, he invariably stated, when occasion called for such a pronouncement, that "Mr Dodgson neither claimed nor acknowledged any connexion with the books not published under his name." He died at Guildford, on the 14th of January 1898. His memory is appropriately kept green by a cot in the Children's Hospital, Great Ormond Street, London, which was endowed perpetually by a public subscription.

See S. D. Collingwood, *Life and Letters of Lewis Carroll* (1898).

DODO (from the Portuguese *Dúdo*, a simpleton), a large bird formerly inhabiting the island of Mauritius, but now extinct—the *Didus ineptus* of Linnaeus. When, in 1507, the Portuguese discovered the island which we now know as Mauritius they named it *Ilha do Cerne*, from a notion that it must be the island of that name mentioned by Pliny; but most authors have insisted that it was known to the seamen of that nation as *Ilha do Cisne*—perhaps but a corruption of Cerne, and brought about by their finding it stocked with large fowls, which, though not aquatic, they likened to swans, the most familiar to them of bulky birds. In 1598 the Dutch, under Van Neck, took possession of the island and renamed it Mauritius. A narrative of this voyage was published in 1601, if not earlier, and has been often reprinted. Here we have birds spoken of as big as swans or bigger, with large heads, no wings, and a tail consisting of a few curly feathers. The Dutch called them *Walvogels* (the word is variously spelled), i.e. nauseous birds, either because no cooking made them palatable, or because this island-paradise afforded an abundance of fare so much superior. De Bry gives two admirably quaint prints of the doings of the Hollanders, and in one of them the *Walvogel* appears, being the earliest published representation of its unwieldy form, with a footnote stating that the voyagers brought an example alive to Holland. Among the company there was a draughtsman, and from a sketch of his, Clusius, a few years after, gave a figure of the bird, which he vaguely called "*Gallinaceus Gallus peregrinus*," but described rather fully. Meanwhile two other Dutch fleets had visited Mauritius. One of them had rather an accomplished artist on board, and his drawings fortunately still exist (see article **BRAD**). Of the other a journal kept by one of the skippers was subsequently published. This in the main corroborates what has been before said of the birds, but adds the curious fact that they were now called by some *Dodaarsen* and by others *Dronten*.¹

Henceforth Dutch narrators, though several times mentioning the bird, fail to supply any important fact in its history. Their navigators, however, were not idle, and found work for their naturalists and painters. Clusius says that in 1605 he saw at Pauw's House in Leyden a dodo's foot,² which he minutely describes. In a copy of Clusius's work in the high school of Utrecht is pasted an original drawing by Van de Venne superscribed "*Vera effigies huius avis Walvogel* (quae & a nautis *Dodaars* propter foedam posterioris partis crassitatem nuncupatur), qualis vix Amsterdamum perlata est ex insula Mauriti. Anno M.DC.XXXVI." Now a good many paintings of the dodo drawn from life by Roelandt Savery (1576-1639) exist; and the paintings by him at Berlin and Vienna—dated 1626 and 1628—as

¹ The etymology of these names has been much discussed. That of the latter, which has generally been adopted by German and French authorities, seems to defy investigation, but the former has been shown by Prof. Schlegel (*Versl. en Mededeel. K. Akad. Wetensch.* ii. pp. 255 et seq.) to be the homely name of the dabchick or little grebe (*Podiceps minor*), of which the Dutchmen were reminded by the round stern and tail diminished to a tuft that characterized the dodo. The same learned authority suggests that dodo is a corruption of *Dodaars*, but, as will presently be seen, we herein think him mistaken.

² What has become of the specimen (which may have been a relic of the bird brought home by Van Neck's squadron) is not known. Broderip and Dr Gray have suggested its identity with that now in the British Museum, but on what grounds is not apparent.

well as the picture by Goltzemaere, belonging to the duke of Northumberland, dated 1627, may be with greater plausibility than ever considered portraits of a captive bird. It is even probable that this was not the first example painted in Europe. In the private library of the emperor Francis I. of Austria was a series of pictures of various animals, supposed to be by the Dutch artist Hoefnagel, who was born about 1545. One of these represents a dodo, and, if there be no mistake in Von Frauenfeld's ascription, it must almost certainly have been painted before 1626, while there is reason to think that the original may have been kept in the *mnisarium* of the emperor Rudolf II., and that the portion of a dodo's head, which was found in the museum at Prague about 1850, belonged to this example. The other pictures by Roelandt Savery, like those in the possession of the Zoological Society of London and others, are undated, but were probably all painted about the same time—1626-1628. The large picture in the British Museum, once belonging to Sir Hans Sloane, by an unknown artist, but supposed to be by Roelandt Savery, is also undated; while the still larger one at Oxford (considered to be by the younger Savery) bears a much later date, 1651. Undated also is a picture in Holland said to be by Pieter Holsteyn.

In 1628 we have the evidence of the first English observer of the bird—one Emanuel Altham, who mentions it in two letters written on the same day from Mauritius to his brother at home (*Proc. Zool. Soc.* 1874, pp. 447-449). In one he says: "You shall see . . . a strange fowle: which I had at the Iland Mauritius called by ye portingalls a Do Do: which for the rareness thereof I hope wilbe welcome to you." The passage in the other letter is to the same effect, with the addition of the words "if it lue." In the same fleet with Altham sailed Sir Thomas Herbert, whose *Travels* ran through several editions. It is plain that he could not have reached Mauritius till 1629, though 1627 has been usually assigned as the date of his visit. The fullest account he gives of the bird is in his edition of 1638: "The Dodo comes first to a description: here, and in *Dygarrois*³ (and no where else, that ever I could see or heare of) is generated the Dodo (a Portuguese name it is, and has reference to her simpleness, a Bird which for shape and rareness might be call'd a Phoenix (wer't in Arabia:)" &c. Herbert was weak as an etymologist, but his positive statement, corroborated as it is by Altham, cannot be set aside, and hence we do not hesitate to assign a Portuguese derivation for the word.⁴ Herbert also gave a figure of the bird.

Proceeding chronologically we next come upon a curious bit of evidence. This is contained in a MS. diary kept between 1626 and 1640, by Thomas Crossfield of Queen's College, Oxford, where, under the year 1634, mention is casually made of one Mr Gosling "who bestowed the Dodar (a blacke Indian bird) vpon ye Anatomy school." Nothing more is known of it. About 1638, Sir Hamon Lestrange tells us, as he walked London streets he saw the picture of a strange fowl hung out on a cloth canvas, and going in to see it found a great bird kept in a chamber "somewhat bigger than the largest Turkey cock, and so legged and footed, but shorter and thicker." The keeper called it a dodo and showed the visitors how his captive would swallow "large pebble stones . . . as bigge as nutmegs."

In 1651 Morisot published an account of a voyage made by François Cauche, who professed to have passed fifteen days in Mauritius, or "l'isle de Sainte Apollonie," as he called it, in 1638. According to De Flacourt the narrative is not very trustworthy, and indeed certain statements are obviously inaccurate. Cauche says he saw there birds bigger than swans, which he describes so as to leave no doubt of his meaning dodos; but perhaps the most important facts (if they be facts) that he

³ i.e. Rodriguez: an error.

⁴ Hence we venture to dispute Prof. Schlegel's supposed origin of "Dodo." The Portuguese must have been the prior nomenclators, and if, as is most likely, some of their nation, or men acquainted with their language, were employed to pilot the Hollanders, we see at once how the first Dutch name *Walvogel* would give way. The meaning of *Dodo* not being plain to the Dutch, they would, as is the habit of sailors, convert it into something they did understand. Then *Dodaars* would easily suggest itself.

relates are that they had a cry like a gosling ("il a un cry comme l'oison"), and that they laid a single white egg ("gros comme un pain d'un sol") on a mass of grass in the forests. He calls them "oiseaux de Nazaret," perhaps, as a marginal note informs us, from an island of that name which was then supposed to lie more to the northward, but is now known to have no existence.

In the catalogue of Tridescant's *Collection of Rarities, preserved at South Lambeth*, published in 1656, we have entered among the



FIG. 1.—Skeleton of a Dodo, *Didus ineptus*, Museum of Zoology, Cambridge, and cast of a Head in Oxford.

"Whole Birds," a "Dodar from the island *Mauritius*; it is not able to fly being so big." This specimen may well have been the skin of the bird seen by Lestrange some eighteen years before, but anyhow we are able to trace the specimen through Willughby, Edward Lwyd and Thomas Hyde, till it passed in or before 1684 to the Ashmolean collection at Oxford. In 1755 it was ordered to be destroyed, but, in accordance with the original orders of Ashmole, its head and right foot were preserved, and still ornament the museum of that university. In the second edition of a *Catalogue of many Natural Rarities, &c.*, "to be seen at the place formerly called the Music House, near the West End of St Paul's Church," collected by one Hubert *alias* Forbes, and published in 1665, mention is made of a "legge of a Dodo, a great heavy bird that cannot fly; it is a Bird of the Mauritius Island." This is supposed to have subsequently passed into the possession of the Royal Society. At all events such a specimen is included in Grew's list of their treasures which was published in 1681. This was afterwards transferred to the British Museum. It is a left foot, without the integuments, but it differs sufficiently in size from the Oxford specimen to forbid its having been part of the same individual. In 1666 Olearius brought out the *Gottorfsche Kunsts Kammer*, wherein he describes the head of a *Walghvogel*, which some sixty years later was removed to the museum at Copenhagen, and is now preserved there, having been the means of first leading zoologists, under the guidance of Prof. J. Th. Reinhardt, to recognize the true affinities of the bird.

We have passed over all but the principal narratives of voyagers or other notices of the bird. A compendious bibliography, up to the year 1848, will be found in Strickland's classical work,¹ and the list was continued by Von Frauenfeld² for twenty years later.

¹ *The Dodo and its Kindred*, by H. E. Strickland and A. G. Melville (London, 1848, 4to).

² *Neu aufgefundenen Abbildung des D. nte*, by Georg Ritter von Frauenfeld (Wien, 1868, fol.).

The last evidence we have of the dodo's existence is furnished by a journal kept by Benj. Harry, and now in the British Museum (*MSS. Addit.* 3668. 11. D). This shows its survival till 1681, but the writer's sole remark upon it is that its "flesh is very hard." The successive occupation of the island by different masters seems to have destroyed every tradition relating to the bird, and doubts began to arise whether such a creature had ever existed. Dr Henry Duncan, Scottish minister and journalist, in 1828, showed how ill-founded these doubts were, and some ten years later William John Broderip with much diligence collected all the available evidence into an admirable essay, which in its turn was succeeded by Strickland's monograph just mentioned. But in the meanwhile little was done towards obtaining any material advance in our knowledge, Prof. Reinhardt's determination of its affinity to the pigeons (*Columbae*) excepted; and it was hardly until George Clark's discovery in 1865 of a large number of dodos' remains in the mud of a pool (the Mare aux Songes) that zoologists generally were prepared to accept that affinity without question. The examination of bone after bone by Sir R. Owen (*Trans. Zool. Soc. vi. p. 49*) confirmed the judgment of the Danish naturalist.

In 1889 Th. Sauzier, acting for the government of Mauritius, sent a great number of bones from the same swamp to Sir Edward Newton.³ From these the first correctly restored and properly mounted skeleton was prepared and sent to Paris, to be forwarded to the museum of Mauritius. Good specimens are in the British Museum, at Paris and at Cambridge, England.

The huge blackish bill of the dodo terminated in a large, horny hook; the cheeks were partly bare, the stout, short legs yellow. The plumage was dark ash-coloured, with whitish breast and tail, yellowish white wings (incapable of flight). The short tail formed a curly tuft.

The dodo is said to have inhabited forests and to have laid one large white egg on a mass of grass. Besides man, hogs and other imported animals seem to have exterminated it. But the dodo is not the only member of its family that has vanished. The little island which has successively borne the name of Mascaregnas, England's Forest, Bourbon and Réunion, and lies to the southward of Mauritius, had also an allied bird, now dead and gone. Of this not a relic has been handled by any naturalist. The latest description of it, by Du Bois in 1674, is very meagre, while Bontekoe (1646) gave a figure, apparently intended to represent it. It was originally called the "solitaire," but this name was also applied to *Peophaps solitarius* of Rodriguez by the Huguenot exile Leguat, who described and figured it about 1691.

The solitaire, *Didus solitarius* of Gmelin, referred by Strickland to a distinct genus *Peophaps*, is supposed to have lingered in the

³ E. Newton and H. Cadow, *Trans. Zool. Soc. xiii.* (1893) pp. 281-302, pls.



FIG. 2.—The Solitaire of Rodriguez (*Peophaps solitarius*). From Leguat's Bois in 1674, is very meagre, while Bontekoe (1646) gave a figure, apparently intended to represent it. It was originally called the "solitaire," but this name was also applied to *Peophaps solitarius* of Rodriguez by the Huguenot exile Leguat, who described and figured it about 1691.

island of Rodriguez until about 1761. Leguat¹ has given a delightful description of its quaint habits. The male stood about 2 ft. 9 in. high; its colour was brownish grey, that of its mate more inclined to brown, with a whitish breast. The wings were rudimentary, the tail very small, almost hidden, and the thigh feathers were thick and curled "like shells." A round mass of bone, "as big as a musket ball," was developed on the wings of the males, and they used it as a weapon of offence while they whirled themselves about twenty or thirty times in four or five minutes, making a noise with their pinions like a rattle. The mien was fierce and the walk stately, the birds living singly or in pairs. The nest was a heap of palm leaves a foot high, and contained a single large egg which was incubated by both parents. The food consisted of seeds and leaves, and the birds aided digestion by swallowing large stones; these were used by the



FIG. 3.—Skeleton of a male Solitaire, *Pezophaps solitaria*, Museum of Zoology, Cambridge.

Dutch sailors to sharpen their knives with. One of these stones, nearly an inch and a half in length, of extremely hard volcanic rock, is in the Cambridge museum. The fighting knobs mentioned above, are very interesting, large exostoses on one of the wrist-bones of either wing; they were undoubtedly covered with a thick, callous skin. Thousands of bones of this curious flightless pigeon were collected through Sir E. Newton's² exertions, and by H. H. Slater on behalf of the Royal Society of London. The results are several almost complete skeletons of both sexes, composed however out of the enormous mass of the dissociated bones. (A.N.; H.F.G.)

DODONA, in Epirus, the seat of the most ancient and venerable of all Hellenic sanctuaries. Its ruins are at Dramisos, near Tsacharovista. In later times the Greeks of the south looked on the inhabitants of Epirus as barbarians; nevertheless for Dodona they always preserved a certain reverence, and the temple there was the object of frequent missions from them. This temple was dedicated to Zeus, and connected with the temple was an oracle

which enjoyed more reputation in Greece than any other save that at Delphi, and which would seem to date from earlier times than the worship of Zeus; for the normal method of gathering the responses of the oracle was by listening to the rustling of an old oak tree, which was supposed to be the seat of the deity. We seem here to have a remnant of the very ancient and widely diffused tree-worship. Sometimes, however, auguries were taken in other manners, being drawn from the moaning of doves in the branches, the murmur of a fountain which rose close by, or the resounding of the wind in the brazen caldrons which formed a circle all round the temple. Croesus proposed to the oracle his well-known question; Lysander sought to obtain from it a sanction for his ambitious views; the Athenians frequently appealed to its authority during the Peloponnesian War. But the most frequent votaries were the neighbouring tribes of the Acarnanians and Aetolians, together with the Boeotians, who claimed a special connexion with the district.

Dodona is not unfrequently mentioned by ancient writers. It is spoken of in the *Iliad* as the stormy abode of Selli who sleep on the ground and wash not their feet, and in the *Odyssey* an imaginary visit of Odysseus to the oracle is referred to. A Hesiodic fragment gives a complete description of the Dodonæa or Hellopia, which is called a district full of corn-fields, of herds and flocks and of shepherds, where is built on an extremity (*ἐν ἄκρῃ*) Dodona, where Zeus dwells in the stem of an oak (*φύλλῳ*). The priestesses were called doves (*πτελέαι*) and Herodotus tells a story which he learned at Egyptian Thebes, that the oracle of Dodona was founded by an Egyptian priestess who was carried away by the Phœnicians, but says that the local legend substitutes for this priestess a black dove, a substitution in which he tries to find a rational meaning. From inscriptions and later writers we learn that in historical times there was worshipped together with Zeus, a consort named Dione (see further ZETS. ORACLE; DIONE).

The ruins, consisting of a theatre, the walls of a town, and some other buildings, had been conjectured to be those of Dodona by Wordsworth in 1832, but the conjecture was changed into ascertained fact by the excavations of Constantin Carapanos. In 1875 he made some preliminary investigations; soon after, an extensive discovery of antiquities was made by peasants, digging without authority; and after this M. Carapanos made a systematic excavation of the whole site to a considerable depth. The topographical and architectural results are disappointing, and show either that the site always retained its primitive simplicity, or else that whatever buildings once existed have been very completely destroyed.

To the south of the hill, on which are the walls of the town, and to the east of the theatre, is a plateau about 200 yds. long and 90 yds. wide. Towards the eastern end of this terrace are the scanty remains of a building which can hardly be anything but the temple of Zeus; it appears to have consisted of pronaos, naos or cella, and opisthodomus, and some of the lower drums of the internal columns of the cella were still resting on their foundations. No trace of any external colonnade was found. The temple was about 130 ft. by 80 ft. It had been converted into a Christian church, and hardly anything of its architecture seems to have survived. In it and around it were found the most interesting products of excavation—statuettes and decorative bronzes, many of them bearing dedications to Zeus Naïus and Dione, and inscriptions, including many small tablets of lead which contained the questions put to the oracle. Farther to the west, on the same terrace, were two rectangular buildings, which M. Carapanos conjectures to have been connected with the oracle, but which show no distinguishing features.

Below the terrace was a precinct, surrounded by walls and flanked with porticoes and other buildings; it is over 100 yds. in length and breadth, and of irregular shape. One of the buildings on the south-western side contained a pedestal or altar, and is identified by M. Carapanos as a temple of Aphrodite, on the insufficient evidence of a single dedicated object; it does not seem to have any of the characteristics of a temple. In front of the porticoes are rows of pedestals, which once bore statues and

¹ *Voyage et aventures de François Leguat*, &c. (2 vols. London, 1708). An English translation, edited with many additional illustrations from Captain Oliver, has been published by the Hakluyt Society (2 vols., 1891).

² Newton and J. W. Clark, *Phil. Trans.* cliv. (1869), pp. 327-362; (1879), pp. 448-451.

other dedications. At the southern corner of the precinct is a kind of gate or propylaeum, flanked with two towers, between which are placed two coarse limestone drums. If these are *in situ* and belong to the original gateway, it must have been of a very rough character; it does not seem probable that they carried, as M. Carapanos suggests, the statuettes and bronze bowl by which divinations were carried on.

The chief interest of the excavation centres in the smaller antiquities discovered, which have now been transferred from M. Carapanos's collection to the National Museum in Athens. Among the dedications, the most interesting historically are a set of weapons dedicated by King Pyrrhus from the spoils of the Romans, including characteristic specimens of the pilum. The leaden tablets of the oracle contain no certain example of a response, though there are many questions, varying from matters of public policy or private enterprise to inquiries after stolen goods.

The temple of Dodona was destroyed by the Aetolians in 219 B.C., but the oracle survived to the times of Pausanias and even of the emperor Julian.

See C. Wordsworth, *Greece* (1839), p. 247; Constantin Carapanos, *Dodona et ses ruines* (Paris, 1878). For the oracle inscriptions, see E. S. Roberts in *Journal of Hellenic Studies*, vol. i. p. 228. (E. Gr.)

DODS, MARCUS (1834-1909), Scottish divine and biblical scholar, was born at Belford, Northumberland, the youngest son of Rev. Marcus Dods, minister of the Scottish church of that town. He was trained at Edinburgh Academy and Edinburgh University, graduating in 1854. Having studied theology for five years he was licensed in 1858, and in 1864 became minister of Renfield Free Church, Glasgow, where he worked for twenty-five years. In 1889 he was appointed professor of New Testament Exegesis in the New College, Edinburgh, of which he became principal on the death of Dr Rainy in 1907. He died in Edinburgh on the 26th of April 1909. Throughout his life, both ministerial and professorial, he devoted much time to the publication of theological books. Several of his writings, especially a sermon on Inspiration delivered in 1878, incurred the charge of unorthodoxy, and shortly before his election to the Edinburgh professorship he was summoned before the General Assembly, but the charge was dropped by a large majority, and in 1891 he received the honorary degree of D.D. from Edinburgh University. He edited Lange's *Life of Christ* in English (Edinburgh, 1864, 6 vols.), Augustine's works (1872-1876), and, with Dr Alexander Whyte, Clark's "Handbooks for Bible Classes" series. In the Expositor's Bible series he edited Genesis and 1 Corinthians, and he was also a contributor to the 9th edition of the *Encyclopaedia Britannica* and Hastings' *Dictionary of the Bible*. Among other important works are: *The Epistle to the Seven Churches* (1885); *Israel's Iron Age* (1874); *Mohammed, Buddha and Christ* (1877); *Handbook on Haggai, Zechariah and Malachi* (1879); *The Gospel according to St John* (1897), in the Expositor's Greek Testament; *The Bible, its Origin and Nature* (1904), the Bross Lectures, in which he gave an able sketch of the use of Old Testament criticism, and finally set forth his Theory of Inspiration. Apart from his great services to Biblical scholarship he takes high rank among those who have sought to bring the results of technical criticism within the reach of the ordinary reader.

DODSLEY, ROBERT (1703-1764), English bookseller and miscellaneous writer, was born in 1703 near Mansfield, Nottinghamshire, where his father was master of the free school. He is said to have been apprenticed to a stocking-weaver in Mansfield, from whom he ran away, taking service as a footman. In 1729 Dodsley published his first work, *Servitude; a Poem . . . written by a Footman*, with a preface and postscript ascribed to Daniel Defoe; and a collection of short poems, *A Muse in Livery, or the Footman's Miscellany*, was published by subscription in 1732. Dodsley's patrons comprising many persons of high rank. This was followed by a satirical farce called *The Toyshop* (Covent Garden, 1735), in which the toyman indulges in moral observations on his wares, a hint which was probably taken from Thomas Randolph's *Conceited Pedlar*. The profits accruing from the sale of his works enabled Dodsley to establish himself with the help of

his friends—Pope lent him £100—as a bookseller at the "Tully's Head" in Pall Mall in 1735. His enterprise soon made him one of the foremost publishers of the day. One of his first publications was Dr Johnson's *London*, for which he gave ten guineas in 1738. He published many of Johnson's works, and he suggested and helped to finance the *English Dictionary*. Pope also made over to Dodsley his interest in his letters. In 1738 the publication of Paul Whitehead's *Manners*, voted scandalous by the Lords, led to a short imprisonment. Dodsley published for Edward Young and Mark Akenside, and in 1751 brought out Thomas Gray's *Elegy*. He also founded several literary periodicals: *The Museum* (1746-1767, 3 vols.); *The Preceptor containing a general course of education* (1748, 2 vols.), with an introduction by Dr Johnson; *The World* (1753-1756, 4 vols.); and *The Annual Register*, founded in 1758 with Edmund Burke as editor. To these various works, Horace Walpole, Akenside, Soame Jenyns, Lord Lyttelton, Lord Chesterfield, Burke and others were contributors. Dodsley is, however, best known as the editor of two collections: *Select Collection of Old Plays* (12 vols., 1744; 2nd edition with notes by Isaac Reed, 12 vols., 1780; 4th edition, by W. C. Hazlitt, 1874-1876, 15 vols.); and *A Collection of Poems by Several Hands* (1748, 3 vols.), which passed through many editions. In 1737 his *King and the Miller of Mansfield*, a "dramatic tale" of King Henry II., was produced at Drury Lane, and received with much applause; the sequel, *Sir John Cockle at Court*, a farce, appeared in 1738. In 1745 he published a collection of his dramatic works, and some poems which had been issued separately, in one volume under the modest title of *Trifles*. This was followed by *The Triumph of Peace, a Masque occasioned by the Treaty of Aix-la-Chapelle* (1749); a fragment, entitled *Agriculture*, of a long tedious poem in blank verse on *Public Virtue* (1753); *The Blind Beggar of Bethnal Green* (acted at Drury Lane 1739, printed 1741); and an ode, *Melpomene* (1757). His tragedy of *Cleone* (1758) had a long run at Covent Garden, 2000 copies being sold on the day of publication, and it passed through four editions within the year. Lord Chesterfield is, however, almost certainly the author of the series of mock chronicles of which *The Chronicle of the Kings of England* by "Nathan ben Saggi" (1740) is the first, although they were included in the *Trifles* and "ben Saggi" was received as Dodsley's pseudonym. *The Economy of Human Life* (1750), a collection of moral precepts frequently reprinted, is also by Lord Chesterfield. In 1759 Dodsley retired, leaving the conduct of the business to his brother James (1734-1797), with whom he had been many years in partnership. He published two more works, *The Select Fables of Aesop translated by R. D.* (1764) and the *Works of William Shenstone* (3 vols., 1764-1769). He died at Durham while on a visit to his friend the Rev. Joseph Spence, on the 23rd of September 1764.

See also *Shadows of the Old Booksellers*, by Charles Knight (1865), pp. 189-216; "At Tully's Head" in *Eighteenth Century Vignettes*, 2nd series, by Austin Dobson (1894); E. Solly in *The Bibliographer*, v. (1884) pp. 57-61. Dodsley's poems are reprinted with a memoir in A. Chalmers's *Works of English Poets*, vol. xv. (1810).

DODSWORTH, ROGER (1585-1654), English antiquary, was born near Oswaldkirk, Yorkshire. He devoted himself early to antiquarian research, in which he was greatly assisted by the fact that his father, Matthew Dodsworth, was registrar of York cathedral, and could give him access to the records preserved there. He married the widow of Laurence Rawthorne of Hutton Grange, where he subsequently resided till his death in August 1654. At various times in his life he was enabled to study the records in the library of Sir Robert Cotton, in Skipton Castle, and in the Tower of London. He collected a vast store of materials for a history of Yorkshire, a *Monasticum Anglicanum*, and an English baronage. The second of these was published with considerable additions by Sir William Dugdale (2 vols., 1655 and 1661). The MSS. were left to Thomas, third Lord Fairfax, who by his will bequeathed them (160 volumes in all) to the Bodleian Library at Oxford. Portions have been printed by the Yorkshire Archaeological Society (*Dodswoorth's Yorkshire Notes*, 1884) and the Chetham Society (copies of Lancashire post-mortem inquisitions, 1875-1876).

DODWELL, EDWARD (1767-1832), English traveller and writer on archaeology. He belonged to the same family as Henry Dodwell the theologian, and was educated at Trinity College, Cambridge. He travelled from 1801 to 1806 in Greece, and spent the rest of his life for the most part in Italy, at Naples and Rome. He died at Rome on the 13th of May 1832, from the effects of an illness contracted in 1830 during a visit of exploration to the Sabine Mountains. His widow, a daughter of Count Giraud, thirty years his junior, subsequently became famous as the "beautiful" countess of Spaur, and played a considerable rôle in the political life of the papal city. He published *A Classical and Topographical Tour through Greece* (1819), of which a German translation appeared in 1821; *Views in Greece*, thirty coloured plates (1821); and *Views and Descriptions of Cypriote or Pelasgic Remains in Italy and Greece* (London and Paris, with French text, 1834).

DODWELL, HENRY (1641-1711), scholar, theologian and controversial writer, was born at Dublin in October, 1641. His father, having lost his property in Connaught during the rebellion, settled at York in 1648. Here Henry received his preliminary education at the free school. In 1654 he was sent by his uncle to Trinity College, Dublin, of which he subsequently became scholar and fellow. Having conscientious objections to taking orders he relinquished his fellowship in 1666, but in 1688 he was elected Camden professor of history at Oxford. In 1691 he was deprived of his professorship for refusing to take the oath of allegiance to William and Mary. Retiring to Shottesbrooke in Berkshire, and living on the produce of a small estate in Ireland, he devoted himself to the study of chronology and ecclesiastical polity. Gibbon speaks of his learning as "immense," and says that his "skill in employing facts is equal to his learning," although he severely criticizes his method and style. Dodwell's works on ecclesiastical polity are more numerous and of much less value than those on chronology, his judgment being far inferior to his power of research. In his earlier writings he was regarded as one of the greatest champions of the non-jurors; but the doctrine which he afterwards promulgated, that the soul is naturally mortal, and that immortality could be enjoyed only by those who had received baptism from the hands of one set of regularly ordained clergy, and was therefore a privilege from which dissenters were hopelessly excluded, did not strengthen his reputation. Dodwell died at Shottesbrooke on the 7th of June 1711. His chief works on classical chronology are: *A Discourse concerning Sanchoiathon's Phœnician History* (1681); *Annales Thucydidei et Xenophontei* (1702); *Chronologia Græco-Romana pro hypothese Dion. Halicarnassæi* (1692); *Annales Velleiani, Quintilianei, Statiani* (1698); and a larger treatise entitled *De veteribus Græcorum Romanorumque Cyclicis* (1701).

His eldest son Henry (d. 1784) is known as the author of a pamphlet entitled *Christianity not founded on Argument*, to which a reply was published by his brother William (1700-1785), who was besides engaged in a controversy with Dr Conyers Middleton on the subject of miracles.

See *The Works of H. D. . . . abridg'd with an account of his life*, by F. Brokesby (2nd ed., 1723) and Thomas Hearne's *Diaries*.

DOG, the English generic term for the quadruped of the domesticated variety of *Canis* (*Fr. chien*). The etymology of the word is unknown; "hound" represents the common Teutonic term (*Ger. Hund*), and it is suggested that the "English dog"—for this was a regular phrase in continental European countries—represented a special breed. Most canine experts believe that the dog is descended from the wolf, although zoologists are less certain (see *CARNIVORA*); the osteology of one does not differ materially from that of the other: the dog and the wolf breed with each other, and the progeny thus obtained will again breed with the dog. There is one circumstance, however, which seems to mark a difference between the two animals: the eye of the dog of every country and species has a circular pupil, but the position or form of the pupil is oblique in the wolf. W. Youatt says there is also a marked difference in the temper and habits of the two. The dog is generally easily managed, and although H. C. Brooke of Welling, Kent, succeeded in making a wolf

fairly tractable, the experience of others has been the reverse of encouraging. G. Cuvier gives an interesting account of a young wolf which, having been trained to follow his master, showed affection and submission scarcely inferior to the domesticated dog. During the absence from home of his owner the wolf was sent to a menagerie, but pined for his master and would scarcely take any food for a considerable time. At length, however, he became attached to his keepers and appeared to have forgotten his former associate. At the end of eighteen months his master returned, and, the moment his voice was heard, the wolf recognized him and lavished on him the most affectionate caresses. A still longer separation followed, but the wolf again remembered his old associate and showed great affection upon his return. Such an association proves that there is very little difference between the dog and the wolf in recognition of man as an object of affection and veneration. H. C. Brooke succeeded in training his wolf so well that it was no uncommon sight to see the latter following his master like a dog. The wolf did not like strangers, however, and was very shy in their presence.

In the Old and New Testaments the dog is spoken of almost with abhorrence; it ranked amongst the unclean beasts: traffic in it was considered as an abomination, and it was forbidden to be offered in the sanctuary in the discharge of any vow. Part of the Jewish ritual was the preservation of the Israelites from the idolatry which at that time prevailed among every other people. Dogs were held in considerable veneration by the Egyptians, from whose tyranny the Israelites had just escaped; figures of them appeared on the friezes of most of the temples, and they were regarded as emblems of the divine being. Herodotus, speaking of the sanctity in which some animals were held by the Egyptians, says that the people of every family in which a dog died shaved themselves—their expression of mourning—adding that this was a custom of his own time.

The cause of this attachment to and veneration for the dog is, however, explained in a far more probable and pleasing way than by many of the fables of ancient mythology. The prosperity of Lower Egypt, and almost the very subsistence of its inhabitants, depended upon the annual overflowing of the Nile; and they looked for it with the utmost anxiety. Its approach was announced by the appearance of a certain star, Sirius, and as soon as that star was seen above the horizon the people hastened to remove their flocks to the higher ground and abandoned the lower pastures to the fertilizing influence of the stream. They hailed it as their guard and protector; and, associating with its apparent watchfulness the well-known fidelity of the dog, they called it the "dog-star" and worshipped it. It was in far later periods and in other countries that the appearance of the dog-star was regarded as the signal of insufferable heat or prevalent disease. In Ethiopia, not only was great veneration paid to the dog, but the inhabitants used to elect a dog as their king. It was kept in great state, and surrounded by a numerous train of officers and guards: when it fawned upon them it was supposed to be pleased with their proceedings; when it growled, it disapproved of the manner in which their government was conducted. Such indications of will were implicitly obeyed, or were translated by the worshippers as their own caprice or interest indicated.

Even 1000 years after this period, the dog was highly esteemed in Egypt for its sagacity and other excellent qualities; for when Pythagoras, after his return from Egypt, founded a new sect in Greece, and at Croton in southern Italy, he taught, with the Egyptian philosophers, that at the death of the body the soul entered into that of various animals. After the death of any of his favourite disciples he would hold a dog to the mouth of the man in order to receive the departing spirit, saying that there was no animal which could perpetuate his virtues better than that quadruped. It was in order to preserve the Israelites from errors and follies of this kind, and to prevent the possibility of such idolatry being established, that the dog was afterwards regarded with utter abhorrence amongst the Jews, and this feeling prevailed during the continuance of the Israelites in Palestine.

The Hindus also regard the dog as unclean, and submit to various purifications if they accidentally come in contact with it, believing that every dog is animated by a wicked and malignant spirit condemned to do penance in that form for crimes committed in a previous state of existence. In every Mahomedan and Hindu country the most scurrilous epithet bestowed on a European or a Christian is "a dog," and that accounts for the fact that in the whole of the Jewish history there is not a single allusion to hunting with dogs. Mention is made of nets and snares, but the dog does not seem to have been used in the pursuit of game.

In the early periods of the history of other countries this seems to have been the case even where the dog was esteemed and valued, and had become the companion, the friend and the defender of man and his home; and in the 2nd century of the Christian era Arrian wrote that "there is as much difference between a fair trial of speed in a good run, and ensnaring a poor animal without an effort, as between the secret piratical assaults of robbers at sea and the victorious naval engagements of the Athenians at Artemisium and at Salamis." The first hint of the employment of the dog in the pursuit of other animals is given by Oppian in his *Cynegetica*, who attributes it to Pollux about 200 years after the promulgation of the Levitical law. The precise species of dog that was cultivated in Greece at that early period cannot be affirmed, although a beautiful piece of sculpture in the possession of Lord Feversham at Duncombe Hall, representing the favourite dog of Alcibiades, differs but little from the Newfoundland dog of the present day. In the British Museum is another piece of early sculpture from the ruins of the villa of Antoninus, near Rome. The greyhound puppies which it represents are identical with a brace of saplings of the present day. In the early periods of their history the Greeks depended too much on their nets to capture game, and it was not until later times that they pursued their prey with dogs, and then not with greyhounds, which run by sight, but with beagles, the dwarf hound which is still very popular. Later, mention is made of large and ferocious dogs which were employed to guard sheep and cattle, or to watch at the door of the house, or even to act as a companion, and G. Cuvier expresses the opinion that the dog exhibits the most complete and the most useful conquest that man has made. Each individual is entirely devoted to his master, adopts his manners, distinguishes and defends his property, and remains attached to him even unto death; and all this springs not from mere necessity nor from constraint, but simply from gratitude and true friendship.

The swiftness, the strength and the highly developed power of scent in the dog, have made it a powerful ally of man against the other animals; and perhaps these qualities in the dog were necessary to the establishment of society. Instances of dogs having saved the lives of their owners by that strange intuition of approaching danger which they appear to possess, or by their protection, are innumerable: their attachment to man has inspired the poet and formed the subject of many notable books, while in Daniel's *Rural Sports* is related a story of a dog dying in the fulness of joy caused by the return of his master after a two years' absence from home.

It is not improbable that all dogs sprang from one common source, but climate, food and cross-breeding caused variations of form which suggested particular uses, and these being either designedly or accidentally perpetuated, the various breeds of dogs arose, and became numerous in proportion to the progress of civilization. Among the ruder or savage tribes they possess but one form; but the ingenuity of man has devised many inventions to increase his comforts; he has varied and multiplied the characters and kinds of domestic animals for the same purpose, and hence the various breeds of horses, cattle and dogs. The parent stock it is now impossible to trace; but the wild dog, wherever found on the continent of Asia, or northern Europe, has nearly the same character, and bears no inconsiderable resemblance to the British dog of the ordinary type; while many of those from the southern hemisphere can scarcely be distinguished from the cross-bred poaching dog, the lurcher.

Dogs were first classified into three groups:—(1) Those having the head more or less elongated, and the parietal bones of the skull widest at the base and gradually approaching towards each other as they ascend, the condyles of the lower jaw being on the same line with the upper molar teeth. The greyhound and all its varieties belong to this class. (2) The head moderately elongated and the parietals diverging from each other for a certain space as they rise upon the side of the head, enlarging the cerebral cavity and the frontal sinus. To this class belong most of the useful dogs, such as the spaniel, the setter, the pointer and the sheepdog. (3) The muzzle more or less shortened, the frontal sinus enlarged, and the cranium elevated and diminished in capacity. To this class belong some of the terriers and most of the toy dogs.

Later, however, "Stonehenge" (J. H. Walsh), in *British Rural Sports*, classified dogs as follows:—(a) Dogs that find game for man, leaving him to kill it himself—the pointer, setters, spaniels and water spaniels. (b) Dogs which kill game when found for them—the English greyhound. (c) Dogs which find and also kill their game—the bloodhound, the foxhound, the harrier, the beagle, the otterhound, the fox terrier and the truffle dog. (d) Dogs which retrieve game that has been wounded by man—the retriever, the deerhound. (e) Useful companions of man—the mastiff, the Newfoundland, the St Bernard dog, the bulldog, the bull terrier, terriers, sheepdogs, Pomeranian or Spitz, and Dalmatian dogs. (f) Ladies' toy dogs—King Charles spaniel, the Blenheim spaniel, the Italian greyhound, the pug dog, the Maltese dog, toy terriers, toy poodles, the lion dog, Chinese and Japanese spaniels. In 1894 *Modern Dogs* (Rawdon B. Lee) was issued, the simple classification of sporting and non-sporting dog—terriers and toy dogs, being adopted; but although there had been an understanding since 1874, when the first volume of the *Kennel Club Stud Book* (Frank C. S. Pearce) was issued, as to the identity of the two great divisions of dogs, an incident at Altrincham Show in September 1900—an exhibitor entering a Russian wolfhound in both the sporting and non-sporting competitions—made it necessary for authoritative information to be given as to how the breeds should be separated. Following petitions to the Kennel Club from exhibitors at the club's own show at the Crystal Palace, and also at the show of the Scottish Kennel Club in Edinburgh during the autumn of 1900, the divisions were decided upon as follows:—

Sporting.—Bloodhound, otterhound, foxhound, harrier, beagle, basset hound (smooth and rough), dachshund, greyhound, deerhound, Borzoi, Irish wolfhound, whippet, pointer, setter (English, Irish and black and tan), retriever (flat-coated, curly-coated and Labrador), spaniel (Irish water, water other than Irish, Clumber, Sussex, field, English springer, other than Clumber, Sussex and field; Welsh springer, red and white and Cocker); fox terriers (smooth- and wire-coated); Irish terrier, Scotch terrier, Welsh terrier, Dandie Dinmont terrier, Skye terrier (prick-eared and drop-eared), Airedale terrier and Bedlington terrier.

Non-Sporting.—Bulldog, bulldog (miniature), mastiff, Great Dane, Newfoundland (black, white and black, or other than black), St Bernard (rough and smooth), Old English sheepdog, collie (rough and smooth), Dalmatian, poodle, bull terrier, white English terrier, black and tan terrier, toy spaniel (King Charles or black and tan, Blenheim, ruby or red and tricolour), Japanese, Pekinese, Yorkshire terrier, Maltese, Italian greyhound, chow-chow, black and tan terrier (miniature), Pomeranian, pug (fawn and black), Schipperke, Griffon Bruxellois, foreign dogs (bouledogues français, elk-hounds, Eskimos, Lhasa terriers, Samoyedes and any other varieties not mentioned under this heading).

On the 4th of May 1898 a sub-committee of the Kennel Club decided that the following breeds should be classified as "toy dogs":—Black and tan terriers (under 7 lb), bull terriers (under 8 lb), griffons, Italian greyhounds, Japanese, Maltese, Pekinese, poodles (under 15 in.), pugs, toy spaniels, Yorkshire terriers and Pomeranians.

All these varieties were represented at the annual show of the

Kennel Club in the autumn of 1905, and at the representative exhibition of America held under the management of the Westminster Kennel Club in the following spring the classification was substantially the same, additional breeds, however, being Boston terriers—practically unknown in England,—Chesapeake Bay dogs, Chihuahuas, Papillons and Roseneath terriers. The latter were only recently introduced into the United States, though well known in Great Britain as the West Highland or Poltalloch terrier; an application which was made (1900) by some of their admirers for separate classification was refused by the Kennel Club, but afterwards it was granted, the breed being classified as the West Highland white terrier.

The establishment of shows at Newcastle-on-Tyne in June 1859 secured for dogs attention which had been denied them up to that time, although sportsmen had appreciated their value for centuries and there had been public coursing meetings since the reign of Charles I. Lord Orford, however, established the first club at Marham Smeeth near Swaffham, where coursing is still carried on, in 1776. The members were in number confined to that of the letters in the alphabet; and when any vacancy happened it was filled up by ballot. On the decease of the founder of the club, the members agreed to purchase a silver cup to be run for annually, and it was intended to pass from one to the other, like the whip at Newmarket, but before starting for it, in the year 1792, it was decided that the winner of the cup should keep it and that one should be annually purchased to be run for in November. At the formation of the club each member assumed a colour, and also a letter, which he used as the initial of his dog's name. The Newcastle dog show of 1859 was promoted by Mr Pape—a local sporting gunmaker—and Mr Shorthose, and although only pointers and setters were entered for in two classes immense interest was taken in the show. But neither the promoters nor the sportsmen who supported it could have had the faintest idea as to how popular dog shows would become. The judges at that historic gathering were: Messrs J. Jobling (Morpeth), T. Robson (Newcastle-on-Tyne) and J. H. Walsh (London) for pointers, and E. Foulger (Alnwick), R. Brailsford (Knowsley) and J. H. Walsh for the setters. Sixty dogs were shown, and it was said that such a collection had not been seen together before; while so even was the quality that the judges had great difficulty in making their awards. The prizes were sporting guns made by Mr Pape and presented by him to the promoters of the show. So great a success was scored that other shows were held in the same year at Birmingham and Edinburgh; while the Cleveland Agricultural Society also established a show of foxhounds at Redcar, the latter being the forerunner of that very fine show of hounds which is now held at Peterborough every summer and is looked upon as the out-of-season society gathering of hunting men and women.

Mr Brailsford was the secretary of the show at Birmingham, and he had classes for pointers, English and Irish setters, retrievers and Clumber spaniels. Another big success was scored, and the National Dog Show Society was established for the purpose of holding a show of sporting dogs in Birmingham every winter. Three years later proposals were made in *The Field* to promote public trials of pointers and setters over game, but it was not until the 18th of April 1865 that a further step was taken in the recognition of the value of the dog by the promotion of working trials. They were held at Southill, near Bedford, on the estate of S. Whitbread, M.P., and they attracted great interest. The order of procedure at the early field trials was similar to what it is to-day, only the awards were given in accordance with a scale of points as follows: nose, 40; pace and range, 30; temperament, 10; staunchness before, 10; behind, 10. Style of working was also taken into consideration. In 1865 a show was held in Paris, and after the National Dog Club—not the Birmingham society—had failed, as the result of a disastrous show at the Crystal Palace, a further exhibition was arranged to be held in June 1870 under the management of G. Nutt and a very strong committee, among whom were many of the most noted owners of sporting dogs of that time. The details of the show were arranged by S. E. Shirley and J. H. Murchison, but the exhibition, although a

most interesting one, was a failure, and the guarantors had to face a heavy loss. A second venture proved to be a little more encouraging, although again there was a loss; but in April 1873, the Kennel Club, which is now the governing body of the canine world, was founded by S. E. Shirley, who, after acting as its chairman for many years, was elected the president, and occupied that position until his death in March 1904. His successor was the duke of Connaught and Strathearn; the vice-presidents including the duke of Portland, Lord Algernon Gordon Lennox, J. H. Salter and H. Richards. The progress of the club has been remarkable, and that its formation did much to improve the conditions of the various breeds of dogs, to encourage their use in the field by the promotion of working trials, and to check abuses which were common with regard to the registration of pedigrees, &c., cannot be denied. The abolition of the cropping of the ears of Great Danes, bull terriers, black and tan terriers, white English terriers, Irish terriers and toy terriers, in 1889 gained the approval of all humane lovers of dogs, and although attempts have been made to induce the club to modify the rule which prohibits the exhibition of cropped dogs, the practice has not been revived; it is declared, however, that the toy terriers and white English terriers have lost such smartness by the retention of the ears that they are becoming extinct. The club has control over all the shows held in the United Kingdom, no fewer than 519 being held in 1905, the actual number of dogs which were entered at the leading fixtures being: Kennel Club show 1789, Cruft's 1768, Ladies' Kennel Association 1306, Manchester 1190, Edinburgh 896 and Birmingham 892. In 1906, however, no fewer than 1956 dogs were entered at the show of the Westminster Kennel Club, held in Madison Square Garden, New York; a fact proving that the show is as popular in America as it is in the United Kingdom, the home of the movement. The enormous sum of £1500 has been paid for a collie, and 1000 guineas for a bulldog, both show dogs pure and simple; while £500 is no uncommon price for a fox terrier. Excepting for greyhounds, however, high prices are rarely offered for sporting dogs, 300 guineas for the pointer "Coronation" and 200 guineas for the retriever "High Legh Blarney" being the best reported prices for gun dogs during the last few years.

The foreign and colonial clubs which are affiliated to the Kennel Club are: the Guernsey Dog Club, the Italian Kennel Club, the Jersey Dog Club, La Société Centrale (Paris), Moscow Gun Club of the Emperor Alexander II., New South Wales Kennel Club, Nimrod Club (Amsterdam), Northern Indian Kennel Association, Royal St Hubert's Society (Brussels) and the South African Kennel Club (Cape Town). Its ramifications therefore extend to all parts of the world; while its rules are the basis of those adopted by the American Kennel Club, the governing body of the "fancy" in the United States. A joint conference between representatives of the two bodies, held in London in 1900, did much towards securing the uniformity of ideas which is so essential between associations having interests in common.

Most of the leading breeds have clubs or societies, which have been founded by admirers with a view to furthering the interests of their favourites; and such combinations as the Bulldog Club (incorporated), the London Bulldog Society, the British Bulldog Club, the Fox Terrier Club, the Association of Bloodhound Breeders—under whose management the first man-hunting trials were held,—the Bloodhound Hunt Club, the Collie Club, the Dachshund Club, the Dandie Dinmont Terrier Club, the English Setter Club, the Gamekeepers' Association of the United Kingdom, the International Gun Dog League, the Irish Terrier Club, the Irish Wolfhound Club, the St Bernard Club, the National Terrier Club, the Pomeranian Club, the Spaniel Club, the Scottish Terrier Club and the Toy Bulldog Club have done good work in keeping the claims of the breeds they represent before the dog-owning public and encouraging the breeding of dogs to type. Each club has a standard of points; some hold their own shows; while others issue club gazettes. All this has been brought about by the establishment of a show for sporting dogs at Newcastle-on-Tyne in the summer of 1859.

America can claim a list of over twenty specialist clubs, and in both countries women exhibitors have their independent



Great Dane.



Saint Bernard.

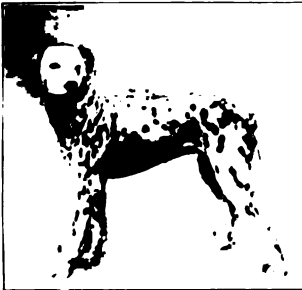

Dalmatian.



Mastiff.



Old English Sheep Dog.



Collie.



Chow.



Newfoundland.



Poodle.



Bull Dog.



French Bull Dog.

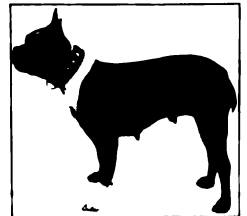

From "Country Life in America."
Boston Terrier.

(From Photos by Bowden Bros.)
Typical Non-Sporting Dogs.



English Setter.



Pointer.



Irish Setter.



Labrador Retriever.



Flat-Coated Retriever.



Irish Wolf-Hound.



Irish Terrier.



Dachshund.



Rough-Coated Fox Terrier.

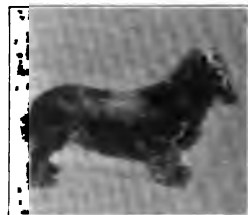

Field Spaniel.

(From Photos by Bowden Bros.)
Typical Sporting Dogs.



Borzoi.



Greyhound.



Deerhound.



Bloodhound.

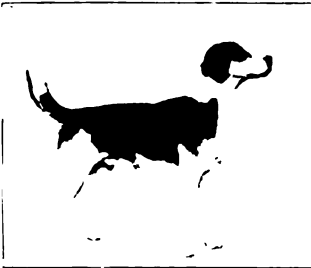

Fox Hound.



Harrier.



Otter Hound.



Australian Terrier.



Skye Terrier.



Scotch Terrier.

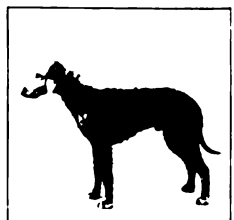

Bedlington Terrier.

(From Photos by Bowden Bros.)
Typical Sporting Dogs.



Photo, Bowden Bros.
Pomeranian.



Photo, Thos. Fall.
Italian Greyhound.



Photo, Bowden Bros.
Toy Bull Terrier.



Photo, Bowden Bros.
Toy Spaniel.



Photo, Walker.
Blenheim.



Photo, Thos. Fall.
Papillon.



Photo, Bowden Bros.
Schipperke.



Photo, Bowden Bros.
Maltese.



Photo, Thos. Fall.
Toy Black and Tan.



Photo, Bowden Bros.
Yorkshire Terrier.



Photo, Bowden Bros.
Pug.



Photo, Bowden Bros.
Griffon.



Photo, Bowden Bros.
Japanese.



Photo, Bowden Bros.
Pekingese.

Typical Toy Dogs.

associations, Queen Alexandra having become one of the chief supporters of the Ladies' Kennel Association (England). There is a ladies' branch of the Kennel Club, and the corresponding clubs in America are the Ladies' Kennel Association of America and the Ladies' Kennel Association of Massachusetts.

The Gazette is the official organ of the Kennel Club. *The Field*, however, retains its position as the leading canine journal, the influence of J. H. Walsh ("Stonehenge"), who did so much towards establishing the first dog shows and field trials, having never forsaken it: the work he began was carried on by its kennel editor, Rawdon B. Lee (d. 1908), whose volumes on *Modern Dogs* (sporting, non-sporting and terriers) are the standard works on dogs. *Our Dogs*, *The Kennel Magazine*, and *The Illustrated Kennel News* are the remaining canine journals in England. Several weekly papers published on the continent of Europe devote a considerable portion of their space to dogs, and canine journals have been started in America, South Africa and even India: while apart from Lee's volumes and other carefully compiled works treating on the dog in general, the various breeds have been written about, and the books or monographs have large sales. At the end of 1905 E. W. Jaquet wrote *The Kennel Club: a History and Record of its Work*, and an edition *de luxe* of *Dogs* is edited by Mr Harding Cox; Mr Sidney Turner, the chairman of the Kennel Club committee, edited *The Kennel Encyclopedia*, the first number of which was issued in 1907. Dog lovers are now numbered by their tens of thousands, and in addition to shows of their favourites, owners are also liberally catered for in the shape of working trials, for during the season competitions for bloodhounds, pointers, setters, retrievers, spaniels and sheepdogs are held.

Breeds of Dog.

Nothing is known with certainty as to the origin of the vast majority of breeds of dogs, and it is an unfortunate fact that the progressive changes which have been made within comparatively recent times by fanciers have not been accurately recorded by the preservation, in museums or collections, of the actual specimens considered typical at different dates. No scientific classification of the breeds of dogs is at present possible, but whilst the division already given into "sporting" and "non-sporting" is of some practical value, for descriptive purposes it is convenient to make a division into the six groups:—wolfdogs, greyhounds, spaniels, hounds, mastiffs and terriers. It is to be remembered, however, that all these types interbred freely, and that many intermediate, and forms of wholly doubtful position, occur.

Wolfhounds.—Throughout the northern regions of both hemispheres there are several breeds of semi-domesticated dogs which are wolf-like, with erect ears and long woolly hair. The Eskimo dog has been regarded as nothing more than a reclaimed wolf, and the Eskimo are stated to maintain the size and strength of their dogs by crossing them with wolves. The domestic dogs of some North American Indian tribes closely resemble the coyote; the black wolfdog of Florida resembles the black wolf of the same region; the sheepdogs of Europe and Asia resemble the wolves of those countries, whilst the pariah dog of India is closely similar to the Indian wolf. The Eskimo dog has small, upright ears, a straight bushy tail, moderately sharp muzzle and rough coat. Like a wolf, it howls but does not bark. It occurs throughout the greater part of the Arctic regions, the varieties in the old and new world differing slightly in colour. They are fed on fish, game and meat. They are good hunters and wonderfully cunning and enduring. Their services to their owners and to Arctic explorers are well known, but Eskimo dogs are so rapacious that it is impossible to train them to refrain from attacking sheep, goats or any small domesticated animals. The Hare Indian dog of the Great Bear Lake and the Mackenzie river is more slender, gentle and affectionate than the Eskimo dog, but is impatient of restraint, and preserves many of the characters of its wild ally, the coyote, and is practically unable to bark.

The Pomeranian dog is a close ally of the Eskimo breed and was formerly used as a wolfdog, but has been much modified. The larger variety of the race has a sharp muzzle, upright

pointed ears, and a bushy tail generally carried over the back. It varies in colour from black through grey to reddish brown and white. The smaller variety, sometimes known as the Spitz, was formerly in some repute as a fancy dog, a white variety with a black tip to the nose and a pure black variety being specially prized. Pomeranians have been given most attention in Germany and Belgium, while the so-called Spitz has been popular in England and America.

The sheepdogs and collies are still further removed from the wolf type, and have the tip of the ear pendent. The tail is thick and bushy, the feet and legs particularly strong, and there is usually a double dew-claw on each hind limb. The many varieties found in different countries have the same general characters. The bark is completely dog-like, and the primitive hunting instincts have been cultivated into a marvellous aptitude for herding sheep and cattle. The training takes place during the first year, and the work is learned with extreme facility. The Scotch collie is lighter and more elegant, and has a sharper muzzle. Since it became popular as a pet dog, its appearance has been greatly improved, and whilst it has lost its old sullen concentration, it has retained unusual intelligence and has become playful and affectionate. The wolfdogs all hunt chiefly by scent.

Greyhounds.—These are characterized by slight build, small ears falling at the tips, elongated limbs and tails and long narrow muzzles. They hunt entirely by sight, the sense of smell being defective. The English greyhound is the most conspicuous and best-known member of the group, and has been supposed to be the parent of most of the others. The animal is thoroughly adapted for extreme speed, the long, rat-like tail being used in balancing the body in quick turns. The favourite colour is a uniform sandy, or pale grey tone, but characters directly related to capacity for speed have received most attention. The Italian greyhound is a miniature greyhound, still capable of considerable speed but so delicate that it is almost unable to pull down even a rabbit, and is kept simply as a pet. The eyes are large and soft, and a golden fawn is the colour most prized. The Scotch deerhound is a larger and heavier variety of the English greyhound, with rough and shaggy hair. It has been used both for deer stalking and for coursing, and several varieties exist. The Irish wolfhound is now extinct, but appears to have been a powerful race heavier than the deerhound but similar to it in general characters. Greyhounds have been bred from time immemorial in Eastern Europe and Western Asia, while unmistakable representatives are figured on the monuments of ancient Egypt. The existing Oriental varieties are in most cases characterized by silky hair. The hairless dogs of Central Africa are greyhounds employed chiefly in hunting antelopes, and there are somewhat similar varieties in China, Central and South America.

The whippet is a local English dog, used chiefly in rabbit coursing and racing, and is almost certainly a cross between greyhounds and terriers.

The lurcher is a dog with the general shape of a greyhound, but with a heavier body, larger ears and rougher coat. Lurchers are cross-bred dogs, greyhounds and sheepdogs, or deerhounds and collies, being the parents.

Spaniels are heavily built dogs with short and very wide skulls rising suddenly at the eyes. The brain is relatively large and the intelligence high. The muzzle is short, the ears large and pendent, the limbs relatively short and heavy, and the coat thick and frequently long. It is supposed, from their name, that they are of Spanish origin. They may be divided into field spaniels, water spaniels and the smaller breeds kept as pets. Field spaniels are excellent shooting dogs, and are readily trained to give notice of the proximity of game. The Clumber, Sussex, Norfolk and Cocker breeds are the best established. The Clumber is long, low and heavy. It is silent when hunting, and has long ears shaped like vine leaves. The ground colour of the coat is white with yellow spots. The Sussex is a lighter, more noisy animal, with a wavy, golden coat. The Cockers are smaller spaniels, brown, or brown-and-white in the Welsh variety, black in the more common modern English form. The head is short,

and the coat silky and wavy. Of the water spaniels the Irish breeds are best known. They are relatively large dogs, with broad splay feet, and silky oily coats.

The poodle is probably derived from spaniels, but is of slighter, more graceful build, and is pre-eminently even among spaniels for intelligence. The best known pet spaniels are the King Charles and the Blenheim, small dogs with fine coats, probably descended from Cocker.

Setters owe their name to their having been trained originally to crouch when marking game, so as to admit of the net with which the quarry was taken being drawn over their heads. Since the general adoption of shooting in place of netting or bagging game, setters have been trained to act as pointers. They are pre-eminently dogs for sporting purposes, and special strains or breeds adapted to the peculiarities of different kinds of sporting have been produced. Great Britain is probably the country where setters were first produced, and as early as the 17th century spaniels were used in England as setting dogs. It is probable that pointer blood was introduced in the course of shaping the various breeds of setter. The English setter should have a silky coat with the hair waved but not curly; the legs and toes should be hairy, and the tail should have a bushy fringe of hairs hanging down from the dorsal border. The colour varies much, ranging according to the strains, from black-and-white through orange-and-white and liver-and-white to pure white, whilst black, white, liver, and red or yellow self-coloured setters are common. The Irish setter is red without trace of black, but occasionally flecked with white. The Gordon setter, the chief Scottish variety, is a heavier animal with coarser hair, black-and-tan in colour. The Russian setter has a woolly and matted coat.

The retriever is a large dog used for retrieving game on land, as a water spaniel is used for the same purpose in water. The breed is almost certainly derived from water-spaniels, with a strong admixture of Newfoundland blood. The colour is black or tan, and the hair of the face, body and tail is close and curly, although wavy-coated strains exist.

The Newfoundland is simply an enormous spaniel, and shows its origin by the facility with which it takes to water and the readiness with which it mates with spaniels and setters. It has developed a definite instinct to save human beings from drowning, this probably being an evolution of the retrieving instinct of the original spaniels. The true Newfoundland is a very large dog and may reach 31 in. in height at the shoulder. The coat is shaggy and oily, and is preferred with as little white as possible, but the general black coloration may have rusty shades. The eyes and ears are relatively small, and the forehead white and dome-shaped, giving the face the well-known appearance of benignity and intelligence. Although these dogs were originally brought to Great Britain from Newfoundland and are still bred in the latter country, greater size, perfection and intelligence have been attained in England, where Newfoundlands for many years have been the most popular large dogs. They are easily taught to retrieve on land or water, and their strength, intelligence and fidelity make them specially suitable as watchdogs or guardians. The Landseer Newfoundland is a black and white variety brought into notice by Sir Edwin Landseer, but the exact ancestry of which is unknown. The Labrador Newfoundland is a smaller black variety with a less massive head. It occurs both in Newfoundland and England, and has been used largely in producing crosses, being almost certainly one parent of the retriever.

The St Bernard is a large breed taking its name from the monastery of Mount St Bernard in the Alps, and remarkable for high intelligence and use in rescuing travellers from the snow. The origin of the breed is unknown, but undoubtedly it is closely related to spaniels. The St Bernard attains as great a size as that of any other breed, a fine specimen being between 60 and 70 in. from the tip of the nose to the root of the tail. The colour varies, but shades of tawny-red and white are more frequent than in Newfoundlands. In the rough-haired breed the coat is long and wavy, but there exists a smooth breed with a nearly smooth coat.

Hounds.—These are large dogs, hunting by smell, with massive structure, large drooping ears, and usually smooth coats, without fringes of hair on the ears, limbs or tail. The bloodhound is probably the stock from which all the English races of hounds have been derived. The chief character is the magnificent head, narrow and dome-like between the huge pendulous ears, and with transverse puckers on the forehead and between the eyes. The prevailing colour is tan with large black spots. Bloodhounds, or, as they are sometimes termed, sleuthhounds, have been employed since the time of the Romans in pursuing and hunting down human beings, and a small variety, known as the Cuban bloodhound, probably of Spanish origin, was used to track fugitive negroes in slaveholding times. Bloodhounds quest slowly and carefully, and when they lose the scent cast backwards until they recover the original trail and make a fresh attempt to follow it.

Staghounds are close derivatives of the bloodhound, and formerly occurred in England in two strains, known respectively as the northern and southern hounds. Both breeds were large and heavy, with pendulous ears and thick throats with dewlaps. These strains seem to be now extinct, having been replaced by foxhounds, a large variety of which is employed in stag-hunting.

The modern English foxhound has been bred from the old northern and southern hounds, and is more lightly built, having been bred for speed and endurance. The favourite and most common colour is black-white-and-tan. The ears are usually artificially clipped so as to present a rounded lower margin. Their dash and vigour in the chase is much greater than that of the bloodhound, foxhounds casting forwards when they have lost the trail.

Harriers are a smaller breed of foxhounds, distinguished by their pointed ears, as it is not the custom to trim these. They are used in the pursuit of hares, and, although they are capable of very fast runs, have less endurance than foxhounds, and follow the trail with more care and deliberation.

Otterhounds are thick, woolly harriers with oily underfur. They are savage and quarrelsome, but are naturally excellent water-dogs.

Beagles are small foxhounds with long bodies and short limbs. They have a full bell-like cry and great cunning and perseverance in the tracking of hares and rabbits. They are relatively slow, and are followed on foot.

Turnspits were a small, hound-like race of dogs with long bodies, pendulous ears, out-turned feet and generally black-and-tan coloration. They were employed as animated roasting jacks, turning round and round the wire cage in which they were confined, but with the employment of mechanical jacks their use ceased and the race appears to be extinct.

Basset hounds are long and crooked-legged dogs, with pendulous ears. They appear to have been produced in Normandy and the Vendée, where they were employed for sporting purposes, and originally were no very definite breed. In comparatively recent times they have been adopted by English fanciers, and a definite strain with special points has been produced.

The dachshund, or badger hound, is of German origin, and like the basset hound was originally an elongated distorted hound with crooked legs, employed in baiting and hunting badgers, but now greatly improved and made more definite by the arts of the breeder. The colour is generally black-and-tan or brownish, the body is extremely long and cylindrical; the ears are large and pendulous, the legs broad, thick and twisted, with everted paws. The coat is short, thick and silky, and the tail is long and tapering.

The pointers, of which there are breeds slightly differing in most European countries, are descendants of the foxhound which have been taught to follow game by general body scent, not by tracking, nose to the ground, the traces left by the feet of the quarry, and, on approaching within sight of the game, to stand rigid, "pointing" in its direction. The general shape is like that of the foxhound, but the build is lighter and better knit, and the coat is soft, whilst white and spotted colorations are preferred. Pointers are employed to mark game for guns, and are especially useful in low cover such as that afforded by turnip fields.

The Dalmatian or coach dog (sometimes called the plum-pudding dog) is a lightly built pointer, distinguished by its spotted coloration, consisting of evenly disposed circular black spots on a white ground. The original breed is said to have been used as a pointer in the country from which it takes its name, but has been much modified by the fancier's art, and almost certainly the original strain has been crossed with bull-terriers.

Mastiffs are powerful, heavily built dogs, with short muzzles, frequently protruding lower jaws, skulls raised above the eyes, ears erect or pendulous, pendulous upper lips, short coats and thin tails. The English mastiff is a huge and powerful dog with pendent ears but short and silky coat. Fawn and brindle are the colours preferred. The Tibetan mastiff is equally powerful, but has still larger pendent ears, a shaggy coat and a long brush-like tail. Mastiffs are employed for fighting or as watchdogs, and for the most part are of uncertain temper and not high intelligence.

The bulldog is a small, compact but extremely heavily built animal of great strength, vigour and tenacity. The lower jaw should be strongly protruding, the ears should be small and erect, the forehead deeply wrinkled with an indentation between the eyes, known as the "stop." The coat should be thick, short and very silky, the favourite colours being white and white marked with brindle. Bulldogs were formerly employed in bull-baiting, and the tenacity of their grip is proverbial. Their ferocious appearance, and not infrequently the habits of their owners, have given this breed a reputation for ferocity and low intelligence. As puppies, however, bulldogs are highly intelligent and unusually docile and affectionate, and if well trained retain throughout life an unusual sweetness of disposition, the universal friendliness of which makes them of little use as guardians.

The German boarhound is one of the largest races of dogs, originally used in Germany and Denmark for hunting boars or deer, but now employed chiefly as watchdogs. The build is rather slighter than that of the English mastiff, and the ears are small and carried erect.

The Great Dane is somewhat similar in general character, but is still more gracefully built, with slender limbs and more pointed muzzle. The ears, naturally pendent at the tips, are always cropped. It is probable that the strain contains greyhound blood.

The bull-terrier, as its name implies, is a cross between the bulldog and the smooth terrier. It is a clever, agile and powerful dog, extremely pugnacious in disposition.

The pugdog is a dwarf race, probably of mastiff origin, and kept solely as a pet. The Chinese pug is slender legged, with long hair and a bushy tail.

Terriers are small dogs of agile and light build, short muzzles, and very highly arched skulls. The brains are large, and the intelligence and educability extraordinarily high. The number of breeds is very large, the two extreme types being the smooth fox-terrier with compact shape, relatively long legs, and the long-bodied, short-legged Skye terrier, with long hair and pendent ears.

All the well-known breeds of dogs are highly artificial and their maintenance requires the constant care of the breeder in mating, and in rejecting aberrant progeny. The frequency with which even the most highly cultivated strains produce degenerate offspring is notorious, and is probably the reason for the profound belief in telegraphic action asserted by most breeders. When amongst the litter of a properly mated, highly bred fox-terrier, pups are found with long bodies and thick short legs and feet, breeders are disposed to excuse the result by the supposition that the bitch has been contaminated by some earlier mating. There is ample evidence, however, that such departures from type are equally frequent when there was no possibility of earlier mismating (see TELEGONY).

Glossary of Points of the Dog.

Apple Head. A rounded head, instead of flat on top.
Blaze. A white mark up the face.
Brisket. The part of body in front of the chest.
Brush. The tail, usually applied to sheepdogs.
Butterfly Nose. A spotted nose.
Button Ear. Where the tip falls over and covers the orifice.
Cat Foot. A short round foot, knuckles high and well developed.

Cheeky. When the cheek bumps are strongly defined.

Chest. Underneath a dog from brisket to belly.

Chops. The pendulous lip of the bulldog.

Cobby. Well ribbed up, short and compact in proportion.

Couplings. Space between tops of shoulder blades and tops of hip joints.

Cow Hocks. Hocks that turn in.

Dew Claw. Extra claw, found occasionally on all breeds.

Deuclap. Pendulous skin under the throat.

Dish Faced. When nose is higher than muzzle at the stop.

Dudley Nose. A yellow or flesh-coloured nose.

Elbow. The joint at the top of the forearm.

Feather. The hair at the back of the legs and under the tail.

Flag. A term for the tail, applied to a setter.

Flaws. The pendulous lips of the bloodhound and other breeds.

Forearm. Part of foreleg extending from elbow to pastern.

Frill. A mass of hair on the chest, especially on collies.

Hare Foot. A long narrow foot, carried forward.

Haw. Red inside eyelid, shown in bloodhounds and St Bernards.

Height. Measured at the shoulder, bending head gently down.

Hocks. The hock joints.

Hucklebones. Tops of the hip joints.

Knee. The joint attaching fore-pastern and forearm.

Leather. The skin of the ear.

Occiput. The projecting bone or bump at the back of the head.

Overshot. The upper teeth projecting beyond the under.

Pastern. Lowest section of leg, below the knee or hock.

Pig Jaw. Exaggeration of overshot.

Pily. A term applied to soft coat.

Rose Ear. Where the tip of ear turns back, showing interior.

Septum. The division between the nostrils.

Smudge Nose. A nose which is not wholly black, but not spotted.

Stiffes. The top joints of the hind legs.

Stop. The indentation below the eyes, most prominent in bulldogs.

Tulip Ear. An erect or pricked ear.

Undershot. The lower teeth projecting in front of the upper ones.

(W. B.; P. C. M.)

DOGE (a modified form of the Ital. *duca*, Lat. *dux*, a leader, or duke), the title of the chief magistrate in the extinct republics of Venice and Genoa.

In Venice the office of doge was first instituted about 700. John the Deacon, referring to this incident in his *Chronicon Venetum*, written about 1000, says "all the Venetian cities (*omnes Venetiae*) determined that it would be more honourable henceforth to be under dukes than under tribunes." The result was that the several tribunes were replaced by a single official who was called a doge and who became the head of the whole state. The first doge was Paolo Lucio Anafesto, and some authorities think that the early doges were subject to the authority of the emperors of Constantinople, but in any case this subordination was of short duration. The doge held office for life and was regarded as the ecclesiastical, the civil and the military chief; his duties and prerogatives were not defined with precision and the limits of his ability and ambition were practically the limits of his power. About 800 his independence was slightly diminished by the appointment of two assistants for judicial work, but these officers soon fell into the background and the doge acquired a greater and more irresponsible authority. Concurrently with this process the position was entrusted to members of one or other of the powerful Venetian families, while several doges associated a son with themselves in the dual office. Matters reached a climax after the fall of the Orseolo family in 1026. In 1033, during the dogeship of Dominico Flabianico, this tendency towards a hereditary despotism was checked by a law which decreed that no doge had the right to associate any member of his family with himself in his office, or to name his successor. It was probably at this time also that two councillors were appointed to advise the doge, who must, moreover, invite the aid of prominent citizens when discussing important matters of state. In 1172 a still more important change was introduced. The dual councillors were increased in number from two to six; universal suffrage, which theoretically still existed, was replaced by a system which entrusted the election of the doge to a committee of eleven, who were chosen by a great council of 480 members, the great council being nominated annually by twelve persons. When a new doge was chosen he was presented to the people with the formula "this is your doge, if it please you." Nominally the citizens confirmed the election, thus maintaining as a constitutional fiction the right of the whole people to choose their chief magistrate. Five years

later this committee of eleven gave way to a committee of forty who were chosen by four persons selected by the great council. After the abdication of Doge Pietro Ziani in 1229 two commissions were appointed which obtained a permanent place in the constitution and which gave emphatic testimony to the fact that the doge was merely the highest servant of the community. The first of these commissions consisted of five *Correttori della promissione ducale*, whose duty was to consider if any change ought to be made in the terms of the oath of investiture (*promissione*) administered to each incoming doge, this oath, which was prepared by three officials, being a potent factor in limiting the powers of the doge. The second commission consisted of three *inquisitori sopra il doge defunto*, their business being to examine and pass judgment upon the acts of a deceased doge, whose estate was liable to be mulcted in accordance with their decision. In consequence of a tie at the election of 1229 the number of electors was increased from forty to forty-one. The official income of the doge was never large, and from early times many holders of the office were engaged in trading ventures. One of the principal duties of the doge was to celebrate the symbolic marriage of Venice with the sea. This was done by casting a precious ring from the state ship, the "Bucentaur," into the Adriatic. In its earlier form this ceremony was instituted to commemorate the conquest of Dalmatia by Doge Pietro Orseolo II. in 1000, and was celebrated on Ascension day. It took its later and more magnificent form after the visit of Pope Alexander III. and the emperor Frederick I. to Venice in 1177.

New regulations for the elections of the doge were introduced in 1268, and, with some modifications, these remained in force until the end of the republic. Their object was to minimize as far as possible the influence of the individual families, and this was effected by a very complex machinery. Thirty members of the great council, chosen by lot, were reduced, again by lot, to nine; the nine chose forty and the forty were reduced by lot to twelve, who chose twenty-five. The twenty-five were reduced by lot to nine and the nine elected forty-five. Then the forty-five were reduced by lot to eleven, and the eleven chose the forty-one, who actually elected the doge. As the oligarchical element in the constitution developed, the more important functions of the ducal office were assigned to other officials, or to administrative boards, and he who had once been the pilot of the ship became little more than an animated figurehead, properly draped and garnished. On state occasions he was surrounded by an increasing amount of ceremonial, and in international relations he had the status of a sovereign prince of the first rank. But he was under the strictest surveillance. He must wait for the presence of other officials before opening despatches from foreign powers; he was forbidden to leave the city and was not allowed to possess any property in a foreign land. To quote H. F. Brown, "his pomp was splendid, his power limited; he appears as a symbol rather than as a factor in the constitution, the outward and visible sign of the impersonal oligarchy." The office, however, was maintained until the closing days of the republic, and from time to time it was held by men who were able to make it something more than a sonorous title. The last doge was Lodovico Manin, who abdicated in May 1797, when Venice passed under the power of Napoleon.

In Genoa the institution of the doge dates from 1339. At first he was elected without restriction and by popular suffrage, holding office for life; but after the reform effected by Andrea Doria in 1528 the term of his office was reduced to two years. At the same time plebeians were declared ineligible, and the appointment of the doge was entrusted to the members of the great and the little councils, who employed for this purpose a machinery almost as complex as that of the later Venetians. The Napoleonic Wars put an end to the office of doge at Genoa.

See Cecchetti, *Il Doge di Venezia* (1864); Musatti, *Storia della promissione ducale* (Padua, 1888); and H. F. Brown, *Venice: a Historical Sketch* (1893).

DOG-FISH, a name applied to several species of the smaller sharks, and given in common with such names as hound and beagle, owing to the habit these fishes have of pursuing or hunt-

ing their prey in packs. The small-spotted dog-fish or rough hound (*Scyllium canicula*) and the large-spotted or nurse hound (*Scyllium catulus*) are also known as ground-sharks. They keep near the sea bottom, feeding chiefly on the smaller fishes and Crustacea, and causing great annoyance to the fishermen by the readiness with which they take bait. They differ from the majority of sharks, and resemble the rays in being oviparous. The eggs are enclosed in semi-transparent horny cases, known on the British coasts as "mermaids' purses," and these have tendril-like prolongations from each of the four corners, by means of which they are moored to sea-weed or some other fixed object near the shore, until the young dog-fish is ready to make its exit. The larger of these species attains a length of 4 to 5 ft., the smaller rarely more than 30 in. The picked dog-fish (*Acanthias vulgaris*, formerly known as *Squalus acanthias*) is pre-eminently the dog-fish. It is the most abundant of the British sharks, and occurs in the temperate seas of both northern, and southern hemispheres. It attains a length of 4 ft., but the usual length is 2 to 3 ft., the female, as in most sharks, being larger than the male. The body is round and tapering, the snout projects, and the mouth is placed ventrally some distance from the end of the snout. There are two dorsal fins, each of which is armed on its anterior edge with a sharp and slightly curved spine, hence its name "picked." This species is viviparous, the female producing five to nine young at a birth; the young when born are 9 to 10 in. long and quite similar to the parents in all respects except size. It is gregarious, and is abundant at all seasons everywhere on the British coasts. In 1858 an enormous shoal of dog-fish, many square miles in extent, appeared in the north of Scotland, when, says J. Couch, "they were to be found floating in myriads on the surface of every harbour." They are the special enemies of the fisherman, injuring his nets, removing the hooks from his lines, and spoiling his fish for the market by biting pieces out of them as they hang on his lines. They are however eaten, both fresh and salted, by fishermen, especially on the west coast of England, and they are sold regularly in the French markets.

DOGGER BANK, an extensive shoal in the North Sea, about 60 m. E. of the coast of Northumberland, England. Over its most elevated parts there is a depth of only about six fathoms, but the depth is generally from ten to twenty fathoms. It is well known as a fishing ground. The origin of the name is obscure; but the middle Dutch *dogger* signifies a trawling vessel, and was formerly applied generally to the two-masted type of vessel employed in the North Sea fisheries, and also to their crews (doggermen) and the fish taken (dogger-fish). Off the south end of the bank an engagement took place between English and Dutch fleets in 1781. On the night of the 21st of October 1904 during the Russo-Japanese War, some British trawlers of the Hull fishing fleet were fired upon by vessels of the Russian Baltic fleet under Admiral Rozhdestvensky on its voyage to the Far East, one trawler being sunk, other boats injured, two men killed and six wounded. This incident created an acute crisis in the relations between Russia and England for several days, the Russian version being that they had seen Japanese torpedo-boats, but on the 28th Mr Balfour, the English prime minister, announced that the tsar had expressed regret and that an international commission would investigate the facts with a view to the punishment of any responsible parties. The terms were settled on 25th November, the commission being composed of five officers (British, Russian, American and French, and one selected by them), to meet in Paris. On the 22nd of December the four original members, Vice-admiral Sir Lewis Beaumont, Vice-admiral Kaznakov (afterwards replaced by Vice-admiral Dubassov), Rear-admiral Davis and Vice-admiral Fournier, met and chose Admiral Baron von Spaun (Austria-Hungary) as the fifth. Their report was issued on the 25th of February 1905. While recognizing that the information received as to a possible attack led the admiral to mistake the trawlers for the enemy, the majority of the commissioners held Rozhdestvensky responsible for the firing and its results, and "being of opinion that there were no torpedo-boats either among the trawlers nor anywhere near" concluded that "the opening of fire was not justifiable," though they absolved him and his squadron from

discredit either to their "military qualities" or their "humanity." The affair ended in compensation being paid by the Russian government.

DOGGETT (or **DOGGET**), **THOMAS** (d. 1721), English actor, was born in Dublin, and made his first appearance in London in 1691 as Nincompoop in D'Urfley's *Love for Money*. In this part, and as Solon in the same author's *Marriage-hater matched*, he gained the favour of the public. He followed Betterton to Lincoln's Inn Fields, creating the part of Ben, especially written for him, in Congreve's *Love for Love*, with which the theatre opened (1695); and next year played Young Hobb in his own *The Country Wake*. He was associated with Cibber and others in the management of the Haymarket and Drury Lane, and he continued to play comedy parts at the former until his retirement in 1713. Doggett is highly spoken of by his contemporaries, both as an actor and as a man, and is frequently referred to in *The Teller* and *Spectator*. It was he who in 1715 founded the prize of "Doggett's Coat and Badge" in honour of the house of Hanover, "in commemoration of his Majesty King George's happy Accession to the British Throne." The prize was a red coat with a large silver badge on the arm, bearing the white horse of Hanover, and the race had to be rowed annually on the 1st of August on the Thames, by six young watermen who were not to have exceeded the time of their apprenticeship by twelve months. Although the first contest took place in 1715, the names of the winners have only been preserved since 1791. The race is still rowed each year, but under modified conditions.

See *Thomas Doggett, Deceased* (London, 1908).

DOGMA (Gr. *δῶγμα*, from *δοκέω*, to seem; literally "that which seems, sc. good or true or useful" to any one), a term which has passed through many senses both general and technical, and is now chiefly used in theology. In Greek constitutional history the decision of—"that which seemed good to"—an assembly was called a *δῶγμα* (i.e. decree), and throughout its history the word has generally implied a decision, or body of decisions or opinions, officially adopted and regarded by those who make it as possessing authority. As a technical term in theology, it has various shades of meaning according to the degree of authority which is postulated and the nature of the evidence on which it is based. Thus it has been used broadly of all theological doctrines, and also in a narrower sense of fundamental beliefs only, confession of which is insisted upon as a term of church communion. By sceptics the word "dogma" is generally used contemptuously, for an opinion grounded not upon evidence but upon assertion; and this attitude is so far justified from the purely empirical standpoint that theological dogmas deal with subjects which, by their very nature, are not susceptible of demonstration by the methods of physical science. Again, popularly, an unproved *ex cathedra* statement of any kind is called "dogmatic," with perhaps an insinuation that it is being obstinately adhered to without, or beyond, or in defiance of, obtainable evidence. But again to "dogmatize" may mean simply to assert, instead of hesitating or suspending judgment.

Three pre-Christian or extra-ecclesiastical usages are recorded by a half-heretical churchman, Marcellus of Ancyra (in Eusebius of Caesarea, *Contra Marcellum*, i. 4):—words which Adolf Harnack has placed on the title-page of his larger *History of Dogma*. First there is a medical usage—empirical *versus* dogmatic medicine. On this old-world technical controversy we need not dwell. Secondly, there is a philosophical usage (e.g. Cicero, Seneca and others). First principles—speculative or practical—are *δῶγματα*, Lat. *decreta*, *scia* or *placita*. The strongest statement regarding the inviolability of such dogmas is in Cicero's *Academics*, ii. chap. 9. But we have to remember that this is dialogue; that the speaker, Hortensius, represents a more dogmatic type of opinion than Cicero's own; that it is the maxims of "wisdom," not of any special school, which are described as unchangeable.¹ Marcellus's third type of dogma is

¹ Sextus Empiricus (c. A. D. 240) denounces all forms of dogmatism, even perhaps the scepticism of definite denial. Blaise Pascal and Immanuel Kant, among others, have Sextus's grouping in mind when they oppose themselves to "dogmatism" and "scepticism"

legal or political, the decree (says Marcellus) of the legislative assembly; but it might also be of the emperor (Luke ii. 1; Acts xvii. 7), or of a church gathering (Acts xvi. 4), or of Old Testament law; so especially in Philo the Jew, and in Flavius Josephus (even perhaps at *Contra Apionem*, i. 8).

While the New Testament knows only the political usage of *δῶγμα*, the Greek Fathers follow one which is more in keeping with philosophical tradition. With few and early exceptions, such as we may note in the Epistle of Barnabas, chap. i., they confine the word to doctrine.

Greek Fathers.

Either dogma (sing.) or dogmas (plural) may be spoken of. Actually, as J. B. Lightfoot points out, the best Greek commentators among the Fathers are so dominated by this new usage, that they misinterpret Col. ii. 14 (20) and Eph. ii. 15 of Christian doctrines. Along with this goes the fundamental Catholic view of "dogmatic faith"—the expression is as old as Cyril of Jerusalem (died 386), if not older—according to which it consists in obedient assent to the voice of authority. All doctrines are "dogmas" to the Greek Fathers, not simply the central teachings of their system, as with the philosophers. Very noteworthy is Cyril of Jerusalem's fourth *Catechetical Discourse* on the "Ten Dogmas" (we might render "Ten Great Doctrines"). The figure ten may be taken from the commandments,² as in Gregory Nazianzen's later, and more incidental, decalogue of belief. In any case, Cyril marks out the way for the subsequent division of the creed into twelve or fourteen "articles" or heads of belief (see below). In saying that all doctrines rank as "dogmas" during the Greek period, we ought to add a qualification. They do so, in so far as they are held to be of authority. Clement of Alexandria or Origen would not call his speculations dogmas. Yet these audacious spirits start from a basis of authority, and insist upon *ὁρθότητα δογματων* (*Stromata*, vii. 763). The "dogma" or "dogmas" of heretics are frequently mentioned by orthodox writers. There can be no question of confining even orthodox "dogma" to conciliar decisions in an age when definition is so incomplete; still, we do meet with references to the Nicene "dogma" (e.g. letter in Theodoret, *H.E.* ii. 15). But dogma is not yet technical for what is Christian or churchly. The word which emerges in Greek for that purpose is "orthodox," "orthodoxy," as in John of Damascus (d. 760), or as in the official title still claimed by the Holy Orthodox Church of the East.

Latin Fathers borrow the word "dogma," though sparingly, and employ it in all the Greek usages. Something novel is added by Jerome's phrase (in the *De viris illustribus*, cc. xxxi., cix.) *ecclesiastica dogmata*,—found again in the title of the treatise now generally ascribed to Gennadius, and occurring once more in another writer of southern Gaul.³ The phrase is a serviceable one, contrasting church teachings with heretical "dogmas." But the main Latin use of dogma in patristic times is found in Vincent of Lerins (d. c. 450) in his brief but influential *Commonitorium*; again from southern Gaul. Thereafter the usage gradually drops. In the Thomas Aquinas⁴ it does not once occur. On the other hand Thomas has his own technical name—doctrine (sing.) or rather *sacra doctrina*; and this expression holds its ground, though the usage of Abelard, *Theologia*, was destined to an even more important place (see THEOLOGY). Another medieval usage of importance is the division of the creed into twelve articles corresponding to the number of the apostles, who, according to a legend already found in Rufinus (d. 410) *On the Apostles' Creed*, composed that formula by contributing each a single sentence.

Latin Fathers.

Medieval usages.

alike. A new shade of condemnation for dogmas as things merely assumed comes to be noticeable here, especially in Kant.

² But there is a variant reading—eleven—supported by a different arrangement.

³ Quoted by C. H. Turner in *Journal of Theol. Studies* (Oct. 1906, and Cf. Oct. 1905). G. Elmenhorst's statement, that Musanus and Didymus in an earlier age wrote treatises with the name *De ecclesiasticis dogmatibus*, seems a plain blunder, if we compare Jerome's Latin with Eusebius's Greek.

⁴ "So videtur bekant"—J. B. Heinrich, "Dogma," in Wetzlar and Welte's (Catholic) *Kirchenlexikon*.

The division is found applied also to the "Nicene-Constantinopolitan" creed, both in East and West. Sometimes fourteen articles are detected (in either creed), 7+7; the sacred number twice over.¹

The Reformation set up a new idea of faith, or recurred to one of the oldest of all. Faith was not belief in authoritative teachings; it was trust in the promises of God and in Jesus Christ as their fulfilment. But the Protestant view was apt to seem intangible, and the influence of the learned tradition was strong—for a time, indeed, doctrine was more cultivated among Protestants than in the Church of Rome. The result was a structure which is well named the Protestant scholasticism. The new view of faith is bracketed with the old, and practically neutralized by it; as was already the case in Melancthon's theological definitions in the 1552-1553 edition of *Loci Communes*, also printed in other works by him. This brings back again the Catholic view of "dogmatic faith."

The word "article" for a time holds the field. Pope Leo X. in 1520 condemns among other propositions of Martin Luther's *Articles* the twenty-seventh—"Certum est in manu Papae, aut ecclesiae, prorsus non esse statuere articulos fidei (simo nec leges morum seu bonorum operum)." The Augsburg Confession (1530) is divided into numerous "articles," while Luther's Lesser Catechism gathers Christianity under three "articles"—Creation, Redemption, Sanctification. Where moderns would speak of the "doctrine" of this or that, Lutherans especially, but also churchmen of other communions, wrote upon this or that "article." Nikolaus Hunnius (*doctores*, &c., 1626), A. Quenstedt (c. 1685) and others—in a controversial interest, to blacken the Calvinists still more—distinguished which articles were "fundamental." Modern Lutheranism (G. Thomasius, *Dogmengeschichte*, 1874-1876, influenced by T. F. D. Kliefoth 1850) speaks rather of "central dogmas";² and the Roman Catholic J. B. Heinrich³ is willing to speak of "fundamental dogmas," those which must be known for salvation; those for which "implicit" faith does not suffice. When Addis and Arnold's *Catholic Dictionary* denounces the conception of central dogmas, what they desire to exclude as uncatholic is the belief that dogmas lying upon the circumference may be questioned or perhaps denied.⁴ This suggests the great ambiguity both in Roman Catholic and Protestant writers of the 17th century as to the relation between "articles" and "dogmas." Many writers in each communion felt that an "article" is a higher thing. Others, in each communion, made the identification absolute. Perhaps the Roman theologians of that age were more concerned than the Protestants to draw a line round necessary truths. This attempt was made by Dr Henry Holden (*Div. Fidei Analysis*, 1652) in connexion with the word "articles."⁵

Another term to be considered is *decretum*, the old Latin equivalent for *δῶγμα*. Another of Luther's assertions branded *decreta* by the pope in 1520—the twenty-ninth—claimed liberty *judicandi conciliorum decreta*. On the other hand, the Augsburg Confession protests its loyalty to the *decretum* of Nice. What Protestantism saw in the distant past, Trent naturally recognized in the present. Every one of its own findings is a *decretum*—except five, among the sacramental chapters, each of which is headed *doctrina*. Holden again quotes the (indefinite) *decretum* of the Council of Basel regarding the Immaculate Conception.

The word "dogma" was however to revive, and, with more or less success, to differentiate itself from "doctrine." Early writers of the modern period, Protestant or Roman Catholic, use

¹ See G. Hoffmann, *Fides implicita*, vol. i. (1903), pp. 82, &c.; and cf. the 17th-century creed of Bishop Mogilas adopted by the whole Greek Church.

² A. Schweizer's *Protestant Central Dogmas* (1854-1856) was an historical study of Reformed, i.e. Calvinist-Zwinglian theology.

³ "Dogma," &c., in Wetzler and Welte's *Kirchenlexikon*.

⁴ The distinction of pure and mixed articles—those of revelation and those taught in common by revelation and natural theology—reappears in modern Roman Catholic theology as a distinction between pure and mixed *dogmas*.

⁵ Luther's Schmalkalden Articles and the Thirty-Nine Articles of the Church of England should also be mentioned.

it frequently of heretics; thus the Augsburg Confession protests that the Protestants have carefully avoided *nova dogmata*. A Roman Catholic writer, Jan Driedo of Louvain, revives the reference to *Ecclesiasticis scripturis et dogmatibus* (1533)—using the word, though not exclusively yet emphatically, of teachings *extra canonem scripturae sacrae*. Philip Melancthon's preface to his *Loci communes* (ed. 1535) protests that he has not expressed himself *de ullo dogmate*—on any point of doctrine—without careful consideration of what has been said before him. Richard Hooker (d. 1600) in bk. viii. of *Ecc. Polity* (pub. 1648 or perhaps 1651) quotes Thomas Stapleton, of the Roman Catholic (*De principis doctrinalibus fidei*, 1579), on the royal right or duty to enforce "dogmas," and adds a gloss of his own—"very articles of the faith,"—a surprising and probably isolated usage. Many identified Dogmas and Articles by levelling down or broadening out; but Hooker levels up. The statement of the Council of Trent (1545-1562) is quoted here. The Council will rely chiefly upon Scripture⁶ in reforming *dogmatibus et instaurandis in ecclesia moribus*; the Roman reply to the two sets of *articuli* of Augsburg, and the Roman counterpart to the (later) Protestant assertion that the Bible⁷ is the "only rule of faith and practice." At Trent, therefore, once more, dogma means doctrine. It still means "doctrine" when the collected *decreta* of Trent bear on their title-page (1564) reference to an *Index dogmatum et reformationis*; but here "dogma" is already verging towards the narrower and more precise sense—truth defined by church authority. In other words, it is already edging away from its identification with (all or any) doctrines. On the Protestant side the identity is still clear in the Lutheran Formula of Concord (1577). This creed formulates its relation to Scripture over and over, as the one *regula* by which all *dogmata* are to be tried. That characteristic Protestant assertion had been still earlier pushed to the front in "Reformed" creeds, e.g. the First Helvetic Confession (1536), and more notably in the Second (1566).

Protestant creeds had clearly affirmed that *nothing possessed authority which was not in Scripture*: in a short time, Protestant theologians—following an impulse common to all Christian communions—define more sharply the identity of what is authoritative with the letter of Scripture, and call these entire contents *dogmas*. Here then, under Protestant scholasticism (Lutheran and Reformed), we have the first perfectly definite conception of dogma, and the most definite ever reached. Dogma is the whole text of the Bible, doctrinal, historical, scientific, or what not. Thus dogma is revealed and is infallibly true. Dogma is doctrine, viz. that body of doctrines and related facts which God Himself has propounded for dogmatic faith. Every true dogma, says Johann Gerhard⁸—the most representative figure of Lutheran scholasticism—occurs in plain terms somewhere in Scripture.

Over against these sweeping assumptions and deductions, the Roman Catholic Church had to build up its own statement of the basis of belief. Its early controversialists—like Driedo or Cardinal Bellarmine—meet assertions such as Gerhard's with a flat denial. The great dogmas are not, literally and verbally, in the Bible. Along with the Bible we must accept unwritten traditions; the Council of Trent makes this perfectly clear. But not any and every tradition; only such as the church stamps with her approval. And that raises the question whether the church has not a further part to play? A. M. Fairbairn holds that D. Petavius's great work *De theologicis dogmatibus* (especially the 1st vol., 1644) made the word "dogma" current for *doctrines which were authoritative as formulated by the church*. We must keep in mind, however, that the question is not simply one as to the meaning of a word. The equation holds, more firmly than ever; dogma = the contents of

⁶ That seems to be what is meant.

⁷ Early Protestantism lived too much in the thought of justification to mark out the boundaries of creed with this scholastic precision.

⁸ *Loci communes* (1610-1622), on Interpretation of Sacred Scripture, ix. 149.

faith. It has to be established on the Roman Catholic side that faith (or dogmas; the two are inseparable) deals with divine truths historically revealed long ago but now administered with authority, according to God's will, by the church. The Englishman Henry Holden (see above), the Frenchman Veronius (François Veron, S.J., 1575-1649) in his *Règle générale de la foy catholique* (1652), the German Philipp Neri Chrismann,¹ in his *Regula fidei catholice et collectio dogmatum credendorum* (1792),² all work at this task. Dogmas or articles of faith (taken as synonymous) depend upon revelation in Scripture or tradition, as confirmed by the church whether acting in general councils or through the pope (in some undefined way; Holden)—in general councils or by universal consent (Chrismann; of bishops? the definite Gallican theory?). Veronius is willing to waive the difficult point of church infallibility as the Council of Trent did not define it. Holden insists strongly upon infallibility. Church traditions are infallible; and church dogmas reach us (from the original revelation) through an infallible medium, the Catholic Church, which the Protestants sadly lack. In Chrismann the word "dogma" has superseded the word "article"; Holden uses both, though "article" has the preponderance. All three writers seek to draw a sharp line round what is "of faith." Hence in Chrismann (who is in other respects the most definite of the three) we have a view of dogma almost as clear-cut as that of the Protestant schoolmen. Dogmas are *revealed*; dogmas are *infallible*; the church is infallible on dogmas (for this statement he cites Muratori) and on nothing else.

This whole period of theology, Protestant and Roman Catholic, is statical. Men are defining and protecting the positions they have inherited; they do not think of progress. And yet the Roman Catholic Church had upon its hands one great unsettled question—the thesis of the Immaculate Conception of the Virgin. This became the standing type of an assertion which, while favoured by the church and on the very verge of dogma, was yet not a dogma³—till the definition came through Pius IX. in 1854. Here then the frontier of dogma had unquestionably moved forward. Its conception must become dynamic; there was need of some theory of development like J. H. Newman's (1845). It does not happen, however, that the papal definition of 1854 employs the word "dogma"; that honour was withheld from the word until the Vatican decrees of 1870 affirmed the personal infallibility of the pope as *divinitus revelatum dogma*. With this, one line of tendency in Roman Catholic doctrine reached its climax; the pope and the council use "dogma" in a distinctive sense for what is definitely formulated by authority. But there is another line of tendency. The same council defines not indeed dogma but faith—inseparable from dogma—as⁴ (1) revealed, (a) in Scripture or (b) in unwritten tradition, and (2) taught by the church, (a) in formulated decrees, or (b) in her ordinary *magisterium*. This is a correction of Chrismann. Not only does the correction involve the substitution of papal authority for a universal consent of "pastors" and "the faithful"; it also deliberately ranks the unformulated teachings of the church on points of doctrine as no less *de fide* than those formulated. This amounts to a serious warning against trying to draw a definite line round dogma. The modern Roman Catholic temper must be eager to believe and eager to submit. New dogmas have been precipitated more than once during the 19th century; there may still be others held in solution in the church's teaching. If so, these are likely one day to crystallize into full dogmas; and, even while not yet "declared," they have the same claim upon faith.

Thus there seems to be a measure of uncertainty as to what the Church of Rome now calls "dogma"—only in part relieved by

¹ Three writers mentioned in Wetzler's and Welte's *Kirchenlexikon*. Also quoted as having appeared 1745, but that is an error; he quotes F. A. Blau, *On the Rule of Faith* (Mainz, 1780). See further the sketch of Chrismann in *Allgemeine deutsche Biographie*, supplement.

² G. Perrone, e.g. *De immaculato B. V. Mariæ conceptu; an dogmatico decreto definiti possit?* (1847).

³ These divisions and subdivisions are not numbered in the Decrees, as for clearness they have been numbered above.

the distinction between "dogmas strictly" and mere "dogmatic truths." Again, the assertion that the church is infallible upon some questions, not belonging to the area of revelation (properly so-called in Roman Catholic theology), destroys the identification of "dogmas" with "infallible certainties" which we noted both in the Protestant schoolmen and in Chrismann. The identification of dogma with revelation remains, with another distinction in support of it, between "material dogmas" (all scriptural or traditional truth) and "formal" or ecclesiastically formulated dogmas.⁵ On the other hand, there is absolute certainty on a point long disputed. Questions about church authority are henceforth questions about the pope's authority. What he calls heresy, under the sanction of excommunication or that more formal excommunication known as anathema, is heresy. What he finds it necessary to condemn even in milder terms as bad doctrine is infallibly condemned; that is certain, Roman Catholic theologians tell us, though not *yet de fide*.

Finally we have to glance at a new list of definitions which perhaps in some cases seek more or less to formulate modern Protestant ideas, but which in general represent rather the world of disinterested historical scholarship. That world of the learned offers us non-dogmatic definitions, drawn up from the outside; definitions which do not share the root assumptions either of Catholicism or of post-Reformation Protestant orthodoxy. It might have been best to surrender the term "dogma" to the dogmatists; but few scholars have consented to do so.

1. We may brush aside the view⁶ for which J. C. Döderlein, J. A. A. Tittmann, and more recently C. F. A. Kahnis are quoted. According to this definition, "dogma" means the opinion of some individual theologian of distinction. That might be a conceivable development of usage. It has been said that persons who dislike authority often show great devotion to "authorities"; and the word dogma might make a similar transition. But, in its case, such a usage would constitute a violent break with the past.

2. Though there is no formal definition in the passage, it is worth recording that, towards the end of his *Chief End of Revelation* (1881), A. B. Bruce sharply contrasts "dogmas of theology" with "doctrines of faith."⁷ While he manifests no wholesale dislike to doctrine, such as is seen in the Broad Church school, Bruce inverts the Catholic estimate. Dogma stands lowest, not highest. It seems hardly better than a *caput mortuum*, out of relation to the original faith or the original facts that are held to have given it birth. There is more than a touch of Matthew Arnold in this; though, while Arnold held nothing in religious experience beyond morality to be objectively genuine, Bruce believed in God's "gracious" purpose.⁸

3. Much more like Chrismann's view is the "generally accepted position" among Protestant scholars, as its leading representative to-day, F. Loofs, has called it;⁹ the doctrine enforced within any one church community is dogma. This definition is significant. It means that historians recognize the peculiar importance of those beliefs which are constitutive of church agreement; and it finds some support from the philosophical and political associations of ancient "dogma." Also Roman Catholic writers could accept the definition in so far as

⁵ Three zones apparently (1) the church's formal decrees, (2) the church's general teaching, (3) points of revelation which the church may not yet have overtaken. *Per contra*, much that was only "implicit" in the deposit of faith has become "explicit" in dogma. (The reader must note that "implicit" is used here in a different sense from that referred to earlier in this article. Here, church dogma has explicated what was implicit in revelation. There, the unlearned accept by *implication*, i.e. by a general acceptance of church belief and teaching, dogmas they perhaps have never heard of. Both usages are current in Roman Catholic theology.)

⁶ Or the view of D. Schenkel, that dogma is what is enforced by civil and criminal law.

⁷ Cf. also preface to 2nd ed. pp. ix, x.

⁸ Cf. pp. 279, 280; the undogmatic words of religious emotion are "thrown out," not at "a cloud mistaken for a mountain," but at a "majestic" and "veritable mountain range."

⁹ See art. "Dogmengeschichte" in Herzog-Hauck's *Realencycl. für prot. Theol.* Cf. also Prof. Loofs's *Leitfaden zum Studium der Dogmengeschichte*.

their own church's authoritative teachings are concerned. But can a *historian* separate the opinions which rose to authority in the church from the other opinions which succumbed? Or the accepted modifications of a theory from those which were rejected? Again, can we substitute church authority for that which is always the background of "dogma" as interpreted from inside—divine authority?¹ Or, again, can we say definitely which doctrines are "enforced" in Protestant communions and so are "dogmas"? It has even been asserted by A. Schweizer (*Christliche Glaubenslehre nach prot. Grundrissen*, 1863-1872) that Protestantism ought not to speak of dogmas at all, except as things of its imperfect past.² And historically it seems plain that—since the age of Protestant scholasticism—there has been nothing in Protestant church life with the name "dogma" can be assigned, without dropping a good deal of its original connotation. Dogma is no longer³ held to be of immediate divine authority. Hence Catholic, and scientific or historical, definitions of dogma are on different planes. They never properly meet.⁴

4. A. Harnack varies in his usage. He is not prepared to exclude the great medieval pronouncements, or the modern Roman Catholic definitions, from the list of dogmas; but on the whole he prefers to keep in view "one historical species"—Loofs suggests that he ought perhaps rather to say one *individual* type—that greatest group of Christian dogmas which "was created by the Greek spirit upon the soil of the gospel" (*Hist. of Dogma*, Eng. tr., vol. i, pp. 17, 21, 22). Thus Harnack agrees with Catholic theologians in holding that, in the fullest sense, there is no dogma except the Catholic. He differs, of course, in holding dogma to be obsolete now. While Protestants, he thinks, have undermined it by a deeper conception of faith,⁵ Roman Catholics have come to attach more value to obedience and "implicit belief" than to knowledge; and even the Eastern Church lives to-day by the cultus more than by the vision of supernatural truth. Again, Harnack gravely differs from Catholic dogmatists in assigning a historical origin to what in their view is essentially divine—supernatural in origin, supernatural even in its declaration by the church. If they do not deny that Greek philosophy has entered into Christian doctrine, they consider it a colourless medium used in fixing the contents of revelation. In all this, Harnack speaks from a point of view of his own. He is no friend of Catholicism or of dogma. Perhaps his detachment makes for clearness of thought; Loofs's friendliness towards dogma, but in a much humbler sense than the Catholic, involves the risk of confusion.

Both Loofs and Harnack contrast with "dogma" the work of individual thinkers, calling the latter "theology." Hence they and other authorities wish to see "History of Dogma" supplemented by "Histories of Theology." Our usual English phrase "History of Doctrine" ignores that distinction.

5. A place must be made for the definition proposed by a philosopher, J. M. E. McTaggart. In *Some Dogmas of Religion* (1906), he uses "dogma" of affirmations, whether supported by reasoning or merely asserted, if they claim "metaphysical" value, metaphysics being defined as "the systematic study of the ultimate nature of reality." Briefly, a dogma is what claims ultimate, not relative, truth. This agrees with one feature in ordinary literary usage—the contrast between "dogmatizing" and suspending judgment, or taking refuge in conjecture. But it

¹ It should be noted that Loofs does not speak merely as a historian. He places himself in a sense within the dogmatic circle by his declaration that guidance is to be expected from developments—in a "free Protestant evangelical spirit"—out of the old confessions of the Protestant churches. This belief may be called what Loofs has called Harnack's definition of dogma—*individuell berechtigt*, and perhaps *nur individuell*. Others, who hold no less strongly to theological progress by evolution, not revolution, will hesitate to grant that the line of advance passes through the symbolical books.

² Cf. DOGMATIC THEOLOGY, and the footnote above.

³ Unless in certain confined circles.

⁴ When Loofs declares (art. "Dogmengeschichte" in Herzog-Hauck's *Realencycl.*, 1898) that dogma is historically equivalent to *regula fidei*, he is in flat contradiction to the "dogma" of his own church as stated in the Formula of Concord. See above.

⁵ Here perhaps Harnack speaks from inside his own type of religious faith; but not from inside dogma.

ignores another quality marked out in common speech—that in respect of which "dogmatism" is opposed to proof. Also it omits the political or social reference so much insisted on by Loofs and others. There are materials for misunderstanding here.

6. A very different view is implied in the *symbolo-fidisme* of Athanasé Sabatier and some other French Protestants: religious dogma consists of symbols in contrast to a scientific gnosis of reality. This is a radical version of the early Protestant idea of faith, and yields a theory of what in English we call "doctrine." More precisely, it is a theory of what doctrine ought to be, or a deeper analysis of its nature; it is not a statement of what doctrine has been held to be in the past. And therefore the definition does not proceed from historical scholarship. Nor yet does it throw light upon "dogma," if dogma is to be distinguished—somehow—from doctrine.

LITERATURE.—Matthew Arnold's *Literature, and Dogma* (1873) is important for literary usage: cf. A. B. Bruce, *op. cit.* Classical and early Christian usages, E. Hatch, *Hibbert Lect.* (1888), pp. 119, 120; J. B. Lightfoot on Colossians ii. 14 (20); W. Schmidt, *Dogmatik*, vol. i. (1895)—many quotations in *extenso*; C. Stange, *Das Dogma und seine Beurteilung in der neueren Dogmengeschichte* (1898)—a pamphlet protesting against what Loofs terms the "generally accepted view." Articles in the (Roman Catholic) *Kirchenlexikon* of Wetzer and Welte, 2nd ed. (by Hergenröther and Kaulen), 1882-1901, Art. "Dogmatik" (J. Köstlin), "Dogmengeschichte" (F. Loofs) in Herzog-Hauck's *Encycl. f. prot. Theol.* (vol. iv., 1898). Art. "Glaubensartikel" in previous ed. (Herzog-Plitt, vol. v., 1879) by C. F. Kling and L. F. Schoeberlein. For works on the history of dogma see THEOLOGY. See also DOGMATIC THEOLOGY. (R. M. A.)

DOGMATIC THEOLOGY, the name usually given in modern times to the systematic study of Christian doctrine or of dogma in the widest sense possible (see DOGMA). Among the many terms used in the early days of Protestant theology to denote the great systems, three deserve special notice—Thetic Theology, Positive Theology, Dogmatic Theology. "Thetic theology" is connected with academic life. It recalls the literal and original meaning of graduation "theses," also Martin Luther's memorable theses and the replies made to him. "Thetic theology," a name now obsolete, naturally included the whole of doctrine, i.e. whatever would be argued for or against; and "dogmatic theology" came into use absolutely as a synonymous expression. "Positive theology" is also a term employed by Petau (*De theologicis dogmatibus*, 1644-1650), and more or less current even to-day in Roman Catholic scholarship (e.g. Joseph Turmel, *Histoire de la théologie positive*, 1906). "Dogmatic theology" proved to have most vitality in it. After some partial precedents of early date (e.g. F. Turrianus—one of the papal theologians at the Council of Trent,—*Dogmaticus (liber 1) de Justificatione*, 1557), the title was used in 1659 by the Lutheran Lukas Friedrich Reinhard (1623-1688), professor of theology at Altdorf (*Synopsis theologice dogmaticae*, eds. 1659, 1660, 1661), and his influence is already seen on the Reformed theologian Andreas van Essen (Essenius, 1618-1677), who, in 1659, published his *Systematis theologice pars prior, the tomus secundus* in 1661, but *Systematis dogmatici tomus tertius et ultimus* in 1665. The same author published a shorter *Compendium theologice dogmaticum* in 1669. A. M. Fairbairn holds that it was the fame of Petau which gave currency to the new coinage "dogmatic theology"; and though the same or kindred phrases had been used repeatedly by writers of less influence since Reinhard and Essenius, F. Bueddes (*Institutiones theol. dogmat.*, 1723; *Compendium*, 1728) is held to have given the expression its supremacy. Noël Alexandre, the Gallican divine, possibly introduced it in the Roman Catholic Church (1693; *Theologia dogmatica et moralis*). Both Roman Catholic and Protestant authorities agree that the expression was connected with the new habit of distinguishing dogmatics from Christian ethics or moral theology, though A. Schweizer denies this of Reinhard. In another direction dogmas and dogmatic theology were also contrasted with truths of reason and natural theology.⁶ F. E. D. Schliermacher, in his *Kurze Darstellung des theologischen Studiums*, and again in his great *System, Der christliche Glaube . . . dargestellt*, ingeniously proposed to treat dogmatic as an historical statement, or report, of beliefs held in

⁶ For "mixed articles" see DOGMA.

the writer's communion at the time of writing. He also insisted, however, upon personal conviction in writers on dogmatic. The expression *Glaubenslehre*—doctrine of faith—which he did much to bring into a wider currency, and which Schweizer, the most loyal of all his disciples, holds to be alone fitted for Protestant use, emphasizes the latter requirement. But "dogmatic" has also continued in use among Protestant theologians of the Left no less than among the orthodox. When we consider the different attitude towards dogma of Roman Catholicism, we feel constrained to question whether the expression "dogmatic theology" can be equally suitable for both communions. Roman theologians may properly define dogmatic as the scientific study of dogmas; Protestant scholars have come to use "dogma" in ways which make that impossible. Indeed, many of them bid us regard "dogmatic" as falling under the history of *theology* and not of *dogma* (see DOGMA). Still, usage is decisive. It will be impossible to uproot the phrase "dogmatic theology" among Protestants. When A. Harnack¹ praises Schleiermacher's description of dogmatic as "historical," he rather strains the meaning of the remark, and creates fresh confusion. Harnack's point is that "dogmatic theology" ought to be used in a sense corresponding to what he regards as the true meaning of "dogma"—Christian belief in its main traditional outlines. This claim is an innovation, and finds no precedent in Schleiermacher. The latter regarded dogmatic as stating in scientific connexion "the doctrine prevailing in a (single) Christian church at a given time"—as "not merely historical (*geschichtlich*)," but containing an "apologetic element"—as "not confined to the symbolical books, but" including all—even local expressions of the common faith which produce no breach of harmony—and as having for its "very business and task" to "purify and perfect" doctrine (*Der christliche Glaube*, § 19). The one merit which "dogmatic" may claim as a term in Protestant theology is that it contrasts positive statements of belief with mere reports (e.g. Biblical theology; history of doctrine) of what has been taught in the past. (See DOGMA; and THEOLOGY.)

DOGRA, a race of Hill Rajputs in India, inhabiting Kashmir and the adjacent valleys of the Himalayas. They form the ruling race in Kashmir. "Dogra" is the name given to the country round Jammu, and is said to be derived from a word meaning the "two lakes," as the original home of the Dogra people was situated between the lakes of Siroensar and Mansar. There are numerous castes in the Dogra country, and the Hindu, Mahomedan and Sikh religions are represented. All, whether Hindus or Mahomedans, whether high-born Rajputs of the Maharaja's caste or low-born menials, are known as Dogras. At the time of the first Sikh War the Dogras had a great reputation as soldiers, which they have worthily maintained in the ranks of the Indian native army. They are classed as fighting men with the Sikh and Punjabi Mahomedans. They distinguished themselves in the Hunza Nagar Expedition and the affair at Chilas in 1891, and in the Tirah campaign of 1897-98.

DOGS, ISLE OF, a district of London, England, on the north bank of the Thames, which surrounds it on three sides. It falls within the metropolitan borough of Poplar. It is occupied by docks, riverside works and poor houses. The origin of the name is not known. The suggestion that it is corrupted from the Isle of Docks falls to the ground on the question of chronology; another, that there were royal kennels here, is improbable, though they were situated at Deptford in the 17th century. (See POPLAR.)

DOG-TOOTH (the French *dent-de-scie*), in architecture, an ornament found in the mouldings of mediæval work of the commencement of the 12th century, which is thought to have been introduced by the Crusaders from the East. The earliest example is found in the hall at Rabbath-Ammon in Moab (c. A.D. 614) built by the Sassanians, where it decorates the arch moulding of the blind arcades and the string courses. In the apse of the church at Murano, near Venice, it is similarly employed. In the 12th and 13th centuries it was further elaborated with carving, losing therefore its primitive form, but constituting a

¹ *Hist. of Dogma*; Eng. trans. i. p. 21, footnote.

most beautiful decorative feature. In Elgin cathedral the dog-tooth ornament in the archivolt becomes a four-lobed leaf, and in Stone church, Kent, a much more enriched type of flower. The term has been supposed to originate in a resemblance to the dog-tooth violet, but the original idea of a projecting tooth is a sufficient explanation.

DOGWOOD (i.e. wood of the dog-tree; referred by the *New English Dictionary* to "dog," apparently as indicating inferiority; but by others connected with "dag," "dagger," and by Prior with A.S. *dolc*, a brooch-pin), the name applied to plants of the genus *Cornus*, of the natural order Cornaceæ. The common dogwood, prick-wood, skewer-wood, cornel or dogberry, *C. sanguinea*, is a shrub reaching a height of 8 or 9 ft., common in hedges, thickets and plantations in Great Britain. Its branches are dark red; the leaves egg-shaped, pointed, about 2 in. long by 1½ broad, and turning red in autumn; the flowers are dull white, in terminal clusters. The berries are small, of a black-purple, bitter and one-seeded, and contain a considerable percentage of oil, which in some places is employed for lamps, and in the manufacture of soap. The wood is white and very hard, and like that of other species of the genus is used for making ladder-spokes, wheel-work, skewers, forks and other implements, and gunpowder charcoal. The red berries of the dwarf species, *C. suecica*, of the Scottish Highlands, are eaten, and are reputed to be tonic in properties. *C. mas*, the Cornelian cherry, a native of Europe and Northern Asia, bears a pulpy and edible fruit, which when unripe contains much tannin. It is a good garden plant, as is also the North American species *C. florida*, one of the commonest trees of the deciduous forests of the middle and southern states. Professor C. S. Sargent (*Silva of North America*) describes it as "one of the most beautiful of the small trees of the American forests, which it emulivens in early spring with the whiteness of its floral leaves and in autumn with the splendour of its foliage and the brilliancy of its fruit. No tree is more desirable in the garden or park in regions where the summer's sun is sufficiently hot to ensure the production of its flowers through the perfect development of the branchlets." The Jamaica dogwood, the root-bark of which is poisonous, is the species *Piscidia Erythrina*, of the natural order Leguminosæ.

DOL, a town of north-western France, in the department of Ille-et-Vilaine, 36 m. N. of Rennes on the Western railway. Pop. (1906) 3543. Dol is situated to the south-west of the rich agricultural district known as the marsh of Dol, where market-gardening is especially flourishing. The streets are still rendered picturesque by houses of the 14th and 15th centuries, which form deep arcades by the projection of their upper storeys; and, high above all, rises the grey granite of the cathedral, mainly of the 13th century, which in the middle ages ranked as the metropolitan church of all Brittany, and still keeps fresh the name of Bishop St Samson, who, having fled, as the legend tells, from the Saxon invaders of England, selected this spot as the site of his monastery. To the architect it is interesting for the English character of its design, and to the antiquarian, for its stained-glass windows of the 13th century, and for the finely sculptured tomb of Bishop Thomas James (d. 1504). About ½ m. from the town is the *Pierre de Champ Dolent*, a menhir some 30 ft. in height; not far off stands the great granite rock of Mont Dol, over 200 ft. in height, surmounted by the statue and chapel of Notre-Dame de l'Espérance. Dol has trade in grain, vegetables and fruit, tobacco is cultivated in the neighbourhood and there are salt-marshes. Tanning and leather-carrying are carried on in the town. The town was unsuccessfully besieged by William the Conqueror, taken by Henry II. in 1164 and by Guy de Thouars in 1204. In 1793 it witnessed the defeat of the republican forces by the Vendéans who had taken refuge within its walls. The bishopric established in the 6th century was suppressed in 1790.

DOLABELLA, **PUBLIUS CORNELIUS**, Roman general and son-in-law of Cicero, was born about 70 B.C. He was by far the most important of the Dolabellæ, a family of the patrician gens Cornelia. In the civil wars he at first took the side of Pompey, but afterwards went over to Caesar, and was present at the battle of Pharsalus. To escape the urgent demands of his creditors, he

introduced (as one of the tribunes) a bill proposing that all debts should be cancelled. This was strongly resisted by his colleagues, and led to serious disturbances in the city. Caesar, on his return from Alexandria, seeing the expediency of removing Dolabella from Rome, took him as one of his generals in the expedition to Africa and Spain. On Caesar's death Dolabella seized the insignia of the consulship (which had already been conditionally promised him), and, by making friends with Brutus and the other assassins, was confirmed in his office. When, however, M. Antonius offered him the command of the expedition against the Parthians and the province of Syria he changed sides at once. His journey to the province was marked by plundering, extortion and the murder of C. Trebonius, proconsul of Asia, who refused to allow him to enter Smyrna. He was thereupon declared a public enemy and superseded by C. Cassius (the murderer of Caesar), who attacked him in Laodicea. On the capture of the place, Dolabella ordered one of his soldiers to kill him (43). Throughout his life he was a profligate and a spendthrift.

See Cicero's *Letters* (ed. Tyrrell and Purser); G. Boissac's *Cicero and his Friends* (Eng. trans. 1897); Orelli, *Onomasticon Tullianum*; Dio Cassius xli. 40, xlii. 29, xliii. 51, xliiv. 22, xlvi. 40, xlvii. 30; Appian, *Bell. civ.* iii. 7, iv. 60.

DOLBEN, JOHN (1625–1686), English divine, was the son of William Dolben (d. 1631), prebendary of Lincoln and bishop-designate of Gloucester. He was educated at Westminster under Richard Busby and at Christ Church, Oxford. He fought on the royalist side at Marston Moor, 1644. Subsequently he took orders and maintained in private the proscribed Anglican service. At the Restoration he became canon of Christ Church (1660) and prebendary of St Paul's, London (1661). As dean of Westminster (1662–1683) he opposed an attempt to bring the abbey under diocesan rule. In 1666 he was made bishop of Rochester, and in 1683 archbishop of York; he distinguished himself by reforming the discipline of the cathedrals in these dioceses. His son John Dolben (1662–1710) was a barrister and politician; he was M.P. for Liskeard from 1707 to 1710 and manager of Sacheverell's impeachment in 1709.

DOLCE, LUDOVICO, or **LUIGI** (1508–1568 or 1569), Italian writer, was a native of Venice, and belonged to a family of honourable tradition but decadent fortune. He received a good education, and early undertook the task of maintaining himself by his pen. Translations from Greek and Latin epics, satires, histories, plays and treatises on language and art followed each other in rapid succession, till the whole number amounted to upwards of seventy works. But he is now mainly memorable as the author of *Marianna*, a tragedy from the life of Herod, which was recast in French by Tristan and by Voltaire, and still keeps a place on the stage. Four licentious comedies, *Il Ragazzo* (1541), *Il Capitano* (1545), *Il Marito* (1560), *Il Ruffiano* (1560), and seven of Seneca's tragedies complete the list of his dramatic efforts. In one epic—to translate the title-page—"he has marvelously reduced into *ottava rima* and united into one narrative the stories of the *Iliad* and the *Aeneid*", in another he devotes thirty-nine cantos to a certain Primalcone, son of Palmerius; in a third he celebrates the first exploits of Count Orlando; and in a fourth he sings of the Paladin Sacripante. A life of the emperor Charles V. and a similar account of Ferdinand I., published respectively in 1560 and 1566, are his chief historical productions; and among his minor treatises it is enough to mention the *Osservazioni sulla lingua volgare* (1550); the *Dialogo della pittura* (1557); and the *Dialogo nel quale si ragiona del modo di accrescer la memoria* (1552).

DOLCI, CARLO, or **CARLINO** (1616–1686), Italian painter, was born in Florence in May 1616. He was the grandson of a painter on the mother's side, and became a disciple of Jacopo Vignali; and when only eleven years of age he attempted a whole figure of St John, and a head of the infant Christ, which received extraordinary approbation. He afterwards painted a portrait of his mother, and displayed a new and delicate style which brought him into notice, and procured him extensive employment at Florence (from which city he hardly ever moved) and in other parts of Italy. Dolci used his pencil chiefly in sacred subjects,

and bestowed much labour on his pictures. In his manner of working he was remarkably slow. It is said that his brain was affected by seeing Luca Giordano, in 1682, despatch more business in four or five hours than he could have executed in as many months, and that he hence fell into a state of hypochondria, which compelled him to relinquish his art, and soon brought him to the grave. His works are not very numerous. He generally painted in a small size, although there are a few pictures by him as large as life. He died in Florence in January 1686, leaving a daughter (Agnese), who arrived at some degree of excellence in copying the works of her father.

Carlo Dolci holds somewhat the same rank in the Florentine that Sassoferrato does in the Roman school. Without the possession of much genius, invention or elevation of type, both these artists produced highly wrought pictures, extremely attractive to some tastes. The works of Dolci are easily distinguishable by the delicacy of the composition, and by an agreeable tint of colour, improved by judicious management of the *chiaroscuro*, which gives his figures a striking relief; he affected the use of ultramarine, much loaded in tint. "His pencil," says Pilkington, "was tender, his touch inexpressibly neat, and his colouring transparent; though he has often been censured for the excessive labour bestowed on his pictures, and also for giving his carnations more of the appearance of ivory than the look of flesh." All his best productions are of a devout description; they frequently represent the patient suffering of Christ or the sorrows of the Mater Dolorosa. Dolci was, in fact, from early youth, exceedingly pious; it is said that during passion week every year he painted a half-figure of the Saviour. His sacred heads are marked with pathetic or at least strongly sentimental emotion. There is a want of character in his pictures, and his grouping lacks harmonious union, but the general tone accords with the idea of the passion portrayed. Among the best works of this master are the "St Sebastian"; the "Four Evangelists," at Florence; "Christ Breaking the Bread," in the marquess of Exeter's collection at Burleigh; the "St Cecilia" in Dresden; an "Adoration of the Magi"; and in special "St Andrew praying before his Crucifixion," in the Pitti gallery, his most important composition, painted in 1646; also several smaller pictures, which are highly valued, and occupy honourable places in the richest galleries. (W. M. R.)

DOLDRUMS (a slang term, *dol* = dull; cf. *tantrum*), the region of calms near the equator where the trade-winds die away, a region of constant precipitation in which the weather is close, hot, vaporous and extremely dispiriting. In the old days of sailing vessels, a becalmed ship sometimes lay helpless for weeks. A letter from this region saying "we are in the doldrums" ("in the dumps") seems to have been regarded as written from "The Doldrums," which thus became the name of this undesirable locality.

DÔLE, a town of eastern France, capital of an *arrondissement* in the department of Jura, 29 m. S.E. of Dijon on the Paris-Lyon railway. Pop. (1906) 11,166. It occupies the slope of a hill overlooking the forest of Chaux, on the right bank of the Doubs, and of the canal from the Rhone to the Rhine which accompanies that river. The streets, which in general are steep and narrow, contain many old houses recalling, in their architecture, the Spanish occupation of the town. The principal buildings are the church of Notre Dame, a Gothic structure of the 16th century; the college, once a Jesuit establishment, which contains the library and a museum of paintings and has a chapel of the Renaissance period; the Hôtel-Dieu and hôtel de ville, both 17th-century buildings; and the law court occupying an old convent of the Cordeliers. In the courtyard of the hôtel de ville there stands an old tower dating from the 15th century. The birth of Louis Pasteur (1822) in the town is commemorated by a monument, and there is also a monument to Jules Grévy. Dôle is the seat of a sub-prefect and has tribunals of first instance and of commerce and a communal college. Metal-founding and the manufacture of fire-pumps, kitchen-ranges and other iron goods, chemical products, machinery, leather, liqueurs and pastry, are among the industries. There is a good trade in agricultural produce and

live stock, and in wood, iron, coal and the stone of the vicinity. Wine is largely grown in the district.

Dôle, the ancient *Dola*, was in Roman times the meeting place of several roads, and considerable remains have been found there; in the later middle ages and till 1648 it was the capital of Franche Comté and seat of a parlement and a university; but in the year 1479 the town was taken by the forces of Louis XI., and so completely sacked that only the house of Jean Vurry, as it is still called, and two other buildings were left standing. It subsequently came into the hands of Maximilian of Austria, and in 1530 was fortified by Charles V. In 1668 and 1674 it was captured by the French and lost its parlement and its university, both of which were transferred by Louis XIV. to Besançon.

DOLE (from Old Eng. *dal*, cf. mod. "deal"), a portion, a distribution of gifts, especially of food and money given in charity. The derivation from O. Fr. *doel*, Late Lat. *dotium*, "grief," suggested by the custom of funeral doles, is wrong. In early Christian days, St Chrysostom says: "doles were used at funerals to procure the rest of the soul of the deceased, that he might find his judge propitious." The distribution of alms to the local poor at funerals was a universal custom in the middle ages. The amount of doles was usually stated in the will. Thus in 1399 Eleanor, duchess of Gloucester, ordered that fifteen poor men should carry torches at her funeral, "each having a gown and hood lined with white, breeches of blue cloth, shoes and a shirt, and twenty pounds amongst them." Later doles usually took the form of bequests of land or money, the interest or rent of which was to be annually employed in charity. Often the distribution took place at the grave of the donor. Thus one William Robinson of Hull at his death in 1708 left money to buy annually a dozen loaves, costing a shilling each, to be given to twelve poor widows at his grave every Christmas. Lenten doles were also formerly common. A will of 1537 bade a barrel of white herrings and a case of red herrings be given yearly to the poor of Clavering, Essex, to help them tide over the fast. One or two London doles are still distributed, e.g. that of St Peter's, Walworth, where a Christmas dinner is each year served to 300 parish poor in the crypt. No one under sixty is eligible, and the dinner is unique in that it is cooked in the church. A pilgrim's dole of bread and ale can be claimed by all wayfarers at the Hospital of St Cross, Winchester. This is said to have been founded by William of Wykeham. Emerson, when visiting Winchester, claimed and received the dole. What were known as *Scrambling Doles*, so called because the meat and bread distributed were thrown among the poor to be scrambled for, were not uncommon in England. Such a dole existed at St Briavel's, Gloucestershire, baskets of bread and cheese cut into small squares being thrown by the churchwardens from the gallery into the body of the church on Whit Sunday. At Wath near Ripon a testator in 1810 ordered that forty penny loaves should be thrown from the church leads at midnight on every Christmas eve. The best known dole in the United States is the "Leake Dole of Bread." John Leake, a millionaire dying in 1792, left £1000 to Trinity Church, New York, the income to be laid out in wheaten loaves and distributed every Sabbath morning after service. The dole still survives, though the day has been altered to Saturday, each week sixty-seven loaves being given away.

DOLERITE (from Gr. *δόλος*, deceptive), in petrology, the name given by Haüy to those basaltic rocks which are comparatively coarse grained and nearly, if not quite, holocrystalline. As may be inferred from their highly crystalline state they are very often intrusive, and occur as dikes and sills, but many of them form lava flows. Their essential minerals are those of basalt, viz. olivine, augite and plagioclase feldspar, while hornblende, ilmenite, apatite and biotite are their commonest accessory ingredients. The chemical and microscopic features of these minerals agree generally with those presented in the basalts, and only their exceptional peculiarities need be mentioned here. Many dolerites are porphyritic and carry phenocrysts of olivine, augite and plagioclase feldspar (or of one or more of these). Others, probably the majority, are non-porphyritic, and these are generally coarser grained than the ground-mass of the former group, though

lacking their large conspicuous phenocrysts. The commonest type of structure in dolerite is the ophitic, which results from the feldspar of the rock having crystallized before the augite; the latter mineral forms shapeless masses in which the idiomorphic feldspars lie. The augite enclosing the feldspars is well crystallized, though its continuity is interrupted more or less completely by the numerous crystals of feldspar which it envelops, and in polarized light the former often behaves as a single individual over a considerable area, while the latter mineral consists of independent crystals. This structure may be so coarse as to be easily detected by the unaided eye, or so fine that it cannot be seen except in microscopic sections. Some of the porphyritic dolerites have ophitic ground-masses; in others this structure is imperfect (subophitic); while in many the augite, like the feldspar, occurs as small and distinct individuals, which react differently on polarized light, and have the outlines of more or less perfectly shaped crystals. Ophitic structure is commonest in olivine-dolerites, though the olivine takes no part in it.

The quartz-dolerites are an important group, hardly less common than the olivine-dolerites. They contain a small amount of quartz, and often micropegmatite, as the last element to consolidate, filling up little angular interspaces between the feldspars and pyroxenes, which had previously crystallized. They rarely contain olivine, but pleochroic hypersthene is by no means rare in them (hypersthene-dolerites). Some contain larger individuals of pale green, rather pleochroic augite (the so-called sahlite), and a little brown mica, and brownish-green hornblende may also be present.

Allied to these are olivine-free dolerites with more or less of interstitial glassy base (tholeites, &c.). In the rocks of this group ophitic structure is typically absent, and the presence of an interstitial finely crystalline or amorphous material gives rise to the structure which is known as "intersertal." Transitions to the porphyritic dolerites and basalts arise by increase in the proportion of this ground-mass. The edges of dolerite sills and dikes often contain much dark brown glass, and pass into tachylytes, in which this material preponderates.

Another interesting group of doleritic rocks contains analcite. They may be ophitic, though often they are not, and they usually contain olivine, while their augite has distinctly purple shades, and a feeble dichroism.

Their characteristic feature is the presence of a small amount of analcite, which never shows crystalline outlines but fills up the interspaces between the other minerals. Some writers held that this mineral has resulted from the decomposition of nepheline; others regard it as a primary mineral. Usually it can be clearly shown to be secondary to some extent, but there is reason to suppose that it is really a pneumatolytic deposit. These rocks are known as teschenites, and have a wide distribution in England, Scotland, on the continent and in America. Often they are comparatively rich in brown hornblende. This last-named mineral is not usually abundant in dolerites, but in a special group, the proterobases, it to a large extent replaces the customary augite. A few dolerites contain much brown mica (mica-dolerites). Nepheline may appear in these rocks, as in the basalts. Typical nepheline-dolerites are scarce, and consist of idiomorphic augite, surrounded by nepheline. Examples are known from the Tertiary volcanic districts of the Rhine.

Dolerites have a very wide distribution, as they are found wherever basalts occur in any number. It is superfluous to cite localities for them as they are among the commonest of igneous rocks. They are much employed for road-mending and for kerbstones, though their dark colour and the tendency they have to weather with a dingy brown crust make them unsuitable for the better classes of architectural work.

(J. S. F.)

DOLET, ÉTIENNE (1509-1546), French scholar and printer, was born at Orleans on the 3rd of August 1509. A doubtful tradition makes him the illegitimate son of Francis I.; but it is evident that he was at least connected with some family of rank and wealth. From Orleans he was taken to Paris about 1521; and after studying under Nicolas Bérauld, the teacher of Coligny, he proceeded in 1526 to Padua. The death of his friend and

master, Simon de Villanova, led him, in 1530, to accept the post of secretary to Jean de Langeac, bishop of Limoges and French ambassador to the republic of Venice; he contrived, however, to attend the lectures of the Venetian scholar Battista Egnazio, and found time to write Latin love poems to some Venetian Elena. Returning to France soon afterwards he proceeded to Toulouse to study law; but there he soon became involved in the violent disputes between the different "nations" of the university, was thrown into prison, and finally banished by a decree of the parlement. In 1535 he entered the lists against Erasmus in the famous Ciceronian controversy, by publishing through Sebastian Gryphe (Gryphius) at Lyons a *Dialogus de imitatione Ciceroniana*; and the following year saw the appearance of his two folio volumes *Commentariorum lingue Latine*. This work was dedicated to Francis I., who gave him the privilege of printing during ten years any works in Latin, Greek, Italian or French, which were the product of his own pen or had received his supervision; and accordingly, on his release from an imprisonment occasioned by his justifiable homicide of a painter named Compaign, he began at Lyons his typographical and editorial labours. That he was not altogether unaware of the dangers to which he was exposed from the bigotry of the time is shown not only by the tone of his mottoes—*Prætere moi, Seigneur, des calamités des hommes*, and *Durior est spectata virtus quam incognita conditio*—but also by the fact that he endeavoured first of all to conciliate his opponents by publishing a *Calo christianus*, or Christian moralist, in which he made profession of his creed. The catholicity of his literary appreciation, in spite of his ultra-Ciceronianism, was soon displayed by the works which proceeded from his press—ancient and modern, sacred and secular, from the New Testament in Latin to Rabelais in French. But before the term of his privilege expired his labours were interrupted by his enemies, who succeeded in imprisoning him (1542) on the charge of atheism. From a first imprisonment of fifteen months Dolet was released by the advocacy of Pierre Duchâtel, bishop of Tulle; from a second (1544) he escaped by his own ingenuity; but, venturing back from Piedmont, whither he had fled in order that he might print at Lyons the letters by which he appealed for justice to the king of France, the queen of Navarre and the parlement of Paris, he was again arrested; branded as a relapsed atheist by the theological faculty of the Sorbonne, and on the 3rd of August 1546 put to the torture, strangled and burned in the Place Maubert. On his way thither he is said to have composed the punning pentameter—*Non dolet ipse Dolet, sed pia turba dolet*.

Whether Dolet is to be classed with the representatives of Protestantism or with the advocates of anti-Christian rationalism has been frequently disputed; by the principal Protestants of his own time he was not recognized, and by Calvin he is formally condemned, along with Agrippa and his master Villanova, as having uttered execrable blasphemies against the Son of God; but, to judge by the religious character of a large number of the books which he translated or published, such a condemnation is altogether misplaced. His repeated advocacy of the reading of the Scriptures in the vulgar tongue is especially noticeable. A statue of Dolet was erected on the Place Maubert in 1890.

See J. F. Née de la Rochelle, *Vie d'Étienne Dolet* (1779); Joseph Boulmier, *E. Dolet, sa vie, ses œuvres, son martyre* (1857); A. F. Didot, *Essai sur la typographie* (1852) and article in the *Nouvelle Biographie générale*; L. Michel, *Dolet: sa statue, place Maubert: ses amis, ses ennemis* (1889); R. C. Christie, *Étienne Dolet, the Martyr of the Renaissance* (2nd ed., 1889), containing a full bibliography of works published by him as author or printer; O. Gallier, *Étienne Dolet* (Paris, 1908). The *proœs*, or trial, of Dolet was published (1836) by A. H. Taillandier from the registers of the parlement of Paris.

DOLGELLEY (*Dolgelau*, dale of hazels), a market town and the county town of Merionethshire, North Wales, situated on the streams Wnion and Aran at the north base of Cader Idris, on the Cambrian and Great Western railways, 232 m. from London. Pop. of urban district (1901) 2437. It consists of small squares and narrow streets, with a free grammar school (1665), market hall, assize hall, county gaol, &c. The so-called parliament house (1404) of Owen Glendower's members has been demolished. There is some trade in coarse flannel and tweed. Glendower's

treaty with Charles of France (*Owinus D.G. princeps Walliæ. . . Datum apud Dolgueli . . .*) was dated here. The families of county rank in the neighbourhood include those of Nannau, Hengwrt (the famous Hengwrt Welsh MSS. are at Peniarth), Caerynwch, Fronwion, Bron-y-gadair, Brynygwin, Brynadda, Abergwynnant, Garthangharad. The county family, Vaughan, claims descent from Rodric Fawr, king of North Wales, Glendower's kinsman and enemy lived at Nannau. Scott (*Marmion*, vi. canto, note) refers to the demon oak at Nannau in 1813. Among neighbouring hills are Moel Offrwm (or *Orthrum*—of sacrifice or of oppression) and Moel Cynwch.

DOLGORUKI, VASILY LUKICH, COUNT (1672-1739), Russian diplomatist and minister, was one of the first batch of young Russians whom Peter the Great sent abroad to be educated. From 1687 to 1700 he resided at Paris, where he learned thoroughly the principal European languages, acquired the superficial elegance of the court of Versailles, and associated with the Jesuits, whose moral system he is said to have appropriated. On his return home he entered the diplomatic service. From 1706 to 1707 he represented Russia in Poland; and from 1707 to 1720 he was her minister at Copenhagen, where he succeeded in persuading King Frederick IV. to join the second coalition against Charles XII. At the end of 1720 he was transferred to Versailles, in order to seek the mediation of France in the projected negotiations with Sweden and obtain the recognition of Peter's imperial title by the French court. In 1724 he represented Russia at Warsaw and in 1726 at Stockholm, the object of the latter mission being to detach Sweden from the Hanoverian alliance, in which he did not succeed. During the reign of Peter II. (1727-1730) Dolgoruki was appointed a member of the supreme privy council, and after procuring the banishment of Menshikov he appropriated the person of the young emperor, whom he would have forced to marry his niece Catherine but for Peter's untimely death. He then drew up a letter purporting to be the last will of the emperor, appointing Catherine Dolgoruki his successor, but shortly afterwards abandoned the nefarious scheme as impracticable, and was one of the first to support the election of Anne of Courland to the throne on condition that she first signed nine "articles of limitation," which left the supreme power in the hands of the Russian council. Anne, who repudiated the "articles" on the first opportunity, never forgave Dolgoruki for this. He was deprived of all his offices and dignities on the 17th of April 1730, and banished first to his country seat and then to the Solovetsky monastery. Nine years later the charge of forging the will of Peter II. was revived against him, and he was tortured and then beheaded at Novgorod on the 8th of November 1739.

See Robert Nisbet Bain, *The Pupils of Peter the Great* (London, 1895).

DOLHAIN, the most eastern town of Belgium, situated on the Vesdre, N. E. of Verviers and close to the Prussian frontier. Pop. (1904) 4757. It is quite a modern town, occupying the site of the lower town of the ancient city of Limburg, which was destroyed by Louis XIV. in 1675. On a rocky eminence above Dolhain are still to be seen the fine ruins of the old castle of Limburg, the cradle of the ancient family of that name from which sprang the Luxemburg family and several emperors of Germany. The Gothic church of St George of the 13th century has been restored. At a short distance from Dolhain is the famous dam of the Gileppe, the vast reservoir constructed to supply Verviers with water free from lime for its cloth manufactures. The aqueduct from Gileppe to Verviers is nearly 5½ m. in length.

DOLICHOCEPHALIC (long-headed), a term invented by Andreas Retzius to denote (as opposed to "brachycephalic") those skulls the diameter of which from side to side, or the transverse diameter, is small in comparison with the longitudinal diameter or that from front to back. Retzius, though inventing the term, did not define it precisely. Paul Broca applied it to skulls having a cephalic index of seventy-five and under, and this limit is generally adopted. Dolichocephaly, according to Retzius, was the distinctive cranial feature of the earliest inhabitants of Europe. To-day it is characteristic of the negro races, of the

Papuans, the Polynesians and the Australians, though among the negritos and some of the pigmy races of Africa brachycephalic skulls are the rule. Of the yellow races the Eskimo is the most dolichocephalic. Of white races the Arabs and Kabyles of Algeria, and the Guanchos of the Canary Islands, are most notable for dolichocephalic tendency. Dolichocephaly is sometimes frontal, as among adult whites, sometimes occipital or confined to the back of the head, as among inferior negro-races, Australians, Papuans and newly-born whites.

DOLL, a child's plaything in the shape of a human figure or taken as representing one. The word "doll" was not in common use in the middle ages, "children's babies" and other terms being substituted for it; the commonly accepted view is that it is abbreviated from the name Dorothy (cf. Scottish "Doroty"). "Idol" has also been connected with it; but the accent is held to tell against this. Another derivation is from Norse *dauð* (woman), with which may be compared O.H.G. *toctha*, M.H.G. *doctte*, a girl, doll, used also in the sense of butterfly, nightmare, &c., thus connecting the doll with magic and superstition. The same connexion is found in Asia Minor, South India, among the Pueblo peoples and in South Africa; philology apart, therefore, the derivation from "idol" has much to recommend it, and some side influence from this word may well have caused the selection of the form "doll." Dolls proper should be distinguished from (a) idols, (b) magical figurines, (c) votive offerings, (d) costume figures. The festival figures of Japan, like the bambino of Italy, given to the child only on certain saints' days, hardly come within the category of dolls.

Dolls were known in ancient Egypt (XVIIIth Dynasty) and Asia Minor; they were common both in Greece and Rome; Persius mentions that girls vowed them to Venus when they got married; dolls found in the catacombs are preserved in the Vatican and the Museum Carpegna. The *νεσπορναρον* (Lat. *crepundia*) of Greek finds of the 6th and later centuries B.C. was a marionette. Dolls were in use among the Arabs at the time of Mahomet, and the prophet's nine-year-old wife Ayesha is said to have induced him to join her in her play with them. Although Mahomedanism prohibits the making of figures in human shape, dolls do not seem to have disappeared from Mahomedan countries, though substitutes for them are perhaps more common there than elsewhere.

Dolls are extremely common in Africa. There seem to be forms peculiar to different regions, such as the flat, spade-shaped figure on the Gold Coast. Among the Wasaramo the girls carry from the age of puberty till the birth of their first child an object indistinguishable from the ordinary doll; it is called *mwana ya kiti* (stool-child) because it is placed on a stool at home; it probably has a magical significance. The same may be said of the Australian figurines; others, made of cane, are undoubtedly children's dolls; excellently moulded wax figures are also found. In Asia dolls properly so-called are apparently rare; but there are specimens in museums from the Malay peninsula, Persia and South India, and in Asia Minor children use cushions, &c., as surrogates. They are found in Alaska among the Eskimo. Most Red Indian tribes had them; a mother who has lost her child carries its dolls and other playthings. Cortes is said to have found Montezuma and his court playing with elaborate dolls; they have been dug up from prehistoric Peruvian graves. In the Gran Chaco metacarpal bones of the rhea are in use, wrapped in a blanket when they represent male, in a petticoat when they are female.

But little attention has been paid to the psychological side of dolls. Though many boys play with them, dolls are mainly confined to girls; and female dolls predominate in the proportion of twelve to one. The culmination of the doll instinct is between the age of eight and nine; but they are not entirely dropped till much later; in fact unmarried and childless women sometimes keep it up for years. In children it is said by Hall to be by no means always a manifestation of the maternal instinct; for dolls are not always regarded as children, and the proportion of adults increases with the age of the children. But the important point is whether the child regarded itself as older or younger than the

doll. There is, on the other hand, a tendency to neglect dolls for babies and a reverse current of love of dolls which arises out of love of babies.

BIBLIOGRAPHY.—For a list of works see A. MacDonald, *Man and Abnormal Man* (U. S. Senate Document, 1905), vol. ix. No. 187, p. 275; see also Andree, *Ethnographische Parallelen* N. F.; Schlegel, *Indische Bibliothek* i. 139; *Brandenburgia*, xi. 28; *Delmeator*, lviii. 927; *Globus*, lxxv. 354, lxxx. 205; *Internat. Archiv f. Ethnogr.* vii. 48; *Ladies' Home Journ.* xvi.; *Westermann's Monatshefte* (Feb. 1899, &c.); *Man* (1903, No. 22). For the psychological side see *Pedagogical Seminary*, iv. 129, discussed in *Contemporary Rev.* lxxv. 48; Mrs F. H. Burnett, "The One I know best of all"; Sully, *Studies of Childhood*; G. Sand, *Histoire de ma vie*. (N. W. T.)

DOLLAR, a town of Clackmannanshire, Scotland, 6 m. N.E. of Alloa by the North British railway, not far from the Devon. Pop. (1901) 1619. The village, which is beautifully situated, contains several handsome stone villas occupied by families attracted to the town by its educational facilities. The academy, housed in a fine mass of buildings of the Grecian order (opened about 1819), was founded by Captain John McNab (1732-1802), a native who began life as a herdbo, and afterwards became a rich shipowner. From the burn of Dollar (or Dolour), which runs through the ravine of Dollar Glen, the town draws its water-supply. On an isolated hill above the junction of the parent streams, named Sorrow and Care, stands the ruin of Castle Campbell, known also as Gloom Castle, an old stronghold of the Argyll family. The castle was burned by the Macleans in 1644, in the interest of the marquess of Montrose, and not again restored. Although a ruin it is carefully preserved. The Rev. Dr James Aitken Wylie (1808-1890), the historian of Protestantism, was a minister in Dollar for several years. Patrick Gibson, the etcher and landscape-painter, was drawing-master at the academy from 1824 to 1829, and William Tennant, the author of *Anster Fair*, was a teacher of classics from 1819 till 1834, when he was appointed to the chair of Hebrew in St Andrews University. Harviestoun Castle, about midway between Dollar and Tillicoultry, once belonged to the Tait family, and here Archibald Campbell Tait, archbishop of Canterbury, spent some of his boyhood.

DOLLAR, a silver coin at one time current in many European countries, and adopted under varying forms of the name elsewhere. The word "dollar" is a modified form of *thaler*, which, with the variant forms (*daler*, *dalar*, *daalder*, *tallero*, &c.), is said to be a shortened form of *Joachimsthaler*. This *Joachimsthaler* was the name given to a coin intended to be the silver equivalent of the gold gulden, a coin current in Germany from the 14th century. In 1516 a rich silver mine was discovered in Joachimsthal (Joachim's dale), a mining district of Bohemia, and the count of Schlicht, by whom it was appropriated, caused a great number of silver coins to be struck (the first having the date 1518), bearing an effigy of St Joachim, hence the name. The *Joachimsthaler* was also sometimes known as the *Schlickenthaler*. The first use of the word dollar in English was as applied to this silver coin, the thaler, which was current in Germany at various values from the 16th century onwards, as well as, more particularly, to the unit of the German monetary union from 1857 to 1873, when the mark was substituted for the thaler. The Spanish piece-of-eight (*reals*) was also commonly referred to as a dollar. When the Bank of England suspended cash payments in 1797, and the scarcity of coin was very great, a large number of these Spanish coins, which were held by the bank, were put into circulation, after having been countermarked at the Mint with a small oval bust of George III., such as was used by the Goldsmiths' Company for marking plate. Others were simply over-stamped with the initials G.R. enclosed in a shield. In 1804 the Maundy penny head set in an octagonal compartment was employed. Several millions of these coins were issued. These Spanish pieces-of-eight were also current in the Spanish-American colonies, and were very largely used in the British North American colonies. As the reckoning was by pounds, shillings and pence in the British-American colonies, great inconveniences naturally arose, but these were to some extent lessened by the adoption of a tariff list, by which the various gold and silver coins circulating

were rated. In 1787 the dollar was introduced as the unit in the United States, and it has remained as the standard of value either in silver or gold in that country. For the history of the various changes in the weights and value of the coin see NUMISMATICS. The Spanish piece-of-eight was also the ancestor of the Mexican dollar, the Newfoundland dollar, the British dollar circulating in Hong Kong and the Straits Settlements, and the dollar of the South American republics, although many of them are now dollars only in name.

DOLLING, ROBERT WILLIAM RADCLYFFE (1851-1902), English divine, known as Father Dolling, was born at Magheralin, Co. Down, and educated at Harrow and Cambridge. From 1878 to 1882 he was warden of one of the houses of the Postmen's League, started by Father Stanton of St Alban's, Holborn. He was ordained in 1883 to a curacy at Corscombe, Dorset, but resided in London as head of St Martin's mission, Stepney. In 1885 a difficulty as to the relation of his mission to Holy Trinity parish, Stepney, led to his resignation, and he next accepted the charge of St Agatha's, Landport, the Winchester College mission. The remarkable reforms he accomplished there may be ascertained from his *Ten years in a Portsmouth slum* (London 1896). In 1885 he again resigned, owing to the bishop of Winchester's refusal to sanction the extreme ritual used in the service at St Agatha's. In 1897 he visited America, where his preaching made a great impression. He returned to England in the following year as vicar of St Saviour's, Poplar, and retained that living until his death.

An account of Dolling's person and missionary work among the poor is given in *The Life of Father Dolling* (London, 1903), by the Rev. C. E. Osborne.

DÖLLINGER, JOHANN JOSEPH IGNAZ VON (1799-1890), German theologian and church historian, was born at Bamberg, Bavaria, on the 28th of February 1799. He came of an intellectual stock, his grandfather and father having both been physicians of eminence and professors of one or other of the branches of medical science; his mother too belonged to a family not undistinguished in intellectual power. Young Döllinger was first educated in the gymnasium at Würzburg, and then began to study natural philosophy at the university in that city, where his father now held a professorship. In 1817 he began the study of mental philosophy and philology, and in 1818 turned to the study of theology, which he believed to lie beneath every other science. He particularly devoted himself to an independent study of ecclesiastical history, a subject very indifferently taught in Roman Catholic Germany at that time. In 1820 he became acquainted with Victor Aimé Huber (1800-1869), a fact which largely influenced his life. On the 5th of April 1822 he was ordained priest, after studying at Bamberg, and in 1823 he became professor of ecclesiastical history and canon law in the lyceum at Aschaffenburg. He then took his doctor's degree, and in 1826 became professor of theology at Munich, where he spent the rest of his life. About this time Döllinger brought upon himself the animadversion of Heine, who was then editor of a Munich paper. The unsparing satirist described the professor's face as the "gloomiest" in the whole procession of ecclesiastics which took place on Good Friday.

It has been stated that in his earlier years Döllinger was a pronounced Ultramontane. This does not appear to have been altogether the case; for, very early in his professorial career at Munich, the Jesuits attacked his teaching of ecclesiastical history, and the celebrated J. A. Möhler (*q.v.*) who afterwards became his friend, on being appealed to, pronounced on the whole in his favour. He also entered into relations with the well-known French Liberal Catholic Lamennais, whose views on the reconciliation of the Roman Catholic Church with the principles of modern society had aroused much suspicion in Ultramontane circles. In 1832 Lamennais, with his friends Lacordaire and Montalembert, visited Germany, and obtained considerable sympathy in their attempts to bring about a modification of the Roman Catholic attitude to modern problems. Döllinger seems to have regarded favourably the removal, by the Bavarian government, in 1841, of Professor Kaiser from his chair, because he had taught the infallibility of the pope. On the other hand, he published a

treatise in 1838 against mixed marriages, and in 1843 wrote strongly in favour of requiring Protestant soldiers to kneel at the consecration of the Host when compelled officially to be present at Mass. Moreover, in his works on *The Reformation* (3 vols. Regensburg, 1846-1848) and on *Luther* (1851, Eng. tr., 1853) he is very severe on the Protestant leaders, and he also accepts, in his earlier works, the Ultramontane view then current on the practical condition of the Church of England, a view which in later days he found reason to change. Meanwhile he had visited England, where he was well received; and he afterwards travelled in Holland, Belgium and France, acquainting himself with the condition and prospects of the Roman Catholic Church. In 1842 he entered into correspondence with the leaders of the Tractarian movement in England, and some interesting letters have been preserved which were exchanged between him and Pusey, Gladstone and Hope Scott. When the last-named joined the Church of Rome he was warmly congratulated by Döllinger on the step he had taken. He, however, much regretted the gradual and very natural trend of his new English allies towards extreme Ultramontane views, of which Archdeacon, afterwards Cardinal, Manning ultimately became an enthusiastic advocate. In 1845 Döllinger was made representative of his university in the second chamber of the Bavarian legislature. In 1847, in consequence of the fall from power of the Abel ministry in Bavaria, with which he had been in close relations, he was removed from his professorship at Munich, but in 1849 he was invited to occupy the chair of ecclesiastical history. In 1848, when nearly every throne in Europe was shaken by the spread of revolutionary sentiments, he was elected delegate to the national German assembly at Frankfurt,—a sufficient proof that at this time he was regarded as no mere narrow and technical theologian, but as a man of wide and independent views.

It has been said that his change of relations to the Papacy dated from the Italian war in 1859, but no sufficient reason has been given for this statement. It is more probable that, like Grosseteste, he had imbibed in early youth an enthusiastic sentiment of attachment to the Papacy as the only centre of authority, and the only guarantee for public order in the Church, but that his experience of the actual working of the papal system (and especially a visit to Rome in 1857) had to a certain extent convinced him how little correspondence there was between his ideal and the reality. He may also have been unfavourably impressed with the promulgation by Pius IX. in 1854 of the dogma of the Immaculate Conception of the Blessed Virgin. But whatever may have been his reasons, he ultimately became the leader of those who were energetically opposed to any addition to, or more stringent definition of, the powers which the Papacy had possessed for centuries. In some speeches delivered at Munich in 1861 he outspokenly declared his view that the maintenance of the Roman Catholic Church did not depend on the temporal sovereignty of the pope. His book on *The Church and the Churches* (Munich, 1861) dealt to a certain extent with the same question. In 1863 he invited 100 theologians to meet at Malines and discuss the question which Lamennais and Lacordaire had prematurely raised in France, namely, the attitude that should be assumed by the Roman Catholic Church towards modern ideas. His address to the assembled divines was "practically a declaration of war against the Ultramontane party." He had spoken boldly in favour of freedom for the Church in the Frankfurt national assembly in 1848, but he had found the authorities of his Church claiming a freedom of a very different kind from that for which he had contended. The freedom he claimed for the Church was freedom to manage her affairs without the interference of the state; the champions of the papal monarchy, and notably the Jesuits, desired freedom in order to put a stop to the dissemination of modern ideas. The addresses delivered in the Catholic congress at Malines were a declaration in the direction of a Liberal solution of the problem of the relations of Church and State. The pope for a moment seemed to hesitate, but there could be little doubt what course he would ultimately pursue, and after four days' debate the assembly was closed at his command. On the 8th of December 1864 Pius IX. issued

the famous *Syllabus*, in which he declared war against modern science and progress (see SYLLABUS). It was in connexion with this question that Döllinger published his *Past and Present of Catholic Theology* (1863) and his *Universities-Past and Present* (Munich, 1867).

We now approach the critical period of Döllinger's life. It was about this time that some of the leading theologians of the Roman Catholic Church, conceiving that the best way of meeting present perils was to emphasize, as well as to define more clearly, the authority of the pope, advised him to make his personal infallibility a dogma of the Church, and urged strenuously on him the necessity of calling a council for that purpose. There was considerable opposition in various quarters. Many bishops and divines considered the proposed definition a false one. Others, though accepting it as the truth, declared its promulgation to be inopportune. But the headquarters of the opposition was Germany, and its leader was Döllinger, whose high reputation and vast stores of learning placed him far above any other member of the band of the theological experts who now gathered around him. Among them were his intimate friends Johann Friedrich (*q.v.*) and J. N. Huber, in Bavaria. In the rest of Germany he found many supporters, chiefly professors in the Catholic faculty of theology at Bonn: among these were the famous canonist von Schulte, Franz Heinrich Reusch, the ecclesiastical historian Joseph Langen, as well as J. H. Reinkens, afterwards bishop of the Old Catholic Church in Germany, Knoodt, and other distinguished scholars. In Switzerland, Professor Edward Herzog, who became Old (or, as it is sometimes called, Christ-) Catholic bishop in Switzerland, and other learned men supported the movement. Early in 1869 the famous *Letters of Janus* (which were at once translated into English; 2nd ed. *Das Papsttum*, 1891) began to appear. They were written by Döllinger in conjunction with Huber and Friedrich, afterwards professor at Munich. In these the tendency of the *Syllabus* towards obscurantism and papal despotism, and its incompatibility with modern thought, were clearly pointed out; and the evidence against papal infallibility, resting, as the *Letters* asserted, on the False Decretals, and accepted without controversy in an age of ignorance, was ably marshalled for the guidance of the council. When, on the 8th of December 1869, it had actually assembled, the world was kept informed of what was going on in the *Letters of Quirinus*, written by Döllinger and Huber while the debates of the council were proceeding. Some of these letters appeared in the German newspapers, and an English translation was published by Rivington. Augustin Theiner, the librarian at the Vatican, then in disgrace with the pope for his outspoken Liberalism, kept his German friends well informed of the course of the discussions. The proceedings of the council were frequently very stormy, and the opponents of the dogma of infallibility complained that they were not infrequently interrupted, and that endeavours were made to put them down by clamour. The dogma was at length carried by an overwhelming majority, and the dissentient bishops, who—with the exception of two—had left the council before the final division, one by one submitted (see VATICAN COUNCIL). Döllinger, however, was not to be silenced. He headed a protest by forty-four professors in the university of Munich, and gathered together a congress at Nuremberg, which met in August 1870 and issued a declaration adverse to the Vatican decrees. An immense ferment took place. In Bavaria, where Döllinger's influence was greatest, the strongest determination to resist the resolutions of the council prevailed. But the authority of the council was held by the archbishop of Munich to be paramount, and he called upon Döllinger to submit. Instead of submitting, Döllinger, on the 28th of March 1871, addressed a memorable letter to the archbishop, refusing to subscribe the decrees. They were, he said, opposed to Holy Scripture, to the traditions of the Church for the first 1000 years, to historical evidence, to the decrees of the general councils, and to the existing relations of the Roman Catholic Church to the state in every country in the world. "As a Christian, as a theologian, as an historian, and as a citizen," he added, "I cannot accept this doctrine."

The archbishop replied by excommunicating the disobedient

professor. This aroused fresh opposition. Döllinger was almost unanimously elected rector-magnificus of the university of Munich, and Oxford, Edinburgh and Marburg universities conferred upon him the honorary degree of doctor of laws and Vienna that of philosophy. The Bavarian clergy invited Bishop Loos of the Jansenist Church in Holland, which for more than 150 years had existed independent of the Papacy and had adopted the name of "Old Catholic," to hold confirmations in Bavaria. The offer was accepted, and the bishop was received with triumphal arches and other demonstrations of joy. The three Dutch Old Catholic bishops declared themselves ready to consecrate a bishop, if it were desired. The momentous question was discussed at a meeting of the opponents of the Vatican decrees, and it was resolved to elect a bishop and ask the Dutch bishops to consecrate him. Döllinger, however, voted against the proposition, and withdrew from any further steps towards the promotion of the movement. This was the critical moment in the history of the resistance to the decrees. Had Döllinger, with his immense reputation as a scholar, as a divine and as a man, allowed himself to be consecrated bishop of the Old Catholic Church, it is impossible to say how wide the schism would have been. But he declined to initiate a schism. His refusal lost Bavaria to the movement; and the number of Bavarian sympathizers was still further reduced when the seceders, in 1878, allowed their priests to marry, a decision which Döllinger, as was known, sincerely regretted. The Old Catholic Communion, however, was formally constituted, with Reinkens at its head as bishop, and it still continues to exist (see OLD CATHOLICS).

Döllinger's attitude to the new community was not very clearly defined. It may be difficult to reconcile the two declarations made by him at different times: "I do not wish to join a schismatic society; I am isolated," and "As for myself, I consider that I belong by conviction to the Old Catholic community." The latter declaration was made some years after the former, in a letter to Pastor Widmann. The nearest approach to a reconciliation of the two statements would appear to be that while, at his advanced age, he did not wish to assume the responsibility of being head of a new denomination, formed in circumstances of exceptional difficulty, he was unwilling to condemn those who were ready to hazard the new departure. "By conviction" he belonged to the Old Catholics, but he never formally joined them. Yet at least he was ready to meet their leaders, to address them, and to discuss difficult problems with them. His addresses on the reunion of the Churches, delivered at the Bonn Conference of 1872, show that he was by no means hostile to the newly formed communion, in whose interests these conferences were held. In 1874 and again in 1875, he presided over the Reunion Conferences held at Bonn and attended by leading ecclesiastics from the British Isles and from the Oriental Church, among whom were Bishop Christopher Wordsworth of Lincoln; Bishop Harold Browne of Ely; Lord Plunket, archbishop of Dublin; Lycurgus, archbishop of Syros and Tenos; Canon Liddon; and Professor Ossinine of St Petersburg. At the latter of these two conferences, when Döllinger was seventy-six years of age, he delivered a series of marvellous addresses in German and English, in which he discussed the state of theology on the continent, the reunion question, and the religious condition of the various countries of Europe in which the Roman Catholic Church held sway. Not the least of his achievements on this occasion was the successful attempt, made with extraordinary tact, ability, knowledge and perseverance, to induce the Orientals, Anglicans and Old Catholics present to accept a formula of concord, drawn from the writings of the leading theologians of the Greek Church, on the long- vexed question of the Procession of the Holy Spirit. This result having been attained, he passed the rest of his days in retirement, emerging sometimes from his retreat to give addresses on theological questions, and also writing, in conjunction with his friend Reusch, his last book, *Geschichte der Moralstränkigkeiten in der römisch-katholischen Kirche seit dem sechzehnten Jahrhundert mit Beiträgen zur Geschichte und Charakteristik des Jesuitenordens* (Nordlingen, 1889), in which he deals with the moral theology of St Alfonso de' Liguori. He died

in Munich, on the 14th of January 1890, at the age of ninety-one. Even in *articulo mortis* he refused to receive the sacraments from the parish priest at the cost of submission, but the last offices were performed by his friend Professor Friedrich.

In addition to the works referred to in the foregoing sketch, he may mention *The Eucharist in the First Three Centuries* (Mainz, 1826); a *Church History* (1836, Eng. trans. 1840); *Hippolytus and Callistus* (1854, Eng. trans., 1876); *First Age of Christianity* (1860); *Lectures on the Reunion of the Churches; The Vatican Decrees; Studies in European History* (tr. M. Warre, 1890); *Miscellaneous Addresses* (tr. M. Warre, 1894).

See *Life* by J. Friedrich (3 vols. 1899-1901); obituary notice in *The Times*, 11th January 1890; L. von Kobell, *Conversations of Dr Dollinger* (tr. by K. Gould, 1892).

DOLLOND, JOHN (1706-1761), English optician, was the son of a Huguenot refugee, a silk-weaver at Spitalfields, London, where he was born on the 10th of June 1706. He followed his father's trade, but found time to acquire a knowledge of Latin, Greek, mathematics, physics, anatomy and other subjects. In 1752 he abandoned silk-weaving and joined his eldest son, Peter Dollond (1730-1820), who in 1750 had started in business as a maker of optical instruments. His reputation grew rapidly, and in 1761 he was appointed optician to the king. In 1758 he published an "Account of some experiments concerning the different refrangibility of light" (*Phil. Trans.*, 1758), describing the experiments that led him to the achievement with which his name is specially associated, the discovery of a means of constructing achromatic lenses by the combination of crown and flint glasses. Leonhard Euler in 1747 had suggested that achromatism might be obtained by the combination of glass and water lenses. Relying on statements made by Sir Isaac Newton, Dollond disputed this possibility (*Phil. Trans.*, 1753), but subsequently, after the Swedish physicist, Samuel Klingenskjerna (1698-1765), had pointed out that Newton's law of dispersion did not harmonize with certain observed facts, he began experiments to settle the question. Early in 1757 he succeeded in producing refraction without colour by the aid of glass and water lenses, and a few months later he made a successful attempt to get the same result by a combination of glasses of different qualities (see TELESCOPE). For this achievement the Royal Society awarded him the Copley medal in 1758, and three years later elected him one of its fellows. Dollond also published two papers on apparatus for measuring small angles (*Phil. Trans.*, 1753, 1754). He died in London, of apoplexy, on the 30th of November 1761.

An account of his life, privately printed, was written by the Rev. John Kelly (1750-1809), the Manx scholar, who married one of his granddaughters.

DOLMAN (from Turk. *dölmân*), originally a long and loose garment left unfastened in front, and with narrow sleeves. It is worn generally by the Turks, and is not unlike a cassock in shape. The name was given to the uniform jacket, worn by hussars, and slung from the shoulders with the sleeves hanging loose; and it is also used for a similar garment worn by ladies, with wide caplike arrangements instead of sleeves.

DOLNJA TUZLA, or **DOŃIJA SOU**, the capital of the Dolnja Tuzla district, in Bosnia, beautifully situated on the Jala or Julla, a small stream flowing into the Spreča, which joins the Bosna at Doboï, 39 m. W.N.W.; and on a branch railway from Doboï. Pop. (1895) 10,227; almost all, including a permanent colony of gipsies, being Moslems. Dolnja Tuzla is the seat of a district court and an Orthodox bishop; with several churches, many mosques, a hospital, gymnasium and commercial school. Besides large alkali works, it has a vigorous trade in grain, livestock, timber and coal, from the surrounding hills, where there is a colony of Hungarian miners; while the salt springs, owned by the state both at Dolnja, or Lower, and Gornja, or Upper Tuzla, 6 m. E., are without a rival in the Balkan Peninsula.

Dolnja Tuzla was called by the Romans *Ad Salinas*. Constantine Porphyrogenitus mentions it, in the 10th century, as *Salenes*; in other medieval documents it appears as *Sou*, *Sow* or *Sohi*. Its modern name is derived from the Turkish *tuz*, "salt." In 1690 the Austrians routed the Turks at Gornja Tuzla, and removed the Franciscan friars, with about 3000 other Roman Catholics, into Slavonia.

DOLOMIEU, DÉODAT GUY SILVAIN TANCRÈDE GRATET DE (1750-1801), French geologist and mineralogist, was born at Dolomieu, near Tour-du-Pin, in the department of Isère in France, on the 24th of June 1750. He was admitted in his infancy a member of the Order of Malta. In his nineteenth year he quarrelled with a knight of the galley on which he was serving, and in the duel that ensued killed him. He was condemned to death for his crime, but in consideration of his youth the grand master granted him a pardon, which, at the instance of Cardinal Torrigiani, was confirmed by Pope Clement XIII., and after nine months' imprisonment he was set at liberty. Throughout that period he had solaced himself with the study of the physical sciences, and during his subsequent residence at Metz he continued to devote himself to them. In 1775 he published his *Recherches sur la pesanteur des corps à différentes distances du centre de la terre*, and two Italian translations of mineralogical treatises by A. F. Cronstedt (1702-1765) and T. O. Bergman (1735-1784). These works gained for him the honour of election as a corresponding member of the Académie des Sciences at Paris. To obtain leisure to follow his favourite pursuits Dolomieu now threw up the commission which, since the age of fifteen, he had held in the carabineers, and in 1777 he accompanied the *bailli* (afterwards Cardinal L. R. E.) de Rohan to Portugal. In the following year he visited Spain, and in 1780 and 1781 Sicily and the adjacent islands. Two months of the year 1782 were spent in examining the geological structure of the Pyrenees, and in 1783 the earthquake of Calabria induced him to go to Italy. The scientific results of these excursions are given in his *Voyage aux îles de Lipari* (1783); *Mémoire sur le tremblement de terre de la Calabre* (1784); *Mémoire sur les Ponces*, et catalogue raisonné des produits de l'Etna (1788) and other works. In 1789 and 1790 he busied himself with an examination of the Alps, his observations on which form the subject of numerous memoirs published in the *Journal de physique*. The mineral *dolomite*, which was named after him, was described by Dolomieu in 1791. He returned to France in that year, bringing with him rich collections of minerals. On the 14th of September 1792 the duc de la Rochefoucauld, with whom he had been for twenty years on terms of the closest intimacy, was assassinated at Forges, and Dolomieu retired with the widow and daughter of the duke to their estate of Roche Guyon, where he wrote several important scientific papers. The events of the 9th Thermidor (July 27, 1794) having restored the country to some tranquillity, Dolomieu recommenced his geological tours, and visited various parts of France with which he had been previously unacquainted. He was in 1796 appointed engineer and professor at the school of mines, and was chosen a member of the Institute at the time of its formation. At the end of 1797 he joined the scientific staff which in 1798 accompanied Bonaparte's expedition to Egypt. He had proceeded up the Nile as far as Cairo when ill-health made his return to Europe necessary, and on the 7th of March 1799 he set sail from Alexandria. His ship proving unseaworthy put into Taranto, and as Naples was then at war with France, all the French passengers were made prisoners. On the 22nd of May they were carried by ship to Messina, whence, with the exception of Dolomieu, they embarked for the coast of France. Dolomieu had been an object of the hatred of the Neapolitan court since 1783, when he revealed to the grand master of his order its designs against Malta, and the calumnies of his enemies on that island served now as a pretext for his detention. He was confined in a pestilential dungeon, where, clothed in rags, and having nothing but a little straw for a bed, he languished during twenty-one months. Dolomieu, however, did not abandon himself to despair. Deprived of writing materials, he made a piece of wood his pen, and with the smoke of his lamp for ink he wrote upon the margins of a Bible, the only book he still possessed, his treatise *Sur la philosophie minéralogique et sur l'espèce minérale* (1801). Friends entreated, but in vain, for his liberty; it was with difficulty that they succeeded in furnishing him with a little assistance, and it was only by virtue of a special clause in the treaty between France and Naples that, on the 15th of March 1801, he was released. On his arrival in France he commenced the duties of the chair of mineralogy at the museum

of natural history, to which, after the death of Daubenton, he had been elected in January 1800. His course of lectures concluded, he revisited Switzerland. Returning thence he reached the residence of his brother-in-law at Château-Neuf, in the department of Saône-et-Loire, where he was seized with a fever, to which in a few days he succumbed, on the 26th of November 1801.

Dolomieu's geological theories are remarkable for originality and boldness of conception. The materials constituting the primordial globe he held to have arranged themselves according to their specific gravities, so as to have constituted a fluid central sphere, a solid crust external to this, next a stratum of water, and lastly the atmosphere. Where water penetrated through the crust, solidification took place in the underlying fluid mass, which enlarging in consequence produced rifts in the superincumbent rocks. Water rushing down through the rifts became decomposed, and the resulting effervescence occasioned submarine volcanoes. The crust of the earth he believed to be continually increasing in thickness, owing to the deposition of aqueous rocks, and to the gradual solidification of the molten interior, so that the volcanic eruptions and other geological phenomena of former must have been of far greater magnitude and frequency than those of recent times.

See Lacépède, "Éloge historique de Dolomieu," in *Mémoires de la classe des sciences de l'Institut* (1806); Thomson, in *Annals of Philosophy*, vol. xii. p. 161 (1808).

DOLOMITE, a mineral species consisting of calcium and magnesium carbonate, $\text{CaMg}(\text{CO}_3)_2$, and occurring as rhombohedral crystals or large rock-masses. Analyses of most well-crystallized specimens correspond closely with the above formula, the two carbonates being present in equal molecular proportions ($\text{CaCO}_3, 54.35$; $\text{MgCO}_3, 45.65\%$). Normal dolomite is thus not an isomorphous mixture of calcium and magnesium carbonates, but a double salt; and any variations in composition are to be explained by the isomorphous mixing of this double salt with carbonates of calcium, iron, magnesium, manganese, and rarely of zinc and cobalt.

In crystalline form dolomite is very similar to calcite, belonging to the same group of rhombohedral carbonates; the primitive rhombohedron, r (100), parallel to the faces of which there are perfect cleavages, has interfacial angles of $73^\circ 45'$, the angle of the cleavage rhombohedron of calcite being $74^\circ 55'$. A specially characteristic feature is that this rhombohedron is frequently the only form present on the crystals (in calcite it is rare except in combination with other forms); the faces are also usually curved

(fig. 1), sometimes to an extraordinary degree giving rise to saddle-shaped crystals (fig. 2). Crystals with plane faces are usually twinned, there being an interpenetration of two rhombohedra with the vertical axes parallel. The secondary twin-lamination, parallel to the obtuse rhombohedron e (110), so common in calcite, does not exist in dolomite. In the degree of symmetry possessed by the crystals there is, however, an important difference between calcite and dolomite; the former has the full number of planes and axes of symmetry of a rhombohedral crystal, whilst the latter is hemihedral with parallel faces, having only an axis of triad symmetry and a centre of symmetry. This lower degree of symmetry, which is the same as that of diopside and phenacite, is occasionally shown by the presence of an obliquely placed rhombohedron, and also by the want of symmetry in the etching and elasticity figures on the faces of the primitive rhombohedron.

Dolomite is both harder ($H. = 3\frac{1}{2}-4$) and denser (sp. gr. 2.85) than calcite. The two minerals may also be readily distinguished

by the fact that dolomite is not acted upon by cold, dilute acids (see below, *Dolomite Rock*). Crystals of dolomite vary from transparent to translucent, and often exhibit a pearly lustre, especially when the faces are curved; the colour is usually white or yellowish.

The crystallized mineral was first examined chemically by P. Woulfe in 1779, and was named compound-spar by R. Kirwan in 1784; other early names are bitter-spar, rhomb-spar and pearl-spar (but these included other rhombohedral carbonates). The name dolomite (*dolomite* of N. T. de Saussure, 1792) is in honour of the French geologist, D. G. Dolomieu, who in 1791 noted that certain Tyrolean calcareous rocks and Italian marbles effervesce only slightly in contact with acid; this name was for many years applied to the rock only, but was later extended to the crystallized mineral, first in the form dolomite-spar.

In the white crystalline dolomite-rock of the Binnenthal near Brieg in Switzerland beautiful water-clear crystals of dolomite are found; and crystallized masses occur embedded in serpentine, talc-schist and other magnesian silicate rocks. The best crystallized specimens are, however, usually found in metalliferous deposits; for example, in the iron mines of Traversella near Ivrea in Piedmont (as large twinned rhombohedra) and Cleator Moor in Cumberland; in the deposits of lead and zinc ores at Alston in Cumberland, Laxey in the Isle of Man, Joplin in Missouri; and in the silver veins of Schemnitz in Hungary and Guanajuato in Mexico.

Several varieties of dolomite have been distinguished, depending on differences in structure and chemical composition. Miemite is a crystallized or columnar variety, of a pale asparagus-green colour, from Miemo near Volterra in Tuscany; taraspite is a similar variety from Tarasp in Switzerland. Gurhofite, from Gurhof near Aggsbach in Lower Austria, is snow-white, compact and porcellanous. Brossite, from the Brosso valley near Ivrea in Piedmont, and tharandite, from Tharand in Saxony, are crystallized varieties containing iron. Closely related is the species ankerite (q.v.). (L. J. S.)

Dolomite Rock.—The rock dolomite, also known as dolomitic or magnesian limestone, consists principally of the mineral of the same name, but often contains admixture of other substances, such as calcite, quartz, carbonate and oxides of iron, argillaceous material, and chert or chalcedony. Dolomites when very pure and well crystallized may be snowy white (e.g. some examples from the eastern Alps), but are commonly yellow, creamy, brownish or grey from the presence of impurities. They tend to be crystalline, though on a fine scale, and appear under the microscope composed of small sharply angular rhombohedra, with a perfect cleavage and very strong double refraction. They can be often recognized by this, but are most certainly distinguished from similar limestones or marbles by tests with weak acid. Dolomite dissolves only very slowly in dilute hydrochloric acid in the cold, but readily when the acid is warmed; limestones are freely attacked by the acid in either state. Magnesian limestones, which contain both dolomite and calcite, may be etched by exposing polished surfaces for a brief time to cold weak acid; the calcite is removed, leaving small pits or depressions. The distribution of the calcite may be rendered more clear by using ferric chloride solution. This is decomposed, leaving a yellow stain of ferric hydrate where the calcite occurred. Alternatively, a solution of aluminium chloride will serve; this precipitates gelatinous alumina on contact with calcite and the film can be stained with aniline dyes (Lemberg's solution). The dolomite is not affected by these processes.

Dolomites of compact structure have a higher specific gravity than limestones, but they very often have a cavernous or drusy character, the walls of the hollows being lined with small crystals of dolomite with a pearly lustre and rounded faces. They are also slightly harder, and for these and other reasons they last better as building stones and wear better when used for paving or road-mending. Dolomites are rarely fossiliferous, as the process of dolomitization tends to destroy any organic remains originally present. As compared with limestones they are less frequently well bedded, but there are exceptions to this rule. Many



FIG. 1.

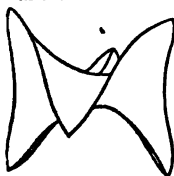

FIG. 2.

dolomites, particularly those of the north of England, show a very remarkable concretionary structure. The beds look as if made up of rounded balls of all sizes from a foot or two in diameter downwards. Often they are stuck together like piles of shot or bunches of grapes. They are composed of fibrous radiate calcite crystals, which by some kind of concretionary action have segregated from the dolomitic material and grouped themselves together in this way. Other concretions from these beds resemble bunches of corals, tufts of plants, or present various strange imitative forms.

Dolomite, unlike calcite, is not secreted by marine animals to build up the hard parts of their skeletons, and it is generally agreed also that dolomite is only very rarely and under exceptional conditions deposited directly from solution in water. On the other hand, there is much evidence to show that limestones may absorb or be partly replaced by magnesium carbonate, and the double salt dolomite substituted for calcite by one of those processes which are described as "metasomatic." Thus the Carboniferous limestones of various parts of Britain pass into dolomites along lines of joint, fissure or fault, or occasionally along certain bedding planes. At the same time the rock becomes crystalline, its minute structure is altered, its fossils are effaced, and as dolomite has a higher specific gravity than limestone, contraction results and cavities are formed. The prevalence of crystalline, concretionary and drusy structures in dolomite can thus be simply explained. The process may actually be studied in many "magnesian limestones," in which by means of the microscope we may trace the gradual growth of dolomite crystals taking place simultaneously with the destruction of the original features of the limestone. Recent investigations in coral reefs show that these changes are going on at the present day at no considerable depths and in rocks which have not long consolidated.

All this goes to prove that the double carbonate of calcium and magnesium is under certain conditions a more stable salt than either of the simple carbonates, and that these conditions recur in nature with considerable frequency. Experiments have proved that at moderately high temperatures (100° to 200° C.) solutions of magnesium salts will convert calcite into dolomite in the laboratory, and that aragonite is even more readily affected than calcite. The analogy with dolomitization of limestones is strong but not complete, as the latter process must take place at ordinary temperatures and approximately under atmospheric pressures. No completely satisfactory explanation of the change, from the standpoint of the geologist, has as yet been advanced, though much light has been thrown upon the problem. Many limestones are rich in aragonite, but this in course of time tends to recrystallize as calcite. Magnesium salts are abundant in sea-water, and in the waters of evaporating enclosed coral lagoons and of many bitter lakes. Calcite is more soluble than dolomite in water saturated with carbonic acid and would tend to be slowly removed from a limestone, while the dolomite increased in relative proportion. Dolomite also being denser than calcite may be supposed to replace it more readily when pressure is increased. These and many other factors probably co-operate to effect the transmutation of limestones into dolomites.

Examples of dolomitization may be obtained in practically every geological formation in which limestones occur. The oldest rocks are most generally affected, e.g. the Cambrian limestones of Scotland, but the change occurs, as has already been stated, even in the upraised coral reefs of the Indian and Pacific oceans which are very recent formations. It is very interesting to note that dolomites are very frequent among rocks which indicate that desert or salt-lake conditions prevailed at the time of their deposit. The dolomite or magnesian limestone of the English Permian is an instance of this. The explanation may be found in the fact that the waters of bitter lakes are usually rich in magnesium salts which, percolating through beds of limestone, would convert them into dolomite. Among the most famous dolomites are those of the Dolomite Alps of Tirol. They are of Triassic age and yield remarkably picturesque mountain scenery; it is believed that some were originally coral reefs; they are now highly crystalline and often contain interesting minerals and ores.

The galena limestone of the North American Trenton rocks is mostly a dolomite.

Dolomites furnish excellent building stones, and those of the north-east of England (Mansfield stone, &c.) have long been regarded with great favour on account of their resistance to decomposition. They vary a good deal in quality, and have not all proved equally satisfactory in practice. Part of the Houses of Parliament at Westminster is built of dolomite. (J. S. F.)

DOLOMITES, THE, a mountain district in the South Tirol Alps, though sometimes it is erroneously considered to form part of some other chain than the Alps. The distinguishing feature of this district is that it is composed of magnesian limestone, which rises in peaks of a most singular degree of sharpness and streaked by veins of the most startling colours. Nowadays it has become well known to tourists, who, however, keep mainly to a few great centres, though most of the more striking peaks were first ascended in the late sixties and early seventies of the 19th century by English mountaineers. Roughly speaking the Dolomite region lies between the Brenner railway from Franzensfeste to Trent (W.) and the road over the Monte Croce Pass from Innichen in the Drave valley by way of the Sexten glen and the Piave valley to Belluno and Feltre (E.). On the north it is limited by the railway line from Innichen to Franzensfeste, and on the south by the railway and road from Trent to Feltre. The highest summit is the Marmolata (10,972 ft.), but far more typical are the Sorapiss, the Cimon della Pala, the Langkofel, the Pelmo, the Drei Zinnen, the Sass Maor and the Rosengarten (see ALPS). Among the chief tourist resorts are St Ulrich (in the Gröden valley), San Martino di Castrozza (near Primiero), Capriè and Cortina d'Ampezzo.

Besides the Dolomites included in the above region there are several other Dolomite groups (though less extensive) in the Alps. N.W. of Trent rises the Tosa group, while in Switzerland there are the Fiz d'Aela group, S.W. of Bergün on the Albula Pass route, and the curious little group N. of the village of Splügen, besides other isolated peaks between the St Gotthard and Lukmanier Passes. In Dauphiné itself (the home of the geologist Dolomieu) the mountain districts of the Royannais, of the Vercors, and of the Dévoluy (all S.W. of Grenoble) are more or less Dolomitic in character.

See J. Gilbert and G. C. Churchill, *The Dolomite Mountains* (London, 1864); Miss L. Tuckett, *Zigzagging among Dolomites* (London, 1871); P. Grohmann, *Wanderungen in den Dolomiten* (Vienna, 1877); L. Sinigaglia, *Climbing Reminiscences of the Dolomites* (London, 1896); *The Climbs of Norman-Neruda* (London, 1899); V. Wolf von Glanvell, *Dolomitenführer* (Vienna, 1898); J. Ball, *Western Alps* (new ed., London, 1898, section 9, Rte. P. French Dolomites). (W. A. B. C.)

DOLPHIN, a name properly belonging to the common cetacean mammal known as *Delphinus delphis*, but also applied to a number of more or less nearly allied species. The dolphins, bottle-noses, or, as they are more commonly called, "porpoises," are found in abundance in all seas, while some species are inhabitants of large rivers, as the Amazon. They are among the



The Common Dolphin (*Delphinus delphis*).

smaller members of the cetacean order, none exceeding 10 ft. in length. Their food is chiefly fish, for the capture of which their long narrow beaks, armed with numerous sharp-pointed teeth, are well adapted, but some also devour crustaceans and molluscs. They are mostly gregarious, and the agility and grace of their movements in the water are themes of admiration to the spectators when a "school of porpoises" is playing round the bows of a vessel at sea.

The type of the group is the common dolphin (*D. delphis*) of the Mediterranean and Atlantic, which usually measures 6 to 8 ft. in length, and is thickest near the centre, where the back fin rises to

a height of 9 or 10 in., and whence the body tapers towards both extremities. The forehead descends abruptly to the base of the slightly flattened beak, which is about 6 in. long, and is separated from the forehead by a transverse depression. The mouth is armed with sharp, slightly curved teeth, of uniform size, varying in number from forty to fifty on each side of both jaws. The aperture of the ear is exceedingly minute; the eyes are of moderate size and the blow-hole is crescent-shaped. The colour of the upper surface is black, becoming lighter on the flanks, and perfectly white below. Dolphins are gregarious, and large herds often follow ships. They exhibit remarkable agility, individuals having been known to leap to such a height out of the water as to fall upon the deck. Their gambols and apparent relish for human society have attracted the attention of mariners in all ages, and have probably given rise to the many fabulous stories told of dolphins. Their appearance at sea was regarded as a good omen, for although it presaged a tempest, yet it enabled the sailors to steer for a place of safety. The dolphin is exceedingly voracious, feeding on fish, cuttlefishes and crustaceans. On the south coast of England it lives chiefly on pilchard and mackerel, and when in pursuit of these is often taken in the nets. The female brings forth a single young one, which she nurses most carefully. Her milk is abundant and rich, and during the operation of suckling, the mother floats in a slightly sidelong position, so as to allow of the necessary respiration in herself and her young. The dolphin was formerly supposed to be a fish, and allowed to be eaten by Roman Catholics when the use of flesh was prohibited, and it seems to have been esteemed as a delicacy by the French. Among the seafaring population of Britain the name "dolphin" is most usually given to the beautifully coloured fish *Coryphaena hippurus*—the dorado of the Portuguese, and it is to the latter the poet is alluding when he speaks of "the dying dolphin's changing hues."

Many other allied genera, such as *Prodelphinus*, *Steno*, *Lagenorhynchus*, &c., are also included in the family *Delphinidae*, some of which live wholly in rivers.

Beside these there is another group of largely freshwater species, constituting the family *Platanistidae*, and typified by the susu (*Platanista gangetica*), extensively distributed throughout nearly the whole of the river-systems of the Ganges, Brahmaputra and Indus, ascending as high as there is water enough to swim in, but never passing out to sea. It is about 8 ft. long, blind and feeds on small fish and crustaceans for which it gropes with its long snout in the muddy waters at the bottom. *Inia geoffroyensis*, the single species of its genus, frequents the Amazon, and reaches an extreme length of 8 ft. It is wholly pink or flesh-coloured, or entirely black, or black above and pink beneath. A third is the La Plata dolphin, *Stenodelphis blainvilliei*, a species about 5 ft. in length. Its colour is palish brown, which harmonizes with the brown-coloured water of the estuary of the Rio de la Plata. See CETACEA. (R. L. *)

DOMAT, or **DAUMAT**, **JEAN** (1625-1696), French juriconsult, was born at Clermont in Auvergne, on the 30th of November 1625. He was closely in sympathy with the Port-Royalists, was intimate with Pascal, and at the death of that celebrated philosopher was entrusted with his private papers. He is principally known from his elaborate legal digest, in three volumes 4to, under the title of *Les civiles dans leur ordre naturel* (1680),—an undertaking for which Louis XIV. settled on him a pension of 2000 livres. A fourth volume, *Le Droit public*, was published in 1697, a year after his death. This is one of the most important works on the science of law that France has produced. Domat endeavoured to found all law upon ethical or religious principles, his motto being *L'homme est fait par Dieu et pour Dieu*. Besides the *Lois Civiles*, Domat made in Latin a selection of the most common laws in the collections of Justinian, under the title of *Legum selectus* (Paris, 1700; Amsterdam, 1703); it was subsequently appended to the *Lois civiles*. His works have been translated into English. Domat died in Paris on the 14th of March 1696.

In the *Journal des sçavants* for 1843 are several papers on Domat by Victor Cousin, giving much information not otherwise accessible.

DOMBES, a district of eastern France, formerly part of the province of Burgundy, now comprised in the department of Ain, and bounded W. by the Saône, S. by the Rhone, E. by the Ain and N. by the district of Bresse. The region forms an undulating plateau with a slight slope towards the north-west, the higher ground bordering the Ain and the Rhone attaining an average height of about 1000 ft. The Dombes is characterized by an impervious surface consisting of boulder clay and other relics of glacial action. To this fact is due the large number of rain-water pools, varying for the most part from 35 to 250 acres in size which cover some 23,000 acres of its total area of 282,000 acres. These pools, artificially created, date in many cases from the 15th century, some to earlier periods, and were formed by landed proprietors who in those disturbed times saw a surer source of revenue in fish-breeding than in agriculture. Disease and depopulation resulted from this policy and at the end of the 18th century the Legislative Assembly decided to reduce the area of the pools which then covered twice their present extent. Drainage works were continued, roads cut, and other improvements effected during the 19th century. Large numbers of fish, principally carp, pike and tench are still reared profitably, the pools being periodically dried up and the ground cultivated.

The Dombes (Lat. *Dumbeæ*) once formed part of the kingdom of Arles. In the 11th century, when the kingdom began to break up, the northern part of the Dombes came under the power of the lords of Baugé, and in 1218, by the marriage of Marguerite de Baugé with Humbert IV. of Beaujeu, passed to the lords of Beaujeu. The southern portion was held in succession by the lords of Villars and of Thoire. Its lords took advantage of the excommunication of the emperor Frederick II. to assert their complete independence of the Empire. In 1400, Louis II., duke of Bourbon, acquired the northern part of the Dombes, together with the lordship of Beaujeu, and two years later bought the southern part from the sires de Thoire, forming the whole into a new sovereign principality of the Dombes, with Trévoux as its capital. The principality was confiscated by King Francis I. in 1523, along with the other possessions of the Constable de Bourbon, was granted in 1527 to the queen-mother, Louise of Savoy, and after her death was held successively by kings Francis I., Henry II. and Francis II., and by Catherine de' Medici. In 1561 it was granted to Louis, duke of Bourbon-Montpensier, by whose descendants it was held till, in 1682, "Mademoiselle," the duchess of Montpensier, gave it to Louis XIV.'s bastard, the duke of Maine, as part of the price for the release of her lover Lauzun. The eldest son of the duke of Maine, Louis Auguste de Bourbon (1700-1755), prince of Dombes, served in the army of Prince Eugene against the Turks (1717), took part in the War of the Polish Succession (1733-1734), and in that of the Austrian Succession (1742-1747). He was made colonel-general of the Swiss regiment, governor of Languedoc and master of the hounds of France. He was succeeded, as prince of Dombes, by his brother the count of Eu (*q.v.*), who in 1762 surrendered the principality to the crown. The little principality of Dombes showed in some respects signs of a vigorous life; the prince's mint and printing works at Trévoux were long famous, and the college at Thoissey was well endowed and influential.

See A. M. H. J. Stokvis, *Manuel d'histoire* (Leiden, 1889); Guichenon, *Histoire de Dombes* (1863, 1872); and various works by M. C. Guigue, including *Bibliotheca Dombensis* (with Valentin Smith) (1856-1885).

DOMBROWSKI, **JAN HENRYK** (1755-1818), Polish general, was born at Pierzowice in the palatinate of Cracow, on the 20th of August 1755. Brought up in Saxony, he served for some years in the Saxon army; but when, in 1791, the Polish diet recalled all Poles serving abroad; he returned to his native land. Under Poniatowski, he took part in the campaign of 1792 against the Russians. In 1794 he distinguished himself under Kosciuszko in the defence of Warsaw. For two years thereafter he lived in retirement, declining the offers of high ranks in their armies made to him by Russia and Prussia. He then went to Paris, and in January 1797 was authorized by the government of the Cisalpine Republic to organize a Polish legion. This task he executed at

Milan. In command of his legion he played an important part in the war in Italy, entered Rome in May 1798, and distinguished himself greatly at the Trebbia (June 19, 1799), and in other battles and combats of 1799-1801. After the peace of Amiens he passed, as general of division, into the service of the Italian republic. Summoned by Napoleon in 1806 to promote a rising in Poland, he organized several divisions of Poles, and distinguished himself at Danzig and at Friedland. In 1809 he served in the Polish campaign and in 1812 he commanded a Polish division in the *Grande Armée*, being wounded at the passage of the Bercina. He fought under Marmont at the battle of Leipzig (1813), and in the following year returned to Poland. He was one of the generals entrusted by the tsar with the reorganization of the Polish army, and was named in 1815 general of cavalry and senator palatine of the new kingdom of Poland. He retired, however, in the following year, to his estates in Posen. General Dombrowski died at his seat of Wina-Gora in Posen on the 26th of June 1818. He wrote several military historical works in the Polish language.

DOME (Lat. *domus*, house; Ital. *duomo*, cathedral), an architectural term, derived from a characteristic feature of Italian cathedrals, correctly applied only to a spherical or spheroidal vault, the horizontal plan of which is always a circle. It may be supported on a circular wall, as in the Pantheon at Rome; or on a drum, as in the later Byzantine churches and generally so in the Renaissance styles; or be carried over a square or polygonal area, in which case the base of the dome is connected to the lines of the main wall by pendentives, squinches, corbels or a series of concentric arches, or two of these combined. Its section may be semi-circular, pointed, ovoid or segmental; in the latter case it is usually termed a cupola, although the pendentives which carry it continue, on the diagonal lines, the complete spherical dome, as in the entrance vestibule on the south side of the Sanctuary at Jerusalem, attributed to Herod, or in those crowning the bays of the Golden Gateway by Justinian. The dome may be constructed in horizontal courses, as in the "beehive" tombs at Mycenae, with joints radiating to the centre, or a compromise between the two, in a series of small segments of circles, as in the Temple of Jupiter in Diocletian's palace at Spalato, or again with the lower portion in horizontal courses and the upper portion with arches, as in the Pantheon at Rome.

The dome is probably one of the earliest forms of covering invented by man, but owing probably to its construction in ephemeral materials, such as the unburnt bricks in Chaldaea, there are no examples existing. But in a bas-relief (see ARCHITECTURE, fig. 10), brought by Layard from Kuyunjik, are representations of semicircular and ovoid domes, which show that the feature was well known in Assyria, and as they build domes of the same nature down to the present day and without centring of any kind, it suggests that they may have existed from the remotest ages. The most ancient examples in Europe are those of the "beehive" tombs at Mycenae and elsewhere in Greece, ascribed generally to the 11th century B.C. In a sense, they are not true domes, because they are built in horizontal courses of stone, which act like the voussoirs of an arch in resisting the thrust of the earth at the back. This did not exist in the Choric Monument of Lysicrates or other circular buildings in Greece, because their vertical sections were not portions of circles. For this reason, the conical vault of the Baths in Pompeii is not a dome. The circular Laconicon in the Baths of Titus (A. D. 72) may have been domed, and the great hemicycles in the Thermae must certainly have been roofed with semi-domes.

The earliest Roman domes are those of the great circular halls at Baiae near Naples, described as temples, but really forming part of the immense bathing establishments there, the favourite place of resort of the Romans during the latter part of the Republic. The largest on the east side of the Lake of Avernus, known as the Temple of Apollo, is a circular hall with an internal diameter of 100 ft. Those of Diana, Mercury and Venus at Baiae, were 96, 66 and 60 ft. respectively. The vaults were all built in tufa with horizontal courses in brick and cement. Half of the dome of the Temple of Mercury had fallen down, showing the

section to have been nearly that of an equilateral arch. From the fact that there were pierced openings or windows in all these domes, they probably constituted the *frigidaria* of the baths.

The first example still existing in Rome is that of the Pantheon (A.D. 112), where a circular dome, 142 ft. in diameter, rests on a circular wall, its height being about equal to its diameter. The lower courses of this dome, built in the Roman brick or tile, were, up to the top of the third coffer, all laid in horizontal courses; above that, the construction is not known for certain; externally a series of small arches is shown, but they rested on a shell already built. The so-called Temple of Minerva Medica (now recognized as the Nymphaeum of the Baths of Gallienus, A. D. 366) is the next dated example. The Nymphaeum was decagonal on plan, so that small pendentives were required to carry the brick dome.

The domed Laconicon of the Thermae of Diocletian (A.D. 302) still exists as the vestibule of the church of Santa Maria degli Angeli. Of Constantine's time there are two small domed examples in the tomb of S. Costanza and the Baptistery of the Lateran, both in Rome, and one in the tomb of Galla Placidia at Ravenna (c. A.D. 450). From these we pass to the Sassanian domes at Serbistan and Firuzabad, of the 4th and 5th centuries respectively. These were built in brick and rested on square pendentives. In section they were ovoid. In Syria, the dome over the octagonal church at Esra, built in stone and dated A.D. 515, is also ovoid, its height being equal to its diameter, i.e. 28 ft. This, as well as the Sassanian domes, was built without centring. The next example is that of the church of Sta Sophia at Constantinople, the finest example existing, both in its conception and execution. It was built by Justinian (537-552) from the designs of Anthemius of Tralles and Isidorus of Miletus. The dome is 104 ft. in diameter, and is carried on pendentives over a square area. The construction is of brick and stone in alternate courses, and the lower part of the dome is pierced with forty windows, which give it an extraordinary lightness. The height from the pavement of the church to the soffit of the dome is 179 ft. No dome of similar dimensions was ever again attempted by the Byzantine architects, and the principal difference in later examples was the raising of the dome on a circular drum pierced with windows.

In order to lighten the dome erected over the church of San Vitale, at Ravenna, it was constructed with hollow cylindrical jars, fitted, the end of one into the mouth of the other; a similar contrivance was adopted in the tomb of the empress Helena (the Torre Pignatiara), the vaults of the Circus of Maxentius on the Via Appia, and the outer aisles of San Stefano, all at Rome, thus dispensing with the buttresses of Sta Sophia.

The domes of the earlier mosques in Cairo were built on the model of Sta Sophia, with windows pierced round the base of the dome and external buttresses between them; these domes were all built in brick coated over with cement or stucco. At a later date, and when built in stone, the upper portion was raised in height and terminated with a point on which a finial was placed. These are the domes inside and outside Cairo, which are carved with an infinity of geometrical patterns interwoven with conventional floral decoration. The upper portion of the dome is very thin, so that there is little weight and comparatively no thrust, and it is to these facts that we probably owe their preservation.

In India, in the "great mosque" of Jama Masjid (A.D. 1560) and the Gol Gumbaz, or tomb of Mahommed Adil Shah (A.D. 1630) at Bijapur, the domes are carried on pendentives consisting of arches crossing one another and projecting inwards, and their weight counteracts any thrust there may be in the dome. It is possibly for a similar reason that in the Jama Masjid of Shah Jahan at Delhi (1632-1638) and the Taj Mahal (A.D. 1630) the domes assume a bulbous form, the increased thickness of the dome below the haunches by its weight served as a counterpoise to any thrust the upper part of the dome might exert. The form is not much to be admired, and when exaggerated, as it is in the churches of Russia, where it was introduced by the Tatars, at times it became monstrous.

From these we pass to the domes of Périgord and La Charente, the earliest of which date from the commencement of the 11th century. Of the western dome of St Étienne at Périgueux (A.D. 14) only the pendentives remain, sufficient, however, with later examples, to show that these French domes were different from the Byzantine both in construction and form. The pendentives are built on horizontal courses of stone, and the voussoirs of the pointed arches which carried them form part of the pendentives; a few feet above the top of the arches is a moulding and a ledge, above which the dome, ovoid in section, is built. The principal examples following St Étienne are those of S. Jean-de-Cole, Cahors, Souillac, Solignac, Angoulême, Fontevrault, and lastly St Front at Périgueux, built about 1150, in imitation of St Mark's at Venice. The domes of the latter church were introduced into the old basilica about 1063, and were based on the church of the Apostles at Constantinople, which was pulled down in the 15th century, so that we have only the clear description of Procopius to go by. The domes over the north and south transepts and the choir of St Mark's are smaller than those over the nave and crossing, because they had to be fitted in between more ancient structures. The construction of the domes of St Mark's is not known, but at St Front the general design only was copied, and they built them in the Périgordian manner. The masons from Périgord are also responsible for the domes of the Crusaders' churches in Palestine and for some of the early churches still remaining in Cyprus. The domes of San Cyriaco at Ancona and Sant' Antonio at Padua were based upon those of St Mark's at Venice.

In central Italy we have the dome (elliptical in plan) of the cathedral of Pisa, and it was a favourite feature over the crossing of the churches throughout Italy, being generally carried on squinch pendentives. The domes of the baptisteries of Florence, Parma, Trieste and Piacenza, are only internal, being enclosed with vertical walls and a sloping roof. In Sicily, on account of the strong Saracenic influence, the squinches are simple versions of the stalactite pendentives described under ARCHITECTURE: *Mohammedan* (q.v.), the earliest example being found in the church of San Giovanni-dei-Leprosi (A.D. 1072), all the domes being ovoid in section.

Except in Périgord and La Charente, domes are not found in the churches in France, but in Spain they were introduced over the crossing at Burgos, Tarragona and Salamanca cathedrals, and were made architectural features externally. This is rarely found in Germany, for although in the cathedrals of Worms, Spire and Mainz, and in the churches of St Martin and Sankt Maria im Capitol at Cologne, the crossings are covered by domes, always carried on squinch pendentives, externally they built lanterns round them.

In the Renaissance styles, the dome was at once accepted as the principal characteristic feature, and its erection over the crossing of Santa Maria del Fiore at Florence was the first important work entrusted to Brunelleschi. The dome was begun in 1422, and finished in 1437, with the exception of the lantern, begun the year of his death in 1444, and completed in 1471. The dome, which is octagonal on plan, is 139 ft. in diameter, and is built with an inner and outer casing, concentric one with the other, tied together by ribs between them: the lower portion is stone, the upper part is brick.

The double shell was also employed by Michelangelo in the dome of St Peter's at Rome, the outer shell being raised higher than the lower and connected by ribs one with the other. The diameter is 140 ft. and the construction in brick, similar to that at Florence, but the ribs are in stone from Tivoli. In both these cases the weight of the lantern was a very important consideration, and is responsible for the repeated repairs required and the introduction of additional ties.

In this respect Sir Christopher Wren solved the difficulty at St Paul's cathedral, London, in another way: he provided three shells, the lower one with an eye in the centre forming the inner dome as seen from the interior; the middle one of conical form, and the outer one framed in timber and covered with lead. The conical shell carries the lantern, the weight of which is carried

direct to the base, bound with iron ties, with such additional strength as may be given by the portico round.

In all these cases these domes are built on lofty drums, so that externally they present quite a different appearance to those of the Pantheon at Rome, or Sta Sophia in Constantinople.

Of other examples, the domes of the Invalides in Paris, by Mansard (1706), and of the Panthéon by Soufflot (1735), have each three shells, the former having a graceful outline. In Spain the dome of the cathedral at Granada (1530) and the Escorial (1563); in Italy those of Sta Maria della Salute at Venice, the small example of Bramante at Todi (1480) and of the Carignano at Genoa, are worth recording, as also the dome of the Suleimanic mosque at Constantinople (1550). See plates illustrating ARCHITECTURE; and INDIAN ARCHITECTURE. (R. P. S.)

DOMENICHINO (or **DOMENICO**), **ZAMPIERI** (1581-1641), Italian painter, born at Bologna, on the 21st of October 1581, was the son of a shoemaker. The diminutive form of Christian name by which he is constantly known indicates his short stature. He was placed, when young, under the tuition of Denis Calvart; but having been treated with great severity by that master, he left him, and became a pupil in the academy of the Caracci, under Agostino. Towards the beginning of the 17th century he went to Rome, at the invitation of his fellow-pupil and intimate Albani, and prosecuted his studies under Annibale Caracci. The faculty of Domenichino was slow in its development. He was at first timid and distrustful of his powers; while his studious, unready and reserved manners were misunderstood by his companions for dulness, and he obtained the nickname of the "Ox" (Bue). But Annibale Caracci, who observed his faculties with more attention, predicted that the apparent slowness of Domenichino's genius would in time produce what would be an honour to the art of painting. When his early productions had brought him into notice, he studied with extreme application, and made such advance as to raise his works into a comparison with those of the most admired masters of the time. From his acting as a continual censor of his own works, he became distinguished amongst his fellow-pupils as an accurate and expressive designer; his colours were the truest to nature; Mengs, indeed, found nothing to desire in his works, except a somewhat larger proportion of elegance. That he might devote his whole powers to the art, Domenichino shunned all society; or, if he occasionally sought it in the public theatres and walks, this was in order better to observe the play of the passions in the features of the people—those of joy, anger, grief, terror and every affection of the mind—and to commit them vividly to his tablets; thus, says Bellori, it was that he succeeded in delineating the soul, in colouring life, and calling forth heartfelt emotions, at which all his works aim. In personal character he is credited with temperance and modesty; but, besides his want of sociability, he became somewhat suspicious, and jealous of his master.

In Rome, Domenichino obtained employment from Cardinals Borghese, Farnese and Aldobrandini, for all of whom he painted works in fresco. The distinguished reputation which he had acquired excited the envy of some of his contemporaries. Lanfranco in particular, one of his most inveterate enemies, asserted that his celebrated "Communion of St Jerome" (painted for the church of La Carità towards 1614, for a pittance of about ten guineas, now in the Vatican Gallery, and ordinarily, but most irrationally, spoken of as the second or third best oil picture in the world) was an imitation from Agostino Caracci; and he procured an engraving of this master's picture of the same subject (now in the Gallery of Bologna), copies of which were circulated for the purpose of proving that Domenichino was a plagiarist. There is in truth a very marked resemblance between the two compositions. The pictures which Zamperi painted immediately afterwards, representing subjects from the life of St Cecilia, only increased the alarm of his competitors, and redoubled their injustice and malignity. Disgusted with these cabals, he left Rome for Bologna, where he remained until he was recalled by Pope Gregory XV., who appointed him principal painter and architect to the pontifical palace. In this architectural post he seems to have done little or nothing, although he

was not expert in the art. He designed in great part the Villa di Belvedere at Frascati, and the whole of the Villa Ludovisi, and some other edifices. From 1630 onwards Domenichino was engaged in Naples, chiefly on a series of frescoes (never wholly completed) of the life of St Januarius in the Cappella del Tesoro. He settled in that city with his family, and opened a school. There the persecution against him became far more shameful than in any previous instance. The notorious so-called "Cabal of Naples"—the painters Corenzio, Ribera and Caracciolo—leagued together as they were to exclude all alien competition, plagued and derided the Bolognese artist in all possible ways; for instance, on returning in the morning to his fresco work, he would find not infrequently that someone had rubbed out the performance of the previous day. Perpetual worry is believed to have brought the life of Domenichino to a close; contemporary suspicion did not scruple to speak broadly of poison, but this has remained unconfirmed. He died in Naples, after two days' illness, on the 15th of April 1641.

Domenichino, in correctness of design, expression of the passions, and simplicity and variety in the airs of his heads, has been considered little inferior to Raphael; but in fact there is the greatest gulf fixed between the two. Critics of the 18th century adulated the Bolognese beyond all reason or toleration; he is now regarded as commonplace in mind and invention, lacking any innate ideality, though undoubtedly a forcible, resolute and learned executant. "We must," says Lanzi, "despair to find paintings exhibiting richer or more varied draperies, details of costume more beautifully adapted, or more majestic mantles. The figures are finely disposed both in place and action, conducing to the general effect; whilst a light pervades the whole which seems to rejoice the spirit, growing brighter and brighter in the aspect of the best countenances, whence they first attract the eye and heart of the beholder. The persons delineated could not tell their tale to the ear more plainly than they speak it to the eye. The 'Scourging of St Andrew,' which he executed in competition with Guido Reni at Rome (a fresco in the church of San Gregorio), is a powerful illustration of this truthful expression. Of the two works of these masters, Annibale Caracci preferred that of Domenichino. It is said that in painting one of the executioners the artist actually wrought himself into a passion, using threatening words and actions, and that Annibale Caracci, surprising him at that moment, embraced him, exclaiming with joy, 'To-day, my dear Domenichino, thou art teaching me.' So novel, and at the same time so natural, it appeared to him that the artist, like the orator, should feel within himself all that he is representing to others." Domenichino is esteemed the most distinguished disciple of the Caracci, or second only to Guido Reni. Algarotti preferred him to the greatest masters; and Nicolas Poussin considered the painter of the "Communion of St Jerome" to be the first after Raphael. His pictures of "Adam and Eve," and the "Martyrdom of St Agnes," in the Gallery of Bologna, are amongst his leading works. Others of superior interest are his first known picture, a fresco of the "Death of Adonis," in the Loggia of the Giardino Farnese, Rome; the "Martyrdom of St Sebastian," in Santa Maria degli Angeli; the "Four Evangelists," in Sant' Andrea della Valle; "Diana and her Nymphs," in the Borghese gallery; the "Assumption of the Virgin," in Santa Maria di Trastevere; and frescoes in the neighbouring abbey of Grotta Ferrata, lives of SS. Nilus and Bartholomew. His portraits are also highly reputed. It is admitted that in his compositions he often borrowed figures and arrangements from previous painters. Domenichino was potent in fresco. He excelled also in landscape painting. In that style (in which he was one of the earliest practitioners) the natural elegance of his scenery, his trees, his well-broken grounds, the character and expression of his figures, gained him as much public admiration as any of his other performances.

See Bolognini, *Life of Domenichino* (1839); C. Landon, *Works of Domenichino, with a Memoir* (1823).

(W. M. R.)

DOMESDAY BOOK, or simply **DOMESDAY**, the record of the great survey of England executed for William the Conqueror. We learn from the English Chronicle that the scheme of this

survey was discussed and determined in the Christmas assembly of 1085, and from the colophon of Domesday Book that the survey (*descriptio*) was completed in 1086. But Domesday Book (*liber*) although compiled from the returns of that survey, must be carefully distinguished from them; nor is it certain that it was compiled in the year in which the survey was made. For the making of the survey each county was visited by a group of royal officers (*legati*), who held a public inquiry, probably in the great assembly known as the county court, which was attended by representatives of every township as well as of the local lords. The unit of inquiry was the Hundred (a subdivision of the county which had then an administrative entity), and the return for each Hundred was sworn to by twelve local jurors, half of them English and half Normans. What is believed to be a full transcript of these original returns is preserved for several of the Cambridgeshire Hundreds, and is of great illustrative importance. The *Inquisitio Eliensis*, the "Exon Domesday" (so called from the preservation of the volume at Exeter), and the second volume of Domesday Book, also all contain the full details which the original returns supplied.

The original MS. of Domesday Book consists of two volumes, of which the second is devoted to the three eastern counties, while the first, which is of much larger size, comprises the rest of England except the most northerly counties. Of these the north-westerly portion, which had Carlisle for its head, was not conquered till some years after the survey was made; but the omission of Northumberland and Durham has not been satisfactorily explained. There are also no surveys of London, Winchester and some other towns. For both volumes the contents of the returns were entirely rearranged and classified according to fiefs. Instead of appearing under the Hundreds and townships they now appeared under the names of the local "barons," i.e. those who held the lands directly of the crown in fee. In each county the list opened with the holding of the king himself (which had possibly formed the subject of separate inquiry); then came those of the churchmen and religious houses; next were entered those of the lay tenants-in-chief (*barones*); and last of all those of women, of the king's sergeants (*servientes*), of the few English "thegns" who retained land, and so forth. In some counties one or more principal towns formed the subject of a separate section; in some the *clawores* (disputed titles to land) were similarly treated apart. But this description applies more specially to the larger and principal volume; in the smaller one the system is more confused, the execution less perfect. The two volumes are distinguished even more sharply by the exclusion, in the larger one, of certain details, such as the enumeration of the live stock, which would have added greatly to its size. It has, indeed, been suggested that the eastern counties' volume represents a first attempt, and that it was found impossible, or at least inconvenient, to complete the work on the same scale.

For the object of the survey we have three sources of information: (1) the passage in the English Chronicle, which tells us why it was ordered, (2) the list of questions which the jurors were asked, as preserved in the *Inquisitio Eliensis*, (3) the contents of Domesday Book and the allied records mentioned above. Although these can by no means be reconciled in every detail, it is now generally recognized that the primary object of the survey was to ascertain and record the fiscal rights of the king. These were mainly (1) the national land-tax (*geldum*), paid on a fixed assessment, (2) certain miscellaneous dues, (3) the proceeds of the crown lands. After a great political convulsion such as the Norman conquest, and the wholesale confiscation of landed estates which followed it, it was William's interest to make sure that the rights of the crown, which he claimed to have inherited, had not suffered in the process. More especially was this the case as his Norman followers were disposed to evade the liabilities of their English predecessors. The Domesday survey therefore recorded the names of the new holders of lands and the assessments on which their tax was to be paid. But it did more than this; by the king's instructions it endeavoured to make a national valuation list, estimating the annual value of all the

land in the country, (1) at the time of King Edward's death, (2) when the new owners received it, (3) at the time of the survey, and further, it reckoned, by command, the potential value as well. It is evident that William desired to know the financial resources of his kingdom, and probable that he wished to compare them with the existing assessment, which was one of considerable antiquity, though there are traces that it had been occasionally modified. The great bulk of Domesday Book is devoted to the somewhat arid details of the assessment and valuation of rural estates, which were as yet the only important source of national wealth. After stating the assessment of the manor, the record sets forth the amount of arable land, and the number of plough-teams (each reckoned at eight oxen) available for working it, with the additional number (if any) that might be employed; then the river-meadows, woodland, pasture, fisheries (i.e. weirs in the streams), water-mills, saltpans (if by the sea) and other subsidiary sources of revenue; the peasants are enumerated in their several classes; and finally the annual value of the whole, past and present, is roughly estimated. It is obvious that, both in its values and in its measurements, the survey's reckoning is very crude.

Apart from the wholly rural portions, which constitute its bulk, Domesday contains entries of interest concerning most of the towns, which were probably made because of their bearing on the fiscal rights of the crown therein. These include fragments of customs, records of the military service due, of markets, mints, and so forth. From the towns, from the counties as wholes, and from many of its ancient lordships, the crown was entitled to archaic dues in kind, such as honey. The information of most general interest found in the great record is that on political, personal, ecclesiastical and social history, which only occurs sporadically and, as it were, by accident. Much of this was used by E. A. Freeman for his work on the Norman Conquest. Although unique in character and of priceless value to the student, Domesday will be found disappointing and largely unintelligible to any but the specialist. Even scholars are unable to explain portions of its language and of its system. This is partly due to its very early date, which has placed between it and later records a gulf that is hard to bridge.

But in the *Dialogus de scaccario* (temp. Hen. II.) it is spoken of as a record from the arbitration of which there was no appeal (from which its popular name of "Domesday" is said to be derived). In the middle ages its evidence was frequently invoked in the law-courts; and even now there are certain cases in which appeal is made to its testimony. To the topographer, as to the genealogist, its evidence is of primary importance; for it not only contains the earliest survey of a township or manor, but affords in the majority of cases the clue to its subsequent descent. The rearrangement, on a feudal basis, of the original returns (as described above) enabled the Conqueror and his officers to see with ease the extent of a baron's possessions; but it also had the effect of showing how far he had enfeoffed "under-tenants," and who those under-tenants were. This was of great importance to William, not only for military reasons, but also because of his firm resolve to make the under-tenants (though the "men" of their lords) swear allegiance directly to himself. As Domesday normally records only the Christian name of an under-tenant, it is vain to seek for the surnames of families claiming a Norman origin; but much has been and is still being done to identify the under-tenants, the great bulk of whom bear foreign names.

Domesday Book was originally preserved in the royal treasury at Winchester (the Norman kings' capital), whence it speaks of itself (in one later addition) as *Liber de Wintonia*. When the treasury was removed to Westminster (probably under Henry II.) the book went with it. Here it remained until the days of Queen Victoria, being preserved from 1606 onwards in the Chapter House, and only removed in special circumstances, as when it was sent to Southampton for photozincographic reproduction. It was eventually placed in the Public Record Office, London, where it can be seen in a glass case in the museum. In 1869 it received a modern binding. The ancient Domes-

day chest, in which it used to be kept, is also preserved in the building.

The printing of Domesday, in "record type," was begun by government in 1773, and the book was published, in two volumes fol. in 1783; in 1811 a volume of indexes was added, and in 1876 a supplementary volume, separately indexed, containing (1) the "Exon Domesday" (for the south-western counties), (2) the *Inquisitio Eliensis*, (3) the *Liber Winton* (surveys of Winchester early in the 12th century), and (4) the *Boldon Book*—a survey of the bishopric of Durham a century later than Domesday. Photographic facsimiles of Domesday Book, for each county separately, were published in 1861-1863, also by government.

BIBLIOGRAPHY.—The following are the more important works to be consulted.—R. Kelham, *Domesday Book*, illustrated (1788); H. Ellis, *General Introduction to Domesday Book* (1833), 2 vols., containing valuable indexes to the names of persons; N. E. S. A. Hamilton, *Inquisitio Cantabrigiensis* (1876), containing the only transcripts of the original returns and the text of the *Inquisitio Eliensis*; E. A. Freeman, *History of the Norman Conquest*, vols. iv. and v.; F. Seebohm, *The English Village Community* (1883); *Domesday Studies*, 2 vols. (1888, 1891), on the occasion of the Domesday Commemoration (1886), by various writers, with bibliography to date; J. H. Round, *Feudal England* (1895); F. W. Maitland, *Domesday Book and Beyond* (1897); P. Vinogradoff, *Villainage in England* (1892) and *Growth of the Manor*; A. Ballard, *The Domesday Boroughs* (1904) and *The Domesday Inquest* (1906), an excellent summary; W. H. Stevenson, "A contemporary description of the Domesday Survey" in *The English Historical Review* (the general index to which should be consulted) (1907). The *Victoria County History* contains a translation of the Domesday text, a map, and an explanatory introduction for each county. (J. H. R.)

DOMESTIC RELATIONS, a term used to express the legal relations subsisting between the various units that comprise the family or domestic group. Those units which go to build up the domestic structure of modern society are parent, child, husband, wife, master and servant. The law which deals with the various relations subsisting between them is made up largely of the law of agency, of contract and of tort. See **HUSBAND AND WIFE**; **MASTER AND SERVANT**; **CHILDREN**, **LAW RELATING TO**; **INFANT**.

DOMETT, ALFRED (1811-1887), British colonial statesman and poet, was born at Camberwell Grove, Surrey, on the 20th of May 1811. He entered St John's College, Cambridge, but left the university in 1833. He published one or two volumes of poetry and contributed several poems to *Blackwood's Magazine*, one of which, "A Christmas Hymn," attracted much admiring attention. For ten years he lived a life of ease in London, where he became the intimate friend of Robert Browning, of whose poem "Waring" he was the subject. An interesting account of the friendship between the two men appeared in *The Contemporary Review* for January 1905, by W. H. Griffin. (See also *Robert Browning and Alfred Domett*, edited by F. G. Kenyon, 1906). In 1842 Domett emigrated to New Zealand where he filled many important administrative posts, being colonial secretary for New Munster in 1848, secretary for the colony in 1851, and prime minister in 1862. He returned to England in 1871, was created C.M.G. in 1880, and died on the 2nd of November 1887. Among his books of poetry, *Ranolf and Amohia, a South Sea Day Dream*, is the best known (1872), and *Flotsam and Jetsam* (1877) is dedicated to Browning.

DOMFRONT, a town of north-western France, capital of an arrondissement in the department of Orne, 43 m. W.N.W. of Alençon by rail. Pop. (1906) of the town, 2215; of the commune, 4663. The town, which is picturesquely situated on a bluff overlooking the Varenne, has a church, Notre-Dame-sur-l'Eau, dating from the 11th century. In the middle ages it was one of the chief strongholds in Normandy, and there still remain several towers of its ramparts, and ruins of the keep of its castle built in 1011, rebuilt in the 12th century by Henry II., king of England, and dismantled at the end of the 16th century. The town is the seat of a sub-prefect, and has a tribunal of first instance and a communal college. Cloth is manufactured, and there are granite quarries in the vicinity. Domfront is said to have grown up in the 6th century round the oratory of the hermit St Front, and played an important part in the wars against the

English and the Religious Wars. In 1574 it was occupied by the Protestant leader Gabriel de Montgomery, who after a stubborn siege was forced to yield it to Jacques Goyon, count of Matignon.

DOMICILE (Lat. *domicilium*, from *domus*, home), in law, a term which may be defined generally as the place of a man's permanent abode; a precise definition is a matter of acknowledged difficulty. Its use in Roman jurisprudence was to fix the jurisdiction to which a person was subject generally, not by reason of a particular circumstance, as the place where a contract was made or where property is situate. Hence it was admitted that a person might have as many domiciles as he had residences possessing some degree of permanence. In the middle ages, when a great diversity of laws had arisen, questions concerning personal status, as the age of majority or the capacity to contract a given marriage, came naturally to depend on the law to which the person was subject by reason of the general jurisdiction over him; and questions relating to the various items of his movable property grouped together, as those of his testamentary capacity or of the succession on his intestacy, had to be considered from a similarly personal point of view. There resulted a general agreement that a man's legal character, so to speak, should be determined by his domicile, and this introduced a stricter notion of domicile, allowing each person to have but one. He might be subjected without great inconvenience to more than one jurisdiction, but not to more than one law. This is the position which domicile now holds in English jurisprudence. It is the criterion of the law applicable in a large class of cases, and it must be single for each person; and English courts have continually to struggle with the difficulty of selecting his domicile from among the various places in any of which he may be said to reside.

Since the beginning of the 19th century most of the leading continental states have unified their internal laws; and attachment to a province by domicile having thus become an unnecessary consideration, they have adopted political nationality as the criterion of the law to be applied in most of the questions which used to depend on domicile. Thus as between themselves they have greatly simplified the determination of those questions, but a similar elimination of domicile is impossible in what concerns British subjects, because the British empire continues to include a great variety of laws, as those of England, Scotland, the province of Quebec, the Cape Colony, &c. Within the British dominions domicile is the only available criterion of the legal character of a British subject, and all British courts continue to apply the same criterion to British subjects outside those dominions and to foreigners, so that, for example, the age of majority of a British subject or of a Frenchman domiciled in Germany would be referred by a British court to German law. Indeed so deeply is the principle of domicile seated in British law that only legislative action could allow a British court to substitute a new principle. And even a French, Italian or German court, applying political nationality as its new criterion to the legal character of a British subject, could obtain no definite result unless it supplemented that criterion by the old one, domicile, in order to connect the person in question with one of the legal systems existing in the British dominions.

Again, so long as the change of the criterion has not become universal, a new question is introduced by its having been made in some countries only. Denmark being one of those European states which still adhere to the principle of domicile, we will take it as an example in order not to complicate the illustration by such differences of internal law as exist in the British dominions. Suppose that a Danish court has to decide on the age of majority of a Danish subject domiciled in France, Italy or Germany. Its rule refers the question to the law of the domicile, and the law of the domicile refers it back to the law of the political nationality. What is to be done? This and all other questions relating to the application of the principle of domicile, which has been only summarily indicated, are treated under **INTERNATIONAL LAW (PRIVATE)**. Here we shall deal briefly with the determination of domicile itself.

The Roman jurists defined domicile to be the place "ubi quis larum rerumque ac fortunarum summam constituit; unde

rursus non sit discessurus si nihil avocet: unde cum profectus est, peregrinari videtur: quo si rediit peregrinari jam destitit." This makes that place the domicile which may be described as the headquarters of the person concerned; but a man's habits of life may point to no place, or may point equally to two places, as his headquarters, and the connexion of domicile with law requires that a man shall always have a domicile, and never more than one. The former of these difficulties is met in the manner described by Lord Westbury in *Udny v. Udny* (*Law Reports*, 1 House of Lords, Scottish Appeals). "It is," he said, "a settled principle that no man shall be without a domicile, and to secure this end the law attributes to every individual as soon as he is born the domicile of his father, if the child be legitimate, and the domicile of his mother, if the child be illegitimate. This is called the domicile of origin, and is involuntary. It is the creation of the law, not of the party. It may be extinguished by act of law, as for example by sentence of death or exile for life, which destroys the *status civilis* of the criminal; but it cannot be destroyed by the will and act of the party. Domicile of choice is the creation of the party. When a domicile of choice is acquired, the domicile of origin is in abeyance, but is not absolutely extinguished or obliterated. When a domicile of choice is abandoned, the domicile of origin revives, a special intention to revert to it not being necessary. A natural-born Englishman may domicile himself in Holland, but if he breaks up his establishment there and quits Holland, declaring that he will never return, it is absurd to suppose that his Dutch domicile clings to him until he has set up his tabernacle elsewhere." If to this we add that legitimate minors follow the changes of the father's domicile and a married woman follows the domicile of her husband, also that compulsory detention will not create a domicile, the outlines of involuntary domicile will have been sufficiently sketched.

For the establishment of a domicile of choice there must be both *animus* and *factum*, intention and fact. The fact need not be more than arrival in the territory of the new domicile if there be the necessary intention, while any number of years' continuance there will not found a domicile if the necessary intention is absent. As the result of the most recent English and Scottish cases it may be laid down that the necessary intention is incompatible with the contemplation by the person in question of any event on the occurrence of which his residence in the territory in question would cease, and that if he has not formed a fixed and settled purpose of settling in that territory, at least his conduct and declarations must lead to the belief that he would have declared such a purpose if the necessity of making an election between that territory and his former one had arisen. The word territory, meaning a country having a certain legal system, is used advisedly, for neither the intention nor the fact need refer to a locality. It is possible that a Scotsman or a foreigner may have clearly established a domicile of choice in England, although it may be impossible to say whether London, Brighton or a house in the country is his true or principal residence. What is here laid down has been gradually attained. In the older English cases an intention to return to the former domicile was not excluded, if the event on which the return depended was highly uncertain and regarded by the person in question as remote. Afterwards a tendency towards the opposite extreme was manifested by requiring for a domicile of choice the intention to associate oneself with the ideas and habits of the new territory—*Quatenus in illo exuere patriam*, not in the political sense, which it was never attempted to connect with change of domicile, but in the social and legal sense. At present it is agreed that the only intention to be considered is that of residence, but that, if the intention to reside in the territory be proved to amount to what has been above stated, a domicile will be acquired from which the legal consequences will follow, even defeating intentions about them so clearly expressed as, for instance, by making a will which by reason of the change of domicile is invalid. The two most important cases are *Douglas v. Douglas*, 1871, L. R. 12 Equity 617, before Vice-chancellor Wickens, and *Winans v. At. Gen.*, 1904, Appeal Cases 287, before the House of Lords.

When the circumstances of a person's life point to two territories

as domiciles, the selection of the one which alone can fill that character often leads to appeals even up to the highest court. The residence of a man's wife and family as contrasted with his place of business, his exercise of political or municipal functions, and any conduct which tends to connect his children with a given country, as by their education or the start given them in life, as well as other indications, are often cited as important; but none of them are in themselves decisive. The situation must be considered as a whole. When the question is between the domicile of origin and an alleged one of choice, its solution is rendered a little easier than it is when the question is between two alleged domiciles of choice, the burden of proof lying on the party which contends that the domicile of origin has been abandoned.

In the state of the law which has been described it will not be found surprising that an act of parliament, 24 & 25 Vict. c. 121, recites that by the operation of the law of domicile the expectation and belief of British subjects dying abroad with regard to the distribution of their property are often defeated, and enacts that when a convention to that effect has been made with any foreign country, no British subject dying in such country shall be deemed to have acquired a domicile therein, unless he has been resident in such country for one year previous to death and has made a declaration in writing of his intention to become domiciled; and that British subjects so dying without having so resided and made such declaration shall be deemed for all purposes of testate or intestate succession as to movables to retain the domicile they possessed at the time of going to reside in such foreign country. Similar exemptions are conferred on the subjects of the foreign state dying in Great Britain or Ireland. But the act does not apply to foreigners who have obtained letters of naturalization in any part of the British dominions. It has not been availed of, and is indeed an anachronism, ignoring as it does the fact that domicile has no longer a world-wide importance, owing to the substitution for it of political nationality as a test of private law in so many important countries. The United States of America is not one of those countries, but there the importance of domicile suffers from the habit of referring questions of capacity to the law of the place of contract instead of to any personal law. (JNO. W.)

DOMINIC, SAINT (1170-1221), founder of the Dominican Order of Preaching Friars, was born in 1170 at Calaroga in Old Castile. He spent ten or twelve years in study, chiefly theological, at Palencia, and then, about 1195, he was ordained and became a canon in the cathedral chapter of Oama, his native diocese. The bishop induced his canons to follow the Rule of St Augustine and thus make themselves Augustinian Canons (q.v.); and so Dominic became a canon regular and soon the prior or provost of the cathedral community. The years from 1195 to 1203 have been filled up with fabulous stories of missions to the Moors; but Dominic stayed at Oama, preaching much in the cathedral, until 1203, when he accompanied the bishop on an embassy in behalf of the king of Castile to "The Marches." This has commonly been taken as Denmark, but more probably it was the French or Italian Marches. When the embassy was over, the bishop and Dominic repaired to Rome, and Innocent III. charged them to preach among the Albigenian heretics in Languedoc. For ten years (1205-1215) this mission in Languedoc was the work of Dominic's life.

The Albigenes (q.v.) have received much sympathy, as being a kind of pre-Reformation Protestants; but it is now recognized that their tenets were an extreme form of Manichæism. They believed in the existence of two gods, a good (whose son was Christ) and an evil (whose son was Satan); matter is the creation of the evil principle, and therefore essentially evil, and the greatest of all sins is sexual intercourse, even in marriage; sinful also is the possession of material goods, and the eating of flesh meat, and many other things. So great was the abhorrence of matter that some even thought it an act of religion to commit suicide by voluntary starvation, or to starve children to death (see article "Neu-Manichæer" by Otto Zöckler in ed. 3 of Herzog's *Realencyklopædie für protestantische Theologie* (1903); or c. iii. of

Paul Sabatier's *Life of St Francis*). Such tenets were destructive not only of Catholicism but of Christianity of any kind and of civil society itself; and for this reason so unecclesiastical a person as the emperor Frederick II. tried to suppress the kindred sects in Italy. In 1208, after the murder of a papal legate, Innocent III. called on the Christian princes to suppress the Albigenian heresy by force of arms, and for seven years the south of France was devastated by one of the most bloodthirsty wars in history, the Albigenes being slaughtered by thousands and their property confiscated wholesale.

During this time, it is the judgment of the most recent Protestant writer on St Dominic that, though keeping on good terms with Simon de Montfort, the leader, and praying for the success of the crusaders' arms during the battle of Muret, "yet, so far as can be seen from the sources, Dominic took no part in the crusade, but endeavoured to carry his spiritual activity on the same lines as before. The oldest trustworthy sources know nothing of his having exercised the office of Inquisitor during the Albigenian war" (Grützmacher). This verdict of a fair-minded and highly competent Protestant church historian on the most controverted point of Dominic's career is of great value. His method was to travel over the country on foot and barefooted, in extreme poverty, simplicity and austerity, preaching and instructing in highways and villages and towns, and in the castles of the nobility, controverting and discussing with the heretics. He used often to organize formal disputations with Albigenian leaders, lasting a number of days. Many times plots were laid against his life. Though in his ten years of preaching a large number of converts were made, it has to be said that the results were not such as had been hoped for, and after it all, and after the crusade, the population still remained at heart Albigenian. A sense of failure appears in Dominic's last sermon in Languedoc: "For many years I have exhorted you in vain, with gentleness, preaching, praying and weeping. But according to the proverb of my country, 'where blessing can accomplish nothing, blows may avail.' We shall rouse against you princes and prelates, who, alas, will arm nations and kingdoms against this land . . . and thus blows will avail where blessings and gentleness have been powerless." The threat that seems to be conveyed in these words, of trying to promote a new crusade, was never carried out; the remaining years of Dominic's life were wholly given up to the founding of his order.

The Order of Dominicans grew out of the little band of volunteers that had joined Dominic in his mission among the Albigenes. He had become possessed with the idea of addressing wider circles and of forming an order whose vocation should be to preach and missionize throughout the whole world. By 1214 the nucleus of such an institute was formed round Dominic and was known as the "Holy Preaching." In 1215 the bishop of Toulouse, Dominic's great friend, established them in a church and house of the city, and Dominic went to Rome to obtain the permission of Innocent III. to found his order of preachers. The course of events is traced in the article **DOMINICANS**. After three years, in 1218, the full permission he desired was given by Honorius III. These last years of his life were spent in journeying backwards and forwards between Toulouse and Rome, where his abode was at the basilica of Santa Sabina on the Aventine, given to him by the pope; and then in extended journeys all over Italy, and to Paris, and into Spain, establishing friaries and organizing the order wherever he went. It propagated and spread with extraordinary rapidity, so that by Dominic's death in 1221, only five or six years after the first practical steps towards the execution of the idea, there were over 500 friars and 60 friaries, divided into 8 provinces embracing the whole of western Europe. Thus Dominic was at his death able to contemplate his great creation solidly established, and well launched on its career to preach to the whole world.

It appears that at the end of his life Dominic had the idea of going himself to preach to the heathen Kuman Tatars on the Dnieper and the Volga. But this was not to be; he was worn out by the incessant toils and fatigues and austerities of his laborious life, and he died at his monastery at Bologna, on the

6th of August 1221. He was canonized in 1234 by Gregory IX, who, as Cardinal Ugolino, had been the great friend and supporter both of Dominic and of Francis of Assisi. As St Dominic's character and work do not receive the same general recognition as do St Francis of Assisi's, it will be worth while to quote from the appreciation by Prof. Grützmacher of Heidelberg:—"It is certain that Dominic was a noble personality of genuine and true piety. . . . Only by the preaching of pure doctrine would he overcome heretics. . . . He was by nature soft-hearted, so that he often shed tears through warm sympathy. . . . In the purity of his intention and the earnestness with which he strove to carry out his ideal, he was not inferior to Francis."

The chief sources for St Dominic's life are the account by Jordan of Saxony, his successor as master-general of the order, and the evidence of the witnesses at the Process of Canonization, —all in the Bollandists' *Acta sanctorum*, Aug. 4. Probably the best modern Life is that by Jean Guiraud, in the series *Les Saints* (translated into English by Katharine de Mattos, 1907); the bibliography contains a useful list of the chief sources for the history of St Dominic and the order, and of the best modern works thereon. See also the article "Dominicus" in ed. 2 of Wetzer and Welte, *Kirchenlexicon*, and Grützmacher's excellent article "Dominikus" in ed. 3 of Herzog, *Realencyclopädie für protestantische Theologie*, already referred to. (E. C. B.)

DOMINICA, the largest of the five presidencies in the colony of the Leeward Islands, British West Indies. It lies in 15° 30' N. and 61° 20' W., between the French islands of Martinique and Guadeloupe, at a distance of about 25 m. from each, is 29 m. long, has a maximum breadth of 16 m. and an area of 201 sq. m. A range of lofty rugged mountains traverses the island from N. to S., broken in the centre by a narrow plain drained by the rivers Layou and Pagoua, flowing W. and E. respectively. The highest point is Morne Diablotin (5314 ft.), situated in the northern half of the range. Signs of volcanic activity abound in the shape of solfataras, subterranean vapours and hot springs; while in the south is the greatest natural curiosity, the renowned Boiling Lake. It lies on the mountain side, 2300 ft. above the sea, its banks are steep and its depth unknown, being more than 300 ft. at a short distance from the margin. Its seething waters are often forced 3 ft. above the normal level by the pressure of the escaping gases; and the fumes rising from the lake are occasionally poisonous. The island is botanically remarkable for its great number of peculiar species, offering in this respect a marked contrast to the poverty of the adjacent islands. The hills are covered with valuable timber, while coffee, limes, oranges, india-rubber trees, spices and all tropical fruits grow luxuriantly in the rich brown mould of the lowlands. There are some thirty streams of considerable size, besides numerous mountain torrents, and this abundance of water renders the island very fertile. The fisheries are productive, and honey and wax are furnished by wild bees, originally introduced from Europe. The temperature varies from 78° to 86° F. in the hot season from August to October, and from 72° to 84° in the cooler months; the rainfall varies in different parts from 50 to 162 in. per annum, but the porous soil soon absorbs the rain, rendering the atmosphere dry and invigorating.

The manufactures include sugar, lime-juice and essential oils; the exports are coffee, cocoa, sugar, limes and lime-juice, essential oils and fruit of all kinds. The inhabitants in 1901 numbered 28,894. The majority are negroes; the whites are of French and British descent. There are also a few Caribs, the remnant of the aboriginal population. A French *patois* is the language of the peasantry, but English is generally understood. The capital, Roseau (5764), is a fortified town and a port; Portsmouth, the only other town, possesses the better harbour in Prince Rupert's Bay on the north-west. In religion the Roman Catholics predominate, and a bishop resides at Roseau, but there is no established church. Education is free and compulsory, and the Cambridge local examinations are held annually.

Dominica was so named on its discovery by Columbus in 1493, in commemoration of the date, Sunday (*Dies Dominica*) the 3rd of November. Dominica was included in the grant of various islands in the Caribbean Sea made in 1627 by Charles I. to the earl of Carlisle, but the first European settlers (1632) were French. They brought with them negro slaves and lived on terms of

friendship with the Caribs, who were then a numerous body. In 1660 a treaty appears to have been made between the French, British and the natives assigning St Vincent and Dominica to the Caribs, but shortly afterwards attempts were made by the British to gain a foothold in the island. These attempts failed, and in 1748 it was once more agreed by France and Great Britain that Dominica should be left in the undisturbed possession of the natives. Nevertheless the French settlers increased, and the island came under the rule of a French governor. It was captured by the British in 1761 and formally ceded by France at the peace of Paris, 1763, French settlers being secured in their estates. In 1778 a French force from Martinique seized the island. Rodney's victory over De Grasse in the neighbouring sea in 1782 was followed by the restoration of the island to Britain in 1783; in the interval the trade of Dominica had been ruined. In 1795 a force from Guadeloupe made an unsuccessful descent on the island, and in 1805 the French general La Grange, at the head of 4000 troops, took Roseau and pillaged the island—an event now remembered as the most memorable in its history. The French were, however, unable to make good their hold, and Dominica has remained since undisturbed in British possession. Its later history presents few features not common to the other British West Indian islands.

Since 1872 Dominica has formed part of the colony of the Leeward Islands, but local affairs are in the hands of an administrator, aided by an executive council of ten members. In 1898 the local legislature, in consideration of pecuniary assistance from Great Britain, passed an act abrogating the semi-elective constitution and providing for a legislative council of twelve nominated members, six of whom sit *ex officio*.

DOMINICANS, otherwise called Friars Preachers, and in England Black Friars, from the black mantle worn over a white habit, an order of friars founded by St Dominic (q.v.). Their first house was in Toulouse, where the bishop established them at the church of St Romain, 1215. Dominic at once went to Rome to obtain permission to found an order of preachers whose sphere of activity should be the whole world, but Innocent III. said they must adopt one of the existing rules. Dominic returned to Toulouse and it was resolved to take the Rule of St Augustine, Dominic himself having been an Augustinian canon at Osma (see AUGUSTINIAN CANONS). Dominic went again to Rome, and during the year 1216 he obtained from Honorius III. a series of confirmations of the community at Toulouse as a congregation of Canons Regular of St Augustine with a special mission to preach. Early in 1218 an encyclical bull was issued to the bishops of the whole Catholic world recommending to them the "Order of Friars Preachers," followed in 1221 by another ordering them to give to the friars faculties to preach and hear confessions in their dioceses. Already in 1217 Dominic had scattered the little band of seventeen over the world—to Paris, into Spain, and one he took with himself to Rome. Within a few months there were forty friars in Rome, at Santa Sabina on the Aventine, and thirty in Paris; and before Dominic's death in 1221 friaries had been established at Lyons, Limoges, Reims, Metz, Poitiers and Orleans; at Bologna, Milan, Florence, Verona, Piacenza and Venice; at Madrid, Palencia, Barcelona and Seville; at Friesach in Carinthia; at Cracow and Prague; and friars were on their way to Hungary and England.

The order took definite shape at the two general chapters held at Bologna in 1220 and 1221. At first it had been but a congregation of canons regular and had worn the canons' black cassock with white linen rochet. But now a white woollen habit with a black cloak or mantle was assumed. The Rule of St Augustine was supplemented by a body of regulations, adopted mostly from those of the Premonstratensian canons. At the head of the order was the master-general, elected for life until recent times, when the term of office was limited to six and then to twelve years; he enjoys supreme power over the entire order, both houses and individuals, all of whom are directly subject to him. He dwells in Rome and is assisted by a council. The order is divided into provinces and over each is a provincial, elected for four years. Each friary has its prior, elected by the community

every four years. The friars belong not to the house or province in which they make their profession, but to the order; and it rests with the master-general to assign to each his place of residence. The manner of life was very austere—midnight office, perpetual abstinence from meat, frequent disciplines, prolonged fasts and silence. At St Dominic's suggestion, and under his strong pressure, but not without considerable opposition, the general chapter determined that the poverty practised in the order should be not merely individual, as in the monastic orders, but corporate, as among the Franciscans; so that the order should have no possessions, except the monastic buildings and churches, no property, no fixed income, but should live on charity and by begging. Thus, doubtless in imitation of the Franciscans, the Dominicans became a mendicant order.

The extraordinarily rapid propagation of the institute suffered no diminution through the founder's death; this was mainly due to the fact that his four immediate successors in the generalate were men of conspicuous ability and high character. In a few years the Dominicans penetrated into Denmark, Sweden, Russia, Prussia and Poland, preaching and missionizing in the still pagan districts of these countries; and soon they made their way to Greece and Palestine and thence to central Asia. St Hyacinth, a Pole received by St Dominic, during missionary journeys extending over thirty-five years travelled over the north and east of Europe and into Tatar, Tibet and northern China. In 1252 the pope addressed a letter to the Dominicans who were preaching "among the Saracens, Greeks, Bulgarians, Kumans, Syrians, Goths, Jacobites, Armenians, Jews, Tatars, Hungarians." From the 14th century until the middle of the 17th the Dominicans had numerous missions in Persia, India and China, and in the northern parts of Africa. They followed the Spanish and Portuguese explorers and conquerors both to the East and to the West, converting, protecting and civilizing the aborigines. On these missionary enterprises great numbers of Dominicans laid down their life for the Gospel.

Another conspicuous field of work of the Dominicans lay in the universities. It had been St Dominic's policy to aim at founding houses first of all in the great university towns—at Paris, Bologna, Palencia, Oxford. This policy was adhered to, and the Dominicans soon became a power in the universities, occupying chairs in those just named and in Padua, Cologne, Vienna, Prague and Salamanca. The scholastic doctors Albert the Great and Thomas Aquinas were the leaders in this side of Dominican activity, and the order's influence on the course of medieval theological development was exercised mainly by these doctors and by the Dominican school of theology, which to this day has maintained the principles and methods elaborated by St Thomas.

The Dominican name is in an especial way associated with the Inquisition, the office of Inquisitor in all countries, including Spain, having usually been held by Dominicans. The vicissitudes of the order have been much like those of other orders—periods of relaxation being followed by periods of revival and reform; but there were not any reforms of the same historical importance as in most other orders, the policy having been to keep all such movements strictly within the organization of the order. In 1425 Martin V. relaxed for some houses the law of corporate poverty, allowing them to hold property, and to have fixed sources of income; and fifty years later Sixtus IV. extended this mitigation to the entire order, which thereby ceased to be mendicant. This change caused no troubles, as among the Franciscans, for it was felt that it did not touch St Dominic's fundamental idea.

The Friars Preachers came to England and were established at Oxford in 1221, and by the end of the century fifty friaries were founded all over England, usually in the towns, and several in Ireland and Scotland. In London they were first on the-site of Lincoln's Inn, but in 1275 they migrated to that now occupied by Printing-house Square, and their name survives in Blackfriars Bridge. The only nunnery was at Dartford. At the Dissolution there were fifty-seven friaries (see lists in F. A. Gasquet's *English Monastic Life*, *Catholic Dictionary* and C. F. Palmer's *Life of Cardinal Howard*, where historical notes are added). In Mary's reign some of the scattered friars were brought together and

established in Smithfield, and the remnant of the nuns were restored to Dartford. In 1559 these houses were suppressed and the nuns and two friars expatriated, and for a hundred years there was no English Dominican community. But throughout the reigns of Elizabeth and the early Stuarts there were usually some Dominicans, either Englishmen professed in foreign monasteries or foreigners, labouring on the English mission or attached to the foreign embassies. In 1658 Friar Thomas Howard (afterwards Cardinal) succeeded in establishing at Bornhem near Antwerp a house for the English friars. From that time there has always been an organized body of English Dominicans, again and again reduced almost to extinction, but ever surviving; it now has half a dozen thriving friaries. The Irish province also survived the days of persecution and possesses a dozen friaries. In 1840 Lacordaire restored the French province. In 1900 there were 4350 Dominicans, including lay brothers, and 300 friaries, scattered all over the world. Missionary work still holds a prominent place in Dominican life; there are missions in Annam, Tongking and China, and in Mesopotamia, Mosul and Kurdistan. They have also a remarkable school for Biblical studies and research at Jerusalem, and the theological faculty in the Roman Catholic university at Fribourg in Switzerland is in their hands. There have been four Dominican popes: Innocent V. († 1276), Benedict XI. († 1304), Pius V. († 1572), Benedict XIII. († 1730).

The friars form the "First Order"; the nuns, or Dominicanesses, the "Second Order." The latter may claim to have chronological precedence over the friars, for the first nunnery was established by St Dominic in 1206 at Prouille in the diocese of Toulouse, as a refuge for women converted from the Albigensian heresy. The second convent was at San Sisto in Rome, also founded by Dominic himself. From that time the institute spread widely. The rule resembled that of the friars, except that the nuns were to be strictly enclosed and purely contemplative; in course of time, however, they undertook educational work. In 1909 there were nearly 100 nunneries of the Second Order, with some 2500 nuns. They have schools and orphanages in South Africa, especially in the Transvaal.

A considerable number of other convents for women follow the Rule of the "Third Order." This rule was not written until the 15th century, and it is controverted whether, and in what sense, it can be held that the "Third Order" really goes back to St Dominic, or whether it grew up in imitation of the Franciscan Tertiaries. Besides the conventual Tertiaries, there are confraternities of lay men and women who strive to carry out this rule while living their family life in the world (see TERTIARIES). St Catharine of Siena was a Dominican Tertiary.

See the authorities cited in the article DOMINIC, SAINT; also Helyot, *Hist. des ordres religieux* (1714), iii. cc. 24-29, and Max Heimbucher, *Orden u. Kongregationen* (1896), §§ 86-91; and C. F. Palmer, *Life of Cardinal Howard* (1867), which gives a special account of the English Dominican province. (E. C. B.)

DOMINIS, MARCO ANTONIO DE (1560-1624), Italian theologian and natural philosopher, was born of a noble Venetian family in 1560 in the island of Arbe, off the coast of Dalmatia. He was educated by the Jesuits in their colleges at Loreto and Padua, and is supposed by some to have joined their order; the more usual opinion, however, is that he was dissuaded from doing so by Cardinal Aldobrandini. For some time he was employed as a teacher at Verona, as professor of mathematics at Padua, and professor of rhetoric and philosophy at Brescia. In 1596 he was appointed to the bishopric of Segna (Zengg) in Dalmatia, and two years later was raised to the archbishopric of Spalato and primacy of Dalmatia and Croatia. His endeavours to reform the Church soon brought him into conflict with his suffragans; and the interference of the papal court with his rights as metropolitan, an attitude intensified by the quarrel between the papacy and Venice, made his position intolerable. This, at any rate, is the account given in his own apology—the *Consilium protectionis*—in which he also states that it was these troubles that led him to those researches into ecclesiastical law, church history and dogmatic theology, which, while confirming him in his love for the ideal of "the true Catholic Church," revealed to him how far the

papal system was from approximating to it. After a visit to Rome, when he in vain attempted to gain the ear of Pope Paul V., he resigned his see in September 1616, wrote at Venice his *Consilium profectiois*, and then went by way of Switzerland, Heidelberg and Rotterdam to England, where he arrived in December. He was welcomed by the king and the Anglican clergy with great respect, was received into the Church of England in St Paul's cathedral, and was appointed master of the Savoy (1618) and dean of Windsor (1619); he subsequently presented himself to the living of West Ilsley, Berkshire. Contemporary writers give no pleasant account of him, describing him as fat, irascible, pretentious and very avaricious; but his ability was undoubted, and in the theological controversies of the time he soon took a foremost place. His published attacks on the papacy succeeded each other in rapid succession: the *Papatus Romanus*, issued anonymously (London, 1617; Frankfurt, 1618), the *Scogli del naufragio Christiano*, written in Switzerland (London, (?) 1618), of which English, French and German translations also appeared, and a *Sermon preached in Italian, &c.*, before the king. But his principal work was the *De republica ecclesiastica*, of which the first part—after revision by Anglican theologians—was published under royal patronage in London (1617), in which he set forth with a great display of erudition his theory of the church. In the main it is an elaborate treatise on the historic organization of the church, its principal note being its insistence on the divine prerogatives of the Catholic episcopate as against the encroachments of the papal monarchy. In 1619 Dominis published in London, with a dedication to James I., Paolo Sarpi's *Historia del Concilio Tridentino*, the MS. of which he had brought with him from Venice. It is characteristic of the man that he refused to hand over to Sarpi a penny of the money present given to him by the king as a reward for this work.

Three years later the ex-archbishop was back again in Rome, doing penance for his heresies in St Peter's with a cord round his neck. The reasons for this sudden revolution in his opinions, which caused grave scandal in England, have been much debated; it is probably no libel on his memory, however, to say that they were connected with the hopes raised by the elevation of his kinsman, Alessandro Ludovisi, to the papal throne as Gregory XV. (1621). It is said that he was enticed back to Rome by the promise of pardon and rich preferment. If so, he was doomed to bitter disappointment. He had barely time to publish at Rome (1623) his *Sui reditus ex Angliæ consilium*, an abject repudiation of his anti-papal works as written "non ex cordis sinceritate, non ex bona conscientia, non ex fide," when Gregory died (July 1623). During the interregnum that followed, the proceedings of the Inquisition against the archbishop were revived, and they continued under Urban VIII. Before they were concluded, however, Dominis died in prison, on the 8th of September 1624. Even this did not end his trial, and on the 20th of December judgment was pronounced over his corpse in the church of Santa Maria sopra Minerva. By order of the Inquisition his body was taken from the coffin, dragged through the streets of Rome, and publicly burnt in the Campo di Fiore. By a strange irony of fate the publication of his *Reditus consilium* was subsequently forbidden in Venice because of its uncompromising advocacy of the supremacy of the pope over the temporal powers. As a theologian and an ecclesiastic Dominis was thoroughly discredited; as a man of science he was more happy. He was the first to put forward a true theory of the rainbow, in his *De radiis visus et lucis in vitris perspectivis et iride* (Venice, 1611).

See the article by Canon G. C. Perry in the *Dict. Nat. Biog.*, and that by Benrath in Herzog-Hauck, *Realencyclopädie* (ed. 1898), iv. p. 781, where a full bibliography is given. Also H. Newland, *Life and Contemporaneous Church History of Antonio de Dominis* (Oxford, 1859).

DOMINOES, a game unknown until the 18th century, and probably invented in Italy, played with twenty-eight oblong pieces, or dominoes, known also as *cards* or *stones*, having ivory faces backed with ebony; from this ebony backing, as resembling the cloak (usually black) called a domino (see *MASK*), the name is said to be derived. Cardboard dominoes to be held in the hand are also in use. The face of each card is divided into two squares

by a black line, and in each square half the value of the card is indicated by its being either a blank or marked with one or more black pips, generally up to six, but some sets run as high as double-nine. There are various ways of playing dominoes described below.

The Black and Draw Games.—The dominoes are shuffled face downwards on the table. The lead is usually decided by drawing for the highest card, but it is sometimes held that any doublet takes precedence. The cards are then reshuffled, and each player draws at random the number of cards required for the particular form of the game, usually seven. The cards left behind are called the *stock*. To play a card is known technically as to *pose*. The leader poses first, generally playing his highest domino, since at the end the player loses according to the number of pips in the cards he has left in his hand. By some rules, a player after playing a double may play another card which matches it: e.g. if he plays double-six he may play another card which has a six at one end. The second player has to match the leader's pose by putting one of his cards in juxtaposition at one end, i.e. if the leader plays four-five, the second player has to play a card which contains either a four or a five, the five being applied to the five, or the four to the four. Doublets are placed *à cheval* (*crosswise*). If a player cannot match, he says "go," and his opponent plays, unless the Draw game—the usual game—is being played, in which case the player who cannot match draws from the stock (two cards must always be left in the stock) till he takes a card that matches. If a player succeeds in posing all his cards, he calls "Domino!" and wins the hand, scoring as many points as there are pips on the cards still held by his opponent. If neither player can match, that player wins who has the fewest pips left in his hand, and he scores as many points as are left in the two hands combined (sometimes only the excess held by his opponent); but when a player has called "Go!" his adversary must match if he can, in which case the other player may be able to match in turn. A game is generally ten plays.

All Fines (or Muggins).—Each player takes five cards. If the leader poses either double-five, six-four, five-blank, or three-two, he scores the number of pips that are on the card. If in the course of play a player can play such a card as makes the sum of the end pips, 5, 10, 15 or 20, he scores that number; e.g. if to two-four he can play double-four (*à cheval*) he scores 10; if to six-one he plays six-four he scores 5. He must pose if he can match; if he cannot, he draws till he can. Scores are called and taken immediately. At the point of domino, the winner scores in points the multiple of five which is nearest to the number of pips in his adversary's hand: e.g. he scores 25 if his adversary has 27 pips, 30 if he has 28. If neither hand can match, the lowest number of pips wins, and the score is taken as before, without addition or subtraction, according to the adversary's pips.

All Threes is played in the same manner as Muggins, save that three or some multiple of three are aimed at.

Threes-and-Fives is similar, but only one point is scored for each five or three made at the two ends, though they can be scored in combination. Thus A plays six-five; B six-one; B scores 2 points for 5-1 (two threes). A plays one-five; B double five; B now scores 8 more, 5 for five threes and 3 for three fives.

Domino-Whist is played by four players. Partners are drawn for as at Whist, the player drawing the highest card leading. Each player takes seven cards. There are no tricks, trumps or honours. The cards are played as in ordinary dominoes, a hand being finished when one of the players plays his last card, or when both ends are blocked. Pips are then counted, and the holder or holders of the highest number score to their debit, the aggregate number of points. The side that is first debited with 100 points loses the game. Strength in a suit is indicated by the lead; i.e. a lead of double-blank or double-six implies strength in blanks or sixes respectively.

Matador (from the Spanish word meaning "killer," *le* of the bull in a bull-fight). This is a favourite and perhaps the most scientific form of the game. It is played on a different principle from the preceding variations, the object being not to match the end number, but to pose such a number, as, added to the end, will make seven; e.g. to a five a two must be played, to a three a four, &c. Seven dominoes are drawn and the highest double begins. When a player cannot make a seven on either end he must draw from the stock until he secures a card that will enable him to make seven, two cards remaining in the stock. As Matador is played with dominoes no higher than six, a blank means the blocking of that end. In this case no further play can take place at that end excepting by posing a *matador*, which may be played at any time. There are four matadors, the 6-1, 5-2, 4-3 and double-blank. It is often better to draw one or more fresh cards than to play one's last matador, as it may save the game at a critical juncture. In posing a double counts as a single number only, but in scoring the full number of pips is counted. When the game has been definitely blocked the player whose pips aggregate the lower number scores the number of the combined hands (sometimes only the excess in his opponent's hand), the game being usually 100. Matador can be played by three persons, in which case the two having the lowest scores usually combine against the threatening winner; and also by four, either each for himself or two on a side.

Other varieties of the game not often played are the Bergen game, Sevastopol and Domino Loo.

See *Card and Table Games* by Hoffmann (London, G. Routledge & Sons).

DOMINUS (from an Indo-European root *dam-*, cf. Gr. *δαῖν*, to subdue, and Eng. "tame"), the Latin word for master or owner. As a title of sovereignty the term under the republic at Rome had all the associations of the Greek *ῥήτορας*; refused during the early principate, it finally became an official title of the Roman emperors under Diocletian. *Dominius*, the French equivalent being *sieur*, was the Latin title of the feudal (superior and mesne) lords, and also an ecclesiastical and academical title. The ecclesiastical title was rendered in English "sir," which was a common prefix before the Reformation for parsons, as in "Sir Hugh Evans" in Shakespeare's *Merry Wives of Windsor*. The academical use was for a bachelor of arts, and so is still used at Cambridge and other universities. The shortened form "dom" is used as a prefix of honour for ecclesiastics of the Roman Church, and especially for members of the Benedictine and other religious orders. The same form is also a title of honour in Portugal, as formerly in Brazil, used by members of the blood royal and others on whom it has been conferred by the sovereign. The Spanish form "don" is also a title, formerly applicable only to the nobility, and now one of courtesy and respect applied to any member of the better classes. The feminine form "donna" is similarly applied to a lady. The English colloquial use of "don" for a fellow or tutor of a college at a university is derived either from an application of the Spanish title to one having authority or position, or from the academical use of *dominus*. The earliest use of the word in this sense appears, according to the *New English Dictionary*, in South's *Sermons* (1660). An English corruption "dan" was in early use as a title of respect, equivalent to "master." The particular literary application to poets is due to Spenser's use of "Dan Chaucer, well of English undefyled" (*Fairy Queen*, IV. ii. 32).

DOMITIAN (TRUS FLAVIUS DOMITIANUS), Roman emperor A.D. 81-96, the second son of Titus Flavius Vespasianus and Flavia Domitilla, twelfth of the Caesars, and third of the Flavian dynasty, was born at Rome on the 24th of October A.D. 51. When Vespasian was proclaimed emperor at Alexandria, Domitian escaped with difficulty from the temple of the Capitol, which had been set on fire by the Vitellians, and remained in hiding till his father's party proved victorious. After the fall of Vitellius he was saluted as Caesar, or prince imperial, by the troops, obtained the city praetorship, and was entrusted with the administration of Italy till his father's return from the East. But although in his father's lifetime he several times filled the office of consul, and after his death was nominally the partner in the empire with his brother Titus, he never took any part in public business, but lived in great retirement, devoting himself to a life of pleasure and of literary pursuits till he succeeded to the throne. The death of Titus, if not hastened by foul means, was at least eagerly welcomed by his brother. Domitian's succession (on the 13th of September 81) was unquestioned, and it would seem that he had intended, so far as his weak volition and mean abilities would allow, to govern well. Like Augustus, he attempted a reformation of morals and religion. As chief pontiff he inquired rigorously into the character of the vestal virgins, three of whom were buried alive; he enforced the laws against adultery, mutilation, and the grosser forms of immorality, and forbade the public acting of mimes. He erected many temples and public buildings (amongst them the Odeum, a kind of theatre for musical performances) and restored the temple of the Capitol. He passed many sumptuary laws, and issued an edict forbidding the over-cultivation of vines to the neglect of corn-growing. Finally, he took a personal share in the administration of justice at Rome, checked the activity of the informers (*delatores*), and exercised a jealous supervision over the governors of provinces. Such public virtues at first counterbalanced his private vices in the eyes of the people. Domitian was the first emperor who arrogated divine honours in his lifetime, and caused himself to be styled *Our Lord and God* in public documents. Doubtless in the poems of writers like Martial this

deification was nothing but fulsome flattery, but in the case of the provincials it was a sincere tribute to the impersonation of the Roman Empire, as the administrator of good government and the peacemaker of the world. Even when Rome and Italy smarted beneath his proscriptions and extortions, the provinces were undisturbed.

Though he took the title of emperor more than twenty times, and enjoyed at least one triumph, Domitian's military achievements were insignificant. He defeated the Chatti, annexed the district of the Taunus, and established the *Limes* as a line of defence; but he suffered defeats at the hands of the Quadi, Sarmatae and Marcomanni; in Dacia he received a severe check, and was obliged to purchase peace (90) from Decebalus by the payment of a large sum of money and by guaranteeing a yearly tribute—the first instance in Roman history. His jealousy was provoked by the successes of Agricola in Britain, who was recalled to Rome (85) in the midst of his conquests, condemned to retirement, and perhaps removed by poison. The revolt of Antonius Saturninus, the commander of the Roman forces in Upper Germany (88 or 89), marks the turning-point in his reign (on the date see H. Schiller, *Geschichte der römischen Kaiserzeit*, i. pt. 2, p. 524, note 2). It was speedily crushed; but from that moment Domitian's character changed. He got rid of all whom he disliked on the charge of having taken part in the conspiracy, and no man of eminence was safe against him. He was in constant fear of assassination and distrusted all around him. During the last three years of his life his behaviour was that of a madman. He sentenced to death his own cousin and nephew by marriage, Flavius Clemens, whose wife he banished for her supposed leaning towards Judaism (Christianity). A conspiracy among his own freedmen—set on foot, it is said, by his wife Domitia Longina, who knew her own life to be threatened—cut short his career. He was stabbed in his bedroom by a freedman of Clemens named Stephanus on the 18th of September 96.

AUTHORITIES. Ancient.—Tacitus, *Historiae*, iii. iv.; Suetonius, *Domitian*; Dio Cassius lvi., lvii.; Tacitus, *Agricola*, 18-22. Modern accounts by A. Imhof, *T. Flavius Domitianus* (Halle, 1857), which, while not claiming any special originality, is based on a conscientious study of authorities; A. Halberstadt, *De imperatoris Domitiani moribus et rebus* (Amsterdam, 1877), an attempt to rehabilitate Domitian; S. Geell, *Essai sur le règne de l'empereur Domitien* (1894), very complete in every respect; H. Schiller (as above), pp. 520-538; C. Merivale, *Hist. of the Romans under the Empire*, ch. 61, 62. For Domitian's attitude towards Christianity, see V. Schultze in Herzog-Hauck's *Realencyclopädie für protestantische Theologie*, iv. (1898); Sir W. M. Ramsay, *The Church in the Roman Empire* (1903); E. G. Hardy, *Christianity and the Roman Government* (1894); J. B. Bury, Appendix 8 to vol. ii. of his edition of Gibbon.

DOMRÉMY-LA-PUCELLE, a village of eastern France, in the department of Vosges, on the left bank of the Meuse, 7 m. N. of Neufchâteau by road. Pop. (1906) 233. Domrémy was the birthplace of Joan of Arc, and the cottage in which she was born still stands. Above the door are the arms of France and of Joan of Arc and an inscription of 1481 reading "Vive labour; vive le roi Louys." There are several monuments to the heroine, and a modern basilica has been erected in her honour on a neighbouring hill, where she is said to have heard the voices in obedience to which she took up the sword. The story of the heroine is annually celebrated by a play in which the villagers take part.

DON (anc. *Tanaïs*), a river of European Russia, called *Tana* or *Duna* by the Tatars, rising in Lake Uvan (580 ft. above sea-level) in the government of Tula, where it has communication with the Volga by means of the Yepifan Canal, which links it with the Upa, a tributary of the Oka, which itself enters the Volga. The Don, after curving east through the government of Ryazan, flows generally south through the governments of Tambov, Orel, Voronezh and the Don Cossacks territory, describing in the last-named a sweeping loop to the east, in the course of which it approaches within 48 m. of the Volga in 49° N. In the middle of the Don Cossacks territory it turns definitely south-west, and finally enters the north-east extremity of the Sea of Azov, forming a delta 130 sq. m. in extent. Its total length is 1325 m., and its drainage area is calculated at 166,000 sq. m. The average fall

of the river is about 5½ in. to the mile. In its upper course, which may be regarded as extending to the confluence of the Voronezh in 51° 40', the Don flows for the most part through a low-lying, fertile country, though in the government of Ryazan its banks are rocky and steep, and in some places even precipitous. In the middle division, or from the mouth of the Voronezh to the point where it makes its nearest approach to the Volga, the stream cuts its way for the most part through Cretaceous rocks, which in many places rise on either side in steep and elevated banks, and at intervals encroach on the river-bed. A short distance below the town of Rostov it breaks up into several channels, of which the largest and most southern retains the name of the river. Before it receives the Voronezh the Don has a breadth of 500 to 700, or even in a few places 1000 ft., while its depth varies from 4 to 20 ft.; by the time it reaches its most eastern point the depth has increased to 8-50 ft., and the ordinary breadth to 700-1000 ft., with an occasional maximum of 1400 ft.; in the lowest division the depth is frequently 70 ft., and the breadth in many places 1870 ft. Generally speaking, the right bank is high and the left flat and low. Shallow reaches are not uncommon, and there are at least seven considerable shoals in the south-western part of the course; partly owing to this cause, and partly to the scarcity of ship-timber in the Voronezh government, the Don, although navigable as far up as Voronezh, does not attain any great importance as a means of communication till it reaches Kachalinskaya in the vicinity of the Volga. From that point, or rather from Kalach, where the railway (built in 1862) of the Volga has its western terminus, the traffic is very extensive. Of the tributaries of the river, the Voronezh, the Khopor, the Medvyeditsa and the Donets are navigable—the Donets having a course of 680 m., and during high water affording access to the government of Kharkov. The Manych, another large affluent on the left, marks the ancient line of water connexion between the Sea of Azov and the Caspian Sea. The lower section of the Don is subject to two annual floods, of which the earlier, known as the "cold water," is caused by the melting of the snow in the country of the Don Cossacks, and the later, or the "warm water," is due to the same process taking place in the region drained by the upper parts of the stream. About the beginning of June the river begins to subside with great rapidity; in August the water is very low and navigation almost ceases; but occasionally after the September rains the traffic with small craft is again practicable. Since the middle of the 18th century there have been five floods of extraordinary magnitude,—namely, in 1748, 1786, 1805, 1820 and 1845. The river is usually closed by ice from November or December to March or April, and at rare intervals it freezes in October. At Aksai, in the delta, it remains open on the average for 250 days in the year, at the mouth of the Medvyeditsa for 239, and at Novo-Cherkask, on another arm of the delta, for 246. This river supports a considerable fishing population, who despatch salt fish and caviare all over Russia. Salmon and herrings are taken in large numbers.

(P. A. K.; J. T. BE.)

DON, a river in the south of Aberdeenshire, Scotland, rising in peat-moss to the east of Glen Avon on the borders of Banffshire, at a height of nearly 2000 ft. above the sea. It follows a generally easterly course, roughly parallel with that of the Dee, and a few miles to the south of it, falling into the North Sea close to Old Aberdeen, after a run of 82 m. At the mouth the two rivers are only 2½ m. apart. Like its greater neighbour, the Don is an excellent salmon stream. On the left its chief affluents are the Ernan, Nocht, Bucket and Urie; on the right, the Conrie, Carvie, Deskry and Strow. The principal places of interest on its banks are Strathdon, Towie, Kildrummy, Alford, Keig, Monymusk, Inverurie, Kintore and Dyce.

DONAGHADEE, a market town of Co. Down, Ireland, in the north parliamentary division, near the south of Belfast Lough, on the Irish Channel, 25 m. E. by N. of Belfast by a branch of the Belfast and Co. Down railway. Pop. (1901) 2073. It is the nearest port in Ireland to Great Britain, being 21½ m. S.W. of Portpatrick in Wigtownshire. Telegraph and telephone cables join these ports, but a regular passenger route does not exist owing to the unsuitability of Portpatrick. Donaghadee harbour admits

vessels up to 200 tons. On the north-east side of the town there is a rath or encampment 70 ft. high, in which a powder magazine is erected. The parish church dates from 1626. There are two holy wells in the town. The town is frequented as a seaside watering-place in the summer months.

DONALDSON, SIR JAMES (1831—), Scottish classical scholar, educational and theological writer, was born at Aberdeen on the 26th of April 1831. He was educated at Aberdeen University and New College, London. In 1854 he was appointed rector of the Stirling high school, in 1866 rector of that of Edinburgh, in 1881 professor of humanity in the university of Aberdeen, and in 1890 principal of the university of St Andrews. by the Universities (Scotland) Act. His chief works are: *Modern Greek Grammar* (1853); *Lyra Graeca* (1854), specimens of Greek lyric poetry from Callinus to Soutsos; *A Critical History of Christian Literature and Doctrine from the Death of the Apostles to the Nicene Council* (i.-iii., 1864-1866; new ed. of L as *The Apostolic Fathers*, 1874), a book unique of its kind in England at the time of its appearance and one which adds materially to the knowledge of Christian antiquities as deduced from the apostolic fathers; *Lectures on the History of Education in Prussia and England* (1874); *The Westminster Confession of Faith and the Thirty-Nine Articles of the Church of England* (1905); *Woman, her position and influence in ancient Greece and Rome* (1907). He was knighted in 1907.

DONALDSON, JOHN WILLIAM (1811-1861), English philologist and biblical critic, was born in London on the 7th of June 1811. He was educated at University College, London and Trinity College, Cambridge, of which society he subsequently became fellow. In 1841 he was elected headmaster of King Edward's school, Bury St Edmunds. In 1855 he resigned his post and returned to Cambridge, where his time was divided between literary work and private tuition. He died on the 10th of February 1861. He is remembered as a pioneer of philology in England, and as a great scholar in his day, though much of his work is now obsolete. *The New Cratylus* (1839), the book on which his fame mainly rests, was an attempt to apply to the Greek language the principles of comparative philology. It was founded mainly on the comparative grammar of Bopp, but a large part of it was original, Bopp's grammar not being completed till ten years after the first edition of the *Cratylus*. In the *Varronianus* (1844) the same method was applied to Latin, Umbrian and Oscan. His *Jashar* (1854), written in Latin as an appeal to the learned world, and especially to German theologians, was an attempt to reconstitute the lost biblical book of Jashar from the remains of old songs and historical records, which, according to the author, are incorporated in the existing text of the Old Testament. His bold views on the nature of inspiration, and his free handling of the sacred text, aroused the anger of the theologians. Of his numerous other works the most important are *The Theatre of the Greeks; The History of the Literature of Ancient Greece* (a translation and completion of C. O. Müller's unfinished work); editions of the *Odes* of Pindar and the *Antigone* of Sophocles; a Hebrew, a Greek and a Latin Grammar.

DONATELLO (diminutive of Donato) (c. 1386-1466), Italian sculptor, was the son of Niccolò di Betto Bardi, a member of the Florentine Woolcombers' Guild, and was born in Florence probably in 1386. The date is conjectural, since the scanty contemporary records of Donatello's life are contradictory, the earliest documentary reference to the master bearing the date 1406, when a payment is made to him as an independent sculptor. That Donatello was educated in the house of the Martelli family, as stated by Vasari, and that he owed to them his introduction to his future friend and patron, Cosimo de' Medici, is very doubtful, in view of the fact that his father had espoused the cause of the Albizzi against the Medici, and was in consequence banished from Florence, where his property was confiscated. It is, however, certain that Donatello received his first training, according to the custom of the period, in a goldsmith's workshop, and that he worked for a short time in Ghiberti's studio. He was too young to enter the competition for the baptistry gates in 1402, from which Ghiberti issued victorious against Brunelleschi, Jacopo

della Quercia, Niccolò d'Arezzo and other rivals. But when Brunelleschi in his disappointment left Florence and went to Rome to study the remains of classic art he was accompanied by young Donatello. Whilst pursuing their studies and excavations on classic soil, which made them talk about amongst the Romans of the day as "treasure seekers," the two young men made a living by working at the goldsmiths' shops. This Roman sojourn was decisive for the entire development of Italian art in the 15th century, for it was during this period that Brunelleschi undertook his measurements of the Pantheon dome and of other Roman buildings, which enabled him to construct the noble cupola of S. Maria del Fiore in Florence, while Donatello acquired his knowledge of classic forms and ornamentation. The two masters, each in his own sphere, were to become the leading spirits in the art movement of the 15th century. Brunelleschi's buildings and Donatello's monuments are the supreme expression of the spirit of the early Renaissance in architecture and sculpture and exercised a potent influence upon the painters of that age.

Donatello probably did not return to Florence before 1405, since the earliest works in that city that can be traced to his chisel are two small statues of "prophets" for the north door of the cathedral, for which he received payment in November 1406 and in the beginning of 1408. In the latter year he was entrusted with the important commissions for the marble "David," now at the Bargello, and for the colossal seated figure of "St John the Evangelist," which until 1588 occupied a niche of the old cathedral façade, and is now placed in a dark chapel of the Duomo. We find him next employed at Or San Michele, where between 1340 and 1406 only four of the fourteen niches had been filled. As the result of a reminder sent by the Signory to the guilds who had undertaken to furnish the statues, the services of Ciuffagni, Nanni di Banco, Ghiberti and Donatello were enlisted, and Donatello completed between 1412 and 1415 the "St Peter," the "St George" (the original, now in the Bargello, has been replaced by a copy) and the "St Mark." He probably also assisted Nanni di Banco in his group of four saints. To this early period—in spite of Dr Bode's contention, who places it about twenty years later—belongs the wooden crucifix in S. Croce, the most striking instance of Donatello's realism in rendering the human form and his first attempt at carving the nude. It is said that this crucifix was executed in rivalry with Brunelleschi's noble work at S. Maria Novella, and that Donatello, at the sight of his friend's work, exclaimed, "It has been left to you to shape a real Christ, whilst I have made a peasant." In this early group of statues, from the prophets for the cathedral door to the "St George," can be followed the gradual advance from Gothic stiffness of attitude and draping to a forceful rendering of the human form and of movement, which is a distinct approach to the classic ideal; from the massiveness of the heavily draped figure to easy poise and muscular litheness. All these figures were carved in marble and are admirably conceived in relation to their architectural setting. In fact, so strong is this tendency that the "St Mark," when inspected at the master's workshop, was disapproved of by the heads of the Guild of Linen-weavers, but aroused public enthusiasm when placed *in situ*, and at a later date received Michelangelo's unstinted admiration.

Between the completion of the niches for Or San Michele and his second journey to Rome in 1433, Donatello was chiefly occupied with statuary work for the campanile and the cathedral, though from this period dates the bronze figure of the Baptist for the christening font of Orvieto Cathedral, which was never delivered and is now among the treasures of the Berlin museum. This, and the "St Louis of Toulouse," which originally occupied a niche at Or San Michele and is now badly placed at S. Croce, were the first works in bronze which owed their origin to the partnership of Donatello with Michelozzo, who undertook the casting of the models supplied by his senior. The marble statues for the campanile, which are either proved to be Donatello's by documentary evidence or can be recognized as his work from their style, are the "Abraham," wrought by the master in conjunction with Giovanni di Bartolo (il Rosso); the "St John the Baptist"; the so-called "Zuccone" (Jonah?);

"Jeremiah"; "Habakuk" (?); the unknown "prophet" who is supposed to bear the features of the humanist Poggio Bracciolini; and possibly he may have had a share in the completion of the "Joshua" commenced by Ciuffagni in 1415. All these statues, and the "St John" at the Bargello, mark a bold departure from the statuesque balance of the "St Mark" and "St George" to an almost instantaneous impression of life. The fall of the draperies is no longer arranged in harmonious lines, but is treated in an accidental, massive, bold manner. At the same time the heads are no longer, as it were, impersonal, but almost cruelly realistic character portraits of actual people, just as the arms and legs and necks are faithfully copied from life with all their angularities and deviations from the lines of beauty. During this period Donatello executed some work for the baptismal font at S. Giovanni in Siena, which Jacopo della Quercia and his assistants had begun in 1416. Though the Florentine's share in it is confined to a relief which may have been designed, or even begun, by Jacopo, and a few statuettes, it is of considerable importance in Donatello's life-work, as it includes his first attempt at relief sculpture—except the marble relief on the socle of the "St George"—his first female figures,—"Faith" and "Hope," and his first *putti*. The relief, "Herod's Feast," shows already that power of dramatic narration and the skill of expressing the depth of space by varying the treatment from plastic roundness to the finest *staccato*, which was to find its mature expression in the panels of the altar of S. Antonio in Padua and of the pulpit of S. Lorenzo in Florence. The casting of the pieces for the Siena font was probably done by Michelozzo, who is also credited with an important share in the next two monumental works, in the designing of which Donatello had to face a new problem—the tomb of John XXIII. in the baptistry (begun about 1425), and that of Cardinal Brancacci at S. Angelo a Nilo in Naples (executed in Pisa, 1427). The noble recumbent figure of the defunct on the former, the relief on the sarcophagus, and the whole architectural design, are unquestionably due to Donatello; the figure of the pope is the most beautiful tomb figure of the 15th century, and served as the model on which Rossellino, Desiderio, and other sculptors of the following period based their treatment of similar problems. Donatello's share in the Naples monument is probably confined to the characteristic low relief of the "Ascension." The baptistry tomb shows how completely Donatello had mastered the forms of Renaissance architecture, even before his second visit to Rome. An earlier proof of his knowledge of classic art is his niche for the "St Louis" at Or S. Michele, now occupied by Verrocchio's "Christ and St Thomas." Similar in treatment to the "Ascension" relief is the "Charge to St Peter" at South Kensington, which is almost impressionistic in its suggestion of distance and intervening atmosphere expressed by the extreme slowness of the relief. Another important work of this period, and not, as Vasari maintains, of Donatello's youth, is the "Annunciation" relief, with its wealth of delicately wrought Renaissance motifs in the architectural setting.

When Cosimo, the greatest art patron of his time, was exiled from Florence in 1433, Michelozzo accompanied him to Venice, whilst Donatello for the second time went to Rome to drink once more at the source of classic art. The two works which still testify to his presence in this city, the "Tomb of Giovanni Crivelli" at S. Maria in Aracoeli, and the "Ciborium" at St Peter's, bear the stamp of classic influence. Donatello's return to Florence in the following year almost coincides with Cosimo's. Almost immediately, in May 1434, he signed a contract for the marble pulpit on the façade of Prato cathedral, the last work executed in collaboration with Michelozzo, a veritable bacchanalian dance of half-nude *putti*, pagan in spirit, passionate in its wonderful rhythmic movement—the forerunner of the "singing tribune" for Florence cathedral, at which he worked intermittently from 1433 to 1440, and which is now restored to its original complete form at the museum of the Opera del Duomo. But Donatello's greatest achievement of his "classic period" is the bronze "David" at the Bargello, the first nude statue of the Renaissance, the first figure conceived in the round, independent of any architectural surroundings—graceful, well-proportioned—

superbly balanced, suggestive of Greek art in the simplification of form, and yet realistic, without any striving after ideal proportions. The same tendencies are to be noted in the bronze *pulso* at the Bargello.

In 1443 Donatello was invited to Padua to undertake the decoration of the high altar of S. Antonio, but in the period preceding his departure he not only assisted Brunelleschi in the decoration of the sacristy of S. Lorenzo, towards which the bronze doors are his chief contribution, but found time to chisel, or model in wax or terra-cotta, for Cosimo and other private patrons, most of the portrait busts and small reliefs, which are now distributed over the museums of the world. His first work in Padua was the bronze crucifix for the high altar, a work immeasurably superior to the early wooden crucifix at S. Croce, both as regards nobility of expression and subtlety of form. In the very year when Donatello arrived in Padua the famous Condottiere Erasmo de' Narni, called Gattamelata, had died, and when it was decided to honour his memory with an equestrian statue, it was only natural that this master should be chosen to undertake a task from the difficulties of which all others may well have shrunk—had shrunk, indeed, since classic times. This commission, and the reliefs and figures for the high altar, kept Donatello in Padua for ten years, though during that time he visited Venice (where he carved the wooden "St John" at the Frari) and probably Mantua, Ferrara and Modena. At least, he was in communication with Borso d'Este of Modena about a project for an equestrian statue, and had to give expert opinion about two equestrian statues at Ferrara. In his workshop in Padua he gathered around him quite a small army of assistants, stone-carvers, metal-workers, painters, gilders and bronze-casters. The Gattamelata was finished and set up in 1453—a work powerful and majestic in its very repose; there is no striving for dramatic effect, no exaggerated muscular action, but the whole thing is dominated by the strong, energetic head, which is modelled with the searching realism of the Zuccone and the Poggio heads. The high altar, for which Donatello executed twenty-two reliefs, seven statues and the crucifix, was completed in 1450, but had subsequently to undergo many changes, in the course of which the original disposition of the sculptures was entirely lost sight of, the present arrangement being due to Camillo Boito (1895). The chief features of the altar are the wonderfully animated and dramatic bronze reliefs, four in number, of the "Miracles of St Anthony."

With the exception of another visit to Siena in 1457, of which the bronze "St John" in the cathedral is a reminder, Donatello spent the remaining years of his life in Florence. Closely akin to the rugged "St John" at Siena, and therefore probably contemporaneous, is the repulsively ugly, emaciated "Magdalen" at the baptistery in Florence. The dramatic intensity of the "Judith" group in the Loggia de' Lanzi, which was originally placed in the court of the Medici Palace, marks it as belonging to the post-Paduan period of the master's life. His last work of importance was the bronze reliefs for the pulpit of S. Lorenzo, commissioned about 1460, and finished after Donatello's death by his pupil Bertoldo. The reliefs of the "Flagellation" and "Crucifixion" at the Victoria and Albert Museum are typical examples of the master's style at this closing period of his life. He died on the 13th of December 1466.

As happened subsequently to Velazquez and Frans Hals, Donatello, whose supreme mastery had been acknowledged by Michelangelo, Raphael and the other giants of the late Renaissance, almost sank into oblivion during the 18th and early 19th centuries, and only in comparatively recent times has he been restored to the eminent position which is his due in the history of art. The full power of his genius was only revealed to the world when, at the quincentenary celebration of his birth, the greater part of his life-work was brought together in Florence. The large hall at the Bargello has ever since been devoted to the display of his works, the numerous original bronzes and marbles and terracottas being supplemented by casts of works at other places, such as the colossal Gattamelata monument.

AUTHORITIES.—Before the date of the Florence exhibition in 1886 the only books on the subject of Donatello—apart from references in

general histories of art—were Pastor's *Donatello* (Giessen, 1882) and Semper's *Donatello, seine Zeit und seine Schule* (Vienna, 1875). Since then the great Florentine sculptor has received attention from many of the leading art writers, though England has only contributed a not very complete record of his life and work by Hope Rea, *Donatello* (London, 1900), and an excellent critical study by Lord Balcarras, *Donatello* (London, 1903), besides a translation of A. G. Meyer's fully illustrated and exhaustive monograph in the Knackfuss series (London, 1902). Other notable books on the subject are—Eugène Müntz, *Donatello* (Paris, 1885), and in the series of *Les Artistes célèbres* (Paris, 1890); Schmarzow, *Donatello* (Breslau, 1886); Cavallucci, *Vita ed opere del Donatello* (Milan, 1886); Tschudi, *Donatello e la critica moderna* (Turin, 1887); Raymond, *Donatello* (Florence, 1899); and Bode, *Florentiner Bildhauer der Renaissance (Donatello als Architekt und Dekorator, Die Madonnenreliefs Donatellos)* (Berlin, 1902). (P. G. K.)

DONATI, GIOVANNI BATTISTA (1826–1873), Italian astronomer, was born at Pisa on the 16th of December 1826. He entered the observatory of Florence as a student in 1852, became assistant to G. B. Amici in 1854, and was appointed in 1864 to succeed him as director. A new observatory at Arcetri near Florence, built under his supervision, was completed in 1872. During the ten years 1854–1864 Donati discovered six comets, one of which, first seen on the 2nd of June 1858, bears his name (see COMET). He observed the total solar eclipse of the 18th of July 1860, at Torreblanca in Spain, and in the same year began experiments in stellar spectroscopy. In 1862 he published a memoir, *Intorno alle strie degli spettri stellari*, which indicated the feasibility of a physical classification of the stars; and on the 5th of August 1864 discovered the gaseous composition of comets by submitting to prismatic analysis the light of one then visible. An investigation of the great aurora of the 4th of February 1872 led him to refer such phenomena to a distinct branch of science, designated by him "cosmical meteorology"; but he was not destined to prosecute the subject. Attending the International Meteorological Congress of August 1873 at Vienna, he fell ill of cholera, and died a few hours after his arrival at Arcetri, on the 20th of September 1873.

See *Vierteljahrsschrift der astr. Gesellschaft* (Leipzig), ix. 4; *Monthly Notices Roy. Astr. Society*, xxvii. 153; *Memoire degli spettroscopisti italiani*, ii. 125 (G. Cacciatore); *Nature*, viii. 556; &c. (A. M. C.)

DONATIO MORTIS CAUSA (grant in case of death), in law, a gift of personal property made in contemplation of death and intended either expressly or impliedly to take complete effect only if the donor dies of the illness affecting him at the time of the gift. The conception as well as the name is borrowed from Roman law, and the definition given by Justinian (*Inst.* ii. 7. 1) applies equally to a *donatio mortis causa* in Roman and English law. A distinction, however, has arisen between the English and civil codes; by English law delivery either actual or (when from the nature of the thing actual delivery is impossible) constructive is essential, and this delivery must pass not only the possession but the dominion of the thing given; by the civil law, in some cases at least, delivery of possession was not essential (see the judgment of Lord Chancellor Hardwicke in *Ward v. Turner*, 1751, 2 Ves. sen. 431, where the whole question is exhaustively discussed). A *donatio mortis causa* stands halfway between a gift *inter vivos* and a legacy, and has some of the characteristics of each form of disposition. It resembles a legacy in that (1) it is revocable during the donor's life, (2) it is subject to legacy and estate duty, and (3) it is liable to satisfy debts of the testator in default of other assets. On the other hand, it resembles a gift *inter vivos* in that it takes effect from delivery; therefore the consent of the executor is not necessary. Anything may be the subject of a *donatio mortis causa*, the absolute property in which can be made to pass by delivery after the donor's death either in law or equity; this will cover bankers' deposit notes, bills of exchange, and notes and cheques of a third person, but not promissory notes and cheques of the donor in favour of the donee, for the donor's signature is merely an authority for his banker to pay, which is revoked by his death.

DONATION OF CONSTANTINE (*Donatio Constantini*), the supposed grant by the emperor Constantine, in gratitude for his conversion by Pope Silvester, to that pope and his successors

for ever, not only of spiritual supremacy over the other great patriarchates and over all matters of faith and worship, but also of temporal dominion over Rome, Italy and "the provinces, places and *civitates* of the western regions." The famous document, known as the *Constitutum Constantini* and compounded of various elements (notably the apocryphal *Vita S. Silvestri*), was forged at Rome some time between the middle and end of the 8th century, was included in the 9th century in the collection known as the *Falsæ Decretals*, two centuries later was incorporated in the *Decretum* by a pupil of Gratian, and in Gibbon's day was still "entrolled among the decrees of the canon law," though already rejected "by the tacit or modest censure of the advocates of the Roman church." It is now universally admitted to be a gross forgery.¹ In spite, however, of Gibbon's characteristic scepticism on this point, it is certain that the *Constitutum* was regarded as genuine both by the friends and the enemies of the papal pretensions throughout the middle ages.² Though no use of it was made by the popes during the 9th and 10th centuries, it was quoted as authoritative by eminent ecclesiastics of the Frankish empire (e.g. by Ado of Vienne and Hincmar of Reims), and it was employed by two Frankish popes, Gregory V. and Silvester II., in urging certain territorial claims. But not till 1050 was it made the basis of the larger papal claims, when another Frankish pope, Leo IX., used it in his controversy with the Byzantines. From this time forward it was increasingly used by popes and canonists in support of the papal pretensions, and from the 12th century onwards became a powerful weapon of the spiritual against the temporal powers. It is, however, as Cardinal Hergenröther points out, possible to exaggerate its importance in this respect; a charter purporting to be a grant by an emperor to a pope of spiritual as well as temporal jurisdiction was at best a double-edged weapon; and the popes generally preferred to base their claim to universal sovereignty on their direct commission as vicars of God. By the partisans of the Empire, on the other hand, the Donation was looked upon as the *fontes et origo malorum*, and Constantine was regarded as having, in his new-born zeal, betrayed his imperial trust. The expression of this opinion is not uncommon in medieval literature (e.g. Walther von der Vogelweide, Pfeiffer's edition, 1880, Nos. 85 and 164), the most famous instance being in the *Inferno* of Dante (xix. 115):

"Ahi, Costantin, di questo mal fu matre
Non la tua conversion, ma quella dote
Che da te prese il primo ricco patre!"

The genuineness of the *Constitutum* was first critically assailed by Laurentius Valla in 1440, whose *De falso credita et ementita Constantini donatione declamatio* opened a controversy that lasted until, at the close of the 18th century, the defence was silenced. In modern times the controversy as to the genuineness of the document has been succeeded by a debate scarcely less lively as to its date, its authorship and place of origin. The efforts of Roman Catholic scholars have been directed (since Baronius ascribed the forgery to the Greeks) to proving that the fraud was not committed at Rome. Thus Cardinal Hergenröther holds that it was written by a Frank in the 9th century, in order to prove that the Greeks had been rightfully expelled from Italy and that Charlemagne was legitimate emperor. This view, with variations, was maintained by the writer of an article in the *Civiltà cattolica* in 1864 (*Serie v.* vol. x. pp. 303, &c.) and supported by Grauert, who maintains that the document was concocted at the abbey of St Denis, after 840. The evidence now available, however, confirms those who ascribe an earlier date to the forgery and place it at Rome. The view held by Gibbon and Döllinger among others,³ that the *Constitutum* is referred to in

¹ Dr Hodgkin's suggestion (*Italy and her Invaders*, vii. p. 153) that the *Constitutum* may have been originally a mere pious romance, recognized as such by its author and his contemporaries, and laid up in the papal archives until its origin was forgotten, is wholly inconsistent with the unquestioned results of the critical analysis of the text.

² Leo of Vercelli, the emperor Otto III.'s chancellor, protested that the *Constitutum* was a forgery, but without effect. The attacks upon it by the heretical followers of Arnold of Brescia (1152) convinced neither the partisans of the pope nor those of the emperor.

³ So Langen (1883) and E. Mayer (1904).

the letter of Pope Adrian I. to Charlemagne (778), is now indeed largely rejected; there is nothing in the letter to make such an assumption safe, and the same must be said of Friedrich's attempt to find such reference in the letter addressed in 785 by the same pope to Constantine VI., emperor of the East, and his mother Irene. Still less safe is it to ascribe the authorship of the forgery to any particular pope on the ground of its style; for papal letters were drawn up in the papal chancery and the style employed there was apt to persist through several pontificates. Friedrich's theory that the *Constitutum* is a composite document, part written in the 7th century, part added by Paul I. when a deacon under Stephen II., though supported by a wealth of learning, has been torn to tatters by more than one critic (G. Krüger, L. Loening).

On one point, however, a fair amount of agreement seems now to have been reached, a result due to the labour in collating documents of Scheffer-Boichorst, namely, that the style of the *Constitutum* is generally that of the papal chancery in the latter half of the 8th century. This being granted, there is room for plentiful speculation as to where and why it was concocted. We may still hold the opinion of Döllinger that it was intended to impress the barbarian Pippin and justify in his eyes the Frank intervention in favour of the pope in Italy; or we may share the view of Loening (rejected by Brunner, *Rechtsgeschichte*) that the forgery was a pious fraud on the part of a cleric of the Curia, committed under Adrian I.,⁴ with the idea of giving a legal basis to territorial dominion which that pope had succeeded in establishing in Italy. The donations of Pippin and Charlemagne established him as sovereign *de facto*; the donation of Constantine was to proclaim him as sovereign *de jure*. It is significant in this connexion that it was under Adrian (c. 774) that the papal chancery ceased to date by the regnal years of the Eastern emperor and substituted that of the pontificate. Döllinger's view is supported and carried a step further by H. Böhmer, who by an ingenious argument endeavours to prove that the *Constitutum* was forged in 753, probably by the notary Christophorus, and was carried with him by Pope Stephen II. to the court of Pippin, in 754, with an eye to the acquisition of the Exarchate. In support of this argument it is to be noted that the forged document first appears at the abbey of St Denis, where Stephen spent the winter months of 754. E. Mayer, on the other hand, denies that the *Constitutum* can have been forged before the news of the iconoclastic decrees of the council of Constantinople of 754 had reached Rome. He lays stress on the relation of the supposed confession of faith of Constantine, embodied in the forgery, to that issued by the emperor Constantine V., pointing out the efforts made by the Byzantines between 756 and the synod of Gentilly in 767 to detach Pippin from the cause of Rome and the holy images. The forgery thus had a double object: as a weapon against Byzantine heresy and as a defence of the papal patrimony. As the result of an exhaustive analysis of the text and of the political and religious events of the time, Mayer comes to the conclusion that the document was forged about 775, i.e. at the time when Charlemagne was beginning to reverse the policy by which in 774 he had confirmed the possession of the duchies of Spoleto and Benevento to the pope.

BIBLIOGRAPHY.—See Döllinger, *Papstfabeln des Mittelalters* (Munich, 1863; Eng. trans. A. Plummer, 1871); "Janus," *Der Pabst und das Konzil* (Munich, 1866; Eng. trans. 1866); Hergenröther, *Catholic Church and Christian State* (Freiburg im Breisgau, 1872; Eng. trans. 2 vols. 1876); W. Martens, *Die römische Frage unter Pippin u. Karl d. Grossen* (Stuttgart, 1881), with text; H. Grauert, "Die Konstantinische Schenkung," in *Hist. Jahrb. der Görres-Gesellsch.* iii. (1882), iv. (1883); Langen, "Entstehung u. Tendenz der Konst. Schenkungsurkunde," in *Sybel's Hist. Zeitschr.* l. (1883); L. Weiland, "Die Konst. Schenkung," in *Zeitschr. f. Kirchenrecht*, xxii. (1887-1888), maintains that the *Constitutum* was forged at Rome between 813 and 875, in connexion with the papal claim to crown the emperors; H. Brunner and K. Zeumer, *Die Konstantinische Schenkungsurkunde* (Berlin, 1888; Festgaben für R. v. Gaiet), with text; Friedrich, *Die Konst. Schenkung* (Nördlingen, 1889), with text; W. Martens, *Die falsche Generalkonkession Konstantins des Grossen* (Munich, 1889); P. Scheffer-Boichorst, "Neue

⁴ This is also W. Mayer's view in his later work. In his *Die römische Frage* (1881) he had placed the forgery in 805 or 806.

Forschungen über die Konst. Schenkung." i. ii. (*Mitteilungen des Instituts für österr. Geschichtsforschung*, x. (1889), xi. (1890); G. Krüger, "Die Frage der Entstehungszeit der Konst. Schenkung," in *Theologische Literaturzeitung*, xiv. (1889); J. Hodgkin, *Italy and her invaders*, vol. vii. p. 135 (Oxford, 1899); article "Konstantinische Schenkung," G. H. Böhmer, in Herzog-Hauck, *Realencycl.* (1902); E. Mayer, "Die Schenkungen Konstantins und Pippins," in *Deutsche Zeitschr. für Kirchenrecht* (Tübingen, 1904). Laurentius Valla's treatise was issued in a new edition, with French translation and historical introduction, by A. Bonneau, *La Donation de Constantin* (Lisieux, 1879). (W. A. P.)

DONATISTS, a powerful sect which arose in the Christian church of northern Africa at the beginning of the 4th century.¹ In its doctrine it sprang from the same roots, and in its history it had in many things the same character, as the earlier Novatians. The predisposing causes of the Donatist schism were the belief, early introduced into the African church, that the validity of all sacerdotal acts depended upon the personal character of the agent, and the question, arising out of that belief, as to the eligibility for sacerdotal office of the *traditores*, or those who had delivered up their copies of the Scriptures under the compulsion of the Diocletian persecution; the exciting cause was the election of a successor to Mensurius, bishop of Carthage, who died in 311. Mensurius had held moderate views as to the treatment of the *traditores*, and accordingly a strong fanatical party had formed itself in Carthage in opposition to him, headed by a wealthy and influential widow named Lucilla, and countenanced by Secundus of Tigisis, *episcopus primae sedis* in Numidia. There were thus two parties, each anxious to secure the succession to the vacant see. The friends of the late bishop fixed their choice on Caecilian, the archdeacon, and secured his election and his consecration by Felix, the bishop of Aptunga, before the other party were ready for action. It had been customary for the Numidian bishops to be present at the election and consecration of the bishop of Carthage, who as metropolitan of proconsular Africa occupied a position of primacy towards all the African provinces. Caecilian's party, however, had not waited for them, knowing them to be in sympathy with their opponents. Soon after Caecilian's consecration, Secundus sent a commission to Carthage, which appointed an intervener temporarily to administer the bishopric which they regarded as vacant. Then Secundus himself with seventy of the Numidian bishops arrived at Carthage. A synod of Africa was formed, before which Caecilian was summoned; his consecration was declared invalid, on the ground that Felix had been a traitor; and finally, having refused to obey the summons to appear, he was excommunicated, and the lector Majorinus, a dependant of Lucilla's, consecrated in his stead. This synod forbade the African churches to hold communion with Caecilian, the schism became overt, and in a very short time there were rival bishops and rival churches throughout the whole province.

It was soon clear, by the exclusion of the "*Pars Majorini*" from certain privileges conferred on the African church, that the sympathies of Constantine were with the other party (Eusebius, *Hist. eccl.* x. 6, 7). To investigate the dispute an imperial commission was issued to five Gallic bishops, under the presidency of Melchisedes, bishop of Rome. The number of referees was afterwards increased to twenty, and the case was tried at Rome in 313.² Ten bishops appeared on each side, the leading representative of the Donatists being Donatus of Casae Nigrae. The decision was entirely in favour of Caecilian, and Donatus was found guilty of various ecclesiastical offences. An appeal was taken and allowed; but the decision of the synod of Arles in 314 not only confirmed the position of Caecilian, but greatly strengthened it by passing a canon that ordination was not

¹ There were three prominent men named Donatus connected with the movement—Donatus of Casae Nigrae; Donatus surnamed Magnus, who succeeded Majorinus as the Donatist bishop of Carthage; and Donatus of Bagoi, a leader of the *circumcelliones*, who was captured and executed c. 350. The name of the sect was derived from the second of these. The Donatists themselves repudiated the designation, which was applied to them by their opponents as a reproach. They called themselves "*Pars Majorini*" or "*Pars Donati*."

² The Donatist movement affords a valuable illustration of the new importance which the changed position of the church under Constantine gave to the synodal system of ecclesiastical legislation.

invalid because performed by a traitor, if otherwise regular. Felix had previously been declared innocent after an examination of records and witnesses at Carthage. A further appeal to the emperor in person was heard at Milan in 316, when all points were finally decided in favour of Caecilian, probably on the advice of Hosius, bishop of Cordova. Henceforward the power of the state was directed to the suppression of the defeated party. Persistent Donatists were no longer merely heretics; they were rebels and incurred the confiscation of their church property and the forfeiture of their civil rights.

The attempt to destroy the sect by force had the result of intensifying its fanaticism. Majorinus, the Donatist bishop of Carthage, died in 315, and was succeeded by Donatus, surnamed Magnus, a man of great force of character, under whose influence the schism gained fresh strength from the opposition it encountered. Force was met with force; the Circumcelliones, bands of fugitive slaves and vagrant (*circum cellas*) peasants, attached themselves to the Donatists, and their violence reached such a height as to threaten civil war. In 321 Constantine, seeing probably that he had been wrong in abandoning his usual policy of toleration, sought to retrace his steps by granting the Donatists liberty to act according to their consciences, and declaring that the points in dispute between them and the orthodox should be left to the judgment of God. This wise policy, to which he consistently adhered to the close of his reign, was not followed by his son and successor Constans, who, after repeated attempts to win over the sect by bribes, resorted to persecution. The renewed excesses of the Circumcelliones, among whom were ranged fugitive slaves, debtors and political malcontents of all kinds, had given to the Donatist schism a revolutionary aspect; and its forcible suppression may therefore have seemed to Constans even more necessary for the preservation of the empire than for the vindication of orthodoxy. The power which they had been the first to invoke having thus declared so emphatically and persistently against them, the Donatists revived the old world-alien Christianity of the days of persecution, and repeated Tertullian's question, "What has the emperor to do with the church?" (*Quid est imperatori cum ecclesia?*) Such an attitude aggravated the lawlessness of the Circumcellion adherents of the sect, and their outrages were in turn made the justification for the most rigorous measures against the whole Donatist party indiscriminately. Many of their bishops fell victims to the persecution, and Donatus (Magnus) and several others were banished from their sees.

With the accession of Julian (361) an entire change took place in the treatment of the Donatists. Their churches were restored and their bishops reinstated (Parmenianus succeeding the deceased Donatus at Carthage), with the natural result of greatly increasing both the numbers and the enthusiasm of the party. A return to the earlier policy of repression was made under Valentinian I. and Gratian, by whom the Donatist churches were again closed, and all their assemblies forbidden. It was not, however, until the commencement of the 5th century that the sect began to decline, owing largely to the rise among them of a group of moderate and scholarly men like the grammarian Tychonius, who vainly strove to overcome the more fanatical section. Against the house thus divided against itself both state and church directed not unsuccessful assaults. In 405 an edict was issued by the emperor Honorius commanding the Donatists, under the severest penalties, to return to the Catholic church. On the other hand, Augustine, bishop of Hippo, after several years' negotiation, arranged a great conference between the Donatists and the orthodox, which was held under the authority of the emperor at Carthage in 411. There were present 286 Catholics and 270 Donatist bishops. Before entering on the proceedings the Catholics pledged themselves, if defeated, to give up their sees, while in the other event they promised to recognize the Donatists as bishops on their simply declaring their adherence to the Catholic church. The latter proposal, though it was received with scorn at the time, had perhaps ultimately as much influence as the logic of Augustine in breaking the strength of the schism. The discussion, which lasted for three days, Augustine

and Aurelius of Carthage being the chief speakers on the one side, and Primum and Petilian on the other, turned exclusively upon the two questions that had given rise to the schism—first, the question of fact, whether Felix of Aptunga who consecrated Caecilian had been a traitor; and secondly, the question of doctrine, whether a church by tolerance of unworthy members within its pale lost the essential attributes of purity and catholicity. The Donatist position, like that of the Novatians, was that the mark of the true church is to guard the essential predicate of holiness by excluding all who have committed mortal sin; the Catholic standpoint was that such holiness is not destroyed by the presence of unworthy members in the church but rests upon the divine foundation of the church and upon the gift of the Holy Spirit and the communication of grace through the priesthood. In the words of Optatus of Milevi, *sanctitas de sacramentis colligitur, non de superbia personarum pondera*. And the much wider diffusion of the orthodox church was also taken as practical confirmation that it alone possessed what was regarded as the equally essential predicate of catholicity.

The decision of Marcellinus, the imperial commissioner, was in favour of the Catholic party on both questions, and it was at once confirmed on an appeal to the emperor. The severest penal measures were enforced against the schismatics; in 414 they were denied all civil rights, in 415 the holding of assemblies was forbidden on pain of death. But they lived on, suffering with their orthodox brethren in the Vandal invasions of the 5th century, and like them finally disappearing before the Saracen onslaught two centuries later.

AUTHORITIES.—1. Contemporary sources: Optatus Milevitanus *De Schismate Donatistarum adversus Parmenianum*, written c. 368 (Dupin's ed., Paris, 1700), and several of the works of Augustine. 2. Modern: C. W. F. Walch, *Entwurf einer vollständigen Historie der Ketzereien* (Leipzig, 1768); Hauck-Herzog, *Realencyc. für prot. Theol.*, art. "Donatismus," by N. Bonwetsch, who cites the literature very fully; W. Möller, *History of the Christian Church* (vol. i. pp. 331 ff., 445 ff.); D. Völter, *Der Ursprung des Donatismus* (Freiburg, 1883).

DONATUS, AELIUS, Roman grammarian and teacher of rhetoric, flourished in the middle of the 4th century A.D. The only fact known regarding his life is that he was the tutor of St Jerome. He was the author of a number of professional works, of which there are still extant:—*Ars grammatica*; the larger portion of his commentary on Terence (a compilation from other commentaries), but probably not in its original form; and a few fragments of his notes on Virgil, preserved and severely criticized by Servius, together with the preface and introduction, and life of Virgil. The first of these works, and especially the section on the eight parts of speech, though possessing little claim to originality, and in fact evidently based on the same authorities which were used by the grammarians Charisius and Diomedes, attained such popularity as a school-book that in the middle ages the writer's name, like the French *Calepin*, became a common metonymy (in the form *donet*) for a rudimentary treatise of any sort. On the introduction of printing editions of the little book were multiplied to an enormous extent. It is extant in the form of an *Ars Minor*, which only treats of the parts of speech, and an *Ars Major*, which deals with grammar in general at greater length.

Aelius Donatus is to be distinguished from Tiberius Claudius Donatus, the author of a commentary (*Interpretationes*) on the *Aeneid* (of far less value than that of Servius), who lived about fifty years later.

The best text of the *Ars* and the commentaries upon it by Servius and others is in H. Keil, *Grammatici Latini*, iv.; the commentary on Terence there is an edition by P. Wessner (1902, Teubner series), with bibliography and full account of MSS. See generally E. A. Gräfenhan, *Geschichte der klassischen Philologie im Altertum*, iv. (1850); P. Rosenstock; *De Donato, Terentii . . . explicatore* (1886); H. T. Karsten, *De comm. Don. ad Terentii fabulas origine et compositione* (Leiden, 1907). For the commentary of Tiberius Donatus see O. Ribbeck, *Prolegomena to Virgil*, Gräfenhan (as above), and V. Burkau, *De Tiberii Claudii Donati in Aeneidem commentario* (1889). The text will be found in C. Fabricius's edition of Virgil (1561), ed. by H. George, i. (1905 fol.).

DONAUFÜRT, a town of Germany in the kingdom of Bavaria, on the left bank of the Danube, at the confluence of the *Wörnitz*, 25 m. N. of Augsburg by rail and at the junction of lines

to Ulm and Ingolstadt. Pop. 5000. It is an ancient town and has several mediæval buildings of interest. Notable among its seven churches (six Roman Catholic) are the Kloster-Kirche (monasterial), a beautiful Gothic edifice with the sarcophagus of Maria of Brabant, and that of the former Benedictine abbey, Heilig-Kreuz, with a lofty tower. Remarkable among secular buildings are the Gothic town hall, and the so-called Tanz-haus, which now includes both a theatre and a school. The industries embrace machinery, brewing and saw-milling; the place is of some importance as a river port, and the centre of a considerable agricultural trade.

Donauwörth grew up in the course of the 11th and 12th centuries under the protection of the castle of Mangoldstein, became in the 13th a seat of the duke of Upper Bavaria, who, however, soon withdrew to Munich to escape from the *manes* of his wife Maria of Brabant, whom he had there beheaded on an unfounded suspicion of infidelity. The town received the freedom of the Empire in 1308, and maintained its position in spite of the encroachments of Bavaria till 1607, when the interference of the Protestant inhabitants with the abbot of the Heilig-Kreuz called forth an imperial law authorizing the duke of Bavaria to inflict chastisement for the offence. In the Thirty Years' War it was stormed by Gustavus Adolphus (1632), and captured by King Ferdinand (1634). In the vicinity, on the Schellenberg, the Bavarians and French were defeated by Marlborough and Prince Louis of Baden on the 2nd of July 1704. The imperial freedom restored to the town by Joseph I. in 1705 was again lost by reincorporation with Bavaria in 1714. In the neighbourhood the Austrians under Mack were, on the 6th of October 1805, decisively defeated by the French under Soult.

See Königsdorfer, *Geschichte des Klosters zum Heiligen Kreuz in Donauwörth* (1819-20).

DON BENITO, a town of western Spain, in the province of Badajoz; near the left bank of the river Guadiana, on the Madrid-Badajoz-Lisbon railway. Pop. (1900) 16,505. Don Benito is a thriving and comparatively modern town; for it dates only from the 15th century, when it was founded by refugees from Don Llorente, who deserted their own town owing to the danger of floods from the Guadiana. Besides manufactures of brandy, flour, oil, soap, linen and cloth, it has an active trade in wheat, wine and fruit, especially melons.

DONCASTER, a market-town and municipal borough in the Doncaster parliamentary division of the West Riding of Yorkshire, England, 156 m. N. by W. from London. Pop. (1901) 28,932. It lies in a flat plain on the river Don, with slight hills rising westward. It is an important station on the Great Northern railway, whose principal locomotive and carriage works are here, and it is also served by the North Eastern, Great Eastern, Great Central, Lancashire & Yorkshire, and Midland railways. The Don affords intercommunication with Goole and the Humber. The parish church of St George, occupying the site of an older structure of the same name, destroyed by fire in 1853, was finished in 1858 under the direction of Sir G. G. Scott. It is a fine cruciform structure of Decorated character, with a central tower 170 ft. high, and contains a particularly fine organ. St James's church was erected, under the same architect and Lord Grimthorpe, by the Great Northern railway company. Other important buildings are the town hall, mansion house, free library and art school, corn exchange and markets. The grammar school was founded in 1553 and reorganized in 1862. Doncaster race-meetings are widely famous. The racecourse lies 1 m. S.E. of the town. The old course is 1 m. 7 fur. 70 yds. in length, and the Sandall course of 1 m. was added in 1892. The grand stand was erected in 1777, but there are several additional stands. Races have long been held at Doncaster, and there was a stand on the course before the year 1615. The St Leger takes its name from Lieut.-General St Leger, who originated the race in 1776; but it was not so named till 1778. The meetings are held in the second week of September. A system of electric tramways connects the town with its principal suburbs. The agricultural trade is extensive, and there are iron, brass and agricultural machine works. Doncaster lies on the outskirts of a populous district extending

up the valley of the Don. Two miles S.W. is the urban district of Balby-with-Hexthorpe (pop. 6781); and 7 m. S. is that of Tickhill, where there are remains of a Norman castle. Wheatley (3579) lies 2 m. N.E. The borough of Doncaster is under a mayor, six aldermen and eighteen councillors. Area, 1695 acres.

History.—There was a Roman station here, and numerous remains of the Roman period have been found. In the reign of Edward the Confessor, Doncaster, as a *berenic* of the manor of Hexthorp, belonged to Earl Tostig; but before 1086 it had been granted to Robert, earl of Mortain, whose successor William was attainted for treason in the time of Henry I. The overlordship then fell to the crown, and the families of Frossard, Mauley and Salvin successively held the manor as underlords. Doncaster was evidently a borough held of the crown for a fee farm rent before 1194, when Richard I. granted and confirmed to the burgesses their soke and town to hold by the ancient rent and by twenty-five marks yearly. The town was incorporated in 1467 by Edward IV., who granted a gild merchant and appointed that the town should be governed by a mayor and two sergeants-at-mace elected every year by the burgesses. Henry VII., while confirming this charter in 1505, granted further that the burgesses should hold their town and soke with all the manors in the soke on payment of a fee farm. He also by another charter in 1508 confirmed letters patent granted by Peter de Mauley in 1341, by which the latter renounced to the inhabitants of Doncaster all the manorial claims which he had upon them, with the "pernicious customs" which his ancestors claimed from bakers, brewers, butchers, fishers and wind-fallen trees. In 1623 Ralph Salvin tried to regain the manor of Doncaster from the mayor and burgesses, who, fearing that the case would go against them, agreed to pay about £3000, in return for which he gave up his claim to all the manors in the soke. Charles II. in 1664 gave the town a new charter, granting that it should be governed by a mayor, twelve aldermen and twenty-four capital burgesses, but since this was not enrolled and was therefore of no effect the burgesses obtained another charter from James II. in 1684 by which the town was governed until the Municipal Corporation Act. In 1200 a fair at Doncaster on the vigil and day of St James the Apostle was confirmed to Robert de Turnham, who held the manor in right of his wife, with the addition of an extra day, for which he had to give the king two palfreys worth 100s. each. By the charter of 1194 the burgesses received licence to hold a fair on the vigil, feast and morrow of the Annunciation, and this with the fair on St James's day was confirmed to them by Henry VII. in 1505. The fairs and markets are still held under these charters.

See *Victoria County History, Yorkshire*: Edward Miller, *The History and Antiquities of Doncaster* (1828-1831); *Calendar to the Records of the Borough of Doncaster*, published by the Corporation.

DON COSSACKS, TERRITORY OF THE (Russ. *Donskaya Oblast*), a government of S.E. Russia, bounded W. by the governments of Voronezh, Kharkov and Ekaterinoslav, S.W. by the Sea of Azov, S. by the governments of Kuban and Stavropol, and E. by those of Astrakhan and Saratov. Area, 63,532 sq. m. Pop. 1,010,135 in 1867, 2,585,920 in 1897 and 3,125,400 (estimate) in 1906. It belongs almost entirely to the region of the South Russian steppes, but in the N., W. and S.W. presents more the aspects of elevated plains gapped with ravine-like river-courses, while in the S.E., towards the Manych depression, it passes over into the arid Aral-Caspian steppes (e.g. Zadonsk Steppe), dotted over with salt lakes. Geologically the region is made up of Carboniferous limestones, clay slates and sandstones, containing anthracite and coal; of Cretaceous marls, chalk, sandstone and greensands—chalk cliffs, in fact, accompany the Don for 200 m.; and of Miocene limestones and clays. The surface, especially W. of the Don, is the fertile black earth, intermingled here and there, especially in the Zadonsk Steppe, with clay impregnated with salt. The government is drained by the Don and its tributaries, of which the Donets, Chir and Mius enter from the right and the Khoper and Medveditsa from the left. The Don is navigable throughout the government, and at Kalach is connected by a railway, 45 m. long, with Tsaritsyn on the Volga, routes by which an enormous amount of heavy merchandise is transported. The

climate is continental and dry, the average temperatures being—year 43° Fahr., January 13°, July 72° at Uryupina (in 50° 48' N.; alt. 92 ft.); and year 48°, January 21°, July 73° at Taganrog. The annual rainfall at the same two places is 13.4 and 17.4 in. respectively. Forests cover only 2 % of the area.

Nearly one-half of the population are Cossacks, the other ethnological groups being (1897) 27,234 Armenians, 2255 Greeks, 1267 Albanians, 16,000 Jews and some 30,000 Kalmuck Tatars, who are Lamaists in religion. Nearly all the rest of the people, except the Jews and about 3000 Mahomedans, belong to the Orthodox Eastern Church. The Cossacks own nearly 30,000,000 acres of land. The government is well provided with schools, especially on the Cossack territory. Agriculture is the principal occupation, but the crops vary very greatly from year to year, owing to deficiency of rain. Vines are cultivated on a large scale, and tobacco is grown in the south. Cattle-breeding is important, and there are fine breeds of horses and large flocks of sheep. Productive fisheries are carried on at the mouth of the Don. Nearly 13,000 persons are engaged in coal-mining; the coalfields form part of the vast Donets coal basin (10,420 sq. m., with a total output of nearly 13,000,000 tons annually). Some iron ore, gypsum, salt and limestone are also produced. The principal branches of manufacturing industry are flour-milling, potteries, ironworks and tobacco factories. The exports consist chiefly of cereals, cattle, horses, sheep, wine, fish and hides. The government is under the administration of the ministry of war, and is divided into nine districts—Donets (chief town, Kamenskaya with 23,576 inhabitants in 1897), First Don district (Konstantinovskaya, 8800), Second Don district (Nizhne-Chirskaya, 15,196), Rostov (Rostov-on-Don, 119,889), Salsky (Velikoknyazheskaya), Taganrog (Taganrog, 58,928 in 1900), Ust-medveditsa (Ust-medveditsa, 16,000), Khoper (Uryupina, 9600), Cherkasky (Novo-cherkassk, 52,005). The capital of the government is Novo-cherkassk. Many of the Cossack *stanitsas* (villages) are very populous. (P. A. K.; J. T. Bk.)

DONEGAL, a county in the extreme north-west of Ireland, in the province of Ulster, bounded N. and W. by the Atlantic Ocean, E. by Lough Foyle and the counties Londonderry and Tyrone, and S. by Donegal Bay and the counties Fermanagh and Leitrim. The area is 1,197,153 acres, or about 1871 sq. m., the county being the largest in Ireland after Cork and Mayo. This portion of the country possesses little natural wealth; its physical characteristics are against easy communications, and although its northern coast affords one or two good natural harbours, there is no commercial inducement to take advantage of them. The fine scenery and other natural attractions of Donegal thus remained practically unknown until late in the 19th century, but an effort was then made by Lord George Hill to introduce wealth from without into the county, and to develop its resources in this, almost the only possible direction. The county possesses a large extent of sea-coast indented by numerous inlets. Ballyshannon harbour, the most southern of these, is small, and has a bar at its mouth, as has Donegal harbour farther north. Killybegs harbour is well sheltered, and capable of receiving large vessels. These, with Bruckles or M'Swiny's Bay, and Teelin harbour, suitable for small vessels, are arms of the fine inlet of Donegal Bay. The western shore is beautified by the indentations of Loughros Beg, Gweebarra, Trawenagh and Inishfree Bays. On the north is Sheephaven, within which is Dunfanaghy Bay, where the largest ships may lie in safety, as they may also in Mulroy Bay and Lough Swilly farther east. Lough Foyle, which divides Donegal from Londonderry, is a noble sheet of water, but is shallow and in part dry at ebb tide, contracted at its entrance, and encumbered with shoals. A few miles west of Malin Head, the most northerly point of the mainland of Ireland, the varied and extensive Lough Swilly runs far into the interior. From these two loughs much land has been reclaimed. Numerous islands and rocks stud the coast. The largest island is North Aran, about 15 m. in circumference, with a lofty hill in its centre, and a gradual declivity down to the sea. On the northern coast are Tory Island, and, farther east, Inishtrahull, the *ultima Thule* of Ireland. The inhabitants of these islands obtain a precarious

livelihood by fishing, kelp-burning and rude husbandry, but are often reduced to extreme destitution.

Mountains and irregular groups of highlands occupy the whole interior of the county, and a considerable portion is bog and moorland. Errigal mountain in the north-west attains an elevation of 2466 ft. and commands from its summit a fine view over a considerable portion of the country. In its vicinity, the Derryveagh mountains reach 2240 ft. in Slieve Snaght; Muckish is 2197 ft.; in the south Bluestack reaches 2219 ft.; and in the Innishowen peninsula between Loughs Swilly and Foyle, another Slieve Snaght is 2019 ft. in elevation. At the western extremity of the north coast of Donegal Bay stands Slieve League, whose western flank consists of a mighty cliff, descending almost sheer to the Atlantic, exhibiting beautiful variegated colouring, and reaching an extreme height of 1972 ft. From these details it will appear that the scenery of the highlands and the sea-coast often attain a character of savage and romantic grandeur; whereas the eastern and southern portions are generally less elevated and more fertile, but still possess considerable beauty. A considerable portion of the surface, however, is occupied by bogs, and entirely destitute of timber.

With the exception of the tidal river Foyle, which forms the boundary between this county and Tyrone and Londonderry, the rivers, though numerous, are of small size. The branches of the Foyle which rise in Donegal are the Derg, issuing from Lough Derg, and the Finn, rising in the beautiful little lake of the same name in the highlands, and passing through some of the best cultivated land in the county. The Foyle, augmented by their contributions, and by those of several other branches from the counties Tyrone and Londonderry, proceeds northward, discharging its waters into the southern extremity of Lough Foyle, at the city of Londonderry. It is navigable for vessels of large burden to this place, and thence by lighters of fifty tons as far as Lifford. Boats of fourteen tons can proceed up the Finn river as far as Castlefinn. The fine river Erne flows from Lough Erne through the southern extremity of the county into the southern extremity of Donegal Bay. Its navigation is prevented by a fall of 12 ft., generally called the Salmon Leap, in the neighbourhood of Ballyshannon, and by rapids between Ballyshannon and Belleek, on the confines of Co. Fermanagh. The Gweebarra, the Owenca, and the Eask are the only other streams of any note. Lakes are very numerous in Donegal. The most remarkable, and also the largest, is Lough Derg, comprising within its waters several islets, on one of which, Station Island, is the cave named St Patrick's Purgatory, a celebrated place of resort for pilgrims and devotees. The circumference of the lake is about 9 m., and the extent of the island to which the pilgrims are ferried over is less than 1 acre. The landscape round Lough Derg is desolate and sombre in the extreme, barren moors and heathy hills surrounding it on all sides. Salmon, sea-trout and brown trout afford sport in most of the rivers and loughs, and Glenties for the Owenca river, and Gweedore for the Clady, in the west; Killybegs for the Eanymore and Eask, in the south; and Rathmelton and Rosapenna for the Owencarrow and Leannan, in the north, may be mentioned as centres. Ballyshannon and Bundoran, in the extreme south, are centres for the Erne and other waters outside the county.

Geology.—The dominant feature in the geology of this county is the north-east and south-west strike forced upon the older rocks during earth-movements that set in at the close of Silurian times. The granite that forms characteristically the core of the folds is probably of the same age as that of Leitner, or may possibly represent older igneous masses, brought into a general parallelism during the main epoch of stress. The oldest recognizable series of rocks is the Dalradian, and its quartzites form the white summits of Muckish, Errigal and Aghla. The intruding granite, which predominates in the north-west, has frequently united with the metamorphic series to form composite gneiss. In the southern mass near Pettigo, once regarded as Archaean and fundamental, residual "eyes" of the hornblende rocks that are associated with the Dalradian series remain floating, as it were, in the gneiss. North of this, the country is wilder, consisting largely of mica-schist, through which a grand mass of unfoliated granite rises at Barnesmore. The course of the Gweebarra, or Glen Beagh, of the Glendowan mountains, and the Aghla ridge, have all been determined by the general strike

imparted to the country. At Donegal Bay the Lower Carboniferous sandstone and limestone come in as a synclinal, and the limestone extends to Bundoran. Small Carboniferous outliers on the summits of the great cliff of Slieve League show the former extension of these strata. Bog iron-ore is raised as a gas-purifier; and talc-schist has been worked for steatite at Croy Head. In most parts of the west the patches of glacial drift form the only agricultural land. The fine-grained sandstone of Mount Charles near Donegal is a well-known building stone, and the granites of the north-west have attracted much attention.

Industries.—The modes of agriculture present little that is peculiar to the county, and the spade still supplies the place of the plough where the rocky nature of the surface prevents the application of the latter implement. The soil of the greater portion of the county, *i.e.* the granite, quartz and mica slate districts, is thin and cold, while that on the carboniferous limestone is warm and friable. Owing to the boggy nature of the soil, agriculture has not made much progress, although in certain districts (Gweedore, for instance) much land has been brought under cultivation through the enterprise of the proprietors. Roughly speaking, however, about 45 % of the land is waste, 35 % pasture and 15 % tillage. Wheat and barley are quite an inconsiderable crop, and in this as well as in other respects Donegal is much behind the rest of Ulster in the extent of its crops. It bears, however, a more favourable comparison as regards its live stock, as cattle, sheep and poultry are extensively kept.

In Donegal, as in other counties of Ulster, the linen manufacture affords employment to a number of inhabitants, especially at Raphoe, while the manufacture of excellent homespun, woollen stockings and worked muslin is carried on pretty extensively. The trade in these manufactures and in the domestic produce of the county finds its principal outlets through the port of Londonderry and the inland town of Strabane, Co. Tyrone. The deep-sea fisheries are important, and are centred at Killybegs, Gweedore and Rathmullen. The salmon fishery is also prosecuted to a considerable extent, the principal seats of the trade being at Ballyshannon and Letterkenny.

The railway system includes the County Donegal railway from Londonderry south-west to Donegal town and Killybegs, with branches to Glenties, a village near the west coast, and to Ballyshannon; and the Londonderry and Lough Swilly, serving Letterkenny, and continuing to Burtonport with a branch north to Buncrana, a watering-place on Lough Swilly, and Cardonagh in the Innishowen peninsula. From Letterkenny the line continues to Dunfanaghy on the north coast, thence to Gweedore and Burtonport.

Population and Administration.—The population (185,635 in 1891; 173,722 in 1901) decreases less seriously than in most Irish counties, though the proportion of emigrants is large. About 78 % of the population is Roman Catholic, and almost the whole is rural. The native Erse naturally dies out slowly in this remote county, and the Donegal dialect is said to be the purest in the Irish language. The towns are small in extent and importance. Lifford (pop. 446), the county town, is practically a suburb of Strabane, in the neighbouring Co. Tyrone. Ballyshannon (2350) on the river Erne, Letterkenny (2370) at the head of Lough Swilly, and Donegal (1214) at the head of the bay of that name, are the other principal towns. The principal watering-places are Moville on Lough Foyle, Buncrana and Rathmelton on Lough Swilly; while, following the coast from north to south, Rosapenna, Dunfanaghy, Gweedore, Dungloe and Ardara, with Bundoran in the extreme south, are seaside villages frequently visited. Resorts deserving mention for the attractive scenery for which they are centres, are—Ardara, on the Owenca river, where the cliffs of the neighbouring coast are particularly fine; Carrick, Malin Head, the beautiful land-locked bay of Mulroy, Narin on Boylagh Bay, Portsalon on Lough Swilly, and Stranorlar, a small market town near the fine mountain pass of Barnesmore.

Donegal contains seven baronies and fifty parishes. Assizes are held at Lifford, and quarter sessions at Ballyshannon, Buncrana, Donegal, Cardonagh, Glenties, Letterkenny and Lifford. The county is in the Protestant dioceses of Clogher and Derry,

and the Roman Catholic dioceses of Raphoe, Clogher and Derry. The county returned twelve members to the Irish parliament; after the Union it returned two; but it is now divided into north, east, south and west divisions, each returning one member.

History and Antiquities.—The greater part of Donegal was anciently called Tyrconnell (*q.v.*) or the country of Conall; and it was sometimes called O'Donnell's country, after the head chieftains of the district. This district was formed into the county of Donegal in the reign of Queen Elizabeth, in 1585, by the lord-deputy Sir John Perrott. The most noteworthy architectural remains of antiquity in the county are to be found at the head of Lough Swilly, where, situated on the summit of a hill 802 ft. high, some remarkable remains exist of a fortress or palace of the northern Irish kings. These are known as the Grianan of Aileach, and evidently date from a period prior to the 12th century. On Tory Island there are one of the best specimens of a round tower and some other interesting remains. Numerous ruins of ancient castles along the coast prove that much attention was formerly paid to the defence of the country from invasion. The principal are—Kilbarrow Castle, an ancient stronghold of the O'Clerys, near Ballyshannon; Donegal Castle, built by the O'Donnells, anciently their chief residence, and now a fine ruin standing close to the water's edge; Burt Castle, built in the reign of Henry VIII. on the shores of Lough Swilly by Sir Cahir O'Dogherty, to whom is also attributed the erection of Green Castle, one of the strongholds of the clan on Lough Foyle. Near the Castle of Doe, or M'Swinye's Castle, at Horn Head, is a natural perforation in the roof of a cave, called M'Swinye's Gun, formed by the workings of the ocean into the overhanging cliff. When the wind blows due north, and the tide is at half flood, the gun is seen to spout up jets of water to a height of 100 ft., attended with explosions heard occasionally in favourable weather at an immense distance. Gulmore Fort, on the coast of Lough Swilly, supposed to have been erected by the O'Doghertys, having come into the possession of the crown, was granted in 1609 to the corporation of London. It was afterwards enlarged or rebuilt, and acted a prominent part in the celebrated siege of Derry. Traces of religious houses, some existing only in traditionary or documental records, are also numerous. The ruins of that of Donegal, founded in 1474, afford proofs of its ancient grandeur. At Raphoe, 5 m. N.W. of Lifford, is the cathedral of a former diocese united to that of Derry in 1835.

DONEGAL, a small seaport and market town of Co. Donegal, Ireland (not, as its name would suggest, the county town, which is Lifford), in the sixth parliamentary division, at the head of Donegal Bay, and the mouth of the river Eask, on the Donegal railway. Pop. (1901) 1214. Its trade in agricultural produce is hampered by the unsatisfactory condition of its harbour, the approach to which is beset with shoals. Here are the ruins of a fine Jacobean castle, occupying the site of a fortress of the O'Donnells of Tyrconnell, but built by Sir Basil Brooke in 1610. There are also considerable remains of a Franciscan monastery, founded in 1474 by one of the O'Donnells, and here were compiled the famous "Annals of the Four Masters," a record of Irish history completed in 1636 by one Michael O'Clery and his coadjutors. There is a chalybeate well near the town, and 7½ m. S., at Ballintra, a small stream forms a series of limestone caverns known as the Pullins. Donegal received a charter from James I., and returned two members to the Irish parliament. The name is said to signify the "fortress of the foreigners," and to allude to a settlement by the Northmen.

DONELSON, PORT, an entrenched camp at Dover, Tennessee, U.S.A., erected by the Confederates in the Civil War to guard the lower Cumberland river, and taken by the Federals on the 16th of February 1862. It consisted of two continuous lines of entrenchments on the land side, and water batteries commanding the river. After the capture (Feb. 6) of Fort Henry on the lower Tennessee the Union army (three divisions) under Brigadier-General U. S. Grant marched overland to invest Donelson, and the gunboat flotilla (Commodore A. H. Foote) descended the Tennessee and ascended the Cumberland to meet him. Albert Sidney Johnston, the Confederate commander in Kentucky, had thrown a large

garrison under General Floyd into Donelson, and Grant was at first outnumbered; though continually reinforced, the latter had at no time more than three men to the Confederates' two. The troops of both sides were untrained but eager.

On the 12th and 13th of February 1862 the Union divisions, skirmishing heavily, took up their positions investing the fort, and on the 14th Foote's gunboats attacked the water batteries. The latter received a severe repulse, Foote himself being amongst the wounded, and soon afterwards the Confederates determined to cut their way through Grant's lines. On the 15th General Pillow attacked the Federal division of McClernand and drove it off the Nashville road; having done this, however, he halted, and even retired. Grant ordered General C. F. Smith's division to assault a part of the lines which had been denuded of its defenders in order to reinforce Pillow. Smith personally led his young volunteers in the charge and carried all before him. The Confederates returning from the sortie were quite unable to shake his hold on the captured works, and, Grant having reinforced McClernand with Lew Wallace's division, these two generals reoccupied the lost position on the Nashville road. On the 16th, the two senior Confederate generals Floyd and Pillow having escaped by steamer, the infantry left in the fort under General S. B. Buckner surrendered unconditionally. The Confederate cavalry under Colonel Forrest made its escape by road. The prisoners numbered about 15,000 out of an original total of 18,000.

DONGA, a Bantu word for a ravine, narrow watercourse or gully formed by the action of water. Adopted by the European residents of South Africa from the Kaffirs, the use of the word has been extended by English writers to ravines or watercourses of the nature indicated in various other parts of the world. It is almost equivalent to the Arabic *hhor*, which, however, also means the dry bed of a stream, or a stream flowing through a ravine. The Indian word *nallah* (properly a watercourse) has also the same significance. The three words are often used interchangeably by English writers.

DONGOLA, a *muḍirra* (province) of the Anglo-Egyptian Sudan. It lies wholly within the region known as Nubia and extends along both banks of the Nile from about 18° N. to 20° N. The rainfall is very slight, and the area of fertility is mainly confined to the lands watered by the Nile. Beyond stretches eastward the Nubian desert, westward the Libyan desert. The Wadi el Kab (Gab), west of and parallel to the Nile, contains, however, a good deal of arable land. This wadi, which is some 63 m. long, obtains water by percolation from the Nile. Farther west is the extensive plateau of Jebel Abiad, and beyond, some 250 m. due west of Debba, is Bir Natron, or Bir Sultan, a valley whence natron is obtained. In this desert region is found the addax, the rarest of Sudan antelopes. The chief grain crops are durra and barley, and date palms are extensively cultivated. The province is also noted for a breed of strong, hardy horses. The largest town is Dongola, but the administrative headquarters of the *muḍirra* are at New Merawi (Merowe, Meroe), on the left bank of the Nile, below the 4th cataract. Other towns, also on the Nile, are Debba and Korti, whence start caravan routes to Kordofan and Omdurman. At Jebel Barkal, in the neighbourhood of Merawi, and elsewhere in the *muḍirra*, are ancient ruins (see *SUDAN: Anglo-Egyptian*). Old Merawi, on the right bank of the Nile, and Sanam Abu Dom, on the left bank, indicate the site of the Ethiopian city of Napata. From Kareima, on the right or northern bank of the Nile, 6 m. above New Merawi, a railway (opened in March 1906) runs to Abu Hamed, whence there is railway connexion with the Red Sea, Khartum and Egypt. From Kareima downstream the Nile is navigable to Kerma, just above the 3rd cataract. Between 1896 and 1904 a railway ran between Kerma and Wadi Halfa. In the last-named year this railway was closed. It had been built for purely military purposes and was unremunerative as a commercial undertaking.

The Dongolese (Dongolawi, Danaglas, Danagalehs) are Nubas in type and language, but have a large admixture of Arab, Turk and other blood. They are great agriculturists and keen

traders, and were notorious slave-dealers. South of Old Dongola the inhabitants are not Nubians but Shagia (q.v.), and the Nubian tongue is replaced by Arabic. Of the nomad desert tribes the chief are the Hawawir and Kabbabish.

The country now forming the mudiria was once part of the ancient empire of Ethiopia (q.v.), Napata being one of its capital cities. From about the beginning of the Christian era the chief tribes in the region immediately south of Egypt were the Blemmyes and the Nobatae. The last named became converted to Christianity about the middle of the 6th century, through the instrumentality, it is stated, of the empress Theodora. A chieftain of the Nobatae, named Silko, between the middle and the close of that century, conquered the Blemmyes, founded a new state, apparently on the ruins of that of the southern Meroe (Bakarawiya), made Christianity the official religion of the country, and fixed his capital at (Old) Dongola. This state, now generally referred to as the Christian kingdom of Dongola, lasted for eight or nine hundred years. Though late in reaching Nubia, Christianity, after the wars of Silko, spread rapidly, and when the Arab conquerors of Egypt sought to subdue Nubia also they met with stout resistance. Dongola, however, was captured by the Moslems in 652, and the country laid under tribute (*bakt*)—400 men having to be sent yearly to Egypt. This tribute was paid when it could be enforced; at periods the Nubians gained the upper hand, as in 737 when Cyriacus, their then king, marched into Egypt with a large army to redress the grievances of the Copts. There is a record of an embassy sent by a king Zacharias in the 9th century to Bagdad concerning the tribute, while by the close of the 10th century the Nubians seem to have regained almost complete independence. They did not, however, possess any part of the Red Sea coast, which was held by the Egyptians, who, during the 9th and 10th centuries, worked the emerald and gold mines between the Nile and the Red Sea. The kingdom, according to the Armenian historian Abu Salih, was in a very flourishing condition in the 12th century. It then extended from Assuan southward to the 4th cataract, and contained several large cities. Gold and copper mines were worked. The liturgy used was in Greek. In 1173 Shams addaula, a brother of Saladin, attacked the Nubians, captured the city of Ibrim (Primis), and among other deeds destroyed 700 pigs found therein. The Egyptians then retired, and for about 100 years the country was at peace. In 1275 the Mameluke sultan Bibars aided a rebel prince to oust his uncle from the throne of Nubia; the sultans Kalaun and Nasir also sent expeditions to Dongola, which was several times captured. Though willing to pay tribute to the Moslems, the Nubians clung tenaciously to Christianity, and, despite the raids to which the country was subjected, it appears during the 12th and 13th centuries to have been fairly prosperous. No serious attempt was made by the Egyptians to penetrate south of Napata, nor is it certain how far south of that place the authority of the Dongola kingdom (sometimes known as Mukarra) extended. It was neighboured on the south by another Christian state, Aloa (Alwa), with its capital Soba on the Blue Nile.

Cut off more and more from free intercourse with the Copts in Egypt, the Nubian Christians at length began to embrace Jewish and Mahomedan doctrines; the decay of the state was hastened by dissensions between Mukarra and Aloa. Nevertheless, the Nubians were strong enough to invade upper Egypt during the reign of Nawaya Krestos (1342-1372), because the governor of Cairo had thrown the patriarch of Alexandria into prison. The date usually assigned for the overthrow of the Christian kingdom is 1351. Only the northern part of the country (as far as the 3rd cataract) came under the rule of Egypt. Nevertheless, according to Leo Africanus, at the close of the 15th century Christianity and native states still survived in Nubia, and in the 16th century the Nubians sent messengers to Abyssinia to Father Alvarez, begging him to appoint priests to administer the sacraments to them—a request with which he was not able to comply. Thereafter the Nubian Church is without records. The Moslems may have extinguished it in blood, for the region between Dongola and Shendi appears to have been depopulated.

Between Assuan and Hannek the Turks introduced in the 16th century numbers of Bosnians, whose descendants ruled the district, paying but a nominal allegiance to the Porte. At Ibrim, Mahass, and elsewhere along the banks and in the islands of the Nile, they built castles, now in ruins. South of Hannek the kings of Sennar became overlords of the country. As the power of the Sennari declined, the nomad Shagia (or Shalkiyeh) attained pre-eminence in the Dongola district.

About 1812 Mamelukes fleeing from Mehemet Ali, the pasha of Egypt, made themselves masters of part of the country, destroying the old capital and building a new one lower down the Nile. In 1820 both Mamelukes and Shagia were conquered by the Egyptians, and the Dongola province annexed to Egypt. In consequence of the rising of the Dervishes Egypt evacuated Dongola in 1886. The attempt to set up an independent government failed, and the Dervishes held the town until September 1896, when it was reoccupied by an Egyptian force.

See J. L. Burckhardt, *Travels in Nubia* (London, 1819); Naum Bey Shucair, *The History and Geography of the Sudan* (in Arabic, 3 vols., Cairo, 1903); E. A. Wallis Budge, *The Egyptian Sudan* (2 vols., London, 1907).

DONGOLA, a town of the Anglo-Egyptian Sudan, which gives its name to a mudiria. It is situated on the W. bank of the Nile, about 45 m. above the 3rd cataract, in 10° 10' N., 30° 20' E. Pop. about 10,000. It is 1082 m. S. of Cairo by river and 638 m. N. of Khartum by the same route. Its commercial outlet, however, is Port Sudan, on the Red Sea, 600 m. E.S.E. by steamer and railway. It is a thriving, well-built town; an important agricultural and trading centre. Lignite is found on the east bank of the Nile opposite the town. Founded c. 1812 by Mamelukes who fled to Nubia from the persecutions of Mehemet Ali, the town is called Dongola Makara (New Dongola) to distinguish it from Dongola Agusa (Old Dongola), which it supplanted. It is also called El Ordî (the barracks), a reminiscence of the buildings erected by the Egyptians after their occupation of the town in 1820. The Mahdi Mahommed Ahmed was a native of Dongola. In 1884-1885 the town was the base of the British troops in their advance on Khartum.

Dongola Agusa, 75 m. upstream from New Dongola, now a heap of ruins, was the capital of the Nubian state usually called the Christian kingdom of Dongola. An Arab historian of the 11th century describes it as a large city with many churches, fine houses and wide streets. It is said to have been finally destroyed by the Mamelukes. On a hill near the ruins is a mosque in which is an Arabic inscription stating that the building was opened "on the 20th Rabi el Aneh in the year 717 (June 1, 1317 A.D.) after the victory of Sefeddin Abdallah en Nasir over the Infidels."

DONIZETTI, GAETANO (1798-1848), Italian musical composer, was born at Bergamo in 1798, the son of a government official of limited means. Originally destined for the bar, he showed at an early age a strong taste for art. At first, strangely enough, he mistook architecture for his vocation, and only after an unsuccessful trial in that direction did he discover his real talent. He entered the conservatoire of his native city, where he studied under Simon Mayr, the fertile operatic composer. His second master was Mattei, the head master of the celebrated music school of Bologna, where Donizetti resided for three years. After his return to Bergamo the young composer determined to devote himself to dramatic music, but his father insisted upon his giving lessons with a view to immediate gain. The disputes arising from this cause ultimately led to Donizetti's enlisting in the army. But this desperate step proved beneficial against all expectation. The regiment was quartered at Venice, and here the young composer's first dramatic attempt, an opera called *Enrico conte di Borgogna*, saw the light in 1818.

The success of this work, and of a second opera brought out in the following year, established Donizetti's reputation. He obtained his discharge from the army, and henceforth his operas followed each other in rapid and uninterrupted succession at the rate of three or four a year. Although he had to contend successively with two such dangerous rivals as Rossini and Bellini, he succeeded in taking firm hold of the public, and the

brilliant reception accorded to his *Anna Bolena* at Milan carried his name beyond the limits of his own country. In 1835 Donizetti went for the first time to Paris, where, however, his *Marino Faliero* failed to hold its own against Bellini's *Puritani*, then recently produced at the Théâtre Italien. The disappointed composer went to Naples, where the enormous success of his *Lucia di Lammermoor* consoled him for his failure in Paris. For Naples he wrote a number of works, none of which is worth notice. In 1840 the censorship refused to pass his *Polisuto*, an Italian version of Corneille's *Polyeucte*, in consequence of which the disgusted composer once more left his country for Paris. Here he produced at the Opéra Comique his most popular opera, *La Fille du régiment*, but again with little success. It was not till after the work had made the round of the theatres of Germany and Italy that the Parisians reconsidered their unfavourable verdict. A serious opera, *Les Martyrs*, produced about the same time with the *Daughter of the Regiment*, was equally unsuccessful, and it was reserved to *La Favorita*, generally considered as Donizetti's masterpiece, to break the evil spell. His next important work, *Linda di Chamounix*, was written for Vienna, where it was received most favourably in 1842, and the same success accompanied the production of *Don Pasquale* after Donizetti's return to Paris in 1843. Soon after this event the first signs of a fatal disease, caused to a great extent by overwork, began to show themselves. The utter failure of *Don Sebastian*, a large opera produced soon after *Don Pasquale*, is said to have hastened the catastrophe. A paralytic stroke in 1844 deprived Donizetti of his reason; for four years he lingered on in a state of mental and physical prostration. A visit to his country was proposed as a last resource, but he reached his native place only to die there on the 1st of April 1848.

The sum total of his operas amounts to sixty-four. The large number of his works accounts for many of their chief defects. His rapidity of working made all revision impossible. It is said that he once wrote the instrumentation of a whole opera within thirty hours, a time hardly sufficient, one would think, to put the notes on paper. And yet it may be doubted whether more elaboration would have essentially improved his work; for the last act of the *Favorita*, infinitely superior to the preceding ones, is also said to have been the product of a single night.

There is a strange parallelism observable in the lives of Rossini, Bellini and Donizetti. They had no sooner established their reputations on the Italian stage than they left their own country for Paris, at that time the centre of the musical world. All three settled in France, and all three were anxious to adapt the style of their music to the taste and artistic traditions of their adopted country. The difference which exists between Rossini's *Tell* and his *Semiramide* may, although in a less striking degree, be noticed between Donizetti's *Fille du régiment* and one of his earlier Italian operas. But here the parallel ends. As regards artistic genius Donizetti can by no means be compared with his illustrious countrymen. He has little of Bellini's melancholy sweetness, less of Rossini's sparkle, and is all but devoid of spontaneous dramatic impulse. For these shortcomings he atones by a considerable though by no means extraordinary store of fluent melody, and by his rare skill in writing for the voice. The duet in the last act of the *Favorita* and the ensemble in *Lucia* following upon the signing of the contract, are masterpieces of concerted music in the Italian style. These advantages, together with considerable power of humorous delineation, as evinced in *Don Pasquale* and *L'Elisir d'amore*, must account for the unimpaired vitality of many of his works on the stage.

DONJON (from a Late Lat. accusative form *domnionem*, connected with *domnus* or *dominus*, a lord), the French term for the keep of a mediæval castle, used now in distinction to "dungeon" (*q.v.*), the prison, which is only an anglicized spelling (see also *KEEP*).

DON JUAN, a legendary character, whose story has found currency in various European countries. He was introduced into formal literature in the Spanish *El Burlador de Sevilla y convidado de piedra*, a play which was first printed at Barcelona in 1630, and is usually attributed to Tirso de Molina; but the story of a

profligate inviting a dead man to supper, and finding his invitation accepted, was current before 1630, and is not peculiar to Spain. A Don Juan Tenorio is said to have frequented the court of Peter the Cruel, and at a later period another Don Juan Tenorio, a dissolute gallant, is reported as living at Seville; but there is no satisfactory evidence of their existence, and it is unlikely that the Don Juan legend is based on historical facts. It exists in Picardy as *Le Souper de fantôme*, and variants of it have been found at points so far apart as Iceland and the Azores; the available evidence goes to show that Don Juan is a universal type, that he is the subject of local myths in many countries, that he received his name in Spain, and that the Spanish version of his legend has absorbed certain elements from the French story of Robert the Devil. Some points of resemblance are observable between *El Burlador de Sevilla* and *Dineros son calidad*, a play of earlier date by Lope de Vega; but these resemblances are superficial, and the character of Don Juan, the incarnation of perverse sensuality and arrogant blasphemy, may be considered as the creation of Tirso de Molina, though the ascription to him of *El Burlador de Sevilla* has been disputed. The Spanish drama was apparently more popular in Italy than in Spain, and was frequently given in pantomime by the Italian actors, who accounted for its permanent vogue by saying that Tirso de Molina had sold his soul to the devil for fame. A company of these Italian mimes took the story into France in 1657, and it was dramatized by Dorimond in 1659 and by De Villiers in 1661; their attempts suggested *Le Festin de pierre* (1665) to Molière, who, apparently with the Spanish original before his eyes, substituted prose for verse, reduced the supernatural element, and interpolated comic effects completely out of keeping with the earlier conception. Later adaptations by Rosimond and Thomas Corneille were even less successful. The story was introduced into England by Sir Aston Cokain in his unreadable *Tragedy of Ovid* (1669), and was the theme of *The Libertine* (1676), a dull and obscene play by Shadwell. Goldoni's *D. Giovanni Tenorio ossia Il Dissoluto*, based upon the adaptations of Molière and Thomas Corneille, is one of his least interesting productions. Tirso de Molina's play was recast, but not improved, by Antonio de Zamora early in the 18th century. A hundred years later the character of Don Juan was endowed with a new name in Espronceda's *Estudiante de Salamanca*; Don Félix de Montemar is plainly modelled on Don Juan Tenorio, and rivals the original in licentiousness, impiety and grim humour. But the most curious resuscitation of the type in Spain is the protagonist in Zorrilla's *Don Juan Tenorio*, which is usually played in all large cities during the first week in November, and has come to be regarded as an essentially national work. It is in fact little more than an adaptation of the elder Dumas' *Don Juan de Marana*, which, in its turn, derives chiefly from Mérimée's novel, *Les Ames du purgatoire*. Less exotic are Zorrilla's two poems on the same subject—*El Desafío del diablo* and *El Testigo de bronce*. Byron's *Don Juan* presents a Regency lady-killer who resembles Ulloa's murderer in nothing but his name.

The sustained popularity of the Don Juan legend is undoubtedly due in great measure to Mozart's incomparable setting of Da Ponte's mediocore libretto. In this pale version of *El Burlador de Sevilla* the French romantic school made acquaintance with Don Juan, and hence, no doubt, the works of Mérimée and Dumas already mentioned, Balzac's *Élixir d'une longue vie*, and Alfred de Musset's *Une Mainée de Don Juan* and *Namouna*. The legend has been treated subsequently by Flaubert and Barbey d'Aurevilly in France, by Landau and Heyse in Germany, and by Sacher-Masoch in Austria. It has always fascinated composers. Mozart's *Don Giovanni* has annihilated the earlier operas of Le Tellier, Righini, Tritto, Gardi and Gazzaniga; but Gluck's ballet-music still survives, and Henry Purcell's setting—the oldest of all—has saved some of Shadwell's insipid lyrics from oblivion.

BIBLIOGRAPHY.—F. de Simone Brouwer, *Don Giovanni nella poesia e nell'arte musicale* (Napoli, 1894); A. Farinelli, *Don Giovanni: Note critiche* (Torino, 1896); A. Farinelli, *Cuatro palabras sobre Don Juan y la literatura donjuanesca del porvenir en la Homenaje a Menéndez y Pelayo* (Madrid, 1899), vol. i. pp. 205-222. (J. F.-K.)

DONKIN, SIR RUFANE SHAW (1773-1841), British soldier, came of a military family. His father, who died, a full general, in 1821, served with almost all British commanders from Wolfe to Gage. Rufane Donkin was the eldest child, and received his first commission at the age of five in his father's regiment; he joined, at fourteen, with eight years' seniority as a lieutenant. Becoming a captain in 1793, he was on active service in the West Indies in 1794, and (as major) in 1796. At the age of twenty-five he became lieutenant-colonel, and in 1798 led a light battalion with distinction in the Ostend expedition. He served with Cathcart in Denmark in 1807, and two years later was given a brigade in the army in Portugal, which he led at Oporto and Talavera. He was soon transferred, as quartermaster-general, to the Mediterranean command, in which he served from 1810 to 1813, taking part in the Catalonian expeditions. Sir John Murray's failure at Tarragona did not involve Donkin, whose advice was proved to be uniformly ignored by the British commander. In July 1815 Major-General Donkin went out to India, and distinguished himself as a divisional commander in Hastings' operations against the Mahrattas (1817-1818), receiving the K.C.B. as his reward. The death of his young wife seriously affected him, and he went to the Cape of Good Hope on sick leave. From 1820 to 1821 he administered the colony with success, and named the rising seaport of Algoa Bay Port Elizabeth in memory of his wife. In 1821 he became lieutenant-general and G.C.H. The rest of his life was spent in literary and political work. He was one of the original fellows of the Royal Geographical Society, and was a member of the Royal Society and of many other learned bodies. His theories as to the course of the river Niger, published under the title *Dissertation on the Course and Probable Termination of the Niger* (London, 1820), involved him in a good deal of controversy. From 1832 onwards he sat in the House of Commons, and in 1835 was made surveyor-general of the ordnance. He committed suicide at Southampton in 1841. He was then a general, and colonel of the 11th Foot.

See Jerdan, *National Portraits*, vol. iii.; *Gentleman's Magazine*, xcii. i. 273.

DONWAY, CHARLES MAURICE (1859-), French dramatist, was born of middle-class parents in Paris in 1859. He made his serious début as a dramatist on the little stage of the Chat Noir with *Phryné* (1891), a series of Greek scenes. *Lysistrata*, a four-act comedy, was produced at the Grand Théâtre in 1892 with Mme Réjane in the title part. Later plays were *Folle Entreprise* (1894); *Pension de famille* (1894); *Complices* (1895), in collaboration with M. Groselande; *Amanis* (1895), produced at the Renaissance theatre with Mme Jeanne Granier as Claudine Rozéray; *La Douleuruse* (1897); *L'Affranchie* (1898); *Georgette Lemesnier* (1898); *Le Torrent* (1899), at the Comédie Française; *Éducation de prince* (1900); *La Clairière* (1900), and *Oiseaux de passage* (1904), in collaboration with L. Descaves; *La Bascule* (1901); *L'Autre danger*, at the Comédie Française (1902); *Le Retour de Jérusalem* (1903); *L'escalade* (1904); and *Paratire* (1906). With *Amanis* he won a great success, and the play was hailed by Jules Lemaitre as the *Bérénice* of contemporary French drama. Very advanced ideas on the relations between the sexes dominate the whole series of plays, and the witty dialogue is written with an apparent carelessness that approximates very closely to the language of every day.

DONNE, JOHN (1573-1631), English poet and divine of the reign of James I., was born in 1573 in the parish of St Nicholas Olave, in the city of London. His father was a wealthy merchant, who next year became warden of the Company of Ironmongers, but died early in 1576. Donne's parents were Catholics, and his mother, Elizabeth Heywood, was directly descended from the sister of the great Sir Thomas More; she was the daughter of John Heywood the epigrammatist. As a child, Donne's precocity was such that it was said of him that "this age hath brought forth another Pico della Mirandola." He entered Hart Hall, Oxford, in October 1584, and left it in 1587, proceeding for a time to Cambridge, where he took his degree. At Oxford he began his friendship with Henry Wotton, and at Cambridge, probably, with Christopher Brooke. Donne was "removed to London" about

1590, and in 1592 he entered Lincoln's Inn with the intention of studying the law.

When he came of age, he found himself in possession of a considerable fortune, and about the same time rejected the Catholic doctrine in favour of the Anglican communion. He began to produce *Saïres*, which were not printed, but eagerly passed from hand to hand; the first three are known to belong to 1593, the fourth to 1594, while the other three are probably some years later. In 1596 Donne engaged himself for foreign service under the earl of Essex, and "waited upon his lordship" on board the "Repulse," in the magnificent victory of the 11th of June. We possess several poems written by Donne during this expedition, and during the Islands Voyage of 1597, in which he accompanied Essex to the Azores. According to Walton, Donne spent some time in Italy and Spain, and intended to proceed to Palestine, "but at his being in the farthest parts of Italy, the disappointment of company, or of a safe convoy, or the uncertainty of returns of money into those remote parts, denied him that happiness." There is some reason to suppose that he was on the continent at intervals between 1595 and the winter of 1597. His lyrical poetry was mainly the product of his exile, if we are to believe Ben Jonson, who told Drummmond of Hawthornden that Donne "wrote all his best pieces ere he was 25 years old." At his return to England he became private secretary in London to Sir Thomas Egerton, the lord keeper (afterwards Lord Brackley), in whose family he remained four years. In 1600 he found himself in love with his master's niece, Anne More, whom he married secretly in December 1601. As soon as this act was discovered, Donne was dismissed, and then thrown into the Fleet prison (February 1602), from which he was soon released. His circumstances, however, were now very much straitened. His own fortune had all been spent and "troubles did still multiply upon him." Mrs Donne's cousin, Sir Francis Wooley, offered the young couple an asylum at his country house of Pyrford, where they resided until the end of 1604.

During the latter part of his residence in Sir Thomas Egerton's house, Donne had composed the longest of his existing poems, *The Progress of the Soul*, not published until 1633. In the spring of 1605 we find the Donnes living at Camberwell, and a little later in a small house at Mitcham. He had by this time "acquired such a perfection" in civil and common law that he was able to take up professional work, and he now acted as a helper to Thomas Morton in his controversies with the Catholics. Donne is believed to have had a considerable share in writing the pamphlets against the papists which Morton issued between 1604 and 1607. In the latter year, Morton offered the poet certain preferment in the Church, if he would only consent to take holy orders. Donne, however, although he was at this time become deeply serious on religious matters, did not think himself fitted for the clerical life. In 1607 he started a correspondence with Mrs Magdalen Herbert of Montgomerie Castle, the mother of George Herbert. Some of these pious epistles were printed by Isaac Walton. These exercises were not of a nature to add to his income, which was extremely small. His uncomfortable little house he speaks of as his "hospital" and his "prison;" his wife's health was broken and he was bowed down by the number of his children, who often lacked even clothes and food. In the autumn of 1608, however, his father-in-law, Sir George More, became reconciled with them, and agreed to make them a generous allowance. Donne soon after formed part of the brilliant assemblage which Lucy, countess of Bradford, gathered around her at Twickenham; we possess several of the verse epistles he addressed to this lady. In 1609 Donne was engaged in composing his great controversial prose treatise, the *Pseudo-Martyr*, printed in 1610; this was an attempt to convince Roman Catholics in England that they might, without any inconsistency, take the oath of allegiance to James I. In 1611 Donne wrote a curious and bitter prose squib against the Jesuits, entitled *Ignatius his Conclave*. To the same period, but possibly somewhat earlier, belongs the apology for the principle of suicide, which was not published until 1644, long after Donne's death. This work, the *Balthazares*, is an attempt to show that "the scandalous disease

of headlong dying," to which Donne himself in his unhappy moods had "often such a sickly inclination," was not necessarily and essentially sinful.

In 1610 Donne formed the acquaintance of a wealthy gentleman, Sir Robert Drury of Hawsted, who offered him and his wife an apartment in his large house in Drury Lane. Drury lost his only daughter, and in 1611 Donne published an extravagant elegy on her, entitled *An Anatomy of the World*, to which he added in 1612 a *Progress of the Soul* on the same subject; he threatened to celebrate the "blessed Maid," Elizabeth Drury, in a fresh elegy on each anniversary of her death, but he happily refrained from the third occasion onwards. At the close of 1611 Sir Robert Drury determined to visit Paris (but not, as Walton supposed, on an embassy of any kind), and he took Donne with him. When he left London, his wife was expecting an eighth child. It seems almost certain that her fear to have him absent led him to compose one of his loveliest poems:

"Sweetest Love, I do not go
For weariness of thee."

He is said to have had a vision, while he was at Amiens, of his wife, with her hair over her shoulders, bearing a dead child in her arms, on the very night that Mrs Donne, in London (or more probably in the Isle of Wight), was delivered of a still-born infant. He suffered, accordingly, a great anxiety, which was not removed until he reached Paris, where he received reassuring accounts of his wife's health. The Drurys and Donne left Paris for Spa in May 1612, and travelled in the Low Countries and Germany until September, when they returned to London. In 1613 Donne contributed to the *Lachrymæ lachrymarum* an obscure and frigid elegy on the death of the prince of Wales, and wrote his famous Marriage Song for St Valentine's Day to celebrate the nuptials of the elector palatine with the princess Elizabeth. About this time Donne became intimate with Robert Ker, then Viscount Rochester and afterwards the infamous earl of Somerset, from whom he had hopes of preferment at court. Donne was now in weak health, and in a highly neurotic condition. He suggested to Rochester that if he should enter the church, a place there might be found for him. But he was more useful to the courtier in his legal capacity, and Rochester dissuaded him from the ministry. At the close of 1614, however, the king sent for Donne to Theobald's, and "descended to a persuasion, almost to a solicitation of him, to enter into sacred orders," but Donne asked for a few days to consider. Finally, early in 1614, King, bishop of London, "proceeded with all convenient speed to ordain him, first deacon, then priest." He was, perhaps, a curate first at Paddington, and presently was appointed royal chaplain.

His earliest sermon before the king at Whitehall carried his audience "to heaven, in holy raptures." In April, not without much bad grace, the university of Cambridge consented to make the new divine a D.D. In the spring of 1616, Donne was presented to the living of Keyston, in Hunts., and a little later he became rector of Sevenoaks; the latter preferment he held until his death. In October he was appointed reader in divinity to the benchers of Lincoln's Inn. His anxieties about money now ceased, but in August 1617 his wife died, leaving seven young children in his charge. Perhaps in consequence of his bereavement, Donne seems to have passed through a spiritual crisis, which inspired him with a peculiar fervour of devotion. In 1618 he wrote two cycles of religious sonnets, *La Corona* and the *Holy Sonnets*, the latter not printed in complete form until by Mr Gosse in 1899. Of the very numerous sermons preached by Donne at Lincoln's Inn, fourteen have come down to us. His health suffered from the austerity of his life, and it was probably in connexion with this fact that he allowed himself to be persuaded in May 1619 to accompany Lord Doncaster as his chaplain on an embassy to Germany. Having visited Heidelberg, Frankfurt and other German cities, the embassy returned to England at the opening of 1620.

In November 1621, James I., knowing that London was "a dish" which Donne "loved well," "carved" for him the deanery of St Paul's. He resigned Keyston, and his preachingship in Lincoln's Inn (Feb., 1622). In October 1623 he suffered from

a dangerous attack of illness, and during a long convalescence wrote his *Devotions*, a volume published in 1624. He was now appointed to the vicarage of St Dunstan's in the West. In April 1625 Donne preached before the new king, Charles I., a sermon which was immediately printed, and he now published his *Four Sermons upon Special Occasions*, the earliest collection of his discourses. When the plague broke out he retired with his children to the house of Sir John Danvers in Chiswick, and for a time he disappeared so completely that a rumour arose that he was dead. Sir John had married Donne's old friend, Mrs Magdalen Herbert, for whom Donne wrote two of the most ingenious of his lyrics, "The Primrose" and "The Autumnal." The popularity of Donne as a preacher rose to its zenith when he returned to his pulpit, and it continued there until his death. Walton, who seems to have known him first in 1624, now became an intimate and adoring friend. In 1630 Donne's health, always feeble, broke down completely, so that, although in August of that year he was to have been made a bishop, the entire breakdown of his health made it worse than useless to promote him. The greater part of that winter he spent at Abury Hatch, in Epping Forest, with his widowed daughter, Constance Alleyne, and was too ill to preach before the king at Christmas. It is believed that his disease was a malarial form of recurrent quinsy acting upon an extremely neurotic system. He came back to London, and was able to preach at Whitehall on the 12th of February 1631. This, his latest sermon, was published, soon after his demise, as *Death's Duet*. He now stood for his statue to the sculptor, Nicholas Stone, standing before a fire in his study at the Deanery, with his winding-sheet wrapped and tied round him, his eyes shut, and his feet resting on a funeral urn. This lugubrious work of art was set up in white marble after his death in St Paul's cathedral, where it may still be seen. Donne died on the 31st of March 1631, after he had lain "fifteen days earnestly expecting his hourly change." His aged mother, who had lived in the Deanery, survived him, dying in 1632.

Donne's poems were first collected in 1633, and afterwards in 1635, 1639, 1649, 1650, 1654 and 1669. Of his prose works, the *Juvenilia* appeared in 1633; the *LXXX Sermons* in 1640; *Biathanatos* in 1644; *Fifty Sermons* in 1649; *Essays in Divinity*, 1651; his *Letters to Several Persons of Honour*, 1651; *Paradoxes, Problems and Essays*, 1652; and *Six and Twenty Sermons*, 1661. Izaak Walton's *Life of Donne*, an admirably written but not entirely correct biography, preceded the *Sermons* of 1640. The principal editor of his posthumous writings was his son, John Donne the younger (1604-1662), a man of eccentric and scandalous character, but of considerable talent.

The influence of Donne upon the literature of England was singularly wide and deep, although almost wholly malign. His originality and the fervour of his imaginative passion made him extremely attractive to the younger generation of poets, who saw that he had broken through the old tradition, and were ready to follow him implicitly into new fields. In the 18th century his reputation almost disappeared, to return, with many vicissitudes in the course of the 19th. It is, indeed, singularly difficult to pronounce a judicious opinion on the writings of Donne. They were excessively admired by his own and the next generation, praised by Dryden, paraphrased by Pope, and then entirely neglected for a whole century. The first impression of an unbiased reader who dips into the poems of Donne is unfavourable. He is repulsed by the intolerably harsh and crabbed versification, by the recondite choice of theme and expression, and by the oddity of the thought. In time, however, he perceives that behind the fantastic garb of language there is an earnest and vigorous mind, an imagination that harbours fire within its cloudy folds, and an insight into the mysteries of spiritual life which is often startling. Donne excels in brief flashes of wit and beauty, and in sudden daring phrases that have the full perfume of poetry in them. Some of his lyrics and one or two of his elegies excepted, the *Satires* are his most important contribution to literature. They are probably the earliest poems of their kind in the language, and they are full of force and picturesqueness. Their obscure and knotty language only serves to give peculiar

brilliantly to the not uncommon passages of noble perspicacity. To the odd terminology of Donne's poetic philosophy Dryden gave the name of "metaphysics," and Johnson, borrowing the suggestion, invented the title of the "metaphysical school" to describe, not Donne only, but all the amorous and philosophical poets who succeeded him, and who employed a similarly fantastic language, and who affected odd figurative inversions.

Isaac Walton's *Life*, first published in 1640, and entirely reast in 1659, has been constantly reprinted. The best edition of Donne's *Poems* was edited by E. K. Chambers in 1896. His prose works have not been collected. In 1899 Edmund Gosse published in two volumes *The Life and Letters of John Donne*, for the first time revised and collected. (E. G.)

DONNYBROOK, a part of Dublin, Ireland, in the south-east of the city. The former village of the name was famous for a fair held under licence from King John in 1204. It gained, however, such a scandalous notoriety for disorder that it was discontinued in 1855, the rights being purchased for £3000.

DONOSO CORTÉS, JUAN, Marquis de Valdegamas (1809-1853), Spanish author and diplomatist, was born at Valle de la Serena (Extremadura) on the 6th of May 1809, studied law at Seville, and entered politics as an advanced liberal under the influence of Quintana (q.v.). His views began to modify after the rising at La Granja, and this tendency towards conservatism, which became more marked on his appointment as private secretary to the Queen Regent, finds expression in his *Lecciones de derecho político* (1837). Alarmed by the proceedings of the French revolutionary party in 1848-1849, Donoso Cortés issued his *Ensayo sobre el catolicismo, el liberalismo, y el socialismo considerados en sus principios fundamentales* (1851), denouncing reason as the enemy of truth and liberalism as leading to social ruin. He became ambassador at Paris, and died there on the 3rd of May 1853. The *Ensayo* has failed to arrest the movement against which it was directed, and is weakened by its extravagant paradoxes; but, with all its rhetorical excesses, it remains the finest specimen of impassioned prose published in Spain during the 19th century.

Donoso Cortés' works were collected in five volumes at Madrid (1854-1855) under the editorship of Gavino Tejado.

DONOVAN, EDWARD (1768-1837), English naturalist, was the author of many popular works on natural history and botany. In 1792 appeared the first volume of his *Natural History of British Insects*, which extended to sixteen volumes, and was completed in 1813. He also published *Natural Histories of British Birds*, in 10 vols. 8vo (1799-1819), of *British Fishes*, in 5 vols. (1802-1808), of *British Shells*, in 5 vols. (1800-1804), a series of illustrated works on *The Insects of India, China, New Holland, &c.*, in 3 vols. 4to (1798-1805), and *Excursions in South Wales and Monmouthshire* (1805). To these works must be added his periodical entitled *The Naturalist's Repository*, a monthly publication, of which three volumes were completed (1823-1825), and an *Essay on the Minute Parts of Plants in general*. Donovan was author of the articles on natural history in Rees's *Cyclopaedia*. In 1833 he published a *Memorial respecting my Publications in Natural History*, in which he complains that he had been nearly ruined by his publishers. He was a fellow of the Linnean Society, and died in London on the 1st of February 1837.

DOOM (Old Eng. *dōm*, a word common to Teut. languages for that which is set up or ordered, from "do," in its original meaning of "place," cf. Gr. *θέμα*, from stem of *τίθημι*), originally a law or enactment, the legal decision of a judge, and particularly an adverse sentence on a criminal. The word is thus applicable to the adverse decrees of fate, and particularly to the day of judgment. The verb "deem," to deliver a judgment, and hence to give or hold an opinion, is a derivative, and appears also in various old Teutonic forms. It is seen in "deemster," the name of the two judges of the Isle of Man.

DOON DE MAYENCE, a hero of romance, who gives his name to the third cycle of the Charlemagne romances, those dealing with the feudal revolts. There is no real unity in the *geste* of Doon de Mayence. The rebellious barons are connected by the

trouvères with Doon by imaginary genealogical ties, and all are represented as in opposition to Charlemagne, though their adventures, in so far as they possess a historical basis, must generally be referred to earlier or later periods than the reign of the great emperor. The general insolence of their attitude to the sovereign suggests that Charlemagne is here only a name for his weaker successors. The tradition of a traitorous family of Mayence, which was developed in Italy into a series of stories of criminals, was however anterior to the Carolingian cycle, for an interpolator in the chronicle of Fredegarius (iv. 87) that the army of Sigebert was betrayed from within its own ranks by men of Mayence in a battle fought with Radulf on the banks of the Unstrut in Thuringia. The chief heroes of the poems which make up the *geste* of Doon de Mayence are Ogier the Dane (q.v.), the four sons of Aymon (see RENAUD), and Huon of Bordeaux (q.v.). It is probable that Doon himself was one of the last personages to be clearly defined, and that the *chanson de geste* relating his exploits was drawn up partly with the view of supplying a suitable ancestor for the other heroes. The latter half of the poem, the story of Doon's wars in Saxony, is perhaps based on historical events, but the earlier half, which is really a separate romance dealing with his romantic childhood, is obviously pure fiction and dates from the 13th century. Doon had twelve sons: Gaufrey de Dane Marche (Ardennes?), the father of Ogier; Doon de Nanteuil, whose son Garnier married the beautiful Aye d'Avignon; Griffon d'Hauteville, father of the arch-traitor Ganelon; Aymon de Dordone or Dourdan, whose four sons were so relentlessly pursued by Charles; Beuves d'Aigremont, whose son was the enchanter Maugis; Sevin or Seguin, the father of Huon of Bordeaux; Girard de Roussillon, and others less known. The history of these personages is given in *Doon de Mayence*, *Gaufrey*, the romances relating to Ogier, *Aye d'Avignon*, the fragmentary *Doon de Nanteuil*, *Gai de Nanteuil*, *Tristan de Nanteuil*, *Parise la Duchesse*, *Maugis d'Aigremont*, *Vivien l'amoureux de Monbranc*, *Renaus de Montauban* or *Les Quatre Fils Aymon*, and *Huon de Bordeaux*. Some of this material, which dates in its existing form from the 12th and 13th centuries, remains unpublished, but the chief poems are available in the series of *Anciens Poètes de la France* (1859, &c.).

See *Hist. litt. de la France*, vols. xxii. and xxvi. (1859 and 1873), for analyses of these poems by Paulin Paris; also J. Barrois, *Éléments carolingiens* (Paris, 1846); W. Niederstadt, *Aller und Heimt altsfr. Doon* (Greifswald, 1889). The prose romance, *La Fleur des batailles Doodin de Mayence*, was printed by Antoine Verard (Paris, 1501), by Alain Lotrian and Denis Janot (Paris, c. 1530), by N. Bonifous (Paris; no date), by J. Waesbergue (Rotterdam, 1604), &c.

DOOR (corresponding to the Gr. *θύρα*, Lat. *fores* or *valvae*; the English word, with other forms common in allied languages, comes from the same Indo-European stem as the Gr. *θύρα* and Lat. *fores*), in architecture, the slab, flap or leaf forming the enclosure of a doorway (q.v.), either in wood, metal or stone. The earliest records are those represented in the paintings of the Egyptian tombs, in which they are shown as single or double doors, each in a single piece of wood. In Egypt, where the climate is intensely dry, there would be no fear of their warping, but in other countries it would be necessary to frame them, which according to Vitruvius (iv. 6.) was done with stiles (*scapi*) and rails (*impages*): the spaces enclosed being filled with panels (*lympana*) let into grooves made in the stiles and rails. The stiles were the vertical boards, one of which, tenoned or hinged, is known as the hanging stile, the other as the middle or meeting stile. The horizontal cross pieces are the top rail, bottom rail, and middle or intermediate rails. The most ancient doors were in timber, those made for King Solomon's temple being in olive wood (1 Kings vi. 31-35), which were carved and overlaid with gold. The doors dwelt upon in Homer would appear to have been cased in silver or brass. Besides olive wood, elm, cedar, oak and cyprus were used. All ancient doors were hung by pivots at the top and bottom of the hanging stile which worked in sockets in the lintel and cill, the latter being always in some hard stone such as basalt or granite. Those found at Nippur by Dr Hilprecht, dating from 2000 B.C., were in dolomite. The tenons of

the gates at Balawat (see fig.) (895-825 B.C.) were sheathed with bronze (now in the British Museum). These doors or gates were hung in two leaves, each about 8 ft. 4 in. wide and 27 ft. high, they were encased with bronze bands or strips, 10 in. high, covered with repoussé decoration of figures, &c. The wood doors would seem to have been about 3 in. thick, but the hanging stile was over 14 in. in diameter. Other sheathings of various sizes in bronze have been found, which proves this to have been the universal method adopted to protect the wood pivots. In the



Hauran in Syria, where timber is scarce, the doors were made in stone, and one measuring 5 ft. 4 in. by 2 ft. 7 in. is in the British Museum; the band on the meeting stile shows that it was one of the leaves of a double door. At Kuffeir near Bosra in Syria, Burckhardt found stone doors, 9 to 10 ft. high, being the entrance doors of the town. In Etruria many stone doors are referred to by Dennis.

The ancient Greek and Roman doors were either single doors (*υποθύρας, unijores*), double doors (*διθύρας, bifores* or *geminæ*) or folding doors (*πίρυξ, palææ*); in the last case the leaves were hinged and folded back one over the other. At Pompeii, in the portico of sheath and socket. Eumachia, is a painting of a door with three leaves, the two outer ones of which were presumably hung, the inner leaf folding on one or the other; hinges connecting the folding leaves of a door have been found in Pompeii. In the tomb of Theron at Agrigento there is a single four-panel door carved in stone. In the Blundell collection is a bas-relief of a temple with double doors, each leaf with five panels. Among existing examples, the bronze doors in the church of SS. Cosmas and Damiano, in Rome, are important examples of Roman metal work of the best period; they are in two leaves, each with two panels, and are framed in bronze. Those of the Pantheon are similar in design, with narrow horizontal panels in addition, at the top, bottom and middle. Two other bronze doors of the Roman period are in the Lateran Basilica.

The doors of the church of the Nativity at Bethlehem (6th century) are covered with plates of bronze, cut out in patterns: those of Sta Sophia at Constantinople, of the 8th and 9th century, are wrought in bronze, and the west doors of the cathedral of Aix-la-Chapelle (9th century), of similar manufacture, were probably brought from Constantinople, as also some of those in St Mark's, Venice.

Of the 11th and 12th centuries there are numerous examples of bronze doors, the earliest being one at Hildesheim, Germany (1015). Of others in South Italy and Sicily, the following are the finest: in Sant' Andrea, Amalfi (1060); Salerno (1099), Canosa (1111); Troja, two doors (1119 and 1124); Ravello (1170), by Barisano of Trani, who also made doors for Trani cathedral; and in Monreale and Pisa cathedrals, by Bonano of Pisa. In all these cases the hanging stile had pivots at the top and bottom. The exact period when the hinge was substituted is not quite known, but the change apparently brought about another method of strengthening and decorating doors, viz. with wrought-iron bands of infinite varieties of design. As a rule three bands from which the ornamental work springs constitute the hinges, which have rings outside the hanging stiles fitting on to vertical tenons run into the masonry or wooden frame. There is an early example of the 12th century in Lincoln; in France the metal work of the doors of Notre Dame at Paris is perhaps the most beautiful in execution, but examples are endless throughout France and England.

Returning to Italy, the most celebrated doors are those of the Baptistery of Florence, which together with the door frames are all in bronze, the borders of the latter being perhaps the most remarkable: the modelling of the figures, birds and foliage of the south doorway, by Andrea Pisano (1330), and of the east doorway by Ghiberti (1425-1452), are of great beauty; in the north door (1402-1424) Ghiberti adopted the same scheme of design for the

panelling and figure subjects in them as Andrea Pisano, but in the east door the rectangular panels are all filled with bas-reliefs, in which Scripture subjects are illustrated with innumerable figures, these being probably the gates of Paradise of which Michelangelo speaks.

The doors of the mosques in Cairo were of two kinds; those which, externally, were cased with sheets of bronze or iron, cut out in decorative patterns, and incised or inlaid, with bosses in relief; and those in wood, which were framed with interlaced designs of the square and diamond, this latter description of work being Coptic in its origin. The doors of the palace at Palermo, which were made by Saracenic workmen for the Normans, are fine examples and in good preservation. A somewhat similar decorative class of door to these latter is found in Verona, where the edges of the stiles and rails are bevelled and notched.

In the Renaissance period the Italian doors are quite simple, their architects trusting more to the doorways for effect; but in France and Germany the contrary is the case, the doors being elaborately carved, especially in the Louis XIV. and Louis XV. periods, and sometimes with architectural features such as columns and entablatures with pediment and niches, the doorway being in plain masonry. While in Italy the tendency was to give scale by increasing the number of panels, in France the contrary seems to have been the rule; and one of the great doors at Fontainebleau, which is in two leaves, is entirely carried out as if consisting of one great panel only.

The earliest Renaissance doors in France are those of the cathedral of St Sauveur at Aix (1503); in the lower panels there are figures 3 ft. high in Gothic niches, and in the upper panels a double range of niches with figures about 2 ft. high with canopies over them, all carved in cedar. The south door of Beauvais cathedral is in some respects the finest in France; the upper panels are carved in high relief with figure subjects and canopies over them. The doors of the church at Gisors (1575) are carved with figures in niches subdivided by classic pilasters superimposed. In St Maclou at Rouen are three magnificently carved doors; those by Jean Goujon have figures in niches on each side, and others in a group of great beauty in the centre. The other doors, probably about forty to fifty years later, are enriched with bas-reliefs, landscapes, figures and elaborate interlaced borders.

In England in the 17th century the door panels were raised with "bollection" or projecting mouldings, sometimes richly carved, round them; in the 18th century the mouldings worked on the stiles and rails were carved with the egg and tongue ornament.

(R. P. S.)

DOORWAY (corresponding to the Gr. *πύλη*, Lat. *porta*), in architecture, the entrance to a building, apartment or enclosure. The term is more generally applied to the framing of the opening in wood, stone or metal. The representations in painting, and existing examples, show that whilst the jambs of the doorway in Egyptian architecture were vertical, the outer side had almost the same batter as the walls of the temples. In the doorways of enclosures or screen walls there was no lintel, but a small projection inwards at the top, to hold the pivot of the door. In Greece the linings of the earliest doorways at Tiryns were in wood, and in order to lessen the bearing of the lintel the dressings or jambs (*antepagmenta*) sloped inwards, so that the width of the doorway opening was less at the top than at the bottom. In the entrance doorway of the tomb of Agamemnon at Mycenæ, 18 ft. in height, the width is about 6 in. less at the top than at the bottom. The lintel of the Greek doorway projected on either side beyond the dressings, constituting what are known as the shoulders or knees (*procturæ*), a characteristic feature which has been retained down to our time. The next step was to work a projecting moulding round the dressings and lintel forming the architrave. Examples with shoulders in stone exist in the Beulé doorway of the Acropolis at Athens, in the tomb of Theron, and in a temple at Agrigento in Sicily; also in the temples of Hercules at Cora, and of Vesta at Trivoli, and with a peculiar pendant in all the Etruscan tombs. The most beautiful example of a Greek doorway is that under the north portico of the Erechtheum (450 B.C.). There is a slight diminution in the width at the top of the opening,

and outside the ordinary architrave mouldings (which here and in all classic examples are derived from those of the architrave of an order) is a band with rosettes, which recall the early decorative features in Crete and Mycenæ; the band being carried across the top of the lintel and surmounted by a cornice supported on each side by corbels (ancones).

In the Roman doorways, excepting those at Cora and Tivoli, there is, as a rule, no diminishing of the width, which is generally speaking half of the height. The dimensions of some of the Roman doorways are enormous; in the temple of the Sun at Palmyra the doorway is 15 ft. 6 in. wide and 33 ft. high; and in the temple of Jupiter at Baalbec, 20 ft. wide and 45 ft. high, the lintel is composed of three stones forming vousoirs the keystone measuring 7 ft. at the bottom, 8 ft. at the top, 10 ft. high and 7 ft. 6 in. deep.

All the doorways mentioned above have cornices, and in those at Palmyra and Baalbec richly carved friezes with side corbels. In the Pantheon there is a plain convex frieze, but the outer mouldings of the architrave and the bed-mould of the cornice are richly carved. In the Byzantine doorways at Sta Sophia, Constantinople, a bold convex moulding and a hollow take the place of the fasciæ of the classic architrave.

So far we have only referred to square-headed doorways, but the side openings of the triumphal arches of Titus and Constantine are virtually doorways, and they have semicircular heads, the mouldings of which are the same as those of the square-headed examples. In Saxon doorways, which had semicircular heads, the outer mouldings projected more boldly than in classic examples, and were sometimes cut in a separate ring of stone like the hood mould of later date.

During the Romanesque period in all countries, the doorway becomes the chief characteristic feature, and consists of two or more orders, the term "order" in this case being applied to the concentric rings of vousoirs forming the door-head. In classic work the faces of these concentric rings were nearly always flush one with the other; in Romanesque work the upper one projected over the ring immediately below, and the employment of a different design in the carving of each ring produced a magnificent and imposing effect: in the Italian churches the decoration of the arch mould is frequently carried down the door jambs, and the same is found, but less often, in the English and French doorways; but as a rule each ring or order is carried by a nook shaft, those in England and France being plain, but in Italy and Sicily elaborately carved with spirals or other ornaments and sometimes inlaid with mosaic.

The deeply recessed Norman doorways in English work required a great thickness of wall, and this was sometimes obtained by an addition outside, as at Ifley, Adel, Kirkstall and other churches.

In France, during the Gothic period, the several orders were carved with figure sculpture, as also the door jambs; and the great recessing of these doorways brought them more into the categories of porches. In England much less importance was given to the Gothic doorways, and although they consisted of many orders, these were emphasized only by deep hollows and converse mouldings and always carried on angle or nook shafts. In the perpendicular period the pointed-arch doorway was often enclosed within a square head-moulding, the spandrel being enriched with foliage or quatrefoil tracery.

In the Mahomedan style the doorway itself is comparatively simple, except that the vousoirs of its lintel are joggled with a series of curves, and being of different coloured stones have a decorative effect. These doorways are placed in a rectangular recess roofed with the stalactite vault.

With the Renaissance architect, the doorway continued as the principal characteristic of the style; the actual door-frame was simply moulded, by enclosing it with pilasters or columns, isolated or semi-detached, raised on pedestals and carrying an entablature with pediment and other kind of super-doorway; and great importance was given to the feature. In the Italian cinquecento period, the panels of the side pilasters were enriched with the most elaborate carving, and this would seem to have

been an ancient Roman method, to judge by portions of carved panels now in the museums of Rome. The doorways of Venice are remarkable in this respect. At Comò the two side doorways of the cathedral, one of which is said to be by Bramante, are of great beauty, and the same rich decoration is found throughout Spain and France. In Germany and England the pattern book too often suggested designs of an extremely rococo character, and it was under the influence of Palladio, through Inigo Jones, that in England the architect returned to the simpler and purer Italian style. (R. P. S.)

DOPPLERITE, a naturally occurring organic substance found in amorphous, elastic or jelly-like masses, of brownish-black colour, in peat beds in Styria and in Switzerland. It is tasteless, insoluble in alcohol and ether, and is described by Dana as an acid substance, or mixture of different acids, related to humic acid.

DORAN, JOHN (1807-1878), English author, was born in London of Irish parentage on the 11th of March 1807. He became tutor in several distinguished families, and while travelling on the continent contributed journalistic sketches to *The Literary Chronicle*, a paper which was afterwards incorporated with *The Athenæum*. His play, *Justice or the Venetian Jew*, was produced at the Surrey theatre in 1824, and in 1830 he began to write translations from French, German, Latin and Italian authors for *The Bath Journal*. After some years of travel on the continent he became in 1841 literary editor of *The Church and State Gazette*, and in 1852 under the title of *Filía dolorosa* produced a memoir of Maria Thérèse Charlotte, duchesse d'Angoulême. Two years later he became a regular contributor to *The Athenæum*, succeeding Hepworth Dixon as editor for a short time in 1869, until he became editor of *Notes and Queries* in 1870. His most elaborate work, *The Majesties' Servants*, a history of the English stage from Betterton to Kean, was published in 1860, and was supplemented by *In and About Drury Lane*, which was written for *Temple Bar* and was not published in book form till 1885, after Doran's death. Among his other works may be mentioned *Table Traits and Habits of Men* (1854), *The Queens of the House of Hanover* (1855), *Knights and their Days* (1856), *Monarchs retired from Business* (1856), *The History of Court Fools* (1858), an edition of the *Bentley Ballads* (1858), *The Last Journals of Horace Walpole* (2 vols., 1859), *The Princess of Wales* (1860), and the *Memoirs of Queen Adelaide* (1861). These were followed by *A Lady of the Last Century* (1873), an account of Mrs Elizabeth Montagu and the blue-stockings; *London in Jacobite Times* (1877); and *Memoirs of our Great Towns* (1878). Doran died in London, on the 25th of January 1878.

DORAT, CLAUDE JOSEPH (1734-1780), French man of letters, was born in Paris on the 31st of December 1734. He belonged to a family whose members had for generations been lawyers, and he entered the corps of the king's musketeers. He obtained a great vogue by his *Réponse d'Abailard à Héloïse*, and followed up this first success with a number of heroic epistles, *Les Victimes de l'amour*, *ou lettres de quelques amants célèbres* (1776). Dorat was possessed by an ambition quite out of proportion to his very mediocre ability. Besides light verse he wrote comedies, fables and, among other novels, *Les Sacrifices de l'amour*, *ou lettres de la vicomtesse de Senanges et du chevalier de Versenay* (1771). He tried to cover his failures as a dramatist by buying up a great number of seats, and his books were lavishly illustrated by good artists and expensively produced, to secure their success. He was maladroit enough to draw down on himself the hatred both of the *philosophe* party and of their arch-enemy Charles Palissot, and thus cut himself off from the possibility of academic honour. *Le Tartufe illustré* (1777) attacked La Harpe and Palissot, and at the same time D'Alembert and Mlle de Lespinasse. Dorat died on the 29th of April 1780 in Paris.

See G. Desnoiretères, *Le Chevalier Dorat et les poètes légers au XVIII^e siècle* (1887). For the bibliographical value of his works, see Henry Cohen, *Guide de l'amateur de livres à figures et à vignettes du XVIII^e siècle* (éditions de Ch. Mehl, 1876, and R. Portalis, 1887).

DORCHESTER, DUDLEY CARLETON, VISCOUNT (1573-1632), English diplomatist, son of Antony Carleton of Baldwin

Brightwell, Oxfordshire, and of Jocos, daughter of John Goodwin of Winchington, Buckinghamshire, was born on the 10th of March 1573, and educated at Westminster school and Christ Church, Oxford, where he graduated M.A. in 1600. He travelled abroad, and was returned to the parliament of 1604 as member for St Mawes. Through his connexion as secretary with the earl of Northumberland his name was associated with the Gunpowder Plot, but after a short confinement he succeeded in clearing himself of any share in the conspiracy. In 1610 he was knighted and was sent as ambassador to Venice, where he was the means of concluding the treaty of Asti. He returned in 1615, and next year was appointed ambassador to Holland. The policy of England on the continent depended mainly upon its relations with that state, and Carleton succeeded in improving these, in spite of his firm attitude on the subject of the massacre of Amboyna, the bitter commercial disputes between the two countries, and the fatal tendency of James I. to seek alliance with Spain. It was in his house at the Hague that the unfortunate Elector Frederick and the princess Elizabeth took refuge in 1621. Carleton returned to England in 1625 with the duke of Buckingham, and was made vice-chamberlain of the household and a privy councillor. Shortly afterwards he took part in an abortive mission to France in favour of the French Protestants and to inspire a league against the house of Austria. On his return in 1626 he found the attention of parliament, to which he had been elected for Hastings, completely occupied with the attack upon Buckingham. Carleton endeavoured to defend his patron, and supported the king's violent exercise of his prerogative. It was perhaps fortunate that his further career in the Commons was cut short by his elevation in May to the peerage as Baron Carleton of Imbercourt. Shortly afterwards he was despatched on another mission to the Hague, on his return from which he was created Viscount Dorchester in July 1628. He was active in forwarding the conferences between Buckingham and Contarini for a peace with France on the eve of the duke's intended departure for La Rochelle, which was prevented by the latter's assassination. In December 1628 he was made principal secretary of state, and died on the 15th of February 1632, being buried in Westminster Abbey. He was twice married, and had children, but all died in infancy, and the title became extinct. Carleton was one of the ablest diplomatists of the time, and his talents would have secured greater triumphs had he not been persistently hampered by the mistaken and hesitating foreign policy of the court.

His voluminous correspondence, remarkable for its clear, easy and effective style, and for the writer's grasp of the main points of policy, covers practically the whole history of foreign affairs during the period 1610-1628, and furnishes valuable material for the study of the Thirty Years' War. His letters as ambassador at the Hague, January 1616 to December 1620, were first edited by Philip Yorke, afterwards second earl of Hardwicke, with a biographical and historical preface, in 1757; his correspondence from the Hague in 1627 by Sir Thomas Phillipps in 1841; other letters are printed in the *Cabala*, and in T. Birch's *Court and Times of James I. and Charles I.*, but by far the greater portion remains in MS. among the state papers.

DORCHESTER, GUY CARLETON, 1st BARON (1724-1808), British general and administrator, was born at Strabane, Co. Tyrone, Ireland, on the 3rd of September 1724. He served with distinction on the continent under the duke of Cumberland, and in 1759 in America as quartermaster-general, under his friend Wolfe. He was wounded at the capture of Quebec, and promoted to the rank of brigadier-general. In 1766 he was appointed governor-general of Canada, which position he held till 1778. His justice and kindness greatly endeared him to the recently conquered French-Canadians, and did much to hold them neutral during the War of American Independence. He ordered the first codification of the civil law of the province, and was largely responsible for the passing of the Quebec Act. On the American invasion of Canada in 1775 he was compelled to abandon Montreal and narrowly escaped capture, but defended Quebec (q.v.) with skill and success. In October of the same year he destroyed the American flotilla on Lake Champlain. In 1777 he was superseded in his command of the military forces by Major-General John Burgoyne, and asked to be recalled. He returned, however, to

America in May 1782 as commander-in-chief, remaining till November 1783. In 1786 he was again sent to Canada as governor-general and commander of the forces, with the title of Baron Dorchester. Many important reforms marked his rule; he administered the country with tact and moderation, and kept it loyal to the British crown amid the ferment caused by the French Revolution, and by the attempts of American emissaries to arouse discontent. In 1791 the province was divided into Upper and Lower Canada by the Constitutional Act. Of this division Carleton disapproved, as he did also of a provision tending to create in the new colony an hereditary aristocracy. In 1796 he insisted on retiring, and returned to England. He died on the 10th of November 1808. He married in 1772 a daughter of the 2nd earl of Effingham, and had nine children, being succeeded in the title by his grandson Arthur. On the death in 1897 of the 4th baron (another grandson) the title became extinct, but was revived in 1899 for his cousin and co-heiress Henrietta Anne as Baroness Dorchester.

J. C. Dent's *Canadian Portrait Gallery* (Toronto, 1880) gives a sketch of Lord Dorchester's Canadian career. His life by A. G. Bradley is included in the *Makers of Canada series* (Toronto). Most of his letters and state papers, which are indispensable for a knowledge of the period, are in the archives department at Ottawa, and are calendared in Brymer's *Reports on Canadian Archives* (Ottawa, 1885, seq.). (W. L. G.)

DORCHESTER, a market town and municipal borough and the county town of Dorsetshire, England, in the southern parliamentary division, 135 m. S.W. by W. from London by the London & South Western railway; served also by the Great Western railway. Pop. (1901) 9458. It stands on an eminence on the right bank of the river Frome, within a wide open tract of land, containing 3400 acres, held under the duchy of Cornwall, called Fordington Field. Several of the streets are planted with trees, and the town is nearly surrounded by fine avenues. St Peter's church is a Perpendicular building with a fine tower. All Saints and Holy Trinity churches are modern, but Fordington church retains Norman and Transitional details. Of public buildings the principal are—the town-hall, with market-house, shire-hall, county prison and county hospital; there is also a county museum, containing many local objects of much interest. The grammar school (founded in 1569) is endowed with exhibitions to Oxford and Cambridge. There is a statue to William Barnes the Dorsetshire poet (1801-1886). The town is noted also for its ale. It is a place of considerable agricultural trade, and large sheep and lamb fairs are held annually. The borough is under a mayor, six aldermen and eighteen councillors. Area 1648 acres.

History.—*Durnovaria* was here, a Romano-British country town of considerable size, probably successor to a British tribal centre of the Durotriges. The walls can be traced in part, and many mosaics, remains of houses, &c., have been found. The remains of an amphitheatre are seen at Maumbury Rings, near the town. Maiden Castle, 2 m. S.W. of the town, is a vast earthwork considered to have been a stronghold of the tribe of the Durotriges. There are other such remains in the vicinity. Little mention of Dorchester (*Dornceaster, Dorcestre*) occurs in Saxon annals, but a charter from Æthelstan to Milton Abbey in 939 is dated at *villa regalis quae dicitur Dorcestria*, and at this period it possessed a mint. According to the Domesday Survey it was a royal borough, and at the time of Edward the Confessor contained 172 houses, of which 100 had been totally destroyed since the Conquest. Mention is made of a castle at Dorchester in records of the 12th and 13th centuries; and the Franciscan priory, founded some time before 1331, is thought to have been constructed out of its ruins. The latter was suppressed among the lesser monasteries in 1536. Edward II. granted the borough to the bailiffs and burgesses at a fee-farm rent of £20 for five years, and the grant was renewed in perpetuity by Edward III. Richard III. empowered the burgesses to elect a coroner and two constables, to be exempt from tolls, and to try minor pleas in the king's court within the borough before a steward to be chosen by themselves. The first charter of incorporation, granted by James I. in 1610, established a governing council of two bailiffs and

fifteen capital burgesses. Charles I. in 1639 instituted a mayor, six aldermen and six capital burgesses, and also incorporated all the freemen of the borough, for the purposes of trade, under the government of a council consisting of a governor, assistants and twenty-four freemen, the governor and four assistants to be chosen out of the twenty-four by the freemen, and five other assistants to be chosen by the mayor out of the capital burgesses; the Council was empowered to hold four courts yearly and to make laws for the regulation of the markets and trade. Dorchester returned two members to parliament from 1295, until the Representation of the People Act of 1868 reduced the number to one; by the Redistribution Act of 1885 the representation was merged in the county. Edward III. granted to the burgesses the perquisites from three fairs lasting one day at the feasts of Holy Trinity, St John Baptist and St James, and markets on Wednesday, Friday and Saturday. Elizabeth granted an additional three days' fair at Candlemas. The days of the fairs and markets have remained unchanged. The cloth industry which flourished during the 16th century never recovered from the depression following on the Civil War. The malting and brewing industries came into prominence in the 17th century, when there was also a considerable serge manufacture, which has since declined.

See *Victoria County History, Dorsetshire*; John Hutchins, *The History and Antiquities of the Town and Borough of Dorchester* (3rd edition, corrected, augmented and improved by W. Shipp and J. W. Hodson, Blandford, 1865).

DORCHESTER, a large village in the south parliamentary division of Oxfordshire, England, 9 m. S.S.E. of Oxford by road, on the river Thame, 1 m. from its junction with the Thames. This is a site of much historical interest. There was a Roman station near the present village, facing, across the Thames, the double isolated mound known as Wittenham Hills (historically *Sinodun*), on one summit of which are strong early earthworks. In Dorchester itself the chief point of interest is the abbey church of St Peter and St Paul. This consists of a nave of great length, primarily of the transitional Norman period; a choir with arcades of the finest Decorated work; north choir aisle of the close of the 13th century, south choir aisle (c. 1300) and south nave aisle (c. 1320). The tower (western) is an erection of the late 17th century. The eastern bay of the choir is considered to have been added as a Lady chapel, and the north window is a magnificent example of a "Jesse window," in which the tracery represents the genealogical tree of Jesse, the complete execution of the design being carried on in the glass. The sedilia and piscina are very fine. The Decorated windows on the south side of the church form a beautiful series, and there are monuments and brasses of great interest.

Dorchester (*Dorcina*, *Dornacestre*, *Dorchecestre*) was conquered by the West Saxons about 560. It occupied a commanding position at the junction of the Thames and the Thame, and in 635 was made the seat of a bishopric which at its foundation was the largest in England, comprising the whole of Wessex and Mercia. The witenagemot of Wessex was held at Dorchester three times in the 9th century, and in 958 Æthelstan held a council here. In the 11th century, however, the town is described as small and ill-peopled and remarkable only for the majesty of its churches, and in about 1086 William I. and Bishop Remigius removed the bishop's stool to Lincoln, as a city more worthy of the distinction. According to the Domesday Survey Dorchester was held by the bishop of Lincoln; it was assessed at 100 hides and comprised two mills. In 1140 Alexander bishop of Lincoln founded an abbey of Black Canons at Dorchester, but the town declined in importance after the removal of the cathedral, and is described by 16th-century writers as a mere agricultural village and destitute of trade.

See *Victoria County History, Oxfordshire*; Henry Addington, *Some Account of the Abbey Church of St Peter and St Paul at Dorchester, Oxfordshire*, reissue with additional notes (Oxford, 1860).

DORCHESTER, a residential and manufacturing district of Boston, Massachusetts, U.S.A., a separate town until 1870, between the Neponset river on the S. and South Boston and Boston proper on the N. It is served by three lines of the New

York, New Haven & Hartford railway. A ridge, with an average height of about 100 ft. above the sea, extends through the district from N. to S. and commands delightful views of Boston Bay to the E. and of the Blue Hills to the S. There are many large private estates, with beautiful lawns, and Franklin Field and Franklin Park, one of the largest parks of the Boston park system, are in Dorchester. The Shawmut school for girls is in the district. Among the landmarks are the Barnard Capen house, built in the fourth decade of the 17th century and now probably the second oldest house in New England; and the James Blake house (1648), now the home of the Dorchester Historical Society, which has a library and a museum. Opposite the Blake house formerly stood the house in which Edward Everett was born. Not far away is the old Dorchester burying ground, which dates from 1634; it has many curious epitaphs, and contains the graves of Barnard Capen, who died in 1638 (probably the oldest marked grave in the United States); of William Stoughton (1631-1701), chief justice of the court which tried the Salem "witches" in 1692, Lieutenant-governor of the colony from 1692, acting governor in 1694-1699 and 1700-1701, and founder of the original Stoughton Hall, Harvard; and of Richard Mather, pastor of the First Parish church here from 1636 until his death. In Dorchester Maria Susanna Cummins (1827-1866) wrote *The Lamplighter* (1854), one of the most popular novels of its time, and William T. Adams ("Oliver Optic") and Charles Follen Adams ("Yawcob Strauss") did much of their writing; it was long the home of Mrs Lucy Stone (Blackwell). Among the manufactures are cocoa, chocolate, &c. (of the long-established Walter Baker & Co.), paper, crushing and grinding machinery (Sturtevant Mill Co.), chemicals, horseshoe nails, valves, organs and pianos, lumber, automobiles and shoe machinery.

Dorchester was founded by about 140 colonists from Dorsetshire, England, with whom the movement for planting the colony in Massachusetts Bay was begun under the leadership of Rev. John White. They organized as a church while at Plymouth, England, in March 1630, then embarked in the ship "Mary and John," arrived in Boston Bay two weeks before Governor Winthrop with the rest of the fleet, and in June selected Savin Hill (E. of what is now Dorchester Avenue and between Crescent Avenue and Dorchester Bay) as the site for their settlement. At the time the place was known as Mattapanock, but they named it Dorchester. Town affairs were at first managed by the church, but in October 1633 a town government was organized, and the example was followed by the neighbouring settlements; this seems to have been the beginning of the town-meeting form of government in America. Up to this time Dorchester was the largest town in the colony, but dissatisfaction arose with the location (Boston had a better one chiefly on account of the deeper water in its harbour), and in 1635-1637 many of the original settlers removed to the valley of the Connecticut where they planted Windsor. New settlers, however, arrived at Dorchester and in 1639 that town established a school supported by a public tax; this was the first free school in America supported by direct taxation or assessment on the inhabitants of a town.¹ In October 1695, a few of the inhabitants of Dorchester organized a church and in December removed to South Carolina where they planted another Dorchester (on the N. bank of the Ashley river, about 26 m. from Charleston); by 1752 they had become dissatisfied with their location, which was unhealthy, and they gradually removed to Georgia, where they settled at Medway

¹ In 1635 the general court of the colony of Massachusetts Bay had granted to Dorchester Thompson's Island, situated near the coast of the township. By the township of Dorchester this island was apportioned among the freemen of the township. On the 20th of May 1639 it was ordered that the proprietors of land in this island should collectively pay a "rent of twenty pounds a year forever," this rent "to be paid to such a school-master as shall undertake to teach English, Latin, and other tongues, and also writing," it being "left to the discretion of the elders and the seven men for the time being whether maids shall be taught with the boys or not." In 1642 the proprietors of the island conveyed it to the township "for and toward the maintenance of a free school in Dorchester aforesaid for the instructing and teaching of children and youth in good literature and learning."

(half way between the Ogeechee and Altamaha rivers), their settlement soon developing into St John's Parish (see *GEORGIA: History*). It was the fortification of Dorchester Heights, under orders from General Washington, on the night of the 4th and 5th of March 1776, that forced the British to evacuate Boston. At one time Dorchester extended from Boston nearly to the Rhode Island line; but its territory was gradually reduced by the creation of new townships and additions to old ones. Dorchester Neck was annexed to Boston in 1804, Thompson's Island in 1834, and the remaining portions in 1855 and 1870.

See W. D. Orcutt, *Good Old Dorchester* (Cambridge, 1893).

DORDOGNE, a river of central and south-western France, rising at a height of 5640 ft. on the Puy-de-Sancy, a mountain of the department of Puy-de-Dôme, and flowing to the Garonne with which it unites at Bec d'Ambès to form the Gironde estuary. It has a length of 295 m. and the area of its basin is 9214 sq. m. Descending rapidly from its source, sometimes over cascades, the river soon enters deep gorges through which it flows as far as Beaulieu (department of Corrèze) where it debouches into a wide and fertile valley and is shortly after joined by the Cère. Entering the department of Lot, it abandons a south-westerly for a westerly course and flowing in a sinuous channel traverses the department of Dordogne, where it receives the waters of the Vézère. Below the town of Bergerac it enters the department of Gironde, where at Libourne it is joined by the Isle and widens out, attaining at its union with the Garonne 45 m. from the sea a width of nearly 3300 yds. A few miles above this point the river is spanned by the magnificent bridges of Cubzac-les-Ponts, which carry a road and railway. Below its confluence with the Vézère, over the last 112 m. of its course, the river carries considerable navigation. The influence of the highest tides is felt at Pessac, a distance of 100 m. from the ocean.

DORDOGNE, an inland department of south-western France, formed in 1790 from nearly the whole of Périgord, a part of Agenais, and small portions of Limousin and of Angoumois. Area 3560 sq. m. Pop. (1906) 447,052. It is bounded N. by Haute-Vienne, W. by Charente, Charente-Inférieure and Gironde, S. by Lot-et-Garonne, and E. by Lot and Corrèze. Situated on the western slopes of the Massif Central, Dordogne consists in the north-east and centre of sterile plateaus sloping towards the west, where they end in a region of pine forests known as the Double. The greatest altitudes are found in the highlands of the north, where many points exceed 1300 ft. in height. The department is intersected by many fertile and beautiful river valleys, which converge from its northern and eastern borders towards the south-west. The Dordogne is the principal river of the department and its chief affluent is the Isle, which crosses the centre of the department and flows into the Dordogne at Libourne, in the neighbouring department of Gironde. The Dronne and the Auvézère, both tributaries of the Isle, are the other main rivers. The climate is generally agreeable and healthy, but rather humid, especially in the north-east. Agriculture flourishes in the south and south-west of the department, especially in the valleys of the Dordogne and Isle, the rest of its surface being covered to a great extent by woods and heath. Pasture and forage amply suffice for the raising of large flocks and herds. The vine, cultivated mainly in the neighbourhood of Bergerac, and tobacco are important sources of profit. Wheat and maize are the chief cereals and potatoes are largely grown. The truffles of Périgord are famous for their abundance and quality. The plum and cider-apple yield good crops. In the forests the prevailing trees are the oak and chestnut. The fruit of the latter is much used both as food by the people and for fattening hogs, which are reared in large numbers. The walnut is extensively grown for its oil. The department has mines of lignite, and produces freestone, lime, cement, mill-stone, peat, potter's clay and fireclay. The leather industry and the preparation of preserved foods are important, and there are flour-mills, brick and tile works, earthenware manufactories, printing works, chemical works and a few iron foundries. Exports consist of truffles, wine, chestnuts and other fruit, live stock, poultry, and minerals of various kinds. Dordogne is served by the Orléans railway, the Dordogne, the Isle and the

Vézère furnish nearly 300 m. of navigable waterway. It is divided into the arrondissements of Périgueux, Bergerac, Nontron, Ribérac and Sarlat, with 47 cantons and 587 communes, and belongs to the ecclesiastical province of Bordeaux, to the académie (educational division) of Bordeaux and to the region of the XII. army corps, which has its headquarters at Limoges. Its court of appeal is at Bordeaux.

Périgueux, the capital, Bergerac, Sarlat and Brantôme are the principal towns (see separate articles). There are several other places of interest. Bourdeilles has two finely preserved châteaux, one of the 14th century, with an imposing keep, the other in the Renaissance style of the 16th century. Both buildings are contained within the same fortified enceinte. The celebrated château of Biron, founded in the 11th century, preserves examples of many subsequent architectural styles, among them a beautiful chapel of late Gothic and early Renaissance workmanship. The château of Jumilhac-le-Grand belongs to the 15th century. Dordogne possesses several medieval *bastides*, the most perfect of which is Monpazier. At Cadouin there are the remains of a Cistercian abbey. Its church is a fine cruciform building in the Romanesque style, while the cloister is an excellent example of Flamboyant architecture. St Jean-de-Côle has an interesting Romanesque church and a château of the 15th, 16th and 18th centuries. In the rocks of the valley of the lower Vézère there are prehistoric caves of great archaeological importance, in which have been found tools, and carvings on bone, flint and ivory. Troglodytic dwellings are to be found in many other places in Dordogne (see *CAVE*).

DORDRECHT (abbreviated *Dordt*, or *Dort*), a town and riverport of Holland, in the province of South Holland, on the south side of the Merwede, and a junction station 12½ m. by rail S.E. of Rotterdam. Steam ferries connect it with Papendrecht and Zwynrecht on the opposite shore, and it has excellent communication by water in every direction. Pop. (1900) 38,386. Dordrecht presents a picturesque appearance with its busy quays and numerous canals and windmills, its quaint streets and curiously gabled houses. The Groote Kerk, of Our Lady, whose massive tower forms a conspicuous object in the views of the town, dates from the 14th century and contains some finely carved stalls (1340) by Jan Terween Aertsz, a remarkable pulpit (1759), many old monuments and a set of gold communion plate. In the town museum is an interesting collection of paintings, chiefly by modern artists, but including also pictures by some of the older masters, among whom Ferdinand Bol, the two Cuyp, Nicolas Maes, Godfried Schalcken, and in later times Ary Scheffer, were all natives of Dordrecht. The celebrated 17th-century statesman John de Witt was also a native of the town. Close to the museum is one of the old city gates, rebuilt in 1618, and now containing a collection of antiquities belonging to the Oud-Dordrecht Society. The South African Museum (1902) contains memorials of the Boer War of 1899-1902. The harbour of Dordrecht still has a large trade, but much has been diverted to Rotterdam. Large quantities of wood are imported from Germany, Scandinavia and America. There are numerous saw-mills, shipbuilding yards, engineering works, distilleries, sugar refineries, tobacco factories, linen bleacheries and stained glass, salt and white lead works.

Dordrecht was founded by Count Dirk III. of Holland in 1018, becoming a town about 1200. One of the first towns in the Netherlands to embrace the reformed religion and to throw off the yoke of Spain, it was in 1572 the meeting-place of the deputies who asserted the independence of the United Provinces. In 1618 and 1619 it was the seat of the synod of Dort (*q.v.*).

DORÉ, LOUIS AUGUSTE GUSTAVE (1832-1883), French artist, the son of a civil engineer, was born at Strassburg on the 6th of January 1832. In 1848 he came to Paris and secured a three years' engagement on the *Journal pour rire*. His facility as a draughtsman was extraordinary, and among the books he illustrated in rapid succession were Balzac's *Contes drolatiques* (1855), Dante's *Inferno* (1861), *Don Quixote* (1863), *The Bible* (1866), *Paradise Lost* (1866), and the works of Rabelais (1873). He painted also many large and ambitious compositions of a

religious or historical character, and made some success as a sculptor, his statue of Alexandre Dumas in Paris being perhaps his best-known work in this line. He died on the 25th of January 1883.

DORIA, ANDREA (1466-1560), Genoese *condottiere* and admiral, was born at Oneglia of an ancient Genoese family. Being left an orphan at an early age, he became a soldier of fortune, and served first in the papal guard and then under various Italian princes. In 1503 we find him fighting in Corsica in the service of Genoa, at that time under French vassalage, and he took part in the rising of Genoa against the French, whom he compelled to evacuate the city. From that time forth it was as a naval captain that he became famous. For several years he scoured the Mediterranean in command of the Genoese fleet, waging war on the Turks and the Barbary pirates. In the meanwhile Genoa had been recaptured by the French, and in 1522 by the Imperialists. But Doria now veered round to the French or popular faction and entered the service of King Francis I., who made him captain-general; in 1524 he relieved Marseilles, which was besieged by the Imperialists, and helped to place his native city once more under French domination. But he was dissatisfied with his treatment at the hands of Francis, who was mean about payment, and he resented the king's behaviour in connexion with Savona, which he delayed to hand back to the Genoese as he had promised; consequently on the expiry of Doria's contract we find him in the service of the emperor Charles V. (1528). He ordered his nephew Filippino, who was then blockading Naples in concert with a French army, to withdraw, and sailed for Genoa, where, with the help of some leading citizens, he expelled the French once more and re-established the republic under imperial protection. He reformed the constitution in an aristocratic sense, most of the nobility being Imperialists, and put an end to the factions which divided the city. He refused the lordship of Genoa and even the dogeship, but accepted the position of perpetual censor, and exercised predominant influence in the councils of the republic until his death. He was given two palaces, many privileges, and the title of *Liberator et Pater Patriae*. As imperial admiral he commanded several expeditions against the Turks, capturing Corona and Patras, and co-operating with the emperor himself in the capture of Tunis (1535). Charles found him an invaluable ally in the wars with Francis, and through him extended his domination over the whole of Italy. Doria's defeat by the Turks at Preveza in 1538 was said to be not involuntary, and designed to spite the Venetians whom he detested. He accompanied Charles on the ill-fated Algerian expedition of 1541, of which he disapproved, and by his ability just saved the whole force from complete disaster. For the next five years he continued to serve the emperor in various wars, in which he was generally successful and always active, although now over seventy years old; there was hardly an important event in Europe in which he had not some share. After the peace of Crépy between Francis and Charles in 1544 he hoped to end his days in quiet. But his great wealth and power, as well as the arrogance of his nephew and heir Giannettino Doria, made him many enemies, and in 1547 the Fiesco conspiracy to upset the power of his house took place. Giannettino was murdered, but the conspirators were defeated, and Andrea showed great vindictiveness in punishing them. Many of their feifs he seized for himself, and he was implicated in the murder of Pier Luigi Farnese, duke of Parma (see FARNESE), who had helped Fiesco. Other conspiracies followed, of which the most important was that of Giulio Cibò (1548), but all failed. Although Doria was ambitious and harsh, he was a good patriot and successfully opposed the emperor Charles's repeated attempts to have a citadel built in Genoa and garrisoned by Spaniards; neither blandishments nor threats could win him over to the scheme. Nor did age lessen his energy, for in 1550, when eighty-four years old, he again put to sea to punish the raids of his old enemies the Barbary pirates, but with no great success. War between France and the Empire having broken out once more, the French seized Corsica, then administered by the Genoese Bank of St George; Doria was again summoned, and he spent two years (1553-1555) in the island

fighting the French with varying fortune. He returned to Genoa for good in 1555, and being very old and infirm he gave over the command of the galleys to his great-nephew Giovanni Andrea Doria, who conducted an expedition against Tripoli, but proved even more unsuccessful than his uncle had been at Algiers, barely escaping with his life. Andrea Doria died on the 25th of November 1560, leaving his estates to Giovanni Andrea. The family of Doria-Pamphilli-Landi (*q.v.*) is descended from him and bears his title of prince of Meli. Doria was a man of indomitable energy and a great admiral. If he appears unscrupulous and even treacherous he did but conform to the standards of 16th-century Italy.

BIBLIOGRAPHY.—E. Petit's *André Doria* (Paris, 1887) is an accurate and documented biography, indicating all the chief works on the subject, but the author is perhaps unduly harsh in his judgment of the admiral; F. D. Guerrazzi's *Vita di Andrea Doria* (3rd ed., Milan, 1874); among the earlier works L. Cappelloni's *Vita di Andrea Doria* (Italian edition, Genoa, 1863) and V. Sigonius's *Vita Andreae Doriae* (1576) may be mentioned; see also "Documenti ispano-genovesi dell'Archivio di Simanca" in the *Atti della Società ligure di Storia patria*, vol. viii.; the *Archivio storico italiano* (serie iii. tome iv. parte i., 1866) contains a bibliography, but a great deal has been published since that date. (L. V.*)

DORIANS, a name applied by the Greeks to one of the principal groups of Hellenic peoples, in contradistinction to Ionians and Aeolians. In Hellenic times a small district known as Doris in north Greece, between Mount Parnassus and Mount Oeta, counted as "Dorian" in a special sense. Practically all Peloponnese, except Achaea and Elis, was "Dorian," together with Megara, Aegina, Crete, Melos, Thera, the Sporades Islands and the S.W. coast of Asia Minor, where Rhodes, Cos, Cnidus and (formerly) Halicarnassus formed a "Dorian" confederacy. "Dorian" colonies, from Corinth, Megara, and the Dorian islands, occupied the southern coasts of Sicily from Syracuse to Selinus. Dorian states usually had in common the "Doric" dialect, a peculiar calendar and cycle of festivals of which the Hyacinthia and Carneia were the chief, and certain political and social institutions, such as the threefold "Dorian tribes." The worship of Apollo and Heracles, though not confined to Dorians, were widely regarded as in some sense "Dorian" in character.

But those common characters are not to be pressed too far. The northern Doris, for example, spoke Aeolic, while Elis, Phocis, and many non-Dorian districts of north-west Greece spoke dialects akin to Doric. Many Dorian states had additional "non-Dorian tribes"; Sparta, which claimed to be of pure and typical Dorian origin, maintained institutions and a mode of life which were without parallel in Peloponnese, in the Parthian and in the Asiatic Doris, and were partially reflected in Crete only.

Most non-Dorian Greeks, in fact, seem to have accepted much as Dorian which was in fact only Spartan: this was particularly the case in the political, ethical and aesthetic controversies of the 5th and 4th centuries B.C. Much, however, which was common (in art, for example) to Olympia, Argolis and Aegina, and might thus have been regarded as Dorian, was conspicuously absent from the culture of Sparta.

Traditional History.—In the diagrammatic family tree of the Greek people, as it appears in the Hesiodic catalogue (6th century) and in Hellanicus (5th century), the "sons of Hellen" are Dorus, Xuthus (father of Ion and Achaeus) and Aeolus. Dorus' share of the inheritance of Hellen lay in central Greece, north of the Corinthian Gulf, between Xuthus in north Peloponnese and Aeolus in Thessaly. His descendants, either under Dorus or under a later king Aegimius, occupied Histiaeotis, a district of northern Thessaly, and afterwards conquered from the Dryopes the head-waters of the Boeotian Cephissus between Mount Parnassus and Mount Oeta. This became "Doris" *par excellence*. Services rendered to Aegimius by Heracles led (1) to the adoption of Hyllus, son of Heracles, by Aegimius, side by side with his own sons Dymas and Pamphylus, and to a threefold grouping of the Dorian clans, as Hylleis, Dymanes and Pamphyli; (2) to the association of the people of Aegimius in the repeated attempts of Hyllus and his family to recover their lost inheritance in

Peloponnese (see HERACLIDÆ). The last of these attempts resulted in the "Dorian conquest" of the "Achæans" and "Ionians" of Peloponnese, and in the assignment of Argolis, Laconia and Messenia to the Heraclid leaders, Temenus, Aristodemus and Cresphontes respectively; of Elis to their Aetolian allies; and of the north coast to the remnants of the conquered Achæans. The conquest of Corinth and Megara was placed a generation later: Arcadia alone claimed to have escaped invasion. This conquest was dated relatively by Thucydides (i. 12) at eighty years after the Trojan War and twenty years after the conquest of Thessaly and Boeotia by the similar "invaders from Arne"; absolutely by Hellanicus and his school (5th century) at 1149 B.C.; by Isocrates and Ephorus (4th century B.C.) at about 1070 B.C.; and by Sosibius, Eratosthenes (3rd century), and later writers generally, at the generations from 1125 to 1100 B.C.

The invasion was commonly believed to have proceeded by way of Aetolia and Elis, and the name Naupactus was interpreted as an allusion to the needful "shipbuilding" on the Corinthian Gulf. One legend made Dorus himself originally an Aetolian prince; the participation of Orylus, and the Aetolian claim to Elis, appear first in Ephorus (4th century). The conquest of Laconia at least is represented in 5th-century tradition as immediate and complete, though one legend admits the previous death of the Heraclid leader Aristodemus, and another describes a protracted struggle in the case of Corinth. Pausanias, however (following Sosibius), interprets a long series of conflicts in Arcadia as stages in a gradual advance southward, ending with the conquest of Amyclæ by King Telemachus (c. 800 B.C.) and of Helos by King Alcamenæ (c. 770 B.C.).

Of the invasion of Argolis a quite different version was already current in the 4th century. This represents the Argive Dorians as having come by sea (apparently from the Maliac Gulf, the nearest seashore to Parthian Doris), accompanied by survivors of the Dryopes (former inhabitants of that Doris), whose traces in south Euboea (Styra and Caryatus), in Cythnus, and at Eion (Haliæis), Hermione and Asine in Argolis, were held to indicate their probable route.

The Homeric Dorians of Crete were also interpreted by Andron and others (3rd century) as an advance-guard of this sea-borne migration, and as having separated from the other Dorians while still in Histiaeotis. The 5th-century tradition that the Heraclid kings of Macedonia were Temenid exiles from Argos may belong to the same cycle.

The fate of the Dorian invaders was represented as differing locally. In Messenia (according to a legend dramatized by Euripides in the 5th century, and renovated for political ends in the 4th century) the descendants of Cresphontes quarrelled among themselves and were exterminated by the natives. In Laconia Aristodemus (or his twin sons) effected a rigid military occupation which eventually embraced the whole district, and permitted (a) the colonization of Melos, Thera and parts of Crete (before 800 B.C.), (b) the reconquest and annexation of Messenia (about 750 B.C.), (c) a settlement of half-breed Spartans at Tarentum in south Italy, 700 B.C. In Argos and other cities of Argolis the descendants of the Achæan chiefs were taken into political partnership, but a tradition of race-feud lasted till historic times. Corinth, Sicyon and Megara, with similar political compromises, mark the limits of Dorian conquest; a Dorian invasion of Attica (c. 1066 B.C.) was checked by the self-sacrifice of King Codrus: "Either Athens must perish or her king." Aegina was reckoned a colony of Epidaurus. Rhodes, and some Cretan towns, traced descent from Argos; Cnidus from Argos and Sparta; the rest of Asiatic Doris from Epidaurus or Troezen in Argolis. The colonies of Corinth, Sicyon and Megara, and the Sicilian offshoots of the Asiatic Dorians, belong to historic times (8th-6th centuries).

Criticism of the Traditional History.—The following are the problems:—(1) Was there a Dorian invasion as described in the legends; and, if not, how did the tradition arise? (2) Who were the Dorian invaders, and in what relation did they stand to the rest of the population of Greece? (3) How far do the Dorian

states, or their characteristics, represent the descendants, or the culture, of the original invaders?

The Homeric poems (12th-10th centuries) know of Dorians only in Crete, with the obscure epithet *ἰωνοειδῆς*, and no hint of their origin. All those parts of Peloponnese and the islands which in historic times were "Dorian" are ruled by recently established dynasties of "Achæan" chiefs; the home of the Asiatic Dorians is simply "Caria"; and the geographical "catalogue" in *Iliad* ii. ignores the northern Doris altogether.

The almost total absence from Homer not only of "Dorians" but of "Ionians" and even of "Hellenes" leads to the conclusion that the diagrammatic genealogy of the "sons of Hellen" is of post-Homeric date; and that it originated as an attempt to classify the Doric, Ionic and Aeolic groups of Hellenic settlements on the west coast of Asia Minor, for here alone do the three names correspond to territorial, linguistic and political divisions. The addition of an "Achæan" group, and the inclusion of this and the Ionic group under a single generic name, would naturally follow the recognition of the real kinship of the "Achæan" colonies of Magna Græcia with those of Ionia. But the attempt to interpret, in terms of this Asiatic diagram, the actual distribution of dialects and peoples in European Greece, led to difficulties. Here, in the 8th-6th centuries, all the Dorian states were in the hands of exclusive aristocracies, which presented a marked contrast to the subject populations. Since the kinship of the latter with the members of adjacent non-Dorian states was admitted, two different explanations seem to have been made, (1) on behalf of the non-Dorian populations, either that the Dorians were no true sons of Hellen, but were of some other northerly ancestry; or that they were merely Achæan exiles; and in either case that their historic predominance resulted from an act of violence, ill-disguised by their association with the ancient claims of the Peloponnesian Heraclidæ; (2) on behalf of the Dorian aristocracies, that they were in some special sense "sons of Hellen," if not the only genuine Hellenes; the rest of the European Greeks, and in particular the anti-Dorian Athenians (with their marked likeness to Ionians), being regarded as Hellenized barbarians of "Pelagian" origin (see PELAGIANS). This process of Hellenization, or at least its final stage, was further regarded as intimately connected with a movement of peoples which had brought the "Dorians" from the northern highlands into those parts of Greece which they occupied in historic times.

So long as the Homeric poems were believed to represent Hellenic (and mainly Ionian) beliefs of the 9th century or later, the historical value of the traditions of a Dorian invasion was repeatedly questioned; most recently and thoroughly by J. Beloch (*Gr. Geschichte*, I., Strassburg, 1893), as being simply an attempt to reconcile the political geography of Homer (i.e. of 8th-century Ionians describing 12th-century events) with that of historic Greece, by explaining discrepancies (due to Homeric ignorance) as the result of "migrations" in the interval. Such legends often arise to connect towns bearing identical or similar names (such as are common in Greece) and to justify political events or ambitions by legendary precedents; and this certainly happened during the successive political rivalries of Dorian Sparta with non-Dorian Athens and Thebes. But in proportion as an earlier date has become more probable for Homer, the hypothesis of Ionic origin has become less tenable, and the belief better founded (1) that the poems represent accurately a well-defined phase of culture in prehistoric Greece, and (2) that this "Homeric" or "Achæan" phase was closed by some such general catastrophe as is presumed by the legends.

The legend of a Dorian invasion appears first in Tyrtaeus, a 7th-century poet, in the service of Sparta, who brings the Spartan Heraclidæ to Peloponnese from Erineon in the northern Doris; and the lost Epic of Aegimius, of about the same date, seems to have presupposed the same story. In the 5th century Pindar ascribes to Aegimius the institutions of the Peloponnesian Dorians, and describes them as the "Dorian folk of Hyllus and Aegimius," and as "originating from Pindus" (*Pyth.* v. 75: cf. Fr. 4). Herodotus, also in the 5th century, describes them as the

typical (perhaps in contrast to Athenians as the *only* genuine) Hellenes, and traces their numerous wanderings from (1) an original home "in Deucalion's time" in Phthiotis (the Homeric "Hellas") in south Thessaly, to (2) Histiaeotis "below Ossa and Olympus" in north-east Thessaly (note that the *historic* Histiaeotis is "below *Pindus*" in north-west Thessaly): this was "in the days of Dorus," i.e. it is at this stage that the Dorians are regarded as becoming specifically distinct from the generic "Hellene": thence (3) to a residence "in Pindus," where they passed as a "Macedonian people." Hence (4) they moved south to the Parnassian Doris, which had been held by Dryopes: and hence finally (5) to Peloponnese. Elsewhere he assigns the expulsion of the Dryopes to Heracles in co-operation not with Dorians but with Malians. Here clearly two traditions are combined:—one, in which the Dorians originated from Hellas in south Thessaly, and so are "children of Hellen"; another, in which they were a "Macedonian people" intruded from the north, from Pindus, past Histiaeotis to Doris and beyond. It is a noteworthy coincidence that in Macedonia also the royal family claimed Heracleid descent; and that "Pindus" is the name both of the mountains above Histiaeotis and of a stream in Doris. It is noteworthy also that later writers (e.g. Andron in Strabo 475) derived the Cretan Dorians of Homer from those of Histiaeotis, and that other legends connected Cretan peoples and places with certain districts of Macedonia.

Thucydides agrees in regarding the Parnassian Doris as the "mother-state" of the Dorians (I. 107) and dates the invasion (as above) eighty years after the Trojan War; this agrees approximately with the pedigree of the kings of Sparta, as given by Herodotus, and with that of Hecataeus of Miletus (considered as evidence for the foundation date of an Ionian refugee-colony). Thucydides also accepts the story of Heracleid leadership.

The legend of an organized apportionment of Peloponnese amongst the Heracleid leaders appears first in the 5th-century tragedians,—not earlier, that is, than the rise of the Peloponnesian League,—and was amplified in the 4th century; the Aetolians' aid, and claim to Elis, appear first in Ephorus. The numerous details and variant legends preserved by later writers, particularly Strabo and Pausanias, may go back to early sources (e.g. Herodotus distinguished the "local" from the "poetic" versions of events in early Spartan history); but much seems to be referable to Ephorus and the 4th-century political and rhetorical historians:—e.g. the enlarged version of the Heracleid claims in Isocrates (*Archidamus*, 120) and the theory that the Dorians were mere disowned Achaeans (Plato, *Lysis*, 3). Moreover, many independent considerations suggest that in its main outlines the Dorian invasion is historical.

The Doric Dialects.—These dialects have strongly marked features in common (future in *-σω -σιω -σῶ*; 1st pers. plur. in *-μεσ*; *αἱ* for *ἄν*; *-αε -αν = ἦ*), but differ more among themselves than do the Ionic. Laconia with its colonies (including those in south Italy) form a clear group, in which *-ε* and *-ο* lengthen to *-η* and *-ω* as in Aeolic. Corinth (with its Sicilian colonies), the Argolid towns, and the Asiatic Doris, form another group, in which *-ε* and *-ο* become *-αι* and *-ου* as in Ionic. Connected with the latter (e.g. by *-αι* and *-ου*) are the "northern" group:—Phocia, including Delphi, with Aetolia, Acarnania, Epirus and Phthiotis in south Thessaly. But these have also some forms in common with the "Aeolic" dialect of Boeotia and Thessaly, which in historic times was spoken also in Doris; Locris and Elis present similar northern "Achaean-Doric" dialects. Arcadia, on the other hand, in the heart of Peloponnese, retained till a late date a quite different dialect, akin to the ancient dialect of Cyprus, and more remotely to Aeolic. This distribution makes it clear (1) that the Doric dialects of Peloponnese represent a superstratum, more recent than the speech of Arcadia; (2) that Laconia and its colonies preserve features alike, *-η* and *-ω* which are common to southern Doric and Aeolic; (3) that those parts of "Dorian" Greece in which tradition makes the pre-Dorian population "Ionic," and in which the political structure shows that the conquered were less completely subjugated, exhibit the Ionic *-αι* and *-ου*; (4) that as

we go north, similar though more barbaric dialects extend far up the western side of central-northern Greece, and survive also locally in the highlands of south Thessaly; (5) that east of the watershed Aeolic has prevailed over the area which has legends of a Boeotian and Thessalian migration, and replaces Doric in the northern Doris. All this points on the one hand to an intrusion of Doric dialect into an Arcadian and Ionic-speaking area; on the other hand to a subsequent expansion of Aeolic over the north-eastern edge of an area which once was Dorian. But this distribution does not by itself prove that Doric speech was the language of the Dorian invaders. Its area coincides also approximately with that of the previous Achaean conquests; and if the Dorians were as backward culturally as traditions and archaeology suggest, it is not improbable that they soon adopted the language of the conquered, as the Norman conquerors did in England. As evidence of an intrusion of northerly folk, however, the distribution of dialects remains important. See GREEK LANGUAGE.

The common calendar and cycle of festivals, observed by all Dorians (of which the Carneia was chief), and the distribution in Greece of the worship of Apollo and Heracles, which attained pre-eminence mainly in or near districts historically "Dorian," suggest that these cults, or an important element in them, were introduced comparatively late, and represent the beliefs of a fresh ethnic superstratum. The steady dependence of Sparta on the Delphic oracle, for example, is best explained as an observance inherited from Parnassian ancestors.

The social and political structure of the Dorian states of Peloponnese presupposes likewise a conquest of an older highly civilized population by small bands of comparatively barbarous raiders. Sparta in particular remained, even after the reforms of Lycurgus, and on into historic times, simply the isolated camp of a compact army of occupation, of some 5000 families, bearing traces still of the fusion of several bands of invaders, and maintained as an exclusive political aristocracy of professional soldiers by the labour of a whole population of agricultural and industrial serfs. The serfs were rigidly debarred from intermixture or social advancement, and were watched by their masters with a suspicion fully justified by recurrent ineffectual revolts. The other states, such as Argos and Corinth, exhibited just such compromises between conquerors and conquered as the legends described, conceding to the older population, or to sections of it, political incorporation more or less incomplete. The Cretan cities, irrespective of origin, exhibit serfage, militant aristocracy, rigid martial discipline of all citizens, and other marked analogies with Sparta; but the Asiatic Dorians and the other Dorian colonies do not differ appreciably in their social and political history from their Ionian and Aeolic neighbours. Tarentum alone, partly from Spartan origin, partly through stress of local conditions, shows traces of militant asceticism for a while.

Archaeological evidence points clearly now to the conclusion that the splendid but overgrown civilization of the Mycenaean or "late Minoan" period of the Aegean Bronze Age collapsed rather suddenly before a rapid succession of assaults by comparatively barbarous invaders from the European mainland north of the Aegean; that these invaders passed partly by way of Thrace and the Hellespont into Asia Minor, partly by Macedonia and Thessaly into peninsular Greece and the Aegean islands; that in east Peloponnese and Crete, at all events, a first shock (somewhat later than 1500 B.C.) led to the establishment of a cultural, social and political situation which in many respects resembles what is depicted in Homer as the "Achaean" age, with principal centres in Rhodes, Crete, Laconia, Argolis, Attica, Orchomenus and south-east Thessaly; and that this régime was itself shattered by a second shock or series of shocks somewhat earlier than 1000 B.C. These latter events correspond in character and date with the traditional irruption of the Dorians and their associates.

The nationality of these invaders is disputed. Survival of fair hair and complexion and light eyes among the upper classes in Thebes and some other localities shows that the blonde type of mankind which is characteristic of north-western Europe had already penetrated into Greek lands before classical times; but

the ascription of the same physical traits to the Achæans of Homer forbids us to regard them as peculiar to that latest wave of pre-classical immigrants to which the Dorians belong; and there is no satisfactory evidence as to the coloration of the Spartans, who alone were reputed to be pure-blooded Dorians in historic times.

Language is no better guide, for it is not clear that the Dorian dialect is that of the most recent conquerors, and not rather that of the conquered Achæan inhabitants of southern Greece; in any case it presents no such affinities with any non-Hellenic speech as would serve to trace its origin. Even in northern and west-central Greece, all vestige of any former prevalence has been obliterated by the spread of "Aeolic" dialects akin to those of Thessaly and Boeotia; even the northern Doris, for example, spoke "Aeolic" in historic times.

The doubt already suggested as to language applies still more to such characteristics as Dorian music and other forms of art, and to Dorian customs generally. It is clear from the traditions about Lycurgus (*q.v.*), for example, that even the Spartans had been a long while in Laconia before their state was rescued from disorder by his reforms; and if there be truth in the legend that the new institutions were borrowed from Crete, we perhaps have here too a late echo of the legislative fame of the land of Minos. Certainly the Spartans adopted, together with the political traditions of the Heracleids, many old Laconian cults and observances such as those connected with the Tyndaridae.

BIBLIOGRAPHY.—K. O. Müller, *Die Dorer* (ed. F. W. Schneidewin, Breslau, 1844); G. Gilbert, *Studien zur altspartanischen Geschichte* (Göttingen, 1872); H. Gelsez, "Die Wanderzüge der lakédonischen Dorer," in *Rhein. Museum*, xxiii. (1877), p. 259; G. Busolt, *Die Lakédonier und ihre Bundesgenossen*, I. (Leipzig, 1878); S. Beloch, "Die dorische Wanderung," in *Rhein. Mus.* xiv. (1890), 555 ff.; H. Collitz, *Sammlung der gr. Dialekt-Inschriften*, iii. (Göttingen, 1899-1905); R. Meister, "Dorer und Achæer," in *Abh. d. K. Sächs. Ges. Wiss.* (Phil.-hist. Kl.), xxiv. 3 (Leipzig, 1904).

(J. L. M.)

DORIA-PAMPHILII-LANDI, a princely Roman family of Genoese extraction. The founder of the house was Ansaldo d'Oría, consul of Genoa in the 12th century, but the authentic pedigree is traced no further back than to Paolo d'Oría (1335). The most famous member of the family was Andrea Doria (*q.v.*), perpetual censor of Genoa in 1528 and admiral to the emperor Charles V., who was created prince of Melù (1531) and marquis of Tursi (in the kingdom of Naples) in 1555. The marquisate of Civiez and the county of Cavallamonte were conferred on the family in 1576, the duchy of Tursi in 1594, the principality of Avella in 1607, the duchy of Avigliano in 1613. In 1760 the title of *Reichsfürst* or prince of the Holy Roman Empire was added and attached to the lordship of Torriglia and the marquisate of Borgo San Stefano, together with the qualification of *Hochgeboren*. That same year the Dorias inherited the fiefs and titles of the house of Pamphilii-Landi of Gubbio, patricians of Rome and princes of San Martino, Valmontano, Val di Toro, Bardi and Corupiano. The Doria-Pamphilii palace in Rome, a splendid edifice, was built in the 17th century, and contains a valuable collection of paintings. The Villa Doria-Pamphilii with its gardens is one of the loveliest round Rome. During the siege of 1849 it was Garibaldi's headquarters.

DORION, SIR ANTOINE AIMÉ¹ (1816-1891), Canadian lawyer and statesman, son of Pierre Dorion and Geneviève Bureau, was born in the parish of Sainte Anne de la Pérade on the 17th of January 1816. He was educated at Nicolet College, and in his twenty-second year went to Montreal to read law with M. Cherrier, an eminent lawyer for whom he retained a lasting friendship. On the 6th of January 1842 he was admitted to the bar of the province, became the partner of M. Cherrier, and in the course of a few years attained the highest rank in his profession. He married in 1848 Iphigénie, daughter of Dr Jean Baptiste Trestler, of Vaudreuil. Dorion descended from an old Liberal family which from early days had supported the reform party in Canada. His father, a merchant of Sainte Anne, was a member of the legislative assembly for the county of Champlain, from

¹ In the baptismal certificate the name is entered as "Emé" (= Edmé-Aimé).

1830 to 1838, and his grandfather, on the maternal side, represented the county of Saint Maurice in the same body from 1819 to 1830. At the time that Dorion commenced the study of law, Canada was entering upon a new phase of her political life. The rebellion of 1837 had resulted in the suspension of the constitution of 1791, and the union of the provinces, effected under the Imperial Act of 1840, was framed to compel the obedience of the refractory population. It was an unsatisfactory measure, providing a single legislature for two provinces, with an equal number of representatives from each province, irrespective of population. At the time the lower province was the larger, but it was foreseen that a tide of English emigration would eventually place the upper province in the stronger position. Indeed, at the date of the Union, there were many English residents in the lower province, so that in the aggregate the English had then the majority. From the first it was apparent that representation by population would become an issue, and for several years there was a constant struggle for the establishment of responsible government, which was only achieved after the contest of 1848, when the La Fontaine-Baldwin administration was maintained in power. The difficulty had been avoided during the first years of the Union by La Fontaine, who succeeded in uniting English and French Liberals, and by substituting principles for race carried out a policy based upon a broader conception of human interests. Although a decisive victory had been gained by La Fontaine and Baldwin in 1848, they did not press for an immediate overthrow of institutions which for years had been a cause of contention, and their influence gradually diminished until, on the 28th of October 1851, the administration was handed over to Hincks and Morin. Liberal principles had now become aggressive; the new leaders did not keep abreast of the spirit of the times, their majority decreased, and, on the 11th of September 1854, a government was formed by McNab and Morin.

The elections of 1854 had brought new blood into the ranks of the Liberal party, young men eager to carry out measures of reform, and Dorion was chosen as leader. Under the coalition brought about by McNab between the Tories of Upper Canada and the Liberals of the lower province old abuses were removed, and, after the abolition of seigniorial tenure and clergy reserves, it appeared that the political atmosphere was clear. In 1856 the question of representation by population was again prominent. Upper Canada had increased, and it contributed a larger share to the revenue, and demanded proportionate representation. La Fontaine had pointed out, at the time he was prime minister, that representation by population would subject the weaker province to the control of the stronger, and that as he would not impose the principle upon Upper Canada at the time he would not concede it, without constitutional restraint, if her position were reversed. Upper Canada now became aggressive and the question had to be settled. Macdonald, who became prime minister in 1856, and had formed a new government with Cartier in 1857, maintained that no amendment to the constitution was necessary; that existing conditions were satisfactory. Brown, on the opposite side of the House, declared that representation by population was imperative, with or without constitutional changes; and Dorion appears to have suggested the true remedy, when he gave notice of a motion in 1856:—

"That a committee be appointed to inquire into the means that should be adopted to form a new political and legislative organization of the heretofore provinces of Upper and Lower Canada, either by the establishment of their former territorial divisions or by a division of each province, so as to form a federation, having a federal government and a local legislature for each one of the new provinces, and to deliberate as to the course which should be adopted to regulate the affairs of united Canada, in a manner which would be equitable to the different sections of the province."

Dorion was in advance of the time. He understood the true principle of federative union as applicable to Canada. But he did not pursue this idea, and in fact his following was never sufficiently strong to enable him to give effect to the sound measures he was so capable of formulating. This, perhaps, was his special weakness. On the 2nd of August 1858 he formed an administration with Brown, but was forced to resign after being in office three days.

When the question of confederation was discussed a few years later he opposed the scheme, believing there was nothing to justify the union at the time, although he admitted "that commercial intercourse may increase sufficiently to render confederation desirable." In 1873 he accepted the portfolio of minister of justice in the Mackenzie government, and during the six months that he was in office passed the Electoral Law of 1874 and the Controverted Elections Act. Dorion sat as member of the assembly for the province of Canada for the city of Montreal from 1854 to 1861, for the county of Hochelaga from 1862 to 1867; as member of the House of Commons for the county of Hochelaga from 1867 to July 1872, and for the county of Napierville from September 1872 to June 1874, when he was appointed chief justice of the province. In 1878 he was created a knight bachelor. He died at Montreal on the 31st of May 1891. No more able or upright judge ever adorned the Canadian bench. He had a broad, clear mind, vast knowledge, and commanded respect from the loftiness of his character and the strength of his abilities. The keynote of his life was an unswerving devotion to duty.

See *Dorion, a Sketch*, by Fenninge Taylor (Montreal, 1865); and "Sir Antoine Amié Dorion," by Sir Wilfrid Laurier, in *The Week* (1887). (A. C. D.)

DORIS, in ancient geography, a small district in central Greece, forming a wedge between Mts. Oeta and Parnassus, and containing the head-waters of the Cephissus, which passes at the gorge of Dadion into the neighbouring land of Phocis. This little valley, which nowhere exceeds 4 m. in breadth and could barely give sustenance to four small townships, owed its importance partly to its command over the strategic road from Heraclia to Amphissa, which pierced the Parnassus range near Cytinium, but chiefly to its prestige as the alleged mother-country of the Dorian conquerors of Peloponnesus (see DORIANS). Its history is mainly made up of petty wars with the neighbouring Oetaeans and Phocians. The latter pressed them hard in 457, when the Spartans, admitting their claim to be the Dorian metropolis, sent an army to their aid, and again during the second Sacred War (356-346). Except for a casual mention of its cantonal league in 196, Doris passed early out of history; the inhabitants may have been exterminated during the conflicts between Aetolia and Macedonia.

See Strabo, pp. 417, 427; Herodotus i. 56, viii. 31; Thucydides i. 107, iii. 92; Diodorus xii. 29, 33; W. M. Leake, *Travels in Northern Greece*, chap. xi. (London, 1835). (M. O. B. C.)

DORISLAUS, ISAAC (1595-1649), Anglo-Dutch lawyer and diplomatist, was born in 1595 at Alkmaar, Holland, the son of a minister of the Dutch reformed church. He was educated at Leiden, removed to England about 1627, and was appointed to a lectureship in history at Cambridge, where his attempt to justify the Dutch revolt against Spain led to his early resignation. In 1629 he was admitted a commoner of the College of Advocates. In 1632 he made his peace at court, and on two occasions acted as judge advocate, in the bishops' war of 1640 and in 1642 in the army commanded by Essex. In 1648 he became one of the judges of the admiralty court, and was sent on a diplomatic errand to the states general of Holland. He assisted in preparing the charge of high treason against Charles I., and, while negotiating an alliance between the Commonwealth and the Dutch Republic, was murdered at the Hague by royalist refugees on the 10th of May 1649. His remains were buried in Westminster Abbey, and moved in 1661 to St Margaret's churchyard.

DORKING, a market town in the Reigate parliamentary division of Surrey, England, 26 m. S.S.W. of London, on the London, Brighton & South Coast and the South-Eastern & Chatham railways. Pop. of urban district (1901) 7670. It is pleasantly situated on the river Mole, in a sheltered vale near the base of Box Hill. It is the centre of an extensive residential district. The parish church of St Martin's is a handsome edifice rebuilt in 1873. Lime of exceptionally good quality is burnt to a large extent in the neighbourhood, and forms an important article of trade; it is derived from the Lower Chalk formation. Dorking has long been famous for a finely favoured breed of fowl distinguished by its having five toes. Several fine mansions are in the vicinity of the town, notably that of Deepdene, contain-

ing part of a gallery of sculpture collected here by Thomas Hope, the author of *Anastasis*. A Roman road, which crossed from the Sussex coast to the Thames, passed near the present churchyard of St Martin.

DORLÉANS, LOUIS (1542-1629), French poet and political pamphleteer, was born in 1542, in Paris. He studied under Jean Daurat, and after taking his degree in law began to practise at the bar with but slight success. He wrote indifferent verses, but was a redoubtable pamphleteer. After the League had arrested the royalist members of parliament, he was appointed (1580) *avocat-général*. His "*Avertissement des catholiques anglais aux Français catholiques du danger où ils sont de perdre la religion et d'expérimenter, comme en Angleterre, la cruauté des ministres s'ils reçoivent à la couronne un roi qui soit hérétique*" went through several editions, and was translated into English. One of his pamphlets, *Le Banquet ou après-dînée du comte d'Ardele*, in which he accused Henry of insincerity in his return to the Roman Catholic faith, was so scurrilous as to be disapproved of by many members of the League. When Henry at length entered Paris, Dorléans was among the number of the proscribed. He took refuge in Antwerp, where he remained for nine years. At the expiration of that period he received a pardon, and returned to Paris, but was soon imprisoned for sedition. The king, however, released him after three months in the Conciergerie, and by this means attached him permanently to his cause. His last years were passed in obscurity, and he died in 1629.

DORMER (from Lat. *dormire*, to sleep), in architecture, a window rising out of the roof and lighting the room in it: sometimes, however, pierced in a small gable built flush with the wall below, or corbelled out, as frequently in Scotland. In Germany, where the roofs are very lofty, there are three or four rows of dormers, one above the other, but it does not follow that the space in the roof is necessarily subdivided by floors. In some of the French châteaux the dormers (*Fr. lucarne*) are highly elaborated, and in some cases, as in Chambord, they form the principal architectural features. In these cases they are either placed flush with the wall or recede behind a parapet and gutter only, so as to rest on the solid wall, as they are built in stone. In Germany they assume larger proportions and constitute small gables with two or three storeys of windows. The term "dormer" arose from the windows being those of sleeping-rooms. In the phrase "dormer beam" or "dormant beam," meaning a tie-beam, we have the same sense as in the modern "sleeper."

DORMITORY (Lat. *dormitorium*, a sleeping place), the name given in monasteries to the monks' sleeping apartment. Sometimes it formed one long room, but was more generally subdivided into as many cells or partitions as there were monks. It was generally placed on the first floor with a direct entrance into the church. The dormitories were sometimes of great length; the longest known, in the monastery of S. Michele in Bosco near Bologna (now suppressed), is said to have been over 400 ft. In some of the larger mansions of the Elizabethan period the space in the roof constitutes a long gallery, which in those days was occasionally utilized as a dormitory. The name "dormitory" is also applied to the large bedrooms with a number of beds, in schools and similar modern institutes.

DORMOUSE (a word usually taken to be connected with Lat. *dormire*, to sleep, with "mouse" added, cf. Germ. *Schäferatte*; it is not a corruption of *Fr. dormeuse*; Skeat suggests a connexion with Icel. *dör*, denumbed, cf. Eng. "doze"), the name of a small British rodent mammal having the general appearance of a squirrel. This rodent, *Muscardinus axellanus*, is the sole representative of its genus, but belongs to a family—the *Gliridae*, or *Myoxidae*—containing a small number of Old World species. All the dormice are small rodents (although many of them are double the size of the British species), of arboreal habits, and for the most part of squirrel-like appearance; some of their most distinctive features being internal. In the more typical members of the group, forming the sub-family *Glirinae*, there are four pairs of cheek-teeth, which are rooted and have transverse enamel-folds. As the characters of the genera are given in the article *RODENTIA* it will suffice to state that the typical genus *Glis* is represented by

the large European edible dormouse, *G. vulgaris* (or *G. glis*), a grey species with black markings known in Germany as *Siebenschläfer*; the genus ranges from continental Europe to Japan. The common dormouse *Muscardinus ocellarius*, ranging from England to Russia and Asia, is of the size of a mouse and mainly chestnut-coloured. The third genus is represented by the continental *levis*, or garden-dormouse, *Eliomys gervinus*, which is a large parti-coloured species, with several local forms—either species or races. Lastly, *Graphiurus*, of which the species are also large, is solely African. In their arboreal life, and the habit of sitting up on their hind-legs with their food grasped in the fore-paws, dormice are like squirrels, from which they differ in being completely nocturnal. They live either among bushes or in trees, and make a neat nest for the reception of their young, which are born blind. The species inhabiting cold climates construct a winter nest in which they hibernate, waking up at times to feed on an accumulated store of nuts and other food. Before retiring they become very fat, and at such times the edible dormouse is a favourite article of diet on the Continent. At the beginning of the cold season the common dormouse retires to its nest, and curling itself up in a ball, becomes dormant. A warmer day than usual restores it to temporary activity, and then it supplies itself with food from its autumn hoard, again becoming torpid till roused by the advent of spring. The young are generally four in number, and are produced twice a year. They are born blind, but in a marvellously short period are able to cater for themselves; and their hibernation begins later in the season than with the adults. The fur of the dormouse is tawny above and paler beneath, with a white patch on the throat. A second subfamily is represented by the Indian *Platacanthemys* and the Chinese *Typhlomys*, in which there are only three pairs of cheek-teeth; thus connecting the more typical members of the family with the *Muridae*. (R. L. *)

DORNBIERN, a township in the Austrian province of the Vorarlberg, on the right bank of the Dornbirner Ach, at the point where it flows out of the hilly region of the Bregenzerwald into the broad valley of the Rhine, on its way to the Lake of Constance. It is by rail 7½ m. S. of Bregenz, and 15 m. N. of Feldkirch. It is the most populous town in the Vorarlberg, its population in 1900 being 13,052. The name Dornbirn is a collective appellation for four villages—Dornbirn, Hatlerdorf, Oberdorf and Haselstauden—which straggle over a distance of about 3 m. It is the chief industrial centre in the Vorarlberg, the regulated Dornbirner Ach furnishing motive power for several factories for cotton spinning and weaving, worked muslin, dyeing, iron-founding and so on. (W. A. B. C.)

DORNBURG, a town of Germany, in the grand-duchy of Saxe-Weimar, romantically situated on a hill 400 ft. above the Saale, on the railway Grossheringen-Jena and 7 m. N.E. of the latter. Pop. 700. Dornburg is an ancient town, but is chiefly famous for its three grand-ducal castles. Of these, the Altes Schloss is built on the site of an imperial stronghold (Kaiserpfalz), once a bulwark against the Slavs, often a residence of the emperors Otto II. and Otto III., and where the emperor Henry II. held a diet in 1005; the Neues Schloss in Italian style of architecture, built 1728-1748, with pretty gardens. Here Goethe was often a guest, "healing the blows of fate and the wounds of the heart in Dornburg." The third and southernmost of the three is the so-called Stohmannsches Rittergut, purchased in 1824 and fitted as a modern palace.

DORNER, ISAAC AUGUST (1809-1884), German Lutheran divine, was born at Neuhausen-ob-Eck in Württemberg on the 20th of June 1809. His father was pastor at Neuhausen. He was educated at Maulbronn and the university of Tübingen. After acting for two years as assistant to his father in his native place he travelled in England and Holland to complete his studies and acquaint himself with different types of Protestantism. He returned to Tübingen in 1834, and in 1837 was made professor extraordinarius of theology. As a student at the university, one of his teachers had been Christian Friedrich Schmid (1794-1852), author of a well-known book, *Biblische Theologie des Neuen Testaments*, and one of the most vigorous opponents of F. C. Baur. At Schmid's suggestion, and with his encouragement,

Dorner set to work upon a history of the development of the doctrine of the person of Christ, *Entwicklungsgeschichte der Lehre von der Person Christi*. He published the first part of it in 1835, the year in which Strauss, his colleague, gave to the public his *Life of Jesus*; completed it in 1839, and afterwards considerably enlarged it for a second edition (1845-1856). It was an indirect reply to Strauss, which showed "profound learning, objectivity of judgment, and fine appreciation of the moving ideas of history" (Otto Pfeiderer). The author at once took high rank as a theologian and historian, and in 1839 was invited to Kiel as professor ordinarius. It was here that he produced, amongst other works, *Das Princip unserer Kirche nach dem innern Verhältnis seiner zwei Seiten betrachtet* (1841). In 1843 he removed as professor of theology to Königsberg. Thence he was called to Bonn in 1847, and to Göttingen in 1853. Finally in 1862 he settled in the same capacity at Berlin, where he was a member of the supreme consistorial council. A few years later (1867) he published his valuable *Geschichte der protestantischen Theologie* (Eng. trans., *History of Protestant Theology*, 2 vols., 1871), in which he "developed and elaborated," as Pfeiderer says, "his own convictions by his diligent and loving study of the history of the Church's thought and belief." The theological positions to which he ultimately attained are best seen in his *Christliche Glaubenslehre*, published shortly before his death (1879-1881). It is "a work extremely rich in thought and matter. It takes the reader through a mass of historical material by the examination and discussion of ancient and modern teachers, and so leads up to the author's own view, which is mostly one intermediate between the opposite extremes, and appears as a more or less successful synthesis of antagonistic theses" (Pfeiderer). The companion work, *System der christlichen Sittenlehre*, was published by his son August Dorner in 1886. He also contributed articles to Herzog-Hauck's *Realencyclopädie*, and was the founder and for many years one of the editors of the *Jahrbücher für deutsche Theologie*. He died at Wiesbaden on the 8th of July 1884. One of the most noteworthy of the "mediating" theologians, he has been ranked with Friedrich Schleiermacher, J. A. W. Neander, Karl Nitzsch, Julius Müller and Richard Rothe.

His son, AUGUST (b. 1846), after studying at Berlin and acting as *Repetent* at Göttingen (1870-1873), became professor of theology and co-director of the theological seminary at Wittenberg. Amongst his works is *Augustinus, sein theologisches System und seine religionsphilosoph. Anschauung* (1873), and he is the author of the article on Isaac Dorner in the *Allgemeine deutsche Biographie*.

See Herzog-Hauck, *Realencyclopädie; Allgemeine deutsche Biographie* (1904); Otto Pfeiderer, *The Development of Theology in Germany since Kant* (1890); F. Lichtenberger, *History of German Theology in the Nineteenth Century* (1889); Carl Schwarz, *Zur Geschichte der neuesten Theologie* (1869). (M. A. C.)

DORNOCH, a royal and police burgh and county town of Sutherlandshire, Scotland. Pop. (1901) 624. It lies on the north shore of Dornoch Firth, an arm of the North Sea, 7½ m. S.E. of Mound station on the Highland railway by light railway. Its dry and bracing climate and fine golf course have brought it into great repute as a health and holiday resort. Before the Reformation it was the see of the bishopric of Caithness and Sutherland. The cathedral, built by Bishop Gilbert de Moravia (Moray) (d. 1245), the last Scot enrolled in the Calendar of Scottish saints, was damaged by fire in 1570, during the raid of the Master of Caithness and Mackay of Strathnaver, and afterwards neglected till 1837, when it was restored by the 2nd duke of Sutherland, and has since been used as the parish church. Noticeable for its high roof, low tower and dwarf spire, the church consists of an aisleless nave, chancel (adorned with Chantrey's statue of the 1st duke) and transepts. It is the burying-place of the Sutherland family and contains the remains of sixteen earls. Of the ancient castle, which was also the bishop's palace, only the west tower exists, the rest of the structure having been destroyed in the outrage of 1570. The county buildings adjoin it. Dornoch became a royal burgh in 1628, and, as one of the Wick burghs, returns a member to parliament. It was the scene of the last execution for witchcraft in Scotland (1722). At Embo, 2 m. N.N.E., a

sculptured stone commemorates the battle with the Danes in the 13th century, in which Richard de Moravia was killed. He was buried in the cathedral, where his effigy was found in the chancel. Skibo castle, about 4 m. W. of Dornoch, once a residence of the bishops of Caithness, was acquired in 1898 by Andrew Carnegie.

DORHOI, or **DOROGOI**, the capital of the department of Dorohoi, Rumania; on the right bank of the river Jijia, which broadens into a lake on the north. Pop. (1900) 12,701, more than half being Jews. The Russian frontier is about 30 m. E., the Austrian 20 m. W.; and there is railway communication with Botoshani and Jassy. Dorohoi is a market for the timber and farm produce of the north Moldavian highlands; merchants from the neighbouring states flock to its great fair, held on the 12th of June. There is a church built by Stephen the Great (1458-1504).

DOROTHEUS, a professor of jurisprudence in the law school of Berytus in Syria, and one of the three commissioners appointed by the emperor Justinian to draw up a book of Institutes, after the model of the *Institutes* of Gaius, which should serve as an introduction to the *Digest* already completed. His colleagues were Tribonian and Theophilus, and their work was accomplished in 529. Dorotheus was subsequently the author of a commentary on the *Digest*, which is called the *Index*, and was published by him in 542. Fragments of this commentary, which was in the Greek language, have been preserved in the *Scholias* appended to the body of law compiled by order of the emperor Basilus the Macedonian and his son Leo the Wise, in the 9th century, known as the *Basilica*, from which it seems probable that the commentary of Dorotheus contained the substance of a course of lectures on the *Digest* delivered by him in the law school of Berytus, although it is not cast in a form so precisely didactic as the *Index* of Theophilus.

DORSAY, **ALFRED GUILLAUME GABRIEL**, COUNT (1801-1852), the famous dandy and wit, was born in Paris on the 4th of September 1801, and was the son of General D'Orsay, from whom he inherited an exceptionally handsome person. Through his mother he was grandson by amorganatic marriage of the king of Württemberg. In his youth he entered the French army, and served as a *garde du corps* of Louis XVIII. In 1822, while stationed at Valence on the Rhone, he formed an acquaintance with the earl and countess of Blessington (q.v.) which quickly ripened into intimacy, and at the invitation of the earl he accompanied the party on their tour through Italy. In the spring of 1823 he met Lord Byron at Genoa, and the published correspondence of the poet at this period contains numerous references to the count's gifts and accomplishments, and to his peculiar relationship to the Blessington family. A diary which D'Orsay had kept during a visit to London in 1821-1822 was submitted to Byron's inspection, and was much praised by him for the knowledge of men and manners and the keen faculty of observation it displayed. On the 1st of December 1827 Count D'Orsay married Lady Harriet Gardiner, a girl of fifteen, the daughter of Lord Blessington by his previous wife. The union, if it rendered his connection with the Blessington family less ostensibly equivocal than before, was in other respects an unhappy one, and a separation took place almost immediately. After the death of Lord Blessington, which occurred in 1820, the widowed countess returned to England, accompanied by Count D'Orsay, and her home, first at Seamore Place, then at Gore House, soon became a resort of the fashionable literary and artistic society of London, which found an equal attraction in host and in hostess. The count's charming manner, brilliant wit, and artistic faculty were accompanied by benevolent moral qualities, which endeared him to all his associates. His skill as a painter and sculptor was shown in numerous portraits and statuettes representing his friends, which were marked by great vigour and truthfulness, if wanting in the finish that can only be reached by persistent discipline. Count D'Orsay had been from his youth a zealous Bonapartist, and one of the most frequent guests at Gore House was Prince Louis Napoleon. In 1840 he went bankrupt, and the establishment at Gore House being broken up, he went to Paris with Lady Blessington, who died a few weeks after their arrival.

He endeavoured to provide for himself by painting portraits. He was deep in the counsels of the prince president, but the relation between them was less cordial after the *coup d'état*, of which the count had by anticipation expressed his strong disapproval. His appointment to the post of director of fine arts was announced only a few days before his death, which occurred on the 4th of August 1852.

Much information as to the life and character of Count D'Orsay is to be found in Richard Madden's *Literary Life and Correspondence of the Countess of Blessington* (1855).

DORSET, EARLS, MARQUESSSES AND DUKES OF, English titles one or more of which have been borne by the families of Beaufort, Grey and Sackville. About 1070 Osmund, or Osmer, an alleged son of Henry, count of Sées, by a sister of William the Conqueror, is said to have been created earl of Dorset, but the authority is a very late one and Osmund describes himself simply as bishop (of Salisbury). William de Mohun of Dunster, a partisan of the empress Matilda, appears as earl of Dorset or Somerset, these two shires being in early times united under a single sheriff. In 1397 John Beaufort, earl of Somerset (d. 1410), the eldest son of John of Gaunt, duke of Lancaster, and Catherine Swinford, was created marquess of Dorset; two years later, however, he was reduced to his former rank of earl of Somerset. In 1411 his brother Thomas, afterwards duke of Exeter, was created earl of Dorset, and in 1441 his youngest son Edmund obtained the same dignity. Two years later Edmund was created marquess of Dorset and still later duke of Somerset. Edmund's son Henry, duke of Somerset and marquess of Dorset, was attainted during the Wars of the Roses, and was beheaded after the battle of Hexham in May 1464, when the titles became extinct. In 1475 Thomas Grey, 8th Lord Ferrers of Groby (1451-1501), a son of Sir John Grey (d. 1461) and a stepson of King Edward IV., having resigned the earldom of Huntington, which he had received in 1471, was created marquess of Dorset (see below). He was succeeded in this title by his son Thomas (1477-1530), and then by his grandson Henry (c. 1510-1554), who was created duke of Suffolk in 1551. When in February 1554 Suffolk was beheaded for sharing in the rising of Sir Thomas Wyatt, the marquessate of Dorset again became extinct; but in 1604 Thomas Sackville (see the account of the family under SACKVILLE, 1ST BARON) was created earl of Dorset (see below), and his descendant the 7th earl was created duke in 1720. In 1843 the titles became extinct.

THOMAS GREY, 1ST MARQUESS OF DORSET (1451-1501), was the elder son of Sir John Grey, 7th Lord Ferrers of Groby (1432-1461), by his wife Elizabeth Woodville, afterwards queen of Edward IV. He fought for Edward at Tewkesbury, and became Lord Harrington and Bonville by right of his wife Cecilia, daughter of William Bonville, 6th Lord Harrington (d. 1460); in 1475 he was created marquess of Dorset, and he was also a knight of the Garter and a privy councillor. After the death of Edward IV. Dorset and his brother Richard Grey were among the supporters of their half-brother, the young king Edward V.; thus they incurred the enmity of Richard duke of Gloucester, afterwards Richard III., and Richard Grey having been arrested, was beheaded at Pontefract in June 1483, while his elder brother, the marquess, saved his life by flight. Dorset was one of the leaders of the duke of Buckingham's insurrection, and when this failed he joined Henry earl of Richmond in Brittany, but he was left behind in Paris when the future king crossed over to England in 1485. After Henry's victory at Bosworth the marquess returned to England and his attainer was reversed, but he was suspected and imprisoned when Lambert Simnel revolted; he had, however, been released and pardoned, had marched into France and had helped to quell the Cornish rising, when he died on the 20th of September 1501.

Dorset's sixth son, Lord Leonard Grey (c. 1490-1541), went to Ireland as marshal of the English army in 1535, being created an Irish peer as Viscount Grane in the same year, but he never assumed this title. In 1536 Grey was appointed lord deputy of Ireland in succession to Sir William Skeffington; he was active in marching against the rebels and he presided over the important

parliament of 1536, but he was soon at variance with the powerful family of the Butlers and with some of the privy councillors.

He did not relax his energy in seeking to restore order, but he was accused, probably with truth, of favouring the family of the Geraldines, to whom he was related, and the quarrel with the Butlers became fiercer than ever. Returning to England in 1540 he was thrown into prison and was condemned to death for treason. He was beheaded on the 28th of July 1541 (see R. Bagwell, *Ireland under the Tudors*, vol. 1, 1885).

THOMAS GREY, 2ND MARQUESS OF DORSET (1477-1530), the eldest son of the 1st marquess, fled to Brittany with his father in 1484; after receiving several marks of the royal favour and succeeding to the title, he was imprisoned by Henry VII., and remained in prison until 1509. He was on very good terms with Henry VIII., who in 1512 appointed him to command the English army which was to invade France in conjunction with the Spanish forces under Ferdinand of Aragon. In spite of the failure which attended this enterprise, Dorset again served in France in the following year, and in 1516 he was made lieutenant of the order of the Garter. Later he was at the Field of the Cloth of Gold, and he was warden of the eastern and middle marches towards Scotland in 1523 and the following years. He received many other positions of trust and profit from the king, and he helped to bring about the fall of Cardinal Wolsey, under whom he had probably been educated. He was famous for his skill in the tournament. He died on the 10th of October 1530.

His eldest son Henry Grey, 3rd marquess of Dorset, was in 1551 created duke of Suffolk (q.v.). A younger son, Lord Thomas Grey, was beheaded in April 1554 for sharing in the rebellion of Sir Thomas Wyatt; another son, Lord John Grey, was also sentenced to death for his share in this rising, but his life was spared owing to the efforts of his wife Mary, daughter of Sir Anthony Browne. Under Elizabeth, Lord John, a strong Protestant, was restored to the royal favour, and he died on the 19th of November 1569. In 1603 his son Henry (d. 1614) was created Baron Grey of Groby, and in 1628 his great-grandson Henry was made earl of Stamford.

THOMAS SACKVILLE, 1ST EARL OF DORSET (c. 1530-1608), English statesman and poet, son of Sir Richard Sackville and his wife Winifred, daughter of Sir John Bruges or Bridges, lord mayor of London, was born at Buckhurst, in the parish of Withyham, Sussex. In his fifteenth or sixteenth year he is said to have been entered at Hart Hall, Oxford; but it was at Cambridge that he completed his studies and took the degree of M.A. He joined the Inner Temple, and was called to the bar. He married at the age of eighteen Cicely, daughter of Sir John Baker of Sissinghurst, Kent; in 1558 he entered parliament as member for Westmorland, in 1559 he sat for East Grinstead, Sussex, and in 1563 for Aylesbury in Buckinghamshire. A visit to the continent in 1565 was interrupted by an imprisonment at Rome, caused by a rash declaration of Protestant opinions. The news of his father's death on the 21st of April 1566 recalled him to England. On his return he was knighted in the queen's presence, receiving at the same time the title of baron of Buckhurst. With his mother he lived at the queen's palace of Sheen, where he entertained in 1568 Odet de Coligni, cardinal de Châtillon. In 1571 he was sent to France to congratulate Charles IX. on his marriage with Elizabeth of Austria, and he took part in the negotiations for the projected marriage of Elizabeth with the duke of Anjou. He became a member of the privy council, and acted as a commissioner at the state trials. In 1572 he was one of the peers who tried Thomas Howard, duke of Norfolk, and in 1586 he was selected to convey the sentence of death to Mary, queen of Scots, a task he is said to have performed with great consideration. He was sent in 1587 as ambassador to the Hague "to expostulate in favour of peace with a people who knew that their existence depended on war, to reconcile those to delay who felt that delay was death, and to heal animosities between men who were enemies from their cradles to their graves."¹ This task was further complicated by the parsimony and prevarication of

Elizabeth. Buckhurst carried out under protest the foolish and often contradictory orders he received. His plain speaking on the subject of Leicester's action in the Netherlands displeased the queen still more. She accused him on his return of having followed his instructions too slavishly, and ordered him to keep to his own house for nine months. His disgrace was short, for in 1588 he was presented with the order of the Garter, and was sent again to the Netherlands in 1589 and 1598. He was elected chancellor of the university of Oxford in 1591, and in 1599 he succeeded Lord Burghley as lord high treasurer of England. In 1601 as high steward he pronounced sentence on Essex, who had been his rival for the chancellorship and his opponent in politics. James I. confirmed him in the office of lord treasurer, the duties of which he performed with the greatest impartiality. He was created earl of Dorset in 1604, and died suddenly on the 19th of April 1608, as he was sitting at the council table at Whitehall. His eldest son, Robert, the 2nd earl (1561-1609), was a member of parliament and a man of great learning. Two other sons were William (c. 1568-1591), a soldier who was killed in the service of Henry IV. of France, and Thomas (1571-1646), also a soldier.

It is not by his political career, distinguished as it was, that Sackville is remembered, but by his share in early life in two works, each of which was, in its way, a new departure in English literature. In *A Myrrour for Magistrates*, printed by Thomas Marshe in 1559, he has sometimes been erroneously credited with the inception of the general plan as well as with the most valuable contributions. But there had been an earlier edition, for the editor, William Baldwin, states in his preface that the work was begun and partly printed "four years ago." He also says that the printer (John Wayland) had designed the work as a continuation of Lydgate's *Fall of Princes* derived from the narrative of Bochas. Fragments of this early edition are extant, the title page being sometimes found bound up with Lydgate's book. It runs *A Memoriall of such princes, as since the tyme of Richard the seconde, have been unfortunate in the realme of England*, while the 1559 edition has the running title *A brieve memorial of unfortunate English princes*. The disconnected poems by various authors were given a certain continuity by the simple device of allowing the ghost of each unfortunate hero "to bewail unto me [Baldwin] his grievous chanches, heavy destinies and woefull misfortunes." After a delay caused by an examination by Stephen Gardiner, bishop of Worcester, the book appeared. It contained nineteen tragic legends by six poets, William Baldwin, George Ferrers, "Master" Cavyll, Thomas Chaloner, Thomas Phaer and John Skelton. In 1563 appeared a second edition with eight additional poems by William Baldwin, John Dolman, Sackville, Francis Segar, Thomas Churchyard and Cavyll. Sackville contributed the *Complaint of Henry Stafford*, duke of Buckingham, to which he prefixed an *Induction*. This was evidently designed as an introduction to a version of the whole work, and, being arbitrarily transposed (1610) to the beginning by a later editor, Richard Nicolls, led to the attribution of the general design to Sackville, an error which was repeated by Thomas Warton. The originators were certainly Baldwin and his "printer." In 1574 Thomas Marshe printed a series of new tragedies by John Higgins as the *Firste parte of the Mirour for Magistrates*. . . . *From the coming of Brute to the Incarnation*. The seventh edition (1578) contained for the first time the two tragedies of Eleanor Cobham and Humphrey duke of Gloucester. In 1587, when the original editor was dead, the two quite separate publications of Baldwin and Higgins were combined. The primary object of this earliest of English miscellanies was didactic. It was to be a kind of textbook of British history, illustrating the evils of ambition. The writers pretended to historical accuracy, but with the notable exceptions of Churchyard and Sackville they paid little attention to form. The book did much to promote interest in English history, and Mr W. J. Courthope has pointed out that the subjects of Marlowe's *Edvard II.*, of Shakespeare's *Henry VI.*, *Richard II.* and *Richard III.* are already dealt with in the *Myrrour*.

Sackville's *Induction* opens with a description of the oncoming of winter. The poet meets with Sorrow, who offers to lead him to

¹ J. L. Motley, *Hist. of the United Netherlands* (vol. ii. p. 216, ed. 1867).

the infernal regions that he may see the sad estate of those ruined by their ambition, and thus learn the transient character of earthly joy. At the approaches of Hell he sees a group of terrible abstractions, Remorse of Conscience, Dread, Misery, Revenge, Care, &c., each vividly described. The last of these was War, on whose shield he saw depicted the great battles of antiquity. Finally, penetrating to the realm of Pluto himself, he is surrounded by the shades, of whom the duke of Buckingham is the first to advance, thus introducing the *Complaint*. To this induction the epithet "Dantesque" has been frequently applied, but in truth Sackville's models were Gavin Douglas and Virgil. The dignity and artistic quality of the narrative of the fall of Buckingham are in strong contrast to the crude attempts of Ferrers and Baldwin, and make the work one of the most important between the *Canterbury Tales* and the *Faerie Queene*.

Sackville has also the credit of being part author with Thomas Norton of the first legitimate tragedy in the English language. This was *Gorboduc* or *Ferrex and Porrex*, performed as part of the Christmas festivities (1560-1561) by the society of the Inner Temple, and afterwards on the 18th of January 1561 before Elizabeth at Whitehall. The argument is as follows:

"Gorboduc, king of Brittain, divided his Realme in his lyfe tyme to his Sones, Ferrex and Porrex. The Sannes tell to dyvisyon and discention. The younger kylled the elder. The Mother, that more dearely loved the elder, for revenge kylled the younger. The people, moved with the Crueltye of the facte, rose in Rebellion, and Slew both father and mother. The Nobilitie assembled, and most terribly destroyed the Rebelles. And afterwards for want of Issue of the Prince, wherby the Succession of the Crowne became uncertayne, they fell to Ciuill warre, in whiche both they and many of their Issues were slayne, and the Lande for a longe tyme almoste desolate, and myserabylly wasted."

The argument shows plainly enough the didactic intention of the whole, and points the moral of the evils of civil discord. The story is taken from Book II. chap. xvi. of Geoffrey of Monmouth's history. It was first printed (1565) in an unauthorized edition as *The Tragedie of Gorboduc* "whereof three Actes were wrytten by Thomas Nortone, and the two laste by Thomas Sackvyle." Norton's share has been generally minimized, and it seems safe to assume that Sackville is responsible for the general design. In 1570 appeared an authentic edition, *The Tragedie of Ferrex and Porrex*, with a preface from the printer to the reader stating that the authors were "very much displeas'd that she (the tragedy) so ran abroad without leave." The tragedies of Seneca were now being translated, and the play is conceived on Senecan lines. The plot was no doubt chosen for its accumulated horrors from analogy with the tragic subjects of Oedipus and Thyestes. None of the crimes occur on the stage, but the action is described in lofty language by the characters. The most famous and harrowing scene is that in which Marcellus relates the murder of Porrex by his mother (Act IV. sc. ii.). The paucity of action is eked out by a dumb show to precede each act, and the place of the Chorus is supplied by four "ancient and sage men of Britain." In the variety of incident, however, the authors departed from the classical model. The play is written in excellent blank verse, and is the first example of the application of Surrey's innovation to drama. Jasper Heywood in the poetical address prefixed to his translation of the Thyestes alludes to "Sackvylde's Sonnets sweetly sauste," but only one of these has survived. It is prefixed to Sir T. Hoby's translation of Castiglione's *Courtier*. Sackville's poetical preoccupations are sufficiently marked in the subject matter of these two works, which remain the sole literary productions of an original mind.

The best edition of the *Mirror for Magistrates* is that of Joseph Haslewood (1815). *Gorboduc* was edited for the Shakespeare Society by W. D. Cooper in 1847; in 1883 by Miss L. Toulmin Smith for C. Vollmöller's *Englische Sprach- und Literaturdenkmale* (Heilbronn, 1883). The *Works* of Sackville were edited by C. Chapple (1820) and by the Hon. and Rev. Reginald Sackville-West (1859). See also *A Mirror for Magistrates* (1898) by Mr W. F. Trench; an excellent account in Mr W. J. Courthope's *History of English Poetry*, vol. i. pp. 111 et seq.; and an important article by Dr J. W. Cunliffe in the *Cambridge History of English Literature*, vol. iii.

EDWARD SACKVILLE, 4TH EARL OF DORSET (1591-1652), son of the 2nd earl, succeeded his brother Richard, the 3rd earl

(1590-1624), in March 1624. He had attained much notoriety by killing Edward Bruce, 2nd Lord Kinloss, in a duel, in August 1613, the place in the Netherlands where this encounter took place being called Bruceland in quite recent times, and in 1620 he was one of the leaders of the English contingent which fought for James I.'s son-in-law, Frederick V., elector palatine of the Rhine, at the battle of the White Hill, near Prague. In the House of Commons, where he represented Sussex, Sackville was active in defending Bacon and in advocating an aggressive policy with regard to the recovery of the Rhenish Palatinate; twice he was ambassador to France, and he was interested in Virginia and the Bermuda Islands. Under Charles I. he was a privy councillor and lord chamberlain to Queen Henrietta Maria. He was frequently employed by the government from the accession of Charles until the outbreak of the Civil War, when he joined the king at York, but he disliked the struggle and was constant in his efforts to secure peace. At Oxford he was lord chamberlain to the king and lord president of his council, but Charles did not altogether approve of his pacific attitude, and is said on one occasion to have remarked to him "Your voice is the voice of Jacob, but your hands are the hands of Esau." He died on the 17th of July 1652. His wife Mary (d. 1645), daughter of Sir George Curzon, was governess to the sons of Charles I., the future kings Charles II. and James II. His character is thus summed up by S. R. Gardiner: "Pre-eminent in beauty of person, and in the vigour of a cultivated intellect, he wanted nothing to fit him for the highest places in the commonwealth but that stern sense of duty without which no man can be truly great."

CHARLES SACKVILLE, 6TH EARL OF DORSET (1638-1706), English poet and courtier, son of Richard Sackville, 5th earl (1622-1677), was born on the 24th of January 1638. His mother was Frances Cranfield, sister and heiress of Lionel, 3rd earl of Middlesex, to whose estates and title he succeeded in 1674, being created Baron Cranfield and 4th earl of Middlesex in 1675. He succeeded to his father's estates and title in August 1677. Buckhurst was educated privately, and spent some time abroad with a private tutor, returning to England shortly before the Restoration. In Charles II.'s first parliament he sat for East Grinstead in Sussex. He had no taste for politics, however, but won a reputation as courtier and wit at Whitehall. He bore his share in the excesses for which Sir Charles Sedley and the earl of Rochester were notorious. In 1662 he and his brother Edward, with three other gentlemen, were indicted for the robbery and murder of a tanner named Hoppy. The defence was that they were in pursuit of thieves, and mistook Hoppy for a highwayman. They appear to have been acquitted, for when in 1663 Sir Charles Sedley was tried for a gross breach of public decency in Covent Garden, Buckhurst, who had been one of the offenders, was asked by the lord chief justice "whether he had so soon forgot his deliverance at that time." Something in his character made his follies less obnoxious to the citizens than those of the other rakes, for he was never altogether unpopular, and Rochester is said to have told Charles II. that he did not "know how it was, my Lord Dorset might do anything, yet was never to blame." In 1665 he volunteered to serve under the duke of York in the Dutch War. His famous song, "To all you ladies now at Land," was written, according to Prior, on the night before the victory gained over "foggy Opdam" off Harwich (June 3, 1665). Dr Johnson, with the remark that "seldom any splendid story is wholly true," says that the earl of Orrery had told him it was only retouched on that occasion. In 1667 Pepys laments that Buckhurst had lured Nell Gwyn away from the theatre, and that with Sedley the two kept "merry house" at Epsom. Next year the king was paying court to Nell, and her "Charles the First," as she called Buckhurst, was sent on a "sleeveless errand" into France to be out of the way. His gaiety and wit secured the continued favour of Charles II., but did not especially recommend him to James II., who could not, moreover, forgive Dorset's lampoons on his mistress, Catharine Sedley, countess of Dorchester. On James's accession, therefore, he retired from court. He occurred in the invitation to William of Orange, who made him privy councillor, lord chamberlain (1689), and knight of the Garter (1692). During

William's absences in 1695-1698 he was one of the lord justices of the realm.

He was a generous patron of men of letters. When Dryden was dismissed from the laureateship, he made him an equivalent pension from his own purse. Matthew Prior, in dedicating his *Poems on Several Occasions* (1709) to Dorset's son, affirms that his opinion was consulted by Edmund Waller; that the duke of Buckingham deferred the publication of his *Rehearsal* until he was assured that Dorset would not "rehearse upon him again"; and that Samuel Butler and Wycherley both owed their first recognition to him. Prior's praise of Dorset is no doubt extravagant, but when his youthful follies were over he appears to have developed sterling qualities, and although the poems he has left are very few, none of them are devoid of merit. Dryden's "Essay on Satire" and the dedication of the "Essay on Dramatic Poesy" are addressed to him. Walpole (*Catalogue of Noble Authors*, iv.) says that he had as much wit as his first master, or his contemporaries Buckingham and Rochester, without the royal want of feeling, the duke's want of principles or the earl's want of thought; and Congreve reported of him when he was dying that he "slabbered" more wit than other people had in their best health. He was three times married, his first wife being Mary, widow of Charles Berkeley, earl of Falmouth. He died at Bath on the 29th of January 1760.

The fourth act of *Pompey the Great*, a tragedy translated out of French by certain persons of honour, is by Dorset. The satires for which Pope classed him with the masters in that kind seem to have been short lampoons, with the exception of *A faithful catalogue of our most eminent ninnies* (reprinted in *Bibliotheca Curiosa*, ed. Goldamid, 1885). *The Works of the Earls of Rochester, Roscommon and Dorset, the Dukes of Devonshire, Buckinghamshire, &c., with Memoirs of their Lives* (1731) is catalogued (No. 20841) by H. G. Bohn in 1841. His *Poems* are included in Anderson's and other collections of the British poets.

LIONEL CRANFIELD SACKVILLE, 1ST DUKE OF DORSET (1688-1765), the only son of the 6th earl, was born on the 18th of January 1688. He succeeded his father as 7th earl of Dorset in January 1706, and was created duke of Dorset in 1720. He was lord steward of the royal household from 1725 to 1730, and lord-lieutenant of Ireland from 1730 to 1737; he was again lord steward from 1737 to 1745, and was lord president of the council from 1745 to 1751. In 1750 he was appointed lord-lieutenant of Ireland for the second time, and after a stormy viceregency he was dismissed from office in 1755. The duke, who was several times one of the lords justices of Great Britain and held many other positions of trust, died on the 10th of October 1765. He left three sons: Charles, the 2nd duke; John Philip (d. 1765); and George, who took the additional name of Germain in 1770, and in 1782 was created Viscount Sackville (q.v.).

CHARLES SACKVILLE, 2ND DUKE OF DORSET (1711-1769), an associate of Frederick, prince of Wales, was a member of parliament for many years and a lord of the treasury under Henry Pelham; he died on the 5th of January 1769, when his nephew, John Frederick (1745-1799), became the 3rd duke. This nobleman was ambassador in Paris from 1783 to 1789, and lord steward of the household from 1789 to 1799; he died on the 19th of July 1799, and was succeeded by his only son, George John Frederick (1793-1815). When the 4th duke died unmarried in February 1815, the titles passed to his kinsman, Charles Sackville Germain (1767-1843), son and heir of the 1st Viscount Sackville, who thus became 5th duke of Dorset. When he died on the 29th of July 1843 the titles became extinct.

DORSETSHIRE (DORSET), a south-western county of England, bounded N.E. by Wiltshire, E. by Hampshire, S. by the English Channel, W. by Devonshire and N.W. by Somersetshire. The area is 987.9 sq. m. The surface is for the most part broken. A line of hills or downs, forming part of the system to which the general name of the Western Downs is applied, enters the county in the north-east near Shaftesbury, and strikes across it in a direction generally W. by S., leaving it towards Axminster and Crewkerne in Devonshire. East of Beaminster in the south-west another line, the Purbeck Downs, branches S.E. to the coast, which it follows as far as the district called the Isle of Purbeck in the

south-east of the county. Both these ranges occasionally exceed a height of 900 ft. Of the principal rivers and streams, the Stour rises just outside the county in Wiltshire, and flows with a general south-easterly course to join the Hampshire Avon close to its mouth. It receives the Cale, Lidden and other streams in its upper course, and breaches the central hills in its middle course between Sturminster Newton and Blandford. The Lidden and Cale are the chief streams of the well-watered and fertile district known as the Vale of Blackmore. The small river Piddle or Trent and the larger Frome, rising in the central hills, traverse a plain tract of open country between the central and southern ranges, and almost unite their mouths in Poole Harbour. In the north-west the Yeo, collecting many feeders, flows northward to join the Parret and so sends its waters to the Bristol Channel. The Char, the Brit and the Bride, with their feeders, water many picturesque short valleys in the south-west. The coast is always beautiful, and in some parts magnificent. In the east it is broken by the irregular, lake-like inlet of Poole Harbour, pleasantly diversified with low islands, shallow, and at low tide largely drained. South of this a bold foreland, the termination of the southern hills (here called Ballard Down) divides Studland Bay from Swanage Bay, after which the coast line turns abruptly westward round Durston Head. The peninsula thus formed with Poole Harbour on the north is known as the Isle of Purbeck, an oblong projection measuring 10 m. by 7. St Albans or Aldhelms Head is the next salient feature, after which the fine cliffs are indented with many little bays, of which the most noteworthy is the almost landlocked Lulworth Cove. The coast then turns southward to embrace Weymouth Bay and Portland Roads, where a harbour of refuge with massive breakwaters is protected to the south by the Isle of Portland. The island is connected with the mainland by Chesil Bank, a remarkable beach of shingle. After this the coast is less broken than before and continues highly picturesque as far as the confines of the county near Lyme Regis. This small town, with Charmouth, Bridport, Weymouth, Lulworth Cove and Swanage, are in considerable favour as watering-places.

Geology.—Occupying as it does the central and most elevated part of the county, the Chalk is the most prominent geological formation in Dorsetshire. It sweeps in a south-westerly direction, as a belt of high ground about 12 m. in width, from Cranborne Chase, through Blandford, Milton Abbas and Frampton to Dorchester; westward it reaches a point just north of Beaminster. From about Dorchester the Chalk outcrop narrows and turns south-eastward by Portland, Bincombe, to West Lulworth, thence the crop proceeds eastward as the ridge of the Purbeck Hills, and finally runs out to sea as the headland between Studland and Swanage Bay.

Upon the Chalk in the eastern part of the county are the Eocene beds of the Hampshire Basin. These are fringed by the Reading Beds and London Clay, which occur as a narrow belt from Cranborne through Wimborne Minster, near Bere Regis and Piddletown; here the crop swings round south-eastward through West Knighton, Winfrith and Lulworth, and thence along the northern side of the Purbeck Hills to Studland. Most of the remaining Eocene area is occupied by the sands, gravel and clay of the Bagshot series. The Agglestone Rock near Studland is a hard mass of the Bagshot formation; certain clays in the same series in the Wareham district have a world-wide reputation for pottery purposes; since they are exported from Poole Harbour they are often known as "Poole Clay." From beneath the Chalk the Selbornian or Gault and Upper Greensand crops out as a narrow, irregular band. The Gault clay is only distinguishable in the northern and southern districts. Here and there the Greensand forms prominent hills, as that on which the town of Shaftesbury stands. The Upper Greensand appears again as outliers farther west, forming the high ground above Lyme Regis, Golden Cap, and Pilsden and Lewesden Penns. The Lower Greensand crops out on the south side of the Purbeck Hills and may be seen at Punfield Cove and Worbarrow Bay, but this formation thins out towards the west. By the action of the agencies of denudation upon the faulted anticline of the Isle of Purbeck, the Wexall beds are brought to light in the vale between Lulworth and Swanage; a similar cause has accounted for their appearance at East Chaldon. South of the strip of Weald Clay is an elevated plateau consisting of Purbeck Beds which rest upon Portland Stone and Portland Sand. Cropping out from beneath the Portland beds is the Kimmeridge Clay with so-called "Coal" bands, which forms the lower platform near the village of that name.

The Middle Purbeck building stone and Upper Purbeck *Paludina* marble have been extensively quarried in the Isle of Purbeck. An interesting feature in the Lower Purbeck is the "Dirt bed," the remains of a Jurassic forest, which may be seen near Mupe Bay and

on the Isle of Portland, where both the Purbeck and Portland formations are well exposed, the latter yielding the well-known freestones. In the north-west of the county the Kimmeridge Clay crops in a N.-S. direction from the neighbourhood of Gillingham by Woolland to near Buckland Newton; in the south, a strip runs E. and W. between Abbotsbury, Upway and Osmington Mill. Next in order come the Corallian Beds and Oxford Clay which follow the line of the Kimmeridge Clay, that is, they run from the north to the south-west except in the neighbourhood of Abbotsbury and Weymouth, where these beds are striking east and west.

Below the Oxford Clay is the Cornbrash, which may be seen near Redipole, Stalbridge and Stourton; then follows the Forest Marble, which usually forms a strong escarpment over the Fuller's Earth beneath—at Thornford the Fuller's Earth rock is quarried. Next comes the Inferior Oolite, quarried near Sherborne and Beaminster; the outcrop runs on to the coast at Bridport. Beneath the Oolites are the Midford sands, which are well exposed in the cliff between Bridport and Burton Brandstock. Except where the Greensand outcrops occur, the south-western part of the county is occupied by Lower and Middle Lias beds. These are clays and marls in the upper positions and limestones below. Rhætic beds, the so-called "White Lias," are exposed in Pinhay Bay.

Many of the formations in Dorsetshire are highly fossiliferous, notably the Lias of Lyme Regis, where *Ichthyosaurus* and other large reptiles have been obtained; remains of the *Iguanodon* have been taken from the Wealden beds of the Isle of Purbeck; the Kimmeridge Clay, Inferior Oolite, Forest Marble and Fuller's Earth are all fossil-bearing rocks. The coast exhibits geological sections of extreme interest and variety; the vertical and highly inclined strata of the Purbeck anticline are well exhibited at Gad Cliff or near Ballard Point; at the latter place the fractured fold is seen to pass into an "overthrust fault."

Climate and Agriculture.—The air of Dorsetshire is remarkably mild, and in some of the more sheltered spots on the coast semi-tropical plants are found to flourish. The district of the clays obtains for the county the somewhat exaggerated title of the "garden of England," though the rich Vale of Blackmore and the luxuriant pastures and orchards in the west may support the name. Yet Dorsetshire is not generally a well-wooded county, though much fine timber appears in the richer soils, in some of the sheltered valleys of the chalk district, and more especially upon the Greensand. About three-fourths of the total area is under cultivation, and of this nearly five-eighths is in permanent pasture, while there are in addition about 26,000 acres of hill pasturage; the chalk downs being celebrated of old as sheep-walks. Wheat, barley and oats are grown about equally. Turnips occupy nearly three-fourths of the average under green crops. Sheep are largely kept, though in decreasing numbers. The old horned breed of Dorsetshire were well known, but Southdowns or Hampshires are now frequently preferred. Devons, shorthorns and Herefords are the most common breeds of cattle. Dairy farming is an important industry.

Other Industries.—The quarries of Isles of Portland and Purbeck are important. The first supplies a white freestone employed for many of the finest buildings in London and elsewhere. Purbeck marble is famous through its frequent use by the architects of many of the most famous Gothic churches in England. A valuable product of Purbeck is a white pipeclay, largely applied to the manufacture of china, for which purpose it is exported to the Potteries of Staffordshire. Industries, beyond those of agriculture and quarrying, are slight, though some ship-building is carried on at Poole, and paper is made at several towns. Other small manufactures are those of flax and hemp in the neighbourhood of Bridport and Beaminster, of bricks, tiles and pottery in the Poole district, and of nets (braiding, as the industry is called) in some of the villages. There are silk-mills at Sherborne and elsewhere. There are numerous fishing stations along the coast, the fishing being mostly coastal. There are oyster beds in Poole Harbour. The chief ports are Poole, Weymouth, Swanage, Bridport, and Lyme Regis. The harbour of refuge at Portland, under the Admiralty, is an important naval station, and is fortified.

Communications.—The main line of the London & South Western railway serves Gillingham and Sherborne in the north of the county. Branches of this system serve Wimborne, Poole, Swanage, Dorchester, Weymouth and Portland. The two last towns, with Bridport, are served by the Great Western railway; the Somerset & Dorset line (Midland and South Western joint)

follows the Stour valley by Blandford and Wimborne; and Lyme Regis is the terminus of a light railway from Axminster on the South Western line.

Population and Administration.—The area of the ancient county is 632,270 acres, with a population in 1801 of 104,517, and in 1901 of 202,936. The area of the administrative county is 625,578 acres. The county contains 35 hundreds. It is divided into northern, eastern, southern and western parliamentary divisions, each returning one member. It contains the following municipal boroughs—Blandford Forum (pop. 3649), Bridport (5710), Dorchester, the county town (9458), Lyme Regis (2095), Poole (19,463), Shaftesbury (2027), Wareham (2003), Weymouth and Melcombe Regis (19,831). The following are other urban districts—Portland (15,199), Sherborne (5760), Swanage (3408), Wimborne Minster (3696). Dorsetshire is in the western circuit, and assizes are held at Dorchester. It has one court of quarter sessions, and is divided into nine petty sessional divisions. The boroughs of Bridport, Dorchester, Lyme Regis, Poole, and Weymouth and Melcombe Regis have separate commissions of the peace, and the borough of Poole has in addition a separate court of quarter sessions. There are 289 civil parishes. The ancient county, which is almost entirely in the diocese of Salisbury, contains 256 ecclesiastical parishes or districts wholly or in part.

History.—The kingdom of Wessex originated with the settlement of Cerdic and his followers in Hampshire in 495, and at some time before the beginning of the 8th century the tide of conquest and colonization spread beyond the Frome and Kennet valleys and swept over the district which is now Dorsetshire. In 705 the West Saxon see was transferred to Sherborne, and the numerous foundations of religious houses which followed did much to further the social and industrial development of the county; though the wild and uncivilized state in which the county yet lay may be conjectured from the names of the hundreds and of their meeting-places, at barrows, boulders and vales. In 787 the Danes landed at Portland, and in 833 they arrived at Charmouth with thirty-five ships and fought with Egbert. The shire is first mentioned by name in the Saxon Chronicle in 845, when the Danes were completely routed at the mouth of the Parret by the men of Dorsetshire under Oaric the ealdorman. In 876 the invaders captured Wareham, but were driven out next year by Alfred, and 120 of their ships were wrecked at Swanage. During the two following centuries Dorset was constantly ravaged by the Danes, and in 1015 Canute came on a plundering expedition to the mouth of the Frome. Several of the West Saxon kings resided in Dorsetshire, and Æthelwald and Æthelbert were buried at Sherborne, and Æthelred in Wimborne. In the reign of Canute Wareham was the shire town; it was a thriving seaport, with a house for the king when he came there on his hunting expeditions, a dwelling for the shire-reeve and accommodation for the leading thegns of the shire. At the time of the Conquest Dorset formed part of Harold's earldom, and the resistance which it opposed to the Conqueror was punished by a merciless harrying, in which Dorchester, Wareham and Shaftesbury were much devastated, and Bridport utterly ruined.

No Englishman retained estates of any importance after the Conquest, and at the time of the Survey the bulk of the land, with the exception of the forty-six manors held by the king, was in the hands of religious houses, the abbeyes of Cerne, Milton and Shaftesbury being the most wealthy. There were 272 mills in the county at the time of the Survey, and nearly eighty men were employed in working salt along the coast. Mints existed at Shaftesbury, Wareham, Dorchester and Bridport, the three former having been founded by Æthelstan. The forests of Dorsetshire were favourite hunting-grounds of the Norman kings, and King John in particular paid frequent visits to the county.

No precise date can be assigned for the establishment of the shire system in Wessex, but in the time of Egbert the kingdom was divided into definite *pagi*, each under an ealdorman, which no doubt represented the later shires. The *Inquisitio Geldi*, drawn up two years before the Domesday Survey, gives the names of the 39 pre-Conquest hundreds of Dorset. The 33 hundreds and

21 liberties of the present day retain some of the original names, but the boundaries have suffered much alteration. The 8000 acres of Stockland and Dalwood reckoned in the Dorset Domesday are now annexed to Devon, and the manor of Holwell now included in Dorset was reckoned with Somerset until the 19th century. Until the reign of Elizabeth Dorset and Somerset were united under one sheriff.

After the transference of the West Saxon see from Sherborne to Sarum in 1075, Dorset remained part of that diocese until 1542, when it was included in the newly formed diocese of Bristol. The archdeaconry was coextensive with the shire, and was divided into five rural deaneries at least as early as 1201.

The vast power and wealth monopolized by the Church in Dorsetshire tended to check the rise of any great county families. The representatives of the families of Mohun, Brewer and Arundel held large estates after the Conquest, and William Mohun was created earl of Dorset by the empress Maud. The families of Clavel, Lovell, Maundeville, Mautravers, Peveler and St Lo also came over with the Conqueror and figure prominently in the early annals of the county.

Dorsetshire took no active part in the struggles of the Norman and Plantagenet period. In 1627 the county refused to send men to La Rochelle, and was reproved for its lack of zeal in the service of the state. On the outbreak of the Civil War of the 17th century the general feeling was in favour of the king, and after a series of royalist successes in 1643 Lyme Regis and Poole were the only garrisons in the county left to the parliament. By the next year however, the parliament had gained the whole county with the exception of Sherborne and the Isle of Portland. The general aversion of the Dorsetshire people to warlike pursuits is demonstrated at this period by the rise of the "clubmen," so called from their appearance without pikes or fire-arms at the county musters, whose object was peace at all costs, and who punished members of either party discovered in the act of plundering.

In the 14th century Dorsetshire produced large quantities of wheat and wool, and had a prosperous clothing trade. In 1626 the county was severely visited by the plague, and from this date the clothing industry began to decline. The hundred of Pimperne produced large quantities of saltpetre in the 17th century, and the serge manufacture was introduced about this time. Portland freestone was first brought into use in the reign of James I., when it was employed for the new banqueting house at Whitehall, and after the Great Fire it was extensively used by Sir Christopher Wren. In the 18th century Blandford, Sherborne and Lyme Regis were famous for their lace, but the industry has now declined.

The county returned two members to parliament in 1290, and as the chief towns acquired representation the number was increased, until in 1572 the county and nine boroughs returned a total of twenty members. Under the Reform Act of 1832 the county returned three members, and Corfe Castle was disfranchised. By the Representation of the People Act of 1868 Lyme Regis was disfranchised, and by the Redistribution Act of 1885 the remaining boroughs were disfranchised.

Antiquities.—Remains of medieval castles are inconsiderable, with the notable exception of Corfe Castle and the picturesque ruins of Sherborne Castle, both destroyed after the Civil War of the 17th century. The three finest churches in the county are the abbey church of Sherborne, Wimborne Minster and Milton Abbey church, a Decorated and Perpendicular structure erected on the site of a Norman church which was burnt. It has transepts, chancel and central tower, but the nave was not built. This was a Benedictine foundation of the 10th century, and the refectory of the 15th century is incorporated in the mansion built in 1772. At Ford Abbey part of the buildings of a Cistercian house are similarly incorporated. There are lesser monastic remains at Abbotsbury, Cerne and Bindon. The parish churches of Dorsetshire are not especially noteworthy as a whole, but those at Cerne Abbas and Beaminster are fine examples of the Perpendicular style, which is the most common in the county. A little good Norman work remains, as in the churches of Bere Regis and

Fiddletrethide, but both these were reconstructed in the Perpendicular period; Bere Regis church having a superb timber roof of that period.

The dialect of the county, perfectly distinguishable from those of Wiltshire and Somersetshire, yet bearing many common marks of Saxon origin, is admirably illustrated in some of the poems of William Barnes (*q.v.*). Many towns, villages and localities are readily to be recognized from their descriptions in the "Wessex" novels of Thomas Hardy (*q.v.*).

A curious ancient *Survey of Dorsetshire* was written by the Rev. Mr Coker, about the middle of the 17th century, and published from his MS. (London, 1732). See also J. Hutchins, *History and Antiquities of the County of Dorset* (London, 1774); 2nd ed. by R. Gough and E. B. Nichols (1796-1815); 3rd ed. by W. Shipp and J. W. Hodson (1861-1873); C. Warne, *Ancient Dorset* (London, 1865); R. W. Eyton, *A Key to Domesday, exemplified by an analysis and digest of the Dorset Survey* (London, 1878); C. H. Mayo, *Bibliotheca Dorsetiensis* (London, 1885); W. Barnes, *Glossary of Dorset Dialect* (Dorchester, 1886); H. J. Moule, *Old Dorset* (London, 1893); *Victoria County History, Dorsetshire*.

DORSIVENTRAL (Lat. *dorsum*, the back, *venter*, the belly), a term used to describe an organ which has two surfaces differing from each other in appearance and structure, as an ordinary leaf.

DORT, SYNOD OF. An assembly of the Reformed Dutch Church, with deputies from Switzerland, the Palatinate, Nassau, Hesse, East Friesland, Bremen, Scotland and England, called to decide the theological differences existing between the Arminians (or Remonstrants) and the Calvinists (or Counter-Remonstrants), was held at Dort or Dordrecht (*q.v.*) in the years 1618 and 1619. The government of Louis XIII. prohibited the attendance of French delegates. During the life of Arminius a bitter controversy had sprung up between his followers and the strict Calvinists, led by Francis Gomar, his fellow-professor at Leiden; and, in order to decide their disputes, a synodical conference was proposed, but Arminius died before it could be held. At the conference held at the Hague in 1610 the Arminians addressed a remonstrance to the states-general in the form of five articles, which henceforth came to be known as the five points of Arminianism. In these they reacted against both the supralapsarian and the infralapsarian developments of the doctrine of predestination and combated the irresistibility of grace; they held that Christ died for all men and not only for the elect, and were not sure that the elect might not fall from grace. This conference had no influence in reconciling the opposing parties, and another, held at Delft in the year 1613, was equally unsuccessful. In 1614, at the instance of the Arminian party, an edict was passed by the states-general, in which toleration of the opinions of both parties was declared and further controversy forbidden; but this act only served, by rousing the jealousy of the Calvinists, to fan the controversial flame into greater fury. Gradually the dispute pervaded all classes of society, and the religious questions became entangled with political issues; the partisans of the house of Orange espoused the cause of the stricter Calvinism, whereas the bourgeois oligarchy of republican tendencies, led by Oldenbarnevelt and Hugo Grotius, stood for Arminianism. In 1617 Prince Maurice of Orange committed himself definitely to the Calvinistic party, found an occasion for throwing Oldenbarnevelt and Grotius into prison, and in November of that year called a synod intended to crush the Arminians. This synod, which assembled at Dort in November 1618, was strictly national—called by the national authority to decide a national dispute, and not intended to have more than a national influence. The foreign deputies were invited to attend, only to assist by their advice in the settlement of a controversy which concerned the Netherland church alone, and which the Netherland church alone could decide. At the fourth sitting it was decided to cite Simon Episcopius and several other Remonstrants to appear within fourteen days before the synod, to state and justify their doctrines. It was also agreed to allow the Arminian deputies to take part in the deliberations, only on condition that they forbore to consult with, or in any way assist,

their cited brethren, but this they refused. During the interval between the citation and the appearance of the accused, the professorial members of the synod was instructed to prepare themselves to be able to confute the Arminian errors, and the synod occupied itself with deliberations as to a new translation of the Bible, for which a commission was named, made arrangements for teaching the Heidelberg catechism, and granted permission to the missionaries of the East Indies to baptize such children of heathen parents as were admitted into their families. At the 25th sitting Episcopius and the others cited appeared, when Episcopius surprised the deputies by a bold and outspoken defence of his views, and even went so far as to say that the synod, by excluding the Arminian deputies, could now only be regarded as a schismatic assembly. The Remonstrants were asked to file copious explanations of the five points in dispute (*Sententia Remonstrantium*), but objecting to the manner in which they were catechized, they were, at the 57th sitting, dismissed from the synod as convicted "liars and deceivers." The synod then proceeded in their absence to judge them from their published writings, and came to the conclusion that as ecclesiastical rebels and trespassers they should be deprived of all their offices. The synodical decision in regard to the five points is contained in the canons adopted at the 136th session held on the 23rd of April 1619; the points were: unconditional election, limited atonement, total depravity, irresistibility of grace, final perseverance of the saints. The issue of *supralapsarianism v. infralapsarianism* was avoided. These doctrinal decisions and the sentence against the Remonstrants were, at the 144th sitting, read in Latin before a large audience in the great church. The Remonstrants were required to subscribe the condemnation, and many of them refused and were banished. The synod was concluded on the 9th of May 1619, by a magnificent banquet given by the chief magistrate of Dort. The Dutch deputies remained a fortnight longer to attend to ecclesiastical business. Though the canons of Dort were adopted by but two churches outside of Holland, the synod ranks as the most impressive assemblage of the Reformed Church.

AUTHORITIES.—*Acta synodi nationalis . . . Dordrechtii habitae* (Lugd. Bat. 1620, official edition); *Acta der Nationale Synode te Dordrecht 1618* (Leiden, 1887), French translation (Leiden, 1622 and 1624, 2 vols.), for the Canons, and the *Sententia Remonstrantium*, E. F. Karl Müller, *Die Bekenntnisschriften der reformirten Kirche* (Leipzig, 1903), p. lix ff., 843 ff.; for canons and abridged translation used by the Reformed Church in America, P. Schaff, *The Creeds of Christendom* (3rd ed., New York, 1877), 550 ff. See also H. Hepp, in *Niederer's Zeitschrift für die historische Theologie*, Bd. 23 (Hamburg, 1853), 226-327 (letters of Hessian deputies); *Acta et scripta synodalia Dordracena missivorum Remonstrantium*, Hardvercij, 1620 (valuable side-lights); A. Schweizer, *Die protestantischen Centraldogmen in ihrer Entwicklung innerhalb der reformirten Kirche*, zweite Hälfte (Zürich, 1896), 25-224; H. C. Rogge in *Herzog-Hauck, Realencyclopädie*, Bd. 4 (Leipzig, 1898), 798-802; H. H. Kuyper, *De Post-Acta of Nahandelingen van de Nationale Synode van Dordrecht, een historische Studie* (Amsterdam, 1899, new material); J. Reitsma, *Geschiednis van de Hervorming en de Hervormde Kerk der Nederlanden* (2nd ed. Groningen, 1899); F. Loois, *Dogmengeschiede* (4th ed., Halle, 1906), 935 ff.; T. Van Oppenraij, *La Prédestination dans l'Église réformée des Pays-Bas depuis l'origine jusqu'à un synode national de Dordrecht* (Louvain, 1906). (W. W. R. *)

DORTMUND, a town of Germany, the chief commercial centre of the Prussian province of Westphalia, on the Esmscher, in a fertile plain, 50 m. E. from Düsseldorf by rail. Pop. (1875) 57,742; (1895) 111,232; (1905) 175,292. Since the abolition of the old walls in 1863 and the conversion of their site into promenades, the town has rapidly assumed a modern appearance. The central part, however, with its winding narrow streets, is redolent of its historical past, when, as one of the leading cities of the Hanseatic League, it enjoyed commercial supremacy over all the towns of Westphalia. Among its ancient buildings must be mentioned the Reinoldikirche, with fine stained-glass windows, the Marienkirche, the nave of which dates from the 11th century, the Petrikerche, with a curious altar, and the Dominican church, with beautiful cloisters. The 13th-century town hall was restored in 1809 and now contains the municipal antiquarian museum, having been superseded by a more commodious building. Among the chief modern structures may be mentioned the magnificent post office, erected in 1895, the provincial law courts,

the municipal infirmary and the large railway station. To the W. of the last there existed down to 1906 (when it was removed) one of the ancient lime trees of the Königshof, where the meetings of the *Vehmgericht* were held (see FÆMERIC COURTS). But the real interest of Dortmund centres in its vast industries, which owe their development to the situation of the town in the centre of the great Westphalian coal basin. In the immediate vicinity are also extensive beds of iron ore, and this combination of mineral wealth has enabled the town to become a competitor with Essen, Oberhausen, Duisburg and Hagen in the products of the iron industry. These in Dortmund more particularly embrace steel railway rails, mining plant, wire ropes, machinery, safes and sewing machines. Dortmund has also extensive breweries, and, in addition to the manufactured goods already enumerated, does a considerable trade in corn and wood. Besides being well furnished with a convenient railway system, linking it with the innumerable manufacturing towns and villages of the iron district, it is also connected with the river Ems by the Dortmund-Ems Canal, 170 m. in length.

Dortmund, the Throtmannia of early history, was already a town of some importance in the 9th century. In 1005 the emperor Henry II. held here an ecclesiastical council, and in 1016 an imperial diet. The town was walled in the 12th century, and in 1387-1388 successfully withstood the troops of the archbishop of Cologne, who besieged it for twenty-one months. About the middle of the 13th century it joined the Hanseatic League. At the close of the Thirty Years' War the population had become reduced to 3000. In 1803 Dortmund lost its rights as a free town, and was annexed to Nassau. The French occupied it in 1806, and in 1808 it was made over by Napoleon to the grand-duke of Berg, and became the chief town of the department of Ruhr. Through the cession of Westphalia by the king of the Netherlands, on the 31st of May 1815, it became a Prussian town.

See Thiersch, *Geschichte der Freireichstadt Dortmund* (Dort, 1854), and Ludolf, *Bau- und Kunstdenkmäler in Dortmund* (Paderborn, 1895); also A. Shadwell, *Industrial Efficiency* (London, 1906).

DORY, or JOHN DORY (*Zeus faber*), an Acanthopterygian fish, the type of the family *Zeidae*, held in such esteem by the ancient Greeks that they called it *Zeus* after their principal divinity. Its English name is probably a corruption of the French *jaune doré*, and has reference to the prevailing golden-yellow colour of the living fish. The body in the dory is much compressed, and is nearly oval in form, while the mouth is large and capable of extensive protrusion. It possesses two dorsal fins, of which the anterior is armed with long slender spines, and the connecting membrane is produced into long tendril-like filaments; while a row of short spines extends along the belly and the roots of the anal and dorsal fins. The colour of the upper surface is olive-brown; the sides are yellowish, and are marked with a prominent dark spot, on account of which the dory divides with the haddock the reputation of being the fish from which Peter took the tribute money. It is an inhabitant of the Atlantic coasts of Europe, the Mediterranean and the Australian seas. It is occasionally abundant on the coasts of Devon and Cornwall, and is also found, though more sparingly, throughout the British seas. It is exceedingly voracious, feeding on molluscs, shrimps and the young of other fish; and Jonathan Couch (1789-1870), author of a *History of British Fishes*, states that from the stomach of a single dory he has taken 25 flounders, some $\frac{1}{2}$ in. long, 3 faterlathers half grown and 5 stones from the beach, one $\frac{1}{4}$ in. in length. They are often taken in the fishermen's nets off the Cornwall and Devon coast, having entered these in pursuit of pilchards. They are seldom found in deep water, preferring sandy bays, among the weeds growing on the bottom of which they lie in wait for their prey, and in securing this they are greatly assisted by their great width of gape, by their power of protruding the mouth, and by the slender filaments of the first dorsal fins, which float like worms in the water, while the greater part of the body is buried in the sand, and thus they entice the smaller fishes to come within easy reach of the capacious jaws. The dory often attains a weight of 12 lb, although those usually brought into the market do not average more than 6 or 7 lb. It is highly valued as an article of food.

The family *Zeidae* has assumed special interest of late, O. Thilo¹ and G. A. Boulenger² having shown that they have much in common with the flat-fishes or *Pleuronectidae* and must be nearly related to the original stock from which this asymmetrical type has been evolved, especially if the Upper Eocene genus *Amphistium* be taken into consideration. This affinity is further supported by the observations made by L. W. Byrne³ on the asymmetry in the number and arrangement of the bony plates at the base of the dorsal and anal fins in the young of the John Dory. (G. A. B.)

DOSITHEUS MAGISTER, Greek grammarian, flourished at Rome in the 4th century A.D. He was the author of a Greek translation of a Latin grammar, intended to assist the Greek-speaking inhabitants of the empire in learning Latin. The translation, at first word for word, becomes less frequent, and finally is discontinued altogether. The Latin grammar used was based on the same authorities as those of Charisius and Diomedes, which accounts for the many points of similarity. Dositheus contributed very little of his own. Some Greek-Latin exercises by an unknown writer of the 3rd century, to be learnt by heart and translated, were added to the grammar. They are of considerable value as illustrating the social life of the period and the history of the Latin language. Of these *Ἐπιγραμματα* (*Interpretamenta*), the third book, containing a collection of words and phrases from everyday conversation (*καθημερινή ὀμιλία*) has been preserved. A further appendix consisted of Anecdotes, Letters and Rescripts of the emperor Hadrian; fables of Aesop; extracts from Hyginus; a history of the Trojan War, abridged from the *Iliad*; and a legal fragment, *Περὶ ἐκθεσίωντων* (*De manumissionibus*).

Editions: *Grammatica* in H. Kell, *Grammatici Latini*, vii. and separately (1871); *Hermeneumata* by G. Götz (1892) (in G. Löwe's *Corpus glossariorum Latinorum*, iii.) and E. Böcking (1832), which contains the appendix (including the legal fragment); see also C. Lachmann, *Versuch über Dositheus* (1837); H. Hagen, *De Dosithei magistri quae feruntur glossis* (1877).

DOSAL (dossel, dorseil or dosel; Fr. *dos*, back), an ecclesiastical ornamented cloth suspended behind the altar.

DOSSETER, or impost block (a Fr. term, from *dos*, back), in architecture, the cubical block of stone above the capitals in a Byzantine church, used to carry the arches and vault, the springing of which had a superficial area greatly in excess of the column which carried them.

DOST MAHOMMED KHAN (1793-1863), founder of the dynasty of the Barakzai in Afghanistan, was born in 1793. His elder brother, the chief of the Barakzai, Fattch Khan, took an important part in raising Mahmud to the sovereignty of Afghanistan in 1800 and in restoring him to the throne in 1809. That ruler repaid his services by causing him to be assassinated in 1818, and thus incurred the enmity of his tribe. After a bloody conflict Mahmud was deprived of all his possessions but Herat, the rest of his dominions being divided among Fattch Khan's brothers. Of these Dost Mohammed received for his share Ghazni, to which in 1826 he added Kabul, the richest of the Afghan provinces. From the commencement of his reign he found himself involved in disputes with Ranjit Singh, the Sikh ruler of the Punjab, who used the dethroned Saduzai prince, Shuja-ul-Mulk, as his instrument. In 1834 Shuja made a last attempt to recover his kingdom. He was defeated by Dost Mohammed under the walls of Kandahar, but Ranjit Singh seized the opportunity to annex Peshawar. The recovery of this fortress became the Afghan amir's great concern. Rejecting overtures from Russia, he endeavoured to form an alliance with England, and welcomed Alexander Burnes to Kabul in 1837. Burnes, however, was unable to prevail on the governor-general, Lord Auckland, to respond to the amir's advances. Dost Mohammed was enjoined to abandon the attempt to recover Peshawar, and to place his foreign policy under British guidance. In return he was only promised protection from Ranjit Singh, of

whom he had no fear. He replied by renewing his relations with Russia, and in 1838 Lord Auckland set the British troops in motion against him. In March 1839 the British force under Sir Willoughby Cotton advanced through the Bolan Pass, and on the 26th of April it reached Kandahar. Shah Shuja was proclaimed amir, and entered Kabul on the 7th of August, while Dost Mohammed sought refuge in the wilds of the Hindu Kush. Closely followed by the British, Dost was driven to extremities, and on the 4th of November 1840 surrendered as a prisoner. He remained in captivity during the British occupation, during the disastrous retreat of the army of occupation in January 1842, and until the recapture of Kabul in the autumn of 1842. He was then set at liberty, in consequence of the resolve of the British government to abandon the attempt to intervene in the internal politics of Afghanistan. On his return from Hindustan Dost Mohammed was received in triumph at Kabul, and set himself to re-establish his authority on a firm basis. From 1846 he renewed his policy of hostility to the British and allied himself with the Sikhs; but after the defeat of his allies at Gujrat on the 21st of February 1849 he abandoned his designs and led his troops back into Afghanistan. In 1850 he conquered Balkh, and in 1854 he acquired control over the southern Afghan tribes by the capture of Kandahar. On the 30th of March 1855 Dost Mohammed reversed his former policy by concluding an offensive and defensive alliance with the British government. In 1857 he declared war on Persia in conjunction with the British, and in July a treaty was concluded by which the province of Herat was placed under a Barakzai prince. During the Indian Mutiny Dost Mohammed punctiliously refrained from assisting the insurgents. His later years were disturbed by troubles at Herat and in Bokhara. These he composed for a time, but in 1862 a Persian army, acting in concert with Ahmad Khan, advanced against Kandahar. The old amir called the British to his aid, and, putting himself at the head of his warriors, drove the enemy from his frontiers. On the 26th of May 1863 he captured Herat, but on the 9th of June he died suddenly in the midst of victory, after playing a great rôle in the history of Central Asia for forty years. He named as his successor his son, Shere Ali Khan. (E. I. C.)

DOSTOIEVSKY, FEODOR MIKHAILOVICH (1821-1881), Russian author, born at Moscow, on the 30th of October 1821, was the second son of a retired military surgeon of a decayed noble family. He was educated at Moscow and at the military engineering academy at St Petersburg, which he left in 1843 with the grade of sub-lieutenant. Next year his father died, and he resigned his commission in order to devote himself to literature—thus commencing a long struggle with ill-health and penury. In addition to the old Russian masters Gogol and Pushkin, Balzac and George Sand supplied him with literary ideals. He knew little of Dickens, but his first story is thoroughly Dickensian in character. The hero is a Russian "Tom Pinch," who entertains a pathetic, humble adoration for a fair young girl, a solitary walk like himself. Characteristically the Russian story ends in "tender gloom." The girl marries a middle-aged man of property; the hero dies of a broken heart, and his funeral is described in lamentable detail. The germ of all Dostoevsky's imaginative work may be discovered here. The story was submitted in manuscript to the Russian critic, Bielinski, and excited his astonishment by its power over the emotions. It appeared in the course of 1846 in the *Recueil de Saint-Petersbourg*, under the title of "Poor People." An English version, *Poor Folk*, with an introduction by Mr George Moore, appeared in 1894. The successful author became a regular contributor of short tales to the *Annals of the Country*, a monthly periodical conducted by Kraevsky; but he was wretchedly paid, and his work, though revealing extraordinary power and intensity, commonly lacks both finish and proportion. Poverty and physical suffering robbed him of the joy of life and filled him with bitter thoughts and morbid imaginings. During 1847 he became an enthusiastic member of the revolutionary reunions of the political agitator, Petrachevski. Many of the students and younger members did little more than discuss the theories of Fourier and other economists at these gatherings. Exaggerated

¹ "Die Vorfahren der Schollen," *Biol. Centralbl.* xiii. (1902), p. 717.

² "On the systematic position of the *Pleuronectidae*," *Ann. and Mag. N. H.* x. (1902), p. 295.

³ "On the number and arrangement of the bony plates of the young John Dory," *Biometrika*, ii. (1902), p. 115.

reports were eventually carried to the police, and on the 23rd of April 1849 Dostoevsky and his brother, with thirty other suspected personages, were arrested. After a short examination by the secret police they were lodged in the fortress of St Peter and St Paul at St Petersburg, in which confinement Feodor wrote his story *A Little Hero*. On the 22nd of December 1849 the accused were all condemned to death and conveyed in vans to a large scaffold in the Simonovskiy Place. As the soldiers were preparing to carry out the sentence, the prisoners were informed that their penalty was commuted to exile in Siberia. The novelist's sentence was, four years in Siberia and enforced military service in the ranks for life. On Christmas eve 1849 he commenced the long journey to Omsk, and remained in Siberia, "like a man buried alive, nailed down in his coffin," for four terrible years. His Siberian experiences are graphically narrated in a volume to which he gave the name of *Recollections of a Dead-House* (1858). It was known in an English translation as *Buried Alive in Siberia* (1881; another version, 1888). His release only subjected him to fresh indignities as a common soldier at Semipalatinsk; but in 1858, through the intercession of an old schoolfellow, General Todleben; he was made an under-officer; and in 1859, upon the accession of Alexander II., he was finally recalled from exile. In 1858 he had married a widow, Madame Isaiev, but she died at St Petersburg in 1867 after a somewhat stormy married life.

After herding for years with the worst criminals, Dostoevsky obtained an exceptional insight into the dark and seamy side of Russian life. He formed new conceptions of human life, of the balance of good and evil in man, and of the Russian character. Psychological studies have seldom, if ever, found a more intense form of expression than that embodied by Dostoevsky in his novel called *Crime and Punishment*. The hero Raskolnikov is a poor student, who is led on to commit a murder partly by self-conceit, partly by the contemplation of the abject misery around him. Unsurpassed in poignancy in the whole of modern literature is the sensation of compassion evoked by the scene between the self-tormented Raskolnikov and the humble street-walker, Sonia, whom he loves, and from whom, having confessed his crime, he derives the idea of expiation. Raskolnikov finally gives himself up to the police and is exiled to Siberia, whither Sonia follows him. The book gave currency to a number of ideas, not in any sense new, but specially characteristic of Dostoevsky: the theory, for instance, that in every life, however fallen and degraded, there are ecstatic moments of self-devotion; the doctrine of purification by suffering, and by suffering alone; and the ideal of a Russian people forming a social state at some future period bound together by no obligation save mutual love and the magic of kindness. In this visionary prospect, as well as in his objection to the use of physical force, Dostoevsky anticipated in a remarkable manner some of the conspicuous tenets of his great successor Tolstoy. The book electrified the reading public in Russia upon its appearance in 1866, and its fame was confirmed when it appeared in Paris in 1867. To his remarkable faculty of awakening reverberations of melancholy and compassion, as shown in his early work, Dostoevsky had added, by the admission of all, a rare mastery over the emotions of terror and pity. But such mastery was not long to remain unimpaired. *Crime and Punishment* was written when he was at the zenith of his power. His remaining works exhibit frequently a marvellous tragic and analytic power, but they are unequal, and deficient in measure and in balance. The chief of them are: *The Injured and the Insulted*, *The Demons* (1867), *The Idiot* (1869), *The Adult* (1875), *The Brothers Karamzov* (1881).

From 1865, when he settled in St Petersburg, Dostoevsky was absorbed in a succession of journalistic enterprises, in the Slavophil interest, and suffered severe pecuniary losses. He had to leave Russia, in order to escape his creditors, and to seek refuge in Germany and Italy. He was further harassed by troubles with his wife, and his work was interrupted by epileptic fits and other physical ailments. It was under such conditions as these that his most enduring works were created. He managed finally to return to Russia early in the seventies, and was for some time director of *The Russian World*. From 1876 he published a kind of review, entitled *Carnet d'un écrivain*, to the pages of which he committed

many strange autobiographical facts and reflections. The last eight years of his life were spent in comparative prosperity at St Petersburg, where he died on the 9th of February 1881.

His life had been irremediably seared by his Siberian experiences. He looked prematurely old; his face bore an expression of accumulated sorrow; in disposition he had become distrustful, taciturn, contemptuous—his favourite theme the superiority of the Russian peasant over every other class; as an artist, though uncultured, he had ever been subtle and sympathetic, but latterly he was tortured by tragic visions and morbidly preoccupied by exceptional and perverted types. M. de Vogüé, in his admirable *Ecrivains russes*, has worked out with some success a parallel between the later years of Dostoevsky and those of Jean Jacques Rousseau. Siberia effectually convinced the novelist of the impotence of Nihilism in such a country as Russia; but though he was assailed by ardent Liberals for the reactionary trend of his later writings, Dostoevsky became, towards the end of his life, an extremely popular figure, and his funeral, on the 12th of February 1881, was the occasion of one of the most remarkable demonstrations of public feeling ever witnessed in the Russian capital. The death of the Russian novelist was not mentioned in the London press; it is only since 1885, when *Crime and Punishment* first appeared in English, that his name has become at all familiar in England, mainly through French translations.

A complete edition of his novels was issued at St Petersburg in fourteen volumes (1882-1883). Two critical studies by Tchij and Zelinsky appeared at Moscow in 1885, and a German life by Hoffmann at Vienna in 1899. (T. Sa.)

DOUAI, a town of northern France, capital of an arrondissement in the department of Nord, 30 m. S. of Lille on the Northern railway between that city and Cambrai. Pop. (1906) town, 21,679; commune, 33,247. Douai is situated in a marshy plain on the banks of the Scarpe which intersects the town from south to north, and supplies water to a canal skirting it on the west. The old fortifications, of which the Porte de Valenciennes (15th century) is the chief survival, have been demolished to make room for boulevards and public gardens. The industrial towns of Dorignies, Sin-le-Noble and Aniche are practically suburbs of Douai. Of the churches, that of Notre-Dame (12th and 14th centuries) is remarkable for the possession of a fine altarpiece of the early 16th century, composed of wooden panels painted by Jean Bellegambe, a native of Douai. The principal building of the town is a handsome hôtel de ville, partly of the 15th century, with a lofty belfry. The Palais de Justice (18th century) was formerly the town house (*refuge*) of the abbey of Marchiennes. Houses of the 16th, 17th and 18th centuries are numerous. There is a statue of Madame Desbordes Valmore, the poet (d. 1859), a native of the town. The municipal museum contains a library of over 85,000 volumes as well as 1800 MSS., and a fine collection of sculpture and paintings. Douai is the seat of a court of appeal, a court of assizes and a subprefect, and has a tribunal of first instance, a board of trade-arbitrators, an exchange, a chamber of commerce and a branch of the Bank of France. Its educational institutions include a lycée, training colleges, a school of mines, an artillery school, schools of music, agriculture, drawing, architecture, &c., and a national school for instruction in brewing and other industries connected with agriculture. In addition to other iron and engineering works, Douai has a large cannon foundry and an arsenal; coal-mining and the manufacture of glass and bottles and chemicals are carried on on a large scale in the environs; among the other industries are flax-spinning, rope-making, brewing and the manufacture of farm implements, oil, sugar, soap and leather. Trade, which is largely water-borne, is in grain and agricultural products, coal and building material.

Douai, the site of which was occupied by a castle (*Castrum Duacense*) as early as the 7th century, belonged in the middle ages to the counts of Flanders, passed in 1384 to the dukes of Burgundy, and so in 1477 with the rest of the Netherlands to Spain. In 1667 it was captured by Louis XIV., and was ultimately ceded to France by the treaty of Utrecht in 1713. Historically Douai is mainly important as the centre of the political and religious propaganda of the exiled English Roman Catholics.

In 1562 Philip II. of Spain founded a university here, in which several English scholars were given chairs; and in connexion with this William Allen (q.v.) in 1568 founded the celebrated English college. It was here that the "Douai Bible" was prepared (see Vol. IV. p. 341). There were also an Irish and a Scots college and houses of English Benedictines and Franciscans. All these survived till 1793, when the university was suppressed. For the Douai Bible see **BIBLE, ENGLISH**.

See F. Brassart, *Hist. du château et de la châtellenie de Douai* (Douai, 1877-87); C. Mine, *Hist. pop. de Douai* (ib. 1861); B. Ward, *Dawn of the Catholic Revival* (London, 1909); Handecqur, *Hist. du Collège anglais, Douai* (Reims, 1898); Daucoisne, *Etablissements britanniques à Douai* (Douai, 1881).

DOUARNENEZ, a fishing-port of western France, in the department of Finistère, on the southern shore of the Bay of Douarnenez 15 m. N.W. of Quimper by rail. Pop. (1906) 13,472. Its sardine fishery, which is carried on from the end of June to the beginning of December, gives occupation to about 800 boats, and between 3000 and 4000 men, and the preserving of the fish is an important industry. Mackerel fishing, boat-building and rope and net making also occupy the inhabitants. There is a lighthouse on the small island of Tristan off Douarnenez.

DOUBLE (from the Mid. Eng. *double*, the form which gives the present pronunciation, through the Old Fr. *double*, from Lat. *duplus*, twice as much), twice as much, or large, having two parts, having a part repeated, coupled, &c. The word appears as a substantive with the special meaning of the appearance to a person of his own apparition, generally regarded as a warning, or of such an apparition of one living person to another, the German *Doppelgänger* (see **APPARITIONS**). Another word often used with this meaning is "fetch." According to the *New English Dictionary*, "fetch" is chiefly of Irish usage, and may possibly be connected with "fetch," to bring or carry away, but it may be a separate word. The Corpus Glossary of the beginning of the 16th century seems to identify a word *facee* with *mare*, meaning a goblin which appears in "nightmare." "Double" is also used of a person whose resemblance to another is peculiarly striking or remarkable, so that confusion between them may easily arise.

DOUBLE BASS (Fr. *contrebasse*; Ger. *Kontrabass*, *Gross Bass* *Geige*; Ital. *contrabasso*, *violone*), the largest member of the modern family of stringed instruments played with a bow, known as the violin family, and the lowest in pitch. The double bass differs slightly in construction from the other members of the family in that it has slanting shoulders (one of the features of the *viola da gamba*, see **VIOLIN**); that is to say that where the belly is joined by the neck and finger-board, it has a decided point, whereas in the violin, viola and violoncello, the finger-board is at right-angles to the horizontal part of a wide curve. It is probable that the shoulders of the double bass were made drooping for the sake of additional strength of construction on account of the strain caused by the tension of the strings. The double bass was formerly made with a flat back—another characteristic of the viol family—whereas now the back is as often found arched as flat. The bow is for obvious reasons shorter and stouter than the violin bow.

The technique of the double bass presents certain difficulties inherent in an instrument of such large proportions. The stretches for the fingers are very great, almost double those required for the violoncello, and owing to the thickness of the strings great force is required to press them against the finger-board when they are vibrating. The performer plays standing owing to the great size of the instrument.

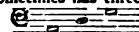
The double bass sometimes has three strings tuned in England and Italy in fourths;  in France and Germany

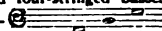
to fifths.  Owing to the scoring of modern composers, however, it was found necessary to adopt an accordance of four strings in order to obtain the additional lower notes required, although this entails the sacrifice of beauty of tone, the three-stringed instrument being more sonorous. Some orchestras make a compromise dividing the double basses into two equal sections of three and four-stringed basses. The four strings are tuned in fourths:— Mr A. C. White, finding that an additional lower compass was required, first tuned his double

¹ The real sounds are an octave lower.

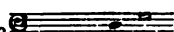
base with three strings to  afterwards adding

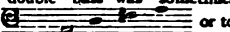
a fourth string, the lower D. By this accordance the third and fourth strings gain additional power and clearness from the fact that the first and second, being their octaves higher, vibrate in sympathy, obviating the necessity of making the 'cello play in octaves with the double basses to increase the tone when the lowest register is used. In order to obtain equal sonority on his double bass with four strings, Mr White² found it necessary to have a wider bridge measuring about 5 in., so that the distance between the strings should remain the same as on a double bass with three strings, thus allowing plenty of room for vibration. The neck was also widened in proportion. A five-stringed double bass was sometimes used in Germany tuned either to  or to

 but such instruments have been almost superseded by those with four strings. A somewhat larger double bass with five strings by Karl Ortho of Leipzig was introduced between 1880 and 1890 with the following accordance:—

 The practical compass of the double bass extends from

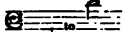
 (real sounds) with all chromatic intervals. In order

to avoid using numerous ledger lines the music is written an octave higher. The quality of tone is very powerful but somewhat rough, and varies greatly in its gradations. The notes of the lowest register, when played *piano*, sound weird and sometimes grotesque, and are sometimes used instead of the kettle-drum; when played *forte* the tone is grand and full. The lowest octave is mainly used as a fundamental octave bass to 'cello, bassoon or trombone. The tone of the *pizzicato* is full and rich owing to the slowness of the vibrations, and it changes character according to the harmonies which lie above it: with a chord of the diminished seventh above it, for instance, the *pizzicato* sounds like a menace, but with the common chord calm and majestic. Both natural and artificial harmonics are possible on the double bass, the former being the best; but they are seldom used in orchestral works. As an instance of their use may be cited the scene by the Nile at the beginning of the third act of Verdi's *Aida*, where harmonics are indicated for both 'cellos and double basses.

The technical capabilities of the double bass are necessarily somewhat more limited than those of the violoncello. Quick passages, though possible, are seldom written for it; they cannot sound clear owing to the time required for the strings to vibrate. An excellent effect is produced by what is known as the *intermittent tremolo*: owing to the elasticity of the bow, it rebounds several times on the strings when a single blow is sharply struck, forming a series of short tremolos. The double bass is the foundation of the whole orchestra and therefore of great importance; it plays the lowest part, often, as its name indicates, only doubling the 'cello part an octave lower. It is only since the beginning of the 19th century that an independent voice has occasionally been allotted to it, as in the Scherzo of Beethoven's Fifth Symphony in C minor:—

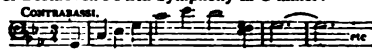

These opening bars are played *soli* by 'cellos and double basses, a daring innovation of Beethoven's which caused quite a consternation at first in musical circles.

The remote origin of the double bass is the same as that of the violin.³ It was evolved from the bass viol; whether the transformation took place simultaneously with that of the violin from the treble viol or preceded it, has not been definitely proved, but both Gasparo da Salo and Maggini constructed double basses, which were in great request in the churches. De Salo made one with three strings for St Mark's, Venice, which is still preserved there.⁴ It was Dragonetti's favourite concert instrument, presented to him by the monks of St Mark, and, according to the desire expressed in his will, the instrument was restored after his death to St Mark's, where it is at present preserved. Dragonetti used a straight bow similar to the violoncello bow, held overhead with the hair slanting towards the neck of the instrument; it

² *The Double Bass* (Novello, *Music Primers*, No. 32), p. 6.

³ See Kathleen Schlesinger, *The Instruments of the Orchestra*, Part II. "The Precursors of the Violin Family" (1908-1909).

⁴ See Laurent Grillet, *Les Ancêtres du violon et du violoncelle* (Paris, 1901), tome ii. p. 159; Willebald Leo von Lustendorff, *Die Geigen und Lautenmacher vom Mittelalter bis zur Gegenwart* (Frankfurt a. M., 1904), p. 50; A. C. White, *The Double Bass*, p. 8.

was introduced into England from Paris, and is a favourite with orchestral players. Praetorius gives an illustration of a sub-bass *sial da gamba* or *gross contra-bass geige*¹ "recently constructed," which displaced the other large contra-bass viols; of which he also gives an illustration.²

Giovanni Bottesini (1822-1889) was the greatest virtuoso on the double bass that the world has ever known. It was not only the perfection of his technique and tone which won him artistic fame, but also the delicacy of his style and his exquisite taste in phrasing. (K. S.)

DOUBLEDAY, ABNER (1819-1893), American soldier, was born at Ballston Spa, New York, on the 26th of June 1819, and graduated from West Point in 1842. He served in the U.S. artillery during the Mexican War, being present at the battles of Monterey and Buena Vista. He was second in command at Fort Sumter, Charleston, South Carolina, when it was bombarded and taken by the Confederates in 1861, and later in the campaign of that year he served in the Shenandoah valley as a field officer. In February 1862 he was made a brigadier-general of volunteers and employed in the lines of Washington. He commanded a division in the Army of the Potomac in the second Bull Run campaign and at Antietam, becoming major-general U.S.V. in November 1862. He continued to command his division in the Fredericksburg and Chancellorsville campaigns, and on the first day of the battle of Gettysburg he led the I. corps, and for a time all the Union forces on the field, after the death of General Reynolds. In the latter part of the war he was employed in various administrative and military posts; in July 1863 he was breveted colonel, and in March 1865 brigadier-general and major-general U.S.A. General Doubleday continued in the army after the war, becoming colonel U.S.A. in 1867; he retired in 1873. He published two important works on the Civil War, *Reminiscences of Fort Sumter and Moudtrie* (1876) and *Chancellorsville and Gettysburg* (1882), the latter being a volume of the series "Campaigns of the Civil War." He died at Mendham, New Jersey, on the 26th of January 1893.

His younger brother, **ULYSSES DOUBLEDAY** (1824-1893), fought through the Civil War as an officer of volunteers, was breveted brigadier-general U.S.V. in March 1865, and commanded a brigade at the battle of Five Forks (1st April).

DOUBLEDAY, THOMAS (1790-1870), English politician and author, was born at Newcastle-on-Tyne in February 1790. In early life he adopted the views of William Cobbett, and was active in promoting the agitation which resulted in the passing of the Reform Bill of 1832. As secretary of the Northern Political Union of Whigs and Radicals he took a prominent part in forwarding the interests of Earl Grey and the reforming party. In 1858-1859 he was a member of the council of the Northern Reform Union; and to the last he was a keen observer of political events. He succeeded his father, George Doubleday, as partner in a firm of soap manufacturers at Newcastle, but devoted his attention rather to literature than to mercantile affairs. On the failure of the firm he obtained the office of registrar of St Andrew's parish, Newcastle, a post which he held until appointed secretary to the coal trade. He died at Bulman's Village, Newcastle-on-Tyne, on the 18th of December 1870. In 1832 Doubleday published an *Essay on Mundane Moral Government*, and in 1842 he attacked some of the principles of Malthus in his *True Law of Population*. He also wrote *A Political Life of Sir Robert Peel* (London, 1856); *A Financial, Statistical and Monetary History of England from 1688* (London, 1847); *Matter for Materialists* (London, 1870); *The Eve of St Mark*, a *Romance of Venice*; and three dramas, *The Statue Wife*, *Diocletian* and *Caius Marius*, in addition to some fishing songs, and many contributions to various newspapers and periodicals.

DOUBLET (a Fr. word, diminutive of *double*, folded or of two thicknesses), a close-fitting garment, with or without sleeves, extending from the neck to a little below the waist, worn by men of all ranks and ages from the 14th century to the time of Charles

II., when it began to be superseded by coat and waistcoat. The doublet was introduced into England from France, and was originally padded for defence or warmth. "Doublet" is also used of a pair or couple—a thing that is the facsimile of another; as in philology, one of two words differing in form, but represented by an identical root, as "alarm" or "alarum"; in optics, of a pair of lenses, combined, for example, to correct aberration. In the work of the lapidary a doublet is a counterfeit gem, made by cementing two pieces of plain glass or crystal on each side of a layer of glass (coloured to represent the stone counterfeited); a thin portion of a genuine stone may be cemented upon an inferior one, as a layer of diamond upon a topaz, or ruby on a garnet.

DOUBS, a river of eastern France, rising in the Jura at the foot of the Noirmont ridge at a height of 3074 ft. and flowing into the Saône. Its course is 269 m. in length, though the distance from its source to its mouth is only 56 m. in direct line; its basin has an area of 3020 sq. m. Flowing N.E. the river traverses the lake of St Point and passes Pontarlier; thenceforth its course lies chiefly through wooded gorges of great grandeur. After skirting the town of Morteau, below which it expands into the picturesque lake of Chaillexon and descends over the Falls of the Doubs (88 ft. in height), the river for about 28 m. forms the frontier between France and Switzerland. Flowing into the latter country for a short distance, it turns abruptly west, then north, and finally at Voujeaucourt, south-west. Just below that town the river is joined by the canal from the Rhone to the Rhine, to accommodate which its course has been canalized as far as Dole. Till it reaches Besançon which lies on a peninsula formed by the river, the Doubs passes no town of importance except Pontarlier. Some distance below Besançon it enters the department of Jura, passes Dole, and leaving the region of hill and mountain, issues into a wide plain. Traversing this, it receives the waters of the Loue, its chief affluent, and broadening out to a width of 260 ft., at length reaches the Saône at Verdun. Below Dole the river is navigable only for some 8 m. above its mouth.

DOUBS, a frontier department of eastern France, formed in 1790 of the ancient principality of Montbéliard and of part of the province of Franche-Comté. It is bounded E. and S.E. by Switzerland, N. by the territory of Belfort and by Haute Saône, and W. and S.W. by Jura. Pop. (1906) 298,438. Area, 2030 sq. m. The department takes its name from the river Doubs, by which it is traversed. Between the Ognon, which forms the north-western limit of the department, and the Doubs, runs a range of low hills known as "the plain." The rest of Doubs is mountainous, four parallel chains of the Jura crossing it from N.E. to S.W. The Lomont range, the lowest of these chains, dominates the left bank of the Doubs. The central region is occupied by hilly plateaux covered with pasturage and forests, while the rest of the department is traversed by the remaining three mountain ranges, the highest and most easterly of which contains the Mont d'Or (4800 ft.), the culminating point of Doubs. Besides the Doubs the chief rivers are its tributaries, the Dessoubre, watering the east of the department, and the Loue, which traverses its south-western portion. The climate is in general cold and rainy, and the winters are severe. The soil is stony and loamy, and at the higher levels there are numerous peat-bogs. Approximately a fifth of the total area is planted with cereals; more than a third is occupied by pasture. In its agricultural aspect the department may be divided into three regions. The highest, on which the snow usually lies from six to eight months in the year, is in part barren, but on its less exposed slopes is occupied by forests of fir trees, and affords good pasturage for cattle. In the second or lower region the oak, beech, walnut and sycamore flourish; and the valleys are susceptible of cultivation. The region of the plain is the most fertile, and produces all kinds of cereals as well as hemp, vegetables, vines and fruit. Cattle-rearing and dairy-farming receive much attention; large quantities of cheese, of the nature of Gruyère, are produced, mainly by the co-operative cheese-factories or *fruitières*. The rivers of the department abound in gorges and falls of great beauty. The most important manufactures are watches, made chiefly at Besançon and Morteau, hardware (Hérimoncourt and Valentigney), and machinery.

¹ M. Praetorius, *Synlogmus music.* (Wolfenbüttel, 1618 and 1620), pp. 54-55 and pl. v. (1).

² *Id.* pl. vi. No. 4.

Large iron foundries are found at Audincourt (pop. 5317) and other towns. The distillation of brandy and absinthe, and the manufacture of cotton and woollen goods, automobiles and paper, are also carried on. Exports include watches, live-stock, wine, vegetables, iron and hardware; cattle, hides, timber, coal, wine and machinery are imported. Large quantities of goods, in transit between France and Switzerland, pass through the department. Among its mineral products are building stone and lime, and there are peat workings. Doubs is served by the Paris-Lyon railway, the line from Dôle to Switzerland passing, via Pontarlier, through the south of the department. The canal from the Rhône to the Rhine traverses it for 84 miles.

The department is divided into the arrondissements of Besançon, Baume-les-Dames, Montbéliard and Pontarlier, with 27 cantons and 637 communes. It belongs to the *académie* (educational circumscription) and the diocese of Besançon, which is the capital, the seat of an archbishop and of a court of appeal, and headquarters of the VII. army corps. Besides Besançon the chief towns are Montbéliard and Pontarlier (qq.v.). Ornans, a town on the Loue, has a church of the 16th century and ruins of a feudal castle, which are of antiquarian interest. Montbenoit on the Doubs near Pontarlier has the remains of an Augustine abbey (13th to 16th centuries). The cloisters are of the 15th century, and the church contains, among other works of art, some fine stalls executed in the 16th century. Lower down the Doubs is the town of Morveau, with the Maison Pertuisier, a house of the Renaissance period, and a church which still preserves remains of a previous structure of the 13th century. Baume-les-Dames owes the affix of its name to a Benedictine convent founded in 763, to which only noble ladies were admitted. Numerous antiquities have been found at Mandeure (near Montbéliard), which stands on the site of the Roman town of *Epomanduodurum*.

DOUCE, FRANCIS (1757-1834), English antiquary, was born in London in 1757. His father was a clerk in Chancery. After completing his education he entered his father's office, but soon quitted it to devote himself to the study of antiquities. He became a prominent member of the Society of Antiquaries, and for a time held the post of keeper of manuscripts in the British Museum, but was compelled to resign it owing to a quarrel with one of the trustees. In 1807 he published his *Illustrations of Shakespeare and Ancient Manners* (2 vols. 8vo), which contained some curious information, along with a great deal of trifling criticism and mistaken interpretation. An unfavourable notice of the work in *The Edinburgh Review* greatly irritated the author, and made him unwilling to venture any further publications. He contributed, however, a considerable number of papers to the *Archæologia* and *The Gentleman's Magazine*. In 1833 he published a *Dissertation on the various Designs of the Dance of Death*, the substance of which had appeared forty years before. He died on the 30th of March 1834. By his will he left his printed books, illuminated manuscripts, coins, &c., to the Bodleian library; his own manuscript works to the British Museum, with directions that the chest containing them should not be opened until the 1st of January 1900; and his paintings, carvings and miscellaneous antiquities to Sir Samuel Meyrick, who published an account of them, entitled *The Doucean Museum*.

DOUGLAS, the name of a Scottish noble family, now represented by the dukes of Hamilton (Douglas-Hamilton, heirs-male), the earls of Home (Douglas-Home) who also bear the title of Baron Douglas of Douglas, the dukes of Buccleuch and Queensberry (Montagu-Douglas-Scott), the earls of Morton (Douglas), the earls of Wemyss (Wemyss-Charteris-Douglas), and the baronets Douglas of Carr, of Springwood, of Glenbervie, &c. The marquessate of Douglas and the earldom of Angus, the historic dignities held by the two chief branches of the family, the Black and the Red Douglas, are merged in the Hamilton peerage. The name represented the Gaelic *dubh glas*, dark water, and Douglasdale, the home of the family in Lanarkshire, is still in the possession of the earls of Home. The first member of the family to emerge with any distinctness was William de Douglas, or Dufglas, whose name frequently appears on charters from 1175 to 1213. He is said to have been brother, or brother-in-law, of

Freakin of Murray, the founder of the house of Murray. His second son, Brice (d. 1222), became bishop of Moray, while the estate fell to the eldest, Sir Archibald (d. c. 1240).

SIR WILLIAM OF DOUGLAS (d. 1298), called "*le hardi*," Archibald's grandson, was the first formally to assume the title of lord of Douglas. After the death of his first wife, Elizabeth, daughter of Alexander the Steward, he abducted from the manor of the La Zouches at Tranent an heiress, Eleanor of Lovain, widow of William de Ferrers, lord of Groby in Leicestershire, who in 1291 appeared by proxy in the court of the English king, Edward I., to answer for the offence of marrying without his permission. He gave a grudging allegiance to John de Baliol, and swore fealty to Edward I. in 1291; but when the Scottish barons induced Baliol to break his bond with Edward I. he commanded at Berwick Castle, which he surrendered after the sack of the town by the English in 1296. After a short imprisonment Douglas was restored to his Scottish estates on renewing his homage to Edward I., but his English possessions were forfeited. He joined Wallace's rising in 1297, and died in 1298, a prisoner in the Tower of London.

His son, **SIR JAMES OF DOUGLAS** (1286-1330), lord of Douglas, called the "Good," whose exploits are among the most romantic in Scottish history, was educated in Paris. On his return he found an Englishman, Robert de Clifford, in possession of his estates. His offer of allegiance to Edward I. being refused, he cast in his lot with Robert Bruce, whom he joined before his coronation at Scone in 1306. From the battle of Methven he escaped with Bruce and the remnant of his followers, and accompanied him in his wanderings in the Highlands. In the next year they returned to the south of Scotland. He twice outwitted the English garrison of Douglas and destroyed the castle. One of these exploits, carried out on Palm Sunday, the 19th of March 1307, with barbarities excessive even in those days, is known as the "Douglas Larder." Douglas routed Sir John de Mowbray at Ederford Bridge, near Kilmarnock, and was entrusted with the conduct of the war in the south, while Bruce turned to the Highlands. In 1308 he captured Thomas Randolph (afterwards earl of Moray), soon to become one of Bruce's firm supporters, and a friendly rival of Douglas, whose exploits he shared. He made many successful raids on the English border, which won for him the dreaded name of the "Black Douglas" in English households. Through the capture of Roxburgh Castle in 1314 by stratagem, the assailants being disguised as black oxen, he secured Teviotdale; and at Bannockburn, where he was knighted on the battlefield, he commanded the left wing with Walter the Steward. During the thirteen years of intermittent warfare that followed he repeatedly raided England: He slew Sir Robert de Nevill, the "Peacock of the North," in single combat in 1316, and in 1319 he invaded Yorkshire, in company with Randolph, defeating an army assembled by William de Melton, archbishop of York, at Mitton-on-Swale (September 20), in a fight known as "The Chapter of Myton." In 1322 he captured the pass of Byland in Yorkshire, and forced the English army to retreat. He was rewarded by the "Emerald Charter," granted by Bruce, which gave him criminal jurisdiction over the family estates, and released the lords of Douglas from various feudal obligations. The emerald ring which Bruce gave Douglas in ratification of the charter is lost, but another of the king's gifts, a large two-handed sword (bearing, however, a later inscription), exists at Douglas Castle. In a daring night attack on the English camp in Weardale in 1327 Douglas came near capturing Edward III. himself. After laying waste the northern counties he retreated, without giving battle to the English. Before his death in 1330 Bruce desired Douglas to carry his heart to Palestine in redemption of his unfulfilled vow to go on crusade. Accordingly Sir James set out in 1330, bearing with him a silver casket containing the embalmed heart of Bruce. He fell fighting with the Moors in Spain on the 25th of August of that year, and was buried in St Bride's Church, Douglas. Since his day the Douglasses have borne a human heart in their coat of arms. Sir James was said to have fought in seventy battles and to have conquered in fifty-seven. His exploits, as told in Froissart's *Chronicles* and in John

Barbour's *Bruce*, are familiar from Scott's *Tales of a Grandfather* and *Castle Dangerous*. His half-brother, Sir Archibald, defeated Edward Baliol at Annan in 1332, and had just been appointed regent of Scotland for David II. when he risked a pitched battle at Halidon Hill, where he was defeated and killed (1333), with his nephew William, lord of Douglas. The inheritance fell to his brother, a churchman, Hugh the "Dull" (b. 1294), who surrendered his lands to David II.; and a re-grant was made to William Douglas, next referred to.

WILLIAM DOUGLAS, 1ST EARL OF DOUGLAS (c. 1327-1384), had been educated in France, and returned to Scotland in 1348. In 1353 he killed in Ettrick Forest his kinsman, William, the knight of Liddesdale (c. 1300-1353), known as the "Flower of Chivalry," who had been warden of the western marches during David II.'s minority, and had taken a heroic share in driving the English from southern Scotland. Liddesdale had in 1342 lost the king's favour by the murder of Sir Alexander Ramsay of Dalhousie, whom David had made constable of the castle of Roxburgh and sheriff of Teviotdale in his place; he was taken prisoner at Nevill's Cross in 1346, and only released on becoming liegeman of Edward III. for the lands of Liddesdale and the castle of the Hermitage; Liddesdale¹ was also accused of contriving the murder of Sir David Barclay in 1350. Some of his lands fell to his kinsman and murderer, who was created earl of Douglas in 1358. In 1357 his marriage with Margaret, sister and heiress of Thomas, 13th earl of Mar, eventually brought him the estates and the earldom of Mar. During a short truce with the warden of the English marches he had served in France, being wounded at Poitiers in 1356. He was one of the securities for the payment of David II.'s ransom, and in consequence of the royal misappropriation of some moneys raised for this purpose Douglas was for a short time in rebellion in 1363. In 1364 he joined David II. in seeking a treaty with England which should deprive Robert the Steward, formerly an ally of Douglas, of the succession by putting an English prince on the Scottish throne. The independence of Scotland was to be guaranteed, and a special clause provided for the restoration of the English estates of the Douglas family. On the accession of Robert II. he was nevertheless reconciled, becoming justiciar of southern Scotland, and the last years of his life were spent in making and repelling border raids. He died at Douglas in May 1384, and was succeeded by his son James. By his wife's sister-in-law, Margaret Stewart, countess of Angus in her own right, and widow of the 13th earl of Mar, he had a son George, afterwards 1st earl of Angus.

JAMES, 2ND EARL OF DOUGLAS AND MAR (c. 1358-1388), married Lady Isabel Stewart, daughter of Robert II. In 1385 he made war on the English with the assistance of a French contingent under John de Vienne. He allowed the English to advance to Edinburgh, wisely refusing battle, and contented himself with a destructive counter-raid on Carlisle. Disputes soon arose between the allies, and the French returned home at the end of the year. In 1388 Douglas captured Hotspur Percy's pennon in a skirmish near Newcastle. Percy sought revenge in the battle of Otterburn (August 1388), which ended in a victory for the Scots and the capture of Hotspur and his brother, though Douglas fell in the fight. The struggle, narrated by Froissart, is celebrated in the English and Scottish ballads called "Chevy Chase" and "The Battle of Otterburn." Sir Philip Sidney "never heard the old song of Percy and Douglas that I found not my heart moved more than with a trumpet" (*Apologie for Poetrie*). The 2nd earl left no legitimate male issue. His natural sons William and Archibald became the ancestors of the families of Douglas of

¹ A descendant of a younger son of the original William de Douglas.

² On the murder of the knight of Liddesdale, his lands, with the exception of Liddesdale and the Hermitage (forfeited to the crown and then secured by his nephew, fell to his nephew, Sir James Douglas of Dalkeith and Aberdour (d. 1420), whose great-grandson James Douglas, 3rd Lord Dalkeith (d. 1504), became earl of Morton in 1458 on his marriage with Lady Joan Stewart, third daughter of James I. His grandson, the 3rd earl, left daughters only, of whom the eldest, Margaret, married James Hamilton, earl of Arran, regent of Scotland, ancestor of the dukes of Hamilton; Elizabeth married in 1543 James Douglas, who became by this marriage 4th earl of Morton.

Drumlanrig (see QUEENSBERRY) and Douglas of Cavers. His sister Isabel became countess of Mar, inheriting the lands of Mar and his unentailed estates.

The earldom and entailed estates of Douglas reverted by the patent of 1358 to ARCHIBALD DOUGLAS, 3RD EARL OF DOUGLAS, called "The Grim" (c. 1328-c. 1400), a natural son of the "good" Sir James. With his cousin, the 1st earl of Douglas, he had fought at Poitiers, where he was taken prisoner, but was released through ignorance of his real rank. On his return to Scotland he became constable and sheriff of Edinburgh, and, later, warden of the western marches, where his position was strengthened by his becoming lord of Galloway in 1369 and by his purchase of the earldom of Wigton in 1372. He further increased his estates by his marriage with Joanna Moray, heiress of Bothwell. During the intervals of war with the English he imposed feudal law on the border chieftains, drawing up a special code for the marches. He was twice sent on missions to the French court. The power of the Black Douglas overshadowed the crown under the weak rule of Robert III., and in 1399 he arranged a marriage between David, duke of Rothesay, the king's son and heir, and his own daughter, Marjory Douglas. Rothesay was already contracted to marry Elizabeth Dunbar, daughter of the earl of March, who had paid a large sum for the honour. March, alienated from his allegiance by this breach of faith on the king's part, now joined the English forces. A natural son of Archibald, Sir William of Douglas, lord of Nithisdale (d. 1392), married Egidia, daughter of Robert III.

Archibald the Grim was succeeded by his eldest son, ARCHIBALD, 4TH EARL OF DOUGLAS, 1st duke of Touraine, lord of Galloway and Annandale (1372-1424), who married in 1390 Lady Margaret Stewart, eldest daughter of John, earl of Carrick, afterwards King Robert III. In 1400 March and Hotspur Percy had laid waste eastern Scotland as far as Lothian when they were defeated by Douglas (then master of Douglas) near Preston. With the regent, Robert, duke of Albany, he was suspected of complicity in the murder (March 1402) of David, duke of Rothesay, who was in their custody at Falkland Castle, but both were officially declared guiltless by the parliament. In that year Douglas raided England and was taken prisoner at Homildon Hill by the Percys. He fought on the side of his captors at Shrewsbury (1403), and was taken prisoner by the English king Henry IV. He became reconciled during his captivity with the earl of March, whose lands had been conferred on Douglas, but were now, with the exception of Annandale, restored. He returned to Scotland in 1409, but was in constant communication with the English court for the release of the captive king James I. In 1412 he had visited Paris, when he entered into a personal alliance with John the Fearless, duke of Burgundy, and in 1423 he commanded a contingent of 10,000 Scots sent to the help of Charles VII. against the English. He was made lieutenant-general in the French army, and received the peerage-duchy of Touraine with remainder to his heirs-male. The new duke was defeated and slain at Verneuil (1424) with his second son, James; his persistent ill-luck earned him the title of the Tyneman (the loser).

ARCHIBALD, 5TH EARL OF DOUGLAS (c. 1391-1439), succeeded to his father's English and Scottish honours, though he never touched the revenues of Touraine. He fought at Baugé in 1421, and was made count of Longueville in Normandy.

His two sons, WILLIAM, 6TH EARL (1423?-1440), and David, were little more than boys at the time of their father's death in 1439. They can hardly have been guilty of any real offence when, on the 24th of November 1440, they were summoned to court by Sir William Crichton, lord chancellor of Scotland, and, after a mock trial in the young king's presence, were beheaded forthwith in the courtyard of Edinburgh Castle. This murder broke up the dangerous power wielded by the Douglases. The lordships of Annandale and Bothwell fell to the crown; Galloway to the earl's sister Margaret, the "Fair Maid of Galloway"; while the Douglas lands passed to his great-uncle JAMES DOUGLAS, 7TH EARL OF DOUGLAS, called the "Gross," of Balvany (1371-1444), lord of Abercorn and Aberdour, earl of Avondale (cr. 1437), younger son of the 3rd earl.

The latter's sons, WILLIAM (c. 1425-1452) and JAMES (1426-

1488), became 8th and 9th earls respectively; Archibald became earl of Moray by marriage with Elizabeth Dunbar, daughter and co-heiress of James, earl of Moray; Hugh was created earl of Ormond in 1445; John was lord of Balvany; Henry became bishop of Dunkeld.

The power of the Black Douglases was restored by the 8th earl, who recovered Wigtown, Galloway and Bothwell by marriage (by papal dispensation) with his cousin, the Fair Maid of Galloway. He was soon high in favour with James II., and procured the disgrace of Crichton, his kinsmen's murderer, by an alliance with his rival, Sir Alexander Livingstone. In 1450 James raided the earl's lands during his absence on a pilgrimage to Rome; but their relations seemed outwardly friendly until in 1452 the king invited Douglas to Stirling Castle under a safe-conduct, in itself, however, a proof of strained relations. There James demanded the dissolution of a league into which Douglas had entered with Alexander Lindsay, the "Tiger" earl (4th) of Crawford. On Douglas's refusal the king murdered him (February 22) with his own hands, the courtiers helping to despatch him. The tales of the hanging of Sir Herbert Herries of Terregles and the murder of McLellan of Bombie by Douglas rest on no sure evidence.

JAMES DOUGLAS, 9TH EARL (and last), denounced his brother's murderers and took up arms, but was obliged by the desertion of his allies to submit. He obtained a papal dispensation to marry his brother's widow, in order to keep the family estates together. He intrigued with the English court, and in 1455 rebelled once more. Meanwhile another branch of the Douglas family, known as the Red Douglas, had risen into importance (see ANGUS, EARLS OR), and George Douglas, 4th earl of Angus (d. 1463), great-grandson of the 1st earl of Douglas, took sides with the king against his kinsmen. James Douglas, again deserted by his chief allies, fled to England, and his three brothers, Ormond, Moray and Balvany, were defeated by Angus at Arkinholm on the Esk. Moray was killed, Ormond taken prisoner and executed, while Balvany escaped to England. Their last stronghold, the Thrieve in Galloway, fell, and the lands of the Douglases were declared forfeit, and were divided among their rivals, the lordship of Douglas falling to the Red Douglas, 4th earl of Angus. In England the earl of Douglas intrigued against his native land; he was employed by Edward IV. in 1461 to negotiate a league with the western highlanders against the Scottish kingdom. In 1484 he was taken prisoner while raiding southern Scotland, and was relegated to the abbey of Lindores, where he died in 1488.

The title of Douglas was restored in 1633 when WILLIAM, 11th earl of Angus (1589-1660), was created 1ST MARQUESS OF DOUGLAS by Charles I. In 1645 he joined Montrose at Philiphaugh, and was imprisoned in 1646 at Edinburgh Castle, only obtaining his release by signing the Covenant. His eldest son, Archibald, created earl of Ormond, Lord Bothwell and Hartside, in 1651, predeceased his father; Lord James Douglas (c. 1617-1645) and his half-brother, Lord George Douglas (c. 1636-1692), created earl of Dumbarton in 1675, successively commanded a Scots regiment¹ in the French service. William (1635-1694), created earl of Selkirk in 1646, became 3rd duke of Hamilton after his marriage (1656) with Anne, duchess of Hamilton in her own right. By the failure of heirs in the elder branches of the family the dukes of Hamilton (q.v.) became heirs-male of the house of Douglas.

JAMES DOUGLAS, 2ND MARQUESS OF DOUGLAS (1646-1700), succeeded his grandfather in 1660. His eldest son, John, by courtesy earl of Angus, raised a regiment of 1200 men, first known as the Angus regiment, later as the Cameronians (26th Foot). He was killed at its head at Steinkirk in 1692. The younger son, ARCHIBALD, 3RD MARQUESS (1694-1761), was created duke of Douglas in 1703, but the dukedom became extinct on his death, without heirs, in 1761. He was a consistent supporter of the Hanoverian cause, and fought at Sheriffmuir. The heir-presumptive to the Douglas estates was his sister, Lady Jane Douglas (1698-1753), who in 1746 secretly married Colonel, afterwards Sir, John Stewart of Grandtully, by whom she had twin sons, born

¹ Transferred to the British service in 1669 and eventually known as the Royal Scots regiment.

in Paris in 1748. These children were alleged to be spurious, and when Lady Jane and the younger of the two boys died in 1753, the duke refused to acknowledge the survivor as his nephew; but in 1760 he was induced, under the influence of his wife, to revoke a will devising the estates to the Hamiltons in favour of Lady Jane's son, Archibald James Edward Steuart (1748-1827), 1st baron Douglas of Douglas (cr. 1790) in the British peerage. The inheritance of the estates was disputed by the Hamiltons, representing the male line, but the House of Lords decided in favour of Douglas in 1769. Three of his sons succeeded Archibald Douglas as Baron Douglas, but as they left no male issue the title passed to the earls of Home, Cospatrick Alexander, 11th earl of Home, having married a granddaughter of Archibald, 1st Baron Douglas. Their descendants, the earls of Home, represent the main line of Douglas on the female side.

AUTHORITIES.—David Hume of Godscroft (1560?-1630), who was secretary to Archibald Douglas, 8th earl of Angus, wrote a *History of the House and Race of Douglas and Angus*, printed under his daughter's superintendence (Edinburgh, 1644). He was a partial historian, and his account can only be accepted with caution. Modern authorities are Sir William Fraser, *The Douglas Book* (4 vols., Edinburgh, 1885), and Sir H. Maxwell, *History of the House of Douglas* (2 vols., 1902). See also G. E. C[okayne]'s *Peerage, and Douglas's Scots Peerage; Calendar of State Papers, Scottish Series, The Hamilton Papers, &c.*

DOUGLAS, SIR CHARLES, Bart. (d. 1789), British admiral, a descendant of the Scottish earls of Morton, was promoted lieutenant in the navy on the 4th of December 1753. Nothing is known of his early life. He became commander on the 24th of February 1759, and attained to post rank in 1761. When the War of American Independence began, he took an active part in the defence of Canada in 1775, and he afterwards commanded the "Stirling Castle" 64 in the battle of the Ushant, 27th of July 1778. His reputation is based first on the part he played in the battle of Dominica, 12th of April 1782, and then on the improvements in gunnery which he introduced into the British navy. It appears from the testimony of Sir F. Thesiger (d. 1805), who was present on the quarter-deck of the flagship, that Sir Charles Douglas, who was then captain of the fleet, first pointed out to Rodney the possibility and the advantage of passing through the French line. His advice was taken with reluctance. On the other hand, Lord Hood accuses Douglas of living in such abject fear of his admiral that he did not venture to speak with the freedom which his important post entitled him to take. His more certain claim to be ranked high among naval officers is founded on the many improvements he introduced into naval gunnery. Some account of these will be found in the writings of his son. He became rear-admiral on the 24th of September 1787, and died suddenly of apoplexy in February 1789. He was made a baronet for his services in the West Indies.

There is a life of Sir Charles Douglas in Charnock, *Biogr. Nav.* vi. 427.

DOUGLAS, GAVIN (1474?-1522), Scottish poet and bishop, third son of Archibald, 5th earl of Angus (called the "great earl of Angus" and "Bell-the-Cat"), was born c. 1474, probably at one of his father's seats. He was a student at St Andrews, 1489-1494, and thereafter, it is supposed, at Paris. In 1496 he obtained the living of Monymusk, Aberdeenshire, and later he became parson of Lynton (*mod.* Linton) and rector of Hauch (*mod.* Prestonkirk), in East Lothian; and about 1501 was preferred to the deanery or provostship of the collegiate church of St Giles, Edinburgh, which he held with his parochial charges. From this date till the battle of Flodden, in September 1513, he appears to have been occupied with his ecclesiastical duties and literary work. Indeed all the extant writings by which he has earned his place as a poet and translator belong to this period. After the disaster at Flodden he was completely absorbed in public business. Three weeks after the battle he, still provost of St Giles, was admitted a Burgess of Edinburgh, his father, the "Great Earl," being then civil provost of the capital. The latter dying soon afterwards (January 1514) in Wigtownshire, where he had gone as justiciar, and his son having been killed at Flodden, the succession fell to Gavin's nephew Archibald (6th earl). The marriage of this youth to James IV.'s widow on the 6th of August 1514 did much to

identify the Douglases with the English party in Scotland, as against the French party led by Albany, and incidentally to determine the political career of his uncle Gavin. During the first weeks of the queen's sorrow after the battle, Gavin, with one or two colleagues of the council, acted as personal adviser, and it may be taken for granted that he supported the pretensions of the young earl. His own hopes of preferment had been strengthened by the death of many of the higher clergy at Flodden. The first outcome of the new connexion was his appointment to the abbacy of Aberbrothock by the queen regent, before her marriage, probably in June 1514. Soon after the marriage she nominated him archbishop of St Andrews, in succession to Elphinstone, archbishop-designate. But Hepburn, prior of St Andrews, having obtained the vote of the chapter, expelled him, and was himself in turn expelled by Forman, bishop of Moray, who had been nominated by the pope. In the interval, Douglas's rights in Aberbrothock had been transferred to James Beaton, archbishop of Glasgow, and he was now without title or temporality. The breach between the queen's party and Albany's had widened, and the queen's advisers had begun an intrigue with England, to the end that the royal widow and her young son should be removed to Henry's court. In those deliberations Gavin Douglas took an active part, and for this reason stimulated the opposition which successfully thwarted his preferment.

In January 1515 on the death of George Brown, bishop of Dunkeld, Douglas's hopes revived. The queen nominated him to the see, which he ultimately obtained, though not without trouble. For the earl of Athole had forced his brother, Andrew Stewart, prebendary of Craig, upon the chapter, and had put him in possession of the bishop's palace. The queen appealed to the pope and was seconded by her brother of England, with the result that the pope's sanction was obtained on the 18th of February 1515. Some of the correspondence of Douglas and his friends incident to this transaction was intercepted. When Albany came from France and assumed the regency, these documents and the "purchase" of the bishopric from Rome contrary to statute were made the basis of an attack on Douglas, who was imprisoned in Edinburgh Castle, thereafter in the castle of St Andrews (under the charge of his old opponent, Archbishop Hepburn), and later in the castle of Dunbar, and again in Edinburgh. The pope's intervention procured his release, after nearly a year's imprisonment. The queen meanwhile had retired to England. After July 1516 Douglas appears to have been in possession of his see, and to have patched up a diplomatic peace with Albany.

On the 17th of May 1517 the bishop of Dunkeld proceeded with Albany to France to conduct the negotiations which ended in the treaty of Rouen. He was back in Scotland towards the end of June. Albany's longer absence in France permitted the party-faction of the nobles to come to a head in a plot by the earl of Arran to seize the earl of Angus, the queen's husband. The issue of this plot was the well-known fight of "Clear-the-Causeway," in which Gavin Douglas's part stands out in picturesque relief. The triumph over the Hamiltons had an unsettling effect upon the earl of Angus. He made free of the queen's rents and abducted Lord Traquair's daughter. The queen set about to obtain a divorce, and used her influence for the return of Albany as a means of undoing her husband's power. Albany's arrival in November 1521, with a large body of French men-at-arms, compelled Angus, with the bishop and others, to flee to the Borders. From this retreat Gavin Douglas was sent by the earl to the English court, to ask for aid against the French party and against the queen, who was reported to be the mistress of the regent. Meanwhile he was deprived of his bishopric, and forced, for safety, to remain in England, where he effected nothing in the interests of his nephew. The declaration of war by England against Scotland, in answer to the recent Franco-Scottish negotiations, prevented his return. His case was further complicated by the libellous animosity of Beaton, archbishop of St Andrews (whose life he had saved in the "Clear-the-Causeway" incident), who was anxious to thwart his election to the archbishopric of St Andrews, now vacant by the death of Forman. In 1522 Douglas

was stricken by the plague which raged in London, and died at the house of his friend Lord Dacre. During the closing years of exile he was on intimate terms with the historian Polydore Vergil, and one of his last acts was to arrange to give Polydore a corrected version of Major's account of Scottish affairs. Douglas was buried in the church of the Savoy, where a monumental brass (removed from its proper site after the fire in 1864) still records his death and interment.

Douglas's literary work, now his chief claim to be remembered, belongs, as has been stated, to the period 1501-1513, when he was provost of St Giles. He left four poems.

1. *The Palace of Honour*, his earliest work, is a piece of the later type of dream-allegory, extending to over 2000 lines in nine-lined stanzas. In its descriptions of the various courts on their way to the palace, and of the poet's adventures—first, when he incautiously slanders the court of Venus, and later when after his pardon he joins in the procession and passes to see the glories of the palace—the poem carries on the literary traditions of the courts of love, as shown especially in the "Romaunt of the Rose" and "The Hous of Fame." The poem is dedicated to James IV., not without some lesson in commendation of virtue and honour. No MS. of the poem is extant. The earliest known edition (c. 1553) was printed at London by William Copland; an Edinburgh edition, from the press of Henry Charteris, followed in 1579. From certain indications in the latter and the evidence of some odd leaves discovered by David Laing, it has been concluded that there was an earlier Edinburgh edition, which has been ascribed to Thomas Davidson, printer, and dated c. 1540.

2. *King Harl* is another example of the later allegory, and, as such, of higher literary merit. Its subject is human life told in the allegory of King Heart in his castle, surrounded by his five servitors (the senses), Queen Plesance, Foresight and other courtiers. The poem runs to over 900 lines and is written in eight-lined stanzas. The text is preserved in the Maitland folio MS. in the Pepysian library, Cambridge. It is not known to have been printed before 1786, when it appeared in Pinkerton's *Ancient Scottish Poems*.

3. *Conscience* is in four seven-lined stanzas. Its subject is the "conceit" that men first clipped away the "con" from "conscience" and left "science" and "na mair." Then they lost "sci," and had nothing but "ens" ("that schrew, Riches and geir").

4. Douglas's longest, last, and in some respects most important work is his translation of the *Aeneid*, the first version of a great classic poet in any English dialect. The work includes the thirteenth book by Mæneus Vegius; and each of the thirteen books is introduced by a prologue. The subjects and styles of these prologues show great variety: some appear to be literary exercises with little or no connexion with the books which they introduce, and were perhaps written earlier and for other purposes. In the first, or general, prologue, Douglas claims a higher position for Virgil than for his master Chaucer, and attacks Caxton for his inadequate rendering of a French translation of the *Aeneid*. That Douglas undertook this work and that he makes a plea for more accurate scholarship in the translation have been the basis of a prevalent notion that he is a Humanist in spirit and the first exponent of Renaissance doctrine in Scottish literature. Careful study of the text will not support this view. Douglas is in all important respects even more of a medievalist than his contemporaries; and, like Henryson and Dunbar, strictly a member of the allegorical school and a follower, in the most generous way, of Chaucer's art. There are several early MSS. of the *Aeneid* extant: (a) in the library of Trinity College, Cambridge, c. 1525, (b) the Elphinstoun MS. in the library of the university of Edinburgh, c. 1525, (c) the Ruthven MS. in the same collection, c. 1535, (d) in the library of Lambeth Palace, 1545-1546. The first printed edition appeared in London in 1553. An Edinburgh edition was issued from the press of Thomas Ruddiman in 1710.

For Douglas's career see, in addition to the public records and general histories, Bishop Sage's *Life* in Ruddiman's edition, and that by John Small in the first volume of his edition of the *Works of Gavin*

Douglas (4 vols., 1874, the only collected edition of Douglas's works). A new edition of the texts is much to be desired. On Douglas's place in Scottish literature see SCOTLAND: *Scottish Literature*, also G. Gregory Smith's *Transition Period* (1900) and chapters in the *Cambridge History of English Literature*, vol. ii. (1908). P. Lange's dissertation *Chaucer's Einfluss auf die Originaldichtungen des Schotten Gavin Douglas* (Halle, 1882) draws attention to Douglas's indebtedness to Chaucer. Further discussion of the question of Douglas's alleged Humanism will be found in Courthope's *History of English Poetry*, i. (1895), T. F. Henderson's *Scottish Vernacular Literature* (1898), and J. H. Millar's *Literary History of Scotland* (1903). For the language of the poems see G. Gregory Smith's *Specimens of Middle Scots* (1902). (G. G. S.)

DOUGLAS, SIR HOWARD, Bart. (1776–1861), British general, younger son of Admiral Sir Charles Douglas, was born at Gosport in 1776, and entered the Royal Military Academy in 1790. He was commissioned second lieutenant in the Royal Artillery in 1794, becoming first lieutenant a few months later. In 1795 he was shipwrecked while in charge of a draft for Canada, and lived with his men for a whole winter on the Labrador coast. Soon after his return to England in 1799 he was made a captain-lieutenant, and in the same year he married. In his regimental service during the next few years, he was attached to all branches of the artillery in succession, becoming captain in 1804, after which he was placed on half-pay to serve at the Royal Military College. Douglas was at this time (1804) appointed to a majority in the York Rangers, a corps immediately afterwards reduced, and he remained on the roll of its officers until promoted major-general. The senior department of the R.M.C. at High Wycombe, of which he was in charge, was the forerunner of the Staff College. Douglas, since 1806 a brevet lieutenant-colonel, served in 1808–1809 in the Peninsula and was present at Corunna, after which he took part in the Walcheren expedition. In 1809 he succeeded to the baronetcy on the death of his half-brother, Vice-admiral Sir William Henry Douglas. In 1812 he was employed in special missions in the north of Spain, and took part in numerous minor operations in this region, but he was soon recalled, the home government deeming his services indispensable to the Royal Military College. He became brevet colonel in 1814 and C.B. in 1815. In 1816 appeared his *Essay on the Principles and Construction of Military Bridges* (subsequent editions 1832, 1853); in 1819, *Observations on the Motives, Errors and Tendency of M. Carnot's System of Defence*, and in the following year his *Treatise on Naval Gunnery* (of which numerous editions and translations appeared up to the general introduction of rifled ordnance). In 1821 he was promoted major-general. Douglas's criticisms of Carnot led to an important experiment being carried out at Woolwich in 1822, and his *Naval Gunnery* became a standard text-book, and indeed first drew attention to the subject of which it treated. From 1823 to 1831 Sir Howard Douglas was governor of New Brunswick, and, while there, he had to deal with the Maine boundary dispute of 1828. He also founded Fredericton College, of which he was the first chancellor. On his return to Europe he was employed in various missions, and he published about this time *Naval Evolutions*, a controversial work dealing with the question of "breaking the line" (London, 1832). From 1835 to 1840 Douglas, now a G.C.M.G., was lord high commissioner of the Ionian Islands, where, amongst other reforms, he introduced a new code of laws. In 1837 he became a lieutenant-general, in 1840 a K.C.B., in 1841 a civil G.C.B., and in 1851 a general. From 1842 to 1847 Douglas sat in parliament, where he took a prominent part in debates on military and naval matters and on the corn laws. He was frequently consulted on important military questions. His later works included *Observations on the Modern System of Fortification, &c.* (London, 1859), and *Naval Warfare Under Steam* (London, 1858 and 1860). He died on the 9th of November 1861 at Tunbridge Wells. Sir Howard Douglas was a F.R.S., one of the founders of the R.G.S., and an honorary D.C.L. of Oxford University. Shortly before his death he declined the offer of a military G.C.B.

See S. W. Fullom, *Life of Sir Howard Douglas* (London, 1862), and *Gentleman's Magazine*, 3rd series, xii. 90–92.

DOUGLAS, JOHN (1721–1807), Scottish man of letters and Anglican bishop, was the son of a small shopkeeper at Pittenweem, Fife, where he was born on the 14th of July 1721. He was

educated at Dunbar and at Balliol College, Oxford, where he took his M.A. degree in 1743, and as chaplain to the 3rd regiment of foot guards he was at the battle of Fontenoy, 1745. He then returned to Balliol as a Snell exhibitor; became vicar of High Erroll, Shropshire, in 1750; canon of Windsor, 1762; bishop of Carlisle, 1787 (and also dean of Windsor, 1788); bishop of Salisbury, 1791. Other honours were the degree of D.D., 1758, and those of F.R.S. and F.S.A. in 1778. Douglas was not conspicuous as an ecclesiastical administrator, preferring to his livings the delights of London in winter and the fashionable watering-places in summer. Under the patronage of the earl of Bath he entered into a good many literary controversies, vindicating Milton from W. Lauder's charge of plagiarism (1750), attacking David Hume's rationalism in his *Criterion of Miracles* (1752), and the Hutchinsonians in his *Apology for the Clergy* (1755). He also edited Captain Cook's *Journals*, and Clarendon's *Diary and Letters* (1763). He died on the 18th of May 1807, and a volume of *Miscellaneous Works*, prefaced by a short biography, was published in 1820.

DOUGLAS, STEPHEN ARNOLD (1813–1861), American statesman, was born at Brandon, Vermont, on the 23rd of April 1813. His father, a physician, died in July 1813, and the boy was under the care of a bachelor uncle until he was fourteen, when his uncle married and Douglas was thrown upon his own resources. He was apprenticed to a cabinetmaker in Middlebury, Vt., and then to another in Brandon, but soon abandoned this trade. He attended schools at Brandon and Canandaigua (N.Y.), and began the study of law. In 1833 he went West, and finally settled in Jacksonville, Illinois, where he was admitted to the bar in March 1834, and obtained a large practice. From the first he took an active interest in politics, identifying himself with the Jackson Democrats, and his rise was remarkably rapid even for the Middle West of that period. In February 1835 he was elected public prosecutor of the first judicial circuit, the most important at that time in Illinois; in 1835 he was one of several Democrats in Morgan county to favour a state Democratic convention to elect delegates to the national convention of 1836—an important move toward party regularity; in December 1836 he became a member of the state legislature. In 1837 he was appointed by President Van Buren registrar of the land office at Springfield, which had just become the state capital. In 1840 he did much to carry the state for Van Buren; and for a few months he was secretary of state of Illinois. He was a judge of the supreme court of Illinois from 1841 to 1843. In 1843 he was elected to the national House of Representatives.

In Congress, though one of the youngest members, he at once sprang into prominence by his clever defence of Jackson during the consideration by the House of a bill remitting the fine imposed on Jackson for contempt of court in New Orleans. He was soon recognized as one of the ablest and most energetic of the Democratic leaders. An enthusiastic believer in the destiny of his country and more especially of the West, and a thorough-going expansionist, he heartily favoured in Congress the measures which resulted in the annexation of Texas and in the Mexican War—in the discussion of the annexation of Texas he suggested as early as 1845 that the states to be admitted should come in slave or free, as their people should vote when they applied to Congress for admission, thus foreshadowing his doctrine of "Popular Sovereignty." He took an active share in the Oregon controversy, asserting his unalterable determination, in spite of President Polk's faltering on the declaration of his party's platform, not to "yield up one inch" of the territory to Great Britain, and advocating its occupation by a military force. Indeed he consistently regarded Great Britain as the natural and foremost rival of the United States, the interests of the two nations, he thought, being always opposed, and few senators fought more vigorously the Clayton-Bulwer Treaty or Great Britain's reassertion of the right of search on the high seas. He ardently supported the policy of making Federal appropriations (of land, but not of money) for internal improvements of a national character, being a prominent advocate of the construction, by government aid, of a trans-continental railway,

and the chief promoter (1850) of the Illinois Central; in 1854 he suggested that Congress should impose tonnage duties from which towns and cities might themselves pay for harbour improvement, &c. To him as chairman of the committee on territories, at first in the House, and then in the Senate, of which he became a member in December 1847, it fell to introduce the bills for admitting Texas, Florida, Iowa, Wisconsin, Minnesota, California and Oregon into the Union, and for organizing the territories of Minnesota, Oregon, New Mexico, Utah, Washington, Kansas and Nebraska. In 1848 he introduced a bill proposing that all the territory acquired from Mexico should be admitted into the Union as a single state, and upon the defeat of this bill proposed others providing for the immediate admission of parts of this territory.

In the bitter debates concerning the keenly disputed question of the permission of slavery in the territories, Douglas was particularly prominent. Against slavery itself he seems never to have had any moral antipathy; he married (1847) the daughter¹ of a slaveholder, Colonel Robert Martin of North Carolina, and a cousin of Douglas's colleague in Congress, D. S. Reid; and his wife and children were by inheritance the owners of slaves, though he himself never was. He did more probably than any other one man, except Henry Clay, to secure the adoption of the Compromise Measures of 1850. In 1849 the Illinois legislature demanded that its representatives and senators should vote for the prohibition of slavery in the Mexican cession, but next year this sentiment in Illinois had grown much weaker, and, both there and in Congress, Douglas's name was soon to become identified with the so-called "popular sovereignty" or "squatter sovereignty" theory, previously enunciated by Lewis Cass, by which each territory was to be left to decide for itself whether it should or should not have slavery. In 1850 his power of specious argument won back to him his Chicago constituents who had violently attacked him for not opposing the Fugitive Slave Law.

The bill for organizing the territories of Kansas and Nebraska, which Douglas reported in January 1854 and which in amended form was signed by the president on the 30th of May, reopened the whole slavery dispute—wantonly, his enemies charged, for the purpose of securing Southern support,—and caused great popular excitement, as it repealed the Missouri Compromise, and declared the people of "any state or territory" "free to form and regulate their domestic institutions in their own way, subject only to the Constitution of the United States." The passage of this Kansas-Nebraska Bill, one of the most momentous in its consequences ever passed by the Federal Congress, was largely a personal triumph for Douglas, who showed marvellous energy, adroitness and resourcefulness, and a genius for leadership. There was great indignation throughout the free states; and even in Chicago Douglas was unable to win for himself a hearing before a public meeting. In 1852, and again in 1856, he was a candidate for the presidential nomination in the national Democratic convention, and though on both occasions he was unsuccessful, he received strong support. In 1857 he broke with President Buchanan and the "administration" Democrats and lost much of his prestige in the South, but partially restored himself to favour in the North, and especially in Illinois, by his vigorous opposition to the method of voting on the Lecompton constitution, which he maintained to be fraudulent, and (in 1858) to the admission of Kansas into the Union under this constitution. In 1858, when the Supreme Court, after the vote of Kansas against the Lecompton constitution, had decided that Kansas was a "slave" territory, thus quashing Douglas's theory of "popular sovereignty," he engaged in Illinois in a close and very exciting contest for the senatorship with Abraham Lincoln, the Republican candidate, whom he met in a series of debates (at Ottawa, Freeport, Jonesboro, Charleston, Galesburg, Quincy and Alton), in one of which, that at Freeport, Douglas was led to declare that any territory, by "unfriendly

legislation," could exclude slavery, no matter what the action of the Supreme Court. This, the famous "Freeport Doctrine," lost to Douglas the support of a large element of his party in the South, and in Illinois his followers did not poll so large a vote as Lincoln's. Douglas, however, won the senatorship by a vote in the legislature of 54 to 46. In the Senate he was not reappointed chairman of the committee on territories. In 1860 in the Democratic national convention in Charleston the adoption of Douglas's platform brought about the withdrawal from the convention of Alabama, Mississippi, Louisiana, South Carolina, Florida, Texas and Arkansas. The convention adjourned to Baltimore, where the Virginia, North Carolina, Tennessee, Kentucky and Maryland delegations left it, and where Douglas was nominated for the presidency by the Northern Democrats; he campaigned vigorously but hopelessly, boldly attacking disunion, and in the election, though he received a popular vote of 1,376,957, he received an electoral vote of only 12—Lincoln receiving 180. Douglas urged the South to acquiesce in Lincoln's election. On the outbreak of the Civil War, he denounced secession as criminal, and was one of the strongest advocates of maintaining the integrity of the Union at all hazards. At Lincoln's request he undertook a mission to the border states and the North-west to rouse the spirit of Unionism; he spoke in West Virginia, Ohio and Illinois. He died on the 3rd of June 1861 at Chicago, where he was buried on the shore of Lake Michigan; the site was afterwards bought by the state, and an imposing monument with a statue by Leonard Volk now stands over his grave.

In person Douglas was conspicuously small, being hardly five feet in height, but his large head and massive chest and shoulders gave him the popular sobriquet "The Little Giant." His voice was strong and carried far, he had little grace of delivery, and his gestures were often violent. As a resourceful political leader, and an adroit, ready, skilful tactician in debate, he has had few equals in American history.

See Allen Johnson's *Stephen A. Douglas: A Study in American Politics* (New York, 1908), W. G. Brown's *Stephen Arnold Douglas* (Boston, 1902), and an excellent review of his later life in James Ford Rhodes's *History of the United States from the Compromise of 1850* (New York, 1893-1906); also P. O. Ray, *Repeal of the Missouri Compromise* (Cleveland, Ohio, 1909), and E. C. Carr, *Stephen A. Douglas* (Chicago, 1909).

DOUGLAS, the capital of the Isle of Man, a municipal borough and a favourite watering-place. Pop. (1901) 19,223. It stands on a fine semicircular bay on the east coast of the island, at the common mouth of two streams, the Awin-Dhoo and Awin-Glass, 62 m. W.N.W. of Fleetwood and 80 m. N.W. of Liverpool. The older streets are irregular and narrow, but the town has greatly extended in modern times, with numerous terraces of good dwelling-houses. A fine parade sweeps round the bay, which, from Derby Castle on the north to Douglas Head on the south, has a circuit exceeding 2 m. Low hills, penetrated by the valleys of the Dhoo and Glass, encircle the town on the north, west and south, the southern spur projecting seaward in the promontory of Douglas Head. The harbour, in the river mouth, lies immediately north of this; vessels drawing 9 ft. may enter it during neap tides, and those drawing 13 ft. during spring tides. A castellated building, called the Tower of Refuge, erected in 1832, marks the dangerous Conister rocks, north of the harbour entrance. The Battery pier protects the entrance on the south-west, and there is a short pier (the Red pier) within the harbour, while the Victoria pier on the north, at which passengers can land and embark at all heights of the tide, was erected in 1872. There is regular daily communication with Liverpool by the steamers of the Isle of Man Steam Packet Company, and during the season there are connexions with Fleetwood, Barrow, Dublin, Belfast and Glasgow. Douglas is connected by electric tramway northward with Laxey, the summit of the mountain of Snaefell and Ramsey, and southward with Port Soderick, while the Isle of Man railway runs to Peel in the west, and Castletown and Port Erin in the south-west. The town has services of cable and horse trams. The various popular attractions of Douglas include theatres, dancing halls, a race-course and two golf links Howstrake and Quarter Bridge. The shore of the bay is of firm

¹ Her death in 1853 was a great blow to him and embittered him. In November 1856 he married Adèle Cutts, a Maryland belle, a grand-niece of Dolly Madison, and a Roman Catholic, who became the leader of Washington society, especially in the winter of 1857-1858, when Douglas was in revolt against Buchanan.

sand (covered at high tide), and the sea-bathing is good. Among buildings and institutions in Douglas may be mentioned the legislative buildings (1893), the town hall (1899), the large free library, the court house and the Isle of Man hospital. Castle Mona, erected in 1804 by John, 4th duke of Arrol and lord of Man, is transformed into an hotel. St George's church, the oldest remaining in Douglas, dates from 1780. Douglas was incorporated in 1895, and is governed by a mayor, six aldermen and eighteen councillors.

DOUGLAS, a village of Lanarkshire, Scotland. Pop. (1901) 1206. It is situated on Douglas water, 3 m. from Douglas station on the branch line from Carstairs to Ayr, 11 m. by road S.S.W. of Lanark. It is a place of ancient aspect, bearing evident signs of decay, but possesses peculiar interest as the original home of the great Douglas family. Of the old castle, Scott's *Castle Dangerous*, only a tower exists. The stronghold repeatedly changed hands during the wars waged against Edward I. for the independence of Scotland. The modern castle is the seat of the earl of Home. Only the choir and spire remain of the 12th-century church of St Bride, the patron saint of the Douglases. The vault beneath the choir was, until 1761, the burial-place of the family, and it contains a silver case said to hold the ashes of the heart of the "good Sir James" (1286-1330). In 1879 the choir was restored and the tombs (including that of Sir James Douglas) repaired. David Hackston of Rathillet, the Covenanter, is stated to have been captured in the village (in a house still standing) after the battle of Aird's Moss in 1680. On the hill of Auchensaugh (1286 ft.), 2½ m. S.E., the Cameronians assembled in 1712 to renew the Solemn League and Covenant. This gathering, the "Auchensaugh Wark," as it was called, led up to the secession of the Reformed Presbyterians from the Kirk.

DOUGLASS, FREDERICK (1817-1895), American orator and journalist, was born in Tuckahoe, Talbot county, Maryland, probably in February 1817. His mother was a negro slave of exceptional intelligence, and his father was a white man. Until nearly eight years of age, he was under the care of his grandmother; then he lived for a year on the plantation of Colonel Edward Lloyd, of whose vast estate his master, Captain Aaron Anthony, was manager. After a year he was sent to Baltimore, where he lived in the family of Hugh Auld, whose brother, Thomas, had married the daughter of Captain Anthony; Mrs Auld treated him with marked kindness and without her husband's knowledge began teaching him to read. With money secretly earned by blacking boots he purchased his first book, the *Columbian Orator*; he soon learned to write "free passes" for runaway slaves. Upon the death of Captain Anthony in 1833, he was sent back to the plantation to serve Thomas Auld, who hired him out for a year to one Edward Covey, who had a wide reputation for disciplining slaves, but who did not break Frederick's spirit. Although a new master, William Freeland, who owned a large plantation near St Michael's, Md., treated him with much kindness, he attempted to escape in 1836, but his plans were suspected, and he was put in jail. From lack of evidence he was soon released, and was then sent to Hugh Auld in Baltimore, where he was apprenticed as a ship caulker. He learned his trade in one year, and in September 1838, masquerading as a sailor, he escaped by railway train from Baltimore to New York city. For the sake of greater safety he soon removed to New Bedford, Massachusetts, where he changed his name from Frederick Augustus Washington Bailey to Frederick Douglass, "Douglass" being adopted at the suggestion of a friend who greatly admired Scott's *Lady of the Lake*. For three years he worked as a day labourer in New Bedford. An extempore speech made by him before an anti-slavery meeting at Nantucket, Mass., in August 1841 led to his being appointed one of the agents of the Massachusetts Anti-Slavery Society, and in this capacity he delivered during the next four years numerous addresses against slavery, chiefly in the New England and middle states. To quiet the suspicion that he was an impostor, in 1845 he published the *Narrative of the Life of Frederick Douglass, an American Slave*. Fearing his recapture, his friends persuaded him to go to England, and from August 1845 to April 1847 he lectured in Ireland,

Scotland and England, and did much to enlist the sympathy of the British public with the Abolitionists in America. Before his return a sum of £150 was raised by subscription to secure his legal manumission, thus relieving him from the fear of being returned to slavery in pursuance of the Fugitive Slave Law. From 1847 to 1860 he conducted an anti-slavery weekly journal, known as *The North Star*, and later as *Frederick Douglass's Paper*, at Rochester, New York, and, during this time, also was a frequent speaker at anti-slavery meetings. At first a follower of Garrison and a disunionist, he allied himself after 1851 with the more conservative political abolitionists, who, under the leadership of James G. Birney, adhered to the national Constitution and endeavoured to make slavery a dominant political issue. He disapproved of John Brown's attack upon Harper's Ferry in 1859, and declined to take any part in it. During the Civil War he was among the first to suggest the employment of negro troops by the United States government, and two of his sons served in the Union army. After the war he was for several years a popular public lecturer; in September 1866 he was a delegate to the national Loyalist convention at Philadelphia; and in 1869 he became the editor, at Washington, of a short-lived weekly paper, *The New National Era*, devoted to the interests of the negro race. In 1871 he was assistant secretary of the Santo Domingo commission, appointed by President Grant. He was marshal of the District of Columbia from 1877 to 1881, was recorder of deeds for the district from 1881 to 1886, and from 1889 to 1891 was the American minister resident and consul-general in the Republic of Haiti. He died in Anacostia Heights, District of Columbia, on the 20th of February 1895. He was widely known for his eloquence, and was one of the most effective orators whom the negro race has produced in America.

His autobiography appeared, after two revisions, as *The Life and Times of Frederick Douglass* (London, 1882). See F. M. Holland, *Frederick Douglass, The Colored Orator* (New York, 1891); C. W. Chesnut, *Frederick Douglass*, (Boston, 1899); and Booker T. Washington, *Frederick Douglass* (Philadelphia, 1907), in the series of American Crisis Biographies.

DOUKHOBORS, a name given by the Russian Orthodox clergy to a community of nonconformist peasants. The word etymologically signifies "spirit-fighters," being originally intended by the priesthood to convey that they fight against the Spirit of God; but the Doukhobors themselves accepted the term as signifying that they fight, not against, but for and with the Spirit. Of late, however, they have decided to give up this name and call themselves "Christians of the Universal Brotherhood." This religious community was first heard of in the middle of the 18th century. By the end of that century or the beginning of the 19th their doctrine had become so clearly defined, and the number of their members had so greatly increased, that the Russian government and Church, considering this sect to be peculiarly obnoxious, started an energetic campaign against it. The foundation of the Doukhobors' teaching consists in the belief that the Spirit of God is present in the soul of man, and directs him by its word within him. They understand the coming of Christ in the flesh, his works, teaching and sufferings, in a spiritual sense. The object of the sufferings of Christ, in their view, was to give an example of suffering for truth. Christ continues to suffer in us even now when we do not live in accordance with the behests and spirit of his teaching. The whole teaching of the Doukhobors is penetrated with the Gospel spirit of love. Worshipping God in the spirit, they affirm that the outward Church and all that is performed in it and concerns it has no importance for them. The Church is where two or three are gathered together, i.e. united in the name of Christ. They pray inwardly at all times; on fixed days they assemble for prayer-meetings, at which they greet each other fraternally with low bows, thereby acknowledging every man as a bearer of the Divine Spirit. Their teaching is founded on tradition, which is called among them the "Book of Life," because it lives in their memory and hearts. It consists of sacred songs or chants, partly composed independently, partly formed out of the contents of the Bible, which, however, has evidently been gathered by them orally, as until quite lately they were almost entirely

illiterate and did not possess any written book. They found alike their mutual relations and their relations to other people—and not only to people, but to all living creatures—exclusively on love, and therefore they hold all people equal and brethren. They extend this idea of equality also to the government authorities, obedience to whom they do not consider binding upon them in those cases when the demands of these authorities are in conflict with their conscience; while in all that does not infringe what they regard as the will of God they willingly fulfil the desire of the authorities. They consider killing, violence, and in general all relations to living beings not based on love as opposed to their conscience and to the will of God. They are industrious and abstemious in their lives, and when living up to the standard of their faith they present one of the nearest approaches to the realization of the Christian ideal which have ever been attained. In many ways they have thus a close resemblance to the Quakers or Society of Friends. For these beliefs and practices the Doukhobors long endured cruel persecution. Under Nicholas I., in the years 1840 and 1850, the Doukhobors, who on religious grounds refused to participate in military service, were all banished from the government of Tauris—whither they had been previously transported from various parts of Russia by Alexander I.—to Transcaucasia, near the Turkish frontier. But neither the severe climate nor the neighbourhood of wild and warlike hillmen shook their faith, and in the course of half a century, in one of the most unhealthy and unfertile localities in the Caucasus, they transformed this wilderness into flourishing colonies, and continued to live a Christian and laborious life, making friends with, instead of fighting, the hillmen. But the wealth to which they attained in the Caucasus weakened for a time their moral fervour, and little by little they began to depart somewhat from the requirements of their belief. As soon, however, as events happened among them which disturbed their outward tranquillity, the religious spirit which had guided their fathers immediately revived within them. In 1887, in the reign of the tsar Alexander III., universal military service was introduced in the Caucasus; and even those for whom, as in the case of the Doukhobors, it had formerly been replaced with banishment, were called upon to serve. This measure took the Doukhobors unawares, and at first they outwardly submitted to it. About the same time, by the decision of certain government officials, the right to the possession of the public property of the Doukhobors (valued at about £50,000) passed from the community to one of their members, who had formed out of the more demoralized Doukhobors a group of his own personal adherents, which was henceforth called the "Small Party." Soon afterwards several of the most respected representatives of the community were banished to the government of Archangel. This series of calamities was accepted by the Doukhobors as a punishment from God, and a spiritual awakening of a most energetic character ensued. The majority (about 12,000 in number) resolved to revive in practice the traditions left them by their fathers, which they had departed from during the period of opulence. They again renounced tobacco, wine, meat and every kind of excess, many of them dividing up all their property in order to supply the needs of those who were in want, and they collected a new public fund. They also renounced all participation in acts of violence, and therefore refused military service. In confirmation of their sincerity, in the summer of 1895 the Doukhobors of the "Great Party," as they were called in distinction from the "Small Party," burnt all the arms which they, like other inhabitants of the Caucasus, had taken up for their protection from wild animals, and those who were in the army refused to continue service. At the commencement of the reign of the tsar Nicholas II., in 1895, the Doukhobors became the victims of a series of persecutions, Cossack soldiers plundering, insulting, beating and mistreating both men and women in every way. More than 400 families of Doukhobors who were living in the province of Tiflis were ruined and banished to Georgian villages. Of 4000 thus exiled, more than 1000 died in the course of the first two years from exhaustion and disease; and more would have perished had not information reached Count Leo Tolstoy and his friends, and through them the Society of Friends

in England. Funds were immediately raised by sympathizers for alleviating the sufferings of the starving victims. At the same time an appeal, written by Tolstoy and some of his friends, requesting the help of public opinion in favour of the oppressed Doukhobors, was circulated in St Petersburg and sent to the emperor and higher government officials. The Doukhobors themselves asked for permission to leave Russia, and the Society of Friends petitioned the emperor to the same effect. In March 1898 the desired permission was granted, and the first party of Doukhobors, 1126 in number, were able in the summer of 1898 to sail from Batum for Cyprus, which was originally chosen for their settlement because at that time funds were not sufficient for transferring them to any other British territory. But as contributions accumulated, it was found possible to send a number of Doukhobor emigrants to Canada, whither they arrived in two parties, numbering above 4000, in January 1899. They were joined in the spring of the same year by the Cyprus party, and another party of about 3000 arrived from the Caucasus. In all about 7500 Doukhobor immigrants arrived in Canada. The Canadian government did their best to facilitate the immigration, and allotted land to the Doukhobors in the provinces of Assiniboia near Yorktown and of Saskatchewan near Thunder Hill and Prince Albert. They were very cordially received by the population of the Canadian port towns. In April 1901, in the Canadian House of Commons, the minister of justice made a statement about them in which he said that "not a single offence had been committed by the Doukhobors; they were law-abiding, and if good conduct was a recommendation, they were good immigrants. . . . The large tracts of land demanded population, and if they were not given to crime, the conclusion was that they would make good citizens." About eighteen months after they arrived in Canada the Doukhobors sent the Society of Friends a collective letter in which they sincerely thanked the English and American Friends for all the generous help of every kind they had received at their hands, but begged the Quakers to cease sending them any more pecuniary support, as they were now able to stand on their own feet, and therefore felt it right that any further help should be directed to others who were more in need of it. At Yorktown in the summer of 1907 the Doukhobors established one of the largest and best brick-making plants in Canada, a significant testimony to the way in which the leaders of the community were working in the interests of the whole. Now and again small bodies broke off from the main community and adopted a semi-nomadic life, but these formed a very small percentage of the total number, which in 1908 was over 8000.

See also *Christian Martyrdom in Russia*, by V. Tchertkoff (The Free Age Press, Christchurch, Haats); Aymer Maude, *A Peculiar People, the Doukhobors*. (V. T.)

DOULLENS, a town of northern France, capital of an arrondissement in the department of Somme, on the Authie, 27 m. N. of Amiens by rail. Pop. (1906) 4495. It has a citadel of the 15th and 16th centuries which has often served as a state prison and is now used as a reformatory for girls. There are also a belfry of the 17th century and two old churches. The town is the seat of a sub-prefect and has a tribunal of first instance; it has trade in phosphates, of which there are workings in the vicinity, and carries on cotton-spinning and the manufacture of leather, paper and sugar. Doullens, the ancient *Dulincum*, was seat of a viscountship and an important stronghold in the middle ages. In 1475 it was burnt by Louis XI. for openly siding with the house of Burgundy. In 1595 it was besieged and occupied by the Spaniards, but was restored to France by the treaty of Vervins (1598).

DOULTON, SIR HENRY (1820-1897), English inventor and manufacturer of pottery, born in Vauxhall on the 25th of July 1820, was from the age of fifteen actively employed in the pottery works of his father, John Doulton, at Lambeth. One of the first results of his many experiments was the production of good enamel glazes. In 1846 he initiated in Lambeth the pipe works, in which he superintended the manufacture of the drainage and sanitary appliances which have helped to make the firm of Doulton famous. In 1870 the manufacture of "Art pottery"

was begun at Lambeth, and in 1877 works were opened at Burslem, where almost every variety of china and porcelain, as well as artistic earthenware, has been produced. Works have since been opened at Rowley Regis, Smethwick, St Helens, Paisley and Paris. After the Paris exhibition of 1878 Henry Doulton was made a chevalier of the Legion of Honour. In 1872 the "Art department" was instituted in the Doulton works, giving employment to both male and female artists, amongst whom such workers as George Tinworth and the Misses Barlow have obtained a reputation outside their immediate sphere. In 1887 Doulton received the honour of knighthood, and a few years later was awarded the Albert medal by the Society of Arts. He married in 1849 the daughter of Mr J. L. Kennaby; she died in 1888. Sir Henry Doulton took an active interest, as almoner, in St Thomas's hospital. He died in London on the 18th of November 1897.

DOUMER, PAUL (1857-), French politician, was born at Aurillac. He studied law and made his début in politics as *chef de cabinet* to Floquet, when president of the chamber in 1885. In 1888 he was elected Radical deputy for the department of the Aisne. Defeated in the general elections of September 1889, he was elected again in 1890 by the arrondissement of Auxerre. As minister of finance in the Bourgeois cabinet (from the 3rd of November 1895 to the 21st of April 1896) he tried without success to introduce an income-tax. In January 1897 he became governor of Indo-China, where he carried out important public works. In 1902 he returned to France and was elected by Laon to the chamber as a Radical. He refused, however, to support the Combes ministry, and formed a Radical dissident group, which grew in strength and eventually caused the fall of the ministry. Doumer became a prominent personage in Paris and was elected president of the chamber in January 1905, being re-elected in January 1906. At the presidential election of the 17th of January 1906 he was a candidate in opposition to M. Fallières and obtained only 371 votes against 449; and the new chamber passed him over as its new president in favour of Henri Brisson. As an author he is known by his *L'Indo-Chine française* (1904), and *Le Livre de mes fils* (1906).

DOUMIC, RENÉ (1860-), French critic and man of letters, was born in Paris, and after a distinguished career at the École Normale began to teach rhetoric at the Collège Stanislas. He was a contributor to the *Moniteur*, the *Journal des Débats* and the *Revue Neve*, but was best known as the independent and uncompromising literary critic of the *Revue des Deux Mondes*. His works include: *Éléments d'histoire littéraire* (1888); *Portraits d'écrivains* (1892); *De Scribæ à Ibsen* (1893); *Écrivains d'aujourd'hui* (1894); *Études sur la littérature française* (5 vols., 1896-1905); *Les Jeunes* (1896); *Essais sur le théâtre contemporain* (1897); *Les Hommes et les idées du XIX^e siècle* (1903); and an edition of the *Lettres d'Élvire à Lamartine* (1905).

DOUNE, a police burgh of Perthshire, Scotland, 8½ m. N.W. of Stirling by the Caledonian railway. Pop. (1901) 930. It is situated on the left bank of the Teith, here crossed by the bridge built in 1535 by Robert Spittal, tailor to James IV. The town was once famous for its pistols and sporrans (as the purses worn with the kilt are called), which were in great request by the clansmen of the Highlands. Doune Castle, now in ruins, occupies a commanding position on the Teith, at the point where it is joined by the Ardoch. It is believed to have been built by Murdoch, 2nd duke of Albany (d. 1425), and was sometimes a residence of the sovereigns, among them James V. and Queen Mary. A nephew of Rob Roy held it for Prince Charlie, and it figures in Scott's *Waverley*. It belongs to the earl of Moray (Murray), who derives from it his title of Lord Doune, and was the home of James Stewart, the "bonnie earl" of Moray, murdered at Donibristle in Fife by the earl of Huntly (1592). The braes of Doune lie to the north-west of the town and extend towards Uam Var. Deanston (pop. 652), 1 m. S.W. of Doune, on the right bank of the Teith, was the scene of the labours of James Smith (1789-1850), the agricultural engineer, who was also manager of the cotton mills established there in 1785. On his farm Smith carried his experiments in deep and thorough drainage, and also

invented a reaping machine, the subsoil plough and numerous other valuable appliances.

DOURO (Span. *Douro*, Port. *Douro*, anc. *Durius*), a river of the Iberian Peninsula. The Douro rises south of the Sierra de la Demanda, in the Pico de Urbiön, an isolated mountain mass 7380 ft. high. It describes a wide curve eastwards past Soria, then flows westward across the Castilian table-land, passing south of Valladolid, with Toro and Zamora on its right bank; then from a point 3 m. E. of Paradella to Barca d'Alva it flows south-west and forms the frontier between Spain and Portugal for 65 m. It crosses Portugal in a westerly direction through a narrow and tortuous bed, and enters the Atlantic 3 m. below Oporto at São João da Foz. The length of the Douro, which is greater than that of any other Iberian river except the Tagus and Guadiana, is probably about 485 m.; but competent authorities differ widely in their estimates, the extremes given being 420 and 507 m. In Spain the Douro receives from the right the rivers Pisuerga, Valderaduey and Esla, and from the left several small streams which drain the Sierra Guadarrama, besides the more important rivers Adaja, Tormes and Yeltes; in Portugal it receives the Agueda, Cõa and Paiva from the left, and the Sabor, Tãa and Tamega from the right. The area drained by the Douro and its tributaries is upwards of 37,500 sq. m., and includes the greater part of the vast plateau of Old Castile, between the watersheds of the Cantabrian Mountains, on the north, and the Guadarrama, Gredos, Gata and Estrella ranges, on the south. The lower stream is beset with numerous rapids, called *portos*, and is subject to swift and violent inundations. On this account navigation is attended with difficulties and risks between its mouth and Barca d'Alva; but a railway, running for the most part along the right bank, skirts the river during the greater part of its course through Portugal. The mouth of the river is partly blocked by a sandy bar; only ships of light draught can enter, while those of greater burden are accommodated at the harbour of Leixões, an artificial basin constructed about 3 m. N. On its way through Portugal the Douro traverses the Paiz do Vinho, one of the richest wine-producing territories in the world; large quantities of wine are conveyed to Oporto in sailing boats. The Douro yields an abundance of fish, especially trout, and lampreys.

DOUROCOULLI, apparently the native name (perhaps derived from their cries) of a small group of American monkeys ranging from Nicaragua to Amazonia and eastern Peru, and forming the genus *Nyctipithecus*. In addition to the absence of prehensile power in their tails, douroucoulis, also known as night-apes, are distinguished by their large eyes, the sockets of which occupy nearly the whole front of the upper part of the skull, the partition between the nostrils being in consequence narrower than usual. The ears are short, and the hair round the eyes forms a disk. Douroucoulis live in parties, and are purely nocturnal, sleeping during the day in hollow trees, and coming out at night to feed on insects and fruits, when they utter piercing cat-like screams.

DOUSA, JANUS [Jan van der Does], lord of Noordwyck (1545-1604), Dutch statesman, historian, poet and philologist, and the heroic defender of Leiden, was born at Noordwyck, in the province of Holland, on the 6th of December 1545. He began his studies at Lier in Brabant, became a pupil of Henry Junius at Delft in 1560, and then passed on in succession to Louvain, Douai and Paris. Here he studied Greek under Pierre Dorat, professor at the Collège Royal, and became acquainted with the chancellor L'Hôpital, Turnebus, Ronsard and other eminent men. On his return in 1565 he married Elizabeth van Zuylen. His name stands in the list of nobles who in that year formed a league against Philip II. of Spain, but he does not appear to have taken any active part in public affairs till 1572, when he was sent as a member of an embassy to England. He was not, however, at first very eager to commit himself to the fortunes of William the Silent, prince of Orange, but having once chosen his side, he threw himself heart and soul into the struggle for freedom from the Spanish yoke. Fortunately for Leiden he was residing in the town at the time of the famous siege. He held no post in the government, but in the hour of need he, though not trained to

arms, took the command of a company of troops. His fearlessness and unshaken resolution had no small influence in encouraging the regents and the citizens to prolong the defence. On the foundation of the university of Leiden by William the Silent, Dousa was appointed first curator, and he held this office for nearly thirty years. Through his friendships with foreign scholars he drew to Leiden many illustrious teachers and professors. After the assassination of the prince of Orange in 1584, Dousa undertook a private journey to England to try and persuade Queen Elizabeth to support the cause of the states, and in 1585 he went at the head of a formal embassy for the same purpose. About the same time he was appointed keeper of the archives of Holland (*registereester van Holland*), and the opportunities thus afforded him of historical research he turned to good account. He had three sons and five daughters. All his sons acquired a reputation for learning, but two of them died before their father. Dousa was author of several volumes of Latin verse and of philological commentaries on Horace, Plautus, Catullus and other Latin poets. His principal work is the *Annals of Holland*, which first appeared in a metrical form in 1599, and was published in prose under the title of *Bataviae Hollandicae annales* in 1601. Dousa also took part as editor or contributor in various other publications. He died at Noordwyck on the 8th of October 1604, and was interred at the Hague; but no monument was erected to his memory till 1792, when one of his descendants placed a tomb to his honour in the church of Noordwyck. There are good portraits of the Great Dousa, as he is often called, by Vischer and Houbraken.

DOUVILLE, JEAN BAPTISTE (1794?–1837), French traveller, was born at Hambye, in the department of Manche. Having at an early age inherited a fortune, he decided to gratify his taste for foreign travel. According to his own profession he visited India, Kashmir, Khorasan, Persia, Asia Minor and many parts of Europe. In 1826 he went to South America, and in 1827 left Brazil for the Portuguese possessions on the west coast of Africa, where his presence in March 1828 is proved by the mention made of him in letters of Castillo Branco, the governor-general of Loanda. In May 1831 he reappeared in France, claiming to have pushed his explorations into the very heart of central Africa. His story was readily accepted by the Société de Géographie of Paris, which hastened to recognize his services by assigning him the great gold medal, and appointing him their secretary for the year 1832. On the publication of his narrative, *Voyage au Congo et dans l'intérieur de l'Afrique équinoxiale*, which occupied three volumes and was accompanied by an elaborate atlas, public enthusiasm ran high. Before the year 1832 was out, however, it was established that Douville's *Voyage* was romance and not verity. He had probably been inspired by the appearance of René Caillié's account of his journey to Timbuktu, and wished to obtain a share of the fame attaching to African explorers. Douville tried vainly to establish the truth of his story in *Ma Défense* (1832), and *Trente mois de ma vie, ou quinze mois avant et quinze mois après mon voyage au Congo* (1833). Mlle Audrun, a lady to whom he was about to be married, committed suicide from grief at the disgrace; and the adventurer withdrew in 1833 to Brazil, and proceeded to make explorations in the valley of the Amazon. According to Dr G. Gardner, in his *Travels in the Interior of Brasil* (1846), he was murdered in 1837 on the banks of the Sao Francisco for charging too high for his medical assistance. Douville may well have explored part of the province of Angola, and Sir Richard Burton maintained that the Frenchman's descriptions of the country of the Congo were life-like; that his observations on the anthropology, ceremonies, customs and maladies of the people were remarkably accurate; and that even the native words used in his narrative were "for the most part given with unusual correctness." It has been shown, however, that the chief source of Douville's inspiration was a number of unpublished Portuguese manuscripts to which he had access.

DOUW (or **Dow**), **GERHARD** (1613–1680), Dutch painter, was born at Leiden on the 7th of April 1613. His first instructor in drawing and design was Bartholomew Dolendo, an engraver;

and he afterwards learned the art of glass-painting under Peter Kouwoorn. At the age of fifteen he became a pupil of Rembrandt, with whom he continued for three years. From the great master of the Flemish school he acquired his skill in colouring, and in the more subtle effects of chiaroscuro; and the style of Rembrandt is reflected in several of his earlier pictures, notably in a portrait of himself at the age of twenty-two, in the Bridge-water House gallery, and in the "Blind Tobit going to meet his Son," at Wardour Castle. At a comparatively early point in his career, however, he had formed a manner of his own distinct from, and indeed in some respects antagonistic to, that of his master. Gifted with unusual clearness of vision and precision of manipulation, he cultivated a minute and elaborate style of treatment; and probably few painters ever spent more time and pains on all the details of their pictures down to the most trivial. He is said to have spent five days in painting a hand; and his work was so fine that he found it necessary to manufacture his own brushes. Notwithstanding the minuteness of his touch, however, the general effect was harmonious and free from stiffness, and his colour was always admirably fresh and transparent. He was fond of representing subjects in lantern or candle light, the effects of which he reproduced with a fidelity and skill which no other master has equalled. He frequently painted by the aid of a concave mirror, and to obtain exactness looked at his subject through a frame crossed with squares of silk thread. His practice as a portrait painter, which was at first considerable, gradually declined, sitters being unwilling to give him the time that he is deemed necessary. His pictures were always small in size, and represented chiefly subjects in still life. Upwards of 200 are attributed to him, and specimens are to be found in most of the great public collections of Europe. His *chef-d'œuvre* is generally considered to be the "Woman sick of the Dropsy," in the Louvre. The "Evening School," in the Amsterdam gallery, is the best example of the candlelight scenes in which he excelled. In the National Gallery, London, favourable specimens are to be seen in the "Poulterer's Shop," and a portrait of himself. Douw's pictures brought high prices, and it is said that President Van Spiring of the Hague paid him 1000 florins a year simply for the right of pre-emption. Douw died in 1680. His most celebrated pupil was Francis Mieris.

DOVE, a river of England, tributary to the Trent, rising in Axe Edge, Derbyshire, and through almost its entire course forming the boundary of that county with Staffordshire. In its upper course it traverses a fine narrow valley, where the limestone hills exhibit many picturesque cliffs, gullies and caves. Dovedale, that part of the valley which lies between Dove Holes and Thorpe Cloud (or with a wider significance between the towns of Hartington and Ashbourne), is especially famous. Below Thorpe Cloud the Dove receives on the west the waters of the Manifold, which, like its tributary the Hamps, and other streams in the limestone district, has part of its course below ground. Near the village of Rocoeter the Churnet joins the Dove on the west, and then the course of the main stream, hitherto southerly, bends nearly easterly on passing Uttoxeter, and, winding through a widening valley, joins the Trent at Newton Solney, a short distance below Burton-on-Trent. The length of the valley is about 40 m. and the total fall of the river about 1450 ft. The Dove is well known for its trout-fishing, and the portion of the upper valley called Bereaford Dale, below Hartington, has a special interest for fishermen through its associations with Izaak Walton and his friend Charles Cotton, whose fishing-house stands near the Pike Pool, a reach of the river with a lofty rock rising from its centre.

DOVE (Dutch *dwyne*, Dan. *due*, Ice. *dufa*, Ger. *Taube*), a name most commonly applied by ornithologists to the smaller members of the group of birds usually called pigeons (*Columbae*); but no sharp distinction can be drawn between pigeons and doves, and in general literature the two words are used almost indifferently, while no one species can be pointed out to which the word dove, taken alone, seems to be absolutely proper. The largest of the group to which the name is applicable is perhaps the ring-dove, or wood-pigeon, also called in many part-

Britain cushat and queest (*Columba palumbus*, Linn.), a very common bird throughout the British Islands and most parts of Europe. It associates in winter in large flocks, the numbers of which (owing partly to the destruction of predaceous animals, but still more to the modern system of agriculture, and the growth of plantations in many districts that were before treeless) have increased enormously. In former days, when the breadth of land in Britain under green crops was comparatively small, these birds found little food in the dead season, and this scarcity was a natural check on their superabundance. But since the extended cultivation of turnips and plants of similar use the case is altered, and perhaps at no time of the year has provender become more plentiful than in winter. The ring-dove may be easily distinguished from other European species by its larger size, and especially by the white spot on either side of its neck, forming a nearly continuous "ring," whence the bird takes its name, and the large white patches in its wings, which are very conspicuous in flight. It breeds several times in the year, making for its nest a slight platform of sticks on the horizontal bough of a tree, and laying therein two eggs—which, as in all the *Columbae*, are white. It is semi-domestic in the London parks.

The stock-dove (*C. oenas* of most authors) is a smaller species, with many of the habits of the former, but breeding by preference in the stocks of hollow trees or in rabbit-holes. It is darker in colour than the ring-dove, without any white on its neck or wings, and is much less common and more locally distributed.

The rock-dove (*C. livia*, Temm.) much resembles the stock-dove, but is of a lighter colour, with two black bars on its wings, and a white rump. In its wild state it haunts most of the rocky parts of the coast of Europe, from the Faeroes to the Cyclades, and, seldom going inland, is comparatively rare. Yet, as it is without contradiction the parent-stem of all British domestic pigeons, its numbers must far exceed those of both the former put together. In Egypt and various parts of Asia it is represented by what Charles Darwin has called "wild races," which are commonly accounted good "species" (*C. schimperi*, *C. affinis*, *C. intermedia*, *C. leucanota*, and so forth), though they differ from one another far less than do nearly all the domestic forms, of which more than 150 kinds that "breed true," and have been separately named, are known to exist. Very many of these, if found wild, would have unquestionably been ranked by the best ornithologists as distinct "species" and several of them would as undoubtedly have been placed in different genera. These various breeds are classified by Darwin in four groups as follows:—

GROUP I., composed of a single Race, that of the "Pouters," having the gullet of great size, barely separated from the crop, and often inflated, the body and legs elongated, and a moderate bill. The most strongly marked sub-race, the *Improved English Pouter*, is considered to be the most distinct of all domesticated pigeons.

GROUP II. includes three Races:—(1) "Carriers," with a long pointed bill, the eyes surrounded by much bare skin, and the neck and body much elongated; (2) "Runts," with a long, massive bill, and the body of great size; and (3) "Earbs," with a short, broad bill, much bare skin round the eyes, and the skin over the nostrils swollen. Of the first four and of the second five sub-races are distinguished.

GROUP III. is confessedly artificial, and to it are assigned five Races:—(1) "Fan-tails," remarkable for the extraordinary development of their tails, which may consist of as many as forty-two rectrices in place of the ordinary twelve; (2) "Turbits" and "Owls," with the feathers of the throat diverging, and a short thick bill; (3) "Tumblers," possessing the marvellous habit of tumbling backwards during flight, or, in some breeds, even on the ground, and having a short, conical bill; (4) "Frill-backs," in which the feathers are reversed; and (5) "Jacobins," with the feathers of the neck forming a hood, and the wings and tail long.

GROUP IV. greatly resembles the normal form, and comprises two Races:—(1) "Trumpeters," with a tuft of feathers at the base of the neck curling forward, the face much feathered, and a very peculiar voice, and (2) Pigeons scarcely differing in structure from the wild stock.

Besides these some three or four other little-known breeds exist, and the whole number of breeds and sub-breeds almost defies computation. The difference between them is in many cases far

from being superficial, for Darwin has shown that there is scarcely any part of the skeleton which is constant, and the modifications that have been effected in the proportions of the head and sternal apparatus are very remarkable. Yet the proof that all these different birds have descended from one common stock is nearly certain. Here there is no need to point out its bearing upon the theory of natural selection. The antiquity of some of these breeds is not the least interesting part of the subject, nor is the use to which one at least of them has long been applied. The dove from the earliest period in history has been associated with the idea of a messenger (Genesis viii. 8-12), and the employment of pigeons in that capacity, developed successively by Greeks, Romans, Mussulmans and Christians, has come down to modern times.

The various foreign species, if not truly belonging to the genus *Columba*, are barely separable therefrom. Of these examples may be found in the Indian, Ethiopian and Neotropical regions. Innumerable other forms entitled to the name of "dove" are to be found in almost every part of the world, and nowhere more abundantly than in the Australian Region. A. R. Wallace (*Ibis*, 1865, pp. 365-400) considers that they attain their maximum development in the Papuan Subregion, where, though the land area is less than one-sixth that of Europe, more than a quarter of all the species (some 300 in number) known to exist are found—owing, he suggests, to the absence of forest-haunting and fruit-eating mammals, which are in most cases destructive to eggs also.

To a small group of birds the name dove is, however, especially applicable in common parlance. This is the group containing the turtle-doves—the time-honoured emblem of tenderness and conjugal love. The common turtle-dove of Europe (*Turtur auritus*) is one of those species which are gradually extending their area. In England, in the 18th century, it seems to have been chiefly, if not solely, known in the southern and western counties. Though in the character of a straggler only, it now reaches the extreme north of Scotland, and is perhaps nowhere more abundant than in many of the midland and eastern counties of England. On the continent of Europe the same thing has been observed, though indeed not so definitely; and this species has appeared as a casual visitor within the Arctic Circle. Its graceful form and the delicate harmony of its modest colouring are proverbial. The species is migratory, reaching Europe late in April and retiring in September. Another species, and one perhaps better known from being commonly kept in confinement, is that called by many the collared or Barbary dove (*T. risorius*)—the second English name probably indicating that it was by way of the Barbary coast that it was brought to England. This is distinguished by its cream-coloured plumage and black neck. (A. N.)

DOVER, GEORGE JAMES WELBORE AGAR-ELLIS, BARON (1797-1833), English man of letters, born on the 14th of January 1797, was the only son of the 2nd Viscount Clifden. He was educated at Westminster school and at Christ Church, Oxford. In 1818 he was returned to parliament as member for Heytesbury. He afterwards represented Seaford (1820), Ludgerhall (1826) and Okehampton (1830). He seconded Canning's motion in 1822 for a bill to relieve the disabilities of Roman Catholic peers, and consistently supported liberal principles. In party politics, however, he took little interest, but he zealously advocated in parliament and elsewhere that state encouragement should be given to the cause of literature and the fine arts. In 1824 he was the leading promoter of the grant of £57,000 for the purchase of John Julius Angerstein's collection of pictures, which formed the foundation of the National Gallery. On the formation of Lord Grey's administration, in November 1830, he was appointed chief commissioner of woods and forests, but was compelled by delicate health to resign it after two months' occupancy. In June 1831, during the lifetime of his father, he was raised to the House of Lords, receiving an English peerage with the title of Baron Dover. He was president (1832) of the Royal Society of Literature, a trustee of the British Museum and of the National Gallery, and a commissioner of public records. He died on the 10th of July

¹ *The Variation of Animals and Plants under Domestication* (London, 1868), vol. i. pp. 131-224.



Rock Dove or Blue Rock Pigeon, *Columba livia*.



Stock Dove, *Columba oenas*.



American Wild Carrier Pigeon,
Ectopistes migratorius.



Ring Dove or Wood Pigeon,
Columba palumbus.

(After the coloured drawings by Mme. Knip (Pauline de Courcelles), painter to the Empress Marie Louise in *Les Pigeons*. Text by C. J. Themminck, Paris, 1811.)



Crowned Pigeon, *Goura coronata*.
(After Mme. Knip, as above.)



Nicobar Pigeon, *Caloenas nicobarica*.
(After Mme. Knip, as above.)



Photographs of two typical pedigree Homing or Racing Pigeons, colours black and blue chequer, bred and shown by Frederick Romer, Esq., prize-winners in races from France to England.

By permission of the proprietors of the *Racing Pigeon*.

1833. Lord Dover's works are chiefly historical, and include *The True History of the Iron Mask, extracted from Documents in The French Archives* (1826), *Inquiries respecting the Character of Clarendon* (1827), and *A Life of Frederick II.* (1831). He also edited the *Ellis Correspondence* (1829) and *Walpole's Letters to Sir Horace Mann* (1833).

DOVER, HENRY JERMYN, EARL OF (c. 1636–1708), was the second son of Sir Thomas Jermyn, of Rushbrooke, Suffolk, elder brother of Henry Jermyn, earl of St Albans (q.v.). Jermyn surpassed his uncle, St Albans, in reputation for profligacy, figuring frequently as "the little Jermyn" in the *Grammont Memoirs*, as the lover of Lady Castlemaine, Lady Shrewsbury, Miss Jennings and other beauties of the court of Charles II. He was also a noted duellist and a lifelong gambler. While the court was in exile, he obtained a post in the household of the duke of York, to whom he became master of the horse at the Restoration. Being a Roman Catholic he enjoyed a position of influence with James II., who on his accession raised Jermyn to the peerage as Baron Dover in 1685, and appointed him lieutenant-general of the royal guard in 1686. At the Revolution, Dover adhered to James, whom he followed abroad, and in July 1689 the deposed sovereign created him Baron Jermyn of Royston, Baron Ipswich, Viscount Cheveley and earl of Dover; these honours being among the "Jacobite peerages" which were not recognized by the English government, though Jermyn became generally known as the earl of Dover. He commanded a troop at the battle of the Boyne; but shortly afterwards made his submission to William III. He succeeded his brother Thomas as 3rd Baron Jermyn of St Edmundsbury in 1703, and died in 1708. As he left no children by his wife, Judith, daughter of Sir Edmund Pole, of Badley, Suffolk, his titles became extinct at his death.

See Samuel Pepys, *Diary*, edited by H. B. Wheatley, 9 vols. (London, 1893); Anthony Hamilton, *Memoirs of Grammont* (Bohn edition, London, 1846); J. S. Clarke, *Life of James II.*, 2 vols. (London, 1816); Narcissus Luttrell, *Brief Relation of State Affairs 1678–1714*, 6 vols. (Oxford, 1857).

DOVER, ROBERT (1575–1641), English captain and attorney, is known as the founder and director for many years of the "Cotswold Games," which he originated as a protest against the growing Puritanism of the day. These sports, which were referred to by contemporary writers as "Mr Robert Dover's Olimpick Games upon the Cotswold Hills," consisted of cudgel-playing, wrestling, running at the quintain, jumping, casting the bar and hammer, hand-ball, gymnastics, rural dances and games and horse-racing, the winners in which received valuable prizes. They continued from about the year 1604 until three years after the death of Dover, which took place in 1641. They were revived for a brief period in the reign of Charles II.

DOVER, the capital of Delaware, U.S.A., and the county seat of Kent county, on the St Jones River, in the central part of the state, about 48 m. S. of Wilmington and about 9 m. from Delaware Bay. Pop. (1890) 3061; (1900) 3329 (772 negroes); (1910) 3720. Dover is served by the Philadelphia, Baltimore & Washington railway (Pennsylvania system). The state house, built about 1722 for a court house, was remodelled for its present purpose in 1791; it contains the state library, which in 1908 had about 50,000 bound volumes. Dover is the seat of the Wilmington Conference Academy (Methodist Episcopal); and about 2 m. N. is the state college for coloured students (co-educational; opened in 1892), an agricultural and manual training school. The surrounding country is largely devoted to the raising of small fruit. Among the manufactures are canned fruit and meat (especially poultry), timber, machine shop products, baskets and crates, and silk. The town was laid out in 1717; in 1777 it replaced New Castle as the capital of the state, and in 1829 it was incorporated as a town. Dover was the birthplace of the American patriot, Caesar Rodney (1738–1784), whose home near Dover is still standing.

DOVER, a seaport and municipal and parliamentary borough of Kent, England, one of the Cinque Ports, 76 m. E.S.E. of London by the South-Eastern & Chatham railway. Pop. (1891) 33,503; (1901) 41,794. It is situated at the mouth of a small

stream, the Dour, whose valley here breaches the high chalk cliffs which fringe the coast on either hand. It is an exceptionally healthy locality, and the steep shore and open downs make it an agreeable summer resort. The better residential quarters lie along the seaboard and on the higher ground, notably on a western spur of the Castle Hill. The dominant object of the place is the castle, on the east height, 375 ft. above sea-level, between which and the batteries on the western heights lies the old town. The castle occupies a space of 35 acres. Within its precincts are a Roman *pharos* or lighthouse, still exhibiting the Roman masonry; the ancient fortress church (St Mary in Castro); some remains of the Saxon fort; and the massive keep and subsidiary defences (such as the Constable's, Avranche's, and other towers) of the Norman building. The church, substantially unaltered, forms an almost unique Christian relic. It has been called Roman, but is later. It is cruciform in shape, and the walls are built mainly of flint, but jambs and arches are formed of Roman bricks. At the end of the 12th century it was remodelled and given an Early English character. In the beginning of the 18th century it was dismantled and turned into a storehouse; and so continued until 1863, when, having been restored by Sir G. G. Scott, it was again opened for divine service, and is now the chapel of the castle garrison.

The view from the castle keep includes on a clear day the line of cliffs from Folkestone to Ramsgate on the one side, and from Boulogne to Gravelines on the other side of the strait. The cliffs are honeycombed in all directions with military works. They are covered by modern works on the north side known as Fort Burgoyne, and additional works extend eastwards towards St Margaret's Bay. The western heights, where is the foundation of another Roman lighthouse, form a further circuit of fortifications. They are still more elevated than the castle. A military shaft, locally known as the Corkscrew Staircase, affords communication between the barracks and the town. Remains were discovered here in 1854 of a round church of the Templars (Holy Sepulchre), 32 ft. in diameter; the church, doubtless, in which King John made his submission to the Papal Nuncio in 1213. Arcliffe Fort lies to the south-west of old Dover. There may further be mentioned the remnant of the Saxon collegiate church of the canons of St Martin, and the parish church of St Mary the Virgin. This last was rebuilt and enlarged in 1843–1844, but preserves the three bays of the Saxon church, with its western narthex, on which was superimposed the Norman tower, which presents its rich front to the street. The rest of the church is mainly Norman and Early English. A later Norman church stands under the Castle Hill, but its parochial status was transferred to the modern church of St James.

The remains of the splendid foundation of St Martin's priory, of the 12th century, include the great gate, the house refectory, with campanile, and the spacious strangers' refectory, now incorporated in Dover College. The college of St Martin for twenty-two secular canons, which had been established in the castle in 606, was removed into the town in the beginning of the 8th century, and in 1130 became a Benedictine priory under the jurisdiction of that at Canterbury, to which see the lands are still attached. The interior of the refectory is very fine. In High Street may be seen the noble hall and truncated fabric of the Maison Dieu founded by Hubert de Burgh in the 13th century for the reception of pilgrims of all nations. From the time of Henry VIII. to 1830 it was used as a crown victualling office, but was subsequently purchased by the corporation and adapted as a town hall. The new town hall adjoining the old hall of the Maison Dieu was opened in 1883. The museum (1849) contains an interesting collection of local antiquities and a natural history collection.

Among various charitable institutions are the National Sailors' Home and the Gordon Boys' and Victoria Ss:side Orphanages. Besides the church of St James, mentioned above, other modern churches are those of Holy Trinity and Christ church, and further up the valley there are the parish churches of Chariton (originally Norman) and Buckland (Early English). Among educational establishments is Dover College, occupying the site and remaining buildings of St Martin's priory, with additional modern buildings.

It was instituted in 1871, and educates about 220 boys. There is a separate junior school.

Dover is the only one of the Cinque Ports which is still a great port. It is one of the principal ports for passenger communications across the Channel, steamers connecting it with Calais and Ostend. The Admiralty pier was begun in 1847 and practically completed to a length of about 2000 ft. in 1871. In 1888 the gates of Wellington dock were widened to admit a larger type of Channel steamers; new coal stores were erected on the Northampton quay; the slipway was lengthened 40 ft., and widened for the reception of vessels up to 800 tons. In 1891 it was resolved to construct a new commercial harbour at an estimated cost of about £700,000. Begun in 1893, the works included the construction of an east pier ("Prince of Wales's Pier"), running parallel to the general direction of the Admiralty pier and in conjunction with it enclosing an area of sheltered water amounting to seventy-five acres. This pier was completed in 1902. A railway line connected with the South-Eastern and Chatham system runs to its head, and in July 1903 it was brought into use for the embarkation of passengers by transatlantic liners. In 1896 and subsequent years funds were voted by parliament for the construction of an artificial harbour for naval purposes, having an area of 610 acres, of which 322 acres were to have a depth of not less than 30 ft. at low water. The scheme comprised three enclosing breakwaters—on the west an extension of the Admiralty pier in a south-easterly direction for a length of 2000 ft.; on the south an isolated breakwater, 4200 ft. long, curving round shoreward at its eastern end to accord with the direction of the third breakwater; on the east, which runs out from the shore in a southerly direction for a length of 3320 ft. These three breakwaters, with a united length of rather more than 1½ m., are each built of massive concrete blocks in the form of a practically vertical wall founded on the solid chalk and rising to a quay level of 10 ft. above high water. Two entrances, one 800 ft. and the other 600 ft. in width, with a depth of about seven fathoms at low water, are situated at either end of the detached breakwater. The plan also included the reclamation of the foreshore at the foot of the cliffs, between the castle jetty and the root of the eastern breakwater, by means of a massive sea-wall. The construction of three powerful forts was undertaken in defence of the harbour, which was opened in 1909.

Besides the mail service and harbour trade, Dover has a trade in shipbuilding, timber, rope and sail making, and ships' stores. Dover is a suffragan bishopric in the diocese of Canterbury. The parliamentary borough returns one member. The town is governed by a mayor, six aldermen and eighteen councillors. Area, 2026 acres.

History.—Dover (*Dubris*) was one of the ports for continental traffic in Roman times. In the 4th century it was guarded by a fort lying down near the harbour, and forming part of the defences of the Saxon shore (*Litus Saxonicum*). As a Cinque Port, Dover (*Dofra*, *Dovorra*) had to contribute twenty of the quota of ships furnished by those ports; in return for this service a charter of liberties was granted to the ports by Edward the Confessor, making the townsmen quit of shires and hundreds, with the right to be impeached only at Shepway, and other privileges, which were confirmed by subsequent kings, with additions, down to James II. During the middle ages Dover Castle was an object of contention both in civil wars and foreign invasions, and was considered the key to England; the constable of the castle, who from the reign of John was appointed by the crown, was also warden of the Cinque Ports. The castle was successfully defended in 1216 against the French under the dauphin Louis by Hubert de Burgh, who was also the founder of the Maison Dieu established for the accommodation of pilgrims. The title of mayor as chief municipal officer first occurs about the middle of the 13th century, when the town was governed by a mayor and twelve jurats. The Cinque Ports were first represented in the parliament of 1265; Dover returned two members until 1885 when the number was reduced to one. In 1685 Charles II. confirmed to the inhabitants of Dover a fair beginning on the 11th of November, which had been held of old in the town, and granted

two others on the 23rd and 24th of April and the 25th and 26th of September.

After the decay of Richborough harbour the passage from Dover to Whitsand, and later to Calais, became the accustomed route to France, and by a statute of 1465 no one might ship for Calais except at Dover. The guardians of the harbour were incorporated by James I. in 1607.

See S. P. H. Statham, *History of the Castle, Town and Port of Dover* (London, 1899); and *Dover Charters and other Documents* (London, 1902).

BATTLE OF DOVER

This famous and important naval victory was won off the town of Dover by the ships of the Cinque Ports on the 21st of August 1217, during the minority of King Henry III. The barons, who were in arms against his father King John, had called Louis, son of Philip Augustus, king of the French, to their aid. Having been recently defeated in Lincoln, they were hard pressed, and reinforcements were sent to them from Calais in a fleet commanded by a pirate and mercenary soldier called Eustace the Monk. His real name is uncertain, but according to the chronicle of Lanercost it was Matthew. He passed the Straits of Dover with a numerous flotilla laden with military machines and stores, and also carrying many knights and soldiers. The Monk's fleet was seen from Dover, where the regent, Hubert de Burgh, lay with a naval force of the Cinque Ports, said to have been very small. Sixteen vessels of large size for the time, and a number of smaller craft, is said to have been their total strength. But medieval estimates of numbers are never to be trusted, and the strength of the Cinque Port squadron was probably diminished to exalt the national glory. It put to sea, and by hugging the wind gained the weather gage of the French adventurer. Eustace is said to have been under the impression that they meant to attack Calais in his absence, and to have derided them because he had left the town well guarded. When they were to windward of his fleet the Cinque Port ships bore down on the enemy. As they approached they threw unslaked lime in the air and the wind blew it in the faces of the French. This form of attack, and the flights of arrows discharged by the English (which flew with the wind), produced confusion in the crowded benches of the French vessels, which in most cases must have been little more than open boats. It is further said that in some cases at least the English vessels were "bearded," that is to say, strengthened by iron bands across the bows for ramming, and that they sank many of the French. The Monk was certainly defeated, and his fleet was entirely scattered, sunk or taken. His own vessel was captured. Eustace, who had concealed himself in the bilge, was dragged out. In answer to his appeals for quarter and promises to pay ransom, he was told by Richard, the bastard son of King John, that he was a traitor who would not be allowed to deceive more men. His head was struck off by Richard, and was sent round the ports on a pike. The Cinque Port seamen returned in triumph, towing their prizes, after throwing the common soldiers overboard, and taking the knights to ransom according to the custom of the age.

The political importance of the battle was very great, for it gave the death-blow to the cause of the barons who supported Louis, and it fixed Henry III. on the throne. But the defeat and death of the Monk was widely regarded as in a peculiar sense a victory over the powers of evil. The man became within a few years after his death the hero of many legends of piracy and necromancy. It was said that after leaving the cloister he studied the black art in Toledo, which had a great reputation in the middle ages as a school of witchcraft. A French poem written seemingly within a generation after his death represents him as a wizard. In a prose narrative discovered and printed by M. Francisque Michel, it is said that he made his ship invisible by magic spells. A brother wizard in the English fleet, by name Stephen Crabbe, detected him while he was invisible to others. The bold and patriotic Crabbe contrived to board the bewitched flagship, and was seen apparently laying about him with an axe on the water—which the spectators took to be a proof either that he was mad, or that this was the devil in his shape. At last he struck off the head of Eustace, upon which the spell was broken, and the ship

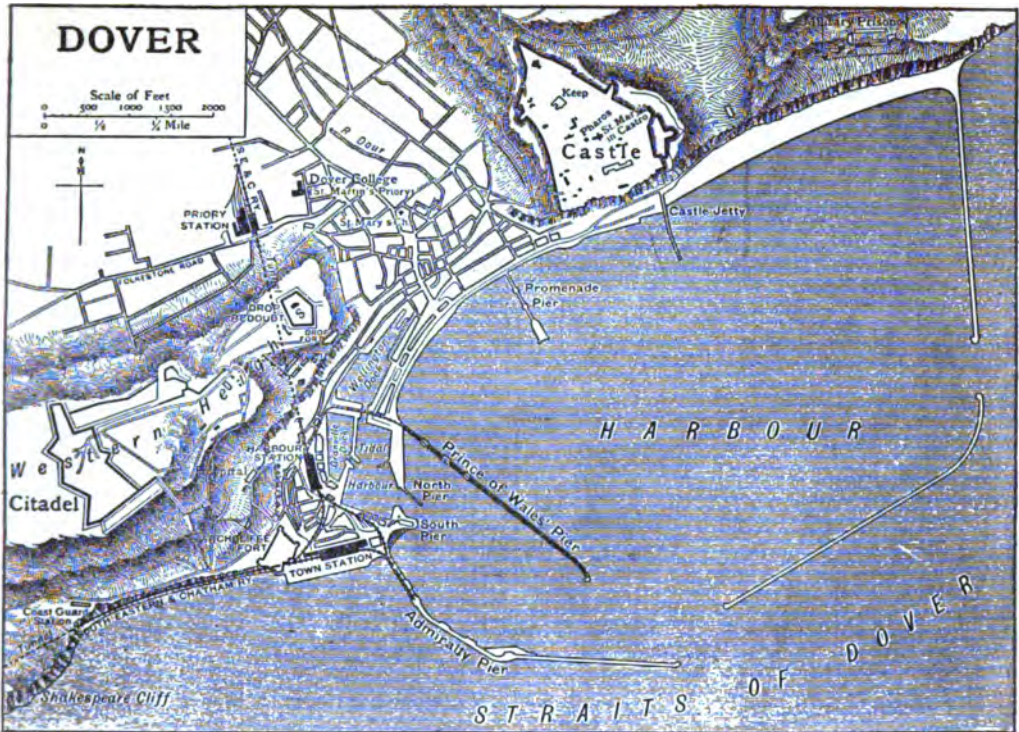

appeared. Crabbe was torn to pieces—presumably by the familiar spirits of the Monk—and the fragments were scattered over the water. Saint Bartholomew, whose feast is on the 21st of August, came to encourage the English by his presence and his voice.

Ascertainable fact concerning Eustace is less picturesque, but enough is known to show that he was an adventurous and unscrupulous scoundrel. In his youth he was a monk, and left the cloister to claim an inheritance from the count of Boulogne. Not having received satisfaction he became a freebooter on land and sea, and mercenary soldier. He is frequently mentioned in the Pipe, Patent and Close Rolls. For a time he served King John, but when the king made friends with the count of Boulogne, he fled abroad, and entered the service of the French prince Louis and his father Philip Augustus. Chroniclers lavish on him the titles of "archipirata," "vir flagitiosissimus et nequissimus," and poets made him an associate of the devil.

The evidence concerning Eustace is collected by Herren Wendelin Förster and Johann Tröst, in their edition of the French poem "Wistasse le moine" (Halle, 1891). See for the battle Sir N. Harris Nicolas, *History of the Royal Navy* (London, 1847).

DOVER, a city and the county seat of Strafford county, New Hampshire, U.S.A., on the Cochecho river, at the head of navigation, 10 m. N.W. of Portsmouth. Pop. (1890) 12,790; (1900) 13,207, of whom 3208 were foreign-born; (1910 census) 13,247. Land area, 26.4 sq. m. It is at the intersection of two branches of the Boston & Maine railway, and is served by several Interurban electric lines. The street plan is irregular. Dover has a fine city hall of red brick and freestone; a public library containing (1907) 34,000 volumes; the Wentworth hospital; the Wentworth home for the aged; a children's and an orphans' home. The Strafford Savings Bank is said to be the largest and oldest savings institution in the state. Dover has long had a considerable commerce, both by rail and by water, that by water being chiefly

in coal and building materials. The navigation of the Cochecho river has been greatly improved by the Federal government, at a cost between 1820 and 1907 of about \$300,000, and in 1909 there was a navigable channel, 60-75 ft. wide and 7 ft. deep at mean low water, from Dover to the mouth of the river; the mean range of tides is 6-8 ft. The Cochecho river falls $31\frac{1}{2}$ ft. within the city limits and furnishes water-power for factories; among the manufactures are textiles, boots and shoes, leather belting, sash, doors and blinds, carriages, machinery and bricks. In 1905 Dover ranked fourth among the manufacturing cities of the state, and first in manufactures of woollens; the value of the city's total factory product in that year was \$6,042,901. Dover is one of the two oldest cities in the state. In May 1623 a settlement was established by Edward Hilton on Dover Point, about 5 m. S.E. of the Cochecho Falls; the present name was adopted in 1639, and with the development of manufacturing and trading interests the population gradually moved nearer the falls; Hilton and his followers were Anglicans, but in 1633 they were joined by several Puritan families under Captain Thomas Wiggim, who settled on Dover Neck (1 m. above Dover Point), which for 100 years was the business centre of the town. As the settlement was outside the jurisdiction of any province, and as trouble arose between the two sects, a plantation covenant was drawn up and signed in 1640 by forty-one of the inhabitants. Dissensions, however, continued, and in 1641, by the will of the majority, Dover passed under the jurisdiction of Massachusetts and so remained for nearly half a century. The town, between 1675 and 1725, suffered greatly from Indian attacks, particularly from that of the 28th of June 1689 at Cochecho Falls. Dover was first chartered as a city in 1855. Within the original territory of the town were included Newington, set off in 1713, Somersworth (1720), Durham (1732), Medbury (1755), Lee, set off from Durham in 1766, and Rollinsford, set off from Somersworth in 1849.

See Jeremy Belknap, *History of New Hampshire* (Philadelphia, 1784-1792); and Rev. Dr. A. H. Quint's *Historical Memoranda of Persons and Places in Old Dover, N.H.*, edited by John Scales (Dover, 1900).

DOVER, a town of Morris county, New Jersey, U.S.A., on the Rockaway river and the Morris canal, about 40 m. by rail W.N.W. of Hoboken. Pop. (1900) 5938, of whom 947 were foreign-born; (1905) 6353; (1910) 7468. The area of the town is 1.72 sq. m. Dover is at the junction of the main line and the Morris & Essex division of the Delaware, Lackawanna & Western railway (which has large repair shops here), and is also served by the High Bridge branch of the Central of New Jersey, and by an electric line connecting with neighbouring towns. The town is situated about 570 ft. above sea-level. Building stone, used extensively for railway bridges, and iron ore abound in the vicinity. The river furnishes good water-power, and the town has various manufactures, including stoves and ranges, boilers, bar iron, rivets, steel castings, rock drills, air compressors, silk hose and underwear, orgazine or thrown silk, and overalls. The water-works are owned by the town, water being obtained from wells varying in depth from 193 to 213 ft. Dover was settled as early as 1748, and was separated from Randolph township and incorporated as a town in 1860.

DOVERCOURT, a watering-place in the Harwich parliamentary division of Essex, England, immediately S.W. of Harwich, with a station between Parkeston Quay and Harwich town on the Great Eastern railway, 70 m. N.E. by E. from London. Pop. (1901) 3894. The esplanade and sea-wall front the North Sea, and there is a fine expanse of sand affording good bathing. There is also a chalybeate spa. The scenery of the neighbouring Orwell and Stour estuaries is pleasant. The church, which stands inland in the old village distinguished as Upper Dovercourt, is Early English and later; it formerly possessed a miraculous rood which became an object of pilgrimage of wide repute. It is said to have been stolen and burnt in 1532, three of the four thieves being subsequently taken and hanged.

DOW, LORENZO (1777-1834), American preacher, noted for his eccentricities of dress and manner, was born at Coventry, Connecticut, on the 16th of October 1777. He was much troubled in his youth by religious perplexities, but ultimately joined the Methodists, and in 1798 was appointed a preacher "on trial" in a New York circuit. In the following year, however, he crossed the Atlantic and preached as a missionary to the Catholics of Ireland, and thereafter was never connected officially with the ministry of the Methodist Church, though he remained essentially a Methodist in doctrine. Everywhere, in America and Great Britain, he attracted great crowds to hear and see him, and he was often persecuted as well as admired. In 1805 he visited England, introduced the system of camp meetings, and thus led the way to the formation of the Primitive Methodist Society. Dow's enthusiasm sustained him through the incessant labours of more than thirty years, during which he preached in almost all parts of the United States. His later efforts were directed chiefly against the Jesuits; indeed he was in general a vigorous opponent of Roman Catholicism. He died in Georgetown, District of Columbia, on the 2nd of February 1834. Among his publications are: *Polemical Works* (1814); *The Stranger in Charleston, or the Trial and Confession of Lorenzo Dow* (1822); *A Short Account of a Long Travel; with Beauties of Wesley* (1823); and *the History of a Cosmopolite; or the Four Volumes of the Rev. Lorenzo Dow's Journal, concentrated in One, containing his Experience and Travels from Childhood to 1814* (1814; many later editions); this volume also contains "All the Polemical Works of Lorenzo." The edition of 1854 was entitled *The Dealings of God, Man, and the Devil as exemplified in the Life, Experience and Travels of Lorenzo Dow*.

DOW, NEAL (1804-1897), American temperance reformer, was born at Portland, Maine, on the 20th of March 1804. His parents were Quakers and he was educated at the Friends' School in New Bedford, Massachusetts. He subsequently became a merchant in his native city and rose to a position of importance in its business and political life. His chief interest, however, was in

the temperance question, and he early attracted attention as an ardent champion of the prohibition of the sale of intoxicating drinks. He drafted the drastic Maine prohibitory law of 1851. He was mayor of Portland in 1851 and in 1855, and was a member of the Maine legislature in 1858-1859. Early in the Civil War he became colonel of the 13th Maine Volunteer Infantry. He served in General B. F. Butler's New Orleans expedition, was commissioned brigadier-general of volunteers in April 1862, and subsequently commanded for a time the department of Florida. He was twice wounded in the attack on Port Hudson, on the 27th of May 1863, and was taken prisoner, remaining eight months in Libby and other prisons before he was exchanged. After the war he devoted a great part of his time and energy to the extension of the prohibition movement in America and England. Through his exertions the prohibitory amendment was added to the Maine constitution in 1884. In 1880 he was the candidate of the National Prohibition Party for president, polling 10,305 votes. He died at Portland on the 2nd of October 1897.

His *Reminiscences* were published at Portland in 1898.

DOWAGER (from the Old Fr. *donagiere*, mod. *domaître*), strictly, a widow in the enjoyment of dower. "Dowager" is also applied to widows of high rank to distinguish them from the wives of their sons, as queen-dowager, dowager-duchess, &c. The title was first used in England of Catherine of Aragon, widow of Arthur, prince of Wales, who was styled princess dowager till her marriage with Henry VIII. By transference the word is used of an elderly lady.

DOWDEN, EDWARD (1843-), Irish critic and poet, son of John Wheeler Dowden, merchant and landowner, was born at Cork on the 3rd of May 1843, being three years junior to his brother John, who became bishop of Edinburgh in 1886. His literary tastes were shown early, in a series of essays written at the age of twelve. His home education was continued at Queen's College, Cork, and Trinity College, Dublin; at the latter university he had a distinguished career, becoming president of the Philosophical Society, and winning the vice-chancellor's prize for English verse and prose, and the first senior moderatorship in ethics and logic. In 1867 he was elected professor of oratory and English literature in Dublin University. His first book, *Shakespeare, his Mind and Art* (1875), was a revision of a course of lectures, and made him widely known as a critic, being translated into German and Russian; and his *Poems* (1876) went into a second edition. His *Shakespeare Primer* (1877) was also translated into Italian and German. In 1878 he was awarded the Cunningham gold medal of the Royal Irish Academy "for his literary writings, especially in the field of Shakespearian criticism." Later works by him in this field were his *Shakespeare's Sonnets* (1881), *Passionate Pilgrim* (1883), *Introduction to Shakespeare* (1893), *Hamlet* (1899), *Romeo and Juliet* (1900), *Cymbeline* (1903), and his article (*National Review*, July 1902) on "Shakespeare as a Man of Science," criticizing T. E. Webb's *Mystery of William Shakespeare*. His critical essays "Studies in Literature" (1878), "Transcripts and Studies" (1888), "New Studies in Literature" (1895) showed a profound knowledge of the currents and tendencies of thought in various ages and countries; but it was his *Life of Shelley* (1886) that made him best known to the public at large. In 1900 he edited an edition of Shelley's works. Other books by him which indicate his interests in literature are his *Southey* (in the "English Men of Letters" series, 1880), his edition of *Southey's Correspondence with Caroline Bowles* (1881), and *Select Poems of Southey* (1895); his *Correspondence of Sir Henry Taylor* (1888), his edition of *Wordsworth's Poetical Works* (1892) and of his *Lyrical Ballads* (1890), his *French Revolution and English Literature* (1897); lectures given at Princeton University in 1896), *History of French Literature* (1897), *Puritan and Anglican* (1900), *Robert Browning* (1904) and *Michel de Montaigne* (1905). His devotion to Goethe led to his succeeding Max Müller in 1888 as president of the English Goethe Society. In 1880 he became the first Taylorian lecturer at Oxford, and from 1892 to 1896 was Clark lecturer at Trinity College, Cambridge. To his sagacity in research are due, among other matters of literary interest, the first account of Carlyle's

"Lectures on periods of European culture"; the identification of Shelley as the author of a review (in *The Critical Review* of December 1814) of a lost romance by Hogg; description of Shelley's "Philosophical View of Reform"; a MS. diary of Fabre D'Eglantine; and a record by Dr Wilhelm Wiessenborn of Goethe's last days and death. He also discovered a "Narrative of a Prisoner of War under Napoleon" (published in *Blackwood's Magazine*), an unknown pamphlet by Bishop Berkeley, some unpublished writings of Hayley relating to Cowper, and a unique copy of the *Tales of Terror*. His wide sympathies and scholarly methods made his influence on criticism both sound and stimulating, and his own ideals are well described in his essay on "The Interpretation of Literature" in his *Transcripts and Studies*. As commissioner of education in Ireland (1896-1901), trustee of the National Library of Ireland, secretary of the Irish Liberal Union and vice-president of the Irish Unionist Alliance, he enforced his view that literature should not be divorced from practical life. He married twice, first (1866) Mary Clerke, and secondly (1895) Elizabeth Dickinson West, daughter of the dean of St Patrick's.

DOWDESWELL, WILLIAM (1721-1775), English politician, was a son of William Dowdeswell of Pull Court, Bushley, Worcestershire, and was educated at Westminster school, at Christ Church, Oxford, and at the university of Leiden. He became member of parliament for the family borough of Tewkesbury in 1747, retaining this seat until 1754, and from 1761 until his death he was one of the representatives of Worcestershire. Becoming prominent among the Whigs, Dowdeswell was made chancellor of the exchequer in 1765 under the marquis of Rockingham, and his short tenure of this position appears to have been a successful one, he being in Lecky's words "a good financier, but nothing more." To the general astonishment he refused to abandon his friends and to take office under Lord Chatham, who succeeded Rockingham in August 1766. Dowdeswell then led the Rockingham party in the House of Commons, taking an active part in debate until his death at Nice on the 6th of February 1775. The highly eulogistic epitaph on his monument at Bushley was written by Edmund Burke.

DOWER (through the Old Fr. *dosaire* from late Lat. *dotarium*, classical Lat. *dos*, dowry), in law, the life interest of the widow in a third part of her husband's lands. There were originally five kinds of dower: (1) at common law; (2) by custom; (3) *ad ostium ecclesie*, or at the church porch; (4) *ex assensu patris*; (5) *de la plus belle*. The last was a conveyance of tenure by knight service, and was abolished in 1660, by the act which did away with old tenures. Dower *ad ostium ecclesie*, by which the bride was dowered at the church porch (where all marriages used formerly to take place), and dower *ex assensu patris*, by the father of the bridegroom, though long obsolete, were formally abolished by the Dower Act 1834. Dower is governed in the United Kingdom, so far as women married after the 1st of January 1834 are concerned, by the Dower Act 1834, and under it only attaches on the husband's death to the lands which he actually possessed for an estate of inheritance at the time of his death. It must be claimed within twelve years of the time of its accrual, but only six years' arrears are recoverable. The wife is also entitled to dower out of equitable estates, but joint estates are exempt. By the act the wife's dower is placed completely under her husband's control. It does not attach to any land actually disposed of by him in his lifetime or by his will, nor to any land from which he has declared by deed his wife shall not be entitled to dower. He may also defeat her right, either as to any particular land or to all his lands, by a declaration in his will; while it is subject to all the deceased husband's debts and contracts, and to any partial estates which he may have created during his life or by his will. A widow tenant in dower may make leases for twenty-one years under the Settled Estates Act 1878. Free-bench is an analogous right in regard to copyhold land; it does not fall within the Dower Act 1834, and varies with the custom of each manor. At common law, and prior to the act of 1834, dower was of a very different nature. The wife's right attached, while the husband was still living, to any land whereof

he was solely seised in possession (excluding equitable and joint estates) for an estate of inheritance at any time during the continuance of the marriage, provided that any child the wife might have had could have been heir to the same, even though no child was actually born. When once this right had attached it adhered to the lands, notwithstanding any sale or devise the husband might make; nor was it liable for his debts. In this way dower proved an obstacle to the free alienation of land, for it was necessary for a husband wishing to make a valid conveyance to obtain the consent of his wife releasing her right to dower. This release was only effected by a fine, the wife being separately examined. Often, by reason of the expense involved, the wife's concurrence was not obtained, and thus the title of the purchaser was defective during the wife's lifetime. The acceptance of a jointure by the wife before marriage was, however, destructive of dower, if after marriage she was put to her election between it and dower. By the ingenuity of the old conveyancers, devices, known as "uses to bar dower" (the effect of which was that the purchaser never had at any time an estate of inheritance in possession), were found to prevent dower attaching to newly purchased lands, and so to enable the owner to give a clear title, without the need of the wife's concurrence, in the event of his wishing, in his turn, to convey the land. All this was, however, swept away by the Dower Act 1834, and a purchaser of land no longer need trouble himself to inquire whether the dower of the wife of the vendor has been barred, or to insist on her concurrence in a fine. (H. S. S.)

DOWIE, JOHN ALEXANDER (1848-1907), founder of "Zionism," was born in Edinburgh, and went as a boy to South Australia with his parents. He returned in 1868 to study for the Congregationalist ministry at Edinburgh University, and subsequently became pastor of a church near Sydney, Australia. He was a powerful preacher, and later, having become imbued with belief in his powers as a healer of disease by prayer, he obtained sufficient following to move to Melbourne, build a tabernacle, and found "The Divine Healing Association of Australia and New Zealand." In 1888 he went to America, preaching and "healing," and in spite of opposition and ridicule attracted a number of adherents. In 1896 he established "The Christian Catholic Apostolic Church in Zion," with himself as "First Apostle"; and in 1901, with money liberally contributed by his followers, he founded Zion City, on a site covering about 10 sq. m. on the west shore of Lake Michigan, with a central temple for the Zionist church. In 1903 and 1904, in the course of a visit to the branches of the Zionist movement throughout the world, he appeared in London, but was mobbed. In April 1906 a revolt against his domination took place in Zion City. He was charged with speculation and with practising polygamy, and was deposed, with the assent of his own wife and son. A suit brought by him in the United States district court to recover possession of the Zion City property, valued at two millions sterling, was unsuccessful, and his defalcations were fully proved. Dowie was now broken in health and unmistakably insane; he was struck with paralysis and gradually becoming weaker died in Zion City in March 1907.

DOWLAS, the name given to a plain cloth, similar to sheeting, but usually coarser. It is made in several qualities, from line warp and welt to two warp and welt, and is used chiefly for aprons, pocketing, soldiers' gaiters, linings and overalls. The finer makes are sometimes made into shirts for workmen, and occasionally used for heavy pillow-cases. The word is spelt in many different ways, but the above is the common way of spelling adopted in factories, and it appears in the same form in Shakespeare's *First Part of Henry IV.*, Act III. scene 3. The modern dowlas is a good, strong and closely woven linen fabric.

DOWN, a maritime county of Ireland, in the province of Ulster, occupying the most easterly part of the island, bounded N. by Co. Antrim and Belfast Lough, E. and S. by the Irish Sea, and W. by Co. Armagh. The area is 607,916 acres, or nearly 950 sq. m. The coast line is indented by several loughs and bays. The largest of these is Strangford Lough, a fine sheet of water studded with 260 islets, 54 of which have names. All are well wooded or

rich in pasture. The lough runs for 10 m. northwards, and the ancient castles and ruined abbeys on some of the islets render the scene one of singular interest and beauty. Farther south Dundrum Bay forms a wider expanse of water. In the south-west Carlingford Lough separates the county from Louth. There are no lakes of importance. Between Strangford and Carlingford loughs the county is occupied by a range of hills known in its south-western portion as the Mourne Mountains, which give rise to the four principal rivers—the Bann, the Lagan, the Annacloy and the Newry. This mass includes, several striking peaks, of which the principal is Slieve Donard, rising finely direct from the sea to a height of 2796 ft., which is exceeded in Ireland only by one peak in the Wicklow range, and by the higher reeks in Killarney. Several other summits exceed 2000 ft.

Holy wells and mineral springs are numerous in Co. Down. These are both chalybeate and sulphurous, and occur at Ardmillan, Granshaw, Dundonnell, Magheralin, Dromore, Newry, Banbridge and Tierkely. Those of Struell near Downpatrick were accredited with miraculous powers by the natives until recent times, and religious observances of an extravagant nature took place there.

Geology.—The foundation of this county is Silurian rock throughout, the slates and sandstones striking as a whole north-east, but giving rise to a country of abundant small hills. The granite that appears along the same axis in Armagh continues from Newry to Slieve Croob, furnishing an excellent building stone. South of it, the Eocene granite of the Mournes forms a group of rocky summits, set with scarps and tors, and divided by noble valleys, which are not yet choked by the detritus of these comparatively youthful mountains. Basalt dykes abound, being well seen along the coast south of Newcastle. At the head of Strangford Lough, the basalt, possibly as intrusive sheets, has protected Triassic sandstone, which is quarried at Scarbo Hill. A strip of marine Permian occurs on the shore at Holywood. The north-west of the county includes, at Moira, a part of the great basaltic plateau, with Chalk and Trias protected by them. The hæmatite of dehomet near Banbridge is well spoken of. Topaz and aquamarine occur in hollows in the granite of the Mournes. The Mourne granite is quarried above Annalong, and an ornamental dolerite is worked at Rosstrevor.

Industries.—The predominating soil is a loam of little depth, in most places intermixed with considerable quantities of stones of various sizes, but differing materially in character according to the nature of the subsoil. Clay is mostly confined to the eastern coast, and to the northern parts of Castlereagh. Of sandy soil the quantity is small; it occurs chiefly near Dundrum. Moor grounds are mostly confined to the skirts of the mountains. Bogs, though frequent, are scarcely sufficient to furnish a supply of fuel to the population. Agriculture is in a fairly satisfactory condition. The bulk of the labouring population is orderly and industrious, and dwell in circumstances contrasting well with those of others of their class in some other parts of Ireland. Tillage land declines somewhat in favour of pasture land. Oats, potatoes and turnips are the principal crops; flax, formerly important, is almost neglected. The breed of horses is an object of much attention, and some of the best racers in Ireland have been bred in this county. The native breed of sheep, a small hardy race, is confined to the mountains. The various other kinds of sheep have been much improved by judicious crosses from the best breeds. Pigs are reared in great numbers, chiefly for the Belfast market, where the large exportation occasions a constant demand for them. Poultry farming is a growing industry. The fisheries, of less value than formerly, are centred at Donaghadee, Newcastle, Strangford and Ardglass, the headquarters of the herring fishery. The chief industries in the county generally are linen manufacture and bleaching, and brewing.

Communications.—The Great Northern railway has an alternative branch route to its main line by Portadown, from Lisburn through Banbridge to Scarva, with a branch from Banbridge to Ballyronney and Newcastle. Newry is on a branch from the Dublin-Belfast line to Warrenpoint on Carlingford Lough. The main line between Lisburn and Portadown touches the north-western extremity of the county. The eastern part of the county is served by the Belfast & County Down railway with its main line from Belfast to Newcastle to Dundrum Bay, and branches from Belfast to Bangor, Comber to Newtownards and Donaghadee, Ballynahinch Junction to Ballynahinch, and

Downpatrick to Ardglass and Killough. The Newry Canal skirts the west of the county, and the Lagan Canal intersects the rich lands in the Lagan valley to the north.

Population and Administration.—The population (219,405 in 1891; 205,889 in 1901) decreases slightly. The population in 1891 on the area of the county before the Local Government (Ireland) Act 1898 was 224,008, for in this case the figures for part of the county borough of Belfast were included. This is worth notice from the comparative point of view, since, whereas emigration to foreign ports is considerable, a large portion of the moving population travels no farther than the metropolis of Belfast. About 39% of the population is of the Presbyterian faith, about 31% Roman Catholic, among whom, as usual, education is in the most backward condition; about 23% are Protestant Episcopalians.

The following are the principal towns:—Newry (pop. 12,405), Newtownards (9110), Banbridge (5006), Downpatrick (2993); the county towns, Holywood (3840), Gilford (1199), Bangor (5903), Dromore (2397), Donaghadee (2073), Comber (2095) and Warrenpoint (1817). Other small towns are Portaferry, Rathfriland, Killyleagh, Killeel, Ballynahinch, Dundrum, a small port, and Hillsborough, near Dromore, where the castle is the seat of the marquesses of Downshire. There are several popular watering-places on the coast, notably Newcastle, Donaghadee, Ardglass and Rosstrevor. On the shore of Belfast Lough are many pleasant residential villages and seats of the wealthy class in Belfast. The county is divided into fourteen baronies, and contains sixty-four parishes. The assizes are held at Downpatrick, and quarter-sessions at the same town and at Banbridge, Newry and Newtownards. The county is in the Protestant diocese of Down, and the Roman Catholic dioceses of Down and Dromore. Down returns four members to parliament—for the north, south, east and west divisions. The borough of Newry returns a member. Previous to the act of Union the county returned fourteen members to the Irish parliament.

History and Antiquities.—The period at which Down was constituted a county is not certain. A district, however, appears to have borne this name before the beginning of the 14th century, but little is known of it even later than this. However, when in 1535 Sir John Perrot undertook the shiring of Ulster, Down and Antrim were excepted as already settled counties. That some such settlement would have been attempted at an early period is likely, as this coast was a place of Anglo-Norman colonization, and to this movement was due the settlement of the baronies of Lecale, the Ards and others.

The county is not wanting in interesting remains. At Sliderryford, near Dundrum, there is a group of ten or twelve pillar stones in a circle, about 10 ft. in height. A very curious cairn on the summit of Slieve Croob is 80 yds. in circumference at the base and 50 at the top, where is a platform on which cairns of various heights are found standing. The village of Anadorn is famed for a cairn covering a cave which contains ashes and human bones. Cromlechs, or altars, are numerous, the most remarkable being the Giant's Ring, which stands on the summit of a hill near the borders of Antrim. This altar is formed of an unwrought stone 7 ft. long by 6½ broad, resting in an inclined position on rude pillars about 3 ft. high. This solitary landmark is in the centre of an enclosure about a third of a mile in circumference, formed of a rampart about 20 ft. high, and broad enough on the top to permit two persons to ride abreast. Near Downpatrick is a rath, or encampment, three-quarters of a mile in circumference. In its vicinity are the ruins of Saul Abbey, said to have been founded by St Patrick, and Inch Abbey, founded by Sir John de Courcy in 1180. The number of monastic ruins is also considerable. The most ancient and celebrated is the abbey or cathedral of Downpatrick. Dundrum Castle, attributed to the de Courcy family, stands finely above that town, and affords an unusual example (for Ireland) of a donjon keep. The castle of Hillsborough is of Carolean date. There are three round towers in the county, but all are fragmentary.

DOWN, a smooth rounded hill, or more particularly an expanse of high rolling ground bare of trees. The word comes from the

Old English *dun*, hill. This is usually taken to be a Celtic word. The Gaelic and Irish *dun* and Welsh *dŷn* are specifically used of a hill-fortress, and thus frequently appear in place-names, e.g. Dumbarton, Dunkeld, and in the Latinized termination—*dunum*, e.g. Lugdunum, Lyons. The Old Dutch *duna*, which is the same word, was applied to the drifted sandhills which are a prevailing feature of the south-eastern coast of the North Sea (Denmark and the Low Countries), and the derivatives, Ger. *Düne*, modern Dutch *dunin*, Fr. *dune*, have this particular meaning. The English "dune" is directly taken from the French. The low sandy tracts north and south of Yarmouth, Norfolk, are known as the "Dunes," which may be a corruption of the Dutch or French words. From "down," hill, comes the adverb "down," from above, in the earlier form "adown," i.e. off the hill. The word for the soft under plumage of birds is entirely different, and comes from the Old Norwegian *dun*, cf. *edar-dun*, eider-down. For the system of chalk hills in England known as "The Downs" see **Downs**.

DOWNES [D(O)UNAUS], ANDREW (c. 1549-1628), English classical scholar, was born in the county of Shropshire. He was educated at Shrewsbury and St John's College, Cambridge, where he did much to revive the study of Greek, at that time at a very low ebb. In 1571 he was elected fellow of his college, and, in 1585, he was appointed to the regius professorship of Greek, which he held for nearly forty years. He died at Coton, near Cambridge, on the 2nd of February 1627/1628. According to Simonds d'Ewes (*Autobiography*, ed. J. O. Halliwell, i. pp. 139, 141), who attended his lectures on Demosthenes and gives a slight sketch of his personality, Downes was accounted "the ablest Grecian of Christendom." He published little, but seems to have devoted his chief attention to the Greek orators. He edited *Lysias Pro caede Erasthenis* (1593); *Prælectiones in Philippticam de pace Demosthenis* (1621), dedicated to King James I.; some letters (written in Greek) to Isaac Casaubon, printed in the *Epistolæ* of the latter; and notes to St Chrysostom, in Sir Henry Savile's edition. Downes was also one of the seven translators of the *Apocrypha* for the "authorized" version of the Bible, and one of the six learned men appointed to revise the new version after its completion.

DOWNING, SIR GEORGE, Bart. (c. 1624-1684), English soldier and diplomatist, son of Emmanuel Downing, barrister, and of Lucy, sister of Governor John Winthrop, was born in England about 1624.¹ His family joined Winthrop in America in 1638, settling in Salem, Massachusetts, and Downing studied at Harvard College. In 1645 he sailed for the West Indies as a preacher and instructor of the seamen, and arrived in England some time afterwards, becoming chaplain to Colonel John Okey's regiment. Subsequently he seems to have abandoned his religious vocation for a military career, and in 1650 he was scout-master-general of Cromwell's forces in Scotland, and as such received in 1657 a salary of £365 and £500 as a teller of the exchequer. His marriage in 1654 with Frances, daughter of Sir William Howard of Naworth, and sister of the 1st earl of Carlisle, aided his advancement. In Cromwell's parliament of 1654 he represented Edinburgh, and Carlisle in those of 1656 and 1659. He was one of the first to urge Cromwell to take "the royal title and restore the old constitution. In 1655 he was sent to France to remonstrate on the massacre of the Protestant Vaudois. Later in 1657 he was appointed resident at The Hague, to effect a union of the Protestant European powers, to mediate between Portugal and Holland and between Sweden and Denmark, to defend the interests of the English traders against the Dutch, and to inform the government concerning the movements of the exiled royalists.

He showed himself in these negotiations an able diplomatist. He was maintained in his post during the interregnum subsequent to the fall of Richard Cromwell, and was thus enabled in April 1660 to make his peace with Charles II., to whom he communicated Thurloe's despatches, and declared his abandonment of "principles sucked in" in New England, of which he now "saw the error." At the Restoration, therefore, Downing was knighted

¹ The date of his birth is variously given as 1623, 1624 and 1625 (Sibley's *Harvard Graduates*, 1883).

(May 1660), was continued in his embassy in Holland, was confirmed in his teleriship of the exchequer, and was further rewarded with a valuable piece of land adjoining St James's Park for building purposes, now known as Downing Street.² Considering his past, he showed a very indecent zeal in arresting in Holland and handing over for execution the regicides Barkstead, Corbet and Okey. Pepys, who characterized his conduct as odious though useful to the king, calls him a "perfidious rogue;" and remarks that "all the world took notice of him for a most ungrateful villain for his pains."³ On the 1st of July 1663 he was created a baronet. Downing had from the first been hostile to the Dutch as the commercial rivals of England. He had strongly supported the Navigation Act of 1660, and he now deliberately drew on the fatal and disastrous war. During its continuance he took part at home in the management of the treasury, introduced the appropriation of supplies, opposed strongly by Clarendon as an encroachment on the prerogative, and in May 1667 was made secretary to the commissioners, his appointment being much welcomed by Pepys.⁴ He had been returned for Morpeth in the convention parliament of April 1660, a constituency which he represented in every ensuing parliament till his death, and he spoke with ability on financial and commercial questions. He was appointed a commissioner of the customs in 1671. The same year he was again sent to Holland to replace Sir William Temple, to break up the policy of the Triple alliance and incite another war between Holland and England in furtherance of the French policy. His unpopularity there was extreme, and after three months' residence Downing fled to England, in fear of the fury of the mob. For this unauthorized step he was sent to the Tower on the 7th of February 1672, but released some few weeks afterwards. He defended the Declaration of Indulgence the same year, and made himself useful in supporting the court policy. He died in July 1684. Downing Street, London, is named after him, while Downing College, Cambridge, derived its name from his grandson, the 3rd baronet. The title became extinct when the 4th baronet, Sir Jacob G. Downing, died in 1764.

Downing was undoubtedly a man of great political and diplomatic ability, but his talents were rarely employed for the advantage of his country and his character was marked by all the mean vices, treachery, avarice, servility and ingratitude. "A George Downing" became a proverbial expression in New England to denote a false man who betrayed his trust.⁵ He published a large number of declarations and discourses, mostly in Dutch, enumerated in Sibley's biography, and wrote also "A True Relation of the Progress of the Parliament's Forces in Scotland" (1651), *Thomason Tracts*, Brit. Mus., E 640 (5).

DOWNMAN, JOHN (1750-1824), English portrait painter, was the son of Francis Downman, attorney, of St Neots, by Charlotte Goodsend, eldest daughter of the private secretary to George I.; his grandfather, Hugh Downman (1672-1729), having been the master of the House of Ordnance at Sheerness. He is believed to have been born near Ruabon, educated first at Chester, then at Liverpool, and finally at the Royal Academy schools, and he was for a while in the studio of Benjamin West. His exquisite pencil portrait drawings, slightly tinted in colour, usually from the reverse, are well known, and many of them are of remarkable beauty. Several volumes of sketches for these drawings are still in existence. Downman is believed to have been "pressed" for the navy as a young man, and on his escape settled down for a while in Cambridge, eventually coming to London, and later (1804) going to reside in Kent in the village of West Malling. He afterwards spent some part of his life in the west of England, especially in Exeter, and then travelled all over the country painting his dainty portraits. In 1818 he settled down at Chester, finally removing to Wrexham, where his only daughter married and where he died and was buried. He was an associate of the Royal Academy. The Downman family is usually known as a Devonshire one, but the exact connexion between the artist

² *Cal. of St Pap.; Dom.* (1661-1662) p. 408; *Notes and Queries*, ix. ser. vii. 92.

³ *Diary*, March 12, 17, 1662.

⁴ Sibley, i. 46.

⁵ *Id* May 27, 1667.

and the Devonshire branch has not been traced. Many of his portraits have attached to them remarks of considerable importance respecting the persons represented.

See *John Downman, his Life and Works*, by G. C. Williamson (London, 1907).

DOWNPATRICK, a market town and the county town of Co. Down, Ireland, in the east parliamentary division, 28 m. S.S.E. of Belfast by the Belfast & County Down railway. Pop. (1901) 2993. It stands picturesquely on a sloping site near the south-west extremity of Strangford Lough. It is the seat of the Protestant and Roman Catholic dioceses of Down. St Patrick founded the see about 440, but the present Protestant cathedral dates from 1790, the old structure, after suffering many vicissitudes, having been in ruins for 250 years. The cathedral is said to contain the remains of its founder, together with those of St Columba and St Bridget. A round tower adjoining it was destroyed in 1790. A small trade is carried on at Strangford Lough by means of vessels up to 100 tons, which discharge at Quoile quay, about 1 m. from the town; but vessels of larger tonnage can discharge at a steamboat quay lower down the Quoile. The imports are principally iron, coal, salt and timber; the exports barley, oats, cattle, pigs and potatoes. Linen manufacture is also carried on, and brewing, tanning and soap-making give considerable employment. The Down corporation race-meeting is important and attracts visitors from far outside the county. The rath or dun from which the town is named remains as one of the finest in Ireland. It was called Rath-Keltair, or the rath of the hero Keltair, and covers an area of 10 acres. In the vicinity of the town are remnants of the monastery of Saul, a foundation ascribed to St Patrick, and of Inch Abbey (1180), founded by Sir John de Courcy. Three miles south is a fine stone circle, and to the south-east are the wells of Struell, famous as miraculous healers among the peasantry until modern times. The town is of extreme-antiquity. It was called *Dun-leth-glas*, the fort of the broken fetters, from the miraculous deliverance from bondage of two sons of Dichu, prince of Lecale, and the first convert of St Patrick. It is the *Dunum* of Ptolemy, and was a residence of the kings of Ulster. It was already incorporated early in the 15th century. It returned two members to the Irish parliament until the Union in 1800, and thereafter one to the Imperial parliament until 1832.

DOWNS, the name of a system of chalk hills in the south-east of England. For the etymology of the word and its meaning see Down. It is most familiar in its application to the two ranges of the North and South Downs. Of these the North Downs are confined chiefly to the counties of Surrey and Kent, and the South to Sussex. Each forms a well-defined long range springing from the chalk area of Dorsetshire and Hampshire, to which, though broken up into a great number of short ranges and groups of hills, the general name of the Western Downs is given. The Downs enclose the rich district of the Weald (*q.v.*).

The North Downs, extending from a point near Farnham to the English Channel between Dover and Folkestone, have a length along the crest line, measured directly, of 95 m. The crest, however, is not continuous, as the hills are breached by a succession of valleys, forming gaps through which high-roads and railways converge upon London. The rivers flowing through these gaps run northward, and, except in the extreme east, are members of the Thames basin. These breaching valleys, which are characteristic of the South Downs also, "carry us back to a time when the greensand and chalk were continued across, or almost across, the Weald in a great dome." The rivers "then ran down the slopes of the dome, and as the chalk and greensand gradually weathered back . . . deepened and deepened their valleys, and thus were enabled to keep their original course."¹ The western termination of the North Downs is the Hog's Back, a narrow ridge, little more than a quarter of a mile broad at the summit, sloping sharply north and south, and reaching 489 ft. in height. At the west end a depression occurs where the rivers Wey and Blackwater closely approach each other; and it is thought that the Wey has beheaded the Blackwater, which formerly

flowed through the gap. In this depression lies Farnham, the first of a series of towns which have grown up at these natural gateways through the hills. The Wey, flowing south of the Hog's Back, breaches the Downs at its eastern extremity, the town of Guildford standing at this point. The next gap is that of the Mole, in which Dorking lies. Between Guildford and Dorking the main line of the Downs reaches a height of 712 ft., but a lateral depression, followed by the railway between these towns, marks off on the south a loftier range of lower greensand, in which Leith Hill, famous as a view-point, is 965 ft. in height. East of the Mole the northward slope of the Downs is deeply cut by narrow valleys, and the depression above Redhill may have been traversed by a stream subsequently beheaded by the Mole. A height of 868 ft. is attained east of Caterham. The next river to break through the main line is the Darent, but here another lateral depression, watered by the headstreams of that river, marks off the Ragstone Ridge, south of Sevenoaks, reaching 800 ft. The lateral depression is continued along the valleys of streams tributary to the Medway, so that nearly as far as Ashford the Downs consist of two parallel ranges; but the Medway itself breaches both, Maidstone lying in the gap. The elevation now begins to decrease, and 682 ft. is the extreme height east of the Medway. The direction, hitherto E. by N., trends E.S.E. The final complete breach is made by the Great Stour, between Ashford and Canterbury; east of which a height of 600 ft. is rarely reached. The valley of the Little Stour, however, offers a well-marked pass followed by the Folkestone-Canterbury railway, and the North Downs finally fall to the sea in the grand white cliffs between Dover and Folkestone.

The South Downs present similar characteristics on a minor scale. Springing from the main mass of the chalk to the south of Petersfield they have their greatest elevation (889 ft. in Butser Hill) at that point, and extend E. by S. for 65 m. to the English Channel at the cliffs of Beachy Head. As in the case of the North Downs a succession of rivers breach the hills, and a succession of towns mark the gaps. These are, from east to west, the Arun, with the town of Arundel, the Adur, with Shoreham, the Ouse, with Lewes and Newhaven, and the Cuckmere, with no considerable town. The steep slope of the South Downs is northward towards the Weald. The southern slopes reach the coast east of Brighton, but west of this town a flat coastal belt intervenes, widening westward. Apart from the complete breaches mentioned, the South Downs, scored on the south with many deep valleys, are generally more easily penetrable than the North Downs, and the coast is less continuous.

Smooth convex curves are characteristic of the Downs; their graceful and striking outline gives them an importance in the landscape in excess of their actual height; their flanks are well wooded, their summits covered with close springy turf.

"THE DOWNS" is also the name of a roadstead in the English Channel off Deal between the North and the South Foreland. It forms a favourite anchorage during heavy weather, protected on the east by the Goodwin Sands and on the north and west by the coast. It has depths down to 12 fathoms. Even during southerly gales some shelter is afforded, though under this condition wrecks are not infrequent.

DOWNSHIRE; WILLS HILL, 1ST MARQUESS OF (1718-1793), son of Trevor Hill, 1st Viscount Hillsborough, was born at Fairford in Gloucestershire on the 30th of May 1718. He became an English member of parliament in 1741, and an Irish viscount on his father's death in the following year, thus sitting in both the English and Irish parliaments. In 1751 he was created earl of Hillsborough in the Irish peerage; in 1754 he was made comptroller of the royal household and an English privy councillor; and in 1756 he became a peer of Great Britain as baron of Harwich. For nearly two years he was president of the board of trade and plantations under George Grenville, and after a brief period of retirement he filled the same position, and then that of joint postmaster-general, under the earl of Chatham. From 1768 to 1772 Hillsborough was secretary of state for the colonies and also president of the board of trade, becoming an English earl on his retirement; in 1779 he was made secretary of state for the northern department, and he was created marquess of

¹ Aveyrie, *The Scenery of England*, ch. xi.

Downshire seven years after his final retirement in 1782. Both in and out of office he opposed all concessions to the American colonists, but he favoured the project for a union between England and Ireland. Reversing an earlier opinion Horace Walpole says Downshire was "a pompous composition of ignorance and want of judgment." He died on the 7th of October 1793 and was succeeded by his son Arthur (1753-1801), from whom the present marquis is descended.

DOWRY (in Anglo-Fr. *dowarie*, O. Fr. *douaire*, Med. Lat. *dotaria*, from Lat. *dos*, from root of *dare*, to give; in Fr. *dot*), the property which a woman brings with her at her marriage, a wife's marriage portion (see SETTLEMENT).

DOWSER and **DOWSING** (from the Cornish "dowse," M.E. *duschen*, to strike or fall), one who uses, or the art of using, the dowsing-rod (called "deusing-rod" by John Locke in 1691), or "striking-rod" or divining-rod, for discovering subterranean minerals or water. (See DIVINING-ROD.)

DOXOLOGY (Gr. *δοξολογία*, a praising, giving glory), an ascription of praise to the Deity. The early Christians continued the Jewish practice of making such an ascription at the close of public prayer (Origen, *Περὶ εὐχῆς*, 33) and introduced it after the sermon also. The name is often applied to the Trisagion (tersanctus), or "Holy, Holy, Holy," the scriptural basis of which is found in Isaiah vi. 3, and which has had a place in the worship of the Christian church since the 2nd century; to the Hallelujah of several of the Psalms and of Rev. xix.; to such passages of glorification as Rom. ix. 5, xvi. 27, Eph. iii. 21; and to the last clause of the Lord's Prayer as found in Matt. vi. 13 (A.V.), which critics are generally agreed in regarding as an interpolation, and which, while used in the Greek and the Protestant churches, is omitted in the Roman rite. It is used, however, more definitely as the designation of two hymns distinguished by liturgical writers as the Greater and Lesser Doxologies.

The origin and history of these it is impossible to trace fully. The germ of both is to be found in the Gospels; the first words of the Greater Doxology, or *Gloria in Excelsis*, being taken from Luke ii. 14, and the form of the Lesser Doxology, or *Gloria Patri*, having been in all probability first suggested by Matt. xxviii. 19. The Greater Doxology, in a form approximating to that of the English prayer-book, is given in the *Apostolical Constitutions* (vii. 47). At this time (c. 375) it ran thus: "Glory to God on high, and on earth peace to men of (his) goodwill. We praise thee, we bless thee, we worship thee, we glorify thee, we give thanks to thee for thy great glory. O Lord God, heavenly king, God the Father Almighty; O Lord, the only begotten Son, Jesus Christ; O Lord God, Lamb of God, Son of the Father, that takest away the sins of the world, have mercy upon us; Thou that takest away the sins of the world, receive our prayer; Thou that sittest at the right hand of the Father, have mercy upon us; For Thou alone art holy. Thou only, Jesus Christ, with the Holy Ghost, art most high in the glory of God the Father. Amen." This is the earliest record of it, but it is also found in the Alexandrine Codex. Alcuin attributes the authorship of the Latin form—the *Gloria in Excelsis*—to St Hilary of Poitiers (died 367). The quotations from the hymn in the pseudo-Athanasian *De Virginitate*, and in Chrysostom (*Hom. 69 in Matth.*), include only the opening words (those from St Luke's gospel), though the passage in Athanasius shows by an *et cœtera* that only the beginning of the hymn is given. These references indicate that the hymn was used in private devotions; as it does not appear in any of the earliest liturgies, whether Eastern or Western, its introduction into the public services of the church was probably of a later date than has often been supposed. Its first introduction into the Roman liturgy is due to Pope Symmachus (498-514), who ordered it to be sung on Sundays and festival days. There was much opposition to the expansion, but it was suppressed by the fourth council of Toledo in 633. Until the end of the 11th century its use was confined to bishops, and to priests at Easter and on their installation. The Mozarabic liturgy provides for its eucharistic use on Sundays and festivals. In these and other early liturgies the Greater Doxology occurs immediately after the beginning of the service; in the English prayer-book it introduced at the close

of the communion office, but it does not occur in either the morning or evening service. This doxology is also used in the Protestant Episcopal and Methodist Episcopal churches of America, as indeed in most Protestant churches at the eucharist.

The Lesser Doxology, or *Gloria Patri*, combines the character of a creed with that of a hymn. In its earliest form it ran simply—"Glory be to the Father, and to the Son, and to the Holy Ghost, world without end, Amen," or "Glory be to the Father, in (or through) the Son, and in (or through) the Holy Ghost." Until the rise of the Arian heresy these forms were probably regarded as indifferent, both being equally capable of an orthodox interpretation. When the Arians, however, finding the second form more consistent with their views, adopted it persistently and exclusively, its use was naturally discountenanced by the Catholics, and the other form became the symbol of orthodoxy. To the influence of the Arian heresy is also due the Catholic addition—"as it was in the beginning, is now, and ever shall be," the use of which was, according to some authorities, expressly enjoined by the council of Nicea. There is no sufficient evidence of this, but there exists a decree of the second council of Vaison (529), asserting its use as already established in the East *propter hæreticorum astutiam*, and ordering its adoption throughout the churches of the West. In the Western Church the *Gloria Patri* is repeated at the close of every psalm, in the Eastern Church at the close of the last psalm. This last is the optional rule of the American Episcopal Church.

Metrical doxologies are often sung at the end of hymns, and the term has become especially associated with the stanza beginning "Praise God from whom all blessings flow," with which Thomas Ken, bishop of Winchester, concluded his morning and evening hymns.

See J. Bingham, *Biog. eccles.* xiv. 2; Siegel, *Christl. Alterthümer*, i. 515, &c.; F. Procter, *Book of Common Prayer*, p. 212; W. Palmer, *Orig. Liturg.* iv. § 23; art. "Liturgische Formeln" (by Drews) in Hauck-Herzog, *Realencyk. für prot. Theol.* xi. 547.

DOYEN, GABRIEL FRANÇOIS (1726-1806), French painter, was born at Paris in 1726. His passion for art prevailed over his father's wish, and he became in his twelfth year a pupil of Vanloo. Making rapid progress, he obtained at twenty the Grand Prix, and in 1748 set out for Rome. He studied the works of Annibale Caracci, Cortona, Giulio Romano and Michelangelo, then visited Naples, Venice, Bologna and other Italian cities, and in 1755 returned to Paris. At first unappreciated and disparaged, he resolved by one grand effort to conquer a reputation, and in 1758 he exhibited his "Death of Virginia." It was completely successful, and procured him admission to the Academy. Among his greatest works are reckoned the "Miracle des Ardens," painted for the church of St Geneviève at St Roch (1773); the "Triumph of Thetis," for the chapel of the Invalides; and the "Death of St Louis," for the chapel of the Military School. In 1776 he was appointed professor at the Academy of Painting. Soon after the beginning of the Revolution he accepted the invitation of Catherine II. and settled at St Petersburg, where he was loaded with honours and rewards. He died there on the 5th of June 1806.

DOYLE, SIR ARTHUR CONAN (1859-), English novelist, eldest son of the artist Charles Doyle, was born on the 22nd of May 1859. He was sent to Stonyhurst College, and further pursued his education in Germany, and at Edinburgh University where he graduated M.B. in 1881 and M.D. in 1885. He had begun to practise as a doctor in Southsea when he published *A Study in Scarlet* in 1887. *Micah Clarke* (1888), a tale of Monmouth's rebellion, *The Sign of Four* (1889), and *The White Company* (1891), a romance of Du Guesclin's time, followed. In *Rodney Stone* (1896) he drew an admirable sketch of the prince regent; and he collected a popular series of stories of the Napoleonic wars in *The Exploits of Brigadier Gerard* (1896). In 1891 he attained immense popularity by *The Adventures of Sherlock Holmes*, which first appeared in *The Strand Magazine*. These ingenious stories of the success of the imperturbable Sherlock Holmes, who had made his first appearance in *A Study in Scarlet* (1887), in detecting crime and disentangling mystery, found a host of imitators. The novelist himself returned to his

hero in *The Memoirs of Sherlock Holmes* (1893), *The Hound of the Baskervilles* (1902), and *The Return of Sherlock Holmes* (1905). His later books include numerous novels; plays, *The Story of Waterloo* (1894), in which Sir Henry Irving played the leading part, *The Fires of Fate* (1909), and *The House of Temperley* (1909); and two books in defence of the British army in South Africa—*The Great Boer War* (1900) and *The War in South Africa; its Causes and Conduct* (1902). Dr Conan Doyle served as registrar of the Langman Field Hospital in South Africa, and was knighted in 1902.

DOYLE, SIR FRANCIS HASTINGS CHARLES, Bart. (1810-1888), English man of letters, was born at Nunappleton, Yorkshire, on the 21st of August 1810. He was the son of Major-General Sir Francis Hastings Doyle, 1st baronet (1783-1839), and was educated at Eton and at Christ Church, Oxford, where he took a first-class in classics in 1831. He read for the bar and was called in 1837. He had been elected to a fellowship of All Souls' in 1835, and his interests were chiefly literary. Among his intimate friends was Mr Gladstone, at whose marriage he assisted as "best man"; but in later life their political opinions widely differed. In 1834 he published *Miscellaneous Verses*, reissued with additions in 1840. This was followed by *Two Destinies* (1844), *The Duke's Funeral* (1852), *Return of the Guards and other Poems* (1866); and from 1867 to 1877 he was professor of poetry at Oxford. In 1869 some of the lectures he delivered were published in book form. One of the most interesting was his appreciation of William Barnes, and the essay on Newman's *Dream of Gerontius* was translated into French. In 1886 he published his *Reminiscences*, full of records of the interesting people he had known. Sir Francis Doyle succeeded his father (chairman of the board of excise) as 2nd baronet in 1839, and in 1844 married Sidney, daughter of Charles Watkin Williams Wynn (1775-1850). From 1845 he held various important offices in the customs. He died on the 8th of June 1888. Doyle's poetry is memorable for certain isolated and spirited pieces in praise of British fortitude. The best-known are his ballads on the "Birkenhead" disaster and on "The Private of the Buffs."

DOYLE, JOHN ANDREW (1844-1907), English historian, the son of Andrew Doyle, editor of *The Morning Chronicle*, was born on the 14th of May 1844. He was educated at Eton and at Balliol College, Oxford, winning the Arnold prize in 1868 for his essay, *The American Colonies*. He was a fellow of All Souls' from 1870 until his death, which occurred at Crickhowell, South Wales, on the 4th of August 1907. His principal work is *The English Colonies in America*, in five volumes, as follows: *Virginia, Maryland and the Carolinas* (1 vol., 1882), *The Puritan Colonies* (2 vols., 1886), *The Middle Colonies* (1 vol., 1907), and *The Colonies under the House of Hanover* (1 vol., 1907), the whole work dealing with the history of the colonies from 1607 to 1759. Doyle also wrote chapters i., ii., v. and vii. of vol. vii. of the *Cambridge Modern History*, and edited William Bradford's *History of the Plimouth Plantation* (1896) and the *Correspondence of Susan Ferris* (1898).

DOYLE, RICHARD (1824-1883), English artist, son of John Doyle, the caricaturist known as "H. B." (1797-1868), was born in London in 1824. His father's "Political Sketches" took the town by storm in the days of Lord Grey and Lord Melbourne. The son was an extremely precocious artist, and in his "Home for the Holidays," done when he was twelve, and his "Comic English Histories," drawn four years later, he showed extraordinary gifts of humour and fancy. He had no art training outside his father's studio. In 1843 he joined the staff of *Punch*, drawing cartoons and a vast number of illustrations, but he retired in 1850, in consequence of the attitude adopted by that paper towards what was known as "the papal aggression," and especially towards the pope himself. In 1854 he published his "Continental Tour of Brown, Jones and Robinson." His illustrations to three of the *Christmas Books* of Charles Dickens, and to *The Newcomes* by Thackeray, are reckoned among his principal achievements; and his fanciful pictures of elves and fairies have always been general favourites. He died on the 11th of December 1883. His most popular drawing is his cover of *Punch*.

DOZSA, GYÖRGY (d. 1514), Hungarian revolutionist, was a Szekler squire and soldier of fortune, who won such a reputation for valour in the Turkish wars that the Hungarian chancellor, Tamás Bákokcz, on his return from Rome in 1514 with a papal bull preaching a holy war in Hungary against the Moslems, appointed him to organize and direct the movement. In a few weeks he collected thousands of so-called *Kurucok* (a corruption of *Cruciati*), consisting for the most part of small yeomen, peasants, wandering students, friars and parish priests, the humblest and most oppressed portion of the community, to whom alone a crusade against the Turk could have the slightest attraction. They assembled in their counties, and by the time Dozsa had drilled them into some sort of discipline and self-confidence, they began to air the grievances of their class. No measures had been taken to supply these voluntary crusaders with food or clothing; as harvest-time approached, the landlords commanded them to return to reap the fields, and on their refusing to do so, proceeded to maltreat their wives and families and set their armed retainers upon the half-starved multitudes. Instantly the movement was diverted from its original object, and the peasants and their leaders began a war of extermination against the landlords. By this time Dozsa was losing control of the rabble, which had fallen under the influence of the socialist parson of Czegled, Lőrincz Mészáros. The rebellion was the more dangerous as the town rabble was on the side of the peasants, and in Buda and other places the cavalry sent against the *Kurucok* were unhorsed as they passed through the gates. The rebellion spread like lightning, principally in the central or purely Magyar provinces, where hundreds of manor-houses and castles were burnt and thousands of the gentry done to death by impalement, crucifixion and other 'unspeakable' methods. Dozsa's camp at Czegled was the centre of the *jacquerie*, and from thence he sent out his bands in every direction, pillaging and burning. In vain the papal bull was revoked, in vain the king issued a proclamation commanding the peasantry to return to their homes under pain of death. By this time the rising had attained the dimensions of a revolution; all the feudal levies of the kingdom were called out against it; and mercenaries were hired in haste from Venice, Bohemia and the emperor. Meanwhile Dozsa had captured the city and fortress of Csánad, and signalized his victory by impaling the bishop and the castellan. Subsequently, at Arad, the lord treasurer, István Telegdy, was seized and tortured to death with satanic ingenuity. It should, however, in fairness be added that only notorious bloodsuckers, or obstinately resisting noblemen, were destroyed in this way. Those who freely submitted were always released on parole, and Dozsa not only never broke his given word, but frequently assisted the escape of fugitives. But he could not always control his followers when their blood was up, and infinite damage was done before he could stop it. At first, too, it seemed as if the government were incapable of coping with him. In the course of the summer he took the fortresses of Arad, Lippá and Világos; provided himself with guns and trained gunners; and one of his bands advanced to within five leagues of the capital. But his half-naked, ill-armed ploughboys were at last overmatched by the mailed chivalry of the nobles. Dozsa, too, had become demoralized by success. After Csánad, he issued proclamations which can only be described as nihilistic. His suppression had become a political necessity. He was finally routed at Temesvár by the combined forces of János Zápolya and István Báthory, was captured, and condemned to sit on a red-hot iron throne, with a red-hot iron crown on his head and a red-hot sceptre in his hand. This infernal sentence was actually carried out, and, life still lingering, the half-roasted carcass of the unhappy wretch, who endured everything with invincible heroism, was finally devoured by half-a-dozen of his fellow-rebels, who by way of preparation had been starved for a whole week beforehand.

See Sándor Marki, *Dozsa György* (Hung.). Budapest, 1884.

(R. N. B.)

DOZY, REINHART PIETER ANNE (1820-1883), Dutch Arabic scholar of French (Huguenot) origin, was born at Leiden in February 1820. The Dozys, like so many other contemporary

French families, emigrated to the Low Countries after the revocation of the edict of Nantes, but some of the former appear to have settled in Holland as early as 1647. Dozy studied at the university of Leiden, obtained the degree of doctor in 1844, was appointed an extraordinary professor of history in 1850, and professor in 1857. The first results of his extensive studies in Oriental literature, Arabic language and history, manifested themselves in 1847, when he published Al-Marrakushi's *History of the Almohades* (Leiden, 2nd ed., 1881), which, together with his *Scriptorium Arabum loci de Abbadis* (Leiden, 1846-1863, 3 vols.), his editions of Ibn-Adhari's *History of Africa and Spain* (Leiden, 1848-1852, 3 vols.), of Ibn-Badrūn's *Historical Commentary on the Poem of Ibn-Abdūn* (Leiden, 1848), and his *Dictionnaire détaillé des noms des vêtements chez les Arabes* (Amsterdam, 1845)—a work crowned by the Dutch Institute—stamped Dozy as one of the most learned and critical Arabic scholars of his day. But his real fame as a historian mainly rests on his great work, *Histoire des Musulmans d'Espagne, jusqu'à la conquête de l'Andalousie par les Almoravides, 711-1110* (Leiden, 1861; 2nd ed., *ibid.*, 1881); a graphically written account of Moorish dominion in Spain, which shed new light on many obscure points, and has remained the standard work on the subject. Dozy's *Recherches sur l'histoire et la littérature de l'Espagne pendant le moyen âge* (Leiden, 2 vols., 1849; 2nd and 3rd ed., completely recast, 1860 and 1881) form a useful and wonderfully trenchant supplement to his *Histoire des Musulmans*, in which he mercilessly exposes the many tricks and falsehoods of the monks in their chronicles, and effectively demolishes a good part of the Cid legends. As an Arabic scholar Dozy stands well-nigh unsurpassed in his *Supplément aux dictionnaires arabes* (Leiden, 1877-1881, 2 vols.), a work full of research and learning, a storehouse of Arabic lore. To the same class belongs his *Glossaire des mots espagnols et portugais, dérivés de l'Arabe*, edited with Dr W. H. Engelmann of Leipzig (Leiden, 1866; 2nd ed., 1868), and a similar list of Dutch words derived from the Arabic. Dozy also edited Al Makkari's *Analectes sur l'histoire et la littérature des Arabes d'Espagne* (Leiden, 1855-1861, 2 vols.), and, in conjunction with his friend and worthy successor, Professor De Goeje, at Leiden, Idrisi's *Description de l'Afrique et de l'Espagne* (1866), also the *Calendrier de Cordoue de l'année 901; texte arabe et ancienne traduction latine* (Leiden, 1874). *Het Islamisme (Islamism)*; Haarlem, 1863, 2nd ed., 1880; French translation) is a popular exposition of Mahomedanism, of a more controversial character; and *De Israëlieten te Mekka* ("The Israelites at Mecca," Haarlem, 1864) became the subject of a rather heated discussion in Jewish circles. Dozy died at Leiden in May 1883. (H. T.)

DRACAENA, in botany, a genus of the natural order Liliaceae, containing about fifty species in the warmer parts of the Old World. They are trees or shrubs with long, generally narrow leaves, panicles of small whitish flowers, and berried fruit. The most remarkable species is *Dracaena Draco*, the dragon-tree of the Canary Isles, which reaches a great size and age. The famous specimen in Tenerife, which was blown down by a hurricane in 1868, when measured by Alexander von Humboldt, was 70 ft. high, with a circumference of 45 ft. several feet above the ground. A resin exuding from the trunk is known as dragon's blood (q.v.).

Many of the cultivated so-called Dracaenas belong to the closely-allied genus *Cordylinae*. They are grown for the beauty of form, colour and variegation of their foliage and are extremely useful as decorative stove plants or summer greenhouse plants, or for room and table decoration. They are easy to grow and may be increased by cuttings planted in sandy soil in a temperature of from 65° to 70° by night, the spring being the best time for propagation. The old stems laid flat in a propagating frame will push young shoots, which may be taken off with a heel when 2 or 3 in. long, and planted in sandy peat in 3-in. pots; the tops can also be taken off and struck. The established plants do best in fibry peat made porous by sand. In summer they should have a day temperature of 75°, and in winter one of 65°. Shift as required, using coarser soil as the pots become larger. By the end of the summer the small cuttings will have made nice

plants, and in the spring following they can be kept growing by the use of manure water twice a week. Those intended for the conservatory should be gradually inured to more air by mid-summer, but kept out of cold draughts. When the plants get too large they can be headed down and the tops used for cuttings.

A large number of the garden species of Dracaena are varieties of *Cordylinae terminalis*. *D. Goldiana* is a grandly variegated species from west tropical Africa, and requires more heat.

DRACHMANN, HOLGER HENRIK HERBOLDT (1846-1908), Danish poet and dramatist, son of Dr A. G. Drachmann, a physician at Copenhagen, whose family was of German extraction, was born in Copenhagen on the 9th of October 1846. Owing to the early death of his mother, who was a Dane, the child was left much to his own devices. He soon developed a fondness for semi-poetical performances, and loved to organize among his companions heroic games, in which he himself took such parts as those of Tordenskjold and Niels Juul. His studies were belated, and he did not enter the university until 1865, leaving it in 1866 to become a student in the Academy of Fine Arts. From 1866 to 1870 he was learning, under Professor Sørensen, to become a marine painter, and not without success. But about the latter date he came under the influence of Georg Brandes, and, without abandoning art, he began to give himself more and more to literature. At various periods he travelled very extensively in England, Scotland, France, Spain and Italy, and his literary career began by his sending letters about his journeys to the Danish newspapers. After returning home, he settled for some time in the island of Bornholm, painting seascapes. He now issued his earliest volume of poems, *Digte* (1872), and joined the group of young Radical writers who gathered under the banner of Brandes. Drachmann was unsettled, and still doubted whether his real strength lay in the pencil or in the pen. By this time he had enjoyed a surprising experience of life, especially among sailors, fishermen, students and artists, and the issues of the Franco-German War and the French Commune had persuaded him that a new and glorious era was at hand. His volume of lyrics, *Dampede Melodier* ("Muffled Melodies," 1875), proved that Drachmann was a poet with a real vocation, and he began to produce books in prose and verse with great rapidity. *Ungt Blod* ("Young Blood," 1876) contained three realistic stories of contemporary life. But he returned to his true field in his magnificent *Sange ved Havet; Venezia* ("Songs of the Sea; Venice," 1877), and won the passionate admiration of his countrymen by his prose work, with interludes in verse, called *Deevre fra Grænsen* ("Over the Frontier there," 1877), a series of impressions made on Drachmann by a visit to the scenes of the war with Germany. During the succeeding years he was a great traveller, visiting most of the principal countries of the world, but particularly familiarizing himself, by protracted voyages, with the sea and with the life of man in maritime places. In 1879 he published *Ranker og Roser* ("Tendrils and Roses"), amatory lyrics of a very high order of melody, in which he showed a great advance in technical art. To the same period belongs *Paa Sømands Tro og Love* ("On the Faith and Honour of a Sailor," 1878), a volume of short stories in prose. It was about this time that Drachmann broke with Brandes and the Radicals, and set himself at the head of a sort of "nationalist" or popular-conservative party in Denmark. He continued to celebrate the life of the fishermen and sailors in books, whether in prose or verse, which were the most popular of their day. *Paul og Virginie* and *Lars Kruse* (both 1879); *Osten for Sol og vesten for Maane* ("East of the Sun and Moon," 1880); *Puppe og Sommerfugl* ("Chrysalis and Butterfly," 1882); and *Strandby Folk* (1883) were among these. In 1882 Drachmann published his fine translation, or paraphrase, of Byron's *Don Juan*. In 1885 his romantic play called *Der var en Gang* ("Once upon a Time") had a great success on the boards of the Royal theatre, Copenhagen; and his tragedies of *Vilund Smed* ("Wayland the Smith") and *Bror-Karl* (1897) made him the most popular playwright of Denmark. He published in 1894 a volume of exquisitely fantastic *Melodramas* in rhymed verse, a collection which contains some of Drachmann's most perfect work. His

novel *Med den brede Pensel* ("With a Broad Brush," 1887) was followed in 1890 by *Forskrævet*, the history of a young painter, Henrik Gerhard, and his revolt against his bourgeois surroundings. With this novel is closely connected *Den hellige Ild* ("The Sacred Fire," 1899), in which Drachmann speaks in his own person. There is practically no story in this autobiographical volume, which abounds in lyrical passages. In 1890 he produced his romantic play called *Gurre*; in 1900 a brilliant lyrical drama, *Hallfred Vandrædeshjald*; and in 1903, *Det grønne Haab*. He died in Copenhagen on the 14th of January 1908.

See an article by K. Gjellerup in *Dansk Biografisk Lexikon* vol. iv. (Copenhagen, 1890). (E. G.)

DRACO (7th century B.C.), Athenian statesman, was Archon Eponymus (but see J. E. Sandys, *Constitution of Athens*, p. 12, note) in 621 B.C. His name has become proverbial as an inexorable lawgiver. Up to his time the laws of Athens were unwritten, and were administered arbitrarily by the Eupatridæ. As at Rome by the twelve Tables, so at Athens it was found necessary to allay the discontent of the people by publishing these unwritten laws in a codified form, and Draco, himself a Eupatrid, carried this out. According to Plutarch (*Life of Solon*): "For nearly all crimes there was the same penalty of death. The man who was convicted of idleness, or who stole a cabbage or an apple, was liable to death no less than the robber of temples or the murderer." For the institution of the 51 Ephetae and their relation to the Areopagus in criminal jurisdiction see GREEK LAW. The orator Demades (d. c. 318 B.C.) said that DRACO'S laws were written in blood. Whether this implies peculiar severity, or merely reflects the attitude of a more refined age to the barbarous enactments of a primitive people, among whom the penalty of death was almost universal for all crimes, cannot be decided. According to Suidas, however, in his *Lexicon*, the people were so overjoyed at the change he made, that they accidentally suffocated him in the theatre at Aegina with the rain of caps and cloaks which they flung at him in their enthusiasm.

The appearance in 1891 of Aristotle's lost treatise on the constitution of Athens gave rise to a most important controversy on the subject of Draco's work. From the statements contained in chapter iv. of this treatise, and inferences drawn from them, many scholars attributed to Draco the construction of an entirely new constitution for Athens, the main features of which were: (1) extension of franchise to all who could provide themselves with a suit of armour—or, as Gilbert (*Constitutional Antiquities*, Eng. trans. p. 121) says, to the Zeugite class, from which mainly the hoplites may be supposed to have come; (2) the institution of a property qualification for office (archon xo minae, strategus 100 minae); (3) a council of 401 members (see BOULE); (4) magistrates and councillors to be chosen by lot; further, the four Solonian classes are said to be already in existence.

For some time, especially in Germany, this constitution was almost universally accepted; now, the majority of scholars reject it. The reasons against it, which are almost overwhelming, may be shortly summarized. (1) It is ignored by every other ancient authority, except an admittedly spurious passage in Plato¹; whereas Aristotle says of his laws "they are laws, but he added the laws to an existing constitution" (*Pol. ii. 9. 9*). (2) It is inconsistent with other passages in the *Constitution of Athens*. According to c. vii., Solon repealed all laws of Draco except those relating to murder; yet some of the most modern features of Solon's constitution are found in Draco's constitution. (3) Its ideas are alien to the 7th century. It has been said that the qualification of the strategus was ten times that of the archon. This, reasonable in the 5th, is preposterous in the 7th century, when the archon was unquestionably the supreme executive official. Again, it is unlikely that Solon, a democratic reformer, would have reverted from a democratic wealth qualification such as is attributed to Draco, to an aristocratic birth quali-

fication. Thirdly, if Draco had instituted a hoplite census, Solon would not have substituted citizenship by birth. (4) The terminology of Draco's constitution is that of the 5th, not the 7th, century, whereas the chief difficulty of Solon's laws is the obsolete 6th-century phraseology. (5) Lastly, a comparison between the ideals of the oligarchs under Theramenes (end of 5th century) and this alleged constitution shows a suspicious similarity (hoplite census, nobody to hold office a second time until all duly qualified persons had been exhausted, fine of one drachma for non-attendance in Boule). It is reasonable, therefore, to conclude that the constitution of Draco was invented by the school of Theramenes, who wished to surround their revolutionary views with the halo of antiquity; hence the allusion to "the constitution of our father" (*ἡ πατρὸς πολιτεία*).

This hypothesis is further corroborated by a criticism of the text. Not only is chapter iv. considered to be an interpolation in the text as originally written, but later chapters have been edited to accord with it. Thus chapter iv. breaks the connexion of thought between chapters iii. and v. Moreover, an interpolator has inserted phrases to remove what would otherwise have been obvious contradictions: thus (a) in chapter vii., where we are told that Solon divided the citizens into four classes (*τετρακταρά*), the interpolator had added the words "according to the division formerly existing" (*καθάπερ ἄρχηται καὶ πρότερον*), which were necessary in view of the statement that Draco gave the franchise to the Zeugites; (b) in chapter xli., where successive constitutional changes are recorded, the words "the Draconian" (*ἡ ἐπὶ Δρακωντος*) are inserted, though the subsequent figures are not accommodated to the change. Solon is also here spoken of as the founder of democracy, whereas the Draconian constitution of chap. iv. contains several democratic innovations. Two further points may be added, namely, that whereas Aristotle's treatise credits Draco with establishing a money fine, Pollux definitely quotes a law of Draco in which fines are assessed at so many oxen, secondly, if chapter iv. did exist in the original text, it is more than curious that though the treatise was widely read in antiquity there is no other reference to Draco's constitution except the two quoted above. In any case, whatever were Draco's laws, we learn from Plutarch's life of Solon that Solon abolished all of them, except those dealing with homicide.

AUTHORITIES.—Beside the works of J. E. Sandys and G. Gilbert quoted above, see those quoted in article CONSTITUTION OF ATHENS; Grote, *Hist. of Greece* (ed. 1907), pp. 9-11, with references; and histories of Greece published after 1894. (J. M. M.)

DRACO ("the Dragon"), in astronomy, a constellation of the northern hemisphere, mentioned by Eudoxus (4th century B.C.) and Aratus (3rd century B.C.); it was catalogued by Ptolemy, 31 stars, Tycho Brahe, 32, Hevelius, 40. The Greeks had many fables concerning this constellation; one is that when Heracles killed the dragon guarding the Hesperian fruit Hera transferred the creature to heaven as a reward for its services. The planetary nebula *H. IV. 37 Draconis* is of a decided pale blue colour, and one of the most conspicuous objects of its class.

DRACONTIUS, BLOSSIUS AEMILIUS, of Carthage (according to the early tradition, of Spanish origin), Christian poet, flourished in the latter part of the 5th century A.D. He belonged to a family of landed proprietors, and practised as an advocate in his native place. After the conquest of the country by the Vandals, Dracontius was at first allowed to retain possession of his estates, but was subsequently deprived of his property and thrown into prison by the Vandal king, whose triumphs he had omitted to celebrate, while he had written a panegyric on a foreign and hostile ruler. He subsequently addressed an elegiac poem to the king, asking pardon and pleading for release. The result is not known, but it is supposed that Dracontius obtained his liberty and migrated to northern Italy in search of peace and quietness. This is consistent with the discovery at Bobbio of a 15th-century MS., now in the Museo Borbonico at Naples, containing a number of poems by Dracontius (the *Carmina minor*). The most important of his works is the *De laudibus Dei* or *De Deo* in three books, wrongly attributed by MS. tradition to St Augustine. The account of the creation,

¹ A passage (long overlooked) in Cicero, *De republica*, shows that, by the 1st century B.C. the interpolation had already been made; the quotation is evidently taken from the list in c. xli. of the *constitution*, which it reproduces.

which occupies the greater part of the first book, was at an early date edited separately under the title of *Hexameron*, and it was not till 1791 that the three books were edited by Cardinal Arevalo. The apology (*Satisfactio*) consists of 158 elegiac couplets; it is generally supposed that the king addressed is Gunthamund (484-496). The *Carmina minora*, nearly all in hexameter verse, consist of school exercises and rhetorical declamations, amongst others the fable of Hylas, with a preface to his tutor, the grammarian Felicianus; the rape of Helen; the story of Medea; two epithalamia. It is also probable that Dracontius was the author of the *Orestis tragœdia*, a poem of some 1000 hexameters, which in language, metre and general treatment of the subject exhibits a striking resemblance to the other works of Dracontius. Opinions differ as to his poetical merits, but, when due allowance is made for rhetorical exaggeration and consequent want of lucidity, his works show considerable vigour of expression, and a remarkable knowledge of the Bible and of Roman classical literature.

ERRORNS.—*De Deo and Satisfactio*, ed. Arevalo, reprinted in Migne's *Patrologia cursus*, lx.; *Carmina minora*, ed. F. de Duhn (1873). On Dracontius generally, see A. Ebert, *Allgemeine Geschichte der Lit. des Mittelalters im Abendlande*, i. (1874); C. Rosenberg, *In D. Carmina minora* (1878); H. Mailait, *De Dracontii poetæ lingua* (1902). On the *Orestis tragœdia*, see editions by R. Peiper (1875) and C. Giarratino (Milan, 1906); pamphlets by C. Rosenberg (1880, on the authorship; 1888, materials for a commentary).

DRAFTED MASONRY, in architecture, the term given to large stones, on the face of which has been dressed round the edge a draft or sunken surface, leaving the centre portion as it came from the quarry. The dressing is worked with an adze of eight teeth to the inch, used in a vertical direction and to a width of 2 to 4 in. The earliest example of drafted masonry is found in the immense platform built by Cyrus 530 B.C. at Pasargadae in Persia. It occurs again in the palace of Hyrcanus, known as the Arak-el-Emir (176 B.C.), but is there inferior in execution. The finest drafted masonry is that dating from the time of Herod, in the tower of David and the walls of the Haram in Jerusalem, and at Hebron. In the castles built by the Crusaders, the adze has been worked in a diagonal direction instead of vertically. In all these examples the size of the stones employed is sometimes enormous, so that the traditional influence of the Phœnician masons seems to have lasted till the 12th century.

DRAG (from the Old Eng. *dragan*, to draw; the word preserves the *g* which phonetically developed into *w*), that which is drawn or pulled along a surface, or is used for drawing or pulling. The term is thus applied to a barrow for breaking up clods of earth, or for an apparatus, such as a grapnel, net or dredge, used for searching water for drowned bodies or other objects. As a name of a vehicle, "drag" is sometimes used as equivalent to "break," a heavy carriage without a body used for training horses, and also a large kind of wagonette, but is more usually applied to a privately owned four-horse coach for four-in-hand driving. The word is also given to the "shoe" of wood or iron, placed under the wheel to act as a brake, and also to the "drift" or "sea-anchor," usually made of spars and sails, employed for checking the lee-way of a ship when drifting. In fox-hunting, the "drag" is the line of scent left by the fox, but more particularly the term is given to a substitute for the hunting of a fox by bounds, an artificial line of scent being laid by the dragging of a bag of aniseed or other strong smelling substance which a pack will follow.

DRAGASHANI (Rumanian *Dragăşani*), a town of Rumania, near the right bank of the river Olt, and on the railway between Caracal and Râmnicu Vâlcea. Pop. (1900) 4398. The town is of little commercial importance, but the vineyards on the neighbouring hills produce some of the best Walachian wines. Dragashani stands on the site of the Roman Rusidava. In 1821 the Turks routed the troops of Ypsilanti near the town.

DRAGOMAN (from the Arabic *ترجمان* *terjuman*, an interpreter or translator; the same root occurs in the Hebrew word *terjuman* signifying translation, the title of the Chaldean translation of the Bible), a comprehensive designation applied to all who act as intermediaries between Europeans and Orientals, from the

hotel tout or travellers' guide, hired at a few shillings a day, to the chief dragoman of a foreign embassy whose functions include the carrying on of the most important political negotiations with the Ottoman government, or the dragoman of the imperial divan (the grand master of the ceremonies).

The original employment of dragomans by the Turkish government arose from its religious scruples to use any language save those of peoples which had adopted Islamism. The political relations between the Porte and the European states, more frequent in proportion as the Ottoman power declined, compelled the sultan's ministers to make use of interpreters, who rapidly acquired considerable influence. It soon became necessary to create the important post of chief dragoman at the Porte, and there was no choice save to appoint a Greek, as no other race in Turkey combined the requisite knowledge of languages with the tact and adroitness essential for conducting diplomatic negotiations. The first chief dragoman of the Porte was Panayot Nikousia, who held his office from 1665 to 1673. His successor, Alexander Mavrocordat, surnamed Exaporritos, was charged by the Turkish government with the delicate and arduous negotiation of the treaty of Carlowitz, and by his dexterity succeeded, in spite of his questionable fidelity to the interests of his employers, in gaining their entire confidence, and in becoming the factotum of Ottoman policy. From that time until 1821 the Greeks monopolized the management of Turkey's foreign relations, and soon established the regular system whereby the chief dragoman passed on as a matter of course to the dignity of hospodar of one of the Danubian principalities.

In the same way, the foreign representatives accredited to the Porte found it necessary, in the absence of duly qualified countrymen of their own, to engage the services of natives, Greek, Armenian, or Levantine, more or less thoroughly acquainted with the language, laws and administration of the country. Their duties were by no means confined to those of a mere translator, and they became the confidential and indispensable go-betweens of the foreign missions and the Porte. Though such dragomans enjoyed by treaty the protection of the country employing them, they were by local interests and family ties very intimately connected with the Turks, and the disadvantages of the system soon became apparent. Accordingly as early as 1669 the French government decided on the foundation of a school for French dragomans at Constantinople, for which in later years was substituted the *École des langues orientales* in Paris; most of the great powers eventually took some similar step, England also adopting in 1877 a system, since modified, for the selection and tuition of a corps of British-born dragomans.

The duties of an embassy dragoman are extensive and not easily defined. They have been described as partaking at once of those of a diplomatist, a magistrate, a legal adviser and an administrator. The functions of the first dragoman are mainly political; he accompanies the ambassador or minister at his audiences of the sultan and usually of the ministers, and it is he who is charged with the bulk of diplomatic negotiations at the palace or the Porte. The subordinate dragomans transact the less important business, comprising routine matters such as requests for the recognition of consuls, the settlement of claims or furthering of other demands of their nationals, and in general all the various matters in which the interests of foreign subjects may be concerned. An important part of the dragoman's duties is to attend during any legal proceedings to which a subject of his nationality is a party, as failing his attendance and his concurrence in the judgment delivered such proceedings are null and void. Moreover, the dragoman is frequently enabled, through the close relations which he necessarily maintains with different classes of Turkish officials, to furnish valuable and confidential information not otherwise obtainable. The high estimation in which the dragomans are held by most foreign powers is shown by the fact that they are usually and in the regular course promoted to the most important diplomatic posts. This is the case in the Russian and Austrian services (where more than one ambassador began his career as a junior dragoman)

and generally in the German service; the French chief dragoon usually attains the rank of minister plenipotentiary. The value of a tactful and efficient intermediary can hardly be over-estimated, and in the East a personal interview of a few minutes often results in the conclusion of some important matter which would otherwise require the exchange of a long and laborious correspondence. The more important consulates in the provinces of Turkey are also provided with one or more dragomans, whose duties, *mutatis mutandis*, are of a similar though less important nature. In the same way banks, railway companies and financial institutions employ dragomans for facilitating their business relations with Turkish officials.

DRAGOMIROV, MICHAEL IVANOVICH (1830-1905), Russian general and military writer, was born on the 8th of November 1830. He entered the Guard infantry in 1849, becoming 2nd lieutenant in 1852 and lieutenant in 1854. In the latter year he was selected to study at the Nicholas Academy (staff college), and here he distinguished himself so much that he received a gold medal, an honour which, it is stated, was paid to a student of the academy only twice in the 19th century. In 1856 he was promoted staff-captain and in 1858 full captain, being sent in the latter year to study the military methods in vogue in other countries. He visited France, England and Belgium, and wrote voluminous reports on the instructional and manoeuvre camps of these countries at Châlons, Aldershot and Beverloo. In 1859 he was attached to the headquarters of the king of Sardinia during the campaign of Magenta and Solferino, and immediately upon his return to Russia he was sent to the Nicholas Academy as professor of tactics. Dragomirov played a leading part in the reorganization of the educational system of the army, and acted also as instructor to several princes of the imperial family. This post he held until 1863, when, as a lieutenant-colonel, he took part in the suppression of the Polish insurrection of 1863-64, returning to St Petersburg in the latter year as colonel and chief of staff to one of the Guard divisions. During the Austro-Prussian War of 1866, Dragomirov was attached to the headquarters of the II. Prussian army. He was present at the battles on the upper Elbe and at Königgrätz, and his comments on the operations which he witnessed are of the greatest value to the student of tactics and of the war of 1866.

In 1868 he was made a major-general, and in the following year became chief of the staff in the Kiev military circumscription. In 1873 he was appointed to command the 14th division, and in this command he distinguished himself very greatly in the Russo-Turkish War of 1877-78. The 14th division led the way at the crossing of the Danube at Zimnitsa, Dragomirov being in charge of the delicate and difficult operation of crossing and landing under fire, and fulfilling his mission with complete success. Later, after the reverses before Plevna, he, with the cesarevich and Generals Todleben and Milutine, strenuously opposed the suggestion of the Grand-duke Nicholas that the Russian army should retreat into Rumania, and the demoralization of the greater part of the army was not permitted to spread to Dragomirov's division, which retained its discipline unimpaired and gave a splendid example to the rest.

He was wounded at the Shipka Pass, and, though promoted lieutenant-general soon after this, was not able to see further active service. He was also made adjutant-general to the tsar and chief of the 53rd Volhynia regiment of his old division. For eleven years thereafter General Dragomirov was chief of the Nicholas Academy, and it was during this period that he collated and introduced into the Russian army all the best military literature of Europe, and in many other ways was active in improving the moral and technical efficiency of the Russian officer-corps, especially of the staff officer. In 1889 Dragomirov became commander-in-chief of the Kiev military district, and governor-general of Kiev, Podolsk and Volhynia, retaining this post until 1903. He was promoted to the rank of general of infantry in 1891. His advanced age and failing health prevented his employment at the front during the Russo-Japanese war of 1904-5, but his advice was continually solicited by the general staff at St Petersburg, and while he disagreed with

General Kuropatkin in many important questions of strategy and military policy, they both recommended a repetition of the strategy of 1812, even though the total abandonment of Port Arthur was involved therein. General Dragomirov died at Konotop on the 28th of October 1905. In addition to the orders which he already possessed, he received in 1901 the order of St Andrew.

His larger military works were mostly translated into French, and his occasional papers, extending over a period of nearly fifty years, appeared chiefly in the *Voennii Sbornik* and the *Rassledschik*; his later articles in the last-named paper were, like the general orders he issued to his own troops, attentively studied throughout the Russian army. His critique of Tolstoy's *War and Peace* attracted even wider attention. Dragomirov was, in formal tactics, the head of the "orthodox" school. His conservatism was not, however, the result of habit and early training, but of deliberate reasoning and choice. His model was, as he admitted in the war of 1866, the British infantry of the Peninsular War, but he sought to reach the ideal, not through the methods of repression against which the "advanced" tacticians revolted, but by means of thorough efficiency in the individual soldier and in the smaller units. He inculcated the "offensive at all costs," and the combination of crushing short-range fire and the bayonet charge. He carried out the ideas of Suvarov to the fullest extent, and many thought that he pressed them to a theoretical extreme unattainable in practice. His critics, however, did not always realize that Dragomirov depended, for the efficiency his unit required, on the capacity of the leader, and that an essential part of the self-sacrificing discipline he exacted from his officers was the power of assuming responsibility. The details of his brilliant achievement of Zimnitsa suffice to give a clear idea of Dragomirov's personality and of the way in which his methods of training conduced to success.

DRAGON (Fr. *dragon*, through Lat. *draco*, from the Greek; connected with *δρακων*, "see," and interpreted as "sharp-sighted"; O.H. Ger. *tracho*, *dracho*, M.H.G. *trache*, Mod. Ger. *Drachen*; A.S. *draca*, hence the equivalent English form "drake," "fire-drake," cf. Low Ger. and Swed. *drake*, Dan. *drage*), a fabulous monster, usually conceived as a huge winged fire-breathing lizard or snake. In Greece the word *δρακων* was used originally of any large serpent, and the dragon of mythology, whatever shape it may have assumed, remains essentially a snake. For the part it has played in the myths and cults of various peoples and ages see the article SERPENT-WORSHIP. Here it may be said, in general, that in the East, where snakes are large and deadly (Chaldea, Assyria, Phoenicia, to a less degree in Egypt), the serpent or dragon was symbolic of the principle of evil. Thus Apophis, in the Egyptian religion, was the great serpent of the world of darkness vanquished by Ra, while in Chaldea the goddess TĪāmat, the female principle of primeval Chaos, took the form of a dragon. Thus, too, in the Hebrew sacred books the serpent or dragon is the source of death and sin, a conception which was adopted in the New Testament and so passed into Christian mythology. In Greece and Rome, on the other hand, while the oriental idea of the serpent as an evil power found an entrance and gave birth to a plentiful brood of terrors (the serpents of the Gorgons, Hydra, Chimaera and the like), the *dracones* were also at times conceived as beneficent powers, sharp-eyed dwellers in the inner parts of the earth, wise to discover its secrets and utter them in oracles, or powerful to invoke as guardian genii. Such were the sacred snakes in the temples of Aesculapius and the *sacri dracones* in that of the Bona Dea at Rome; or, as guardians, the Python at Delphi and the dragon of the Hesperides.

In general, however, the evil reputation of dragons was the stronger, and in Europe it outlived the other. Christianity, of course, confused the benevolent and malevolent serpent-deities of the ancient cults in a common condemnation. The very "wisdom of the serpent" made him suspect; the devil, said St Augustine, "leo et draco est; leo propter impetum, draco propter insidias." The dragon myths of the pagan East took new shapes in the legends of the victories of St Michael and

St George; and the kindly snakes of the "good goddess" lived on in the *immansissimus draco* whose baneful activity in a cave of the Capitol was cut short by the intervention of the saintly pope Silvester I. (Duchesne, *Liber pontificalis*, i. 100 seq.). In this respect indeed Christian mythology found itself in harmony with that of the pagan North. The similarity of the Northern and Oriental snake myths seems to point to some common origin in an antiquity too remote to be explored. Whatever be the origin of the Northern dragon, the myths, when they first become articulate for us, show him to be in all essentials the same as that of the South and East. He is a power of evil, guardian of hoards, the greedy withholder of good things from men; and the slaying of a dragon is the crowning achievement of heroes—of Siegmund, of Beowulf, of Sigurd, of Arthur, of Tristram—even of Lancelot, the *beau idéal* of medieval chivalry. Nor were these dragons anything but very real terrors, even in the imaginations of the

sky. The belief in dragons and the conceptions of their shape were undoubtedly often determined, in Europe as in China, by the discovery of the remains of the gigantic extinct saurians.

The qualities of dragons being protective and terror-inspiring, and their effigies highly decorative, it is natural that they should have been early used as warlike emblems. Thus, in Homer (*Iliad* xl. 36 seq.), Agamemnon has on his shield, besides the Gorgon's head, a blue three-headed snake (*βράσιον*), just as ages afterwards the Norse warriors painted dragons on their shields and carved dragons' heads on the prows of their ships. From the conquered Dacians, too, the Romans in Trajan's time borrowed the dragon ensign which became the standard of the cohort as the eagle was that of the legion; whence, by a long descent, the modern dragon. Under the later East Roman emperors the purple dragon ensign became the ceremonial standard of the emperors, under the name of the *δρακονοειρον*. The imperial fashion spread; or similar causes elsewhere produced similar results. In England before the Conquest the dragon was chief among the royal ensigns in war. Its origin, according to the legend preserved in the *Flores historiarum*, was as follows. Uther Pendragon, father of King Arthur, had a vision of a flaming dragon in the sky, which his seers interpreted as meaning that he should come to the kingdom. When this happened, after the death of his brother Aurelius, "he ordered two golden dragons to be fashioned, like to those he had seen in the circle of the star, one of which he dedicated in the cathedral of Winchester, the other he kept by him to be carried into battle." From Uther Dragon-head, as the English called him, the Anglo-Saxon kings borrowed the ensign, their custom being, according to the *Flores*, to stand in battle *inter draconem et standardum*. The dragon ensign, which was borne before Richard I. in 1191 when on crusade "to the terror of the heathen beyond the sea," was that of the dukes of Normandy; but even after the loss of Normandy the dragon was the battle standard of English kings (*signum regium, quod Draconem vocant*), and was displayed, e.g. by Henry III. in 1245 when he went to war against the Welsh. Not till the 20th century, under King Edward VII., was the dragon officially restored as proper only to the British race of Uther Pendragon, by its incorporation in the armorial bearings of the prince of Wales. As a matter of fact, however, the dragon ensign was common to nearly all nations, the reason for its popularity being naively stated in the romance of *Athis* (quoted by Du Cange),

"Ce souloient Romains porter,
Ce nous fait moult à redouter."

"This the Romans used to carry, This makes us very much to be feared." Thus the dragon and wyvern (i.e. a two-legged snake, M.E. *winare*, viper) took their place as heraldic symbols (see HERALDRY).

As an ecclesiastical symbol it has remained consistent to the present day. Wherever it is represented it means the principle of evil, the devil and his works. In the middle ages the chief of these works was heresy, and the dragon of the medieval church legends and mystery plays was usually heresy. Thus the knightly order of the vanquished dragon, instituted by the emperor Sigismund in 1418, celebrated the victory of orthodoxy over John Huss. Hell, too, is represented in medieval art as a dragon with gaping jaws belching fire. Of the dragons carried in effigy in religious processions some have become famous, e.g. the Gargouille (gargoyle) at Rouen, the Grailly at Metz, and the Tarascon at Tarascon. Their popularity tended to disguise their evil significance and to restore to them something of the beneficent qualities of the ancient *dracones* as local tutelary genii.

In the East, at the present day, the dragon is the national symbol of China and the badge of the imperial family, and as such it plays a large part in Chinese art. Chinese and Japanese dragons, though regarded as powers of the air, are wingless. They are among the deified forces of nature of the Taoist religion, and the shrines of the dragon-kings, who dwell partly in water and partly on land, are set along the banks of rivers.

The constellation Draco (*anguis, serpens*) was probably so



Dragon Lizard (*Draco taeniopterus*).

learned, until comparatively modern times. As the waste places were cleared, indeed, they withdrew farther from the haunts of men, and in Europe their last lurking-places were the inaccessible heights of the Alps, where they lingered till Jacques Balmain set the fashion which has finally relegated them to the realm of myth. In the works of the older naturalists, even in the great *Historia animalium* of so critical a spirit as Conrad Gesner (d. 1564), they still figure as part of the fauna known to science.

As to their form, this varied from the beginning. The Chaldaean dragon Tiamat had four legs, a scaly body, and wings. The Egyptian Apophis was a monstrous snake, as were also, originally at least, the Greek *dracontes*. The dragon of the Apocalypse (Rev. xii. 3), "the old serpent," is many-headed, like the Greek Hydra. The dragon slain by Beowulf is a snake (worm), for it "buckles like a bow"; but that done to death by Sigurd, though its motions are heavy and snake-like, has legs, for he wounds it "behind the shoulder." On the other hand, the dragon seen by King Arthur in his dreams is, according to Malory, winged and active, for it "swoughs" down from

called from its fanciful likeness to a snake. Numerous myths, in various countries, are however connected with it. The general character of these may be illustrated by the Greek story which explains the constellation as being the dragon of the Hesperides slain by Heracles and translated by Hera or Zeus to the heavens.

See C. V. Daremberg and E. Saglio, *Dictionnaire des antiquités grecques et romaines* (Paris, 1886, etc.), s.v. "Draco"; Fauly-Wisnowa, *Reencyclopédie*, s.v. "Drakon"; Du Cange, *Glossarium*, s.v. "Draco"; *La Grande Encyclopédie*, s.v. "Dragon"; J. B. Panthot, *Histoire des dragons et des escaraboués* (Lyons, 1691). See also the articles EGYPT: Religion, and BABYLONIAN AND ASSYRIAN RELIGION. (W. A. P.)

In zoology the name "dragon" is now applied to a highly interesting, but very harmless, group of small flying lizards forming the genus *Draco*, belonging to the *Agamidae*, a family of Saurian reptiles. About 20 species of "flying dragons" inhabit the various Indo-Malayan countries; one, *D. dussumieri*, occurs in Madras. They are small creatures, measuring about 20 in. long, including the tail, which in some cases is more than half of the entire length. The head is small, and the throat is provided with three pouches which are spread out when they lie on the trunks of trees. They are, however, chiefly remarkable for the wing-like cutaneous processes with which their sides are provided, and which are extended and supported by greatly elongated ribs. These form a sort of parachute by which the animals are enabled to glide from branch to branch of the trees on which they live, but, being altogether independent of the fore limbs, they cannot be regarded as true wings, nor do they enable the lizard to fly, but merely to make extensive leaps. But they have the habit of opening and folding these prettily coloured organs, when resting upon a branch, which gives them the appearance of butterflies. When not in use they are folded by the side after the manner of a fan, and the dragon can then walk or run with considerable agility. Its food consists of insects.

DRAGONETTI, DOMENICO (1763-1846), Italian double-bass player, was born in Venice on the 7th of April 1763. Having become famous as a performer on his instrument, he went to London in 1794, where his playing created a furor. He was the friend of Haydn and of Beethoven, and a well-known character in his day. He died in London on the 16th of April 1846.

DRAGON-FLY (Ger. *Wasserjungfer*; Swed. *trollslända*; Dan. *guldsmed*; Dutch, *skerpslekedevlieg*; Fr. *démouille*), the popular English name applied to the members of a remarkable group of insects which formed the genus *Libellula* of Linnaeus and the ancient authors. In some parts of the United States they appear to be known as "devil's darning needles," and in many parts of England are termed "horse-stingers." It is almost needless to say that (excepting to other insects upon which they prey) they are perfectly innocuous, though some of the larger species can inflict a momentarily painful bite with their powerful jaws. Their true systematic position is still contested and somewhat uncertain. By most of the older systematists they were placed as forming part of the heterogeneous order *Neuroptera*. J. C. Fabricius, however, elevated them to the rank of a distinct order, which he termed *Odonata*; and whatever may be the difference of opinion amongst authors at the present day, that term is almost universally employed for the group. W. F. Erichson transferred all the groups of so-called *Neuroptera* with incomplete metamorphoses, hence including the dragon-flies, as a division of *Orthoptera*, which he termed *Pseudo-Neuroptera*. K. E. A. Gerstaecker more recently also retains them in the *Orthoptera*, terming those groups in which the earlier states are subaquatic *Orthoptera amphibotica*. All entomologists are agreed in maintaining the insects as forming a group marked by characters at once extraordinary and isolated in their nature, and in most modern classifications they are treated as a distinct order.

The group *Odonata* is divided into three families, and, each of these again into two subfamilies. The families are the *Agri-*

families *Calopterygina* and *Argonina*, the second *Gomphina* and *Aeschnina*, and the third *Cordulina* and *Libellulina*.

Anatomy.—The structure of a dragon-fly being so very remarkable, it is necessary to enter somewhat extensively into details. The head is comparatively small, and excavated posteriorly, connected very slightly with the prothorax, on which it turns almost as on a pivot. The eyes are, as a rule, enormous, often contiguous, and occupying nearly the whole of the upper surface of the head, but sometimes (*Argonidae* and *Gomphina*) widely distant; occupied by innumerable facets, which are often larger on the upper portion. The antennae, which are smaller in proportion than in almost any other insects, consist only of two short swollen basal joints and a 5 or 6-jointed bristle-like thread. The large labrum conceals the jaws and inner mouth parts. The lower lip, or labium (formed by the conjoined second maxillae), is attached to a very small chin piece (or mentum), and is generally very large, often (*Argonidae*) divided almost to its base into two portions, or more frequently entire or nearly so; on each side of it are two usually enormous hypertrophied pieces, which form the "palpi," and which are often furnished at the tips with an articulated spine (or terminal joint), the whole structure serving to retain the prey. Considerable diversity of opinion exists with respect to the composition of the mouth parts, and by some authors the "palpi" have been termed the side pieces of the lower lip. The prothorax is extremely small, consisting of only a narrow ring. The rest of the thorax is very large, and consolidated into a single piece with oblique sutures on the sides beneath the wings.

The abdomen varies excessively in form, the two extremes being the filiform structure observable in most *Argonidae*, and the very broad and depressed formation seen in the familiar British *Libellula depressa*. It consists of ten distinct segments, whereof the basal two and those at the apex are short, the others elongate, the first being excessively short. In a slit on the under side of the second in the male, accompanied by external protuberances, are concealed the genital organs: on the under side of the eighth in the female is a scale-like formation, indicating the entrance to the oviduct. The tenth is always provided in both sexes with prominent appendages, differing greatly in form, and often furnishing the best specific (and even generic) characters.

The legs vary in length and stoutness, but may, as a rule, be termed long and slender. The anterior pair probably assist in capturing and holding insect prey, but the greatest service all the legs render is possibly in enabling the creature to rest lightly, so that it can quit a position of repose in chase of passing prey in the quickest possible manner. The coxa is short and stout, followed by a still shorter trochanter; the femora and tibiae long and slender, almost invariably furnished on their under surface with two series of strong spines, as also are the tarsi, which consist of three slender joints, the last having two long and slender claws.

The wings are always elongate, and furnished with strong longitudinal neurulation and dense transverse nervules strengthening the already strong (although typically transparent) membrane. In the *Argonidae* both pairs are nearly equal, and are carried vertically and longitudinally in repose, and the neurulation and membrane are less strong; hence the species of this family are not so powerful on the wing as are those of the other groups in which the wings are horizontally extended in a position ready for instant service. The neurulation is peculiar, and in many respects without precise analogy in other groups of insects, but it is not necessary here to enter into more than some special points. The arrangement of the nervules at the base of the wing is very singular, and slight differences in it form useful aids to classification. In the *Aeschnidae* and *Libellulidae* this arrangement results in the formation of a triangular space (known as the "triangle"), which is either open or traversed by nervules; but in many *Argonidae* this space, instead of being triangular, is oblong or elongately quadrate, or with its upper edge partly straight and partly oblique. This fixture of type in neurulation is not one of the least important of the many peculiarities exhibited in these insects.

The internal structure is comparatively simple. The existence of salivary glands, denied by L. Duprix, has been asserted by O. Poletajewa. The rest of the digestive apparatus consists of an elongate canal extending from mouth to anus, comprising the oesophagus, stomach and intestine, with certain dilations and constrictions; the characteristic Malpighian vessels are stated to number about forty, placed round the posterior extremity of the stomach. Dragon-flies eat their prey completely, and do not content themselves by merely sucking its juices; the harder portions are rejected as elongate, nearly dry, pellets of excrement.

Pairing.—But the most extraordinary feature in the economy—one which has attracted the attention of naturalists from remote times—is the position of the genital organs; and the corresponding anomalous manner in which the pairing of the sexes and impregnation is effected. In the male the intromittent organ is situated in a slit on the under surface of the second abdominal segment; it is usually very crooked or sinuous in form, and is accompanied by sheaths, and by external hooks or secondary appendages, and also by seminal vessels. But the ducts of the vessels connected with the testes unite and open on the under surface of the ninth segment; hence, before copulation can take place, it is necessary that the vessels in the second

segment be charged from this opening, and in the majority of cases this is done by the male previously to seeking the female. In the latter sex the entrance to the oviduct and genital organs is on the under surface of the eighth abdominal segment. The act of pairing may be briefly stated as follows. The male, when flying, seizes the prothorax of the female with the strong appendages at the extremity of the abdomen, and the abdomen of this latter sex is then curved upward so as to bring the under side of the eighth segment into



FIG. 1.—The anterior portion of the body of *Aeschna cyanea* freed from the nymph-cuticle.



FIG. 2.—The tail being extricated.

contact with the organs of the second segment of the male. In the more powerful *Libellulidae*, &c., the act is of short duration, and it is probable that polygamy and polyandry exist, for it possibly requires more than one almost momentary act to fertilize all the eggs in the ovaries of a female. But in many *Agrionidae*, and in some others, the male keeps his hold of the prothorax of the female for a lengthened period, retaining himself in flight in an almost perpendicular manner, and it may be that the deposition of eggs and pairing goes on alternately. There is, however, much yet to be learned on these points. The gravid female usually lays her eggs in masses (but perhaps sometimes singly), and the operation may be witnessed by any one in localities frequented by these insects. She hovers for a considerable time over nearly the same spot, rapidly dipping the apex of her abdomen into the water, or at any rate touching it, and often in places where there are no water-weeds,



FIG. 3.—The whole body extricated.

less than a year, but precise evidence is wanting as to the occurrence of two broods in one year. On the other hand, it is certain that often a longer period is requisite to enable the creature to attain its full growth, and three years have been stated to be necessary for this in the large and powerful

Anax formosus. Like all insects with incomplete metamorphoses, there is no quiescent pupal condition, no sharp line of demarcation between the larval and so-called "nymph" or penultimate stage. The creature goes on eating and increasing in size from the moment it emerges from the egg to the time when it leaves the water to be transformed into the aerial perfect insect. The number of moults is uncertain, but they are without doubt numerous. At probably about the antepenultimate of these operations, the rudimentary wings begin to appear as thoracic buddings, and in the full-grown nymph these wings overlap about one-half of the dorsal surface of the abdomen. In structure there is a certain amount of resemblance to the perfect insect, but the body is always much stouter and shorter, in some cases most disproportionately so, and the eyes are always separated; even in those genera (*e.g. Aeschna*) in which the eyes of the imago are absolutely contiguous, the most that can be seen in the larva is a prolongation towards each other, and there are no ocelli. The legs are shorter and more fitted for crawling about water plants and on the bottom. In the mouth parts the mandibles and maxillae are similar in form to those of the adult,

but there is an extraordinary and unique modification of the lower lip. This is attached to an elongate and slender mentum articulated to the posterior portion of the lower surface of the head, slightly widened at its extremity, to which is again articulated the labium proper, which is very large, flattened, and gradually dilated to its extremity; but its form differs according to group as in the perfect insect. Thus in the *Agrionidae* it is deeply cleft, and with comparatively slender side-pieces (or palpi), and strongly developed articulated spines; in the *Aeschnidae* it is at the most notched, with narrow side-pieces and very strong spines; in the *Libellulidae* it is entire, often triangular at its apex, and with enormously developed palpi without spines, but having the opposing inner edges furnished with interlocking serrations. The whole of this apparatus is commonly termed the mask. In a state of repose it is applied closely against the face, the elongated mentum directed backward and lying between the anterior pair of legs; but when an approaching victim is seen the whole apparatus is suddenly projected, and the prey caught by the raptorial palpi; in some large species it is capable of being projected fully half an inch in front of the head. The prey, once caught and held by this apparatus, is devoured in the usual manner. There are two pairs of thoracic spiracles, through which the nymph breathes during its later life by thrusting the anterior end of the body into the air; but respiration is mostly effected by a peculiar apparatus at the tail end, and there are two different methods. In the *Agrionidae* there are three elongate flattened plates, or false gills, full of tracheal ramifications, which extract the air from the water, and convey it to the internal tracheae (in *Calopteryx* these plates are excessively long, nearly equalling the abdomen), the plates also serving as means of locomotion. But in the other groups these external false gills are absent, and in



FIG. 4.—The perfect insect (the wings having acquired their full dimensions) resting to dry itself, preparatory to the wings being horizontally extended.

the perfect insect (the wings having acquired their full dimensions) resting to dry itself, preparatory to the wings being horizontally extended.

their place are five valves, which by their sudden opening and closing force in the water to the rectum, the walls of which are furnished with branchial lamellae. The alternate opening and closing of these valves enables the creature to make quick jerks or rushes (incorrectly termed "leaps") through the water,¹ and, in conjunction with its mouth parts, to make sudden attacks upon prey from a considerable distance. Well-developed Aeschnid larvae have been observed to take atmospheric air into the rectum. The lateral angles of the terminal abdominal segments are sometimes produced into long curved spines. In colour these larvae are generally muddy, and they frequently have a coating of muddy particles, and hence are less likely to be observed by their victims. If among insects the perfect dragon-fly may be termed the tyrant of the air, so may its larva be styled that of the water. Aquatic insects and larvae form the principal food, but there can be no doubt that worms, the fry of fish, and even younger larvae of their own species, form part of the bill of fare. The "nymph" when arrived at its full growth sallies forth from the water, and often crawls a considerable distance (frequently many feet up the trunks of trees) before it fixes itself for the final change, which is effected by the thorax splitting longitudinally down the back, through which fissure the perfect insect gradually drags itself. The figures indicate this process as observed in *Aeschna cyanea*.

The Complete Insect.—For a considerable time after its emergence a dragon-fly is without any of its characteristic colours, and is flaccid and weak, the wings (even in those groups in which they are afterwards horizontally extended) being held vertically in a line with the abdomen. By degrees the parts harden, and the insect essays its first flight, but even then the wings have little power and are semi-opaque in appearance, as if dipped in mucilage. In most species of *Calopterygina*, and in some others, the prevailing colour of the body is a brilliant bronzy green, blue or black, but the colours in the other groups vary much, and often differ in the sexes. Thus in *Libellula depressa* the abdomen of the fully adult male is covered with a bluish bloom, whereas that of the female is yellow; but several days elapse before this pulverulent appearance is attained, and a comparatively young male is yellow like the female. The wings are typically hyaline and colourless, but in many species (especially *Calopterygina* and *Libellulina*) they may be wholly or in part opaque and often black, due apparently to gradual oxydization of a pigment between the two membranes of which the wings are composed; the brilliant iridescence, or metallic lustre, so frequently found is no doubt due to interference—the effect of minute irregularities of the surface—and not produced by a pigment. A beautiful little genus (*Chalopteryx*) of *Calopterygina* from the Amazon is a gem in the world of insects, the posterior wings being of the most brilliant fiery metallic colour, whereas the anterior remain hyaline.

These insects are pre-eminently lovers of the hottest sunshine (a few are somewhat crepuscular), and the most powerful and daring on the wing in fine weather become inert and comparatively lifeless when at rest in dull weather, allowing themselves to be captured by the fingers without making any effort to escape. Many of the larger species (*Aeschna*, &c.) have a habit of affecting a particular twig or other resting place like a fly-catcher among birds, darting off after prey and making long excursions, but returning to the chosen spot. A. R. Wallace, in his *Malay Archipelago*, states that the inhabitants of Lombok use the large species for food, and catch them by means of limed twigs.

They are distributed over the whole world excepting the polar regions, but are especially insects of the tropics. At the present day about 2200 species are known, dispersed unequally among the several subfamilies as follows: Agrionina, 700 species; Calopterygina, 280; Gomphina, 320; Aeschnina, 170; Cordulina, 130; Libellulina, 600. In Europe proper only 100 species have been observed, and about 46 of these occur in the British islands. New Zealand is excessively poor, and can only number 8 species, whereas they are very numerous in Australia.

¹ A similar contrivance was suggested and (if the writer mistakes not) actually tried as a means of propelling steamships.

Some species are often seen at sea, far from land, in calm weather, in troops which are no doubt migratory; the common *Libellula quadrimaculata*, which inhabits the cold and temperate regions of the northern hemisphere, has been frequently seen in immense migratory swarms. One species (*Pantala flavescens*) has about the widest range of any insect, occurring in the Old World from Kamtchatka to Australia, and in the New from the Southern States to Chili, also all over Africa and the Pacific islands, but is not found in Europe. The largest species occur in the *Aeschnina* and *Agrionina*; a member of the former subfamily from Borneo expands to nearly 6½ in., and with a moderately strong body and powerful form; in the latter the Central American and Brazilian *Megalopterus caeruleus* and species of *Mecistogaster* are very large, the former expanding to nearly 7 in., and the latter to nearly as much, but the abdomen is not thicker than an ordinary grass-stem and of extreme length (fully 5 in. in *Mecistogaster*).

Fossils.—Among fossil insects dragon-flies hold a conspicuous position. Not only do they belong to what appears to have been a very ancient type, but in addition, the large wings and strong dense reticulation are extremely favourable for preservation in a fossil condition, and in many cases all the intricate details can be as readily followed as in a recent example. From the Carboniferous strata of Combray, France, C. Brongniart has described several genera of gigantic insects allied to dragon-flies, but with less specialized thoracic segments and simpler wing-venation. These form a special group—the Protodonata. True *Odonata* referable to the existing families are plentiful in Mesozoic formations; in England they have been found more especially in the Purbeck beds of Swanage, and the vales of Wardour and Aylesbury, in the Stonesfield Slate series, and in the Lias and Rhaetic series of the west of England. But the richest strata appear to be those of the Upper Miocene at Oeningen, near Schaffhausen in the Rhine valley; the Middle Miocene at Radaboj, near Krapina in Croatia; the Eocene of Aix, in Provence; and more especially the celebrated Secondary rocks furnishing the lithographic stone of Solenhofen, in Bavaria. This latter deposit would appear to have been of marine origin, and it is significant that, although the remains of gigantic dragon-flies discovered in it are very numerous and perfect, no traces of their subaquatic conditions have been found, although these as a rule are numerous in most of the other strata, hence the insects may be regarded as having been drowned in the sea and washed on shore. Many of these Solenhofen species differ considerably in form from those now existing, so that Dr H. A. L. Hagen, who has especially studied them, says that for nearly all it is necessary to make new genera. It is of great interest, however, to find that a living Malayan genus (*Euphaea*) and another living genus *Uropetala*, now confined to New Zealand, are represented in the Solenhofen deposits, while a species of *Megapodagrion* now entirely Neotropical, occurs in the Eocene beds of Wyoming.

A notice of fossil forms should not be concluded without the remark that indications of at least two species have been found in amber, a number disproportionately small if compared with other insects entombed therein; but it must be remembered that a dragon-fly is, as a rule, an insect of great power, and in all probability those then existing were able to extricate themselves if accidentally entangled in the resin.

See E. de Selys-Longchamps, *Monographie des Libellulides d'Europe* (Brussels, 1840); *Synopsis des Agrionines, Calopterygines, Gomphines, et Cordulines*, with Supplements (Brussels, from 1853 to 1877); E. de Selys-Longchamps and H. A. L. Hagen, *Revue des Odonates d'Europe* (Brussels, 1850); *Monographie des Calopterygines et des Gomphines* (Brussels, 1854 and 1858); Charpentier, *Libellulines europeae* (Leipzig, 1840). For modern systematic work see various papers by R. M. Lachlan, P. F. Calvert, J. G. Needham, R. Martin, E. B. Williamson, F. Karsch, &c.; also H. Tumpel, *Die Geradflügler Mitteleuropas* (Eisenach, 1900); and W. F. Kirby, *Catalogue of Neuroptera Odonata* (London, 1890). For habits and details of transformation and larval life, see L. C. Miall, *Natural History of Aquatic Insects* (London, 1895); H. Dewitz, *Zool. Anz.* xiii. (1891); and J. G. Needham, *Bull. New York Museum*, lxviii. (1903). For geographical distribution, G. H. Carpenter, *Sci. Proc. R. Dublin Soc.* viii. (1897). For British species, W. J. Lucas, *Handbook of British*

Dragonflies (London, 1899). For wings and mechanism of flight, R. von Lendenfeld, *S.B. Akad. Wien*, lxxxiii. (1881), and J. G. Needham, *Proc. U.S. Nat. Mus.* xxvi. (1903). For general morphology, R. Heymons, *Abhandl. k. preuss. Akad.* (1896), and *Ann. Hofmus. Wein*, xix. (1904). (R. M'L.; G. H. C.)

DRAGON'S BLOOD, a red-coloured resin obtained from several species of plants. *Calamus draco* (Willd.), one of the rotang or rattan palms, which produces much of the dragon's blood of commerce, is a native of Further India and the Eastern Archipelago. The fruit is round, pointed, scaly, and the size of a large cherry, and when ripe is coated with the resinous exudation known as dragon's blood. The finest dragon's blood, called *jernang* or *djernang* in the East Indies, is obtained by beating or shaking the gathered fruits, sifting out impurities, and melting by exposure to the heat of the sun or by placing in boiling water; the resin thus purified is then usually moulded into sticks or quills, and after being wrapped in reeds or palm-leaves, is ready for market. An impurer and inferior kind, sold in lumps of considerable size, is extracted from the fruits by boiling. Dragon's blood is dark red-brown, nearly opaque and brittle, contains small shell-like flakes, and gives when ground a fine red powder; it is soluble in alcohol, ether, and fixed and volatile oils. If heated it gives off benzoic acid. In Europe it was once valued as a medicine on account of its astringent properties, and is now used for colouring varnishes and lacquers; in China, where it is mostly consumed, it is employed to give a red facing to writing paper. The drop dragon's blood of commerce, called *cinnabar* by Pliny (*N.H.* xxxiii. 39), and *sangre de dragon* by Barbosa was formerly and is still one of the products of Socotra, and is obtained from *Dracaena cinnabari*. The dragon's blood of the Canary Islands is a resin procured from the surface of the leaves and from cracks in the trunk of *Dracaena draco*. The hardened juice of a euphorbiaceous tree, *Croton draco*, a resin resembling kino, is the *sangre del drago* or dragon's blood of the Mexicans, used by them as a vulnerary and astringent.

DRAGOON (*Fr. dragon*, *Ger. Dragoner*), originally a mounted soldier trained to fight on foot only (see CAVALRY). This mounted infantryman of the late 16th and 17th centuries, like his comrades of the infantry who were styled "pike" and "shot," took his name from his weapon, a species of carbine or short musket called the "dragon." Dragoons were organized not in squadrons but in companies, like the foot, and their officers and non-commissioned officers bore infantry titles. The invariable tendency of the old-fashioned dragoon, who was always at a disadvantage when engaged against true cavalry, was to improve his horsemanship and armament to the cavalry standard. Thus "dragoon" came to mean medium cavalry, and this significance the word has retained since the early wars of Frederick the Great, save for a few local and temporary returns to the original meaning. The phrases "to dragoon" and "dragoonade" bear witness to the mounted infantry period, this arm being the most efficient and economical form of cavalry for police work and guerrilla warfare. The "Dragonnades," properly so called, were the operations of the troops (chiefly mounted) engaged in enforcing Louis XIV.'s decrees against Protestants after the revocation of the edict of Nantes. In the British service the dragoons (1st Royals, 2nd Scots Greys, 6th Inniskillings) are heavy cavalry, the Dragoon Guards (seven regiments) are medium, as are the dragoons of other countries. The light cavalry of the British army in the 18th and early 19th century was for the most part called light dragoons.

DRAGUIGNAN, the chief town of the department of the Var in S.E. France; 5½ m. N.E. of Toulon, and 2½ m. N.W. of Fréjus by rail; situated at a height of 670 ft. above the level of the sea, at the southern foot of the wooded heights of Malmont, and on the left bank of the Nartuby river; pop. (1906) 7766. It possesses no notable buildings, save a modern parish church, a prefecture, also modern, and a building wherein are housed the town library and a picture gallery, with some fair works of art. In modern times the ramparts have been demolished, and new wide streets pierced through the town.

DRAINAGE OF LAND. The verb "to drain," with its substantives "drain" and "drainage," represents the O. Eng.

draeknian, from the same root found in "dry," and signifies generally the act of drawing off moisture or liquid from somewhere, and so drinking dry, and (figuratively) exhausting; the substantive "drain" being thus used not only in the direct sense of a channel for carrying off liquid, but also figuratively for a very small amount such as would be left as dregs. The term "drainage" is applied generally to all operations involving the drawing off of water or other liquid, but more particularly to those connected with the treatment of the soil in agriculture, or with the removal of water and refuse from streets and houses. For the last, see SEWERAGE; the following article being devoted to the agricultural aspects of this subject. See also the articles RECLAMATION OF LAND, CANAL, IRRIGATION, RIVER ENGINEERING, WATER SUPPLY and (LAW) WATER RIGHTS.

Agricultural or field drainage consists in the freeing of the soil from stagnant and superfluous water by means of surface or underground channels. It may be distinguished from the draining of land on a large scale which is exemplified in the reclamation of the English Fens (see FENS). Surface drainage is usually effected by ploughing the land into convex ridges off which the water runs into intervening furrows and is conveyed into ditches. For several reasons this method is ineffective, and, where possible, is now superseded by underground drainage by means of pipe-tiles. Land is not in a satisfactory condition with respect to drainage unless the rain that falls upon it can sink down to the minimum depth required for the healthy development of the roots of crops and thence find vent either through a naturally porous subsoil or by artificial channels.

A few of the evils inseparable from the presence of overmuch water in the soil may be enumerated. Wet land, if in grass, produces only the coarser grasses, and many subaquatic plants and mosses, which are of little or no value for pasturage; its herbage is late in spring, and fails early in autumn; the animals grazed upon it are unduly liable to disease, and sheep, especially; to foot-rot and liver-rot. In the case of arable land the crops are poor and moisture-loving weeds flourish. Tillage operations on such land are easily interrupted by rain, and the period always much limited in which they can be prosecuted at all; the compactness and toughness of the soil renders each operation more arduous, and its repetition more necessary than in the case of dry land. The surface must necessarily be thrown into ridges, and the furrows and cross-cuts cleared out after each process of tillage, and upon this surface-drainage as much labour is expended in twenty years as would suffice to make under-drains enough to lay it permanently dry. With all these precautions the best seed time is often missed, and this usually proves the prelude to a scanty crop, or to a late and disastrous harvest. The cultivation of the turnip and other root crops, which require the soil to be wrought to a deep and free tilth, either becomes altogether impracticable and must be abandoned for the safe but costly bare fallow, or is carried out with great labour and hazard; and the crop, when grown, can neither be removed from the ground, nor consumed upon it by sheep without damage by "poaching."

The roots of plants require both air and warmth. A deep stratum through which water can percolate, but in which it can never stagnate, is therefore necessary. A waterlogged soil is impenetrable by air, and owing to the continuous process of evaporation and radiation, its temperature is much below that of drained soil. The surface of the water in the supersaturated soil is known as the "water-table" and is exemplified in water standing in a well. Water will rise in clay by capillarity to a height of 50 in., in sand to 22 in. Above the "water-table" the water is held by capillarity, and the percentage of water held decreases as we approach the surface where there may be perfect dryness. Draining reduces the "surface tension" of the capillary water by removal of the excess, but the "water-table" may be many feet below. Drains ordinarily remove only excess of capillary water, an excess of percolating water in wet weather.

In setting about the draining of a field, or farm, or estate, the first point is to secure a proper outfall. The lines of the receiving drains must next be determined, and then the direction of the

parallel drains. The former must occupy the lowest part of the natural hollows, and the latter must run in the line of the greatest slope of the ground. In the case of flat land, where a fall is obtained chiefly by increasing the depth of the drains at their lower ends, these lines may be disposed in any direction that is found convenient; but in undulating ground a single field may require several distinct sets of drains lying at different angles, so as to suit its several slopes. When a field is ridged in the line of the greatest ascent of the ground, there is an obvious convenience in adopting the furrows as the site of the drains; but wherever this is not the case the drains must be laid off to suit the contour of the ground, irrespective of the furrows altogether. When parts of a field are flat, and other parts have a considerable acclivity, it is expedient to cut a receiving drain near to the bottom of the slopes, and to give the flat ground an independent set of drains. In laying off receiving drains it is essential to give hedgerows and trees a good offing, lest the conduit be obstructed by the roots.

When a main drain is so placed that parallel ones empty into it from both sides, care should be taken that the inlets of the latter are not made exactly opposite to each other. Much of the success of draining depends on the skilful planning of these main drains, and in making them large enough to discharge the greatest flow of water to which they may be exposed. Very long main drains are to be avoided. Numerous outlets are also objectionable, from their liability to obstruction. An outlet to an area of from 10 to 15 acres is a good arrangement. These outlets should be faced with mason work, and guarded with iron gratings.

The distance and depth apart of the parallel drains is determined chiefly by reference to the texture of the soil. In an impervious clay the flow of the water is much impeded and the water-table can be controlled only by frequent lines of pipes. On such land it is customary to lay them about 3 ft. from the surface and from 15 to 21 ft. apart. In lighter soils the depth, and proportionately the distance apart, is increased, but the drains are rarely more than 4 ft. 6 in. below the surface, though they may be 75 or 100 apart. A fall of at least 1 in 200 is desirable.

There are various forms of under-drainage, some of them alluded to in the historical section below, but by far the commonest is by means of cylindrical or oval pipes of burnt clay about 1 ft. in length, sometimes supplemented by collars, though nowadays the use of these is being abandoned. Pipes vary in bore from 2 in. for the parallel to 6 in. for the main drains.

In constructing a drain, it is of importance that the bottom be cut out just wide enough to admit the pipes and no more. Pipes, when accurately fitted in, are much less liable to derangement than when laid in the bottom of a trench several times their width, into which a mass of loose earth must necessarily be returned. This is easily effected in the case of soils tolerably free from stones by the use of draining spades and the tile-hook which are represented in the accompanying cut. The tile-hook is an implement by means of which the pipes may be lowered from the edge of the trench and laid at the bottom. An implement, sometimes propelled by steam, known as the draining plough, can be used for opening the trenches. Draining can be carried on at all seasons, but is usually best done in autumn or summer. A thoroughly trustworthy and experienced workman should be selected to lay the pipes, with instructions to set no pipes until he is satisfied that the depth of the drains and level of the bottoms are correct. The expense of tile-drainage may vary from about £2:10s. per acre on loose soils to £10 an acre on the most tenacious soils, the rate of wages and the cost of the pipes, the depth of the trenches and the ease with which they can be dug, all influencing the cost of the process.

Drainage is not a modern discovery. The Romans were careful to keep their arable lands dry by means of open trenches or covered drains filled with stones or twigs. It is at least several centuries since covered channels of various kinds were used by British husbandmen for drying their land. Walter Blith (see *AGRICULTURE*) about the middle of the 17th century wrote of

the improvement which might be effected in barren land by freeing it from the excess of stagnant water on or near the surface by means of channels filled with faggots or stones, but his principles, never generally adopted, were ultimately forgotten. In the latter half of the 18th century. Joseph Elkington, a Warwickshire farmer, discovered a plan of laying dry sloping ground that is drowned by the outbursting of springs. When the higher-lying portion of such land is porous, rain falling upon it sinks down until it is arrested by clay or other impervious matter, which causes it again to issue at the surface and wet the lower-lying ground. Elkington showed that by cutting a deep drain through the clay, aided when necessary by wells or auger holes, the subjacent bed of sand or gravel in which a body of water is pent up by the clay, as in a vessel, might be tapped and the water conveyed harmlessly in the covered drain to the nearest ditch or stream. In the circumstances to which it is applicable, and in the hands of skilful drainers, Elkington's

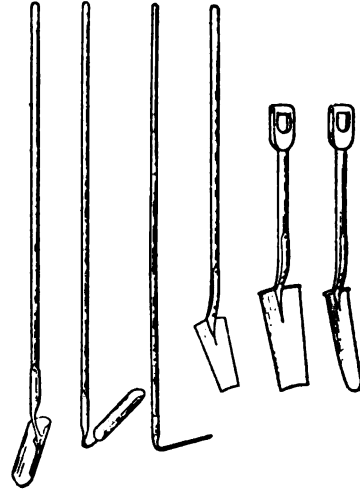

Draining Implements.

plan, known as "sink-hole drainage," by bringing into play the natural drainage furnished by porous strata, is often eminently successful.

During the subsequent thirty or forty years most of the draining that took place was on this system, and an immense capital was expended in such works with varying results. Things continued in this position until about 1823, when James Smith of Deanston, having discovered anew those principles of draining so long before indicated by Blith, proceeded to exemplify them in his own practice, and to expound them to the public in a way that speedily effected a complete revolution in the art of draining, and marked an era in agricultural progress. Instead of persisting in fruitless attempts to dry extensive areas by a few dexterous cuts, he insisted on the necessity of providing every field that needed draining at all with a complete system of parallel underground channels, running in the line of the greatest slope of the ground, and so near to each other that the whole rain falling at any time upon the surface should sink down and be carried off by the drains. A main receiving drain was to be carried along the lowest part of the ground, with sub-drains in every subordinate hollow that the ground presented. The distances between drains he showed must be regulated by the greater or less retentiveness of the ground operated upon, and gave 10 to 40 ft. as the limits of their distance apart. The depth which he prescribed for his parallel drains was 30 in., and these were to be filled with 12 in. of stones small enough to pass through a 3-in. ring—in short a new edition of Blith's drain. Josiah Parkes, engineer

to the Royal Agricultural Society, advocated a greater distance apart for the drains, and, in order that the subterranean water might be reached, a depth of at least 4 ft.

The cultivated lands of Britain being disposed in ridges which usually lie in the line of greatest ascent, it became customary to form the drains in each furrow, or in each alternate, or third or fourth one, as the case might require, or views of economy dictate and hence the system soon came to be popularly called "furrow draining." From the number and arrangement of the drains, the terms "frequent" and "parallel" were also applied to it. Smith himself more appropriately named it, from its effects, "thorough draining." The sound principles thus promulgated by him were speedily adopted and extensively carried into practice. The great labour and cost incurred in procuring stones in adequate quantities, and the difficulty of carting them in wet seasons, soon led to the substitution of "tiles," and soles of burnt earthenware. The limited supply and high price of these tiles for a time impeded the progress of the new system of draining; but the invention of tile-making machines removed this impediment, and gave a stimulus to this fundamental agricultural improvement. The substitution of cylindrical pipes for the original horse-shoe tiles has still further lowered the cost and increased the efficiency and permanency of drainage works.

The system introduced by Smith of Deanston has now been virtually adopted by all drainers. Variations in matters of detail (having respect chiefly to the depth and distance apart of the parallel drains) have indeed been introduced; but the distinctive features of his system are recognized and acted upon.

A great stimulus was given to the improvement of land by the passing in England of a series of acts of parliament, which removed certain obstacles that effectually hindered tenants with limited interests from investing capital in works of drainage and kindred amelioration. The Public Money, Drainage Acts 1846-1856 authorized the advance of public money to landowners to enable them to make improvements in their lands, not only by draining, but by irrigation, the making of permanent roads, clearing, erecting buildings, planting for shelter, &c. The rapid absorption of the funds provided by these acts led to further legislative measures by which private capital was rendered available for the improvement of land. A series of special improvement acts were passed, authorizing companies to execute or advance money for executing improvements in land. Finally, the Land Improvement Act 1864, amended and extended by the act of 1899, gave facilities for borrowing money by charging the cost of draining, &c., as a rent-charge upon the inheritance of the land. The instalments must be repaid with interest in equal amounts extending over a fixed term of years by the tenant for life during his lifetime, the tenant being bound to maintain the improvements.

See C. G. Elliott, *Engineering for Land Drainage* (New York, 1903); F. H. King, *Irrigation and Drainage* (New York, 1899); G. S. Mitchell, *Handbook of Land Drainage* (London, 1898), with a good bibliography.

DRAKE, SIR FRANCIS (c. 1545-1595), English admiral, was born near Tavistock, Devonshire, about 1545 according to most early authorities, but possibly as early as 1539 (see Corbett, vol. I., Appendix A). His father, a yeoman and a zealous Protestant, was obliged to take refuge in Kent during the persecutions in the reign of Queen Mary. He obtained a naval chaplaincy from Queen Elizabeth, and is said to have been afterwards vicar of Upnor Church (evidently a misprint or slip of the pen for Upchurch) on the Medway. Young Drake was educated at the expense and under the care of Sir John Hawkins, who was his kinsman; and, after passing an apprenticeship on a coasting vessel, at the age of eighteen he had risen to be purser of a ship trading to Biscay. At twenty he made a voyage to Guinea; and at twenty-two he was made captain of the "Judith." In that capacity he was in the harbour of San Juan de Ulloa, in the Gulf of Mexico, where he behaved most gallantly in the actions under Sir John Hawkins, and returned with him to England, having acquired great reputation, though with the loss of all the money which he had embarked in the expedition. In 1570 he obtained a regular privateering commission from Queen Elizabeth, the powers of which he immediately exercised in a cruise in the Spanish Main. Having next projected an attack against

the Spaniards in the West Indies to indemnify himself for his former losses, he set sail in 1572, with two small ships named the "Pasha" and the "Swan." He was afterwards joined by another vessel; and with this small squadron he took and plundered the Spanish town of Nombre de Dios. With his men he penetrated across the isthmus of Panama, and committed great havoc among the Spanish shipping. From the top of a tree which he climbed while on the isthmus he obtained his first view of the Pacific, and resolved "to sail an English ship in these seas." In these expeditions he was much assisted by the Maroons, descendants of escaped negro slaves, who were then engaged in a desultory warfare with the Spaniards. Having embarked his men and filled his ships with plunder, he bore away for England, and arrived at Plymouth on the 9th of August 1573.

His success and honourable demeanour in this expedition gained him high reputation; and the use which he made of his riches served to raise him still higher in popular esteem. Having fitted out three frigates at his own expense, he sailed with them to Ireland, and rendered effective service as a volunteer, under Walter, earl of Essex, the father of the famous but unfortunate earl. After his patron's death he returned to England, where he was introduced to Queen Elizabeth (whether by Sir Christopher Hatton is doubtful), and obtained a favourable reception. In this way he acquired the means of undertaking the expedition which has immortalized his name. The first proposal he made was to undertake a voyage into the South Seas through the Straits of Magellan, which no Englishman had hitherto ever attempted. This project having been well received at court, the queen furnished him with means; and his own fame quickly drew together a sufficient force. The fleet with which he sailed on this enterprise consisted of only five small vessels, and their united crews mustered only 166 men. Starting on the 13th of December 1577, his course lay by the west coast of Morocco and the Cape Verde Islands. He reached the coast of Brazil on the 6th of April, and entered the Rio de la Plata, where he parted company with two of his ships; but having met them again, and taken out their provisions, he turned them adrift. On the 19th of June he entered the port of St Julian's, where he remained two months, partly to lay in provisions, and partly delayed by the trial and execution of Thomas Doughty, who had plotted against him. On the 21st of August he entered the Straits of Magellan. The passage of the straits took sixteen days, but then a storm carried the ships to the west; on the 7th of October, having made back for the mouth of the strait, Drake's ship and the two vessels under his vice-admiral Captain Wynter were separated, and the latter, missing the rendezvous arranged, returned to England. Drake went on, and came to Mocha Island, off the coast of Chile, on the 25th of November. He thence continued his voyage along the coast of Chile and Peru, taking all opportunities of seizing Spanish ships, and attacking them on shore, till his men were satiated with plunder; and then coasted along the shores of America, as far as 48° N. lat., in an unsuccessful endeavour to discover a passage into the Atlantic. Having landed, however, he named the country New Albion, and took possession of it in the name of Queen Elizabeth. Having careened his ship, he sailed thence on the 26th of July 1579 for the Moluccas. On the 4th of November he got sight of those islands, and, arriving at Ternate, was extremely well received by the sultan. On the 10th of December he made the Celebes, where his ship unfortunately struck upon a rock, but was taken off without much damage. On the 11th of March he arrived at Java, whence he intended to have directed his course to Malacca; but he found himself obliged to alter his purpose, and to think of returning home. On the 26th of March 1580 he again set sail; and on the 15th of June he doubled the Cape of Good Hope, having then on board only fifty-seven men and three casks of water. He passed the line on the 12th of July, and on the 16th reached the coast of Guinea, where he watered. On the 11th of September he made the Island of Terceira, and on the 26th of September (?) he entered the harbour of Plymouth. This voyage round the world, the first accomplished by an Englishman, was thus performed in two years and about ten

months. The queen hesitated for some time whether to recognize his achievements or not, on the ground that such recognition might lead to complications with Spain, but she finally decided in his favour. Accordingly, soon after his arrival she paid a visit to Deptford, went on board his ship, and there, after partaking of a banquet, conferred upon him the honour of knighthood, at the same time declaring her entire approbation of all that he had done. She likewise gave directions for the preservation of his ship, the "Golden Hind," that it might remain a monument of his own and his country's glory. After the lapse of a century it decayed and had to be broken up. Of the sound timber a chair was made, which was presented by Charles II. to the university of Oxford. In 1581 Drake became mayor of Plymouth; and in 1585 he married a second time, his first wife having died in 1583. In 1585, hostilities having commenced with Spain, he again went to sea, sailing with a fleet to the West Indies, and taking the cities of Santiago (in the Cape Verde Islands), San Domingo, Cartagena and St Augustine. In 1587 he went to Lisbon with a fleet of thirty sail; and having received intelligence of a great fleet being assembled in the bay of Cadiz, and destined to form part of the Armada, he with great courage entered the port on the 19th of April, and there burnt upwards of 10,000 tons of shipping—a feat which he afterwards jocosely called "singeing the king of Spain's beard." In 1588, when the Spanish Armada was approaching England, Sir Francis Drake was appointed vice-admiral under Lord Howard, and made prize of a very large galleon, commanded by Don Pedro de Valdez, who was reputed the projector of the invasion, and who struck at once on learning his adversary's name.

It deserves to be noticed that Drake's name is mentioned in the singular diplomatic communication from the king of Spain which preceded the Armada:—

"Te veto ne pergas bello defendere Belgas;
Quae Dracus eripuit nunc restituantur oportet;
Quas pater evertit jubeo te condere cellas;
Religio Papae fac restitatur ad unguem."

To these lines the queen made this extempore response:—

"Ad Graecias, bone rex, fiant mandata kalendas."

In 1580 Drake commanded the fleet sent to restore Dom Antonio, king of Portugal, the land forces being under the orders of Sir John Norreys; but they had hardly put to sea when the commanders differed, and thus the attempt proved abortive. But as the war with Spain continued, a more formidable expedition was fitted out, under Sir John Hawkins and Sir Francis Drake, against their settlements in the West Indies, than had hitherto been undertaken during the whole course of it. Here, however, the commanders again disagreed about the plan; and the result in like manner disappointed public expectation. These disasters were keenly felt by Drake, and were the principal cause of his death, which took place on board his own ship, near the town of Nombre de Dios, in the West Indies, on the 28th of January 1595.

The older Lives by Samuel Clarke (1671) and John Barrow, junr. (1843), have been superseded by Julian Corbett's two admirable volumes on *Drake and the Tudor Navy* (1898), the best source of information on the subject, which were preceded by the same author's *Sir Francis Drake* in the "English Men of Action" series (1890). See also E. J. Payne's edition of *Voyages of the Elizabethan Seamen to America: Thirteen original narratives from the collection of Hakluyt* (new ed., 1893).

DRAKE, NATHAN (1766–1836), English essayist and physician, son of Nathan Drake, an artist, was born at York in 1766. He was apprenticed to a doctor in York in 1779, and in 1786 proceeded to Edinburgh University, where he took his degree as M.D. in 1789. In 1790 he set up as a general practitioner at Sudbury, Suffolk, where he found an intimate friend in Dr Mason Good (d. 1827). In 1792 he removed to Hadleigh, Suffolk, where he died in 1836. His works include several volumes of literary essays, and some papers contributed to medical periodicals; but his most important production was *Shakespeare and his Times, including the Biography of the Poet,*

Criticisms on his Genius and Writings; a new Chronology of his Plays; a Disquisition on the Object of his Sonnets; and a History of the Manners, Customs and Amusements, Superstitions, Poetry and Elegant Literature of his Age (2 vols., 1817). The title sufficiently indicates the scope of this ample work, which has the merit, says G. G. Gervinus (*Shakespeare Commentaries*, Eng. trans., 1877) "of having brought together for the first time into a whole the tedious and scattered material of the editions and of the many other valuable labours of Tyrwhitt, Heath, Ritson, &c."

DRAKENBORCH, ARNOLD (1684–1748), Dutch classical scholar, was born at Utrecht on the 1st of January 1684. Having studied philology under Graevius and Burmann the elder, and law under Cornelius Van Eck, in 1716 he succeeded Burmann in his professorship (conjointly with C. A. Duker), which he continued to hold till his death on the 16th of January 1748. Although he obtained the degree of doctor of laws, and was intended for the legal profession, he determined to devote himself to philological studies. His edition of Livy (1738–1746, and subsequent editions) is the work on which his fame chiefly rests. The preface gives a particular account of all the literary men who have at different periods commented on the works of Livy. The edition itself is based on that of Gronovius; but Drakenborch made many important alterations on the authority of manuscripts which it is probable Gronovius had never seen. He also published *Dissertatio de praefectis urbi* (1704; reprinted at Frankfurt in 1752 with a life of Drakenborch); *Dissertatio de officio praefectorum praetorio* (1707); and an edition of Silius Italicus (1717).

DRAKENSBERG (*Quathamba* or *Kahlamba*, *s.s.* "heaped up and jagged," of the natives), a mountain chain of S.E. Africa, running parallel to the coast from Basutoland to the Limpopo river—a distance of some 600 m. The Drakensberg are the eastern part of the rampart which forms the edge of the inner tableland of South Africa. The sides of the mountains facing the sea are in general precipitous; on their inner face they slope more or less gently to the plateau. The culminating points of the range, and the highest lands in South Africa, are found in a sharp bend from S.E. to N.W. in about 29° S. 29° E., where "the Berg" (as the range is called locally) forms the frontier between Natal and Basutoland. Within 60 m. of one another are three mountains, Giant's Castle, Champagne Castle or Cathkin Peak, and Mont aux Sources, 10,000 to 11,000 or more ft. above the sea. From Mont aux Sources the normal N.E. direction of the range is resumed. Conspicuous among the heights along the Orange Free State, Transvaal and Natal frontiers are Tintwa, Malani, Inkwelo and Amajuba or Majuba (*q.v.*) all between 7000 and 8000 ft. The Draken's Berg—the particular hill from which the range is named—is 5682 ft. high and lies between Malani and Inkwelo heights. It was so named by the *soo-trekkers* about 1840. North of Majuba the range enters the Transvaal. Here the elevation is generally lower than in the south, but the Mauch Berg is about 8500 ft. high. At its northernmost point the range joins the Zoutpansberg. In their southern part the Drakensberg form the parting between the rivers draining west to the Atlantic and those flowing south and east to the Indian Ocean. At Mont aux Sources rise the chief headwaters of the Orange, Tugela and other rivers. In the north, however, several streams rising in the interior plateau, e.g. the Komati, the Crocodile and the Olifants, pierce the Drakensberg and reach the Indian Ocean. The range has numerous passes, many available for wheeled traffic. Van Reenen's Pass, between Tintwa and Malani, is crossed by a railway which connects the Orange Free State and Natal: Laing's Nek, the main pass leading from Natal to the Transvaal, which lies under the shadow of Majuba, is pierced by a railway tunnel. The railway from Delagoa Bay to Pretoria crosses the Drakensberg by a very steep gradient. Several subsidiary ranges branch off from the main chain of the Berg. This is especially the case in Natal, where one range is known as the Little Drakensberg. (See further BASUTOLAND; NATAL and TRANSVAAL.)

DRAMA (literally "action," from Gr. *δρᾶν*, act or do), the term applied to those productions of Art which imitate or, to use a more modern term, "represent" action by introducing the personages taking part in them as real, and as employed in the action itself. There are numerous varieties of the drama, differing more or less widely from one another, both as to the objects imitated and as to the means used in the process. But they all agree in the *method or manner* which is essential to the drama and to dramatic art, namely, *imitation in the way of action*. The function of all Art being to give pleasure by representation (see FINE ARTS), it is clear that what is distinctive of any one branch or form must be the manner in which this function is performed by it. In the epos, for instance, the method or manner is narrative, and even when Odysseus tells of his action, he is not acting.

I. THEORY OF THE DRAMA, AND DRAMATIC ART

The first step towards the drama is the assumption of character, whether real or fictitious. It is caused by the desire, inseparable from human nature, to give expression to feelings and ideas. These man expresses not only by sound and gesture, like other animals, and by speech significant by its delivery as well as by its purport, but also by imitation superadded to these. To imitate, says Aristotle, is instinctive in man from his infancy, and no pleasure is more universal than that which is given by imitation. Inasmuch as the aid of some sort of dress or decoration is usually at hand, while the accompaniment of dance or song, or other music, naturally suggests itself, especially on joyous or solemn occasions, we find that this preliminary step is taken among all peoples, however primitive or remote. But it does not follow, as is often assumed, that they possess a drama in germ. Boys playing at soldiers, or men walking in a pageant—a shoemaker's holiday in ribbons and flowers, or a Shetland sword-dance—none of these is in itself a drama. This is not reached till the imitation or representation extends to action.

An action which is to present itself as such to human minds must enable them to recognize in it a procedure from cause to effect. This of course means, neither that the cause suggested must be the final cause, nor that the result shown forth need pretend to be the ultimate result.

We look upon an action as ended when the purpose with which it began is shown to have been gained or frustrated; and we trace the beginning of an action back to the human will that set it on foot—though this will may be in bondage to a higher or stronger will, or to fate, in any or all of its purposes. Without an action in the sense stated—without a plot, in a word—there can be no drama. But the very simplest action will satisfy the dramatic test; a mystery representing the story of Cain and Abel without a deviation from the simple biblical narrative, a farce exhibiting the stalest trick played by designing sobriety upon oblivious drunkenness, may each of them be a complete drama. But even to this point, the imitation of action by action in however crude a form, not all peoples have advanced.

But after this second step has been taken, it only remains for the drama to assume a form regulated by certain literary laws, in order that it may become a branch of dramatic literature. Such a literature, needless to say, only a limited number of nations has come to possess; and, while some are to be found that have, or have had, a drama without a dramatic literature, it is quite conceivable that a nation should continue in possession of the former after having ceased to cultivate the latter. It is self-evident that no drama which forms part of a dramatic literature can ignore the use of speech; and, however closely music, dancing and decoration may associate themselves with particular forms or phases of the drama, their aid cannot be more than adventitious. As a matter of fact, the beginnings of dramatic composition are, in the history of such literatures as are well known to us, preceded by the earlier stages in the growth of the lyric and epic forms of poetry, or by one of these at all events; and it is in the continuation of both that the drama in its literary form takes its origin in those instances which lie open to our study.

While the aid of all other arts—even, strictly speaking, the aid of the literary art—is merely an accident, the co-operation of the art of acting is indispensable to that of the drama. The dramatic writer may have reasons for preferring to leave the imagination of his reader to supply the absence of this co-operation; but, though the term "literary drama" is freely used of works kept away from the stage, it is in truth either a misnomer or a self-condemnation. It is true that the actor only temporarily interprets, and sometimes misinterprets, the dramatist, while occasionally he reveals dramatic possibilities in a character or situation which remained hidden from their literary inventor. But this only shows that the courses of the dramatic and the histrionic arts do not run parallel; it does not contradict the fact that their conjunction is, on the one side as well as on the other, indispensable. No drama is more than potentially such till it is acted.

To essay, whether in a brief summary or in more or less elaborate detail, a statement of the main laws of the drama, has often been regarded as a superfluous, not to say, futile effort. But the laws of which it is proposed to give some indication here are not so much those which any particular literature or period has chosen to set up and follow, as those abstracted by criticism, in pursuit of its own free comparative method, from the process that repeats itself in every drama adequately meeting the demands upon it. Aristotle, whom we still justly revere as the originator of the theory of the drama, and thus its *νομοθέτης*, was, no doubt, in his practical knowledge of it, confined to its Greek examples, yet his object was not to produce another generation of great Attic tragedians, but rather to show how it was by following the necessary laws of their art that the great masters, true to themselves and to their artistic ends, had achieved what they had achieved. Still more distinctly was such the aim of the greatest modern critical writer on the drama, Lessing, whose chief design was to combat false dramatic theories and to overthrow laws demonstrated by him to be artificial inventions, unreal figments. He proved, what before him had only been suspected, that Shakespeare, though in hopeless conflict with certain rules dating from the *siècle de Louis XIV.*, was not in conflict with those laws of the drama which are of its very essence, and that, accordingly, if Shakespeare and the rules in question could not be harmonized, it was only so much the worse for the rules. To illustrate from great works, and expound with their aid, the organic processes of the art to which they belong, is not only among the highest, it is also one of the most useful functions of literary and artistic criticism. Nor is there, in one sense at least, any finality about it. Neither the great authorities on dramatic theory nor the resolute and acute apologists of more or less transitory phases of the drama—Corneille, Dryden and many later successors—have exhausted the statement of the means which the drama has proved, or may prove, capable of employing. The multitude of technical terms and formulæ which has gathered round the practice of the most living and the most Protean of arts has at no time seriously interfered with the operation of creative power. On the other hand, no dramaturgic theory has (though the attempt has been often enough made) ever succeeded in giving rise to a single dramatic work of enduring value, unless the creative force was there to animate the form.

It is therefore the operation of this creative force which we are chiefly interested in noting; and its task begins with the beginning of the dramatist's labours. He must of course start with the choice of a subject; yet it is obvious that the subject is merely the dead material out of which is formed that living something, the action of a play; and it is only in rare instances—far rarer than might at first sight appear—that the subject is as it were self-moulded as a dramatic action. The less experienced a playwright, the more readily will he, as the phrase is, rush at his subject, more especially if it seems to him to possess *prima facie* dramatic capabilities; and the consequence will be that which usually attends upon a precipitate start. On the other hand, while the quickness of a great dramatist's apprehension is apt to suggest

The dramatic and the histrionic arts.

Laws and rules of the drama.

Origin of the drama.

Dramatic action.

Dramatic literature.

Choice of subject.

to him an infinite number of subjects, and insight and experience may lead him half instinctively in the direction of suitable themes, it will often be long before in his mind the subject converts itself into the initial conception of the action of a play. To mould a subject—be it a Greek legend, or a portion of a Tudor chronicle, or one out of a hundred Italian tales, or a true story of modern life—into the action or fable of a play, is the primary task of the dramatist, and with this all-important process the creative part of his work really begins. Although his conception may expand or modify itself as he executes it, yet upon the conception the execution must largely depend. The range of subjects open to a dramatist may be as wide as the world itself, or it may be restricted by an endless variety of causes, conventions and considerations; and it is quite true that even the greatest dramatists have not always found time for contemplating each subject that occurs to them till the ray is caught which proclaims it a dramatic diamond. What they had time for, and what only the playwright who entirely misunderstands his art ignores the necessity of finding time for, is the transformation of the dead material of the subject into the living action of a drama.

What is it, then, that makes an action *dramatic*, and without which no action, whatever may be its nature—serious or ludicrous, stately or trivial, impetuous as a flame of fire, or light as a western breeze—can be so described? The answer to this question can only suggest itself from an attempt to ascertain the laws which determine the nature of all actions corresponding to this description. The first of the laws in question is in so far the most noteworthy among them that it has been the most amply discussed and the most pertinaciously misunderstood. This is the law which requires that a dramatic action should be *one*—that it should possess *unity*. What in the subject of a drama is merely an approximate or supposititious, must in its action be an actual unity; and it is indeed this requirement which constitutes the most arduous part of the task of transforming subject into action. There is of course no actual unity in any group of events in human life which we may choose to call by a single collective name—a war, a revolution, a conspiracy, an intrigue, an imbroglio. The events of real life, the facts of history, even the imitative incidents of narrative fiction, are like the waves of a ceaseless flood; that which binds a group or body of them into a single action is the bond of the dramatic idea; and this it is incumbent upon the dramatist to supply. Within the limits of a dramatic action all its parts should (as in real life or in history they so persistently refuse to do) flow into its current like tributaries to a single stream; or, to vary the figure, everything in a drama should form a link in a single chain of cause and effect. This law is incumbent upon every kind of drama—alike upon the tragedy which sets itself to solve one of the problems of a life, and upon the farce which sums up the follies of an afternoon.

Such is not, however, the case with certain more or less arbitrary rules which have at different times been set up for this or that kind of drama. The supposed necessity that an action should consist of *one event* is an erroneous interpretation of the law that it should be, as an action, *one*. For an event is but an element in an action, though it may be an element of decisive moment. The assassination of Caesar is not the action of a *Caesar* tragedy; the loss of his treasure is not the action of *The Miser*. Again, unity of action, while excluding those unconnected episodes which Aristotle so severely condemns, does not prohibit the introduction of one or even more subsidiary actions as contributing to the progress of the main action. The sole indispensable law is that these should always be treated as what they are—subsidiary only; and herein lies the difficulty, which Shakespeare so successfully overcame, of fusing a combination of subjects taken from various sources into the idea of a single action; herein also lies the danger in the use of that favourite device of the Spanish and other modern dramas—"by-plots" or "under-plots." On the other hand, the modern French drama has largely employed another device—quite legitimate in itself—for increasing the interest of an action without destroying its unity. This may be called the dramatic use of backgrounds,

the depiction of surroundings on which the action or its chief characters seem sympathetically to reflect themselves, back-biting "good villagers" or academicians who inspire one another—with tedium. But a really double or multiple action, logically carried out as such, is inconceivable in a single drama, though many a play is palpably only two plays knotted into one. It was therefore not all pedantry which protested against the multiplicity of action which had itself formed part of the revolt against the too narrow interpretation of unity adopted by the French classical drama. Thirdly, unity of action need not imply unity of hero—for hero (or heroine) is merely a conventional term signifying the principal personage of the action. It is only when the change in the degree of interest excited by different characters in a play results from a change in the conception of the action itself, that the consequent *duality* (or multiplicity) of heroes recalls a faulty uncertainty in the conception of the action they carry on. Such an objection, while it may hold in the case of Schiller's *Don Carlos*, would therefore be erroneously urged against Shakespeare's *Julius Caesar*. Lastly, as to the theory which made the so-called unities of *time* and *place* constitute, together with that of *action*, the Three Unities indispensable to the (tragic) drama, the following note must suffice. Aristotle's supposed exaction of all the Three Unities, having been expanded by Chapelein and approved by Richelieu, was stereotyped by Corneille, though he had (as one might say) got on very well without them, and was finally set forth in Horatian verse by Boileau. Thus it came to be overlooked that there is nothing in Aristotle's statement to show that in his judgment unity of time and place are, like unity of action, absolute dramatic laws. Their object is by representing an action as visibly continuous to render its unity more distinctly or easily perceptible. But the imagination is capable of constructing for itself the bridges required for preserving to an action, conceived of as such, its character of continuousness. In another sense these rules were convenient usages conducing to a concise and clear treatment of a limited kind of themes; for they were a Greek invention, and the repeated resort to the same group of myths made it expedient for a Greek poet to seek the subject of a single tragedy in a part only of one of the myths at his disposal. The observance of unity of place, moreover, was suggested to the Greeks by certain outward conditions of their stage—as assuredly as it was adopted by the French in accordance with the construction and usages of theirs, and as the neglect of it by the Elizabethans was in their case encouraged by the established form of the English scene. The palpable artificiality of these laws needs no demonstration, so long as the true meaning of the term "action" be kept in view. Of the action of *Othello* part takes place at Venice and part at Cyprus, and yet the whole is one in itself; while the limits of time over which an action—Hamlet's progress to resolve, for instance—extends cannot be restricted by a revolution of the earth round the sun or of the moon round the earth.

In a drama which presents its action as *one*, this action must be *complete in itself*. This Aristotelian law, like the other, distinguishes the dramatic action from its subject. The former may be said to have a real artistic, while the latter has only an imaginary real, completeness. The historian, for instance, is aware that the complete exposition of a body of events and transactions at which he aims can never be more than partially accomplished, since he may present only what he knows, and all human knowledge is imperfect. But Art is limited by no such uncertainty. The dramatist, in treating an action as *one*, comprehends the whole of it in the form of his work, since, to him who has *conceived* it, all its parts, from cause to effect, are equally clear. It is his fault if in the action of his drama anything is left unaccounted for—not *motivé*; though a dramatic *motif* might not always prove to be a sufficient explanation in real life. Accordingly, every drama should represent in organic sequence the several stages of which a complete action consists, and which are essential to it. This law of completeness, therefore, lies at the foundation of all systems of dramatic "construction."

Unity of action.

Completeness of action.

Every action, if conceived of as complete, has its causes, growth, height, consequences and close. There is no binding law to prescribe the relative length or proportion at which these several stages in the action should be treated in a drama; or to regulate the treatment of such subsidiary actions as may be introduced in aid of the main plot, or of such more or less directly connected "episodes" as may at the same time advance and relieve its progress. But experience has necessarily from time to time established certain rules of practice, and from the adoption of particular systems of division for particular species of the drama—such as that into five acts for a regular tragedy or comedy, which Roman example has caused to be so largely followed—has naturally resulted a certain uniformity of relation between the conduct of an action and the outward sections of a play. Essentially, however, there is no difference between the laws regulating the construction of a Sophoclean or Shakespearian tragedy, a comedy of Molière or Congreve, and a well-built modern farce, because all exhibit an action complete in itself.

The "introduction" or "exposition" forms an integral part of the action, and is therefore to be distinguished from the "prologue" in the more ordinary sense of the term, which like the "epilogue" (and the Greek *παράβασις*) stands outside the action, and is a mere address to the public from author, presenter or actor occasioned by the play. Prologue and epilogue are mere external, though at times effective, adjuncts, and have, properly speaking, as little to do with the construction of a play as the bill which announces it or the musical prelude which disposes the mind for its reception. A special kind of preface or argument is the "dumb-show," which in some old plays briefly rehearses in pantomime the action that is to follow. The introduction or

exposition belongs to the action itself; it is, as the Hindu critics called it, the seed or circumstance from which the business arises. Clearness being its primary requisite, many expedients have been at various times adopted to secure this feature. Thus the Euripidean prologue, though spoken by one of the characters of the play, took a narrative form, more acceptable to the audience than to the critics, and placed itself half without, half within, the action. The same purpose is served by the separate "inductions" in many of the old English plays, and by the preludes or prologues, or whatever name they may assume, in numberless modern dramas of all kinds—from *Foxt* down to the favourites of the Ambigu and the Adelphi. More facile is the orientation supplied in French tragedy by the opening scenes between hero and *confidant*, and in French comedy and its derivatives by those between observant valet and knowing lady's-maid. But all such expedients may be rendered unnecessary by the art of the dramatist, who is able outwardly also to present the introduction of his action as an organic part of that action itself; who seems to take the spectators *in medias res*, while he is really building the foundations of his plot; who touches in the opening of his action the chord which is to vibrate throughout its course—"Down with the Capulets! down with the Montagues!"—"With the Moor, sayest thou?"

The exposition, which may be short or long, but which should always prepare and may even seem to necessitate the action, ends when the movement of the action itself begins. This transition may occasionally be marked with the utmost distinctness (as in the actual meeting between the hero and the Ghost in *Hamlet*), while in other instances subsidiary action or episode may judiciously intervene (as in *King Lear*, where the subsidiary action of Gloster and his sons opportunely prevents too abrupt a sequence of cause and effect).

From this point the second stage of the action—its "growth"—progresses to that third stage which is called its "height" or "climax." All that has preceded the attainment of this constitutes that half of the drama—usually its much larger half—which Aristotle terms the *Mors*, or tying of the knot. The varieties in the treatment of the growth or second stage of the action are infinite; it is here that the greatest

freedom is manifestly permissible; that in the Indian drama the personages make long journeys across the stage; and that, with the help of their under-plots, the masters of the modern tragic and the comic drama—notably those unequalled weavers of intrigues, the Spaniards—are able most fully to exercise their inventive faculties. If the growth is too rapid, the climax will fail of its effect; if it is too slow, the interest will be exhausted before the greatest demand upon it has been made—a fault to which comedy is specially liable; if it is involved or inverted, a vague uncertainty will take the place of an eager or agreeable suspense, the action will seem to halt, or a fall will begin prematurely. In the contrivance of the "climax" itself lies one of the chief tests of the dramatist's art; for while the transactions of real life often fail to reach any climax at all, that of a dramatic action should present itself as self-evident. In the middle of everything, says the Greek poet, lies the strength; and this strongest or highest point it is the task of the dramatist to make manifest. Much here depends upon the niceties of constructive instinct; much (as in all parts of the action) upon a thorough dramatic transformation of the subject. The historical drama at this point presents peculiar difficulties, of which the example of *Henry VIII.* may be cited as an illustration.

From the climax, or height, the action proceeds through its "fall" to its "close," which in a drama with an unhappy ending we still call its "catastrophe," while to terminations in general we apply the term *dénouement*. This latter name would, however, more properly be applied in the sense in which Aristotle employs its Greek equivalent *Mors*—the untying of the knot—to the whole of the second part of the action, from the climax downwards. In the management of the climax, everything depends upon producing the effect; in the fall, everything depends upon not marring it. This may be ensured by a rapid advance to the close; but neither does every action admit of such treatment, nor is it in accordance with the character of those which are of a more subtle or complicated kind. With the latter, therefore, the "fall" is often a revolution or "return," *i.e.* in Aristotle's phrase a change into the reverse of what is expected from the circumstances of the action (*επιπέτρα*)—as in *Coriolanus*, where the Roman story lends itself so admirably to dramatic demands. In any case, the art of the dramatist is in this part of his work called upon for the surest exercise of its tact and skill. The effect of the climax was to concentrate the interest; the fall must therefore, above all, avoid dissipating it. The use of episodes is not even now excluded; but, even where serving the purpose of relief, they must now be such as help to keep alive the interest, previously raised to its highest pitch. This may be effected by the raising of obstacles between the height of the action and its expected consequences; in tragedy by the suggestion of a seemingly possible recovery or escape from them (as in the wonderfully powerful construction of the latter part of *Macbeth*); in comedy, or wherever the interest of the action is less intense, by the gradual removal of incidental difficulties. In all kinds of the drama "discovery" will remain, as it was in the judgment of Aristotle, a most effective expedient; but it should be a discovery prepared by that method of treatment which in its consummate master, Sophocles, has been termed his "irony." Nowhere should the close or catastrophe be other than a consequence of the action itself. Sudden revulsions from the conditions of the action—such as are supplied with the aid of the *deus ex machina*, or the revising officer of the emperor of China, or the nabob returned from India, or a virulent malaria—condemn themselves as unsatisfactory makeshifts. However sudden, and even in manner of accomplishment surprising, may be the catastrophe; it should, like every other part of the action, be in organic connexion with the whole preceding action. The sudden suicides which terminate so many tragedies, and the unmerited paternal blessings which close an equal number of comedies, should be something more than a "way out of it," or a signal for the fall of the curtain. A catastrophe may conveniently, and even (as in

Height or climax.

Fall.

Return.

Close or catastrophe.

Faust) with powerful effect, be left to the imagination; but to substitute for it a deliberate blank is to leave the action incomplete, and the drama a fragment ending with a—possibly interesting—confession of incompetence.

The action of a drama, besides being one and complete in itself, ought likewise to be *probable*. The probability or necessity (in the Aristotelian sense of the terms) required of a drama is not that of actual or historical experience—it is a conditional probability, or in other words an internal consistency between the course of the action and the conditions under which the dramatist has chosen to carry it on. As to the former, he is fettered by no restrictions save those which he imposes upon himself, whether or not in deference to the usages of certain accepted species of dramatic composition. Ghosts seldom appear in real life or in dramas of real life, but the introduction of supernatural agency is neither enjoined nor prohibited by any general dramatic law. The use of such expedients is as open to the dramatist as to any other poet; the judiciousness of his use of them depends upon the effect which, consistently with the general conduct of his action, they will exercise upon the spectator, whom other circumstances may or may not predispose to their acceptance. The Ghost in *Hamlet* belongs to the action of the play; the Ghost in the *Persæ* is not intrinsically less probable, but seems a less immediate product of the surrounding atmosphere. Dramatic probability has, however, a far deeper meaning than this. The *Eumenides* is probable, with all its mysterious commingling of cults, and so is *Macbeth*, with all its barbarous witchcraft. The proceedings of the feathered builders of Clouduckootown in the *Birds* of Aristophanes are as true to dramatic probability as are the pranks of Oberon's fairies in *Midsummer Night's Dream*. In other words, it is in the harmony between the action and the characters, and in the consistency of the characters with themselves, in the appropriateness of both to the atmosphere in which they have their being, that this dramatic probability lies. The dramatist has to represent characters affected by the progress of an action in a particular way, and contributing to it in a particular way, because, if consistent with themselves, they *must* be so affected, and *must* so act.

Upon the invention and conduct of his characters the dramatist must therefore expend a great proportion—even a preponderance—of his labour. His treatment of them will, in at least as high a degree as his choice of subject, conception of action, and method of construction, determine the effect which his work produces. And while there are aspects of the dramatic art under which its earlier phases already exhibit an unsurpassed degree of perfection, there is none under which its advance is more notable than this. Many causes have contributed to this result; the chief is to be sought in the multiplication of the opportunities for mankind's study of man. The theories of the Indian critics on the subject of dramatic character are little more than an elaborate scaffolding. Aristotle's remarks on the subject are scanty; nor indeed is the strength of the dramatic literature from whose examples he abstracted his maxims to be sought in the fulness or variety of its characterization. This relative deficiency was beyond doubt largely caused by the outward conditions of the Greek theatre—the remoteness of actor from spectator, and the consequent necessity for the use of masks, and for the raising, and consequent conventionalizing, of the tones of the voice. Later Greek and Roman comedy, unable or unwilling to resist the force of habit, limited their range of characters to an accepted gallery of types. Nor is it easy to ignore the fact that the influence of these classical examples, combined with that of national tendencies of mind and temperament, have all along inclined the dramatists of the Romance nations to attach less importance to characterization of a closer and more varied kind than to interest of action and effectiveness of construction. The Italian and the Spanish drama more especially, and the French during a great part of its history, have in general shown a disposition to present their characters, as it were, ready made—whether in the case of tragic heroes and heroines, or in that of comic types, often

moulded, as in the *commedia dell' arte* "and beyond," according to a long-lived system of local or national selection. These types, expanded, heightened and modified, are recognizable in some of the triumphs of comic characterization achieved by the Germanic drama, and by its master, Shakespeare, above all; but this fact must not obscure one of more importance than itself. In the matter of comic as well as of serious characterization—in the individualizing of characters and in evolving them as it were out of the progress of the action—the modern drama has not only advanced, but in a sense revolutionized, the dramatic art, as inherited from its ancient masters.

Yet, however the method and scope of characterization may vary under the influence of different historical epochs and different tendencies or tastes of races or nations, the laws of this branch of the dramatic art remain based on the same essential requirements. What interests us in a man or woman in real life, or in the impressions we form of historical personages, is that which seems to us to give them individuality. A dramatic character must therefore, whatever its part in the action, be sufficiently marked by features of its own to interest the imagination; with these features its subsequent conduct must be consistent, and to them its participation in the action must correspond. In order to achieve such a result, the dramatist must have, in the first instance, distinctly conceived the character, however it may have been suggested to him. His task is, not to paint a copy of some contemporary or "historical" personage, but to conceive a particular kind of man, acting under the operation of particular circumstances. This conception, growing and modifying itself with the progress of the action, also invented by the dramatist, will determine the totality of the character which he creates. The likeness which the result bears to an actual or historical personage may very probably, from secondary points of view, affect the immediate stage success of the creation; upon its dramatic result this likeness can have no influence whatever. In a wider sense than that in which Shakespeare denied the charge that Falstaff was Oldcastle, it should be possible to say of every dramatic character which it is sought to identify with an actual personage, "This is not the man." The mirror of the drama is not a photographic apparatus; and not even the most conscientious combination of science and art can bring back even a "phase" of the real Napoleon.

Distinctiveness, as the primary requisite in dramatic characterization, is to be demanded in the case of all personages introduced into a dramatic action, but not in all cases in an equal degree. Schiller, in adding to the *dramatis personæ* of his *Pisces* superscriptions of their chief characteristics, labels Sacco as "an ordinary person," and this, no doubt, suffices for Sacco. But with the great masters of characterization a few touches, of which the true actor's art knows how to avail itself, distinguish even their lesser characters from one another; and every man is in his humour down to the "third citizen." Elaboration is necessarily reserved for characters who are the more important contributors to the action, and the fulness of elaboration for its heroes. Many expedients may lend their aid to the higher degrees of distinctiveness. Much is gained by a significant introduction of hero or heroine—thus Antigone is dragged in by the watchman, Gloucester enters alone upon the scene, Volpone is discovered in adoration of his golden saint. Nothing marks character more clearly than the use of contrast—as of Othello with Iago, of Ottavio with Max Piccolomini, of Joseph with Charles Surface. Nor is direct antithesis the only effective kind of contrast; Cassius is a foil to Brutus, and Leonora to her namesake the Princess. But, besides impressing the imagination as a conception distinct in itself, each character must maintain a consistency between its conduct in the action and the features it has established as its own. This consistency does not imply uniformity; for, as Aristotle observes, there are characters which, to be represented with uniformity, must be presented as uniformly un-uniform. Of such consistently complex characters the great critic cites no instances, nor indeed are they of frequent occurrence in Greek tragedy; in the modern drama Hamlet is their unrivalled

Probability of action.

Characterization.

Advance of the drama in this respect.

Requisite of character.

Distinctiveness.

Self-consistency.

exemplar; and Weislingen in Goethe's *Götter*, and Alceste in the *Misanthrope*, may be mentioned as other illustrations in dramas differing widely from one another. The list might be enlarged almost indefinitely from the gallery of female characters, in view of the greater pliability and more habitual dependence of the nature of women. It should be added that those dramatic literatures which freely admit of a mixture of the serious with the comic element thereby enormously increase the opportunities of varied characterization. The difficulty of the task at the same time enhances the effect resulting from its satisfactory accomplishment; and, if the conception of a character is found to meet a variety of tests resembling that which life has at hand for every man, its naturalness, as we term it, becomes more obvious to the imagination. "Naturalness" is only another word for what Aristotle terms "propriety"; the artificial rules by which usage has at times sought to define particular species of character are in their origin only a convenience of the theatre, though they have largely helped to conventionalize dramatic characterization. Lastly, a character should be directly effective with regard

Ethical-ness.

to the dramatic action in which it takes part—that is to say, the influence it exerts upon the progress of the action should correspond to its distinctive features; the conduct of the play should seem to spring from the nature of its characters. In other words, no characterization can be effective which is not what may be called economical, *i.e.* which does not strictly limit itself to suiting the purposes of the action. Even the minor characters should not idly intervene; while the chief characters should predominate over, or determine, the course of the action, its entire conception should harmonize with their distinctive features. It is only a Prometheus whom the gods bind fast to a rock, only a Juliet who will venture into a living death for her Romeo. Thus, in a sense, chance is excluded from dramatic action, or rather, like every other element in it, bends to the dramatic idea.

In view of this predominance of character over action, we may appropriately use such expressions as a tragedy of love or jealousy or ambition, or a comedy of character. For such collocations merely indicate that plays so described have proved (or were intended to prove) specially impressive by the conception or execution of their chief character or characters.

The term "manners" (as employed in a narrower sense than the Aristotelian $\lambda\eta\eta$) applies to that which colours both action and characters, but does not determine the essence of

Manners.

either. As exhibiting human agents under certain conditions of time and place, and of the various relations of life, the action of a drama, together with the characters engaged in it, and the incidents and circumstances belonging to it, must more or less adapt itself to the external conditions assumed. From the assumption of some such conditions not even those dramatic species which indulge in the most sovereign licence, such as Old Attic comedy, or burlesque in general, can wholly emancipate themselves; and even supernatural or fantastic characters and actions must suit themselves to some sort of antecedents. But it depends altogether on the measure in which the nature of an action and the development of its characters are effected by considerations of time and place, or of temporary social systems and the transitory distinctions incidental to them, whether the imitation of a particular kind of manners becomes a significant element in a particular play. The Hindu caste-system

Their relative significance.

is an antecedent of every Hindu drama, and the peculiar organization of Chinese society of nearly every Chinese play with which we are acquainted. Greek tragedy itself, though treating subjects derived from no historic age, had established a standard of manners from which in its decline it did not depart with impunity. Again, the imitation of manners of a particular age or country may or may not be of moment in a play. In some dramas, and in some species of drama, time and place are so purely imaginary and so much a matter of indifference that the adoption of a purely conventional standard of manners, or at least the exclusion of any definitely fixed standard, is here desirable. The dual reign of Theseus at Athens (if its period be ascertainable) does not date *A Midsummer*

Night's Dream; nor do the coats of Bohemia in *The Winter's Tale* localize the manners of the customers of Autolycus. Where, on the other hand, as more especially in the historic drama, or in that kind of comedy which directs its shafts against the ridiculous vices of a particular age or country, significance attaches to the degree in which the manners represented resemble what is more or less known, the dramatist will do well to be careful in his colouring. How admirably is the French court specialized in *Henry V.*; how completely are we transplanted among the burghers of Brussels in the opening scenes of *Edmond*; what a portraiture of a clique we have in the *Précieuses ridicules* of Molière; what a reproduction of a class in the pot-house politicians of Holberg! And how minutely have modern dramatists found it necessary to study the more fascinating aspects of *la vie parisienne*, in order to convey to the curious at home and abroad a conviction of the verisimilitude of their pictures! Yet, even in such instances, the dramatist will only use what suits his dramatic purpose; he will select, not transfer in mass, historic features, and discriminate in his use of modern instances. The details of historic fidelity, and the lesser shades distinguishing the varieties of social usage, will be introduced by him at his choice, or left to be supplied by the actor. Where the reproduction of manners becomes the primary purpose of a play, its effect can only be of an inferior kind; and a drama purely of manners is a contradiction in terms.

No complete system of dramatic species can be abstracted from any one dramatic literature. They are often the result of particular antecedents, and their growth is often affected by peculiar conditions. Different nations or *Species of the drama.*

ages use the same names and may preserve some of the same rules for species which in other respects their usage may have materially modified from that of their neighbours or predecessors. The very question of the use of measured or pedestrian speech as fit for different kinds of drama, and therefore distinctive of them, cannot be profitably discussed except in reference to particular literatures. In the Chinese drama the most solemn themes are treated in the same form—an admixture of verse and prose—which not so very long since was characteristic of that ariest of Western dramatic species, the French *vaudeville*. Who would undertake to define, except in the applications which have been given to the words in successive generations, such terms as "tragi-comedy," or indeed as "drama" (*drame*) itself? Yet this uncertainty does not imply that all is confusion in the terminology as to the species of the drama. In so far as they are distinguishable according to the effects which their actions, or those which the preponderating parts of their actions, produce, these species may primarily be ranged in accordance with the broad difference established by Aristotle between tragedy and comedy. "Tragic" and "comic" effects differ in regard to the emotions of the mind which they excite; and a drama is tragic or comic according as such effects are produced by it. The strong or serious emotions are *Tragic and comic.* alone capable of exercising upon us that influence which, employing a bold but marvellously happy figure, Aristotle termed *purification*, and which a Greek comedian, after a more matter-of-fact fashion, thus expressed:

"For whoso'er a man observes his fellow
Bear wrongs more grievous than himself has known,
More easily he bears his own misfortunes."

That is to say, the petty troubles of self which disturb without elevating the mind are driven out by the sympathetic participation in greater griefs, which raises while it excites the mind employed upon contemplating them. It is to these emotions—which are and can be no others than pity and terror—that actions which we call tragic appeal. *Naïf* as we may think Aristotle in desiderating for such actions a complicated rather than a simple plot, he obviously means that in form as well as in design they should reveal their relative importance. Those actions which we term comic address themselves to the sense of the ridiculous, and their themes are those vices and moral infirmities the representation of which is capable of touching the springs of laughter. Where, accordingly, a drama confines itself to effects of the

former class, it may be called a pure "tragedy"; when to those of the latter, a pure "comedy." In dramas where the effects are mixed the nature of the main action and of the main characters (as determined by their distinctive features) alone enables us to classify such plays as serious or humorous dramas—or as "tragic" or "comic," if we choose to preserve the terms. But the classification admits of a variety of transitions, from "pure" tragedy to "mixed," from "mixed tragedy" to "mixed comedy," and thence to "pure comedy," with the more freely licensed "farce" and "burlesque," the time-honoured inversion of the relations of dramatic method and purpose. This system of distinction has no concern with the mere question of the termination of the play, according to which Philostratus and other authorities have sought to distinguish tragic from comic dramas. The serious drama which ends happily (the German *Schauspiel*) is not a species co-ordinate with tragedy and comedy, but at the most a subordinate variety of the former. Other distinctions may be almost infinitely multiplied, according to the point of view adopted for the classification.

The historical sketch of the drama attempted in the following pages will best serve to indicate the successive growth of national dramatic species, many of which, by asserting their influence in other countries and ages than those which gave birth to them, have acquired a more than national vitality.

The art of acting, whose history forms an organic though a distinct part of that of the drama, necessarily possesses a theory and a technical system of its own. But into these it is

The art of acting.

impossible here to enter. One claim, however, should be vindicated for the art of acting, viz. that, though it is a dependent art, and most signally so in its highest forms, yet its true exercise implies (however much the term may have been abused) a creative process. The conception of a character is determined by antecedents not of the actor's own making; and the term originality can be applied to it only in a relative sense. Study and reflection enable him, with the aid of experience and of the intuition which genius bestows, but which experience may in a high degree supply, to interpret, to combine, and to supplement given materials. But in the transformation of the conception into the represented character the actor's functions are really creative; for here he becomes the character by means which belong to his art alone. The distinctiveness which he gives to the character by making the principal features recognized by him in it its groundwork—the consistency which he maintains in it between groundwork and details—the appropriateness which he preserves in it to the course of the action and the part borne in it by the character—all these are of his own making, though

his means.

suggested by the conception derived by him from his materials. As to the means at his disposal, they are essentially of two kinds only; but not all forms of the drama have admitted of the use of both, or of both in the same completeness. All acting includes the use of gesture, or, as it has been more comprehensively termed, of bodily eloquence.

Costume.

From various points of view its laws regulate the actor's bearing, walk and movements of face and limbs. They teach what is aesthetically permitted and what is aesthetically pleasing. They deduce from observation what is appropriate to the expression of particular affections of the mind and of their combinations, of emotions and passions, of physical and mental conditions—joy and grief, health and sickness, waking, sleeping and dreaming, madness, collapse and death—of particular ages of life and temperaments, as well as of the distinctive characteristics of

Speech.

race, nationality or class. While under certain conditions—as in the masked drama—the use of bodily movement as one of the means of expression has at times been partially restricted, there have been, or are, forms of the drama which have altogether excluded the use of speech (such as pantomime), or have restricted the manner of its employment (such as opera). In the spoken drama the laws of rhetoric regulate the actor's use of speech, but under conditions of a special nature. Like the orator, he has to follow the laws of pronunciation, modulation, accent and rhythm (the last in certain kinds of prose as well as in such forms of verse as he may

be called upon to reproduce). But he has also to give his attention to the special laws of dramatic delivery, which vary in soliloquy and dialogue, and in such narrative or lyrical passages as may occur in his part.

The totality of the effect produced by the actor will in some degree depend upon other aids, among which those of a purely external kind are unlikely to be lost sight of. But the *Costume.* significance of costume (*q.v.*) in the actor, like that of decoration and scenery (see THEATRE) in an action, is a wholly relative one, and is to a large measure determined by the claims which custom enables the theatre to make, or forbids its making, upon the imagination of the spectators. The actor's real achievement lies in the transformation which the artist himself effects; nor is there any art more sovereign in the use it can make of its means, or so happy in the directness of the results it can accomplish by them.

II. INDIAN DRAMA

The origin of the Indian drama may unhesitatingly be described as purely native. The Mahomedans, when they overran India, brought no drama with them; the Persians, the Arabs and the Egyptians were without a national theatre. It would be absurd to suppose the Indian drama to have owed anything to the Chinese or its offshoots. On the other hand, there is no real evidence for assuming any influence of Greek examples upon the Indian drama at any stage of its progress. Finally, it had passed into its decline before the dramatic literature of modern Europe had sprung into being.

The Hindu writers ascribe the invention of dramatic entertainments to an inspired sage Bharata, or to the communications made to him by the god Brahma himself concerning *Origin.* an art gathered from the Vedas. As the word *Bharata* signifies an actor, we have clearly here a mere personification of the invention of the drama. Three kinds of entertainments, of which the *nṛtya* (defined as a dance combined with gesticulation and speech) comes nearest to the drama, were said to have been exhibited before the gods by the spirits and nymphs of Indra's heaven, and to these the god Siva added two new styles of dancing.

The origin of the Indian drama was thus unmistakably religious. Dramatic elements first showed themselves in certain of the hymns of the *Rig Veda*, which took the form of dialogues between divine personages, and in one of which is to be found the germ of Kālidāsa's famous *Vikrama and Urvśi*. These hymns were combined with the dances in the festivals of the gods, which soon assumed a more or less conventional form. Thus, from the union of dance and song, to which were afterwards added narrative recitation, and first sung, then spoken, dialogue, was gradually evolved the acted drama. Such scenes and stories from the mythology of Vishnu are still occasionally enacted by pantomime or spoken dialogue in India (*jātras* of the Bengalis; *śāsas* of the Western Provinces); and the most ancient Indian play was said to have treated an episode from the history of that deity—the choice of him as a consort by Laxmi—a favourite kind of subject in the Indian drama. The tradition connecting its earliest themes with the native mythology of Vishnu agrees with that ascribing the origin of a particular kind of dramatic performance—the *saṅgū*—to Krishna and the shepherdesses. The author's later poem, the *Gūḡagovinda*, has been conjectured to be suggestive of the earliest species of Hindu dramas. But, while the epic poetry of the Hindus gradually approached the dramatic in the way of dialogue, their drama developed itself independently out of the union of the lyric and the epic forms. Their dramatic poetry arose later than their epos, whose great works, the *Mahābhārata* and the *Ramayana*, had themselves been long preceded by the hymnody of the *Vedas*—just as the Greek drama followed upon the Homeric poems and these had been preceded by the early hymns.

There seems, indeed, no reason for dating the beginnings of the regular Indian drama farther back than the 5th century A.D., though it is probable that the earliest extant Sanskrit play, the delightful, and in some respects incomparable, *Mṛichchhakatikā*

(*The Toy Cart*), was considerably earlier in date than the works of Kālidāsa. Indeed, of his predecessors in dramatic composition very little is known, and even the contemporaries who competed with him as dramatists are mere names. Thus, by the time the Indian drama produced almost the earliest specimens with which we are acquainted, it had already reached its zenith; and it was therefore looked upon as having sprung into being as a perfect art. We know it only in its glory, in its decline, and in its decay.

The history of Indian dramatic literature may be roughly divided into the following periods,

I. *To the 11th Century A.D.*—This period virtually belongs to the pre-Mahomedan age of Indian history; but already to that

First period (classical).

second division of it in which Buddhism had become a powerful factor in the social as well as in the moral and intellectual life of the land. It is the classical period of the Hindu drama, and includes the works of its two indisputably greatest masters. The earliest extant Sanskrit play is the pathetic *Mricchhakatikā* (*The Toy Cart*), which has been dated back as far as the close of the 2nd century A.D. It is attributed (as is not uncommon with Indian plays) to a royal author, named Sūdraka; but it was more probably written by his court poet, whose name has been concluded to have been Dandin. It may be described as a comedy of middle-class life, treating of the courtship and marriage of a ruined Brahman and a wealthy and large-hearted courtesan.

Kālidāsa, the brightest of the "nine gems" of genius in whom the Indian drama gloried, lived at the court of Ujjain, though whether in the earlier half of the 6th century A.D., or in the 3rd century, or at a yet earlier date, remains an unsettled question. He is the author of *Sākuntalā*—the work which, in the translation by Sir William Jones (1780), first revealed to the Western world of letters the existence of an Indian drama, since reproduced in innumerable versions in many tongues. This heroic comedy, in seven acts, takes its plot from the first book of the *Mahābhārata*. It is a dramatic love-idyll of surpassing beauty, and one of the masterpieces of the poetic literature of the world. Another drama by Kālidāsa, *Vikrama and Urdasi* (*The Hero and the Nymph*), though unequal as a whole to *Sākuntalā*, contains one act of incomparable loveliness; and its enduring effect upon Indian dramatic literature is shown by the imitations of it in later plays. (It was translated into English in 1827 by H. H. Wilson.) To Kālidāsa has likewise been attributed a third play, *Mālavikā and Agnimitra*; but it is possible that this conventional comedy, though held to be of ancient date, was composed by a different poet of the same name.

To Harsadeva, king of northern India, are ascribed three extant plays, which were more probably composed by some poet in his pay. One of these, *Nagananda* (*Joy of the Serpents*), which begins as an erotic play, but passes into a most impressive exemplification of the supreme virtue of self-sacrifice, is notable as the only Buddhist drama which has been preserved, though others are known to have existed and to have been represented.

The palm of pre-eminence is disputed with Kālidāsa by the great dramatic poet Bābhavūti (called Crikānta, or he in whose throat is fortune), who flourished in the earlier part of the 8th century. While he is considered more artificial in language than his rival, and in general more bound by rules, he can hardly be deemed his inferior in dramatic genius. Of his three extant plays, *Mahādeva-Charitra* and *Uttara-Rāma-Charitra* are heroic dramas concerned with the adventures of Rāma (the seventh incarnation of Vishnu); the third, the powerful melodrama, in ten acts, of *Mālatī and Mādhava*, has love for its theme, and has been called (perhaps with more aptitude than usually belongs to such comparisons) the *Romeo and Juliet* of the Hindus. It is considered by their critical authorities the best example of the *prakarāka*, or drama of domestic life. Bābhavūti's plays, as is indicated by the fact that no jester appears in them, are devoid of the element of humour.

The plays of Rājasekhara, who lived about the end of the 9th century, deal, like those of Harsadeva, with harem and court life. One of them, *Karpura Manjuri* (*Camphor Cluster*),

is stated to be the only example of the *saltaka* or minor heroic comedy, written entirely in Prakrit.

In this period may probably also be included Viśākhadatta's interesting drama of political intrigue, *Mudra-Rakshasa* (*The Signet of the Minister*), in which Chandragupta (Sandracottus) appears as the founder of a dynasty. In subject, therefore, this production, which is one of the few known Indian historical dramas, goes back to the period following on the invasion of India by Alexander the Great; but the date of composition is probably at least as late as A.D. 1000. The plot of the play turns on the gaining-over of the prime minister of the *ancien régime*.

Among the remaining chief works of this period is the *Veni-Samhara* (*Binding of the Braid*) by Nārāyana Bhatta. Though described as a play in which both pathos and horror are exaggerated—its subject is an outrage resembling that which Dunstan is said to have inflicted on Elgiva—it is stated to have been always a favourite, as written in exact accordance with dramatic rules. Perhaps the *Condakāsika* by Ksemisvara should also be included, which deals with the working of a curse pronounced by an aged priest upon a king who had innocently offended him.

II. *The Period of Decline.*—This may be reckoned from about the 11th to about the 14th century of the Christian era, the beginning roughly coinciding with that of a continuous series of Mahomedan invasions of India. *Hansuman-Nalaka*, or "the great Natika" (for this irregular play, the work of several hands, surpasses all other Indian dramas in length, extending over no fewer than fourteen acts), dates from the 10th or 11th century. Its story is taken from the Rāma-cycle, and a prominent character in it is the mythical monkey-chief King Hanuman, to whom, indeed, tradition ascribed the original authorship of the play. Kfishāmicra's "theosophic mystery," as it has been called,—though it rather resembles some of the moralities,—*Prabodha-Chandrodaya* (*The Rise of the Moon of Insight*, i.e. the victory of true doctrine over error), is ascribed by one authority to the middle of the 11th century, by another to about the end of the 12th. The famous *Ratnavali* (*The Necklace*), a court-comedy of love and intrigue, with a half-Terentian plot, seems also to date from the earlier half of the period.

The remaining plays of which it has been possible to conjecture the dates range in the time of their composition from the end of the 11th to the 14th century. Of this period, as compared with the first, the general characteristics seem to be an undue preponderance of narrative and description, and an affected and over-elaborated style. As a striking instance of this class is mentioned a play on the adventures of Rāma, the *Anarpha-Rāghava*, which in spite, or by reason, of the commonplace character of its sentiments, the extravagance of its diction, and the obscurity of its mythology, is stated to enjoy a higher reputation with the pundits of the present age than the masterpieces of Kālidāsa and Bābhavūti. To the close of this period, the 14th century, has likewise (but without any pretension to certainty) been ascribed the only Tamil drama of which we possess an English version. *Arichandra* (*The Martyr of Truth*) exemplifies—with a strange likeness in the contrivance of its plot to the *Book of Job* and *Faust*—by the trials of a heroically enduring king the force of the maxim "Better die than lie."

III. *Period of Decay.*—Isolated plays remain from centuries later than the 14th; but these, which chiefly turn on the legends of Kfishāsa (the last incarnation of Vishnu), may be regarded as a mere aftergrowth, and exhibit the Indian drama in its decay. Indeed, the latest of them, *Chitra-Yajna*, which was composed about the beginning of the 19th century, and still serves as a model for Bengali dramatic performances, is imperfect in its dialogue, which (after the fashion of Italian improvised comedy) is left to the actors to supplement. Besides these there are farces or farcical entertainments, more or less indelicate, of uncertain dates.

The number of plays which have descended to us from so vast an expanse of time is still comparatively small. But though, in 1827, Wilson doubted whether all the plays to be found, and

Second period (decline).

Third period (decay).

those mentioned by Hindu writers on the drama, amounted to many more than sixty, M. Schuyler's bibliography (1906) enumerates over five hundred Sanskrit plays. To these have to be added the plays in Tamil, stated to be about a hundred in number, and to have been composed by poets who enjoyed the patronage of the Pandian kings of Madura, and some in other vernaculars.

There certainly is among the Hindus no dearth of dramatic theory. The sage Bharata, the reputed inventor of dramatic entertainments, was likewise revered as the father of dramatic criticism—a combination of functions to which the latter days of the English theatre might perhaps furnish an occasional parallel. The commentators (possibly under the influence of inspiration rather than as a strict matter of memory) constantly cite his *sūtras*, or aphorisms. (From *sūtra*, thread, was named the *sūtra-dhāra*, thread-holder, carpenter's term applied to the architect and general manager of sacrificial solemnities, then to the director of theatrical performances.) By the 11th century, when the drama was already approaching its decline, dramatic criticism had reached an advanced point; and the *Dasa-Rupaka* (of which the text belongs to that age) distinctly defines the ten several kinds of dramatic composition. Other critical works followed at later dates, exhibiting a rage for subdivision unsurpassed by the efforts of Western theorists, ancient or modern; the misfortune is that there should not be examples remaining (if they ever existed) to illustrate all the branches of so elaborate a dramatic system.

"What," inquires the manager of an actor in the induction to one of the most famous of Indian plays, "are those qualities which the virtuous, the wise, the venerable, the learned and the Brahmans require in a drama?" "Profound exposition of the various passions," is the reply, "pleasing interchange of mutual affection, loftiness of character, delicate expression of desire, a surprising story and elegant language." "Then," says the manager (for the Indian dramatists, though not, like Ben Jonson, wont to "rail" the public "into approbation," are unaffected by *maussais honie*), "I recollect one." And he proceeds to state that "Babhavūti has given us a drama composed by him, replete with all qualities, to which indeed this sentence is applicable: 'How little do they know who speak of us with censure! This entertainment is not for them. Possibly some one exists, or will exist, of similar tastes with myself; for time is boundless, and the world is wide!'" This disregard of popularity, springing from a consciousness of lofty aims, accounts for much that is characteristic of the higher class of Indian plays. It explains both their relative paucity and their extraordinary length, renders intelligible the chief peculiarity in their diction, and furnishes the key to their most striking ethical as well as literary qualities. Connected in their origin with religious worship, they were only performed on solemn occasions, chiefly of a public nature, and more especially at seasons sacred to some divinity. Thus, though they might in some instances be reproduced, they were always written with a view to one particular solemn representation. Again, the greater part of every one of the plays of Northern India is written in Sanskrit, which ceased to be a popular language by 300 B.C., but continued the classical and learned, and at the same time the sacred and court form of speech of the Brahmans. Sanskrit is spoken by the heroes and principal personages of the plays, while the female and inferior characters use varieties, more or less refined, of the Prakrit languages (as a rule not more than three, that which is employed in the songs of the women being the poetic dialect of the most common Prakrit language, the Saurasēni). Hence, part at least of each play cannot have been understood by the large majority of the audience, except in so far as their general acquaintance with the legends or stories treated enabled them to follow the course of the action. Every audience thus contained an *inner* audience, which could alone feel the full effect of the drama. It is, then, easy to see why the Hindu critics should make demands upon the art, into which only highly-trained and refined intellects were capable of entering, or called upon to enter. The general public could not be expected

to appreciate the sentiments expressed in a drama, and thus (according to the process prescribed by Hindu theory) to receive instruction by means of amusement. These sentiments are termed *rāsas* (tastes or flavours), and said to spring from the *bhāvas* (conditions of mind and body). A variety of subdivisions is added; but the *sakta rāsa* is logically enough excluded from dramatic composition, inasmuch as it implies absolute quiescence.

The Hindu critics know of no distinction directly corresponding to that between tragedy and comedy, still less of any determined by the nature of the close of a play. For, in accordance with the child-like element of their character, the Hindus dislike an unhappy ending to any story, and a positive rule accordingly prohibits a fatal conclusion in their dramas. The general term for all dramatic compositions is *rūpaka* (from *rūpa*, form), those of an inferior class being distinguished as *uparūpakas*. Of the various subdivisions of the *rūpaka*, in a more limited sense, the *nūttaka*, or play proper, represents the most perfect kind. Its subject should always be celebrated and important—it is virtually either heroism or love, and most frequently the latter—and the hero should be a demigod or divinity (such as *Rāma* in *Babhavūti*'s heroic plays) or a king (such as the hero of *Sakuntalā*). But although the earlier dramatists took their plots from the sacred writings or *Purāṇas*, they held themselves at liberty to vary the incidents—a licence from which the later poets abstained. Thus, in accordance, perhaps, with the respective developments in the religious life of the two peoples, the Hindu drama in this respect reversed the progressive practice of the Greek. The *prakārohas* agree in all essentials with the *nūttakas* except that they are less elevated; their stories are mere fictions, taken from actual life in a respectable class of society.¹ Among the species of the *uparūpaka* may be mentioned the *trōlaka*, in which the personages are partly human, partly divine, and of which a famous example remains.² Of the *bhāsa*, a monologue in one act, one literary example is extant—a curious picture of manners in which the speaker describes the different persons he meets at a spring festival in the streets of Kolahalapur.³ The satire of the farcical *prakāśanas* is usually directed against the hypocrisy of ascetics and Brahmans, and the sensuality of the wealthy and powerful. These trifles represent the lower extreme of the dramatic scale, to which, of course, the principles that follow only partially apply.

Unity of action is strictly enjoined by Hindu theory, though not invariably observed in practice. Episodic or prolix interruptions are forbidden; but, in order to facilitate the connexion, the story of the play is sometimes carried on by narratives spoken by actors or "interpreters," something after the fashion of the Chorus in *Henry V.*, or of Gower in *Pericles*. "Unity of time" is liberally, if rather arbitrarily, understood by the later critical authorities as limiting the duration of the action to a single year; but even this is exceeded in more than one classical play.⁴ The single acts are to confine the events occurring in them to "one course of the sun," and usually do so. "Unity of place" is unknown to the Hindu drama, by reason of the absence of scenery; for the plays were performed in the open courts of palaces, perhaps at times in large halls set apart for public entertainments, or in the open air. Hence change of scene is usually indicated in the texts; and we find the characters making long journeys on the stage, under the eyes of spectators not trained to demand "real" mileage.

With the solemn character of the higher kind of dramatic performances accord the rules and prohibitions defining what may be called the *proprieties* of the Indian drama. It has been already seen that all plays must have a happy ending. Furthermore, not only should death never be inflicted *coram populo*, but the various operations of biting, scratching, kissing, eating, sleeping, the bath, and the marriage ceremony should never take place on the stage. Yet such rules are made to be occasionally broken. It is true that the mild humour of the *vidūshaka* is restricted to his "gesticulating

¹ e.g. *Mrichchhakatika*; *Mātaṅg and Mādhava*.

² *Vikrama and Urvśī*. ³ *Safado-Tilaka*.

⁴ *Sakuntalā*; *Uttara-Rāma-Charitra*. ⁵ *Aricandro*, act iv.

Critical
Literature.

Species of
dramas.

Exclusiveness
of the
Indian
drama.

The
"unites."

Pro-
prieties.

phase in the cycle of his destinies, the highest of moral efforts at the same time points to the summit of possibilities, and self-sacrifice is the supreme condition both of individual perfection and of the progress of the world. Such conceptions as these seem at once to enfold and to overshadow the moral life of the Indian drama. The affections and passions forming part of self it delineates with a fidelity to nature which no art can afford to neglect; on the other hand, the freedom of the picture is restricted by conditions which to us are unfamiliar and at times seem intolerable, but which it was impossible for the Indian poet's imagination to ignore. The sheer self-absorption of ambition or love appears inconceivable by the minds of any of these poets; and their social philosophy is always based on the system of caste. On the other hand, they are masters of many of the truest forms of pathos, above all of that which blends with resignation. In humour of a delicate kind they are by no means deficient; to its lower forms they are generally strangers, even in productions of a professedly comic intention. Of wit, Indian dramatic literature—though a play on words is as the breath of its nostrils—furnishes hardly any examples intelligible to Western minds.

The distinctive excellence of the Indian drama is to be sought in the poetic robe which envelops it as flowers overspread the

Poetry of the Indian drama.

bosom of the earth in the season of spring. In its nobler productions, at least, it is never untrue to its half religious, half rural origin; it weaves the wreaths of idyllic fancies in an unbroken chain, adding to its

favourite and familiar blossoms ever fresh beauties from an inexhaustible garden. Nor is it unequal to depicting the grander aspects of nature in her mighty forests and on the shores of the ocean. A close familiarity with its native literature can here alone follow its diction through a ceaseless flow of phrase and figure, listen with understanding to the hum of the bee as it hangs over the lotus, and contemplate with Sakuntala's pious sympathy the creeper as it winds round the mango tree. But the poetic beauty of the Indian drama reveals itself in the mysterious charm of its outline, if not in its full glow, even to the untrained; nor should the study of it—for which the materials seem continually on the increase—be left aside by any lover of literature.

3. CHINESE DRAMA

Like the Indian drama, the Chinese arose from the union of the arts of dance and song. To the ballets and pantomimes out of which it developed itself, and which have continued to flourish by the side of its more advanced forms, the Chinese ascribe a primitive antiquity of origin; many of them originally had a symbolical reference to such subjects as the harvest, and war and peace. A very ancient pantomime is said to have symbolized the conquest of China by Wu-Wang; others were of a humbler, and often of a very obscure, character. To their music the Chinese likewise attribute a great antiquity of origin.

There are traditions which carry back the characters of the Chinese drama to the 18th century before the Christian era. Others declare the Emperor Wan-Te (β. about A.D. 580) to have invented the drama; but this honour is more usually given to the emperor Yuen-Tsung (A.D. 720), who is likewise remembered as a radical musical reformer. Pantomimes henceforth fell into disrepute; and the history of the Chinese drama from this date is divided, with an accuracy we cannot profess to control, into four distinct periods. Each of these periods, we are told, has a style, and each style a name of its own; but these names, such as "Divisions of the Woods in Flower," have little or no meaning for us; and it would therefore be useless to cite them.

The first period is that of the dramas composed under the T'ang dynasty, from A.D. 720 to 907. These pieces, called *Tchouen-Khi*, were limited to the representation of extraordinary events, and were therefore, in design at least, a species of heroic drama. The ensuing times of civil war interrupted the "pleasures of peace and prosperity" (a Chinese phrase for dramatic performances)—which, however, revived.

The second period is that of the Tsung Dynasty, from 960 to

1119. The plays of this period are called *Hi-Khio*, and presented what became a standing peculiarity of the Chinese *Classical drama*, viz. that in them figures a principal personage *who sings*.

The third and best-known age of the Chinese drama was under the Kin and Yuen dynasties, from 1125 to 1367. The plays of this period are called *Yuen-Pen* and *Tsa-Ki*; the latter seem to have resembled the *Hi-Khio*, and to have treated very various subjects. The *Yuen-Pen* are the plays from which our literary knowledge of the Chinese drama is mainly derived; the short pieces called *Yen-Kia* were in the same style, but briefer. The list of dramatic authors under the Yuen dynasty, the most important period in Chinese literary annals, which covered the years 1260 to 1368, is tolerably extensive, comprising 85, among whom four are designated as courtesans; the number of plays composed by these and by anonymous authors is reckoned at not less than 564. In 1735 the Jesuit missionary Joseph Henry Prémare first revealed to Europe the existence of the tragedy *Tchao-Chi-Cu-Eul* (*The Little Orphan of the House of Tchao*), which was founded upon an earlier piece treating of the fortunes of an heir to the imperial throne, who was preserved in a mysterious box like another Cypselus or Moses. Voltaire seized the theme of the earlier play for a rhetorical tragedy, *L'Orphelin de la Chine*, in which he coolly professes it was his intention "to paint the manners of the Chinese and the Tartars." The later play, which is something less elevated in the rank of its characters, and very decidedly less refined in treatment, was afterwards retranslated by Stanislas Julien; and to the labours of this scholar, of Sir J. F. Davis (1795-1890) and of Antoine Bazin (1799-1863), we owe a series of translated Chinese dramas, among which there can be no hesitation whatever in designating the master-piece.

The justly famous *Pi-Pa-Ki* (*The Story of the Lute*) belongs to a period rather later than that of the Yuen plays, having been composed towards the close of the 14th century by *Pi-Pa-Ki*. Kao-Tong-Kia, and reproduced in 1404, under the Ming dynasty, with the alterations of Mao-Tsue, a commentator of learning and taste. *Pi-Pa-Ki*, which as a domestic drama of sentiment possesses very high merit, long enjoyed a quite exceptional popularity in China; it was repeatedly republished with laudatory prefaces, and so late as the 18th century was regarded as a monument of morality, and as the master-piece of the Chinese theatre. It would seem to have remained without any worthy competitors; for, although it had been originally designed to produce a reaction against the immorality of the drama then in fashion, especially of Wang-Chi-Fou's celebrated *Si-Siang-Ki* (*The Story of the Western Pavilion*), yet the fourth period of the Chinese drama, under the Ming dynasty, from 1368 to 1644, exhibited no improvement. "What" *Dictionnaire and ducy.* (says the preface to the 1704 edition of *Pi-Pa-Ki*) "do you find there? Farcical dialogue, a mass of scenes in which one fancies one hears the hubbub of the streets or the ignoble language of the highways, the extravagances of demons and spirits, in addition to love-intrigues repugnant to delicacy of manners." Nor would it appear that the Chinese theatre has ever recovered from its decay.

In theory, no drama could be more consistently elevated in purpose and in tone than the Chinese. Every play, we learn, should have both a moral and a meaning. A virtuous aim is imposed upon Chinese dramatists by an article of the penal code of the empire; and those who write immoral plays are to expect after death a purgatory which will last so long as these plays continue to be performed. In practice, however, the Chinese drama falls far short of its ideal; indeed, according to the native critic already cited, among ten thousand playwrights not one is to be found intent upon perfecting the education of mankind by means of precepts and examples.

The Chinese are, like the Hindus, unacquainted with the distinction between tragedy and comedy; they classify their plays according to subjects in twelve categories. It may be doubted whether what seems the highest of these is actually such; for the religious element in the Chinese drama is often sheer buffoonery. Moreover, Chinese religious

Religious drama.

life, as reflected in the drama, seems one in which creed elbows creed, and superstitions are welcome whatever their origin. Of all religious traditions and doctrines, however, those of Buddhism (which had reached China long before the known beginnings of its drama) are the most prominent; thus, the theme of absolute self-sacrifice is treated in one play,¹ that of entire absorption in the religious life in another.² The historical

Historical. drama is not unknown to the Chinese; and although a law prohibits the bringing on the stage of "emperors, empresses, and the famous princes, ministers, and generals of former ages," no such restriction is observed in practice. In *Han-Kong-Tseu* (*The Sorrows of Han*), for instance, which treats a national historic legend strangely recalling in parts the story of Esther and the myth of the daughter of Erechtheus, the emperor Yuen-Ti (the representative, to be sure, of a fallen dynasty) plays a part, and a sufficiently sorry one.

Domestic. By far the greater number, however, of the Chinese plays accessible in translations belong to the domestic species, and to that subspecies which may be called the criminal drama. Their favourite virtue is piety, of a formal³ or a practical⁴ kind to parents or parents-in-law; their favourite interest lies in the discovery of long-hidden guilt, and in the vindication of persecuted innocence.⁵ In the choice and elaboration of such subjects they leave little to be desired by the most ardent devotees of the literature of agony. Besides this description of plays, we have at least one love-comedy pure and simple—a piece of a nature not "tolerably mild," but ineffably harmless.⁶

Free in its choice of themes, the Chinese drama is likewise remarkably unrestricted in its range of characters. Chinese society, it is well known, is not based, like Indian,

Range of characters. upon the principle of caste; rank is in China determined by office, and this again depends on the results of examination. These familiar facts are constantly brought home to the reader of Chinese plays. The *Tchoang-Yuen*, or senior classman on the list of licentiates, is the flower of Chinese society, and the hero of many a drama;⁷ and it is a proud boast that for years "one's ancestors have held high posts, which they owed to their literary successes."⁸ On the other hand, a person who has failed in his military examination, becomes, as if by a natural transition, a man-eating monster.⁹ But of mere class the Chinese drama is no respecter, painting with noteworthy freedom the virtues and the vices of nearly every phase of society. The same liberty is taken with regard to the female sex; it is clear that in earlier times there were few vexatious restrictions in Chinese life upon the social intercourse between men and women. The variety of female characters in the Chinese drama is great, ranging from the heroine who sacrifices herself for the sake of an empire¹⁰ to the well-brought-up young lady who avers that "woman came into the world to be obedient, to unravel skeins of silk, and to work with her needle"¹¹—from the chambermaid who contrives the most gently sentimental of *rendezvous*,¹² to the reckless courtesan who, like another Millwood, upbraids the partner of her guilt on his suing for mercy, and bids him die with her in hopes of a reunion after death.¹³ In marriage the first or legitimate wife is distinguished from the second, who is at times a *ci-devant* courtesan, and towards whom the feelings of the former vary between bitter jealousy¹⁴ and sisterly kindness.¹⁵

The conduct of the plays exhibits much ingenuity, and an aversion from restrictions of time and place; in fact, the nature of the plot constantly covers a long series of years, and spans wide intervals of local distance. The plays are divided into acts and scenes—the former being usually four in number, at times

¹ *The Self-Sacrifice of Tchoao-Li.*
² *Lai-Seng-Tchai* (*The Debt to be Paid in the Next World*).
³ *Lao-Seng-Eul.*
⁴ *Pi-Pa-Ki.*
⁵ *The Circle of Chalk* (*Hoel-Lan-Ki*); *The Tunic Matched*; *The Revenge of Teou-Ngo.*

⁶ *Tchoao-Mei-Hiang* (*The Intrigues of a Chambermaid*).
⁷ *Tchoao-Mei-Hiang*; *Ho-Han-Chan*; *Pi-Pa-Ki.*
⁸ *Hoel-Lan-Ki*, Prol. sc. i.
⁹ *Thao-Li.*
¹⁰ *Han-Kong-Tseu.*
¹¹ *Pi-Pa-Ki*, sc. 2.
¹² *Tchoao-Mei-Hiang.*
¹³ *He-Lang-Tan*, act. iv.; cf. *Hoel-Lan-Ki*, act. iv.
¹⁴ *Hoel-Lan-Ki.*
¹⁵ *Pi-Pa-Ki.*

with an induction or narrative prologue spoken by some of the characters (*Sie-Tsen*). Favourite plays were, however, allowed to extend to great length; the *Pi-Pa-Ki* is divided into 24 sections, and in another recension apparently comprised 42. "I do not wish," says the manager in the prologue, "that this performance should last too long; finish it to-day, but cut out nothing"—whence it appears that the performance of some plays occupied more than a single day. The rule was always observed that a separate act should be given up to the *dénouement*; while, according to a theory of which it is not always easy to trace the operation, the perfection of construction was sought in the dualism or contrast of scene and scene, just as the perfection of diction was placed in the parallelism or antithesis of phrase and phrase. Being subject to no restrictions as to what might, or might not, be represented on the stage, the conduct of the plots allowed of the introduction of almost every variety of incidents. Death takes place, in sight of the audience, by starvation,¹⁶ by drowning,¹⁷ by poison,¹⁸ by execution;¹⁹ flogging and torture are inflicted on the stage;²⁰ wonders are wrought;²¹ and magic is brought into play;²² the ghost of an innocently-executed daughter calls upon her father to revenge her foul murder, and assists in person at the subsequent judicial enquiry.²³ Certain peculiarities in the conduct of the business are due to the usages of society rather than to dramatic laws. Marriages are generally managed—at least in the higher spheres of society—by ladies professionally employed as matrimonial agents.²⁴ The happy resolution of the *modus* of the action is usually brought about by the direct interposition of superior official authority²⁵—a tribute to the paternal system of government, which is the characteristic Chinese variety of the *deus ex machina*. This naturally tends to the favourite close of a glorification of the emperor,²⁶ resembling that of Louis XIV. at the end of *Tartufe*, or in spirit, at all events, those of the virgin queen in more than one Elizabethan play. It should be added that the characters save the necessity for a bill of the play by persistently announcing and re-announcing their names and genealogies, and the necessity for a book by frequently recapitulating the previous course of the plot.

One peculiarity of the Chinese drama remains to be noticed. The chief character of a play represents the author as well as the personage; he or she is hero or heroine and chorus in one. This is brought about by the hero's (or heroine's) singing the poetical passages, or those containing maxims of wisdom and morality, or reminiscences and examples drawn from legend or history. Arising out of the dialogue, these passages at the same time diversify it, and give to it such elevation and brilliancy as it can boast. The singing character must be the principal personage in the action, but may be taken from any class of society. If this personage dies in the course of the play, another sings in his place. From the mention of this distinctive feature of the Chinese drama it will be obvious how unfair it would be to judge of any of its productions, without a due appreciation of the lyric passages, which do not appear to be altogether restricted to the singing of the principal personage, for other characters frequently "recite verses." In these lyrical or didactic passages are to be sought those flowers of diction which, as Julien has shown, consist partly in the use of a metaphorical phraseology of infinite nicety in its variations—such as a long series of phrases compounded with the word signifying *jd* and expressing severally the ideas of rarity, distinction, beauty, &c., or as others derived from the names of colours, birds, beasts, precious metals, elements, constellations, &c., or alluding to favourite legends or anecdotes. These features constitute the literary element *par excellence* of Chinese dramatic composition. At the same time, though it is impossible for the untrained reader to be alive to

¹⁶ *Pi-Pa-Ki*, sc. 15.
¹⁷ *Hoel-Lan-Ki*, act. i.
¹⁸ *Hoel-Lan-Ki*, act. ii.
¹⁹ *Pi-Pa-Ki*, sc. 18.
²⁰ *Tchoao-Mei-Hiang*; *Pi-Pa-Ki.*
²¹ *Ho-Han-Chan*.

²² *Ho-Han-Chan*, act. ii.
²³ *Teou-Ngo-Yuen*, act. iii.
²⁴ *Teou-Ngo-Yuen*, act. iii.
²⁵ *Teou-Ngo-Yuen*, act. iv.
²⁶ *Hoel-Lan-Ki.*

the charms of so unfamiliar a phraseology, it may be questioned whether even in its diction the Chinese drama can claim to be regarded as really poetic. It may abound in poetic ornament; it is not, like the Indian, bathed in poetry.

On the other hand, the merits of this dramatic literature are by no means restricted to ingenuity of construction and variety of character—merits, in themselves important, which no candid critic will deny to it. Its master-piece is not only truly pathetic in the conception and the main situations of its action, but includes scenes of singular grace and delicacy of treatment—such as that where the remarried husband of the deserted heroine in vain essays in the presence of his second wife to sing to his new lute, now that he has cast aside the old.¹ In the last act of a tragedy appealing at once to patriotism and to pity, there is true imaginative power in the picture of the emperor, when aware of the departure, but not of the death, of his beloved, sitting in solitude broken only by the ominous shriek of the wild-fowl.² Nor is the Chinese drama devoid of humour. The lively abigail who has to persuade her mistress into confessing herself in love by arguing (almost like Beatrice) that “humanity bids us love men”;³ the corrupt judge (a common type in the Chinese plays) who falls on his knees before the prosecuting parties to a suit as before “the father and mother who give him sustenance,”⁴ may serve as examples; and in *Pi-Pa-Ki* there is a scene of admirable burlesque on the still more characteristic theme of the humours of a competitive examination.⁵ If such illustrations could not easily be multiplied, they are at least worth citing in order to deprecate a perfunctory criticism on the qualities of a dramatic literature as to which our materials for judgment are still scanty.

While in the north of China houses are temporarily set apart for dramatic performances, in the south these are usually confined to theatres erected in the streets (*Hi-Thai*). These scenic decorations of any importance must always have been out of question in the Chinese theatre. The costumes, on the other hand, are described as magnificent; they are traditionally those worn before the 17th century, in accordance with the historical colouring of most of the plays. The actor's profession is not a respectable one in China, the managers being in the habit of buying children of slaves and bringing them up as slaves of their own. Women may not appear on the stage, since the emperor K'ien-Lung admitted an actress among his concubines; female parts are therefore played by lads, occasionally by eunuchs.

4. JAPANESE DRAMA

The Japanese drama, as all evidence seems to agree in showing, still remains what in substance it has always been—an amusement passionately loved by the lower orders, but hardly dignified by literature deserving the name. Apart from its native elements of music, dance and song, and legendary or historical narrative and pantomime, it is clearly to be regarded as a Chinese importation; nor has it in its more advanced forms apparently even attempted to emancipate itself from the reproduction of the conventional Chinese types. As early as the close of the 6th century Hada Kawatsu, a man of Chinese extraction, but born in Japan, is said to have been ordered to arrange entertainments for the benefit of the country, and to have written as many as thirty-three plays. The Japanese, however, ascribe the origin of their drama to the introduction of the dance called *Sambāso* as a charm against a volcanic depression of the earth which occurred in 805; and this dance appears still to be used as a prelude to theatrical exhibitions. In 1108 lived a woman called Iso no Zenji, who is looked upon as “the mother of the Japanese drama.” But her performances seem to have been confined to dancing or posturing in male attire (*otokomai*); and the intro-

duction of the drama proper is universally attributed to Sarnwaka Kanzaburō, who in 1624 opened the first theatre (*sibata*) at Yeddo. Not long afterwards (1651) the playhouses were removed to their present site in the capital; and both here and in the provincial towns, especially of the north, the drama has since continued to flourish. Persons of rank were formerly never seen at these theatres; but actors were occasionally engaged to play in private at the houses of the nobles, who appear themselves to have taken part in performances of a species of opera affected by them, always treating patriotic legends and called *shō*. The mikado has a court theatre.

The subjects of the serious popular plays are mainly mythological—the acts of the great spirit Day-Sin, the incarnation of Brahma, and similar themes—or historical, treating of the doings of the early dynasties. In these the names of the personages are changed. An example of the latter class is to be found in the *jōwari*, or musical romance, in which the universally popular tale of *Chūshingura* (*The Loyal League*) has been amplified and adapted for theatrical representation. This famous narrative of the feudal fidelity of the forty-seven *ronins*, who about the year 1609 revenged their chief's judicial suicide upon the arrogant official to whom it was due, is stirring rather than touching in its incidents, and contains much bloodshed, together with a tea-house scene which suffices as a specimen of the Japanese comedy of manners. One of the books of this dramatic romance consists of a metrical description, mainly in dialogue, of a journey which (after the fashion of Indian plays) has to be carried out on the stage. The performance of one of these quasi-historical dramas sometimes lasts over several days; they are produced with much pomp of costume; but the acting is very realistic, and *hori-kari* is performed, almost “to the life.” Besides these tragic plays (in which, however, comic *intermezzos* are often inserted) the Japanese have middle-class domestic dramas of a very realistic kind. The language of these, unlike that of Chinese comedy, is often gross and scurrilous, but intrigues against married women are rigidly excluded. Fairy and demon operas and ballets, and farces and *intermezzos*, form an easy transition to the interludes of tumblers and jugglers. As a specimen of nearly every class of play is required to make up a Japanese theatrical entertainment, which lasts from sunrise to sunset, and as the lower houses appropriate and mutilate the plays of the higher, it is clear that the status of the Japanese theatre cannot be regarded as at all high. In respect, however, of its movable scenery and properties, it is in advance of its Chinese prototype. The performers are, except in the ballet, males only; and the comic acting is said to be excellent of its kind. Though the leading actors enjoy great popularity and very respectable salaries, the class is held in contempt, and the companies were formerly recruited from the lowest sources. The disabilities under which they lay have, however, been removed; a Dramatic Reform Association has been organized by a number of noblemen and scholars, and a theatre on European lines built (see JAPAN).

5. PERSIAN AND OTHER ASIATIC, POLYNESIAN AND PERUVIAN DRAMA

Such dramatic examples of the drama as may be discoverable in Siam will probably have to be regarded as belonging to a branch of the Indian drama. The drama of the Malay populations of Java and the neighbouring island of Sumatra also resembles the Indian, to which it may have owed what development it has reached. The Javanese, as we learn, distinguish among the lyrics sung on occasions of popular significance the *panlon*, a short simile or fable, and the *icharita*, a more advanced species, taking the form of dialogue and sung or recited by actors proper. From the *icharita* the Javanese drama, which in its higher forms treats the stories of gods and kings, appears to have been derived. As in the Indian drama, the functions of the director or manager are of great importance; as in the Greek, the performers wear masks, here made of wood. The comic drama is often represented in both Java and Sumatra by parties of strollers consisting of

¹ *Pi-Pa-Ki*, sc. 14.

² *Tchao-Met-Hiang*, act. ii.

³ *Tou-Ngo-Yuen*, act. ii.; cf. *Hoel-Lou-Ki*.

⁴ *Pi-Pa-Ki*, sc. 5.

⁵ *Han-Kong-Tsun*.

Java,
Sumatra,
&c.

two men and a woman—a troop sufficient for a wide variety of plot.

Among other more highly civilized Asiatic peoples, the traces of the dramatic art are either few or late. The originally Aryan

Persians exhibit no trace of the drama in their ample earlier literature. But in its later national development the two species, widely different from one another, of the religious drama or mystery and of the popular comedy or farce have made their appearance—the former in a growth of singular interest.

Of the Persian *taziés* (lamentations or complaints) the subjects are invariably derived from religious history, and more or less directly connected with the "martyrdoms" of the

house of Ali. The performance of these episodes or scenes takes place during the first ten days of the month

of Muharram, when the adherents of the great Shi'ite sect all over Persia and Mahomedan India commemorate the deaths of the Prophet and his daughter Fatima, the mother of Ali, the martyrdoms of Ali himself, shamefully murdered in the sanctuary, and of his nonoffending son Hasan, done to death by his miserable guilty Deianira of a wife, and lastly the never-to-be-forgotten sacrifice of Hasan's brother, the heroic Hosain, on the bloody field of Kerbela (A.D. 680). With the establishment in Persia, early in the 16th century, of the Safawid (Sufi) dynasty by the Shi'ites, the cult of the martyrs Hasan and Hosain secured the official sanction which it has since retained. Thus the performance of these *taziés*, and the defraying of the equipment of them, are regarded as religious, and in a theological sense meritorious, acts; and the plays are frequently provided by the court or by other wealthy persons, by way of pleasing the people or securing divine favour. The plays are performed, usually by natives of Isfahan, in courtyards of mosques, palaces, inns, &c., and in the country in temporary structures erected for the purpose.

It would seem that, no farther back than the beginning of the 10th century, the *taziés* were still only songs or elegies in honour of the martyrs, occasionally chanted by persons actually representing them. Just, however, as Greek tragedy was formed by a gradual detachment of the dialogue from the choric song of which it was originally only a secondary outgrowth, and by its gradually becoming the substance of the drama, so the *Miracle Play of Hasan and Hosain*, as we may call it, has now come to be a continuous succession of dramatic scenes. Of these fifty-two have, thanks to the labours of Alexander Chodzko and Sir Lewis Pelly, been actually taken down in writing, and thirty-seven published in translations; and it is clear that there is no limit to the extension of the treatment, as is shown by such a *tazié* as the *Marriage of Kassem*, dealing with the unfortunate Hosain's unfortunate son.¹ The performance is usually opened by a prologue delivered by the *rouzékhán*, a personage of semi-priestly character claiming descent from the Prophet, who edifies and excites the audience by a pathetic recitation of legends and vehement admonitions in prose or verse concerning the subject of the action. But the custom seems to have arisen of specially prefacing the drama proper by a kind of induction which illustrates the cause or effect of the sacred story—as for instance that of Amir Timur (Tamerlane), who appears as lamenting and avenging the death of Hosain; or the episode of Joseph's betrayal by his brethren, as prefiguring the cruelty shown to Ali and his sons. At the climax of the action proper Hosain prays to be granted at the day of judgment the key of the treasure of intercession; and the final scene shows the fulfilment of his prayer, which opens paradise to those who have helped the holy martyr, or who have so much as shed a single tear for him. It will thus be seen that not only is this complex and elaborate production unapproached in its length and in its patient development of a long sequence of momentous events by any chronicle history or religious drama, but that it embodies together with the passionately cherished traditions of a great religious community the expression of a long-lived resentment of foreign invasion—and is thus a kind of Oberammergau play and complaint of the Nibelungs in one.

¹ Translated by Comte de Gobineau, in his *Religions et philosophies dans l'Asie centrale* (Paris, 1865).

The other kind of Persian drama is the *témacha* (=spectacle), a kind of comedy or farce, sometimes called *teglid* (disguising), performed by wandering minstrels or *joculatores* called *louyts*, who travel about accompanied by their *baya-dères*, and amuse such spectators as they find by their improvised entertainments, which seem to be on much the same level as English "interludes." A favourite and ancient variety of the species is the *karaguez* or puppet-play, of which the protagonist is called *kétschel péshévan* (the bald hero).

The modern Persian drama seems to have admitted Western influences, as in the case of such comedies as *The Pleaders of the Court*, and, avowedly, *Monsieur Jourdan* and *Musadli's Shah*, of whom the former steals away the wits of young Persia by his pictures of the delights of Paris.

There is no necessity for any reference here to the civilization or to the literature of the Hebrews, or to those of other Semitic peoples, with whom the drama is either entirely wanting, or only appears as a quite occasional and exotic growth. Dramatic elements are apparent in two of the books of the Hebrew scripture—the *Book of Ruth* and the *Book of Job*, of which latter the author of *Everyman*, and Goethe in his *Faust*, made so impressive a use.

From Polynesia and aboriginal America we also have isolated traces of drama. Among these are the performances, accompanied by dancing and intermixed with recitation and singing, of the South Sea Islanders, first described by Captain Cook, and reintroduced to the notice of students of comparative mythology by W. Wyatt Gill. Of the so-called Inca drama of the Peruvians, the unique relic, *Apu Ollantay*, said to have been written down in the Quichua tongue from native dictation by Spanish priests shortly after the conquest of Peru, has been partly translated by Sir Clements Markham, and has been rendered into German verse. It appears to be an historic play of the heroic type, combining stirring incidents with a pathos finding expression in at least one lyric of some sweetness—the lament of the lost Collyar. With it may be contrasted the ferocious Aztec dramatic ballet, *Rabinal-Achi* (translated by Brasseur de Bourbourg), of which the text seems rather a succession of warlike harangues than an attempt at dramatic treatment of character. But these are mere isolated curiosities.

6. DRAMATIC ELEMENTS IN EGYPTIAN CULTURE

The civilization and religious ideas of the Egyptians so vitally influenced the people of whose drama we are about to speak that a reference to them cannot be altogether omitted. The influence of Egyptian upon Greek civilization has probably been over-estimated by Herodotus; but while it will never be clearly known how much the Greeks owed to the Egyptians in divers branches of knowledge, it is certain that the former confessed themselves the scholars of Egypt in the cardinal doctrine of its natural theology. The doctrine of the immortality of the soul there found its most solemn expression in mysterious recitations connected with the rites of sepulture, and treating of the migration of the soul from its earthly to its eternal abode. These solemnities, whose transition into the Hellenic mysteries has usually been attributed to the agency of the Thracian worship of Dionysus, undoubtedly contained a dramatic element, upon the extent of which it is, however, useless to speculate. The ideas to which they sought to give utterance centred in that of Osiris, the vivifying power or universal soul of nature, whom Herodotus simply identifies with the Dionysus of the Greeks. The same deity was likewise honoured by processions among the rural Egyptian population, which, according to the same authority, in nearly all respects except the absence of choruses resembled the Greek phallic processions in honour of the wine-god.

That the Egyptians looked upon music as an important science seems fully established; it was diligently studied by their priests, though not, as among the Greeks, forming a part of general education, and in the sacred rites of their gods they as a rule permitted the use of flute and harp, as well as of vocal music. Dancing was as an art confined to professional persons; but though the higher orders abstained from its practice, the lower indulged

in it on festive occasions, when a tendency to pantomime naturally asserted itself, and licence and wanton buffoonery prevailed, as in the early rustic festivals of the Greek and Italian peoples. Of a dance of armed men, on the other hand, there seems no satisfactory trace in the representations of the Egyptian monuments.

7. GREEK DRAMA.

Whatever elements the Greek drama may, in the sources from which it sprang, have owed to Egyptian, or Phrygian, or other Asiatic influences, its development was independent and self-sustained. Not only in its beginnings, but so long as the stage existed in Greece, the drama was in intimate connexion with the national religion. This is the most signal feature of its history, and one which cannot in the same degree or to the same extent be ascribed to the drama of any other people, ancient or modern. Not only did both the great branches of the Greek drama alike originate in the usages of religious worship, but they never lost their formal union with it, though one of them (comedy) in its later growth abandoned all direct reference to its origin. Hellenic polytheism was at once so active and so fluid or flexible in its anthropomorphic formations, that no other religious system has ever with the same conquering force assimilated to itself foreign elements, or with equal vivacity and variety developed its own. Thus, the worship of Dionysus, introduced into Greece by the Phœnicians as that of the tauriform sun-god whom his worshippers adored with loud cries (whence *Bacchus* or *Iacchus*), and the god of generation (whence his *phallic* emblem) and production, was brought into connexion with the Dorian religion of the sun-god Apollo. Apollo and his sister, again, corresponded to the Pelasgian and Achæan divinities of sun and moon, whom the Phœnician Dionysus and Demeter superseded, or with whose worship theirs was blended. Dionysus, whose rites were specifically conducted with reference to his attributes as the wine-god, was attended by deified representations of his original worshippers, who wore the skin of the goat sacrificed to him. These were the *satyrs*. Out of the connected worships of Dionysus, Bacchus, Apollo and Demeter sprang the beginnings of the Greek drama.

"Both tragedy and comedy," says Aristotle, "originated in a rude and unpremeditated manner—the first from the leaders of the dithyramb, and the second from those who led off the phallic songs." This diversity of origin, and the distinction jealously maintained down to the latest times between the two branches of the dramatic art, even where they might seem to come into actual contact with one another, necessitate a separate statement as to the origin and history of either.

The custom of offering thanks to the gods by hymns and dances in the places of public resort was first practised by the Greeks in the Dorian states, whose whole system of life was organized on a military basis. Hence the dances of the Dorians originally taught or imitated the movements of soldiers, and their hymns were warlike chants. Such were the beginnings of the *chorus*, and of its songs (called *psalms*, from an epithet of Apollo), accompanied first by the phorminx and then by the flute. A step in advance was taken when the poet with his trained singers and dancers, like the Indian *sûtra-dhara*, performed these religious functions as the representative of the population. From the Doric *psæan* at a very early period several styles of choral dancing formed themselves, to which the three styles of dance in scenic productions—the tragic, the comic and the satyric—are stated afterwards to have corresponded. But none of these could have led to a literary growth. This was due to the introduction among the Dorians of the *dithyramb* (from *diôs*, descended from Zeus, and *θρηνησις*, the Latin *triumphus*), originally a song of revellers, probably led by a flute-player and accompanied by the music of other Eastern instruments, in which it was customary in Crete to celebrate the birth of Bacchus (the doubly-born) and possibly also his later adventures. The leader of the band (*coryphæus*) may be supposed to have at times assumed the character of the wine-god, whose worshippers

bore aloft the vine-clad *thyrsus*. The dithyramb was reduced to a definite form by the Lesbian Arion (fl. 610), who composed regular poems, turned the moving band of worshippers into a standing or "cyclic" chorus of attendants on Dionysus—a chorus of satyrs, a tragic or goat chorus—invented a style of music adapted to the character of the chorus, and called these songs "tragedies" or "goat-songs." Arion, whose goat-chorus may perhaps have some connexion with an early Arcadian worship of Pan, associated it permanently with Dionysus, and thus became the inventor of "lyrical tragedy"—a transition stage between the dithyramb and the regular drama. His invention, or the chorus with which it dealt, was established according to fixed rules by his contemporary Stesichorus. About the time when Arion introduced these improvements into the Dorian city of Corinth, the (likewise Dorian) families at Sicily honoured the hero-king Adrastus by tragic choruses. Hence the invention of tragedy was ascribed by the Sicyonians to their poet Epigenes; but this step, significant for the future history of the Greek drama, of employing the Bacchic chorus for the celebration of other than Bacchic themes, was soon annulled by the tyrant Cleisthenes.

The element which transformed lyrical tragedy into the tragic drama was added by the Ionians. The custom of the recitation of poetry by wandering minstrels, called *rhapsodes* (from *ῥάβδος*, staff, or from *ῥάπτω*, to piece together), first sprang up in the Ionia beyond the sea; to such minstrelsy was due the spread of the Homeric poems and of subsequent epic cycles. These recitations, with or without musical accompaniment, soon included gnomic or didactic, as well as epic, verse; if Homer was a rhapsode, so was the sententious or "moral" Hesiod. The popular effect of these recitations was enormously increased by the metrical innovations of Archilochus (from 708), who invented the trochee and the *iambus*, the latter the arrowy metre which is the native form of satirical invective—the species of composition in which Archilochus excelled—though it was soon used for other purposes also. The recitation of these iambs may already have nearly approached to theatrical declamation. The rhapsodes were welcome guests at popular festivals, where they exercised their art in mutual emulation, or ultimately recited parts, perhaps the whole, of longer poems. The recitation of a long epic may thus have resembled theatrical dialogue; even more so must the alternation of iambic poems, the form being frequently an address in the second person. The rhapsode was in some sense an actor; and when these recitations reached Attica, they thus brought with them the germs of theatrical dialogue.

The rhapsodes were actually introduced into Attica at a very early period; the *Iliad*, we know, was chanted at the Brauronia, a rural festival of Bacchus, whose worship had early entered Attica, and was cherished among its rustic population. Meanwhile the cyclic chorus of the Dorians had found its way into Attica and Athens, ever since the Athenians had recognized the authority of the great centre of the Apolline religion at Delphi. From the second half of the 6th century onwards the chorus of satyrs formed a leading feature of the great festival of Dionysus at Athens. It therefore only remained for the rhapsodic and the cyclic—in other words, for the epic and the choral—elements to coalesce; and this must have been brought about by a union of the two accompaniments of religious worship in the festive rites of Bacchus, and by the domestication of these rites in the ruling city. This occurred in the time of Peisistratus, perhaps after his restoration in 554. To Thespis (534), said to have been a contemporary of the tyrant and a native of an Attic deme (Icaria), the invention of tragedy is accordingly ascribed. Whether his name be that of an actual person or not, his claim to be regarded as the inventor of tragedy is founded on the statement that he introduced an actor (*ὑποκριτής*, originally, "answerer"), doubtless, at first, generally the poet himself, who, instead of merely alternating his recitations with the songs of the chorus, addressed his speech to its leader—the *coryphæus*—with whom he thus carried on a

Religious origin.

Lyrical tragedy.

The rhapsodes.

Invention of the tragic drama.

The dithyramb.

species of "dialogue." Or, in other words, the leader of the chorus (*coryphaeus*), instead of addressing himself to the chorus, held converse with the actor. The chorus stood round its leader in front of the Bacchic altar (*thymelæ*); the actor stood with the *coryphaeus*, who had occupied a more elevated position in order to be visible above his fellows, on a rude table, or possibly on a cart, though the wagon of Thespis may be a fiction, due to a confusion between his table and the wagon of Susarion. In any case, we have here, with the beginnings of dialogue, the beginning of the stage. It is a significant minor invention ascribed to Thespis, that he disguised the actor's face first by means of a pigment, afterwards by a mask. In the dialogue was treated some myth relating to Bacchus, or to some other deity or hero. Whether or not Thespis actually wrote tragedies (and there seems no reason to doubt it), Phrynichus and one or two other poets are mentioned as having carried on choral tragedy as set on foot by him, and as having introduced improvements into its still predominating lyrical element. The step which made dramatic action possible, and with which the Greek drama thus really began, was, as is distinctly stated by Aristotle, taken by Aeschylus. He added a second actor; and, by reducing the functions of the chorus, he further established the dialogue as the principal part of tragedy. Sophocles afterwards added a third actor, by which change the preponderance of the dialogue was made complete.

If the origin of Greek comedy is simpler in its nature than that of Greek tragedy, the beginnings of its progress are involved in more obscurity. Its association with religious worship was not initial; its foundations lay in popular mirth, though religious festivals, and those of the vintage god in particular, must from the first have been the most obvious occasions for its exhibition. It is said to have been "invented" by Susarion, a native of Doric Megaris, whose inhabitants were famed for their coarse humour, which they communicated to their own and other Dorian colonies in Sicily, to this day the home of vivacious mimic dialogue. In the rural Bacchic vintage festivals bands of jolly companions (*kômpos*, properly a revel continued after supper) went about in carts or afoot, carrying the phallic emblem, and indulging in the ribald licence of wanton mirth. From the song sung in these processions or at the Bacchic feasts, which combined the praise of the god with gross personal ridicule, and was called *comus* in a secondary sense, the Bacchic reveller taking part in it was called a *comus-singer* or *comedus*. These phallic processions, which were afterwards held in most Greek cities, and in Athens seem to have early included a "topical" speech as well as a choral song, determined the character of Old Attic comedy, whose most prominent feature was an absolute licence of personal vilification.

Thus independent of one another in their origin, Greek tragedy and comedy never actually coalesced. The "satyr-drama," though in some sense it partook of the nature of both, was in its origin as in its history connected with tragedy alone, whose origin it directly recalled. Pratinas of Phlius, a contemporary of Aeschylus in his earlier days, is said to have restored the tragic chorus to the satyrs; *i. e.* he first produced dramas in which, though they were the same in form and theme as the tragedies, the choric dances were different and entirely carried on by satyrs. The tragic poets, while never writing comedies, henceforth also composed satyr-dramas; but neither tragedies nor satyr-dramas were ever written by the comic poets, and it was in conjunction with tragedies only that the satyr-dramas were performed. The theory of the Platonic Socrates, that the same man ought to be the best tragic and the best comic poet, was among the Greeks never exemplified in practice. The so-called "hilaro-tragedy" or "tragi-comedy" of later writers, perhaps in some of its features in a measure anticipated by Euripides,¹ in form nowise differed from tragedy; it merely contained a comic element in its characters, and invariably had a happy ending. It is an instructive fact that the serious and sentimental element in the comedy of Menander and his con-

temporaries did far more to destroy the essential difference between the two great branches of the Greek dramatic art.

Periods of Greek Tragedy.—The history of Greek—which to all intents and purposes remained Attic—tragedy divides itself into three periods.

I. *The Period before Aeschylus* (535-490).—From this we have but a few names of authors and plays—those of the former being (besides Thespis) Choerilus, Phrynichus and Pratinas, all of whom lived to contend with Aeschylus for the tragic prize. To each of them certain innovations are ascribed—for instance the introduction of female characters to Phrynichus. He is best remembered by the overpowering effect said to have been created by his *Capture of Miletus*, in which the chorus consisted of the wives of the Phœnician sailors in the service of the Great King.

II. *The Classical Period of Attic Tragedy*—that of Aeschylus, Sophocles and Euripides, and their contemporaries (490-405). To this belong all the really important phases in the progress of Greek tragedy, which severally connect themselves with the names of its three great masters. They may be regarded as the representatives of successive generations of Attic history and life, though of course in these, as in the progress of their art itself, there is an unbroken continuity.

Aeschylus (525-456) had not only fought both at Marathon and at Salamis against those Persians whose rout he celebrated with patriotic pride,² but he had been trained in the *Aeschylus*. Eleusinian mysteries, and strenuously asserted the value of the institution most intimately associated with the primitive political traditions of the past—the Aropeagus.³ He had been born in the generation after Solon, to whose maxims he fondly clung; and it was the Dorian development of Hellenic life and the philosophical system based upon it with which his religious and moral convictions were imbued. Thus even upon the generation which succeeded him, and to which the powerful simplicity of his dramatic and poetic diction seemed strange, the ethical loftiness of his conceptions and the sublimity of his dramatic imagination fell like the note of a mightier age. To us nothing is more striking than the conciliatory tendencies of his conservative mind, and the progressive nature of what may have seemed to his later contemporaries antiquated ideals.

Sophocles (495-405) was the associate of Pericles, and an upholder of his authority, rather than a consistent pupil of his political principles; but his manhood, and perhaps *Sophocles*. the maturity of his genius, coincided with the great days when he could stand, like his mighty friend and the community they both so gloriously represented, on the sunny heights of achievement. Serenely pious as well as nobly patriotic, he nevertheless treats the myths of the national religion in the spirit of a conscious artist, contrasting with lofty irony the struggles of humanity with the irresistible march of its destinies. Perhaps he, too, was one of the initiated; and the note of personal responsibility which is the mystic's inner religion is recognizable in his view of life.⁴ The art of Sophocles may in its perfection be said to typify the greatest epoch in the life of Athens—an epoch conscious of unequalled achievements, but neither wholly unconscious of the brief endurance which was its destiny.

Euripides (480-406), as is the fate of genius of a more complex kind, has been more variously and antithetically judged than either of his great fellow-tragedians. His art has *Euripides*. been described as devoid of the idealism of theirs, his genius as rhetorical rather than poetical, his morality as that of a sophistical wit. On the other hand, he has been recognized not only as the most tragic of the Attic tragedians and the most pathetic of ancient poets, but also as the most humane in his social philosophy and the most various in his psychological insight. At least, though far removed from the more naïf age of the national life, he is, both in patriotic spirit and in his choice of themes, genuinely Attic; and if he was "haunted on the stage by the daemon of Socrates," he was, like Socrates himself, the representative of an age which was a seed-time as well as a season of decay. His technical innovations

¹ *Alcestis; Orestes.*

² *Persææ.*

³ *Eumenides.*

⁴ *Antigone; Oedipus Rex.*

corresponded to his literary characteristics; but neither in the treatment of the chorus, nor in his management of the beginning and the ending of a tragedy, did he introduce any radical change. To Euripides the general progress of dramatic literature nevertheless owes more than to any other ancient poet. Tragedy followed in his footsteps in Greece and at Rome. Comedy owed him something in the later phases of the very Aristophanes who mocked him, and more in the human philosophy expressed in the sentiments of Menander; and, when the modern drama came to engraft the ancient upon its own crude growth, his was directly or indirectly the most powerful influence in the establishment of a living connexion between them.

The incontestable pre-eminence of the three great tragic poets was in course of time acknowledged at Athens by the usage allowing no tragedies but theirs to be performed more than once, and by the prescription that one play of theirs should be performed at each Dionysia, as well as by the law of Lycurgus (c. 330) which obliged the actors to use, in the case of works of the great masters, authentic copies preserved in the public archives. Yet it is possible that the exclusiveness of these tributes is not entirely justifiable; and not all the tragic poets contemporary with the great writers were among the myriad of younglings derided by Aristophanes. Of those who attained to celebrity Ion of Chios (d. before 410) seems to have followed earlier traditions of style than Euripides; Agathon, who survived the latter, on the other hand, introduced certain innovations of a transnormal kind both into the substance and the form of dramatic composition.¹

III. Of the third period of Greek tragedy the concluding limit cannot be precisely fixed. Down to the days of Alexander the Great, Athens had remained the chief home of tragedy. Though tragedies must have begun to be acted at the Syracusan and Macedonian courts, since Aeschylus, Euripides and Agathon had sojourned there—though the practice of producing plays at their Dionysia before the allies of Athens must have led to their holding similar exhibitions at home—yet before the death of Alexander we meet with no instance of a tragic poet writing or of a tragedy written outside Athens. An exception should indeed be made in favour of the tyrant Dionysius of Syracuse, who (like Critias in his earlier days at Athens) was "addicted to" tragic composition. Not all the tragedians of this period, however, were Athenians born; though the names of Euphorion, the son of Aeschylus, Iophon, the son of Sophocles, and Euripides and Sophocles, the nephew and the grandson respectively of their great namesakes, illustrate the descent of the tragic art as an hereditary family possession. Chæremon (fl. 380) already exhibits tragedy on the road to certain decay, for we learn that his plays were written for reading.

Soon after the death of Alexander theatres are found spread over the whole Hellenic world of Europe and Asia—a result to which the practice of the conqueror and his father of celebrating their victories by scenic performances had doubtless contributed. Alexandria having now become a literary centre with which even Athens was in some respects unable to compete, while the latter still remained the home of comedy, the tragic poets flocked to the capital of the Ptolemies; and here, in the canon of Greek poets drawn up by command of Ptolemy Philadelphus (283–247), Alexander the Aetolian undertook the list of tragedies, while Lycophron was charged with the comedies. But Lycophron himself was included in all the versions of the list of the seven tragic poets famed as the "Pleias" who still wrote in the style of the Attic masters and followed the rules observed by them. Tragedy and the dramatic art continued to be favoured by the later Ptolemies; and about 100 B.C. we meet with the curious phenomenon of a Jewish poet, Ezechiel, composing Greek tragedies, of one of which (the *Exodus* from Egypt) fragments have come down to us. Tragedy, with the satyr-drama and comedy, survived in Alexandria beyond the days of Cicero and

¹ *Anthos*.

Varro; nor was their doom finally sealed till the emperor Caracalla abolished theatrical performances in the Egyptian capital in A.D. 217.

Thus Greek tragedy is virtually only another name for Attic; nor was any departure from the lines laid down by its three great masters made in most respects by the Roman imitators of these poets and of their successors.

Tragedy was defined by Plato as an imitation of the noblest life. Its proper themes—the deeds and sufferings of heroes—were familiar to audiences intimately acquainted with the mythology of the national religion. To such themes Greek tragedy almost wholly confined itself; and in later days there were numerous books which only discussed these myths of the tragedians. They only very exceptionally treated historic themes, though one great national calamity,² and a yet greater national victory,³ and in later times a few other historical subjects,⁴ were brought upon the stage. Such veiled historical allusions as critical ingenuity has sought not only in passages but in the entire themes of other Attic tragedies⁵ cannot, of course, even if accepted as such, stamp the plays in which they occur as historic dramas. No doubt Attic tragedy, though after a different and more decorous fashion, shared the tendency of her comic sister to introduce allusions to contemporary events and persons; and the indulgence of this tendency was facilitated by the revision (*ἰσακμή*) to which the works of the great poets were subjected by them, or by those who produced their works after them.⁶ So far as we know, the subjects of the tragedies before Aeschylus were derived from the epics; and it was a famous saying of this poet that his dramas were "but dry scraps from the great banquets of Homer"—an expression which may be understood as including the poems which belong to the so-called Homeric cycles. Sophocles, Euripides and their successors likewise resorted to the Trojan, and also to the Heracleian and the Thesean myths, and to Attic legend in general, as well as to Theban, to which already Aeschylus had had recourse, and to the side or subsidiary myths connected with these several groups. These substantially remained to the last the themes of Greek tragedy, the Trojan myths always retaining so prominent a place that Lucian could jest on the universality of their dominion. Purely invented subjects were occasionally treated by the later tragedians; of this innovation Agathon was the originator.⁷

Thespis is said to have introduced the use of a "prologue" and a "rhesis" (speech)—the former being probably the opening speech recited by the *coryphæus*, the latter the dialogue between him and the actor. It was a natural result of the introduction of the second actor that a second *rhesis* should likewise be added; and this tripartite division would be the earliest form of the *trilogy*,—three sections of the same myth forming the beginning, middle and end of a single drama, marked off from one another by the choral songs. From this Aeschylus proceeded to the treatment of these several portions of a myth in three separate plays, connected together by their subject and by being performed in sequence on a single occasion. This is the *Aeschylean trilogy*, of which we have only one extant example, the *Oresteia*—as to which critics may differ whether Aeschylus adhered in it to his principle that the strength should

¹ Phrynichus, *Capture of Miletus*.

² Id., *Phoenissæ*; Aeschylus, *Persæ* (*Persæ-trilogy*?).

³ Moschion, *Themistocles*; Theodectes, *Mausolus*; Lycophron, *Marathonis*; Cassandreis; Sotici; Philiiscus, *Themistocles*.

⁴ Aeschylus, *Septem c. Thebas*; *Prometheus Vinculus*; *Danaë-trilogy*; Sophocles, *Antigone*; *Oedipus Colonus*; Euripides, *Medea*.

⁵ Quite distinct from this revision was the practice against which the law of Lycurgus was directed, of "cobbling and beeling" the dramas of the great masters by alterations of a kind familiar enough to the students of Shakespeare as improved by Colley Cibber and other experts. The later tragedians also appear to have occasionally transposed long speeches or episodes from one tragedy into another—a device largely followed by the Roman dramatists, and called *contamination* by Latin writers.

⁶ *Anthos* (*The Flower*).

The great tragic masters and their contemporaries.

The successors of the great masters at Athens.

The Alexandrians.

The tragedy of the great masters.

Subjects of Greek tragedy.

Construction.

The Aeschylean trilogy.

lie in the middle—in other words, that the interest should centre in the second play. In any case, the symmetry of the trilogy

was destroyed by the practice of performing after it a satyr-drama, probably as a rule, if not always, connected in subject with the trilogy, which thus became

a tetralogy, though this term, unlike the other, seems to be a purely technical expression invented by the learned.¹ Sophocles, a more conscious and probably a more self-critical artist than Aeschylus, may be assumed from the first to have elaborated his tragedies with greater care; and to this, as well as to his innovation of the third actor, which materially added to the fullness of the action, we may attribute his introduction of the custom of contending for the prize with single plays. It does not follow that he never produced connected trilogies, though we have no example of such by him or any later author; on the other hand, there is no proof that either he or any of his successors ever departed from the Aeschylean rule of producing three tragedies, followed by a satyr-drama, on the same day. This remained the third and last stage in the history of the construction of Attic tragedy. The tendency of its action towards complication was a natural progress, and is emphatically approved by Aristotle. This complication, in which Euripides excelled, led to his use of prologues, in which one of the characters opens the play by an exposition of the circumstances under which its action begins. This practice, though ridiculed by Aristophanes, was too convenient not to be adopted by the successors of Euripides, and Menander transferred it to comedy. As the dialogue increased in importance, so the dramatic significance of the chorus diminished. While in Aeschylus it mostly, and in Sophocles occasionally, takes part in the action, its songs could not but more and more approach the character of lyrical *intermezzos*; and this they openly assumed when Agathon began the practice of inserting choral songs (*embolima*) which had nothing to do with the action of the play. In the general contrivance of their actions it was only natural that, as compared with Aeschylus, Sophocles and Euripides should exhibit an advance in both freedom and ingenuity; but the palm, due to a treatment at once piously adhering to the substance of the ancient legends and original in an effective dramatic treatment of them, must be given to Sophocles. Euripides was, moreover, less skilful in untying complicated actions than in weaving them; hence his frequent resort² to the expedient of the *deus ex machina*, which Sophocles employs only in his latest play.³

The other distinctions to be drawn between the dramatic qualities of the three great tragic masters must be mainly based upon a critical estimate of the individual genius of each. In the characters of their tragedies, Aeschylus and Sophocles avoided those lapses of dignity with which from one point of view Euripides has been charged by Aristophanes and other critics, but which, from another, connect themselves with his humanity. If his men and women are less heroic and statuesque, they are more like men and women. Aristotle objected to the later tragedians that, compared with the great masters, they were deficient in the drawing of character—by which he meant the lofty drawing of lofty character. In

diction, the transition is even more manifest from the "helmeted phrases" of Aeschylus, who had Milton's love of long words and sonorous proper names, to the play of Euripides "smooth and diligent tongue"; but to a sustained style even he remained essentially true, and it was reserved for his successors to introduce into tragedy the "low speech"—i.e. the conversational language—of comedy. Upon the whole, however, the Euripidean diction seems to have remained the standard of later tragedy, the flowery style of speech introduced by Agathon finding no permanent favour.

¹ One satyr-drama only is preserved to us, the *Cyclops* of Euripides, a dramatic version of the Homeric tale of the visit of Odysseus to Polyphemus. Lycophron, by using the satyr-drama (in his *Meneides*) as a vehicle of personal ridicule applied it to a purpose resembling that of Old Attic Comedy.

² *Ion*; *Supplices*; *Iphigenia in Tauris*; *Electra*; *Helena*; *Hippolytus*; *Andromache*.

³ *Philoctetes*.

Finally, Aeschylus is said to have made certain reforms in tragic costume of which the object is self-evident—to have improved the mask, and to have invented the *colturnus* or buskin, upon which the actor was raised to loftier stature. Euripides was not afraid of rags and tatters; but the sarcasms of Aristophanes on this head seem feeble to those who are aware that they would apply to *King Lear* as well as to *Telemachus*.

Periods of Greek Comedy.—The history of Greek comedy is likewise that of an essentially Attic growth, although Sicilian comedy was earlier in date than her Attic sister or descendant. The former is represented by Epicharmus (fl. 500), and by the names of one or two other poets. It probably had a chorus, and, dealing as it did in a mixture of philosophical discourse, anti-theatrical rhetoric and wild buffoonery, necessarily varied in style. His comedies were the earliest examples of the class distinguished as *motoriae* from the *statariae* and the *mixtae* by their greater freedom and turbulence of movement. Though in some respects Sicilian comedy seems to have resembled the Middle rather than the Old Attic comedy, its subjects sometimes, like those of the latter, coincided with the myths of tragedy, of which they were doubtless parodies. The so-called "mimes" of Sophron (fl. 430) were dramatic scenes from Sicilian everyday life, intended, not for the stage, but for recitation, and classed as "male" and "female" according to the sex of the characters.

Attic comedy is usually divided into three periods or species. I. *Old comedy*, which dated from the complete establishment of democracy by Pericles, though a comedy directed against Themistocles is mentioned. The Megarean farcical entertainments had long spread in the rural districts of Attica, and were now introduced into the city, where

from about 460 onwards the "comus" became a matter of public concern. Cratinus (c. 450-422) and Crates (c. 440-425) first moulded these beginnings into the forms of Attic art. The final victory of Pericles and the democratic party may be reckoned from the ostracism of Thucydides (444); and so eagerly was the season of freedom employed by the comic poets that already four years afterwards a law—which, however, remained only a short time in force—limited their licence. Cratinus, an exceedingly bold and broad satirist, apparently of conservative tendencies, was followed by Eupolis (446-after 415), every one of whose plays appears to have attacked some individual,⁴ by Phrynichus, Plato and others; but the representative of old comedy in its fullest development is Aristophanes (c. 444-c. 380), a comic poet of unique and unsurpassed genius. Dignified by the acquisition of a chorus (more numerous—twenty-four to twelve or afterwards fifteen—though of a less costly kind than the tragic) of masked actors, and of scenery and machinery, as well as by a corresponding literary elaboration and elegance of style, Old Attic comedy nevertheless remained true both to its origin and to the purposes of its introduction into the free imperial city. Its special season was at the festival of the Lenaea, when the Athenians could enjoy the fun against one another without spying strangers; but it was also performed at the Great Dionysia. It borrowed much from tragedy, but it retained the phallic abandonment of the old rural festivals, the licence of word and gesture, and the audacious directness of personal invective. These characteristics are not features peculiar to Aristophanes. He was twitted by some of the older comic poets with having degenerated from the full freedom of the art by a tendency to refinement, and he took credit to himself for having superseded the time-honoured *canon* and the stale practical joking of his predecessors by a nobler kind of mirth. But in daring, as he likewise boasted, he had no peer; and the shafts of his wit, though dipped in wine-les and at times feathered from very obscene fowl, flew in high game.⁵ He has been accused of seeking to degrade what he ought to have recognized as good; and it has been shown with complete success that he is not to be taken as an impartial or accurate

⁴ *Archilochi*; *Pythine* (*The Bottle*).

⁵ *Marcus* (Cleon); *Baptoe* (Alcibiades); *Lacomes* (Cimon)

⁶ *Knights*.

⁷ *Clouds*.

Improvements in costume, etc.

The Old comedy.

Aristophanes.

authority on Athenian history. But partisan as he was, he was also a genuine patriot; and his very political sympathies—which were conservative, like those of the comic poets in general, not only because it was the old families upon whom the expense of the *choregia* in the main devolved—were such as have often stimulated the most effective political satire. Of the conservative quality of reverence he was, however, altogether devoid; and his love for Athens was that of the most free-spoken of sons. Flexible even in his religious notions, he was, in this as in other respects, ready to be educated by his times; and, like a true comic poet, he could be witty at the expense even of his friends, and, it might almost be said, of himself. In wealth of fancy¹ and in beauty of lyric melody, he has few peers among the great poets of all times.

The distinctive feature of Old, as compared with Middle comedy, is the *parabasis*, the speech in which the chorus, moving towards and facing the audience, addressed it in the name of the poet, often abandoning all reference to the action of the play. The loss of the *parabasis* was involved in the loss of the chorus, of which comedy was deprived in consequence of the general reduction of expenditure upon the comic drama, culminating in the law of the personally aggrieved dithyrambic poet Cinesias (396).² But with the downfall of the independence of Athenian public life, the ground had been cut from under the feet of its most characteristic representative. Already in 414, in the anxious time after the sailing of the Sicilian expedition, the law of Syracuse had prohibited the comic poets from making direct reference to current events; but the *Birds* had taken their flight above the range of all regulations. The catastrophe of the city (405) was preceded by the temporary overthrow of the democracy (411), and was followed by the establishment of an oligarchical "tyranny" under Spartan protection; and, when liberty was restored (404), the citizens for a time addressed themselves to their new life in a soberer spirit, and continued (or passed) the law prohibiting the introduction by name of any individual as one of the personages of a play. The change to which comedy had to accommodate itself was one which cannot be defined by precise dates, yet it was not the less inevitable in its progress and results. Comedy, in her struggle for existence, now chiefly devoted herself to literary and social themes, such as the criticism of tragic poets,³ and the literary craze of women's rights,⁴ and the transition to Middle comedy accomplished itself. Of the later plays of Aristophanes, three⁵ are without a *parabasis*, and in the last of those preserved to us which properly belongs to Middle comedy⁶ the chorus is quite insignificant.

II. *Middle comedy*, whose period extends over the remaining years of Athenian freedom (from about 400 to 338), thus differed in substance as well as in form from its predecessor. It is represented by the names of thirty-seven writers (more than double the number of poets attributed to Old comedy), among whom Eubulus, Antiphanes and Alexis are stated to have been pre-eminently fertile and successful. It was a comedy of manners as well as character, although its ridicule of particular classes of men tended to the creation of standing types, such as soldiers, parasites, courtesans, revellers, and—a favourite figure already drawn by Aristophanes⁷—the self-conceited cook. In style it necessarily inclined to become more easy and conversational and to substitute insinuation for invective; while in that branch which was devoted to the parodying of tragic myths its purpose may have been to criticize, but its effect must have been to degrade. This species of the comic art had found favour at Athens already before the close of the great civil war; its inventor was the Thasian Hegemon, whose *Gigantomachia* was amusing the Athenians on the day when the news arrived of the Sicilian disaster.

III. *New comedy*, which is dated from the establishment of the Macedonian supremacy (338), is merely a further development of Middle, from which indeed it was not distinguished till the time of Hadrian. If its favourite types were more numerous, including the captain (of mercenaries) —the original of a long line of comic favourites—the cunning slave, &c., they were probably also more conventional. New comedy appears to have first constituted love intrigues the main subject of dramatic actions. The most famous of the sixty-four writers said to have belonged to this period of comedy were Philemon (fl. from 350), Menander (342–329) and his contemporary Diphilus. Of these authors we know something from fragments, but more from their Latin adapters Plautus and Terence. As comedians of character, they were limited by a range of types which left little room for originality of treatment; in the construction of their plots they were skillful rather than varied. In style, as well as to some extent in construction, Menander seems to have taken Euripides as his model, infusing into his comedy an element of moral and sentimental reflection, which refined if it did not enliven it.

New comedy, and with it Greek comedy proper, is regarded as having come to an end with Posidippus (fl. c. 280). Other comic writers of a later date are, however, mentioned, among them Rhinthon of Tarentum (fl. c. 300), whose mixed compositions have been called by various names, among them by that of "phylacographies" (from *phylax*, idle chatter). He was succeeded by Sopater, Sotades and others; but the dramatic element in these often obscene, but not perhaps altogether frivolous, travesties is not always clearly ascertainable. It is certain that Greek comedy gradually ceased to be productive; and though even in its original form it long continued to be acted in imperial Rome, these are phases of its history which may here be passed by.

The religious origin of the Attic drama impresses itself upon all its most peculiar features. Theatrical performances were held at Athens only at fixed seasons in the early part of the year—at the Bacchic festivals of the country Dionysia (vintage), the Lenaea (wine-press), probably at the Anthesteria, and above all, at the Great Dionysia, or the Dionysia *par excellence*, at the end of March and beginning of April, when in her most glorious age Athens was crowded with visitors from the islands and cities of her federal empire. As a part of religious worship, the performances took place in a sacred locality—the *Lenaecum* on the south-eastern declivity of the Acropolis, where the first wine-press (*lenos*) was said to have been set up, and where now an altar of Bacchus (*thymele*) formed the centre of the theatre. For the same reason the exhibitions claimed the attendance of the whole population, and room was therefore provided on a grand scale—according to the Platonic Socrates, for "more than 30,000" spectators (see THEATRE). The performances lasted all day, or were at least, in accordance with their festive character, extended to as great a length as possible. To their religious origin is likewise to be attributed the fact that they were treated as a matter of state concern. The expenses of the chorus, which in theory represented the people at large, were defrayed on behalf of the state by the *liturgies* (public services) of wealthy citizens, chosen in turn by the tribes to be *choragi* (leaders, i.e. providers of the chorus), the duty of training being, of course, deputed by them to professional persons (*chorodidascali*). Publicly appointed and sworn judges decided between the merits of the dramas produced in competition with one another; the successful poet, performers and choragus were crowned with ivy, and the last-named was allowed at his own expense to consecrate a tripod in memory of his victory in the neighbourhood of the sacred Bacchic enclosure. Such a monument—one of the most graceful relics of ancient Athens—still stands in the place where it was erected, and recalls to posterity the victory of Lysicrates, achieved in the same year as that of Alexander on the Granicus. The dramatic exhibitions being a matter of religion and state, the entrance money (*theoricum*), which had been introduced to

¹ *Birds*.

² *Strattis, The Choricids* (against Cinesias).

³ Aristophanes, *Frogs*; Phrynichus, *Musae*; *Tragœdi*.

⁴ Aristophanes, *Ecclesiasusae*.

⁵ *Lysistrata*; *Thesmophoriasusae*; *Plutus II*.

⁶ *Plutus*. ⁷ *Aeoliscum*.

The New comedy.

Philemon and Menander.

Decay of comedy.

Results of religious origin of Attic drama.

prevent overcrowding, was from the time of Pericles provided out of the public treasury. The whole population had a right to its Bacchic holiday; neither women, nor boys, nor slaves were excluded from theatrical spectacles at Athens.

The religious character of dramatic performances at Athens, and the circumstances under which they accordingly took place, likewise determined their externals of costume and scenery. The actor's dress was originally the festive Dionysian attire, of which it always retained the gay and variegated hues. The use of the mask, surmounted, high over the forehead, by an ample wig, was due to the actor's appearing in the open air and at a distance from most of the spectators; the several species of mask were elaborated with great care, and adapted to the different types of theatrical character. The *colturnus*, or thick-soled boot, which further raised the height of the tragic actor (while the comedian wore a thin-soled boot), was likewise a relic of Bacchic costume. The scenery was, in the simplicity of its original conception, suited to open-air performances; but in course of time the art of scene-painting came to be highly cultivated, and movable scenes were contrived, together with machinery of the ambitious kind required by the Attic drama, whether for bringing gods down from heaven, or for raising mortals aloft.

On a stage and among surroundings thus conventional, it might seem as if little scope could have been left for the actor's art. But, though the demands made upon the Attic actor differed in kind even from those made upon his Roman successor, and still more from those which the histrionic art has to meet in modern times, they were not the less rigorous. Mask and buskin might increase his stature, and the former might at once lend the appropriate expression to his appearance and the necessary resonance to his voice. But in declamation, dialogue and lyric passage, in gesticulation and movement, he had to avoid the least violation of the general harmony of the performance. Yet it is clear that the refinements of by-play must, from the nature of the case, have been impossible on the Attic stage; the gesticulation must have been broad and massive; the movement slow, and the grouping hard, in tragedy; and the weighty sameness of the recitation must have had an effect even more solemn and less varied than the half-chant which still lingers on the modern stage. Not more than three actors, as has been seen, appeared in any Attic tragedy. The actors were provided by the poet; perhaps the performer of the first parts (*protagonist*) was paid by the state. It was again a result of the religious origin of Attic dramatic performances and of the public importance attached to them, that the actor's profession was held in high esteem. These artists were as a matter of course free Athenian citizens, often the dramatists themselves, and at times were employed in other branches of the public service. In later days, when tragedy had migrated to Alexandria, and when theatrical entertainments had spread over all the Hellenic world, the art of acting seems to have reached an unprecedented height, and to have taken an extraordinary hold of the public mind. Synods, or companies, of Dionysian artists abounded, who were in possession of various privileges, and in one instance at least (at Pergamum) of rich endowments. The most important of these was the Ionic company, established first in Teos, and afterwards in Lebedos, near Colophon, which is said to have lasted longer than many a famous state. We likewise hear of strolling companies performing *in partibus*. Thus it came to pass that the vitality of some of the masterpieces of the Greek drama is without a parallel in theatrical history; while Greek actors were undoubtedly among the principal and most effective agents of the spread of literary culture through a great part of the known world.

The theory and technical system of the drama exercised the critical powers both of dramatists, such as Sophocles, and of the greatest among Greek philosophers. If Plato touched the subject incidentally, Aristotle has in his *Poetics* (after 334) included an exposition of it, which, mutilated as it is, has formed the basis of all later systematic inquiries. The specialities of Greek tragic dramaturgy refer above

all to the chorus; its general laws are those of the regular drama of all times. The theories of Aristotle and other earlier writers were elaborated by the Alexandrians, many of whom doubtless combined example with precept; they also devoted themselves to commentaries on the old masters, such as those in which Didymus (c. 30 B.C.) abundantly excelled, and collected a vast amount of learning on dramatic composition in general, which was doomed to perish, with so many other treasures, in the flames kindled by religious fanaticism.

8. ROMAN DRAMA

In its most productive age, as well as in the times of its decline and decay, the Roman drama exhibits the continued coexistence of native forms by the side of those imported from Greece—either kind being necessarily often subject to the influence of the other. Italy (with Sicily) has ever been the native land of acting and of scenic representation; and, though Roman dramatic literature at its height is but a faint reflex of Greek examples, there is perhaps no branch of Roman literary art more congenial than this to the soil whence it sprang.

Quick observation and apt improvisation have always been distinctive features in the Italian character. Thus in the rural festivities of Italy there developed from a very early period in lively intermixture the elements of the dance, of jocular and abusive succession of song, speech and dialogue, and of an assumption of character such as may be witnessed in any ordinary dialogue carried on by southern Italians at the present day. Not less indigenous was the invariable accompaniment of the music of the flute (*sibia*). The occasions of these half obligatory, half impromptu festivities were religious celebrations, public or private—among the latter more especially weddings, which have in all ages been provocative of demonstrative mirth. The so-called *Fescennine* verses (from Fescennium in southern Etruria, and very possibly connected with *fascinum* = phallos), which were afterwards confined to weddings, and ultimately suggested an elaborate species of artistic poetry, never merged into actual dramatic performances. In the *saturnae*, on the other hand—a name originally suggested by the goatskins of the shepherds, but from primitive times connected with the "fulness" of both performers and performance—there seems from the first to have been a dramatic element; they were probably comic songs or stories recited with gesticulation and the invariable flute accompaniment. Introduced into the city, these entertainments received a new impulse from the performances of the Etruscan players (*ludiones*) who had been brought into Rome when scenic games (*ludi scenici*) were introduced there in 364 B.C. for purposes of religious propitiation. These (*histriones*, as they were called at Rome (*istri* had been their native name), who have had the privilege of transmitting their appellation to the entire *histrionic* art and its professors, were at first only dancers and pantomimists in a city where their speech was exotic. But their performances encouraged and developed those of other players and mountebanks, so that after the establishment of the regular drama at Rome on the Greek model, the *saturnae* came to be performed as farcical after-pieces (*exodia*), until they gave way to other species. Among these the *mimus* were at Rome probably coeval in their beginnings with the *Atina* itself, where those who performed them were afterwards known under the same name, possibly in the place of an older appellation (*planipedes*, bare-footed, representatives of slaves and humble folk). These loose farces, after being probably at first performed independently, were then played as after-pieces, till in the imperial period, when they reasserted their predominance, they were again produced independently. At the close of the republican period the *mimus* found its way into literature, through D. Laberius, C. Matius and Publius Syrus, and was assimilated in both form and subjects to other varieties of the comic drama—preserving, however, as its distinctive feature, a preponderance of the mimic or gesticulatory element. Together with the *pantomimus* (see below) the *mimus* continued to prevail in the days of the Empire, having transferred its

Costume
and
scenery.

Actors.

Origin of
its native
forms.

Saturnae.

Histriones.

Atina.

original grossness to its treatment of mythological subjects, with which it dealt in accordance with the demands of a "lubric and adulterate age." As a matter of course, the *missus* freely borrowed from other species, among which, so far as they were of native Italian origin, the *Atellane fables* (from *Atella* in Campania) call for special mention. Very probably of Oscan origin, they began with declinations of the life of small towns, in which dramatic and other satire has never ceased to find a favourite subject. The principal personages in these living sketches gradually assumed a fixed and conventional character, which they retained even when, after the final overthrow of Campanian independence (210), the *Atellanae* had been transplanted to Rome. Here the heavy father or husband (*poppus*), the ass-eared glutton (*maccus*), the full-cheeked, voracious chatterbox (*bucco*), and the wily sharper (*dorsenus*) became accepted comic types, and, with others of a similar kind, were handed down, to reappear in the modern Italian drama. In these characters lay the essence of the *Atellanae*: their plots were extremely simple; the dialogue (perhaps interspersed with songs in the Saturnian metre) was left to the performers to improvise. In course of time these plays assumed a literary form, being elaborated as after-pieces by Lucius Pomponius of Bononia, Novius and other authors; but under the Empire they were gradually absorbed in the pantomimes.

The regular, as distinct from the popular, Roman drama, on the other hand, was of foreign (i.e. Greek) origin; and its early history, at all events, attaches itself to more or less fixed dates. It begins with the year 240 B.C., when at the *Iudi Romani*, held with unusual splendour after the first Punic War, its victorious conclusion was, in accordance with Macedonian precedent, celebrated by the first production of a tragedy and a comedy on the Roman stage. The author of both, who appeared in person as an actor, was Livius Andronicus (b. 278 or earlier), a native of the Greek city of Tarentum, where the Dionysiac festivals enjoyed high popularity. His models were, in tragedy, the later Greek tragedians and their revisions of the three great Attic masters; in comedy, we may feel sure, Menander and his school. Greek examples continued to dominate the regular Roman drama during the whole of its course, even when it resorted to native themes.

The main features of Roman tragedy admit of no doubt, although our conclusions respecting its earlier progress are only derived from analogy, from scattered notices, especially of the titles of plays, and from such fragments—mostly very brief—as have come down to us. Of the known titles of the tragedies of Livius Andronicus, six belong to the Trojan cycle, and this preference consistently maintained itself among the tragedians of the "Trojogenae"; next in popularity seem to have been the myths of the house of Tantalus, of the Pelopidae and of the Argonauts. The distinctions drawn by later Roman writers between the styles of the tragic poets of the republican period must in general be taken on trust. The Campanian Cn. Naevius (fl. from 236) wrote comedies as well as tragedies, so that the rigorous separation observed among the Greeks in the cultivation of the two dramatic species was at first neglected at Rome. His realistic tendency, displayed in that fondness for political allusions which brought upon him the vengeance of a noble family (the Metelli) incapable of understanding a joke of this description, might perhaps under more favourable circumstances have led him more fully to develop a new tragic species invented by him. But the *fabula*

praetexta, *praetexta* or *praetextata* (from the purple-bordered robe worn by higher magistrates) was not destined to become the means of emancipating the Roman serious drama from the control of Greek examples. In design, it was national tragedy on historic subjects of patriotic interest—which the Greeks had treated only in isolated instances; and one might at first sight marvel why, after Naevius and his successors had produced skilful examples of the species, it should have failed to overshadow and outlast in popularity a tragedy telling the oft-told foreign tales of Thebes and Mycenae, or even the pseudo-ancestral

story of Troy. But it should not be forgotten to how great an extent so-called early Roman history consisted of the traditions of the *gentes*, and how little the party-life of later republican Rome lent itself to a dramatic treatment likely to be acceptable both to the nobility and to the multitude. As for the emperors, the last licence they would have permitted to the theatre was a free popular treatment of the national history; if Augustus prohibited the publication of a tragedy by his adoptive father on the subject of *Oedipus*, it was improbable that he or his successors should have sanctioned the performance of plays dealing with the earthly fortunes of Divus Julius himself, or with the story of Marius, or that of the Gracchi, or any of the other tragic themes of later republican or imperial history. The historic drama at Rome thus had no opportunity for a vigorous life, even could tragedy have severed its main course from the Greek literature of which it has been well called a "free-hand copy." The *praetextae* of which we know chiefly treat—possibly here and there helped to form—legends of a hoary antiquity, or celebrate battles chronicled in family or public records²; and in the end the species died a natural death.³

Q. Ennius (239–168), the favourite poet of the great families, was qualified by his Tarentine education, which taught the Oscan youth the Greek as well as the Latin tongue (so that he boasted "three souls"), to become the literary *Ennius and his successors* exponent of the Hellenizing tendencies of his age of Roman society. Nearly half of the extant names of his tragedies belong to the Trojan cycle; and Euripides was clearly his favourite source and model. M. Pacuvius (b. c. 229), like Ennius subject from his youth up to the influences of Greek civilization, and the first Roman dramatist who devoted himself exclusively to the tragic drama, was the least fertile of the chief Roman tragedians, but was regarded by the ancients as indisputably superior to Ennius. He again was generally (though not uniformly) held to have been surpassed by L. Accius (b. 170), a learned scholar and prolific dramatist, of whose plays 50 titles and a very large number of fragments have been preserved. The plays of the last-named three poets maintained themselves on the stage till the close of the republic, and Accius was quoted by the emperor Tiberius.⁴ Of the other tragic writers of the republic several were *dilectantii*—such as the great orator and eminent politician C. Julius Strabo, the cultivated officer Q. Tullius Cicero, who made an attempt, disapproved by his illustrious brother, to introduce the satyr-drama into the Roman theatre; L. Cornelius Balbus, a Caesarean partisan; and finally C. Julius Caesar himself.

Tragedy continued to be cultivated under the earlier emperors, and one author, the famous and ill-fated L. Annaeus Seneca (4 B.C.–A.D. 65), left behind him a series of works *Seneca*, which were to exercise a paramount influence upon the beginnings of modern tragedy. In accordance with the character of their author's prose-work, they exhibit a strong predominance of the rhetorical element, and an artificiality of style far removed from that of the poets Sophocles and Euripides, from whom Seneca derived his themes. Yet he is interesting, not only by these devices and by a "sensational" choice of themes, but also by a quickness of treatment which we may call "modern," a quality not easily resisted in a dramatist. The metrification of his plays is very strict, and they were doubtless intended for recitation, whether or not also designed for the stage. A few tragic poets are mentioned after Seneca, till about the reign of Domitian (81–96) the list comes to an end. The close of Roman tragic literature is obscurer than its beginning; and, while there are traces of tragic performances at Rome as late as even the 6th century, we are ignorant how long the works of the old

¹ Naevius, *Lupus* (*The Wolf*); *Romulus*; Ennius, *Sabinae* (*The Sabine Women*); Accius, *Brutus*.

² Naevius, *Clastidium* (*Marcellus*?); Ennius, *Ambracia*; Pacuvius, *Paulus*; Accius, *Aeneadae* (*Decius*).

³ Balbus's *Iler* (*The Mission*), an isolated play on an episode of the Pharsalian campaign, seems to have been composed for the mere private delectation of its author and hero. *Oetania*, a late *praetexta* ascribed to Seneca, was certainly not written by him.

⁴ "Oderint dum metuant" (*Atrous*).

masters of Roman tragedy maintained themselves on the stage.

It would obviously be an error to draw from the plays of Seneca conclusions as to the method and style of the earlier writers. In general, however, no important changes seem to have occurred in the progress of Roman tragic composition. The later Greek plays remained, so far as can be gathered, the models in treatment; and, inasmuch as at Rome the several plays were performed singly, there was every inducement to make their action as full and complicated as possible. The dialogue-scenes (*dierbia*) appear to have been largely interspersed with musical passages (*canitica*); but the effect of the latter must have suffered from the barbarous custom of having the songs sung by a boy, placed in front of the flute-player (*cantor*), while the actor accompanied them with gesticulations. The chorus (unlike the Greek) stood on the stage itself and seems occasionally at least to have taken part in the action. But the whole of the musical element can hardly have attained to so full a development as among the Greeks. The divisions of the action appear at first to have been three; from the addition of prologue and epilogue may have arisen the invention (probably due in tragedy to Varro) of the fixed number of five acts. In style, such influence as the genius of Roman literature could exercise must have been in the direction of the rhetorical and the pathetic; a superfluity of energy on the one hand, and a defect of poetic richness on the other, can hardly have failed to characterize these, as they did all the other productions of early Roman poetry.

In Roman comedy two different kinds—respectively called *palliata* and *togata* from well-known names of dress—were distinguished,—the former treating Greek subjects and imitating Greek originals, the latter professing a native character. The *palliata* sought its originals especially in New Attic comedy; and its authors, as they advanced in refinement of style, became more and more dependent upon their models, and unwilling to gratify the coarser tastes of the public by local allusions or gross seasonings. But that kind of comedy which shrinks from the rude breath of popular applause usually has in the end to give way to less squeamish rivals; and thus, after the species had been cultivated for about a century (c. 250–150 B.C.), *palliatae* ceased to be composed except for the amusement of select circles, though the works of the most successful authors, Plautus and Terence, kept the stage even after the establishment of the empire. Among the earlier writers of *palliatae* were the tragic poets Andronicus, Naevius and Ennius, but they were alike surpassed by T. Maccius Plautus (254–184), nearly all of whose comedies esteemed genuine by Varro—not less than 20 in number—have been preserved, though twelve of them were not known to the modern world before 1429. He was exclusively a comic poet, and, though he borrowed his plots from the Greeks—from Diphilus and Philemon apparently in preference to the more refined Menander—there was in him a genuinely national as well as a genuinely popular element. Of the extent of his originality it is impossible to judge; probably it lies in his elaboration of types of character and the comic turns of his dialogue rather than in his plots. Modern comedy is indebted to him in all these points; and, in consequence of this fact, as well as of the attention his text has for linguistic reasons received from scholarship both ancient and modern, his merits have met with quite their full share of recognition. Caecilius Statius (an Insubrian brought to Rome as a captive c. 200) stands midway between Plautus and Terence, but no plays of his remain. P. Terentius Afer (c. 185–159)

was, as his cognomen implies, a native of Carthage, of whose conqueror he enjoyed the patronage. His six extant comedies seem to be tolerably close renderings of their Greek originals, nearly all of which were plays of Menander. It was the good fortune of the works of Terence to be preserved in an exceptionally large number of MSS. in the monastic libraries of the middle ages, and thus (as will be seen) to become a main link between the ancient and the Christian drama. As a

dramatist he is distinguished by correctness of style rather than by variety in his plots or vivacity in his characters; his chief merit—and at the same time the quality which has rendered him so suitable for modern imitation—is to be sought in the polite ease of his dialogue. In general, the main features of the *palliatae*, which were divided into five acts, are those of the New Comedy of Athens, like which they had no chorus; for purposes of explanation from author to audience the prologue sufficed; the Roman versions were probably terser than their originals, which they often altered by the process called *contaminatio*.

The *togatae*, in the wider sense of the term, included all Roman plays of native origin—among the rest, the *praetextae*, in contradistinction to which and to the transient species of the *trabeatae* (from the dress of the knights) the comedies dealing with the life of the lower classes were afterwards called *tabernariae* (from *taberna*, a shop), a name suited by some of their extant titles,¹ while others point to the treatment of provincial scenes.² The *togata*, which was necessarily more realistic than the *palliata*, and doubtless fresher as well as coarser in tone, flourished in Roman literature between 170 and 80 B.C. In this species Titinius, all whose plays bear Latin titles and were *tabernariae*, was succeeded by the more refined L. Afranius, who, though still choosing natural subjects, seems to have treated them in the spirit of Menander. His plays continued to be performed under the empire, though with an admixture of elements derived from that lower species, the pantomime, to which they also were in the end to succumb. The Romans likewise adopted the burlesque kind of comedy called from its inventor *Rhinthonica*, and by other names (see above). But with them, the general course of the drama, which with the Greeks lost itself in the sand, could not fail to be merged into the flood.

The end of Roman dramatic literature was dilettantism and criticism; the end of the Roman drama was spectacle and show, buffoonery and sensual allurements. It was for this that the theatre had passed through all its early troubles, when the political puritanism of the old school had upheld the martial games of the circus against the enervating influence of the stage. In those days the guardians of Roman virtue had sought to diminish the attractions of the theatre by insisting upon its remaining as uncomfortable as possible; but as was usual at Rome, the privileges of the upper orders were at last extended to the population at large, though a separation of classes continued to be characteristic of a Roman audience. The first permanent theatre erected at Rome was that of Cn. Pompeius (55 B.C.), which contained nearly 18,000 seats; but even of this the portion allotted to the performers (*scenae*) was of wood; nor was it till the reign of Tiberius (A.D. 22) that, after being burnt down, the edifice was rebuilt in stone.

Though a species of amateur literary censorship, introduced by Pompeius, became customary in the Augustan age, in general the drama's laws at Rome were given by the drama's patrons—in other words, the production of plays was a matter of private speculation. The exhibitions were contracted for with the officials charged with the superintendence of public amusements (*curatores ludorum*); the actors were slaves trained for the art, mostly natives of southern Italy or Greece. Many of them rose to reputation and wealth, purchased their freedom, and themselves became directors of companies; but, though Sulla might make a knight of Roscius, and Caesar and his friends defy ancient prejudice, the stigma of civil disability (*infamia*) was not removed from the profession, which in the great days of the Attic drama had been held in honour at Athens. But, on the whole, the social treatment of actors was easy in the days of the early empire; senators and knights actually appeared on the stage; Nero sang on it; and a *pantomimus* was made *praefectus urbi* by Elagabalus.

The actor's art was carried on at Rome under conditions differing in other respects from those of the Greek theatre

¹ *Augur*; *Cinerarius* (*The Crimper*); *Fullonia* (*The Fuller's Trade*); *Libertus* (*The Freedman*); *Tibicina* (*The Flute-Girl*)

² *Brundisinae*; *Ferentinis*; *Selino*.

The Romans loved a full stage, and from the later period of the republic liked to see it crowded with supernumeraries. This accorded with their military instincts, and with the general grossness of their tastes, which led them in the theatre as well as in the circus to delight in spectacle and tumult, and to applaud Pompeius when he furnished forth the return of Agamemnon in the *Clytemnestra* with a grand total of 600 heavily-laden mules. On the other hand, the actors stood nearer to the spectators in the Roman theatre than in the Greek, the stage (*pulpitum*) not being separated from the first rows of the audience by an orchestra occupied by the chorus; and this led in earlier times to the absence of masks, diversely coloured wigs serving to distinguish the age of the characters. Roscius, however, is said (because of an obliquity of vision which disfigured his countenance) to have introduced the use of masks; and the retrograde innovation, though disapproved of, maintained itself. The tragic actors wore the *crepida*, corresponding to the *colthumus*, and a heavy toga, which in the *prætexta* had the purple border giving its name to the species. The conventional costumes of the various kinds of comedy are likewise indicated by their names. The comparative nearness of the actors to the spectators encouraged the growth of that close criticism of acting which has always been dear to an Italian public, and which in ancient days manifested itself at Rome in all the ways familiar to modern audiences. Where there is criticism, devices are apt to spring up for anticipating or directing it; and the evil institution of the *claque* is modelled on Roman precedent, typified by the standing conclusion "plaudite!" in the epilogues of the *palliatee*.

In fine, though the art of acting at Rome must have originally formed itself on Greek example and precept, it was doubtless elaborated with a care unknown to the greatest Attic artists. Its most famous representatives were Gallus, called after his emancipation Q. Roscius Gallus (d. c. 62 B.C.), who, like the great "English Roscius," excelled equally in tragedy and comedy, and his younger contemporary Clodius Aesopus, a Greek by birth, likewise eminent in both branches of his art, though in tragedy more particularly. Both these great actors are said to have been constant hearers of the great orator Hortensius; and Roscius wrote a treatise on the relations between oratory and acting. In the influence of oratory upon the drama are perhaps to be sought the chief among the nobler features of Roman tragedy to which a native origin may be fairly ascribed.

9. DOWNFALL OF THE CLASSICAL DRAMA

The ignominy of the Roman—and with it of the ancient classical—drama has been already foreshadowed. The elements of dance and song, never integrally united with the dialogue in Roman tragedy, were now altogether separated from it. While it became customary simply to recite tragedies to the small audiences who continued (or, as a matter of courtesy, affected) to appreciate them, the *pantomimus* commended itself to the heterogeneous multitudes of the Roman theatre and to an effete upper class by confining the performance of the actor to gesticulation and dancing, a chorus singing the accompanying text. The species was developed with extraordinary success already under Augustus by Pylades and Bathyllus; and so popular were these entertainments that even eminent poets, such as Lucan (d. A.D. 65), wrote the librettos for these *fabulae salticae* (ballets), of which the subjects were generally mythological, only now and then historical, and chiefly of an amorous kind. A single masked performer was able to enchant admiring crowds by the art of gesticulation and movement only. In what direction this art tended, when suiting itself to the most abnormal demands of a recklessly sensual age, may be gathered from the remark of one of the last pagan historians of the empire, that the introduction of pantomimes was a sign of the general moral decay of the world which began with the beginning of the monarchy. Comedy more easily lost itself in the cognate form of the *mimus*, which survived all other kinds of comic entertainments because of its more audacious immorality and open obscenity. Women took

part in these performances, by means of which, as late as the 6th century, a *mima* acquired a celebrity which ultimately raised her to the imperial throne, and perhaps occasioned the removal of a disability which would have rendered her marriage with Justinian impossible.

Meanwhile, the regular drama had lingered on, enjoying in all its forms imperial patronage in the days of the literary revival under Hadrian (117-138); but the perennial taste for the spectacles of the amphitheatre, which was as strong at Byzantium as it was at Rome, and which reached its climax in the days of Constantine the Great (306-337), under whom the reaction set in, determined the downfall of the dramatic art. It was not absolutely extinguished even by the irruptions of the northern barbarians; but a bitter adversary had by this time risen into power. The whole authority of the Christian Church had, without usually caring to distinguish between the nobler and the looser elements in the drama, involved all its manifestations in a consistent condemnation (as in Tertullian's *De spectaculis*, 200 c.), comprehended them all in an uncompromising anathema. When the faith of that Church was acknowledged as the religion of the Roman empire, the doom of the theatre was sealed. It died hard, however, both in the capitals and in many of the provincial centres of East and West alike. At Rome the last mention of *spectacula* as still in existence seems to date from the sway of the East-Goths under Theodoric and his successor, in the earlier half of the 6th century. In the capital and provinces of the Eastern empire the decline and fall of the stage cannot be similarly traced; but its end is authoritatively assigned to the period of Saracen invasions which began with the Omayyad dynasty in the 7th century.

It cannot be pretended that the doom which thus slowly and gradually overtook the Roman theatre was undeserved. The remnants of the literary drama had long been overshadowed by entertainments such as both earlier and later Roman emperors—Domitian and Trajan as well as Galerius and Constantine—had found themselves constrained to prohibit in the interests of public morality and order, by the bloody spectacles of the amphitheatre and by the maddening excitement of the circus. The art of acting had sunk into pandering to the lewd or frivolous itch of eye and ear; its professors had, in the words of a most judicious modern historian, become "a danger to the peace of householders, as well as to the peace of the streets"; and the theatre had contributed its utmost to the demoralization of a world. The attitude taken up by the Christian Church towards the stage was in general as unavoidable as its particular expressions were at times heated by fanaticism or distorted by ignorance. Had she not visited with her condemnation a wilderness of decay, she could not herself have become—what she little dreamt of becoming—the nursing mother of the new birth of an art which seemed incapable of regeneration.

Though already in the 4th century *scenics* had been excluded from the benefit of Christian sacraments, and excommunication had been extended to those who visited theatres instead of churches on Sundays and holidays, while the clergy were absolutely prohibited from entering a theatre, and though similar enactments had followed at later dates—yet the entertainments of the condemned profession had never been entirely suppressed, and had even occasionally received imperial patronage. The legislation on the subject in the *Codex Theodosianus* (accepted by both empires in the earlier part of the 5th century) shows a measure of tolerance indicating a conviction that the theatrical profession could not be suppressed. Gradually, however, as they lost all footing in the centres of civic life, the *mimes* and their fellows became a wandering fraternity, who doubtless appeared at festivals when their services were required, and vanished again into the depths of the obscurity which has ever covered that mysterious existence—the strollers' life. It was thus that these strange intermediaries of civilization carried down such traditions as survived of the acting drama of pagan antiquity into the succeeding ages.

The drama and the Christian Church.

Roscius and Aesopus.

Pantomimus.

Survival of the mimes.

Mimus.

10. MEDIEVAL DRAMA

While the scattered and persecuted strollers thus kept alive something of the popularity, if not of the loftier traditions, of their art, neither, on the other hand, was there an utter absence of written compositions to bridge the gap between ancient and modern dramatic literature. In the midst of the condemnation with which the Christian Church visited the stage, its professors and votaries, we find individual ecclesiastics resorting in their writings to both the tragic and the comic form of the ancient drama. These isolated productions, which include the *Χριστός πάσχων* (*Passion of Christ*) formerly attributed to St Gregory Nazianzen, and the *Querolus*, long fathered upon Plautus himself, were doubtless mostly written for educational purposes—whether Euripides and Lycophron, or Menander, Plautus and Terence, served as the outward models. The same was probably the design of the famous “comedies” of Hrosvitha, the Benedictine nun of Gandersheim, in Eastphalian Saxony, which associate themselves in the history of Christian literature with the spiritual revival of the 10th century in the days of Otto the Great. While avowedly imitated in form from the comedies of Terence, these religious exercises derive their themes—martyrdoms,¹ and miraculous or otherwise startling conversions²—from the legends of Christian saints. Thus, from perhaps the 9th to the 12th centuries, Germany and France, and through the latter, by means of the Norman Conquest, England, became acquainted with what may be called the literary monastic drama. It was no doubt occasionally performed by the children under the care of monks or nuns, or by the religious themselves; an exhibition of the former kind was that of the *Play of St Katharine*, acted at Dunstable about the year 1110 in “copes” by the scholars of the Norman Geoffrey, afterwards abbot of St Albans. Nothing is known concerning it except the fact of its performance, which was certainly not regarded as a novelty.

These efforts of the cloister came in time to blend themselves with more popular forms of the early medieval drama. The natural agents in the transmission of these popular forms were those *mimes*, whom, while there representatives of more elaborate developments, the “pantomimes” in particular, had inevitably succumbed, the Roman drama had left surviving it, unextinguished and unextinguishable. Above all, it is necessary to point out how in the long interval now in question—the “dark ages,” which may, from the present point of view, be reckoned from about the 6th to the 11th century—the Latin and the Teutonic elements of what may be broadly designated as medieval “minstrelsy,” more or less imperceptibly, coalesced. The traditions of the disestablished and disendowed *minimus* combined with the “occupation” of the Teutonic *scōp*, who as a professional personage does not occur in the earliest Teutonic poetry, but on the other hand is very distinctly traceable under this name or that of the “gleeman,” in Anglo-Saxon literature, before it fell under the control of the Christian Church. Her influence and that of docile rulers, both in England and in the far wider area of the Frank empire, gradually prevailed even over the inherited goodwill which neither Alfred nor even Charles the Great had denied to the composite growth in which *minimus* and *scōp* alike had a share.

How far the *foclutores*—which in the early middle ages came to be the name most widely given to these irresponsible transmitters of a great artistic trust—kept alive the usage of entertainments more essentially dramatic than the minor varieties of their performances, we cannot say. In different countries these entertainers suited themselves to different tastes, and with the rise of native literatures to different literary tendencies. The literature of the *troubadours* of Provence, which communicated itself to Spain and Italy, came only into isolated contact with the beginnings of the religious drama; in northern France the *jongleurs*, as the *foclutores* were now called, were confounded

with the *trouvères*, who, to the accompaniment of *vielle* or harp, sang the *chansons de geste* commemorative of deeds of war. As appointed servants of particular households they were here, and afterwards in England, called *menestrels* (from *ministerium*) or *minstrels*. Such a *histrion* or *minimus* (as he is called) was Taillefer, who rode first into the fight at Hastings, singing his songs of Roland and Charlemagne, and tossing his sword in the air and catching it again. In England such accomplished minstrels easily outshone the less versatile gleemen of pre-Norman times, and one or two of them appeared as landholders in Domesday Book, and many enjoyed the favour of the Norman, Angevin and Plantagenet kings. But here, as elsewhere, the humbler members of the craft spent their lives in strolling from castle to convent, from village-green to city-street, and there exhibiting their skill as dancers, tumblers, jugglers proper, and as masquers and conductors of bears and other dumb contributors to popular wonder and merriment. Their only chance of survival finally came to lie in organization under the protection of powerful nobles; but when, in the 15th century in England, companies of players issued forth from towns and villages, the profession, in so far as its members had not secured preference, saw itself threatened with ruin.

In any attempt to explain the transmission of dramatic elements from pagan to Christian times, and the influence exercised by this transmission upon the beginnings of *Survivals and adaptations of pagan festivals and ceremonies* from the end of the 6th century onwards, the Western Church tolerated and even attracted to her own festivals popular customs, significant of rejoicing, which were in truth relics of heathen ritual. Such were the Mithraic feast of the 25th of December, or the egg of Eostre-tide, and a multitude of Celtic or Teutonic agricultural ceremonies. These rites, originally symbolical of propitiation or of weather-magic, were of a semi-dramatic nature—such as the dipping of the neck of corn in water, sprinkling holy drops upon persons or animals, processions of beasts or men in beast-masks, dressing trees with flowers, and the like, but above all ceremonial dances, often in disguise. The sword-dance, recorded by Tacitus, of which an important feature was the symbolic threat of death to a victim, endured (though it is rarely mentioned) to the later middle ages. By this time it had attracted to itself a variety of additional features, and of characters familiar as pace-eggers, mummers, morris-dancers (probably of distinct origin), who continually enlarged the scope of their performances, especially as regarded their comic element. The dramatic “expulsion of death,” or winter, by the destruction of a lay-figure—common through western Europe about the 8th century—seems connected with a more elaborate rite, in which a disguised performer (who perhaps originally represented summer) was slain and afterwards revived (the *Pängstl*, Jack in the Green, or Green Knight). This representation, after acquiring a comic complexion, was annexed by the character dancers, who about the 15th century took to adding still livelier incidents from songs treating of popular heroes, such as St George and Robin Hood; which latter found a place in the festivities of May Day with their central figure, the May Queen. The earliest ceremonial observances of this sort were clearly connected with pastoral and agricultural life; but the inhabitants of the towns also came to have a share in them; and so, as will be seen later, did the clergy. They were in particular responsible for the buffooneries of the feast of fools (or asses), which enjoyed the greatest popularity in France (though protests against it are on record from the 11th century onwards to the 17th), but was well known from London to Constantinople. This riotous New Year’s celebration was probably derived from the ancient Kalend feasts, which may have bequeathed to it both the hobby-horse and the lord, or bishop, of misrule. In the 16th century the feast of fools was combined with the elaborate festivities of courts and cities during the twelve Christmas feasts—the season when throughout the previous two centuries the “mummers” especially

¹ *Gallicanus*, part ii.; *Sapientia*.

² *Gallicanus*, part i.; *Calimachus*; *Abraham*; *Paphnutius*.

flourished, who in their disguisings and "siseses" began as dancers gesticulating in dumb-show, but ultimately developed into actors proper.

Thus the literary and the professional element, as well as that of popular festive usages, had survived to become tributaries to the main stream of the early Christian drama, which had its direct source in the liturgy of the Church itself. The service of the Mass contains in itself dramatic elements, and combines with the reading out of portions of Scripture by the priest—its "epical" part—a "lyrical" part in the anthems and responses of the congregation. At a very early period—certainly already in the 5th century—it was usual on special occasions to increase the attractions of public worship by living pictures, illustrating the Gospel narrative and accompanied by songs; and thus a certain amount of action gradually introduced itself into the service. The insertion, before or after sung portions of the service, of tropes, originally one or more verses of texts, usually serving as introits and in connexion with the gospel of the day, and recited by the two halves of the choir, naturally led to dialogue chanting; and this was frequently accompanied by illustrative fragments of action, such as drawing down the veil from before the altar.

Tropes.

This practice of interpolations in the offices of the church, which is attested by texts from the 9th century onwards (the so-called "Winchester tropes" belong to the 10th and 11th), progressed, till on the great festivals of the church the epical part of the liturgy was systematically connected with spectacular and in some measure mimical adjuncts, the lyrical accompaniment being of course retained. Thus the *liturgical mystery*—the earliest form of the Christian drama—was gradually called into existence. This had certainly been accomplished as early as the 10th century, when on great ecclesiastical festivals it was customary for the priests to perform in the churches these offices (as they were called). The whole Easter story, from the burial to Emmaus, was thus presented, the Maries and the angel adding their lyrical *planctus*; while the surroundings of the Nativity—the Shepherds, the Innocents, &c.—were linked with the Shepherds of Epiphany by a recitation of "Propheets," including Vergil and the Sibyl. Before long, from the 11th century onwards, *mysteriess*, as they were called, were produced in France on scriptural subjects unconnected with the great Church festivals—such as the Wise and Foolish Virgins, Adam (with the fall of Lucifer), Daniel, Lazarus, &c. Compositions on the last-named two themes remain from the hand of one of the very earliest of medieval play-writers, Hilarius, who may have been an Englishman, and who certainly studied under Abelard. He also wrote a "miracle" of St Nicholas, one of the most widely popular of medieval saints. Into the pieces founded on the Scripture narrative outside characters and incidents were occasionally introduced, by way of diverting the audience.

These mysteries and miracles being as yet represented by the clergy only, the language in which they were usually written is Latin—in many varieties of verse with occasional prose; but already in the 11th century the further step was taken of composing these texts in the vernacular—the earliest example being the mystery of the Resurrection. In time a whole series of mysteries was joined together; a process which was at first roughly and then more elaborately pursued in France and elsewhere, and finally resulted in the *collective mystery*—merely a scholars' term of course, but one to which the principal examples of the English mystery-drama correspond.

The productions of the medieval religious drama it is usual technically to divide into three classes. The *mysteriess* proper deal with scriptural events only, their purpose being to set forth, with the aid of the prophetic or preparatory history of the Old Testament, and more especially of the fulfilling events of the New, the central mystery of the Redemption of the world, as accomplished by Nativity, the Passion and the Resurrection. But in fact

these were not kept distinctly apart from the *miracle-plays*, or *miracles*, which are strictly speaking concerned with the legends of the saints of the church; and in England the name *mysteriess* was not in use. Of these species the miracles must more especially have been fed from the resources of the monastic literary drama. Thirdly, the *moralities*, or *moral-plays*, teach and illustrate the same truths—not, however, by direct representation of scriptural or legendary events and personages, but allegorically, their characters being personified virtues or qualities. Of the moralities the Norman *trousses* had been the inventors; and doubtless this innovation connects itself with the endeavour, which in France had almost proved victorious by the end of the 13th century, to emancipate dramatic performances from the control of the church.

The attitude of the clergy towards the dramatic performances which had arisen out of the elaboration of the services of the church, but soon admitted elements from other sources, was not, and could not be, uniform. As the plays grew longer, their paraphernalia more extensive, and their spectators more numerous, they began to be represented outside as well as inside the churches, at first in the churchyards, and the use of the vulgar tongue came to be gradually preferred. A Beverley Resurrection play (1220 c.) and some others are bilingual. Miracles were less dependent on this connexion with the church services than mysteries proper; and lay associations, guilds, and schools in particular, soon began to act plays in honour of their patron saints in or near their own halls. Lastly, as scenes and characters of a more or less trivial description were admitted even into the plays acted or superintended by the clergy, as some of these characters came to be depended on by the audiences for conventional extravagance or fun, every new Herod seeking to out-Herod his predecessor, and the devils and their chief asserting themselves as indispensable favourites, the comic element in the religious drama increased; and that drama itself, even where it remained associated with the church, grew more and more profane. The endeavour to sanctify the popular tastes to religious uses, which connects itself with the institution of the great festival of Corpus Christi (1264, confirmed 1311), when the symbol of the mystery of the Incarnation was borne in solemn procession, led to the closer union of the dramatic exhibitions (hence often called *processus*) with this and other religious feasts; but it neither limited their range nor controlled their development.

It is impossible to condense into a few sentences the extremely varied history of the processes of transformation undergone by the medieval drama in Europe during the two centuries—from about 1200 to about 1400—in which it ran a course of its own, and during the succeeding period, in which it was only partially affected by the influence of the Renaissance. A few typical phenomena may, however, be noted in the case of the drama of each of the several chief countries of the West; where the vernacular successfully supplanted Latin as the ordinary medium of dramatic speech, where song was effectually ousted by recitation and dialogue, and where finally, though the emancipation was on this head nowhere absolute, the religious drama gave place to the secular.

In France, where dramatic performances had never fallen entirely into the hands of the clergy, the progress was speediest and most decided towards forms approaching those of the modern drama. The earliest plays in the French tongue, however, the 13th-century *Adam*, supposed to have been written by a Norman in England (as is a fragmentary *Résurrection* of much the same date), still reveals its connexion with the liturgical drama. Jean Bodel of Arras' miracle-play of *St Nicolas* (before 1205) is already the production of a secular author, probably designed for the edification of some civic confraternity to which he belonged, and has some realistic features. On the other hand, the *Theophilus* of Rutebeuf (d. c. 1280) treats its Faust-like theme, with which we meet again in Low-German dramatic literature two centuries later, in a rather lifeless form but in a highly religious spirit, and belongs to the cycle of miracles of the Virgin of which examples abound throughout

The *liturgy* the main source of the medieval religious drama.

The *clergy* and the religious drama.

Progress of the medieval drama in Europe.

France.

Mysteriess, miracles, and moralities distinguished.

this period. Easter or Passion plays were fully established in popular acceptance in Paris as well as in other towns of France by the end of the 14th century; and in 1402 the *Confrérie de la Passion*, who at first devoted themselves exclusively to the performance of this species, obtained a royal privilege for the purpose. These series of religious plays were both extensive and elaborate; perhaps the most notable series (c. 1450) is that by Arnoul Greban, who died as a canon of Le Mans, his native town. Its revision, by Jean Michel, containing much illustrative detail (first performed at Angers in 1486), was very popular. Still more elaborate is the Rouen Christmas mystery of 1474, and the celebrated *Mystère du vieil testament*, produced at Abbeville in 1458, and performed at Paris in 1500. Most of the Provençal Christmas and Passion plays date from the 14th century, as well as a miracle of St Agnes. The miracles of saints were popular in all parts of France, and the diversity of local colouring naturally imparted to these productions contributed materially to the growth of the early French drama. The miracles of Ste Geneviève and St Denis came directly home to the inhabitants of Paris, as that of St Martin to the citizens of Tours; while the early victories of St Louis over the English might claim a national significance for the dramatic celebration of his deeds. The local saints of Provence were in their turn honoured by miracles dating from the 15th and 16th centuries.

It is less easy to trace the origins of the comic medieval drama in France, connected as they are with an extraordinary variety of associations for professional, pious and pleasurable purposes. The *ludi inhonesti* in which the students of a Paris college (Navarre) were in 1315 debarred from engaging cannot be proved to have been dramatic performances; the earliest known secular plays presented by university students in France were moralities, performed in 1426 and 1431. These plays, depicting conflicts between opposing influences—and at bottom the struggle between good and evil in the human soul—become more frequent from about this time onwards. Now it is (at Rennes in 1439) the contention between *Bien-avisé* and *Mal-avisé* (who at the close find themselves respectively in charge of *Bonne-fin* and *Mal-fin*); now, one between *l'homme juste* and *l'homme mondain*; now, the contrasted story of *Les Enfants de Moutenent*, who, however, is no abstraction, but an honest baker with a wife called Mignotte. Political and social problems are likewise treated; and the *Mystère du Concile de Bâle*—an historical morality—dates back to 1432. But thought is taken even more largely of the sufferings of the people than of the controversies of the Church; and in 1507 we even meet with a hygienic or abstinence morality (by N. de la Chesnaye) in which "Banquet" enters into a conspiracy with "Apoplexy," "Epilepsy" and the whole regiment of diseases.

Long before this development of an artificial species had been consummated—from the beginning of the 14th century onwards—the famous fraternity or professional union of the Basoche (clerks of the Parlement and the Châtelet) had been entrusted with the conduct of popular festivals at Paris, in which, as of right, they took a prominent personal share; and from a date unknown they had performed plays. But after the *Confrérie de la Passion* had been allowed to monopolize the religious drama, the *basochiens* had confined themselves to the presentation of moralities and of farces (from Italian *farsa*, Latin *farctio*), in which political satire had as a matter of course when possible found a place. A third association, calling themselves the *Enfants sans souci*, had, apparently also early in the 15th century, acquired celebrity by their performances of short comic plays called *soties*—in which, as it would seem, at first allegorical figures ironically "played the fool," but which were probably before long not very carefully kept distinct from the farces of the Basoche, and were like these on occasion made to serve the purposes of State or of Church. Other confraternities and associations readily took a leaf out of the book of these devil-may-care good-fellows, and interwove their religious and moral plays with comic scenes and characters from actual life, thus becoming more and more free and secular in their dramatic methods, and unconsciously preparing the transition to the regular drama.

The earliest example of a serious secular play known to have been written in the French tongue is the *Estoire de Griseldis* (1393), which is in the style of the miracles of the Virgin, but is largely indebted to Petrarch. The *Mystère du siège d'Orléans*, on the other hand, written about half a century later, in the epic tediousness of its manner comes near to a chronicle history, and interests us chiefly as the earliest of many efforts to bring Joan of Arc on the stage. Jacques Millet's celebrated mystery of the *Destruction de Troye la grant* (1452) seems to have been addressed to readers and not to hearers only. The beginnings of the French regular comic drama are again more difficult to extract from the copious literature of farces and *soties*, which, after mingling actual types with abstract and allegorical figures, gradually came to exclude all but the concrete personages; moreover, the large majority of these productions in their extant form belong to a later period than that now under consideration. But there is ample evidence that the most famous of all medieval farces, the immortal *Maistre Pierre Pathelin* (otherwise *L'Avocat Pathelin*), was written before 1470 and acted by the *basochiens*; and we may conclude that this delightful story of the biter bit, and the profession outwitted, typifies a multitude of similar comic episodes of real life, dramatized for the delectation of clerks, lawyers and students, and of all lovers of laughter.

In the neighbouring Netherlands many Easter and Christmas mysteries are noted from the middle of the 15th century, attesting the enduring popularity of these religious plays; and with them the celebrated series of the Seven Joys of Maria—of which the first is the Annunciation and the seventh the Ascension. To about the same date belongs the small group of the so-called *abele spelen* (as who should say plays easily managed), chiefly on chivalrous themes. Though allegorical figures are already to be found in the Netherlands miracles of Mary, the species of the moralities was specially cultivated during the great Burgundian period of this century by the chambers or lodges of the *Rederijkers* (rhetoricians)—the well-known civic associations which devoted themselves to the cultivation of learned poetry and took an active share in the festivals that formed one of the most characteristic features of the life of the Low Countries. Among these moralities was that of *Elcherlijck* (printed 1495 and presumably by Peter Dorlandus), which there is good reason for regarding as the original of one of the finest of English moralities, *Everyman*.

In Italy the liturgical drama must have run its course as elsewhere; but the traces of it are few, and confined to the north-east. The collective mystery, so common in other Western countries, is in Italian literature represented by a single example only—a *Passione di Gesù Cristo*, performed at Revello in Saluzzo in the 15th century; though there are some traces of other cyclic dramas of the kind. The Italian religious plays, called *figure* when on Old, *vangelis* when on New, Testament subjects, and differing from those of northern Europe chiefly by the less degree of coarseness in their comic characters, seem largely to have sprung out of the development of the processional element in the festivals of the Church. Besides such processions as that of the Three Kings at Epiphany in Milan, there were the penitential processions and songs (*laude*), which at Assisi, Perugia and elsewhere already contained a dramatic element; and at Siena, Florence and other centres these again developed into the so-called (*sacre*) *rappresentazioni*, which became the most usual name for this kind of entertainment. Such a piece was the *San Giovanni e San Paolo* (1480), by Lorenzo the Magnificent—the prince who afterwards sought to reform the Italian stage by paganizing it; another was the *Santa Teodora*, by Luigi Pulci (d. 1487); *San Giovanni Gualberto* (of Florence) treats the religious experience of a latter-day saint; *Rosana e Ulimento* is a love-story with a Christian moral. Passion plays were performed at Rome in the Coliseum by the *Compagnia del Gonfalone*; but there is no evidence on this head before the end of the 15th century. In general, the spectacular magnificence of Italian theatrical displays accorded with the growing pomp of the processions both ecclesiastical and lay—called *trionfi*.

The
Nether-
lands.

Italy.

already in the days of Dante; while the religious drama gradually acquired an artificial character and elaboration of form assimilating it to the classical attempts, to be noted below, which gave rise to the regular Italian drama. The poetry of the Troubadours, which had come from Provence into Italy, here frequently took a dramatic form, and may have suggested some of his earlier poetic experiments to Petrarch.

It was a matter of course that remnants of the ancient popular dramatic entertainments should have survived in particular abundance on Italian soil. They were to be recognized in the improvised farces performed at the courts, in the churches (*farse spirituali*), and among the people; the Roman carnival had preserved its wagon-plays, and various links remained to connect the modern comic drama of the Italians with the *Atellanes* and *mimes* of their ancestors. But the more notable later comic developments, which belong to the 16th century, will be more appropriately noticed below. Moralities proper had not flourished in Italy, where the love of the concrete has always been dominant in popular taste; more numerous are examples of scenes, largely mythological, in which the influence of the Renaissance is already perceptible, of eclogues, and of allegorical festival-plays of various sorts.

In Spain hardly a monument of the medieval religious drama has been preserved. There is manuscript evidence of the 11th century attesting the early addition of dramatic elements to the Easter office; and a Spanish fragment of the Three Kings Epiphany play, dating from the 12th century, is, like the French *Adam*, one of the very earliest examples of the medieval drama in the vernacular. But that religious plays were performed in Spain is clear from the permission granted by Alphonso X. of Castile (d. 1284) to the clergy to represent them, while prohibiting the performance by them of *juegos de escarnio* (mocking plays). The earliest Spanish plays which we possess belong to the end of the 15th or beginning of the 16th century, and already show humanistic influence. In 1472 the couplets of *Mingo Reculgo* (i.e. Domingo Vulgus, the common people), and about the same time another dialogue by the same author, offer examples of a sort resembling the Italian *contrasti* (see below).

The German religious plays in the vernacular, the earliest of which date from the 14th and 15th centuries, and were produced at Trier, Wolfenbüttel, Innsbruck, Vienna, Berlin, &c., were of a simple kind; but in some of them, though they were written by clerks, there are traces of the minstrels' hands. The earliest complete Christmas play in German, contained in a 14th-century St Gallen MS., has nothing in it to suggest a Latin original. On the other hand, the play of *The Wise and the Foolish Virgins*, in a Thuringian MS. thought to be as early as 1328, a piece of remarkable dignity, was evidently based on a Latin play. Other festivals besides Christmas were celebrated by plays; but down to the Reformation Easter enjoyed a preference. In the same century miracle-plays began to be performed, in honour of St Catherine, St Dorothea and other saints. But all these productions seem to belong to a period when the drama was still under ecclesiastical control. Gradually, as the liturgical drama returned to the simpler forms from which it had so surprisingly expanded, and ultimately died out, the religious plays performed outside the churches expanded more freely; and the type of mystery associated with the name of the Frankfort canon Baldemar von Peterweil communicated itself, with other examples, to the receptive region of the south-west. The Corpus Christi plays, or (as they were here called) *Frohleichnamsspiele*, are notable, since that of Innsbruck (1391) is probably the earliest extant example of its class. The number of non-scriptural religious plays in Germany was much smaller than that in France; but it may be noted that (in accordance with a long-enduring popular notion) the theme of the last judgment was common in Germany in the latter part of the middle ages. Of this theme *Antichrist* may be regarded as an episode, though in 1469 an *Antichrist* appears to have occupied at Frankfort four days in its performance. The earlier (12th century) *Antichrist* is a production quite unique of its kind;

this political protest breathes the Ghibelline spirit of the reign (Frederick Barbarossa's) in which it was composed.

Though many of the early German plays contain an element of the moralities, there were few representative German examples of the species. The academical instinct, or some other influence, kept the more elaborate productions on the whole apart from the drolleries of the professional strollers (*fahrende Leute*), whose Shrove-Tuesday plays (*Fasnachtsspiele*) and cognate productions reproduced the practical fun of common life. Occasionally, no doubt, as in the Lübeck *Fasnachtsspiel* of the Five Virtues, the two species may have more or less closely approached to one another. When, in the course of the 15th century, Hans Rosenplüt, called Schnepferer—or Hans Schnepferer, called Rosenplüt—the predecessor of Hans Sachs, first gave a more enduring form to the popular Shrove-Tuesday plays, a connexion was already establishing itself between the dramatic amusements of the people and the literary efforts of the "master-singers" of the towns. But, while the main productivity of the writers of moralities and cognate productions—a species particularly suited to German latitudes—falls into the periods of Renaissance and Reformation, the religious drama proper survived far beyond either in Catholic Germany, and, in fact, was not suppressed in Bavaria and Tirol till the end of the 18th century.¹

It may be added that the performance of miracle-plays is traceable in Sweden in the latter half of the 14th century; and that the German clerks and laymen who immigrated into the Carpathian lands, and into Galicia in particular, in the later middle ages, brought with them their religious plays together with other elements of culture. This fact is the more striking, inasmuch as, though Czech Easter plays were performed about the end of the 14th century, we hear of none among the Magyars, or among their neighbours of the Eastern empire.

Coming now to the English religious drama, we find that from its extant literature a fair general idea may be derived of the character of these medieval productions. The *miracle-plays*, *miracles* or *plays* (these being the terms used in England) of which we hear in London in the 12th century were probably written in Latin and acted by ecclesiastics; but already in the following century mention is made—in the way of prohibition—of plays acted by professional players. (Isolated moralities of the 12th century are not to be regarded as popular productions.) In England as elsewhere, the clergy either sought to retain their control over the religious plays, which continued to be occasionally acted in churches even after the Reformation, or else reprobated them with or without qualifications. In Cornwall miracles in the native Cymric dialect were performed at an early date; but those which have been preserved are apparently copies of English (with the occasional use of French) originals; they were represented, unlike the English plays, in the open country, in extensive amphitheatres constructed for the purpose—one of which, at St Just near Penzance, has recently been restored.

The flourishing period of English miracle-plays begins with the practice of their performance by trading-companies in the towns, though these bodies were by no means possessed of any special privileges for the purpose. Of this practice Chester is said to have set the example (1268-1276); it was followed in the course of the 13th and 14th centuries by many other towns, while in yet others traces of such performances are not to be found till the 15th, or even the 16th. These towns with their neighbourhoods include, starting from East Anglia, where the religious drama was particularly at home, Wymondham, Norwich, Sleaford, Lincoln, Leeds, Wakefield, Beverley, York, Newcastle-on-Tyne, with a deviation across the border to Edinburgh and Aberdeen. In the north-west they are found at Kendal, Lancaster, Preston,

¹The passion-play of Oberammergau, familiar in its present artistic form to so many visitors, was instituted under special circumstances in the days of the Thirty Years' War (1634). Various reasons account for its having been allowed to survive.

Sweden,
Car-
pathian
lands, &c.

Religious
drama in
England.

Cornish
miracle-
plays.

Localities
of the
perform-
ance of
miracle-
plays.

Chester; whence they may be supposed to have migrated to Dublin. In the west they are noticeable at Shrewsbury, Worcester and Tewkesbury; in the Midlands at Coventry and Leicester; in the east at Cambridge and Basingbourne, Heybridge and Manningtree; to which places have to be added Reading, Winchester, Canterbury, Bethesda and London, in which last the performers were the parish-clerks. Four collections, in addition to some single examples of such plays, have come down to us, the *York plays*, the so-called

The York, Towneley, Chester and Coventry plays.

Towneley plays, which were probably acted at the fairs of Widkirk, near Wakefield, and those bearing the names of *Chester* and of *Coventry*. Their dates, in the forms in which they have come down to us, are more or less uncertain; that of the *York* may on the whole be concluded to be earlier than that of the *Towneley*, which were probably put together about the middle of the 14th century; the *Chester* may be ascribed to the close of the 14th or the earlier part of the 15th; the body of the *Coventry* probably belongs to the 15th or 16th. Many of the individual plays in these collections were doubtless founded on French originals; others are taken direct from Scripture, from the apocryphal gospels, or from the legends of the saints. Their characteristic feature is the combination of a whole series of plays into one *collective* whole, exhibiting the entire course of Bible history from the creation to the day of judgment. For this combination it is unnecessary to suppose that they were generally indebted to foreign examples, though there are several remarkable coincidences between the Chester plays and the French *Mystère du vieil testament*. Indeed, the oldest of the series—the *York plays*—exhibits a fairly close parallel to the scheme of the *Cursus mundi*, an epic poem of Northumbrian origin, which early in the 14th century had set an example of treatment that unmistakably influenced the collective mysteries as a whole. Among the isolated plays of the same type which have come down to us may be mentioned *The Harrowing of Hell* (the Saviour's descent into hell), an East-Midland production which professes to tell of "a strife of Jesu and of Satan" and is probably the earliest dramatic, or all but dramatic, work in English that has been preserved; and several belonging to a series known as the *Digby Mysteries*, including *Parfre's Candlemas Day* (the massacre of the Innocents), and the very interesting miracle of *Mary Magdalene*. Of the so-called "Paternoster" and "Creed" plays (which exhibit the miraculous powers of portions of the Church service) no example remains, though of some we have an account; the *Croxton Play of the Sacrament*, the MS. of which is preserved at Dublin, and which seems to date from the latter half of the 15th century, exhibits the triumph of the holy wafer over wicked Jewish wiles.

To return to the collective mysteries, as they present themselves to us in the chief extant series. "The manner of these

English collective mysteries.

plays," we read in a description of those at Chester, dating from the close of the 16th century, "were — Every company had his pageant, which pageants were a high scaffold with two rooms, a higher and a lower, upon four wheels. In the lower they apparelled themselves, and in the higher room they played, being all open at the top, that all beholders might hear and see them. The places where they played them was in every street. They began first at the abbey gates, and when the first pageant was played, it was wheeled to the high cross before the mayor, and so to every street, and so every street had a pageant playing before them at one time till all the pageants appointed for the day were played; and when one pageant was near ended, word was brought from street to street, that so they might come in place thereof, exceedingly orderly, and all the streets have their pageants afore them all at one time playing together; to see which plays was great resort, and also scaffolds and stages made in the streets in those places where they determined to play their pageants."

Each play, then, was performed by the representative of a particular trade or company, after whom it was called the *fishers'*, *glovers'*, &c., *pageant*; while a general prologue was spoken by a herald. As a rule the movable stage sufficed for the

action, though we find horsemen riding up to the scaffold, and Herod instructed to "rage in the pagond and in the strete also." There is no probability that the stage was, as in France, divided into three platforms with a dark cavern at the side of the lowest, appropriated respectively to the Heavenly Father and his angels, to saints and glorified men, to mere men, and to souls in hell. But the last-named locality was frequently displayed in the English miracles, with or without fire in its mouth. The costumes were in part conventional,—divine and saintly personages being distinguished by gilt hair and beards, Herod being clad as a Saracen, the demons wearing hideous heads, the souls black and white coats according to their kind, and the angels gold skins and wings.

Doubtless these performances abounded in what seem to us ludicrous features; and, though their main purpose was serious, they were not in England at least intended to be devoid of fun. But many of the features in question are in truth only homely and *naïf*, and the simplicity of feeling which they exhibit is at times pathetic rather than laughable. The occasional grossness is due to an absence of refinement of taste rather than to an obliquity of moral sentiment. These features the four series have more or less in common, still there are certain obvious distinctions between them. The *York plays* (48), which were performed at Corpus Christi, are comparatively free from the tendency to jocularity and vulgarity observable in the *Towneley*; several of the plays concerned with the New Testament and early Christian story are, however, in substance common to both series. The *Towneley Plays* or *Wakefield Mysteries* (32) were undoubtedly composed by the friars of Widkirk or Nostel; but they are of a popular character; and, while somewhat over-free in tone, are superior in vivacity and humour to both the later collections. The *Chester Plays* (25) were undoubtedly indebted both to the *Mystère du vieil testament* and to earlier French mysteries; they are less popular in character than the earlier two cycles, and on the whole undistinguished by original power of pathos or humour. There is, on the other hand, a notable inner completeness in this series, which includes a play of *Antichrist*, devoid of course of any modern application. While these plays were performed at Whitsuntide, the *Coventry Plays* (42) were Corpus Christi performances. Though there is no proof that the extant series were composed by the Grey Friars, they reveal a considerable knowledge of ecclesiastical literature. For the rest, they are far more effectively written than the *Chester Plays*, and occasionally rise to real dramatic force. In the *Coventry* series there is already to be observed an element of abstract figures, which connects them with a different species of the mediæval drama.

Character of the plays.

The *moralties* corresponded to the love for allegory which manifests itself in so many periods of English literature, and which, while dominating the whole field of mediæval literature, was nowhere more assiduously and effectively cultivated than in England. It is necessary to bear this in mind, in order to understand what to us seems so strange, the popularity of the moral-plays, which indeed never equalled that of the miracles, but sufficed to maintain the former species till it received a fresh impulse from the connexion established between it and the "new learning," together with the new political and religious ideas and questions, of the Reformation age. Moreover, a specially popular element was supplied to these plays, which in manner of representation differed in no essential point from the miracles, in a character borrowed from the latter, and, in the *moralties*, usually provided with a companion whose task it was to lighten the weight of such abstractions as Sapience and Justice. These were the Devil and his attendant the *Vice*, of whom the latter seems to have been of native origin, and, as he was usually dressed in a fool's habit, was probably suggested by the familiar custom of keeping an attendant fool at court or in great houses. The *Vice* had many *aliases* (*Shifft*, *Ambidexter*, *Sin*, *Fraud*, *Iniquity*, &c.), but his usual duty is to torment and tease the Devil his master for the edification and diversion of the audience.

The Devil and the Vice.

He was gradually blended with the domestic fool, who survived in the regular drama. There are other concrete elements in the moralities; for typical figures are often fitted with concrete names, and thus all but converted into concrete human personages.

The earlier English moralities—from the reign of Henry VI. to that of Henry VII.—usually allegorize the conflict between good and evil in the mind and life of man, without any side-intention of theological controversy. Such also is still essentially the purpose of the extant morality by Henry VIII.'s poet, the witty Skelton.¹ *Everyman* (pr. c. 1529), perhaps the most perfect example of its class, with which the present generation has fortunately become familiar, contains passages certainly designed to enforce the specific teaching of Rome. But its Dutch original was written at least a generation earlier, and could have no controversial intention. On the other hand, R. Wever's *Lusty Juventus* breathes the spirit of the dogmatic reformation of the reign of Edward VI. Theological controversy largely occupies the moralities of the earlier part of Elizabeth's reign,² and connects itself with political feeling in a famous morality, Sir David Lyndsay's *Satire of the Three Estates*, written and acted (at Cupar, in 1539) on the other side of the border, where such efforts as the religious drama proper had made had been extinguished by the Reformation. Only a single English political morality proper remains to us, which belongs to the beginning of the reign of Elizabeth.³ Another series connects itself with the ideas of the Renaissance rather than the Reformation, treating of intellectual progress rather than of moral conduct;⁴ this extends from the reign of Henry VIII. to that of his younger daughter. Besides these, there remain some Elizabethan moralities which have no special theological or scientific purpose, and which are none the less lively in consequence.⁵

The transition from the morality to the regular drama in England was effected, on the one hand, by the intermixture of historical personages with abstractions—as in Bishop Bale's *Kyng Johan* (c. 1548)—which easily led over to the *chronicle history*; on the other, by the introduction of types of real life by the side of abstract figures. This latter tendency, of which instances occur in earlier plays, is observable in several of the 16th-century moralities;⁶ but before most of these were written, a further step in advance had been taken by a man of genius, John Heywood (b. c. 1500, d. between 1577 and 1587), whose "interludes"⁷ were short farces in the French manner. The term "interludes" was by no means new, but had been applied by friend and foe to religious plays, and plays (including moralities) in general, already in the 14th century. But it conveniently serves to designate a species which marks a distinct stage in the history of the modern drama. Heywood's interludes dealt entirely with real—very real—men and women. Orthodox and conservative, he had at the same time a keen eye for the vices as well as the follies of his age, and not the least for those of the clerical profession. Other writers, such as T. Ingeland,⁸ took the same direction; and the allegory of abstractions was thus undermined on the stage, very much as in didactic literature the ground had been cut from under its feet by the *Ship of Fools*. Thus the interludes facilitated the advent of comedy, without having superseded the earlier form. Both moralities and miracle-plays survived into the Elizabethan age after the regular drama had already begun its course.

Transition from the morality to the regular drama.

Heywood's interludes.

¹ To the earliest group belong *The Castle of Perseverance*; *Wisdom who is Christ*; *Mankind*; to the second, or early Tudor group, *Medwell, Nature*; *The World and the Child*; *Hycke-Scorner*, &c.

² *Magnificence*.

³ *New Customs*; N. Woodes, *The Conflict of Conscience*, &c.

⁴ *Albyon Knight*.

⁵ Rastell, *Nature of the Four Elements*; Redford, *Wit and Science*; *The Trial of Treasure*; *The Marriage of Wit and Science*.

⁶ *The Marriage of Wit and Wisdom*; *The Contention between Liberality and Prodigality*.

⁷ *Jack Juggler*; *Tom Tyler and his Wife*, &c.

⁸ *The Four P's*, &c. ⁸ *The Disobedient Child* (c. 1560).

Such, in barest outline, was the progress of dramatic entertainments in the principal countries of Europe, before the revival of classical studies brought about a return to the examples of the classical drama, or before this return had distinctly asserted itself. It must not, however, be forgotten that from an early period in England as elsewhere had flourished a species of entertainments, not properly speaking dramatic, but largely contributing to form and foster a taste for dramatic spectacles. The *pageants*—as they were called in England—were the successors of those *ridings* from which, when they gladdened "Chepe," Chaucer's idle apprentice would not keep away; but they had advanced in splendour and ingenuity of device under the influence of Flemish and other foreign examples. Costumed figures represented before gaping citizens the heroes of mythology and history, and the abstractions of moral, patriotic, or municipal allegory; and the city of London clung with special fervour to these exhibitions, which the Elizabethan drama was neither able nor—as represented by most of its poets who composed devices and short texts for these and similar shows—willing to oust from popular favour. Some of the greatest and some of the least of English dramatists were the ministers of pageantry; and perhaps it would have been an advantage for the future of the theatre if the legitimate drama and the *Triumphs of Old Drapery* had been more jealously kept apart. With the reign of Henry VIII. there also set in a varied succession of entertainments at court and in the houses of the great nobles, which may be said to have lasted through the Tudor and early Stuart periods; but it would be an endless task to attempt to discriminate the dramatic elements contained in these productions. The "mask," stated to have been introduced from Italy into England as a new diversion in 1512-1513, at first merely added a fresh element of "disguising" to those already in use; as a quasi-dramatic species ("mask" or "masque") capable of a great literary development it hardly asserted itself till quite the end of the 16th century.

II. THE MODERN NATIONAL DRAMA

The literary influence which finally transformed the growths noticed above into the national dramas of the several countries of Europe, was that of the Renaissance. Among the remains of classical antiquity which were studied, translated and imitated, those of the drama necessarily held a prominent place. Never altogether lost sight of, they now became subjects of devoted research and models for more or less exact imitation, first in Greek or Latin, then in modern tongues; and these essentially literary endeavours came into more or less direct contact with, and acquired more or less control over, dramatic performances and entertainments already in existence. This process it will be most convenient to pursue *seriatim*, in connexion with the rise and progress of the several dramatic literatures of the West. For no sooner had the stream of the modern drama, whose source and contributories have been described, been brought back into the ancient bed, than its flow diverged into a number of national currents, unequal in impetus and strength, and varying in accordance with their manifold surroundings. And even of these it is only possible to survey the most productive or important.

(a) Italy.

The priority in this as of most of the other aspects of the Renaissance belongs to Italy. In ultimate achievement the Italian drama fell short of the fulness of the results obtained elsewhere—a surprising fact when it is considered, not only that the Italian language had the vantage-ground of closest relationship to the Latin, but that the genius of the Italian people has at all times led it to love the drama. The cause is doubtless to be sought in the lack, noticeable in Italian national life during a long period, and more especially during the troubled days of division and strife coinciding with the rise and earlier promise of Italian dramatic literature, of those loftiest and most potent impulses of popular feeling to which a national drama owes so much of its strength. This deficiency was due partly to the peculiarities of the Italian

Pageants.

Influence of the Renaissance.

The modern Italian drama.

character, partly to the political and ecclesiastical experiences which Italy was fated to undergo. The Italians were alike strangers to the enthusiasm of patriotism, which was as the breath in the nostrils of the English Elizabethan age, and to the religious devotion which identified Spain with the spirit of the Catholic revival. The clear-sightedness of the Italians had something to do with this, for they were too intelligent to believe in their tyrants, and too free from illusions to deliver up their minds to their priests. Finally, the chilling and enervating effects of a pressure of foreign domination, such as no Western people with a history and a civilization like those of Italy has ever experienced, contributed to paralysing for many generations the higher efforts of the dramatic art. No basis was permanently found for a really national tragedy; while literary comedy, after turning from the direct imitation of Latin models to a more popular form, lost itself in an abandoned immorality of tone and in reckless insolence of invective against particular classes of society. Though its productivity long continued, the poetic drama more and more concentrated its efforts upon subordinate or subsidiary species, artificial in origin and decorative in purpose, and surrendered its substance to the overpowering aids of music, dancing and spectacle. Only a single form of the Italian drama, improvised comedy, remained truly national; and this was of its nature dissociated from higher literary effort. The revival of Italian tragedy in later times is due partly to the imitation of French models, partly to the endeavour of a brilliant genius to infuse into his art the historical and political spirit. Comedy likewise attained to new growths of considerable significance, when it was sought to accommodate its popular forms to the representation of real life in a wider range, and again to render it more poetical in accordance with the tendencies of modern romanticism.

The regular Italian drama, in both its tragic and its comic branches, began with a reproduction, in the Latin language, of classical models—the first step, as it was to prove, towards the transformation of the medieval into the modern drama, and the birth of modern dramatic literature. But the process was both tentative and tedious, and must have died away but for the pomp and circumstance with which some of the patrons of the Renaissance at Florence, Rome and elsewhere surrounded these manifestations of a fashionable taste, and for the patriotic inspiration which from the first induced Italian writers to dramatize themes of national historic interest. Greek tragedy had been long forgotten, and one or two indications in the earlier part of the 16th century of Italian interest in the Greek drama, chiefly due to the printing presses, may be passed by.¹ To the later middle ages classical tragedy meant Seneca, and even his plays remained unremembered till the study of them was revived by the Paduan judge Lovato de' Lovati (Lupatus, d. 1309). Of the comedies of Plautus three-fifths were not rediscovered till 1420; and though Terence was much read in the schools, he found no dramatic imitators, *pour le bon motif* or otherwise, since Hrosvitha.

Thus the first medieval follower of Seneca, Albertino Mussato (1261-1330) may in a sense be called the father of modern dramatic literature. Born at Padua, to which city all his services were given, he in 1315 brought out his *Eccerisina*, a Latin tragedy very near to the confines of epic poetry, intended to warn the Paduans against the designs of Can Grande della Scala by the example of the tyrant Ezzelino. Other tragedies of much the same type followed during the ensuing century; such as L. da Fabriano's *De casu Caesenas* (1377) a sort of chronicle history in Latin prose on Cardinal Albornoz' capture of Caesena.² Purely

¹ The *Xaeris rexus*, an artificial Byzantine product, probably of the 11th century, glorifying the Virgin in Euripidean verse, was not known to the Western world till 1542.

² Of G. Manzini della Motta's Latin tragedy on the fall of Antonio della Scala only a chorus remains. He died after 1389. Probably to the earlier half of the century belongs the Latin prose drama *Colamparnini*, the story of which, though it ends happily, resembles that of *The Cenci*. Later plays in Latin of the historic type are the extant Landivio de' Nobili's *De captivitate Ducis Jacobi* (the *condottiere* Jacopo Piccinino, d. 1464); C. Verardi's *Historia Baetica*

classical themes were treated in the *Achilleis* of A. de' Loschi of Vicenza (d. 1441), formerly attributed to Mussato, several passages of which are taken verbally from Seneca; in the celebrated *Progne* of the Venetian Gregorio Comaro, which is dated 1428-1429, and in later Latin productions included among the translations and imitations of Greek and Latin tragedies and comedies by Bishop Martinano (d. 1557), the friend of Pope Leo X.,³ and the efforts of Pomponius Laetus and his followers, who, with the aid of Cardinal Raffaele Riario (1451-1521), sought to revive the ancient theatre, with all its classical associations, at Rome.

In this general movement Latin comedy had quickly followed suit, and, as just indicated, it is almost impossible, when we reach the height of the Italian Renaissance under the Medici at Florence and at Rome in particular, to review the progress of either species apart from that of the other. If we possessed the lost *Philologia* of Petrarch, of which, as of a juvenile work, he declared himself ashamed, this would be the earliest of extant humanistic comedies. As it is, this position is held by *Passus*, a Latin comedy of life on the classic model, by the orthodox P. P. Vergerio (1370-1444); which was followed by many others.⁴

Early in the 16th century, tragedy began to be written in the native tongue; but it retained from the first, and never wholly lost, the impress of its origin. Whatever the source of its subjects—which, though mostly of classical origin, were occasionally derived from native romance, or even due to invention—they were all treated with a predilection for the horrible, inspired by the example of Seneca, though no doubt encouraged by a perennial national taste. The chorus, stationary on the stage as in old Roman tragedy, was not reduced to a merely occasional appearance between the acts till the beginning of the 17th century, or ousted altogether from the tragic drama till the earlier half of the 18th. Thus the changes undergone by Italian tragedy were for a long series of generations chiefly confined to the form of verification and the choice of themes; nor was it, at all events till the last century of the course which it has hitherto run, more than the aftergrowth of an aftergrowth. The honour of having been the earliest tragedy in Italian seems to belong to A. da Pistoia's *Pamfilo* (1490), of which the subject was taken from Boccaccio, introduced by the ghost of Seneca, and marred in the taking. Carretto's *Sofonisba*, which hardly rises above the art of a chronicle history, though provided with a chorus, followed in 1502. But the play usually associated with the beginning of Italian tragedy—that with which "the Italian scene first learned to glow"—was another *Sofonisba*, acted before Leo X. in 1515, and written in blank hendecasyllables instead of the *ottava* and *terza rima* of the earlier tragedians (retaining, however, the lyric measures of the chorus), by G. G. Trissino, who was employed as nuncio by that pope. Other tragedies of the former half of the 16th century, largely inspired by Trissino's example, were the *Rosmunda* of Rucellai, a nephew of Lorenzo the Magnificent (1516); Martelli's *Tullia*, Alamanni's *Antigone* (1532); the *Canace* of Sperone Speroni, the envious *Mopsus* of Tasso, who, like Guarini, took Sperone's elaborate style for his model; the

(the expulsion of the Moors from Granada) (1492), and the same author's *Faráinandus* (of Aragon) *Servatus*, which is called a tragedy-comedy because it is neither tragic nor comic. The Florentine L. Dall'i *Hemspad* (1441-1442) remains in MS. A few tragedies on sacred subjects were produced in Italy during the last quarter of the 15th century, and a little later. Such were the religious dramas written for his pupils by F. Domizio, on which Politian cast contempt; and the tragedies, following ancient models, of T. da Prato of Treviso, B. Campagna of Verona, *De passione Redemptoris*; and G. F. Conti, author of *Theandrotanasos* and numerous vanished plays.

³ *Imber aureus* (Danaë), &c.

⁴ L. Bruni's *Polissena* (c. 1395); Sacco Polentone's (1370-1463) jovial *Lusus ebriorum*; *De lege bibia*; the papal secretary P. Candido Decembrio's (1399-1477) non-extant *Aphrodita*; L. B. Alberti's *Philodoxos* (1424); Ugolino Pisani of Parma's (d. before 1462) *Philogenia* and *Confutatio copularia* (a merry student's play); the *Fraudiphila* of A. Tridentino, also of Parma, who died after 1470 and perhaps served Pius II.; Eneo Silvio de' Piccolomini's own verse comedy, *Christis*, likewise in MS., written in 1444; P. Domizio's *Lucina*, acted in the palace of Lorenzo de' Medici in 1478, &c.

Orazio, the earliest dramatic treatment of this famous subject by the notorious Aretino (1549); and the nine tragedies of G. B. Giraldi (Cinthio) of Ferrara, among which *L'Orbecche* (1541) is accounted the best and the bloodiest. Cinthio, the author of those *Heccatomitichi* to which Shakespeare was indebted for so many of his subjects, was (supposing him to have invented these) the first Italian who was the author of the fables of his own dramas; he introduced some novelties into dramatic construction, separating the prologue and probably also the epilogue from the action, and has by some been regarded as the inventor of the pastoral drama. But his style was arid. In the latter half of the 16th century may be mentioned the *Didone* and the *Marianna* of L. Dolce, the translator of Euripides and Seneca (1565); A. Leonico's *Il Soldato* (1550); the *Adriana* (acted before 1561 or 1586) of L. Groto, which treats the story of *Romeo and Juliet*; Tasso's *Torrismondo* (1587); the *Tancredi* of Asinari (1588); and the *Merope* of Torelli (1593), the last who employed the stationary chorus (*coro fisso*) on the Italian stage. Leonico's *Soldato* is noticeable as supposed to have given rise to the *tragedia cittadina*, or domestic tragedy, of which there are few examples in the Italian drama, and De Volo's *Tamar* (1586) as written in prose. Subjects of modern historical interest were in this period treated only in isolated instances.¹

The tragedians of the 17th century continued to pursue the beaten track, marked out already in the 16th by rigid prescription. In course of time, however, they sought by the introduction of musical airs to compromise with the danger with which their art was threatened of being (in Voltaire's phrase) extinguished by the beautiful monster, the opera, now rapidly gaining ground in the country of its origin. (See OPERA.) To Count P. Bonarelli (1589-1659), the author of *Soisimano*, is on the other hand ascribed the first disuse of the chorus in Italian tragedy. The innovation of the use of rhyme attempted in the learned Pallavicino's *Ermisigilde* (1655), and defended by him in a discourse prefixed to the play, was unable to achieve a permanent success in Italy any more than in England; its chief representative was afterwards Martelli (d. 1727), whose rhymed Alexandrian verse (*Martelliano*), though on one occasion used in comedy by Goldoni, failed to commend itself to the popular taste. By the end of the 17th century Italian tragedy seemed destined to expire, and the great tragic actor Cotta had withdrawn in disgust at the apathy of the public towards the higher forms of the drama. The 18th century was, however, to witness a change, the beginnings of which are attributed to the institution of the Academy of the Arcadians at Rome (1690). The principal efforts of the new school of writers and critics were directed to the abolition of the chorus, and to a general increase of freedom in treatment.

Before long the marquis S. Maffei with his *Merope* (first printed 1713) achieved one of the most brilliant successes recorded in the history of dramatic literature. This play, which is devoid of any love-story, long continued to be considered the masterpiece of Italian tragedy; Voltaire, who declared it "worthy of the most glorious days of Athens," adapted it for the French stage, and it inspired a celebrated production of the English drama.² It was followed by a tragedy full of horrors,³ noticeable as having given rise to the first Italian dramatic parody; and by the highly esteemed productions of Granelli (d. 1769) and his contemporary Bettinelli. P. T. Metastasio (1698-1782), who had early begun his career as a dramatist by a strict adherence to the precepts of Aristotle, gained celebrity by his contributions to the operatic drama at Naples, Venice and Vienna (where he held office as *poeta casareo*, whose function was to arrange the court entertainments). But his *libretti* have a poetic value of their own;⁴ and Voltaire pronounced much of him worthy of Corneille and of Racine, when at their best. The influence of Voltaire had now come to predominate over the Italian drama; and, in accordance

with the spirit of the times, greater freedom prevailed in the choice of tragic themes. Thus the greatest of Italian tragic poets, Count V. Alfieri (1749-1803), found his path prepared for him. Alfieri's grand and impassioned treatment of his subjects caused his faultiness of form, which he never altogether overcame, to be forgotten. His themes were partly classical;⁵ but the spirit of a love of freedom which his creations breathe was the herald of the national ideas of the future. Spurning the usages of French tragedy, his plays, which abound in soliloquies, owe part of their effect to an impassioned force of declamation, part to those "points" by which Italian acting seems pre-eminently capable of thrilling an audience. He has much besides the subjects of two of his dramas⁶ in common with Schiller, but his amazon-muse (as Schlegel called her) was not schooled into serenity, like the muse of the German poet. Among his numerous plays (21), *Merope* and *Sosa*, and perhaps *Mirra*, are accounted his masterpieces.

The political colouring given by Alfieri to Italian tragedy reappears in the plays of U. Foscolo and A. Manzoni, both of whom are under the influence of the romantic school of modern literature; and to these names must be added those of S. Pellico and G. B. Niccolini (1785-1861), Paolo Giacometti (b. 1816) and others, whose dramas⁷ treat largely national themes familiar to all students of modern history and literature. In their hands Italian tragedy upon the whole adhered to its love of strong situations and passionate declamation. Since the successful efforts of G. Modena (1804-1861) renovated the tragic stage in Italy, the art of tragic acting long stood at a higher level in this than in almost any other European country; in Adelaide Ristori (Marchesa del Grillo) the tragic stage lost one of the greatest of modern actresses; and Ernesto Rossi (1827-1896) and Tommaso Salvini long remained rivals in the noblest forms of tragedy.

In comedy, the efforts of the scholars of the Italian Renaissance for a time went side by side with the progress of the popular entertainments noticed above. While the *contrasti* of the close of the 15th and of the 16th century were disputations between pairs of abstract or allegorical figures, in the *frottole* human types take the place of abstractions, and more than two characters appear. The *farsa* (a name used of a wide variety of entertainments) was still under medieval influences, and in this popular form Alione of Asti (soon after 1500) was specially productive. To these popular diversions a new literary as well as social significance was given by the Neapolitan court-poet Sannazaro (c. 1492); about the same time a *capitano valoroso*, Venturino of Pesara, first brought on the modern stage the *capitano glorioso* or *spavento*, the military braggart, who owed his origin both to Plautus⁸ and to the Spanish officers who abounded in the Italy of those days. The popular character-comedy, a relic of the ancient *Atellanes*, likewise took a new lease of life—and this in a double form. The *improvised comedy* (*commedia a soggetto*) was now as a rule performed by professional actors, members of a *craft*, and was thence called the *commedia dell'arte*, which is said to have been invented by Francesco (called Terenziano) Chereia, the favourite player of Leo X. Its scenes, still unwritten except in skeleton (*scenario*), were connected together by the ligatures or links (*lazzi*) of the *arlechino*, the descendant of the ancient Roman *sonnio* (whence our *sonny*). Harlequin's summit of glory was probably reached early in the 17th century, when he was ennobled in the person of Cecchino by the emperor Matthias; of Cecchino's successors, Zaccagnino and Truffaldino, we read that "they shut the door in Italy to good harlequins." Distinct from this growth is that of the *masked comedy*, the action of which was chiefly carried on by certain

¹ Mondella, *Isifile* (1582); Fuligni, *Bragadino* (1589).

² Home, *Douglas*.

³ Lazzaroni, *Ulisse il giovane* (1719).

⁴ *Didone abbandonata*, *Siroe*, *Semiramide*, *Artaserse*, *Demetris*, &c.

⁵ *Cleopatra*, *Antigone*, *Octavia*, *Mirope*, &c.

⁶ e.g. *Bruto I.* and *II.*

⁷ Filippo, *Maria Stuarda*.

⁸ Pellico, *Francesca da Rimini*; Niccolini, *Giovanni da Procida*; *Beatrice Cenci*; Giacometti, *Cola di Rienzi* (Giacometti's masterpiece was *La Morte civile*).

⁹ Pyrogopolinices in the *Miles Gloriosus*.

typical figures in masks, speaking in local dialects,¹ but which was not improvised, and indeed from the nature of the case hardly could have been. Its inventor was A. Beolco of Padua, who called himself Ruzzante (joker), and is memorable under that name as the first actor-playwright—a combination of extreme significance for the history of the modern stage. He published six comedies in various dialects, including the Greek of the day (1530). This was the masked comedy to which the Italians so tenaciously clung, and in which, as all their own and imitable by no other nation, they took so great a pride that even Goldoni was unable to overthrow it. Improvisation and burlesque, alike abominable to comedy proper, were inseparable from the species.

Meanwhile, the Latin imitations of Roman, varied by occasional translations of Greek, comedies early led to the production of Italian translations, several of which were performed at Ferrara in the last quarter of the 15th century, whence they spread to Milan, Pavia and other towns of the north. Contemporaneously, imitations of Latin comedy made their appearance, for the most part in rhymed verse; most of them applying classical treatment to subjects derived from Boccaccio's and other *novelle*, some still mere adaptations of ancient models. In these circumstances it is all but idle to assign the honour of having been "the first Italian comedy"—and thus the first comedy in modern dramatic literature—to any particular play. Boiardo's *Timone* (before 1494), for which this distinction was frequently claimed, is to a large extent founded on a dialogue of Lucian's; and, since some of its personages are abstractions, and Olympus is domesticated on an upper stage, it cannot be regarded as more than a transition from the moralities. A. Ricci's *I Tre Tiranni* (before 1530) seems still to belong to the same transitional species. Among the earlier imitators of Latin comedy in the vernacular may be noted G. Visconti, one of the poets patronized by Ludovico il Moro at Milan;² the Florentines G. B. Araldo, J. Nardi, the historian,³ and D. Gianotti.⁴ The step—very important had it been adopted consistently or with a view to consistency—of substituting prose for verse as the diction of comedy, is sometimes attributed to Ariosto; but, though his first two comedies were originally written in prose, the experiment was not new, nor did he persist in its adoption. Caretto's *I Sei Contenti* dates from the end of the 15th century, and Publio Filippo's *Formicone*, taken from Apuleius, followed quite early in the 16th. Machiavelli, as will be seen, wrote comedies both in prose and in verse.

But, whoever wrote the first Italian comedy, Ludovico Ariosto was the first master of the species. All but the first two of his comedies, belonging as they do to the field of *commedia erudita*, or scholarly comedy, are in blank verse, to which he gave a singular mobility by the dactylic ending of the line (*sdruciolato*). Ariosto's models were the masterpieces of the *palliate*, and his morals those of his age, which emulated those of the worst days of ancient Rome or Byzantium in looseness, and surpassed them in effrontery. He chose his subjects accordingly; but his dramatic genius displayed itself in the effective drawing of character,⁵ and more especially in the skilful management of complicated intrigues.⁶ Such, with an additional brilliancy of wit and lasciviousness of tone, are likewise the characteristics of Machiavelli's famous prose comedy, the *Mandragola* (*The*

Magic Draught);⁷ and at the height of their success, of the plays of P. Aretino,⁸ especially the prose *Marescalco* (1526-1527) whose name, it has been said, ought to be written in asterisks. It may be added that the plays of Ariosto and his followers were represented with magnificent scenery and settings. Other dramatists of the 16th century were B. Accolti, whose *Virginia* (prob. before 1513) treats the story from Boccaccio which reappears in *All's Well that Ends Well*; G. Cecchi, F. d'Ambrà, A. F. Grazzini, N. Secco or Secchi and L. Dolce—all writers of romantic comedy of intrigue in verse or prose.

During the same century the "pastoral drama" flourished in Italy. The origin of this peculiar species—which was the bucolic idyll in a dramatic form, and which freely lent itself to the introduction of both mythological and allegorical elements—was purely literary, and arose directly out of the classical studies and tastes of the Renaissance. It was very far removed from the genuine peasant plays which flourished in Venetia and Tuscany early in the 16th century. The earliest example of the artificial, but in some of its productions exquisite, growth in question was the renowned scholar A. Politian's *Orfeo* (1472), which begins like an idyll and ends like a tragedy. Intended to be performed with music—for the pastoral drama is the parent of the opera—this beautiful work tells its story simply. N. da Correggio's (1450-1508) *Cefalo*, or *Aurora*, and others followed, before in 1554 A. Beccari produced, as totally new of its kind, his Arcadian pastoral drama *Il Saggiato*, in which the comic element predominates. But an epoch in the history of the species is marked by the *Aminta* of Tasso (1573), in whose Arcadia is allegorically mirrored the Ferrara court. Adorned by choral lyrics of great beauty, it presents an allegorical treatment of a social and moral problem; and since the conception of the characters, all of whom think and speak of nothing but love, is artificial, the charm of the poem lies not in the interest of its action, but in the passion and sweetness of its sentiment. This work was the model of many others, and the pastoral drama reached its height of popularity in the famous *Pastor fido* (written before 1590) of G. B. Guarini, which, while founded on a tragic love-story, introduces into its complicated plot a comic element, partly with a satirical intention. It is one of those exceptional works which, by circumstance as well as by merit, have become the property of the world's literature at large. Thus, both in Italian and in other literatures, the pastoral drama became a distinct species, characterized, like the great body of modern pastoral poetry in general, by a tendency either towards the artificial or towards the burlesque. Its artificiality affected the entire growth of Italian comedy, including the *commedia dell'arte*, and impressed itself in an intensified form upon the opera. The foremost Italian masters of the last-named species, so far as it can claim to be included in the poetic drama, were A. Zeno (1668-1750) and P. Metastasio.

The comic dramatists of the 17th century are grouped as followers of the classical and of the romantic school. G. B. della Porta (q.v.) and G. A. Cicognini (whom Goldoni *Comedy in* describes as full of whining pathos and commonplace the 17th and 18th centuries.) being regarded as the leading representatives of the former. But neither of these largely intermixed groups of writers could, with all its fertility, prevail against the competition, on the one hand of the musical drama, and on the other of the popular farcical entertainments and those introduced in imitation of Spanish examples. Italian comedy had fallen into decay, when its reform was undertaken by the wonderful theatrical genius of C. Goldoni. One of the most fertile and rapid of playwrights (of his 150 comedies *Goldoni* 16 were written and acted in a single year), he at the same time pursued definite aims as a dramatist. Disgusted with the conventional buffoonery, and ashamed of the rampant

¹ The masked characters, each of which spoke the dialect of the place he represented, were (according to Baretto) *Pantalone*, a Venetian merchant; *Dottore*, a Bolognese physician; *Spaviento*, a Neapolitan braggadocio; *Pullucchinella*, a wag of Apulia; *Giangurgolo* and *Coriello*, clowns of Calabria; *Gelfomino*, a Roman beau; *Brighella*, a Ferrarese pimp; and *Arlecchino*, a blundering servant of Bergamo. Besides these and a few other such personages (of whom four at least appeared in each play), there were the *Amorosos* or *Innamoratos*, men or women (the latter not before 1560, up to which time actresses were unknown in Italy) with serious parts, and *Smeraldina*, *Colombina*, *Spilletta*, and other *servettas* or waiting-maids. All these spoke Tuscan or Roman, and wore no masks.

² *Parites*.

³ *Amicizia*.

⁴ *Miseria*.

⁵ *La Lena*; *Il Negromante*. ⁶ *La Casaria*; *I Suppositi*.

⁷ Of Machiavelli's other comedies, two are prose adaptations from Plautus and Terence, *La Cistia* (Casina) and *Andria*; of the two others, simply called *Comédie*, and in verse, his authorship seems doubtful.

⁸ *La Cortigiana*, *La Talanta*, *Il Ippocrito*, *Il Filosofo*.

The
pastoral
drama.

Comedy in
the 17th
and 18th
centuries.

Goldoni.

immorality of the Italian comic stage, he drew his characters from real life, whether of his native city (Venice)¹ or of society at large, and sought to enforce virtuous and pathetic sentiments without neglecting the essential objects of his art. Happy and various in his choice of themes, and dipping deep into a popular life with which he had a genuine sympathy, he produced, besides comedies of general human character,² plays on subjects drawn from literary biography³ or from fiction.⁴ Goldoni, whose style was considered defective by the purists whom Italy has at no time lacked, met with a severe critic and a temporarily successful rival in Count C. Gozzi (1722-1806), who sought to *Gozzi* rescue the comic drama from its association with the actual life of the middle classes, and to infuse a new spirit into the figures of the old masked comedy by the invention of a new species. His themes were taken from Neapolitan⁵ and Oriental⁶ fairy tales, to which he accommodated some of the standing figures upon which Goldoni had made war. This attempt at mingling fancy and humour—occasionally of a directly satirical turn⁷—was in harmony with the tendencies of the modern romantic school; and Gozzi's efforts, which though successful found hardly any imitators in Italy, have a family resemblance to those of Tieck and of some more recent writers whose art wings its flight, through the windows, "over the hills and far away."

During the latter part of the 18th and the early years of the 19th century comedy continued to follow the course marked out by its acknowledged master Goldoni, under the influence of the sentimental drama of France and other countries. Abati Andrea Villi, the marquis Albergati Capacelli, Antonio Simone Sografi (1760-1825), Federici, and Pietro Napoli Signorelli (1731-1815), the historian of the drama, are mentioned among the writers of this school; to the 19th century belong Count Giraud, Marchisio (who took his subjects especially from commercial life), and Nota, a fertile writer, among whose plays are three treating the lives of poets. Of still more recent date are L. B. Bon and A. Brofferio. At the same time, the comedy of dialect to which the example of Goldoni had given sanction in Venice, flourished there as well as in the mutually remote spheres of Piedmont and Naples. Quite modern developments must remain unnoticed here; but the fact cannot be ignored that they signally illustrate the perennial vitality of the modern drama in the home of its beginnings. A new realistic style set fully in about the middle of the 18th century with P. Ferrari and A. Torelli; and though an historical reaction towards classical and medieval themes is associated with the names of P. Cossa and G. Giacosa, modernism reasserted itself through P. Bracco and other dramatists. It should be noted that the influence of great actors, more especially Ermete Novelli and Eleanora Duse, must be credited with a large share of the success with which the Italian stage has held its own even against the foreign influences to which it gave room. And it would seem as if even the paradoxical endeavour of the poet Gabrielle d'Annunzio to lyricize the drama by ignoring action as its essence were a problem for the solution of which the stage can furnish unexpected conditions of its own. In any event, both Italian tragedy and Italian comedy have survived periods of a seemingly hopeless decline; and the fear has vanished that either the opera or the ballet might succeed in ousting from the national stage the legitimate forms of the national drama.

¹ *Momolo Cortesano* (*Jerome the Accomplished Man*); *La Bottega del caffè*, &c.

² *La Vedova scaltra* (*The Cunning Widow*); *La Putta onorata* (*The Respectable Girl*); *La Buona Figlia*; *La B. Sposa*; *La B. Famiglia*; *La B. Madre* (the last of which was unsuccessful; "goodness," says Goldoni, "never displeases, but the public weary of every thing"), &c.; and *Il Burbero benefico*, called in its original French version *Le Bourru bienfaisant*.

³ *Molière*; *Terenzio*; *Tasso*.

⁴ *Pamelo*; *Pamela Mariata*; *Il Filosofo Inglese* (*Mr Spectator*).

⁵ *L' Amore delle tre malarancie* (*The Three Lemons*); *Il Corvo*.

⁶ *Turandot*; *Zobeide*.

⁷ *L' Amore delle tre m.* (against Goldoni); *L' Angellino Belverde* (*The Small Green Bird*), (against Helvetius, Rousseau and Voltaire).

(b) Greece.

The dramatic literature of the later Hellenes is a creation of the literary movement which preceded their noble struggle for independence, or which may be said to form part of that struggle. After beginning with dramatic dialogues of a patriotic tendency, it took a step in advance with the tragedies of J. R. Nerulos¹ (1778-1850), whose name belongs to the political as well as to the literary history of his country. His comedies—especially one directed against the excesses of journalism²—largely contributed to open a literary life for the modern Greek tongue. Among the earlier patriotic Greek dramatists of the 19th century are T. Alkaios, J. Zampelios (whose tragic style was influenced by that of Alfieri),³ S. K. Karydis and A. Valaoritis. A. Zoïros⁴ is noteworthy as having introduced the use of prose into Greek tragedy, while preserving to it that association with sentiments and aspirations which will probably long continue to pervade the chief productions of modern Greek literature. The love of the theatre is ineradicable from Attic as it is from Italian soil; and the tendencies of the young dramatic literature of Hellas which is not wholly absorbed in the effort to keep abreast of recent modern developments, seem to justify the hope that a worthy future awaits it.

Under Italian influence an interesting dramatic growth attained to some vitality in the Dalmatian lands about the beginning of the 16th century, where the religious drama, whose days were passing away in Italy, found favour with a people with a scant popular literature of its own. At Ragusa Italian literary influence had been spread by the followers of Petrarch from the later years of the 15th century; here several Servo-Croatian writers produced religious plays in the manner of the Italian *rappresentazioni*; and a gifted poet, Martin Držić, composed, besides religious plays and farces, a species of pastoral which enjoyed much favour.

(c) Spain.

Spain is the only country of modern Europe which shares with England the honour of having achieved, at a relatively early date, the creation of a genuinely national form of the regular drama. So proper to Spain was the form of the drama which she produced and perfected, that to it the term *romantic* has been specifically applied, though so restricted a use of the epithet is clearly unjustifiable. The influences which from the Romance peoples—in whom Christian and Germanic elements mingled with the legacy of Roman law, learning and culture—spread to the Germanic nations were represented with the most signal force and fullness in the institutions of chivalry,—to which, in the words of Scott, "it was peculiar to blend military valour with the strongest passions which actuate the human mind, the feelings of devotion and those of love." These feelings, in their combined operation upon the national character, and in their reflection in the national literature, were not confined to Spain; but nowhere did they so long or so late continue to animate the moral life of a nation.

Outward causes contributed to this result. For centuries after the crusades had become a mere memory, Spain was a battle-ground between the Cross and the Crescent. And it was just at the time when the Renaissance was establishing new starting-points for the literary progress of Europe, that Christian Spain rose to the height of Catholic as well as national self-consciousness by the expulsion of the Moors and the conquest of the New World. From their rulers or rivals of so many centuries the Spaniards derived that rich, if not very varied, glow of colour which became permanently distinctive of their national life, and more especially of its literary and artistic

¹ *Aspasia*; *Polysena*.

² *Ephemeridophobos*.

³ *Timoleon*; *Konstantinos Palaeologos*; *Rhigas of Pheras*.

⁴ *The Thres Hundred*, or *The Character of the Ancient Hellenes* (*Leonidas*); *The Death of the Orator* (*Demosthenes*); *A Scion of Timoleon*, &c.

expressions; they also perhaps derived from the same source a not less characteristically refined treatment of the passion of love. The ideas of Spanish chivalry—more especially religious devotion and a punctilious sense of personal honour—asserted themselves (according to a process often observable in the history of civilization) with peculiar distinctness in literature and art, after the period of great achievements to which they had contributed in other fields had come to an end. The ripest glories of the Spanish drama belong to an age of national decay—mindful, it is true, of the ideas of a greater past. The chivalrous enthusiasm pervading so many of the masterpieces of its literature is indeed a distinctive feature of the Spanish nation in all, even in the least hopeful, periods of its later history; and the religious ardour breathed by these works, though associating itself with what is called the Catholic Reaction, is in truth only a manifestation of the spirit which informed the noblest part of the Reformation movement itself. The Spanish drama neither sought nor could seek to emancipate itself from views and forms of religious life more than ever sacred to the Spanish people since the glorious days of Ferdinand and Isabella; and it is not so much in the beginnings as in the great age of Spanish dramatic literature that it seems most difficult to distinguish between what is to be termed a religious and what a secular play. After Spain had thus, the first after England among modern European countries, fully unfolded that incomparably richest expression of national life and sentiment in an artistic form—a truly national dramatic literature,—the terrible decay of her greatness and prosperity gradually impaired the strength of a brilliant but, of its nature, dependent growth. In the absence of high original genius the Spanish dramatists began to turn to foreign models, though little supported in such attempts by popular sympathy; and it is only in more recent times that the Spanish drama has sought to reproduce the ancient forms from whose masterpieces the nation had never become estranged, while accommodating them to tastes and tendencies shared by later Spanish literature with that of Europe at large.

The earlier dramatic efforts of Spanish literature may without inconvenience be briefly dismissed. The reputed author of the

Early efforts.

Coplas de Mingo Revulgo (R. Cota the elder) likewise composed the first act of a story of intrigue and character, purely dramatic but not intended for representation. This tragic comedy of *Calisto and Meliboea*, which was completed (in 21 acts) by 1499, afterwards became famous under the name of *Celestino*; it was frequently imitated and translated, and was adapted for the Spanish stage by R. de Zepeda in 1582. But the father of the Spanish drama was J. de la Encina, whose *representaciones* under the name of "eclogues" were dramatic dialogues of a religious or pastoral character. His attempts were imitated more especially by the Portuguese

On Vicente.

Gil Vicente, whose writings for the stage appear to be included in the period 1502-1536, and who wrote both in Spanish and in his native tongue. A further impulse came, as was natural, from Spaniards resident in Italy, and especially from B. de Torres Naharro, who in 1517 published, as the chief among the "firstlings of his genius" (*Propaladia*), a series of eight *comedias*—a term generally applied in Spanish literature to any kind of drama. He claimed some knowledge of the theory of the ancient drama, divided his plays into *jornadas*¹ (to correspond to acts), and opened them with an *introyto* (prologue). Very various in their subjects, and occasionally odd in form,² they were gross as well as audacious in tone, and were soon prohibited by the Inquisition. The church remained unwilling to renounce her control over such dramatic exhibitions as she permitted, and sought to suppress the few plays on not strictly religious subjects which appeared in the early part of the reign of Charles I. Though the universities produced both translations from the classical drama and modern Latin plays,

these exercised very little general effect. Juan Perez' (*Petretius*) posthumous Latin comedies were mainly versions of Ariosto.³

Thus the foundation of the Spanish national theatre was reserved for a man of the people. Cervantes has vividly sketched the humble resources which were at the command of *Lope de Rueda and his followers.* Lope de Rueda, a mechanic of Seville, who with his friend the bookseller Timoneda, and two brother authors and actors in his strolling company, succeeded

in bringing dramatic entertainments out of the churches and palaces into the public places of the towns, where they were produced on temporary scaffolds. The manager carried about his properties in a corn-sack; and the "comedies" were still only "dialogues, and a species of eclogues between two or three shepherds and a shepherdess," enlivened at times by intermezcos of favourite comic figures, such as the negress or the Biscayan, "played with inconceivable talent and truthfulness by Lope." One of his plays at least,⁴ and one of Timoneda's,⁵ seem to have been taken from an Italian source; others mingled modern themes with classical apparitions,⁶ one of Timoneda's was (perhaps again through the Italian) from Plautus.⁷ Others of a slighter description were called *pasos*,—a species afterwards termed *entremeses* and resembling the modern French *proverbes*. With these popular efforts of Lope de Rueda and his friends a considerable dramatic activity began in the years 1560-1590 in several Spanish cities, and before the close of this period permanent theatres began to be fitted up at Madrid. Yet Spanish dramatic literature might still have been led to follow Italian into an imitation of classical models. *Classical dramas.*

Two plays by G. Bermudez (1577), called by their learned author "the first Spanish tragedies," treating the national subject of Inez de Castro, but divided into five acts, composed in various metres, and introducing a chorus; *Dido* (c. 1580) by C. de Virues (who claimed to have first divided dramas into three *jornadas*); and the tragedies of L. L. de Argensola (acted 1585, and praised in *Don Quixote*) alike represent this tendency.

Such were the alternatives which had opened for the Spanish drama, when at last, about the same time as that of the English, its future was determined by writers of original genius. *Cervantes.*

The first of these was the immortal Cervantes, who, however, failed to anticipate by his earlier plays (1584-1588) the great (though to him unproductive) success of his famous romance. In his endeavour to give a poetic character to the drama he fell upon the expedient of introducing personified abstractions speaking a "divine" or elevated language—a device which was for a time favourably received. But these plays exhibit a neglect or ignorance of the laws of dramatic construction; their action is episodic; and it is from the realism of these episodes (especially in the *Nuñancia*, which is crowded with both figures and incidents), and from the power and flow of the declamation, that their effect must have been derived. When in his later years (1615) Cervantes returned to dramatic composition, the style and form of the national drama had been definitively settled by a large number of writers, the brilliant success of whose acknowledged chief may previously have diverted Cervantes from his labours for the theatre. His influence upon the general progress of dramatic literature is, however, to be sought, not only in his plays, but also in those *novelas exemplares*—incomparable alike in their clearness and their terseness of narrative—to which more than one drama is indebted for its plot, and for much of its dialogue to boot.

Lope de Vega, one of the most astonishing geniuses the world has known, permanently established the national forms of the Spanish drama. Some of these were in their beginnings taken over by him from ruder predecessors; some were cultivated with equal or even superior success by subsequent authors; but in variety, as in fertility of dramatic production, he has no rivals. His fertility, which was such that he wrote about 1500 plays, besides 300 dramatic works classed

Lope de Vega.

¹ The term is the same as that used in the old French collective mysteries (*journees*).

² In some of his plays (*Comedia Serafina; C. Tinalaria*) there is a mixture of languages even stranger than that of dialects in the Italian masked comedy.

³ *Necromanticus, Lena, Decepti, Suppositi.*

⁴ *Los Engaños (Gli Ingananti).* ⁵ *Cornelia (II Negromante).*

⁶ *Lope, Armolina (Medea and Neptune as deus ex machina—i modo machina adjuisset).* ⁷ *Menenos.*

as *autos sacramentales* and *entremeses*, and a vast series of other literary compositions, has indisputably prejudiced his reputation with those to whom he is but a name and a number. Yet as a dramatist Lope more fully exemplifies the capabilities of the Spanish theatre than any of his successors, though as a poet Calderon may deserve the palm. Nor would it be possible to imagine a truer representative of the Spain of his age than a poet who, after suffering the hardships of poverty and exile, and the pangs of passion, sailed against the foes of the faith in the Invincible Armada, subsequently became a member of the Holy Inquisition and of the order of St Francis, and after having been decorated by the pope with the cross of Malta and a theological doctorate, honoured by the nobility, and idolized by the nation, ended with the names of Jesus and Mary on his lips. From the plays of such a writer we may best learn the manners and the sentiments, the ideas of religion and honour, of the Spain of the Philippine age, the age when she was most prominent in the eyes of Europe and most glorious in her own. For, with all its inventiveness and vigour, the genius of Lope primarily set itself the task of pleasing his public,—the very spirit of whose inner as well as outer life is accordingly mirrored in his dramatic works. In them we have, in the words of Lope's French translator Baret, "the movement, the clamour, the conflict of unforeseen intrigues suitable to unreflecting spectators; perpetual flatteries addressed to an unextinguishable national pride; the painting of passions dear to a people never tired of admiring itself; the absolute sway of the point of honour; the deification of revenge; the adoration of symbols; buffoonery and burlesque, everywhere beloved of the multitude, but here never defiled by obscenities, for this people has a sense of delicacy, and the foundation of its character is nobility; lastly, the flow of proverbs which at times escape from the *gracioso*" (the comic servant domesticated in the Spanish drama by Lope)—"the commonplace literature of those who possess no other."

The plays of Lope, and those of the national Spanish drama in general, are divided into classes which it is naturally not always easy, and which there is no reason to suppose him always to have intended, to keep distinct from one another. After in his early youth composing eclogues, pastoral plays, and allegorical moralities in the old style, he began his theatrical activity at Madrid about 1590, and the plays which he thenceforth produced have been distributed under the following heads. The *comedias*, all of which are in verse, include (1) the so-called *c. de capa y espada*—not comedies proper, but dramas in which the principal personages are taken from the class of society that wears cloak and sword. Gallantry is their main theme, an interesting and complicated, but well-constructed and perspicuous intrigue their chief feature; and this is usually accompanied by an underplot in which the *gracioso* plays his part. Their titles are frequently taken from the old proverbs or proverbial phrases of the people¹ upon the theme suggested, by which the plays often (as G. H. Lewes admirably expresses it) constitute a kind of gloss (*glosa*) in action. This is the favourite species of the national Spanish theatre; and to the plots of the plays belonging to it the drama of other nations owes a debt almost incalculable in extent.

(2) The *c. heroicas* are distinguished by some of their personages being of royal or very high rank, and by their themes being often historical and largely² (though not invariably³) taken from the national annals, or founded on contemporary or recent events.⁴ Hence they exhibit a greater gravity of tone; but in other respects there is no difference between them and the cloak-and-sword comedies with which they share the element of comic underplots. Occasionally Lope descended in the opposite direction, to (3) plays of which the scene is laid in common life, but for which no special name appears

to have existed.⁵ Meanwhile, both he and his successors were too devoted sons of the church not to acknowledge in some sort her claim to influence the national drama. This claim she had never relinquished, even when she could no longer retain an absolute control over the stage. For a time, indeed, she was able to reassert even this; for the exhibition of all secular plays was in 1598 prohibited by the dying Philip II., and remained so for two years; and Lope with his usual facility proceeded to supply religious plays of various kinds. After a few dramas on scriptural subjects he turned to the legends of the saints; and the *comedias de santos*, of which he wrote a great number, became an accepted later Spanish variety of the miracle-play. True, however, to the popular instincts of his genius, he threw himself with special zeal and success into the composition of another kind of religious plays—a development of the Corpus Christi pageants, in honour of which all the theatres had to close their doors for a month. These were the famous *autos sacramentales* (i.e. solemn "acts" or proceedings in honour of the Sacrament), which were performed in the open air by actors who had filled the cars of the sacred procession. Of these Lope wrote about 400. These entertainments were arranged on a fixed scheme, comprising a prologue in dialogue between two or more actors in character (*loa*), a farce (*entremes*), and the *auto* proper, an allegorical scene of religious purport, as an example of which Ticknor cites the *Bridge of the World*,—in which the Prince of Darkness in vain seeks to defend the bridge against the Knight of the Cross, who finally leads the Soul of Man in triumph across it. Not all the *entremeses* of Lope and others were, however, composed for insertion in these *autos*. This long-lived popular species, together with the old kind of dramatic dialogue called *eclogues*, completes the list of the varieties of his dramatic works.

The example of Lope was followed by a large number of writers, and Spain thus rapidly became possessed of a dramatic literature almost unparalleled in quantity—for in fertility also Lope was but the first among many. Among the writers of Lope's school, his friend G. de Castro (1569–1631) must not be passed by, for his *Cid*⁶ was the basis of Corneille's; nor J. P. de Montalban, "the first-born of Lope's genius," the extravagance of whose imagination, like that of Lee, culminated in madness. Soon after him died (1639) Juan Ruiz de Alarcon, in whose plays, as contrasted with those of Lope; has been recognized the distinctive element of a moral purpose. To G. Tellez, called Tirso de Molina (d. 1648), no similar praise seems due; but the frivolous gaiety of the inventor of the complete character of Don Juan was accompanied by ingenuity in the construction of his excellent⁷ though at times "sensational"⁸ plots. F. de Rojas Zorrilla (b. 1607), who was largely plundered by the French dramatists of the latter half of the century, survived Molina for about a generation. In vain scholars of strictly classical tastes protested in essays in prose and verse against the ascendancy of the popular drama; the prohibition of Philip II. had been recalled two years after his death and was never renewed; and the activity of the theatre spread through the towns and villages of the land, everywhere under the controlling influence of the school of writers who had established so complete a harmony between the drama and the tastes and tendencies of the people.

The glories of Spanish dramatic literature reached their height in P. Calderon de la Barca, though in the history of the Spanish theatre he holds only the second place. He elaborated some of the forms of the national drama, but brought about no changes of moment in any of them. Even the brilliancy of his style, glittering with a constant reproduction of the same family of tropes, and the variety of his melodious versification, are mere intensifications of the poetic qualities of Lope, while

¹ *El Asero de Madrid* (The Stead Water of Madrid); *Dineros son Calidad* (= The Dog in the Manger), &c.

² *La Estrella de Sevilla* (The Star of Seville, i.e. Sancho the Brave); *El Nuevo Mundo* (Columbus), &c.

³ *Roma Abrassada* (R. in Ashes—Nero).

⁴ *Arauco domado* (The Conquest of Arauco, 1560).

⁵ *La Moza de cantaro* (The Water-maid).

⁶ *Las Mocedades* (The Youthful Adornments) del Cid.

⁷ *Don Gil de las calzas verdes* (D. G. in the Green Breeches).

⁸ *El Burlador de Sevilla y Comediante de piedra* (The Deceiver of Seville, i.e. Don Juan, and the Stone Guest).

in their moral and religious sentiments, and their general views of history and society, there is no difference between the two. Like Lope, Calderon was a soldier in his youth and an ecclesiastic in his later years; like his senior, he suited himself to the tastes of both court and people, and applied his genius with equal facility to the treatment of religious and of secular themes. In fertility Calderon was inferior to Lope (for he wrote not many more than 100 plays); but he surpasses the elder poet in richness of style, and more especially in fire of imagination. In his *autos* (of which he is said to have left not less than 73), Calderon probably attained to his most distinctive excellence; some of these appear to take a wide range of allegorical invention,¹ while they uniformly possess great beauty of poetical detail. Other of his most famous or interesting pieces are *comedias de santos*.² In his secular plays he treats as wide a variety of subjects as Lope, but it is not a dissimilar variety; nor would it be easy to decide whether a poet so uniformly admirable within his limits has achieved greater success in romantic historical tragedy,³ in the comedy of amorous intrigue,⁴ or in a dramatic work combining fancy and artificiality in such a degree that it has been diversely described as a romantic caprice and as a philosophical poem.⁵

During the life of the second great master of the Spanish drama there was little apparent abatement in the productivity of its literature; while the *autos* continued to flourish in Madrid and elsewhere, till in 1765 (shortly before the expulsion of the Jesuits from Spain) their public representation was prohibited by royal decree. In the world of fashion, the opera had reached Spain already during Calderon's lifetime, together with other French influences, and the great dramatist had himself written one or two of his plays for performance with music. But the regular national

drama continued to command popular favour, and with A. Moreto may be said to have actually taken a step in advance. While he wrote in all the forms established by Lope and cultivated by Calderon, his manner seems most nearly to approach the masterpieces of French and later English comedy of character; he was the earliest writer of the *comedias de figura*, in which the most prominent personage is (in Congreve's phrase) "a character of affection," in other words, the Spanish *top of real life*.⁶ His masterpiece, a favourite of many stages, is one of the most graceful and pleasing of modern comedies—simple but interesting in plot, and true to nature, with something like Shakespearian truth.⁷ Other writers trod more closely in the footsteps of the masters without effecting any noticeable changes in the form of the Spanish drama; even the *saynete* (tit-bit), which owes its name to Benavente (fl. 1645), was only a kind of *entremes*. The Spanish drama in all its forms retained its command over the nation, because they were alike popular in origin and character; nor is there any other example of so complete an adaptation of a national art to the national taste and sentiment in its ethics and aesthetics, in the nature of the plots of the plays (whatever their origin), in the motives of their actions, in the conduct and tone and in the very costume of their characters.

National as it was, and because of this very quality, the Spanish drama was fated to share the lot of the people it so fully represented. At the end of the 17th century, when the Spanish throne at last became the declared apple of discord among the governments of Europe, the Spanish people lay, in the words of an historian of its later days, "like a corpse, incapable of feeling its own impotence." That national art to which it had so faithfully clung had fallen into decline and decay with the spirit of Spain itself. By the time of the close of the great war, the theatre had sunk into a mere amusement of the populace, which during the greater part

of the 18th century, while allowing the old masters the measure of favour which accords with traditional esteem, continued to uphold the representatives of the old drama in its degeneracy—authors on the level of their audiences. But the Spanish court was now French, and in the drama, even more than in any other form of art, France was the arbiter of taste in Europe. With the restoration of peace accordingly began isolated attempts to impose the French canons of dramatic theory, and to follow the example of French dramatic practice; and in the middle of the century these endeavours assumed more definite form. Montiano's bloodless tragedy of *Virginia* (1750), which was never acted, was accompanied by a discourse endeavouring to reconcile the doctrines of the author with the practice of the old Spanish dramatists; the play itself was in blank verse (a metre never used by Calderon, though occasionally by Lope), instead of the old national ballad-measures (the romance-measure with assonance and the rhymed *redondilla* quatrain) preferred by the old masters among the variety of metres employed by them. The earliest Spanish comedy in the French form (a translation only, though written in the national metre)⁸ (1751), and the first original Spanish comedy on the same model, Nicolas Moratin's *Petimetra* (*Petite-Maitresse*), printed in 1756 with a critical dissertation, likewise remained unacted. In 1770, however, the same author's *Hermesinda*, an historic drama on a national theme and in the national metre, but adhering to the French rules, appeared on the stage; and similar attempts followed in tragedy by the same writer and others (including Ayala, who ventured in 1775 to compete with Cervantes on the theme of Numantia), and in comedy by Iriarte and Jovellanos (afterwards minister under Godoy), who produced a sentimental comedy in Diderot's manner.⁹ But these endeavours failed to effect any change in the popular theatre, which was with more success raised from its deepest degradation by R. de la Cruz, a fertile author of light pieces of genuine humour, especially *saynetes*, depicting the manners of the middle and lower classes. In literary circles Garcia de la Huerta's voluminous collection of the old plays (1785) gave a new impulse to dramatic productivity, and the conflict continued between representatives of the old school, such as Luciano Francisco Comella (1716-1779) and of the new, such as the younger Moratin, whose comedies—of which the last and most successful¹⁰ was in prose—raised him to the foremost position among the dramatists of his age. In tragedy N. de Cienfuegos likewise showed some originality. After, however, the troubles of the French domination and the war had come to an end, the precepts and examples of the new school failed to reassert themselves.

Already in 1815 an active critical controversy was carried on by Böhl de Faber against the efforts of J. Faber and Alcalá Galiano to uphold the principles of classicism; and with the aid of the eminent actor Múiquez the old romantic masterpieces were easily reinstated in the public favour, which as a matter of fact they had never forfeited. The Spanish dramatists of the 19th century, after passing, as in the instance of F. Martínez de la Rosa and Bréton de los Herreros, from the system of French comedy to the manner of the national drama, appear either to have stood under the influence of the French romantic school, or to have returned once more to the old Spanish models. Among the former class A. Gil y Zaraté, of the latter J. Zorrilla, are mentioned as specially prominent. The most renowned Spanish dramatist at the opening of the 20th century was the veteran politician and man of letters J. Echegaray.

Meanwhile, the old religious performances are not wholly extinct in Spain, and the relics of the solemn pageantry with which they were associated may long continue to survive there, as in the case of the *pasos*, which claim to have been exhibited in Holy Week at Seville for at least three centuries. As to the theatre itself, there can be no fear either that the imitation

Contemporaries of Calderon.

Moreto and the comedias de figura.

Decay of the national Spanish drama.

The French school of the 18th century.

Other later dramatists.

¹ *El Divino Orfeo, &c.*
² *El Magico prodigioso; El Purgatorio de San Patricio; La Desdena de la Cruz.*
³ *El Principe constante* (Don Ferdinand of Portugal).
⁴ *La Dama duende* (*The Fairy Lady*).
⁵ *Vida es sueño* (*Life is a Dream*).
⁶ *El Lindo Don Diego* (*Pretty Don Diego*).
⁷ *Desden con el desden* (*Disdain against Disdain*).

⁸ Luzan, *La Rason contra la mode* (*La Chaussette, La Préjugé à la mode*).
⁹ *El Delincuente honrado* (*The Honoured Culprits*).
¹⁰ *El Sí de las niñas* (*The Young Maidens' Consent*).

of foreign examples will satisfy Spanish dramatists—especially when, like the author of *Doña Perfecta* (Perez Galdos), they have excellent home material of their own for adaptation,—or that the Spanish public itself, with fine actors and actresses still upholding the lofty traditions of the national drama, will remain too fatigued to consume the drama unless bit by bit—in the shape of *sarsuelas* and similar one-act confections. Whatever may be the future of one of the noblest of modern dramatic literatures, it may confidently be predicted that, so long as Spain is Spain, her theatre will not be permanently either denationalized or degraded.

(d) Portugal.

The Portuguese drama in its earlier phases, especially before in the latter part of the 14th century the nation completely achieved its independence, seems to have followed much the same course as the Spanish; and the religious drama in all its prevailing forms and direct outgrowths retained its popularity even by the side of the products of the Renaissance. In the later period of that movement translations of classical dramas into the vernacular were stimulated by the cosmopolitan example of George Buchanan, who for a time held a post in the university of Coimbra; to this class of play Teive's *Johannes* (1553) may be supposed to have belonged. In the next generation Antonio Ferreira¹ and others still wrote comedies more or less on the classical model. But the rather vague title of "the Plautus of Portugal" is accorded to an earlier comic writer, the celebrated Gil Vicente, who died about 1536, after, it is stated, producing forty-two plays. He was the founder of popular Portuguese comedy, and his plays were called *autos*, or by the common name of *praticas*.² Among his most gifted successors are mentioned A. Ribeiro, called *Chiado* (the mocking-bird), who died in 1590;³ his brother Jeronymo, B. Dias, A. Pires, J. Pinto, H. Lopes and others. The dramatic efforts of the illustrious poet Luis de Camões (Camoens) are relatively of slight importance; they consist of one of the many modern versions of the *Amphitruo*, and of two other comedies, of which the earlier (*Filodemo*) was acted at Goa in 1553, the subjects having a romantic colour.⁴ Of greater importance were the contributions to dramatic literature of F. de Sá de Miranda, who, being well acquainted with both Spanish and Italian life, sought early in his career to domesticate the Italian comedy of intrigue on the Portuguese stage;⁵ but he failed to carry with him the public taste, which preferred the *autos* of Gil Vicente. The followers of Miranda were, however, more successful than he had been himself, among them the already-mentioned Antonio Ferreira; the prose plays of Jorge Ferreira de Vasconcellos, which bear some resemblance to the Spanish *Celestina*, are valuable as pictures of contemporary manners in city and court.⁶

The later Portuguese dramatic literature seems also to have passed through phases corresponding to those of the Spanish, though with special features of its own. In the 18th century Alcino Mycenio (1728-1770), known as Domingos dos Reis Quito in everyday life, in which his avocation was that of Allan Ramsay, was remarkably successful with a series of plays,⁷ including of course an *Ines de Castro*, which in a subsequent adaptation by J. B. Gomes long held the national stage. Another dramatist, of both merit and higher aspirations, was Lycidas Cynthio (*alias* Manoel de Figueiredo, 1725-1801).⁸ But the romantic movement was very late in coming to Portugal. Curiously enough, one of its chief representatives, the viscount da Almeida Garrett, exhibited his sympathy with French, revolutionary and anti-

English ideas by a tragedy on the subject of Cato;⁹ but his later works were mainly on national subjects.¹⁰ The expansive tendencies of later Portuguese dramatic literature are illustrated by the translations of A. F. de Castilho, who even ventured upon Goethe's *Faust* (1872). Among 19th-century dramatists are to be noted Pereira da Cunha, R. Cordeiro, E. Biester, L. Palmeirin, and Garrett's disciple F. G. de Amorim, by whom both political and social themes have been freely treated. The reaction against romanticism observable in Portuguese poetic literature can hardly fail to affect (or perhaps has already affected) the growth of the national drama; for the receptive qualities of both are not less striking than the productive.

(e) France.

France was the only country, besides Italy, in which classical tragedy was naturalized. In 1531 the Benedictine Barthélémy of Loches printed a *Christus Xylenicus*; and a very notable impulse was given both to the translation and to the imitation of ancient models by a series of efforts made in the university of Paris and other French places of learning. The most successful of these attempts was the *Johannes Baptistes* of George Buchanan, who taught in Paris for five years and at a rather later date resided at Bordeaux, where in 1540 he composed this celebrated tragedy (afterwards translated into four or five modern languages), in which it is now ascertained that he had in view the trial and condemnation of Sir Thomas More. He also wrote *Jephthah*, and translated into Latin the *Medea* and *Alcestis* of Euripides. At a rather later date the great scholar M. A. Muret (Muretus) produced his *Julius Caesar*, a work perhaps superior in correctness to Buchanan's tragic masterpiece, but inferior to it in likeness to life. About the same time the enthusiasm of the Paris classicists showed itself in several translations of Sophoclean and Euripidean tragedies into French verse.¹¹

Thus the beginnings of the regular drama in France, which, without absolutely determining, potentially swayed its entire course, came to connect themselves directly with the great literary movement of the Renaissance. Du Bellay sounded the note of attack which converted that movement in France into an endeavour to transform the national literature; and in Ronsard the classical school of poetry put forward its conquering hero and sovereign lawgiver. Among the disciples who gathered round Ronsard, and with him formed the "Pleiad" of French literature, Étienne Jodelle, the reformer of the French theatre, soon held a distinguished place. The stage of this period left ample room for the enterprise of this youthful writer. The popularity of the old entertainments had reached its height when Louis XII., in his conflict with Pope Julius II., had not scrupled to call in the aid of Pierre Gringoire (Grignon), and when the *Mère sotte* had mockingly masqueraded in the petticoats of Holy Church. In the reign of Francis I. the Inquisition, and on occasion the king himself, had to some extent succeeded in repressing the audacity of the actors, whose follies were at the same time an utter abomination in the eyes of the Huguenots. For a time the very mysteries of the Brethren of the Passion had been prohibited; while the moralities and farces had sunk to an almost contemptible level. Yet to this reign belong the contributions to farce-literature of three writers so distinguished as Rabelais (non-extant), Clément Marot and Queen Margaret of Navarre. Meanwhile isolated translations of Italian¹² as well as classical dramas had in literature begun the movement which Jodelle now transferred to the stage itself. His tragedy *Cléopâtre captive* was produced there on the same day as his comedy *L'Écuyer*, in 1552, his *Didon se sacrifiant* following in 1558. Thus at a time when a national theatre was perhaps impossible in a country distracted by civil and religious

¹ *O cioso* (*The Jealous Man*), &c. His *Ines de Castro* is a tragedy with choruses, partly founded on the Spanish play of J. Bermudez.

² *Don Duarados, Amadis*, &c.

³ *Auto das Regateiras* (*The Market-women*), *Pratica de compadres* (*The Gossips*), &c.

⁴ *Emphatricos, Filodemo, Seleuco*.

⁵ *Os Extrangeiros, Os Vilhalpandos* (*The Impostors*).

⁶ *Eufrosina, Ulyssipe* (Lisbon), *Aulegrafia*.

⁷ *Astora, Hermiona, Megara*.

⁸ These assumptions of names remind us that we are in the period of the "Arcadians."

⁹ *Cato*.

¹⁰ *Manoel de Sousa*, &c.

¹¹ *Antigone and Electra; Hecuba; and Iphigenia in Aulis*. The *Andria* was also translated, and in 1540 Ronsard translated the *Plutus* of Aristophanes.

¹² *Trismino, Sofonisba*, by de Saint-Gelais.

conflicts, whose monarchy had not yet welded together a number of provinces attached each to its own traditions, and whose population, especially in the capital, was enervated by frivolity or enslaved by fanaticism, was born that long-lived artificial growth, the so-called classical tragedy of France. For French comedy, though subjected to the same influences as tragedy, had a national basis upon which to proceed, and its history is partly that of a modification of old popular forms.

The history of French tragedy begins with the *Cleopâtre captive*, in the representation of which the author, together with other members of the "Pleiad," took part. It is a tragedy in the manner of Seneca, devoid of action and provided with a ghost and a chorus. Though mainly written in the five-foot Iambic couplet, it already contains passages in the Alexandrine metre, which soon afterwards J. de La Pérouse by his *Médée* (pr. 1556) established in French tragedy, and which Jodelle employed in his *Didon*. Numerous tragedies followed in the same style by various authors, among whom Gabriel Bounyn produced the first French regular tragedy on a subject neither Greek nor Roman,¹ and the brothers de la Taille,² and J. Grévin,³ distinguished themselves by their style. In the reign of Charles IX. a vain attempt was made by Nicolas Filleul to introduce the pastoral style of the Italians into French tragedy;⁴ and the Brotherhood of the Passion was intermingling with pastoral plays its still continued reproductions of the old entertainments, and the religious drama making its expiring efforts, among which T. Le Coq's interesting mystery of *Cain* (1580) should be noted. Beza's *Abraham sacrificant* (1550), J. de Coignac's *Goliath* (dedicated to Edward VI.), Rivandean's *Héman* (1561), belong to a group of Biblical tragedies, inspired by Calvinist influences. But these more and more approached to the examples of the classical school, which, in spite of all difficulties and rivalries prevailed. Among its followers Montchretien exhibited unusual vigour of rhetoric,⁵ and in R. Garnier French tragedy reached the greatest height in nobility and dignity of style, as well as in the exhibition of dramatic passion, to which it attained before Corneille. In his tragedies⁶ choruses are still interspersed among the long Alexandrine tirades of the dialogue.

During this period comedy had likewise been influenced by classical models; but the distance was less between the national farces and Terence, than between the mysteries and moralities, and Seneca and the Greeks. *L'Eugène* differs little in style from the more elaborate of the old farces; and while it satirizes the foibles of the clergy without any appreciable abatement of the old licence, its theme is the favourite burden of the French comic theatre in all times—*le coquage*. The examples, however, which directly facilitated the productivity of the French comic dramatists of this period, among whom Jean de la Taille was the first to attempt a regular comedy in prose,⁷ were those of the Italian stage, which in 1576 established a permanent colony in France, destined to survive there till the close of the 17th century, by which time it had adopted the French language, and was ready to coalesce with French actors, without, however, relinquishing all remembrance of its origin.. R. Belleau, a member of the "Pleiad," produced a comedy in which the type (already approached by Jodelle) of the swaggering captain appears,⁸ J. Grévin copied Italian intrigue, characters and manners;⁹ O. de Turnèbe (d. 1581) borrowed the title of one Italian play¹⁰ and perhaps parts of the plots of others; the Florentine F. d'Amboise (d. 1558) produced versions of two Italian comedies;¹¹ and the foremost French comic poet of the century, P. de Larivey, likewise an Italian born (of the name of Pietro Giunto), openly professed to imitate the poets of his native country. His plays are more or less literal

translations of L. Dolce,¹² Secchi¹³ and other Italian dramatists; and this lively and witty author, to whom Molière owes much, thus connects two of the most important and successful growths of the modern comic drama.

The close conjunction between the history of a living dramatic literature and that of the theatre can least of all be ignored in the case of France, where the actor's art has gone through so ample an evolution, and where the theatre has so long and continuously formed an important part of the national life. By the middle of the 16th century not only had theatrical representations, now quite emancipated from clerical control, here and there already become matters of speculation and business, but the acting profession was beginning to organize itself as such; strolling companies of actors had become a more or less frequent experience; and the attitude of the church and of civic respectability were once more coming to be systematically hostile to the stage and its representatives.

Before, however, either tragedy or comedy in France entered into the period of their history when genius was to illuminate both of them with creations of undying merit, and before the theatre had associated itself enduringly with the artistic and literary divisions of court and society and the people at large, the country had passed through a new phase of the national life. When the troubles and terrors of the great civil and religious wars of the 16th century were over at last, they were found to have produced a reaction towards culture and refinement which spread from certain spheres of society whose influence was for a time prevailing. The seal had been set upon the results of the Renaissance by Malherbe, the father of French style. The masses meanwhile continued to solace or distract their weariness and their sufferings with the help of the accredited ministers of that half-cynical gaiety which has always lighted up the darkest hours of French popular life. In the troublous days preceding Richelieu's definitive accession to power (1624), the *tabarinades*—a kind of street dialogue recalling the earliest days of the popular drama—had made the Pont-Neuf the favourite theatre of the Parisian populace. Meanwhile the influence of Spain, which Henry IV. had overcome in politics, had throughout his reign and afterwards been predominant in other spheres, and not the least in that of literature. The *stilo culto*, of which Gongora was the native Spanish, Marino the Italian, and Lyly the English representative, asserted its dominion over the favourite authors of French society; the pastoral romance of Honoré d'Urfé—the text-book of pseudo-pastoral gallantry—was the parent of the romances of the Scudérys, de La Calprenède and Mme de La Fayette; the Hôtel de Rambouillet was in its glory; the true (not the false) *précieuses* sat on the heights of intellectual society; and J. L. G. de Balzac (ridiculed in the earliest French dramatic parody)¹⁴ and Voiture were the dictators of its literature. Much of the French drama of this age is of the same kind as its romance-literature, like which it fell under the polite castigation of Boileau's satire. Heroic love (quite a technical passion), "fertile in tender sentiments," seized hold of the theatre as well as of the romances; and La Calprenède, G. de Scudéry¹⁵ and his sister and others were equally fashionable in both species. The Gascon Cyrano de Bergerac, though not altogether insignificant as a dramatist,¹⁶ gained his chief literary reputation by a Rabelaisian fiction. Meanwhile, Spanish and Italian models continued to influence both branches of the drama. Everybody knew by heart Gongora's version of the story of "young Pyramus and his love Thisbe," as dramatized by Th. Viaud (1590-1626); and the sentiment of Tristan¹⁷ (1601-1655) overpowered Herod on the stage, and drew tears from Cardinal Richelieu in the audience. J. Mairet was noted for superior vigour.¹⁸ P. Du Ryer's style is described as, while otherwise superior to that of his contemporaries,

French tragedy and comedy in the 17th century before Corneille.

¹ *La Soltane* (1561).

² *Datre* (*Darius*).

³ *La Mort de César*.

⁴ *Achille* (1563).

⁵ *Les Lacènes*; *Maria Stuart* or *L'Écossoise*.

⁶ *La Juive*, &c.

⁷ *Les Corinaux* (1573).

⁸ *La Reconnaissance* (*Le Capitaine Rodomont*).

⁹ *Les Esbañis*.

¹⁰ *Les Contens* (S. Parabosco, *I Contenti*).

¹¹ *Les Neapolitaines*; *Les Désespérades de l'amour*.

¹² *Le Laquis* (*Il Ragazzo*).

¹³ *Les Tromperies* (*Gli Inganni*).

¹⁴ L. du Pasquier" (de Barry), *La Comédie des comédies*.

¹⁵ *L'Amour tyrannique*.

¹⁶ *Marianne*.

¹⁷ *Arrippine*, *Le Pédant joué*.

¹⁸ *Sophonisbe*.

Italian in its defects. A mixture of the forms of classical comedy with elements of Spanish and of the Italian pastoral was attempted with great temporary success by A. Hardy, a playwright who thanked Heaven that he knew the precepts of his art while preferring to follow the demands of his trade. The mixture of styles begun by him was carried on by the marquis de Racan,¹ J. de Rotrou and others; and among these comedies of intrigue in the Spanish manner the earliest efforts of Corneille himself² are to be classed. Rotrou's noteworthy productions³ are later in date than the event which marks an epoch in the history of the French drama, the appearance of Corneille's *Cid* (1636).

P. Corneille is justly revered as the first, and in some respects the unequalled, great master of French tragedy, whatever may have been unsound in his theories, or defective in his practice. The attempts of his predecessors had been without life, because they lacked really tragic characters and the play of really tragic passions; while their style had been either pedantically imitative or a medley of plagiarisms. He conquered tragedy at once for the national theatre and for the national literature—and this, not by a long tentative process of production, but by a few masterpieces, which may be held to be comprehended within the ten years 1636 to 1646; for in his many later tragedies he never again proved fully equal to himself. The French tragedy, of which the great age begins with the *Cid*, *Horace*, *Cinna*, *Polyeucte* and *Rodogune*, was not, whatever it professed to be, a copy of the classical tragedy of Greeks or Romans, or an imitation of the Italian imitations of these; nor, though in his later tragedies Corneille depended less and less upon characters, and more and more, after the fashion of the Spaniards, upon situations, and even upon spectacle, were the forms of the Spanish drama able to assert their dominion over the French tragic stage. The mould of French tragedy was cast by Corneille; but the creative power of his genius was unable to fill it with more than a few examples. His range of passions and characters was limited; he preferred, he said, the reproach of having made his women too heroic to that of having made his men effeminate. His actions inclined too much to the exhibition of conflicts political rather than broadly ethical in their significance. The defects of his style are of less moment; but in this, as in other respects, he was, with all his strength and brilliancy, not one of those rarest of artists who are at the same time the example and the despair of their successors. The *examens* which he printed of all his plays up to 1660 show how much self-criticism (though it may not always be as in this case conscious) contributes to the true fertility of genius.

In comedy also Corneille begins the first great original epoch of French dramatic literature; for it was to him that Molière owed the inspiration of the tone and style which he made those of the higher forms of French comedy. But *Le Menteur* (the parent, with its sequel, of a numerous dramatic progeny⁴) was itself derived from a Spanish original,⁵ which it did not (as was the case with the *Cid*) transform into something new. French tragi-comedy Corneille can hardly be said to have invented;⁶ and of the mongrel growths of sentimental comedy and of domestic drama or *drame*, he rather suggested than exemplified the conditions.

The tragic art of Racine supplements rather than surpasses that of his older contemporary. His works reflect the serene and settled formality of an age in which the sun of monarchy shone with an effulgence no clouds seemed capable of obscuring, and in which the life of a nation seemed reducible to the surroundings of a court. The tone of the poetic literature of such an age is not necessarily unreal, because the range of its ideas is limited, and because its forms seem to exist by an immutable authority. That Racine should permanently hold the position which belongs to him in French dramatic

literature is due to the fact that to him it was given to present these forms—the forms approved by his age—in what may reasonably be called perfection; and, from the point of view of workmanship, Sophocles could not have achieved more. What his plays contain is another question. They suit themselves so well to the successive phases in the life of Louis XIV., that Madame de Sévigné described Racine as having in his later years loved God as he had formerly loved his mistresses; and this sally at all events indicates the range of passions which inspired his tragic muse. His heroes are all of one type—that of a gracious gloriousness; his heroines vary in their fortunes, but they are all the "trophies of love,"⁷ with the exception of the scriptural figures, which stand apart from the rest.⁸ T. Corneille, Campistron, Joseph Duché (1668–1704), Antoin de Lafosse (c. 1653–1708) and Quinault were mere followers of one or both of the great masters of tragedy, though the last named achieved a reputation of his own in the bastard species of the opera.

The type of French tragedy thus established, like everything else which formed part of the "age of Louis XIV.," proclaimed itself as the definitively settled model of its kind, and was accepted as such by a submissive world. Proud of its self-imposed fetters, French tragedy dictatorially denied the liberty of which it had deprived itself to the art of which it claimed to furnish the highest examples. Yet, though calling itself classical, it had not caught the essential spirit of the tragedy of the Greeks. The elevation of tone which characterizes the serious drama of the age of Louis XIV. is a true elevation, but its heights do not lose themselves in a sphere peopled by the myths of a national religion, still less in the region of great thoughts which ask Heaven to stoop to the aspirations and the failures of man. The personages of this drama are conventional like its themes, but the convention is with itself only; Orestes and Iphigenia have not brought with them the cries of the stern goddesses and the flame on the altar of Artemis; their passions like their speech are cadenced by a modern measure. In construction, the simplicity and regularity of the ancient models are stereotyped into a rigid etiquette by the exigencies of the court-theatre, which is but an apartment of the palace. The unities of time and place, with the Greeks mere rules of convenience, French tragedy imposes upon itself as a permanent yoke. The Euripidean prologue is judiciously exchanged for the exposition of the first act, and the lyrical element essential to Greek tragedy is easily suppressed in its would-be copy; lyrical passages still occur in some of Corneille's early masterpieces,⁹ but the chorus is consistently banished, to reappear only in Racine's latest works¹⁰ as a scholastic experiment appropriate to a conventual atmosphere. Its uses for explanation and comment are served by the expedient, which in its turn becomes conventional, of the conversations with *confidants* and *confidantes*, which more than sufficiently supply the foil of general sentiments. The epic element is allowed full play in narrative passages, more especially in those which relate parts of the catastrophe,¹¹ and, while preserving the stage intact from realism, suit themselves to the generally rhetorical character of this species of the tragic drama. This character impressed itself more and more upon the tragic art of a rhetorical nation in an age when the loftiest themes were in the pulpit receiving the most artistic oratorical treatment, and developed in the style of French classical tragedy the qualities which cause it to become something between prose and poetry—or to appear (in the phrase of a French critic) like prose in full dress. The force of this description is borne out by the fact that the distinction between the versification of French tragedy and that of French comedy seems at times imperceptible.

The universal genius of Voltaire found it necessary to shine in all branches of literature, and in tragedy to surpass predecessors whom his own authority declared to have surpassed

¹ *Les Bergeries*. ² *Mélite; Clitandre, &c.*

³ *Le Véritable Saini Genest; Venceslas.*

⁴ *Steele, The Lying Lover; Foote, The Liar; Goldoni, Il Bugiardo.*

⁵ *Ruis de Alarcon, La Verdad sospechosa.*

⁶ *L'Ilusion comique* is antithetically mixed.

⁷ *Andromaque; Phédre; Bérénice, &c.*

⁸ *Esther; Athalie.*

⁹ *Le Cid; Polyeucte.*

¹⁰ *Esther; Athalie.*

¹¹ *Corneille, Rodogune; Racine, Phédre.*

the efforts of the Attic muse. He succeeded in impressing the world with the belief that his innovations had imparted a fresh vitality to French tragedy; in truth, however, they represent no essential advance in art, but rather augmented the rhetorical tendency which paralyses true dramatic life. Such life as his plays possess lies in their political and social sentiments, their invective against tyranny,¹ and their exposure of fanaticism.² In other respects his versatility was barren of enduring results. He might take his themes from French history,³ or from Chinese,⁴ or Egyptian,⁵ or Syrian,⁶ from the days of the Epigoni⁷ or from those of the Crusades;⁸ he might appreciate Shakespeare, with a more or less partial comprehension of his strength, and condescendingly borrow from and improve the barbarian.⁹ But he added nothing to French tragedy where it was weakest—in character; and where it was strongest—in diction—he never equalled Corneille in fire or Racine in refinement. While the criticism to which French tragedy in this age at last began to be subjected has left unimpaired the real titles to immortality of its great masters, the French theatre itself has all but buried in respectful oblivion the dramatic works bearing the name of Voltaire—a name persistently belittled, but second to none in the history of modern progress and of modern civilization.

As it is of relatively little interest to note the ramifications of an art in its decline, the contrasts need not be pursued among the contemporaries of Voltaire, between his imitator Bernard Joseph Saurin (1706-1781), Saurin's royalist rival de Belloy, Racine's imitator Lagrange-Chancel and Voltaire's own would-be rival, the "terrible" Crébillon the elder, who professed to vindicate to French tragedy, already mistress of the heavens through Corneille, and of the earth through Racine, Pluto's supplementary realm, but who, though thus essaying to carry tragedy lower, failed to carry it farther. In the latter part of the 18th century French classical tragedy as a literary growth was dying a slow death, however numerous might be the leaves which sprouted from the decaying tree. Its form had been permanently fixed; and even Shakespeare, as manipulated by Ducis¹⁰—an author whose tastes were better than his times—failed to bring about a change. "It is a Moor, not a Frenchman, who has written this play," cried a spectator of Ducis' *Othello* (1791); but Talma's conviction was almost as strong as his capacity was great for convincing his public; and he certainly did much to prepare the influence which Shakespeare was gradually to assert over the French drama, and which was aided by translations, more especially that of Pierre Letourneur (1736-1788), which had attracted the sympathy of Diderot and the execrations of the aged Voltaire.¹¹ Meanwhile, the command which classical French tragedy continued to assert over the stage was due in part, no doubt, to the love of Roman drapery—not always abundant, but always in the grand style—which characterized the Revolution, and which was by the Revolution handed down to the Empire. It was likewise, and more signally, due to the great actors who freed the tragic stage from much of its artificiality and animated it by their genius. No great artist has ever more generously estimated the labours of a predecessor than Talma judged those of Le Kain; but it was Talma himself whose genius was pre-eminently fitted to reproduce the great figures of antiquity in the mimic world, which, like the world outside, both required and possessed its Caesar. He, like Rachel after him, reconciled French classical tragedy with nature; and it is upon the art of great original actors such as these that the theatrical future of this form of the drama in France depends. Mere whims of fashion

—even when inspired by political feeling—will not wait back to it a real popularity; nor will occasional literary aftergrowths, however meritorious, such as the admirable *Lucretia* of F. Ponsard and the attempts of even more recent writers, suffice to re-establish a living union between it and the progress of the national literature.

The rival influences under which classical tragedy has after a long struggle virtually become a thing of the past in French literature are also to be traced in the history of French comedy, which under the co-operation of other influences produced a wide variety of growths. The germs of most of these—though not of all—are to be found in the works of the most versatile, the most sure-footed, and, in some respects, the most consummate master of the comic drama whom the world has known—Molière. What Molière found in existence was a comedy of intrigue, derived from Spanish or Italian examples, and the elements of a comedy of character, in French and more especially in Italian farce and ballet-pantomime. Corneille's *Menteur* had pointed the way to a fuller combination of character with intrigue, and in this direction Molière's genius exercised the height of its creative powers. After beginning with farces, he produced in the earliest of his plays (from 1652), of which more than fragments remain, comedies of intrigue which are at the same time marvellously lively pictures of manners, and then proceeded, with the *École des maris* (1661), to begin a long series of masterpieces of comedy of character. Yet even these, the chief of which are altogether unrivalled in dramatic literature, do not exhaust the variety of his productions. To define the range of his art is as difficult as to express in words the essence of his genius. For though he has been copied ever since he wrote, neither his spirit nor his manner has descended in full to any of his copyists, whose schools of whom have missed elements of both. A Molière can only be judged in his relations to the history of comedy at large. He was indeed the inheritor of many forms and styles—remaining a stranger to those of Old Attic comedy only, rooted as it was in the political life of a free imperial city; though even the rich extravagances of Aristophanes' burlesque was not left wholly unreproduced by him. Molière is both a satirist and a humorist; he displays at times the sentiments of a loyal courtier, at others that gay spirit of opposition which is all but indispensable to a popular French wit. His comedies offer elaborate and subtle—even tender—pictures of human character in its eternal types, lively sketches of social follies and literary extravagances, and broad appeals to the ordinary sources of vulgar merriment. Light and perspicuous in construction, he is master of the delicate play of irony, the penetrating force of wit, and the expansive gaiety of frolicsome fun. Faithful to the canons of artistic taste, and under the sure guidance of true natural humour, his style suits itself to every species attempted by him. His morality is the reverse of rigid, but its aberrations are not those of prurience, nor its laws those of pretence; and, wholly free as he was from the didactic aim which is foreign to all true dramatic representation, the services rendered by him to his art are not the less services rendered to society, concerning which the laughter of genuine comedy tells the truth. He raised the comedy of character out of the lower sphere of caricature, and in his greatest creations subordinated to the highest ends of all dramatic composition the plots he so skillfully built, and the pictures of the manners he so faithfully reproduced.

Even among the French comic dramatists of this age there must have been many who "were not aware" that Molière was its greatest poet. For though he had made the true path luminous to them, their efforts were still often of a tentative kind, and one was reviving *Pathelin* while another was translating the *Andria*. A more unique attempt was made in one of the very few really modern versions of an Aristophanic comedy, which deserves to be called an original copy—the *Plaideurs* of Racine. The tragic poets Quinault and Campistron likewise wrote comedies, one¹²

¹ *Brutus*; *La Mort de César*; *Sémiramis*.

² *Édipe*; *Le Fanatisme* (*Mahomet*).

³ *Alzide du Guesclin*.

⁴ *Taxis et Zélide*.

⁵ *Tancrède*.

⁶ *Hamlet*; *Le Roi Lear*, &c.

⁷ The lectures delivered by the late Professor A. Beljame at Trinity College, Cambridge, in 1905-1906 may be mentioned as valuable contributions to our knowledge of the growth of Shakespeare's influence in France.

⁴ *L'Orphelin de la Chine*.

⁵ *Les Guèbres*.

⁷ *Olimpie*.

⁸ *La Mort de César*; *Zaire* (*Othello*).

Comedy.

Molière.

Molière's contemporaries and successors.

¹² Quinault, *L'Amour indiscret* (Newcastle and Dryden's *Sir Martin Marcell*).

or more of which furnished materials to contemporary English dramatists, as did one of the felicitous plays in which Boursault introduced Mercury and Aescop into the theatrical *salon*.¹ Antoine Montfleury (1640-1685), Baron and Dancourt, who were actors like Molière, likewise wrote comedies. But if the mantle of Molière can be said to have fallen upon any of his contemporaries or successors, this honour must be ascribed to J. F. Regnard, who imitated the great master in both themes and characters,² while the skillfulness of his plots, and his gaiety of the treatment even of subjects tempting into the by-path of sentimental comedy,³ entitle him to be regarded as a comic poet of original genius. With him C. R. Dufresny occasionally collaborated.

In the next generation (that of Voltaire) comedy gradually—but only gradually—surrendered for a time the very essence of its vitality to the seductions of a hybrid species, which disguised its identity under more than a single name. A. R. le Sage, who as a comic dramatist at first followed successfully in the footsteps of Molière, proved himself on the stage as well as in picturesque fiction a keen observer and imitable satirist of human life.⁴ The light texture of the playful and elegant art of J. B. L. Gresset was shown on the stage in a character comedy of merit;⁵ and in a comedy which reveals something of his pointed wit, A. Piron produced something like a new type of enduring ridiculousness.⁶ P. C. de Marivaux, the French *Spectator*, is usually supposed to have formed the connecting link between the "old" French comedy and the "new" and bastard variety. Yet, though his minute analysis of the tender passion excited the scorn of Voltaire, it should not be overlooked that in *marivaudage* proper the wit holds the balance to the sentiment, and that in some of this frequently misjudged writer's earlier and most delightful plays the elegance and gaiety of diction are as irresistible as the pathetic sentiment, which is in fact rather an ingredient in his comedy than the pervading characteristic of it.⁷ Some of the comedies of P. H. Destouches no doubt have a serious basis, and in his later plays he comes near to a kind of drama in which the comic purpose has been virtually submerged.⁸ The writer who is actually to be credited with the transition to sentimental comedy, and who was fully conscious of the change which he was helping to effect, was Nivelle de La Chaussée, in whose hands French comedy became a champion of the sanctity of marriage, and reproduced the sentiments—in one instance even the characters—of Richardson.⁹ To his play *La Fausse Antipathie* the author supplied a *critique*, amounting to an apology for the new species of which it was designed as an example.

The new species known as *comédie larmoyante* was now fairly in the ascendant; and it would be easy to show how even Voltaire, who had deprecated the innovation, had to yield to a power greater than his own, and introduced the sentimental element into some of his comedies.¹⁰ The further step, by which *comédie larmoyante* was transformed into *tragédie bourgeoise*, from which the comic element was to all intents and purposes extruded, was taken by a great French writer, D. Diderot; to whose influence it was largely due that the species which had attained to this consummation for more than a generation ruled supreme in the dramatic literature of Europe. But the final impulse, as Diderot himself virtually acknowledged in the *entretiens* subjoined by him to his *Fils naturel* (1757), had been

given by a far humbler citizen of the world of letters, the author of *The London Merchant*. Diderot's own plays were a literary rather than a theatrical success. *Le Fils naturel ou les épreuves de la vertu* was not publicly performed till 1771, and then only in deference to the determination of a single actor of the Français (Molé); nor was the performance of it repeated. Diderot's second play, *Le Père de famille*, printed in 1758 with a *Discours sur la poésie dramatique*, went through a few public performances in 1761; and a later revival was unsuccessful. But "at a distance," as was well said, the effect of Diderot's endeavours, the earlier in particular, was extremely great, and Lessing, though very critical as to particular points, greatly helped to spread it. Diderot had for the first time consciously sought to proclaim the theatre an agency of social reform, and to entrust to it as its task the propagation of the gospel of philanthropy. Though the execution of his dramatic works fell far short of his aims; though Madame de Staël was not far wrong in denouncing them as exhibiting not nature itself, but "the affectation of nature," yet they contained, in a measure almost unequalled in the history of the modern drama, the fermenting element which never seems to subside. Their author announced them as examples of a third dramatic form—the *genre sérieux*—which he declared to be the consummation of the dramatic art. Making war upon the frigid artificiality of classical tragedy, he banished verse from the new species. The effect of these plays was intended to spring from their truth to nature—a truth such as no spectator could mistake, and which should bring home its moral teachings to the business as well as the bosoms of all. The theatre was to become a real and realistic school of the principles of society and of the conduct of life—it was, in other words, to usurp functions with which it has no concern, and to essay the direct reformation of mankind. The idea was neither new nor just; but its speciousness will probably continue to commend it to many enthusiastic minds, whensoever and in whatsoever shape it is revived.

From this point the history of the French drama becomes that of a conflict between an enfeebled artistic school and a tendency which is hardly to be dignified by the name of a school at all. Among the successful dramatists following on Diderot may be mentioned the critical and versatile J. F. Marmontel, and more especially M. J. Sedaine, who though chiefly working for the opera, produced two comedies of acknowledged merit.¹¹ P. A. de Beaumarchais (1732-1799), who for his early sentimental plays,¹² in which he imitated Diderot, invented the appellation *drame*—so convenient in its vagueness that it became the accepted name of the hybrid species to which they belonged—in two works of a very different kind, the famous *Barbier de Séville* and the still more famous *Mariage de Figaro*, boldly carried comedy back into its old Spanish atmosphere of intrigue; but, while surpassing all his predecessors in the skill with which he constructed his frivolous plots, he drew his characters with a lightness and sureness of touch peculiar to himself, animated his dialogue with an unparalleled brilliancy of wit, and seasoned action as well as dialogue with a political and social meaning, which caused his epigrams to become proverbs, and which marks his *Figaro* as a herald of the Revolution. Such plays as these were ill suited to the rule of the despot whose vigilance could not overlook their significance. The comedy of the empire is, in the hands of Collin d'Harleville, Louis Picard (1769-1828), A. Duval, Étienne and others, mainly a harmless comedy of manners; nor was the attempted innovation of N. Lemercier—who was fain to invent a new species, that of historical comedy—more than a flattering self-delusion. The theatre had its share in all the movements and changes which ensued in France; though the most important revolution which the drama itself was to undergo was not one of wholly native origin. Those branches of the drama which belong specifically to the history of the opera, or which associate themselves with it, are here passed by. Among them was the *vaudreville* (from Val de Vire in Calvados), which

The comedy of the Revolution and the first empire.

¹ *Le Mercure galant; Ésope à la ville; Ésope à la cour* (Vanbrugh, Aescop).

² *Le Bal (M. de Pourceaugnac); Geronte in Le Légataire universel* (Argan in *Le Malade imaginaire*); *La Critique du L. (La C. de l'école des Femmes)*.

³ *Le Joueur; La Légataire universel.*

⁴ *Crispin rival de son maître; Turcaret.*

⁵ *Le Méchant.*

⁶ *Le Jeu de l'amour et du hasard; Le Legs; La Surprise de l'amour; Les Faussez Confidences; L'Épave.*

⁷ *Le Philosophe marié; Le Glorieux; Le Dissipateur.*

⁸ *La Fausse Antipathie; Le Prêjugé à la mode; L'École des amis; Méluside; Paméla. L'École des mères* was the play which Frederick the Great described as turning the stage into a bureau général de la fadour.

⁹ See especially *Nanine*, founded on the original *Paméla*.

¹¹ *Le Philosophe sans le savoir; La Gageure imprévue.*

¹² e.g. *Eugénie* (the original of Goethe's *Clavigo*) and *Les Deux Amis, ou Le Négociant de Lyon*.

began as an interspersing of pantomime with the airs of popular songs, and which, after the Italian masks had been removed from it, was cultivated by Ponsard and Marmontel, while Sedaine wrote a didactic poem on the subject (1756). Sedaine was the father of the *opéra-comique* proper; ¹ Marmontel,² as well as Rousseau,³ likewise composed *opérettes*—a smaller sort of opera, at first of the pastoral variety; and these flexible species easily entered into combination. The melodrama proper, of which the invention is also attributed to Rousseau,⁴ in its latter development became merely a drama accentuated by music, though usually in little need of any accentuation.

The chief home of the regular drama, however, demanded efforts of another kind. At the Théâtre Français, or Comédie Française, whose history as that of a single company of actors had begun in 1680, the party-strife of the times made itself audible; and the most prominent tragic poet of the Revolution, M. J. de Chénier, a disciple of Voltaire in dramatic poetry as well as in political philosophy, wrote for the national stage the historical drama—with a political moral⁵—in which in the memorable year 1789 the actor Talma achieved his first complete triumph. But the victorious Revolution proclaimed among other liberties that of the theatres in Paris, of which soon not less than 50 were open. In 1807 the empire restricted the number to 9, and reinstated the Théâtre Français in sole possession (or nearly such) of the right of performing the classic drama. No writer of note was, however, tempted or inspired by the rewards and other encouragements offered by Napoleon to produce such a classic tragedy as the emperor would have willingly stamped from out of the earth. The tragedies of C. Delavigne represent the transition from the expiring efforts of the classical to the ambitious beginnings of the romantic school of the French drama.

Of modern romantic drama in France it must suffice to say that it derives some of its characteristics from the general movement of romanticism which in various ways and at various points of time transformed nearly every modern European literature, others from the rhetorical tendency which is a French national feature. Victor Hugo was the founder whom it followed in a spirit of high emprise to success upon success, his own being the most conspicuous of all;⁶ A. Dumas the elder its unshrinking middleman. The marvellous fire and grandeur of genius of the former, always in extremes but often most sublime at the height of danger, was nowhere more signally such than in the drama; Dumas was a Briareus, working, however, with many hands besides his own. Together with them may, with more or less precision, be classed in the romantic school of dramatists A. de Vigny⁷ and George Sand,⁸ neither of whom, however, attained to the highest rank in the drama, and Jules Sandeau;⁹ A. de Musset, whose originality pervades all his plays, but whose later works, more especially in his prose "proverbs" and pieces of a similar kind, have a flavour of a delicacy altogether indescribable;¹⁰ perhaps also P. Mérimée (1803-1870), who invented not only Spanish dramas but a Spanish dramatist, and who was never more audacious than when he seemed most naïf.¹¹

The romantic school was not destined to exercise a permanent control over French public taste; but it can hardly be said to have been overthrown by the brief classical revival begun by F. Ponsard, and continued, though in closer contact with modern

ideas, both by him¹² and by E. Augier, a dramatist who gradually attained to an extraordinary effectiveness in the self-restrained treatment of social as well as of historical themes.¹³ While the theatrical fecundity and the remarkable constructive ability of E. Scribe¹⁴ supplied a long series of productions attesting the rapid growth of the playwright's mastery over the secrets of his craft the name of his competitors is legion. Among them may be mentioned, if only as the authors of two of the most successful plays of the historical species produced in the century, two writers of great eminence—C. Delavigne¹⁵ and E. Legouvé.¹⁶ Later developments of the drama bore the impress of a period of social decay, prepared to probe its own sufferings, while glad at times to take refuge in the gaiety traditional in France in her more light-hearted days, but which even then had not yet deserted either French social life or the theatre which reflected it. After a fashion which would have startled even Diderot, while recalling his efforts in the earnestness of its endeavour to arouse moral interests to which the theatre had long been a stranger, A. Dumas the younger set himself to reform society by means of the stage.¹⁷ But the technical skill which he and contemporary dramatists displayed in the execution of their self-imposed task was such as had been undreamt of by Diderot. O. Feuillet, more eminent as a novelist than on the stage, applied himself, though with the aid of fewer prefaces, to the solution of the same or similar problems; while the extraordinary versatility of V. Sardou and his unflinching constructive skill was applied by him to almost every kind of serious, or serio-comic, drama—even the most solid of all.¹⁸ In the same period, while E. Pailleron revived some of the most characteristic tendencies of the best French satirical comedy in ridiculing the pompous pretentiousness of learning for its own sake,¹⁹ the light-hearted gaiety of E. Labiche changed into something not altogether similar in the productions of the comic muse of L. Halévy and H. Meilhac, ranging from the licence of the musical burlesque which was the congenial delight of the later days of the Second Empire to a species of comedy in which the ingredients of bitterness and even of sadness found a place.²⁰

Dramatic criticism in France has had a material share in the maintenance of a deep as well as wide national interest in the preservation of a high standard of excellence both in the performance of plays and in the plays themselves. Among its modern representatives the foremost place would probably be by common consent allowed to F. Sarcey, whose Monday theatrical *feuilleton* in the *Temps* was long awaited week by week as an oracle of dramaturgy. But he was only the first among equals, and the successor and the predecessor of writers who have at least sought to be equal to a function of real public importance. For it seems hardly within the range of probability to suppose that the theatre will for many a generation to come lose the hold which it has established over the intellectual and moral sympathies of nearly the whole of the educated—to say nothing of a great part of the half-educated—population of France. This does not, of course, imply that the creative activity of French dramatic literature is certain to endure. Since the great changes set in which were consequent upon the disastrous war of 1870, French dramatic literature has reflected more than one phase of national sentiment and opinion, and has represented the aspirations, the sympathies and the philosophy of life of more than one class in the community. Thus it has had its episodes of reaction in the midst of an onward flow of which it would be difficult to predict the end. The tendency of what can only vaguely be described as the naturalistic school of writers has corresponded to that even more prominent in the dramatic literatures of

¹ *Richard Cœur de Lion, &c.*
² *Zémire et Asor; Jeannot et Jeannette.*
³ *Les Muses galantes; Le Devin du village.*
⁴ *Charles IX, ou l'école des rois.*
⁵ *Hernani* (1830); *Le Roi s'amuse; Ruy Blas; Les Burgraves, &c.* Even in *Torquemada*, the fruit of its author's old age, and full of bombast, the original power has not altogether gone out.
⁶ *Chatterton.*
⁷ *Le Gendre de M. Poirier.*
⁸ *On ne badine pas avec l'amour*, as interpreted by Delaunay, was almost always remain the most exquisite type of this inimitable genre.
⁹ *Théâtre de Clara Gassdi. La Famille Carrajal*, one of these pieces, treats the same story as that of *The Cenci*.

Tendencies of the drama and of the theatre in France.
¹² *Lucrèce* (1843); *L'Honneur et l'Argent; Charlotte Corday.*
¹³ *La Cigüe; L'Aventurier; Gabrielle; Le Fils de Giboyer, &c.*
¹⁴ *Valérie; Bertrand et Raton; Le Verre d'eau, &c.*
¹⁵ *Louis XI.*
¹⁶ *Adrienne Lecouvreur.*
¹⁷ *La Dame aux camélias; Le Demi-monde; Le Supplice d'une femme; Les Idées de Mme Aubray; L'Étrangère; Francillon.*
¹⁸ *Les Pattes de mouche; Nos bons villageois; Patrie.*
¹⁹ *Le Monde où l'on s'ennuie.*
²⁰ *Frow-frow.*

certain other European nations; but it must be allowed that a new poetic will have to be constructed if the freedom of development which the dramatic, like all other arts, is entitled to claim is to be reconciled to laws deducible from the whole previous history of the drama. The reaction towards earlier forms has asserted itself in various ways—through the poetic plays of the later years of F. Coppée; in the success (notable for reasons other than artistic) of Vicomte H. de Bornier's first tragedy; and of late more especially in the dramas—highly original and truly romantic in both form and treatment—of E. Rostand.

The art of acting is not altogether dependent upon the measure of contemporary literary productivity, even in France, where the connexion between dramatic literature and the stage has perhaps been more continuously intimate than in many other countries. Talma and Mlle Mars flourished in one of the most barren ages of the French literary drama; and though this cannot be asserted of the two most brilliant stars of the French 19th century tragic stage, Rachel and Sarah Bernhardt, or of their comic contemporaries from Frédéric-Lemaître down to types less unique than the "Talma of the boulevards," the constantly accumulating experience of the successive schools of acting in France may here ensure to the art a future not less notable than its past. Moreover, the French theatre has long been, and is more than ever likely to continue, an affair of the state as well as of the nation; and the judicious policy of not leaving the chief theatres at the mercy of shifting fashion and the base demands of idleness and sensuality will remain the surest guarantee for the maintenance of a high standard both in principle and in practice. So long as France continues to maintain her ascendancy over other nations in matters of taste, and in much else that adorns, brightens and quickens social life, the predominant influence of the French theatre over the theatres of other nations is likewise assured. But dramatic literature is becoming international to a degree hardly dreamt of half a century ago; and the distinctive development of the French theatre cannot fail to be affected by the success or failure of the national drama in retaining and developing its own most characteristic qualities. Its history shows periods of marvellously rapid advance, of hardly less swift decline, and of frequent though at times fitful recovery. Its future may be equally varied; but it will remain not less dependent on the conditions which in every people, ancient or modern, have proved to be indispensable to national vigour and vitality. (A. W. W.)

Recent French Drama.—The last twenty-five years of the 19th century witnessed an important change in the constructive methods, as well as in the moral tendencies, of the French playwrights. Of the two leading dramatists who reigned supreme over the *haute comédie* in 1875, one, Émile Augier, had almost ended his career, but the other, Alexandre Dumas, was to maintain his ascendancy for many years longer. Sardou's fertility of invention, and extraordinary cleverness at manipulating a complicated intrigue, were also greatly admired, and much was expected from Edouard Pailleron's brilliant and—as it seemed—inexhaustible wit in satirizing the whims and weaknesses of high-born and highly-cultured society. Alexandre Dumas had created and still monopolized the problem play, of which *Le Demi-monde*, *Le Fils naturel*, *La Question d'argent*, *Les Idées de Madame Aubray*, *La Femme de Claude*, *Monsieur Alphonse*, *La Visite de noces*, *L'Étrangère*, *Francillon* and *Denise* may be mentioned as the most characteristic specimens. The problem play is the presentation of a particular case, with a view to a general conclusion on some important question of human conduct. This afforded the author, who, in his way, a moralist and a reformer, excellent opportunities for humorous discussions and the display of that familiar eloquence which was his greatest gift and most effective faculty. Among other subjects, the social position of women had an all-powerful attraction for his mind, and many of his later plays were written with the object of placing in strong relief the remarkable inequality of the sexes, both as regards freedom of action and responsibility, in modern marriage. Like all the dramatists of his time, he adhered to

Scribe's mode of play-writing—a mixture of the *drame bourgeois*, as initiated by Diderot, and the comedy of character and manners, long in vogue—from the days of Molière, Regnard, Destouches and Marivaux, down to the beginning of the 19th century. In his prefaces Dumas often undertook the defence of the system which, in his estimation, was best calculated to serve the purpose of the artist, the humorist and the moralist—a dramatist being, as he conceived, a combination of the three.

Though the majority of French playgoers continued to side with him, and to cling to the time-honoured theatrical beliefs, a few young men were beginning to murmur against the too elaborate mechanism and artificial logic. Scribe and his successors, whose plays were a combination of comedy and drama, were wont to devote the first act to a brilliant and witty presentation of personages, then to crowd the following scenes with incidents, until the action was brought to a climax about the end of the fourth act, invariably concluding, in the fifth, with an optimistic *dénouement*, just before midnight, the time appointed by police regulations for the closing of playhouses. At the same time a more serious and far-reaching criticism was levelled at the very principles on which the conception of human life was then dependent. A new philosophy, based on scientific research, had been gradually gaining ground and penetrating the French mind. A host of bold writers had been trying, with considerable firmness and continuity of purpose, to start a new kind of fiction, writing in perfect accordance with the determinist theories of Auguste Comte, Darwin and Taine. The long-disputed success of the Naturalistic School carried everything before it during the years 1875-1885, and its triumphant leaders were tempted to make the best of their advantage by annexing a new province and establishing a footing on the stage. In this they failed signally, either when they were assisted by professional dramatists or when left to their own resources. It became evident that Naturalism, to be made acceptable on the stage, would have to undergo a special process of transformation and be handled in a peculiar way. Henry Becque succeeded in embodying the new theories in two plays, which at first met with very indifferent success, but were revived at a later period, and finally obtained permanent recognition in the French theatre—even with the acquiescence of the most learned critics, when they discovered, or fancied they discovered, that Becque's comedies agreed, in the main, with Molière's conception of dramatic art. In *Les Corbeaux* and *La Parisienne* the plot is very simple; the episodes are incidents taken from ordinary life. No extraneous character is introduced to discuss moral and social theories, or to acquaint us with the psychology of the real *dramatis personae*, or to suggest humorous observations about the progress of the dramatic action. The characters are left to tell their own tale in their own words, which are sometimes very comical, sometimes very repulsive, but purport to be always true to nature. Human will, which was the soul and mainspring of French tragedy in the 17th century, and played such a paramount part in the *drame bourgeois* and the *haute comédie* of the 19th, appears in M. Becque's plays to have fallen from its former exalted position and to have ceased to be a free agent. It is a mere passive instrument to our inner desires and instincts and appetites, which, in their turn, obey natural laws. Thus, in Becque's comedies, as in the old Greek drama, destiny, not man, is the chief actor, the real but unseen protagonist.

Becque was not a prolific writer, and when he died, in 1899, it was remarked that he had spent the last ten years of his life in comparative inactivity. But during these years his young and ardent disciples had spared no effort in putting their master's theories to the test. It had occurred to a gifted and enterprising actor-manager, named André Antoine, that the time had come for trying dramatic experiments in a continued and methodical manner. For this purpose he gathered around him a number of young authors, and produced their plays before a select audience of subscribers, who had paid in advance for their season-tickets. The entertainment was a strictly private one. In this way Antoine made himself independent of the censors, and at the same time was no longer obliged to consider the requirements

of the average playgoer, as is the case with ordinary managers, anxious, above all things, to secure long runs. At the Théâtre Libre the most successful play was not to be performed for more than three nights.

The reform attempted was to consist in the elimination of what was contrary to nature in Dumas's and Augier's comedies: of the *intrigue parallèle* or underplot, of the over-numerous and improbable incidents which followed the first act and taxed the spectator's memory to the verge of fatigue; and, lastly, of the conventional *dénouement* for which there was no justification. A true study of character was to take the place of Sardou's complicated fabrications and Dumas's problem plays. The authors would present the spectator with a fragment of life, but would force no conclusion upon him at the termination of the play. The reformation in histrionic art was to proceed apace. The actors and actresses of the preceding period had striven to give full effect to certain witty utterances of the author, or to preserve and to develop their own personal peculiarities or oddities. Antoine and his fellow-artists did their best to make the public realize, in every word and every gesture, the characteristic features and ruling passions of the men and women they were supposed to represent.

It was in the early autumn of 1887 that the Théâtre Libre opened its doors for the first time. It struggled on for eight years amidst unflinching curiosity, but not without encountering some adverse, or even derisive, criticism from a considerable portion of the public and the press. The Théâtre Libre brought under public notice such men as George Courteline and George Ancey, who gave respectively, in *Bombouche* and *La Dupe*, specimens of a comic vein called the "*comique cruel*." Fabre, in *L'Argent*, approached if not surpassed his master, Henry Becque. Brieux, in *Blanchette*, gave promise of talent, which he has since in a great measure justified. In *Les Fossiles* and *L'Envers d'une sainte*, by François de Curel, were found evidences of dramatic vigour and concentrated energy, allied with a remarkable gift for the minute analysis of feeling. Antoine's activity was not exclusively confined to the efforts of the French Naturalistic School; he included the Norwegian drama in his programme, and successively produced several of Ibsen's plays. They received a large amount of attention from the critics, the views then expressed ranging from the wildest enthusiasm to the bitterest irony. Franquise Sarcey was decidedly hostile, and Jules Lemaitre, who ranked next to him in authority, ventured to suggest that Ibsen's ideas were nothing better than long-discarded social and literary paradoxes, borrowed from Pierre Leroux through George Sand, and returned to the French market as novelties. Ibsen was not understood by the French public at large, though his influence could be clearly traced on thoughtful men like Paul Hervieu and François de Curel.

The authors of the Théâtre Libre were sadly wanting in tact and patience. They went at once to extremes, and, while trying to free themselves from an obsolete form of drama, fell into a state of anarchy. If a too elaborate plot is a fault, no plot at all is an absurdity. The old school had been severely taken to task for devoting the first act to the delineation of character, and the delineation of character was now found to have extended over the whole play; and worse still, most of these young men seemed to find pleasure in importing a low vocabulary on to the stage; they made it their special object to place before the spectator revolting pictures of the grossest immorality. In this they were supported by a knot of noisy and unwisdom admirers, whose misplaced approval largely contributed towards bringing an otherwise useful and interesting undertaking into disrepute. The result was that after the lapse of eight years the little group collected round Antoine had lost in cohesion and spirit, that it was both less hopeful and less compact than it had been at the outset of the campaign. But some authors who had kept aloof from the movement were not slow in reaping the moral and intellectual profit of these tentative experiments. Among them must be cited George de Porto-Riche, Henri Lavedan, Paul Hervieu, Maurice Donnay and Jules Lemaitre. Alone among the authors of the Théâtre Libre, É. Brieux secured an assured position on

the regular stage. Instead of attacking the vices and follies of his times, he has made a name by satirizing the weak points or the wrong application of certain fundamental principles by which modern institutions are supported. He mocked at universal suffrage in *L'Engrenage*, at art in *Ménages d'artistes*, at popular instruction in *Blanchette*, at charity in *Les Bienfaiteurs*, at science in *L'Évasion*, and then at law in *La Robe rouge*. Of *Les Trois Filles de M. Dupont*, one is an old maid with a strong bent towards mysticism, another is a star in the demi-monde, and the third is married. Neither religion, nor free love, nor marriage has made one of the three happy. The strange fact about Brieux is that he propounds his uncomfortable ideas with an incredible amount of dash and spirit.

All the plays written by the above-mentioned authors, and by those who follow in their steps, have been said to constitute the "new comedy." But one may question the advisability of applying the same name to literary works which present so little, if any, family likeness. It was tacitly agreed to remove the intricacies of the plot and the forced *dénouement*. But no one will trace in those plays the uniformity of moral purpose which would justify us in comprising them under the same head, as products of the same school. Then, before the Naturalistic, or half-Naturalistic, School had attained to a practical result or taken a definite shape, a wave of Romanticism swept over the French public, and in a measure brought back the old artistic and literary dogmas propounded by Victor Hugo and the generation of 1830. Signs of a revival in French dramatic poetry were not lacking. The success of *La Fille de Roland*, by the Vicomte de Bornier, was restricted to the more cultivated classes, but the vogue of Jean Richepin's *Chemineau* was at once general and lasting. *Cyrano de Bergerac*, produced in the last days of 1897, brought a world-wide reputation to its young author, Edmond Rostand. This play combines sparkling wit and brilliancy of imagination with delightful touches of pathos and delicate tenderness. It was assumed that Rostand was endowed to an extraordinary degree both with theatrical genius and the poetic faculty. *L'Aiglon* fell short of this too favourable judgment. It is more a dramatic poem than a real drama, and the author handles history with the same childish incompetence and inaccuracy as Hugo did in *Cromwell*, in *Ruy Blas* and *Hernani*. The persistent approbation of the public seemed, however, to indicate a growing taste for poetry, even when unsupported by dramatic interest—a curious symptom among the least poetical of modern European races.

To sum up, the French, as regards the present condition of their drama, were confronted with two alternative movements. Naturalism, furthered by science and philosophy, was contending against traditions three centuries old, and seemed unable to crystallize into mastery works; while romantic drama, founded on vague and exploded theories, had become embodied in productions of real artistic beauty, which have been warmly welcomed by the general playgoer. It should nevertheless be noted that in *Cyrano* and *L'Aiglon* human will, which was the mainspring of Corneille's tragedy and Hugo's drama, tried to reassert itself, but was baffled by circumstance, and had to submit to inexorable laws. This showed that the victorious school would have to reckon with the doctrines of the defeated party, and suggested that a determinist theatre might be the ultimate outcome of a compromise. (A. Fi.)

(f) English Drama.

Among the nations of Germanic descent the English alone succeeded, mainly through the influence of the Renaissance movement, in transforming the later growths of the mediæval drama into the beginnings of a great and enduring national dramatic literature, second neither in volume nor in splendour to any other in the records of the world. And, although in England, as elsewhere, the preparatory process had been continuing for some generations, its consummation coincided with one of the greatest epochs of English national history, and indeed forms one of the chief glories of that epoch itself; so that, in thinking or speaking of the Elizabethan age and the Elizabethan

drama, the one can scarcely be thought or spoken of without the other.

It is of course conceivable that the regular drama, or drama proper, might in England have been called into life without the direct influence of classical examples. Already in the reign of Edward VI. the spirit of the Reformation had (with the aid of a newly awakened desire for the study of history, which was no doubt largely due to Italian examples) quickened the relatively inanimate species of the morality into the beginning of a new development.¹ But though the *Kyng Johan* of Bale (much as this author abhorred the chronicles as written by ecclesiastics) came very near to the chronicle histories, there is no proof whatever that the work, long hidden away for very good reasons, actually served as a transition to the new species; and Bale's production was entirely unknown to the particular chronicle history which treated the same subject. Before the earliest example of this transitional species was produced, English tragedy had directly connected its beginnings with classical models.

Much in the same way, nothing could have been more natural and in accordance with the previous sluggish evolution of the English drama than that a gradual transition, however complete in the end, should have been effected from the moralities to comedy. It was not, however, John Heywood himself who was to accomplish any such transition; possibly, he was himself the author of the morality *Genus humanum* performed at the coronation feast of Queen Mary, whose council speedily forbade the performance of interludes without the queen's licence. Nor are we able to conjecture the nature of the pieces bearing this name composed by Richard Farrant, afterwards the master of the Children of St George's at Windsor, or of William Hunnis, master under Queen Elizabeth of the Children of the Chapel Royal. But the process of transition is visible in productions, also called interludes, but charged with serious purpose, such as T. Ingeland's noteworthy *Disobedient Child* (before 1560), and plays in which the element of abstractions is perceptibly yielding to that of real personages, or in which the characters are for the most part historical or the main element in the action belongs to the sphere of romantic narrative.² The demonstration would, however, be alien to the purpose of indicating the main conditions of the growth of the English drama. The immediate origin of the earliest extant English comedy must, like that of the first English tragedy, be sought, not in the development of any popular literary or theatrical antecedents, but in the imitation, more or less direct, of classical models. This cardinal fact, unmistakable though it is, has frequently been ignored or obscured by writers intent upon investigating the *origines* of our drama, and to this day remains without adequate acknowledgment in most of the literary histories accessible to the great body of students.

It is true that in tracing the entrance of the drama into the national literature there is no reason for seeking to distinguish very narrowly between the several tributaries to the main stream which fertilized this as well as other fields under Renaissance culture. The universities then still remained, and for a time became more prominently than ever, the leading agents of education in all its existent stages; and it is a patent fact that no influence could have been so strong upon the Elizabethan dramatists as that to which they had been subjected during the university life through which the large majority of them had passed. The corporate life of the universities, and the enthusiasms (habitually unanimous) of their undergraduates and younger graduates, communicated this influence, as it were automatically, to the students, and to the learned societies themselves, of the Inns of Court. In the Tudor, as afterwards in the early Stuart, times, these Inns were at once the seminaries

of loyalty, and the obvious resort for the supply of young men of spirit desirous of honouring a learned court by contributing to its choicer amusements. Thus, whether we trace them in the universities, in the "bowers" or halls of the lawyers, or in the palaces of the sovereign, the beginnings of the English academical drama, which in later Elizabethan and Jacobean literature cannot claim to be more than a subordinate species of the national drama, in an earlier period served as the actual link between classical tragedy and comedy and the surviving native growths, and supplied the actual impulse towards the beginnings of English tragedy and comedy.

The academical drama of the early years of Elizabeth's reign and of the preceding part of the Tudor period—including the school-drama in the narrower sense of the term and other performances of academical origin—consisted, ^{The earlier academical drama.} apart from actual reproductions of classical plays in the original Latin or in Latin versions of the Greek, in adaptations of Latin originals, or of Latin or English plays directly modelled on classical examples. A notable series of plays of this kind was performed in the hall of Christ Church, Oxford, from the first year of Edward VI. onward, when N. Grimald's *Archipropheta*, treating in classic form the story of St John the Baptist, but introducing the Vice and comic scenes, was brought out.³ Others were J. Calfill's *Progne* and R. Edwardes' *Palaemon* and *Arcyle* (both 1566), and, from about 1580 onwards, a succession of Latin plays by William Gager, beginning with the tragedy *Meleager*, and including, with other tragedies,⁴ a comedy *Rivales*. Yet another comedy, acted at Christ Church, and extolled in 1591 by Harington for "harmless mirth," was the *Bellum grammaticale*, or Civil War between Nouns and Verbs, which may have been a revision of a comedy written by Bale's friend, R. Radcliff, in 1538, but of which in any case the ultimate origin was a celebrated Italian allegorical treatise.⁵ In Cambridge, as is not surprising, the activity of the early academical friends and favourers of the drama was even more marked. At St John's College, where Bishop Watson's Latin tragedy called *Abolom* was produced within the years 1534 and 1544, plays were, according to Ascham, repeatedly performed about the middle of the century; at Christ's a controversial drama in the Lutheran interest called *Pammachius*, of which Gardiner complained to the privy council, and which seems afterwards to have been translated by Bale, was acted in 1544; and at Trinity there was a long series of performances which began with Christopherson's *Jephtha* about 1546, and consisted partly of reproductions of classical works,⁶ partly of plays and "shows" unnamed; while on one occasion at all events, in 1559, "two English plays" were produced. In 1560 was acted, doubtless in the original Latin, and not in Palsgrave's English translation (1540) for schoolboys, the celebrated "comedy" of *Acolastus*, by W. Gnaphaeus, on the story of the Prodigal Son. The long series of Trinity plays interspersed with occasional plays at King's (where Udall's *Ezechias* was produced in English in 1564), at St John's (where T. Legge's *Richardus III.* was first acted in 1573), and, as will be seen below, at Christ's, continued, with few noticeable breaks, up to the time when the Elizabethan drama was in full activity.⁷ Among the "academical" plays not traceable to any particular university source may be mentioned, as acted at court so early as the end of 1565 or the beginning of 1566, the Latin *Sapientia Solomonis*, which generally follows the biblical narrative, but introduces a comic element in the sayings of the popular Marcolph, who here appears as a court fool.

¹ An earlier drama by him, *Christus redemptus*, is said to have been printed at Cologne.

² *Oedipus; Diado; Ulysses redus.*

³ By A. Guarna.

⁴ *Pax; Troas; Menachmi; Oedipus; Mostellaris; Hecuba; Amphitruo; Medea.* These fall between 1546 and 1560. The date and place of the production of William Goldingham of Trinity Hall's *Herodes*, some time after 1567, are unknown.

⁵ The date and place of performance of the Latin *Fatum Vortigerni* are unknown; but it was not improbably produced at a later time than Shakespeare's *Richard II.*, which it seems in certain points to resemble.

¹ As has been already seen, Sir David Lyndsay's celebrated *Satyre of the Three Estates*, a dramatic manifesto in favour of the Reformation, is in form a morality pure and simple.

² *Tom Tyler and his Wife* (1578); *A Knack to know a Knave* (c. 1594); *Sir Clyomon and Sir Clamydes* (misattributed to G. Peele, (printed 1599)).

It was under the direct influence of the Renaissance, viewed primarily, in England as elsewhere, as a revival of classical studies, and in connexion with the growing taste in university and cognate circles of society, and at a court which prided itself on its love and patronage of learning, that English tragedy and comedy took their actual beginnings. Those of comedy, as it would seem, preceded those of tragedy by a few years. Already in Queen Mary's reign, translation was found the readiest form of expression offering itself to literary scholarship; and Italian examples helped to commend Seneca, the most modern of the ancient tragedians, and the imitator of the most human among the masters of Attic tragedy, as a favourite subject for such exercises. In the very year of Elizabeth's accession—seven years after Jodelle had brought out the earliest French tragedy—a group of English university scholars began to put forth a series of translations of the ten tragedies of Seneca, which one of them, T. Newton, in 1581 collected into a single volume. The earliest of these versions was that of the *Troades* (1559) by Jasper Heywood, a son of the author of the *Interludes*. He also published the *Thyestes* (1560) and the *Hercules Furvens* (1561); the names of his fellow-translators were A. Neville, T. Nuce, J. Studley and the T. Newton aforesaid. These translations, which occasionally include original interpolations ("additions," a term which was to become a technical one in English dramaturgy), are in no instance in blank verse, the favourite metre of the dialogue being the couplets of fourteen-syllable lines best known through Chapman's *Homer*.

The authority of Seneca, once established in the English literary world, maintained itself there long after English drama had emancipated itself from the task of imitating this pallid model, and, occasionally, Seneca's own prototype, Euripides.¹ Nor can it be doubted that some translation of the Latin tragic poet had at one time or another passed through Shakespeare's own hands. But what is of present importance is that to the direct influence of Seneca is to be ascribed the composition of the first English tragedy which we possess. Of *Corbodus* (afterwards re-named *Perrex and Porrex*), first acted on the 18th of January 1562 by the members of the Inner Temple before Queen Elizabeth, the first three acts are stated to have been written by T. Norton; the rest of the play (if not more) was the work of T. Sackville, afterwards Lord Buckhurst and earl of Dorset, whom Jasper Heywood praised for his sonnets, but who is better known for his leading share in *The Mirror for Magistrates*. Though the subject of *Corbodus* is a British legend, and though the action is neither copied nor adapted from any treated by Seneca, yet the resemblance between this tragedy and the *Thebais* is too strong to be fortuitous. In all formal matters—chorus, messengers, &c.—*Corbodus* adheres to the usage of classical tragedy; but the authors show no respect for the unities of time or place. Strong in construction, the tragedy is—like its model, Seneca—weak in characterization. The dialogue, it should be noticed, is in blank verse; and the device of the *dumb-show*, in which the contents of each act are in succession set forth in pantomime only, is employed at once to instruct and to stimulate the spectator.

The nearly contemporary *Apius and Virginia* (c. 1563), though it takes its subject—destined to become a perennial one in the modern stage—from Roman story; the *Historie of Horestes* (pr. 1567); and T. Preston's *Cambises King of Persia* (1569–1570), are somewhat rougher in form, and, the first and last of them at all events, more violent in diction, than *Corbodus*. They still contain elements of the moralities (above all the Vice) and none of the formal features of classical tragedy. But a *Julius Sesar* seems to have been performed, in precisely the same circumstances as *Corbodus*, so early as 1562; and, four years later, G. Gascoigne, the author of the satire *The Steele Glass*, produced with the aid of two associates (F. Kinwelmerah and Sir Christopher Yelverton,

who wrote an epilogue), *Jocasta*, a virtual translation of L. Dolce's *Giocasta*, which was an adaptation, probably, of R. Winter's Latin translation of the *Phocissae* of Euripides.² Between the years 1567 and 1580 a large proportion of the plays presented at court by choir- or school-boys, and by various companies of actors, were taken from Greek legend or Roman history; as was R. Edwards' *Damon and Pithias* (perhaps as early as 1564–1565), which already shades off from tragedy into what soon came to be called *tragi-comedy*.³ Simultaneously with the influence, exercised directly or indirectly, of classical literature, that of Italian, both dramatic and narrative, with its marked tendency to treat native themes, asserted itself, and, while diversifying the current of early English tragedy, infused into it a long-abiding element of passion. There are sufficient grounds for concluding that a play on the subject of *Romeo and Juliet*, which L. da Porto and M. Bandello had treated in prose narrative—that of the latter having through a French version formed itself into the English poem—was seen on an English stage in or before 1562. *Gismonde of Salerno*, a play founded on Boccaccio, was acted before Queen Elizabeth at the Inner Temple in 1568, nearly a generation before it was published, rewritten in blank verse by R. Wilmot, one of the performers, then in holy orders; G. Whetstone's *Promos and Cassandra*, founded on G. Cinthio (from which came the plot of *Measure for Measure*), followed, printed in 1578; and there were other "casts of Italian devices" belonging to this age, in which the choice of a striking theme still seemed the chief preoccupation of English tragic poets.

From the double danger which threatened English tragedy in the days of its infancy—that it would congeal on the wintry heights of classical themes, or dissolve its vigour in the glowing heat of a passion fiercer than that of the Italians—*Inglese Italianato è un diavolo incarnato*—it was preserved more than by any other cause by its happy association with the traditions of the national history. An exceptional position might seem to be in this respect occupied by T. Hughes' interesting tragedy *The Misfortunes of Arthur* (1587). But the author of this play—in certain portions of whose framework there were associated with him seven other members of Gray's Inn, including Francis Bacon, and which was presented before Queen Elizabeth like *Corbodus*—in truth followed the example of the authors of that work both in choice of theme, in details of form, and in a general though far from servile imitation of the manner of Seneca; nor does he represent any very material advance upon the first English tragedy.

Fortunately, at the very time when from such beginnings as those just described the English tragic drama was to set forth upon a course in which it was to achieve so much, a new sphere of activity suggested itself. And in this, after a few more or less tentative efforts, English dramatists very speedily came to feel at home. In their direct dramatization of passages or portions of English history (in which the doings and sufferings of King Arthur could only by courtesy or poetic licence be included) classical models would be of scant service, while Italian examples of the treatment of national historical subjects, having to deal with material so wholly different, could not be followed with advantage. The native species of the *chronicle history*, which designedly assumed this name in order to make clear its origin and purpose, essayed nothing more or less than a dramatic version of an existing chronicle. Obviously, while the transition from half historical, half epical narrative often implied carrying over into the new form some of the features of the old, it was only when the subject matter had been remoulded and recast that a true dramatic action could result. Put the *histories* to be found among the plays of Shakespeare and one or two other Elizabethans are true dramas, and it would be inconvenient to include these in the transitional species of those known as *chronicle histories*. Among these ruder

¹ "Supposes" and "Jocasta," ed. J. W. Cunliffe.

² His *Palamon and Arcyte* (produced in Christ Church hall, Oxford, in 1566) is not preserved; or we should be able to compare with *The Two Noble Kinsmen* this early dramatic treatment of a singularly fine theme.

compositions, which intermixed the blank verse introduced on the stage by *Gorboduc* with prose, and freely combined or placed side by side tragic and comic ingredients, we have but few distinct examples. One of these is *The Famous Victories of Henry the Fifth*, known to have been acted before 1588; in which both the verse and the prose are frequently of a very rude sort, while it is neither divided into acts or scenes nor, in general, constructed with any measure of dramatic skill. But its vigour and freshness are considerable, and in many passages we recognize familiar situations and favourite figures in later masterpieces of the English historical drama. The second is *The Troublesome Reign of King John*, in two parts (printed in 1591), an epical narrative transferred to the stage, neither a didactic effort like *Bala's*, nor a living drama like Shakespeare's, but a far from contemptible treatment of its historical theme. *The True Chronicle History of King Lear* (acted in 1593) in form resembles the above, though it is not properly on a national subject (its story is taken from Geoffrey of Monmouth); but, with all its defects, it seems only to await the touch of the master's hand to become a tragedy of supreme effectiveness. A yet further step was taken in the *Tragedy of Sir Thomas More* (c. 1590)—in which Shakespeare's hand has been thought traceable, and which deserves its designation of "tragedy" not so much on account of the relative nearness of the historical subject to the date of its dramatic treatment, as because of the tragic responsibility of character here already clearly worked out.

Such had been the beginnings of tragedy in England up to the time when the genius of English dramatists was impelled by the spirit that dominates a great creative epoch of literature to seize the form ready to their hands.

Earliest comedies.

The birth of English comedy, at all times a process of less labour and eased by an always ready popular responsiveness to the most tentative efforts of art, had slightly preceded that of her serious sister. As has been seen from the brief review given above of the early history of the English academical drama, isolated Latin comedies had been performed in the original or in English versions as early as the reign of Henry VIII.—perhaps even earlier; while the morality and its direct descendant, the interlude, pointed the way towards popular treatment in the vernacular of actions and characters equally well suited for the diversion of Roman, Italian and English audiences. Thus there was no innovation in the adaptation by N. Udal (q.v.) of the *Miles Gloriosus* of Plautus under the title of *Ralph Roister Doister*, which may claim to be the earliest extant English comedy. It has a genuinely popular vein of humour, and the names fit the characters after a fashion familiar to the moralities. The second English comedy—in the opinion of at least one high authority our first—is *Misogonus*, which was certainly written as early as 1560. Its scene is laid in Italy; but the Vice, commonly called "Cacurgus," is both by himself and others frequently designated as "Will Summer," in allusion to Henry VIII.'s celebrated jester. *Gammer Gurton's Needle*, long regarded as the earliest of all English comedies, was printed in 1575, as acted "not long ago in Christ's College, Cambridge." Its authorship was till recently attributed to John Still (afterwards bishop of Bath and Wells), who was a resident M.A. at Christ's, when a play was performed there in 1566. But the evidence of his authorship is inconclusive, and the play "made by Mr. S., Master of Arts," may be by William Stevenson, or by some other contemporary. This comedy is slighter in plot and coarser in diction than *Ralph Roister Doister*, but by no means unamusing.

In the main, however, early English comedy, while occasionally introducing characters and scenes of thoroughly native origin and complexion (e.g. Grim, the Collier of Croydon), was content to borrow its themes from classical or Italian sources.¹ G. Gascoigne's *Supposes* (acted at Gray's Inn in 1566) is a translation of *I Suppositi* of Ariosto, remarkable for the flowing facility of ¹ *The History of the Collier*.

² *A Historie of Error* (1577), one of the many imitations of the *Menæchmi*, may have been the foundation of the *Comedy of Errors*. In the previous year was printed the old *Taming of a Shrew*, founded on a novel of G. F. Straparola. Part of the plot of Shakespeare's *of the Shrew* may have been suggested by *The Supposes*.

its prose. While, on the one hand, the mixture of tragic with comic motives, which was to become so distinctive a feature of the Elizabethan drama, was already leading in the direction of tragic-comedy, the precedent of the Italian pastoral drama encouraged the introduction of figures and stories derived from classical mythology; and the rapid and diversified influence of Italian comedy, in close touch with Italian prose fiction, seemed likely to affect and quicken continuously the growth of the lighter branch of the English drama.

Out of such promises as these the glories of English drama were ripened by the warmth and light of the great Elizabethan age—of which the beginnings may fairly be reckoned from the third decennium of the reign to which it owes its name. The queen's steady love of dramatic entertainments could not of itself have led, though it undoubtedly contributed, to such a result. Against the attacks which a nascent puritanism was already directing against the stage by the hands of J. Northbrooke,³ the repentant playwright S. Gosson,⁴ P. Stubbes,⁵ and others,⁶ were to be set not only the frugal favour of royalty and the more liberal patronage of great nobles,⁷ but the fact that literary authorities were already weighing the endeavours of the English drama in the balance of respectful criticism, and that in the abstract at least the claims of both tragedy and comedy were upheld by those who shrank from the despicience of idle pastimes. It is noticeable that this period in the history of the English theatre coincides with the beginning of the remarkable series of visits made to Germany by companies of English comedians, which did not come to an end till the period immediately before the Thirty Years' War, and were occasionally resumed after its close. As at home the popularity of the stage increased, the functions of playwright and actor, whether combined or not, began to hold out a reasonable promise of personal gain. Nor, above all, was that higher impulse which leads men of talent and genius to attempt forms of art in harmony with the tastes and tendencies of their times wanting to the group of writers who can be remembered by no nobler name than that of Shakespeare's predecessors.

The lives of all of these are, of course, in part contemporary with the life of Shakespeare himself; nor was there any substantial difference in the circumstances under which most of them, and he, led their lives as dramatic authors. A distinction was manifestly kept up between poets and playwrights. Of the contempt entertained for the actor's profession some fell to the share of the dramatist; "even Lodge," says C. M. Ingleby, "who had indeed never trod the stage, but had written several plays, and had no reason to be ashamed of his antecedents, speaks of the vocation of the play-maker as sharing the odium attaching to the actor." Among the dramatists themselves good-fellowship and literary partnership only at times asserted themselves as stronger than the tendency to mutual jealousy and abuse; of all chapters of dramatic history, the annals of the early Elizabethan stage perhaps least resemble those of Arcadia.

Moreover, the theatre had hardly found its strength as a powerful element in the national life, when it was involved in a bitter controversy, with which it had originally no connexion, on behalf of an ally whose sympathy with it can only have been of a very limited kind. The Marprelate controversy, into which, among leading playwrights, Lyly and Nashe were drawn, in 1580 led to a stoppage

¹ *Treatise wherein Dicing, Dauncing, Vaine Playes or Enteriudes . . . are reproved, &c.* (1577).

² *The School of Abuse*.

³ *The Anatomy of Abuses*.

⁴ H. Denham, G. Whetstone (the author of *Promos and Cassandra*), W. Rankine.

⁷ It may be mentioned that the practice of companies of players, of one kind or another, being taken into the service of members of the royal family, or of great nobles, dates from much earlier times than the reign of Elizabeth. So far back as 1400/1 the corporation of Shrewsbury paid rewards to the *historiones* of Prince Henry and of the earl of Stafford, and in 1408/9 reference is made to the players of the earl and counts of Arundel, of Lord Powys, of Lord Talbot and of Lord Furnival.

Conditions of the early Elizabethan drama.

The predecessors of Shakespeare.

History of the Elizabethan stage.

of stage-plays which proved only temporary; but the general result of the attempt to make the stage a vehicle of political abuse and invective was beyond a doubt to coarsen and degrade both plays and players. Scurrilous attempts and rough repression continued during the years 1590-1593; and the true remedy was at last applied, when from about 1594, the chief London actors became divided into two great rival companies—the lord chamberlain's and the lord admiral's—which alone received licences. Instead of half a dozen or more companies whose jealousies communicated themselves to the playwrights belonging to them, there were now, besides the Children of the Chapel, two established bodies of actors, directed by steady and, in the full sense of the word, respectable men. To the lord chamberlain's company, which, after being settled at "the Theater" (opened as early as 1576 or 1577), moved to Blackfriars, purchased by James Burbage, in 1596, and to the Globe on the Bankside in 1599, Shakespeare and Richard Burbage, the greatest of the Elizabethan actors, belonged; the lord admiral's was managed by Philip Henslowe, the author of the *Diary*, and Edward Alleyn, the founder of Dulwich College, and was ultimately, in 1600, settled at the Fortune. In these and other houses were performed the plays of the Elizabethan dramatists, with few adventitious aids, the performance being crowded into a brief afternoon, when it is obvious that only the idler sections of the population could attend. No woman might appear at a playhouse, unless masked; on the stage, down to the Restoration, women's parts continued to be acted by boys.

It is futile to take no account of such outward circumstances as these and many which cannot here be noted in surveying the progress of the literature of the Elizabethan drama. Like that of the Restoration—and like that of the present day—it was necessarily influenced in its method and spirit of treatment by the conditions and restrictions which governed the place and circumstances of the performance of plays, including the construction of theatre and stage, as well as by the social composition of its audiences, which the local accommodation, not less than the entertainment, provided for them had to take into account. But to these things a mere allusion must suffice. It may safely be said, at the same time, that no dramatic literature which has any claim to rank beside the Elizabethan—not that of Athens nor those of modern Italy and Spain, nor those of France and Germany in their classic periods—had to contend against such odds; a mighty inherent strength alone ensured to it the vitality which it so triumphantly asserted, and which enabled it to run so unequalled a course.

Among Shakespeare's predecessors, John Lyly, whose plays were all written for the Children of the Chapel and the Children of St Paul's, holds a position apart in English dramatic literature. The cuphuism, to which his famous romance gave its name, likewise distinguishes his mythological,¹ quasi-historical,² allegorical,³ and satirical⁴ comedies. But his real service to the progress of English drama is to be sought neither in his choice of subjects nor in his imagery—though to his fondness for fairylure and for the whole phantasmagoria of legend, classical as well as romantic, his contemporaries, and Shakespeare in particular, were indebted for a stimulative precedent, and though in his *Endimion* at all events he excites curiosity by an allegorical treatment of contemporary characters and events. It does not even lie in the songs interspersed in his plays, though none of his predecessors had in the slightest degree anticipated the lyric grace which distinguishes some of these incidental efforts. It consists in his adoption of Gascoigne's innovation of writing plays in prose; and in his having, though under the fetters of an affected and pretentious style, given the first example of brisk and vivacious dialogue—an example to

which even such successors as Shakespeare and Jonson were indebted. Thomas, Kyd, the author of the *Spanish Tragedy* (preceded or followed by the first part of *Jeronimo*), and probably of several plays whose author was

unnamed, possesses some of the characteristics, but none of the genius, of the greatest tragic dramatist who preceded Shakespeare. No slighter tribute than this is assuredly the due of Christopher Marlowe, whose violent end prematurely closed a poetic career of dazzling brilliancy. His earliest play, *Tamburlaine the Great*, in which the use of blank verse was introduced upon the English public stage, while full of the "high astounding terms" of an extravagant and often bombastic diction, is already marked by the passion which was the poet's most characteristic feature, and which was to find expression so luxuriantly beautiful in his *Doctor Faustus*, and so surpassingly violent in his *Jew of Malta*. His masterpiece, *Edward II.*, is a tragedy of singular pathos and of a dramatic power unapproached by any of his contemporaries.

Poet.
George Peele was a far more versatile writer even as a dramatist; but, though his plays contain passages of exquisite beauty, not one of them is worthy to be ranked by the side of Marlowe's *Edward II.*, compared with which, if indeed not absolutely, Peele's *Chronicle of Edward I.* still stands on the level of the species to which its title and character alike assign it. His finest play is undoubtedly *David and Belshazzar*, which resembles *Edward I.* in construction, but far surpasses it in beauty of language and versification, besides treating its subject with greatly superior dignity. If the difference between Peele and Shakespeare is still, in many respects besides that of genius, an immeasurable one, we seem to come into something like a Shakespearean atmosphere in more than one passage of the plays of the unfortunate Robert Greene—

Green.
fortunate perhaps in nothing more enduringly than in the proof which he left behind him of his supercilious jealousy of Shakespeare. Greene's genius, most conspicuous in plays treating English life and scenes, could, notwithstanding his academic self-sufficiency, at times free itself from the pedantry apt to beset the flight of Peele's and at times even of Marlowe's muse; and his most delightful work⁵ seems to breathe something of the air, sweet and fresh like no other, which blows over an English countryside. Thomas Lodge, whose dramatic, and much less of course his literary activity, is measured by the only play that we know to have been wholly his,⁶ Thomas Nashe, the redoubtable pamphleteer and the father of the English picaresque novel;⁷ Henry Chettle, who worked the chords of both pity⁸ and terror⁹ with equal vigour, and Anthony Munday, better remembered for his city pageants than for his plays, are among the other more important writers of the early Elizabethan drama, though not all of them can strictly speaking be called predecessors of Shakespeare. It is not possible here to enumerate the more interesting of the anonymous plays which belong to this "pre-Shakespearean" period of the Elizabethan drama; but many of them are by intrinsic merit as well as for special causes deserving of the attention of the student.

The common characteristics of nearly all these dramatists and plays were in accordance with those of the great age to which they belonged. Stirring times called for stirring themes, such as those of "Mahomet, Scipio and Tamerlane"; and these again for a corresponding vigour of treatment. Neatness and symmetry of construction were neglected for fulness and variety of matter. Novelty and grandeur of subject seemed well matched by a swelling amplitude and often reckless extravagance of diction. As if from an inner necessity, the balance of rhymed couplets gave way to the impetuous march of blank verse; "strong lines" were as inevitably called for as strong situations and strong characters. Although the chief of these poets are marked off from one another by the individual genius which impressed itself upon both the form and the matter of their works, yet the stamp of the age is upon them all. Writing

¹ *Friar Bacon and Friar Bungay.*

² *The Wounds of Civil War.* With Greene he wrote *A Looking-Glass for London*

³ *Summer's Last Will and Testament* is his sole entire extant play.

⁴ *Dido, Queen of Carthage*, is by him and Marlowe.

⁵ *Patient Grisild* (with Dekker and Haughton).

⁶ *Hoffman, or A Revenge for a Father.*

¹ *The Woman in the Moone; Sapho and Phao.*

² *Alexander and Campaspe.*

³ *Endimion; Mydas.*

⁴ *Gallathea.*

for the stage only, of which some of them possessed a personal experience and from which none of them held aloof, they acquired an instinctive insight into the laws of dramatic cause and effect, and infused a warm vitality into the dramatic literature which they produced, so to speak, for immediate consumption. On the other hand, the same cause made rapidity of workmanship indispensable to a successful playwright. How a play was produced, how many hands had been at work upon it, what loans and what spoiliations had been made in the process, were considerations of less moment than the question whether it was produced, and whether it succeeded. His harness—frequently double or triple—was inseparable from the lusty Pegasus of the early English drama, and its genius toiled, to borrow the phrase of the Attic comedian, “like an Arcadian mercenary.”

This period of the English drama, though it is far from being one of crude effort, could not therefore yet be one of full consummation. In tragedy the advance which had been made in the choice of great themes, in knitting closer the connection between the theatre and the national history, in vindicating to passion its right to adequate expression, was already enormous. In comedy the advance had been less decisive and less independent; much had been gained in reaching greater freedom of form and something in enlarging the range of subjects; but artificiality had proved a snare in the one direction, while the licence of the comic stage, upheld by favourite “clowns,” such as Kemp or Tarlton, had not succumbed before less elastic demands. The way of escaping from the dilemma had, however, been already recognized to lie in the construction of suitable plots, for which a full storehouse was open in the popular traditions preserved in national ballads, and in the growing literature of translated foreign fiction, or of native imitations of it. Meanwhile, the aberration of the comic stage to political and religious controversy, which it could never hope to treat with Attic freedom in a country provided with a strong monarchy and a dogmatic religion, seemed likely to extinguish the promise of the beginnings of English romantic comedy.

These were the circumstances under which the greatest of dramatists began to devote his genius to the theatre. Shakespeare's career as a writer of plays can have differed little in its beginnings from those of his contemporaries and rivals. Before or while he was proceeding from the re-touching and re-writing of the plays of others to original dramatic composition, the most gifted of those whom we have termed his predecessors had passed away. He had been decried as an actor before he was known as an author; and after living through days of darkness for the theatre, if not for himself, attained, before the close of the century, to the beginnings of his prosperity and the beginnings of his fame. But if we call him fortunate, it is not because of such rewards as these. As a poet, Shakespeare was no doubt happy in his times, which intensified the strength of the national character, expanded the activities of the national mind, and were able to add their stimulus even to such a creative power as his. He was happy in the antecedents of the form of literature which commended itself to his choice, and in the opportunities which it offered in so many directions for an advance to heights yet undiscovered and unknown. What he actually accomplished was due to his genius, whose achievements are immeasurable like itself. His influence upon the progress of English drama divides itself in very unequal proportions into a direct and an indirect influence. To the former alone reference can here be made.

Already the first editors of Shakespeare's works in a collected form recognized so marked a distinction between his plays taken from English history and those treating other historical subjects (whether ancient or modern) that, while they included the latter among the tragedies at large, they grouped the former as *histories* by themselves. These *histories* are in their literary genesis a development of the *chronicle histories* of Shakespeare's predecessors and contemporaries, the taste for which had greatly increased towards the beginning of his own career as a dramatist,

in accordance with the general progress of national life and sentiment in this epoch. Though it cannot be assumed that Shakespeare composed his several dramas from English history in the sequence of the chronology of their themes, his genius gave to the entire series an inner harmony, and a continuity corresponding to that which is distinctive of the national life, such as not unnaturally inspired certain commentators with the wish to prove it a symmetrically constructed whole. He thus brought this peculiarly national species to a perfection which made it difficult, if not impossible, for his later contemporaries and successors to make more than an occasional addition to his series. None of them was, however, found able or ready to take up the thread where Shakespeare had left it, after perfunctorily attaching the present to the past by a work (probably not all his own) which must be regarded as the end rather than the crown of the series of his *histories*.¹ But to furnish such supplements accorded little with the tastes and tendencies of the later Elizabethans; and with the exception of an isolated work,² the national historical drama in Shakespeare reached at once its perfection and its close. The ruder form of the old chronicle history for a time survived the advance made upon it; but the efforts in this field of T. Heywood,³ S. Rowley,⁴ and others are, from a literary point of view, anachronisms.

Of Shakespeare's other plays the several groups exercised a more direct influence upon the general progress of our dramatic literature. His Roman tragedies, though following their authorities with much the same fidelity as that of the English *histories*, even more effectively taught the great lesson of free dramatic treatment of historic themes, and thus pre-eminently became the perennial models of the modern historic drama. His tragedies on other subjects, which necessarily admitted of a more absolute freedom of treatment, established themselves as the examples for all time of the highest kind of tragedy. Where else is exhibited with the same fulness the struggle between will and obstacle, character and circumstance? Where is mirrored with equal power and variety the working of those passions in the mastery of which over man lies his doom? Here, above all, Shakespeare as compared with his predecessors, as well as with his successors, “is that nature which they paint and draw.” He threw open to modern tragedy a range of hitherto unknown breadth and depth and height, and emancipated the national drama in its noblest forms from limits to which it could never again restrict itself without a consciousness of having renounced its enfranchisement. Happily for the variety of his creative genius on the English stage, no divorce had been proclaimed between the serious and the comic, and no division of species had been established such as he himself ridicules as pedantic when it professes to be exhaustive. The comedies of Shakespeare accordingly refuse to be tabulated in deference to any method of classification deserving to be called precise; and several of them are comedies only according to a purely technical use of the term. In those in which the instinct of reader or spectator recognizes the comic interest to be supreme, it is still of its nature incidental to the progress of the action; for the criticism seems just, as well as in agreement with what we can conclude as to Shakespeare's process of construction, that among all his comedies not more than a single one⁵ is in both design and effect a comedy of character proper. Thus in this direction, while the unparalleled wealth of his invention renewed or created a whole gallery of types, he left much to be done by his successors; while the truest secrets of his comic art, which interweaves fancy with observation, draws wisdom from the lips of fools, and imbues with character what all other hands would have left shadowy, monstrous or trivial, are among the things inimitable belonging to the individuality of his poetic genius.

The influences of Shakespeare's diction and versification upon those of the English drama in general can hardly be overrated, though it would be next to impossible to state them definitely. In these points, Shakespeare's manner as a writer was progressive;

¹ Henry VIII.

² Ford, *Perkin Warbeck*.

³ Edward IV.; *If You Know Not Me, &c.*

⁴ Henry VIII.

⁵ *The Merry Wives of Windsor*.

and this progress has been deemed sufficiently well traceable in his plays to be used as an aid in seeking to determine their chronological sequence. The general laws of this progress accord with those of the natural advance of creative genius; artificiality gives way to freedom, and freedom in its turn submits to a greater degree of regularity and care. In versification as in diction the earliest and the latest period of Shakespeare's dramatic writing are more easily recognizable than what lies between and may be called the *normal* period, the plays belonging to which in form most resemble one another, and are least affected by distinguishable peculiarities—such as *astherhymes* and intentionally euphuistic colouring of style which characterize the earliest, or the feminine endings of the lines and the more condensed manner of expression common to the latest of his plays. But, such distinctions apart, there can be no doubt but that in verse and in prose alike, Shakespeare's style, so far as it admitted of reproduction, is itself to be regarded as the *norm* of that of the Elizabethan drama; that in it the prose form of English comedy possesses its first accepted model; and that in it the chosen metre of the English versified drama established itself as irremovable unless at the risk of an artificial experiment.

The assertion may seem paradoxical, that it is by their construction that Shakespeare's plays exerted the most palpable influence upon the English drama, as well as upon the modern drama of the Germanic nations in general, and upon such forms of the Romance drama as have been in more recent times based upon it. For it was not in construction that his greatest strength lay, or that the individuality of his genius could raise him above the conditions under which he worked in common with his immediate predecessors and contemporaries. Yet the fact that he accepted these conditions, while producing works of matchless strength and of unequalled fidelity to the demands of nature and art, established them as inseparable from the Shakespearian drama—to use a term which is perhaps unavoidable but has been often misapplied. The great and irresistible demand on the part of Shakespeare's public was for *incident*—a demand which of itself necessitated a method of construction different from that of the Greek drama, or of those modelled more or less closely upon it. To no other reason is to be ascribed the circumstance that Shakespeare so constantly combined two actions in the course of a single play, not merely supplementing the one by means of the other as a *bye- or under-plot*. In no respect is the progress of his technical skill as a dramatist more apparent,—a proposition which a comparison of plays clearly ascribable to successive periods of his life must be left to prove.

Should it, however, be sought to express in one word the greatest debt of the drama to Shakespeare, this word must be the same as that which expresses his supreme gift as a dramatist. It is in *characterization*—in the drawing of characters ranging through almost every type of humanity which furnishes a fit subject for the tragic or the comic art—that he remains absolutely unapproached; and it was in this direction that he pointed the way which the English drama could not henceforth desert without becoming untrue to itself. It may have been a mere error of judgment which afterwards held him to have been surpassed by others in particular fields of characterization (setting him down, forsooth, as supremely excellent in male, but not in female, characters). But it was a sure sign of decay when English writers began to shrink from following him in the endeavour to make the drama a mirror of humanity, and when, in self-condemned arrogance, they thrust unreality back upon a stage which he had animated with the warm breath of life, where Juliet had blossomed like a flower of spring, and where Othello's noble nature had suffered and sinned.

By the numerous body of poets who, contemporary with Shakespeare or in the next generation, cultivated the wide field of the national drama, every form commending itself to the tastes and sympathies of the national genius was essayed. None were neglected except those from which the spirit of English

literature had been estranged by the Reformation, and those which had from the first been artificial importations of the Renaissance. The mystery could not in England, as in Spain, produce such an aftergrowth as the *auto*, and the confines of the religious drama were only now and then tentatively touched.¹ The direct imitations of classical examples were, except perhaps in the continued efforts of the academical drama, few and feeble. Chapman, while resorting to use of narrative in tragedy and perhaps otherwise indebted to ancient models, was no follower of them in essentials. S. Daniel (1562–1610) may be regarded as a belated disciple of Seneca,² while experiments like W. Alexander's (afterwards earl of Stirling) *Monarchiche Tragedies*³ (1603–1605) are the mere isolated efforts of a student, and more exclusively so than Milton's imposing *Samson Agonistes*, which belongs to a later date (1677). At the opposite end of the dramatic scale, the light gaiety of the Italian and French farce could not establish itself on the English popular stage without more substantial adjuncts; the Englishman's festive digestion long continued robust, and he liked his amusements solid. In the pastoral drama and the mask, however, many English dramatists found special opportunities for the exercise of their lyrical gifts and of their inventive powers. The former could never become other than an exotic, so long as it retained the artificial character of its origin. Shakespeare had accordingly only blended elements derived from it into the action of his romantic comedies. In more or less isolated works Jonson, Fletcher, Daniel, Randolph, and others sought to rival Tasso and Guarini—Jonson⁴ coming nearest to nationalizing an essentially foreign growth by the fresh simplicity of his treatment, Fletcher⁵ bearing away the palm for beauty of poetic execution, Daniel being distinguished by simpler beauties of style in both verse and prose.⁶

The mask (or masque) was a more elastic kind of composition, mixing in varying proportions its constituent elements of declamation and dialogue, music and dancing, decoration and scenery. In its least elaborate literary form—which, of course, externally was the most elaborate—it closely approached the pageant; in other instances the distinctness of its characters or the fulness of the action introduced into its scheme, brought it nearer to the regular drama. A frequent ornament of Queen Elizabeth's progresses, it was cultivated with increased assiduity in the reign of James I., and in that of his successor outshone, by the favour it enjoyed with court and nobility, the attractions of the regular drama itself. Most of the later Elizabethan dramatists contributed to this species, upon which Shakespeare expended the resources of his fancy only incidentally in the course of his dramas; but by far the most successful writer of masks was Ben Jonson, of whose numerous compositions of this kind many hold a permanent place in English poetic literature, and "next" whom, in his own judgment, "only Fletcher and Chapman could write a mask." From a poetic point of view, however, they were at least rivalled by Dekker and Ford; in productivity and favour T. Campion, who was equally eminent as poet and as musician, seems for a time to have excelled. Inasmuch, however, as the history of the mask in England is to a great extent that of "painting and carpentry" and of Inigo Jones, and as, moreover, this kind of piece, while admitting dramatic elements, is of its nature occasional, it need not further be pursued here. The *Microcosmus* of T. Nabbes (printed 1637), which is very like a morality, seems to have been the first mask brought upon the public stage. It was the performance of a mask by Queen Henrietta Maria and her ladies at Whitehall which had some years previously (1632) been thought to have supplied to the invective of *Histrion-Mastix* against the stage the occasion for disloyal innuendo; and it was for the performance of a

¹ Massinger. *The Virgin Martyr*; Shirley, *St Patrick for Ireland*.

² *Cleopatra*; *Philotas*.

³ *Darius*; *Croesus*; *Julius Caesar*; *The Alexandreaan Tragedy*.

⁴ *The Sad Shepherd*.

⁵ *The Queen's Arcadia*.

mask in a great nobleman's castle that Milton—a Puritan of a very different cast—not long afterwards (1634) wrote one of the loftiest and loveliest of English poems. *Comus* has been judged and condemned as a drama—unjustly, for the dramatic qualities of a mask are not essential to it as a species. Yet its history in England remains inseparably connected with that of the Elizabethan drama. In later times the mask merged into the opera, or continued a humble life of its own apart from contact with higher literary effort. It is strange that later English poets should have done so little to restore to its nobler uses, and to invest with a new significance, a form so capable of further development as the poetic mask.

The annals of English drama proper in the period reaching from the closing years of Elizabeth to the outbreak of the great Revolution include, together with numerous names relatively insignificant, many illustrious in the history of our poetic literature. Among Shakespeare's contemporaries and successors there is, however, but one who by the energy of his genius, not less than by the circumstances of his literary career, reached undisputed primacy among his fellows. Ben Jonson, to whom in his latter days a whole generation of younger writers did filial homage as to their veteran chief, was alone in full truth the founder of a school or family of dramatists. Yet his pre-eminence did not (whatever he or his followers may have thought) extend to both branches of the regular drama. In tragedy he fell short of the highest success; the weight of his learning lay too heavily upon his efforts to draw from deeper sources than those which had sufficed for Shakespeare. Such as they are, his tragic works¹ stand almost, though not quite, alone in this period as examples of sustained effort in historic tragedy proper. G. Chapman treated stirring themes, more especially from modern French history,² always with vigour, and at times with genuine effectiveness; but, though rich in beauties of detail, he failed in this branch of the drama to follow Shakespeare even at a distance in the supreme art of fully developing a character by means of the action. Mention has been made above of Ford's isolated effort in the direction of historic tragedy, as well as of excursions into the still popular domain of the chronicle history by T. Heywood, Dekker and others, which cannot be regarded as anything more than retrogressions. With the great body of the English dramatists of this and of the next period, tragedy had passed into a phase where its interest depended mainly upon plot and incident. The romantic tragedies and tragi-comedies which crowd English literature in this period constitute together a growth of at first sight astonishing exuberance, and in mere externals of theme—ranging as these plays do from Byzantium to ancient Britain, and from the Caesars of ancient Rome to the tyrants of the Renaissance—of equally astonishing variety. The sources from which these subjects were derived had been perennially augmenting. Besides Italian, Spanish and French fiction, original or translated, besides British legend in its Romance dress, and English fiction in its humbler or in its more ambitious and artificial forms, the contemporary foreign drama, especially the Spanish, offered opportunities for resort. To the English, as to the French and Italian drama, of both this and the following century, the prolific dramatists clustering round Lope de Vega and Calderon, and the native or naturalized fictions from which they drew their materials supplied a whole arsenal of plots, incidents and situations—among others to Middleton, to Webster, and most signally to Beaumont and Fletcher. And, in addition to these resources, a new field of supply was at hand since English dramatists had begun to regard events and episodes of domestic life as fit subjects for tragic treatment. Domestic tragedy of this description was indeed no novelty on the English stage; Shakespeare himself may have retouched with his master-hand more than one effort of this kind;³ but T. Heywood may be set down as the first who achieved any work of considerable

literary value of this class,⁴ to which some of the plays of T. Dekker, T. Middleton, and others likewise more or less belong. Yet, in contrast to this wide variety of sources, and consequent apparent variety of themes, the number of *motives* employed—at least as a rule—in the tragic drama of this period was comparatively small and limited. Hence it is that, notwithstanding the diversity of subjects among the tragic dramas of such writers as Marston, Webster, Fletcher, Ford and Shirley, an impression of sameness is left upon us by a connected perusal of these works. Scheming ambition, conjugal jealousy, absolute female devotion, unbridled masculine passion—such are the motives which constantly recur in the Decameron of our later Elizabethan drama. And this impression is heightened by the want of moderation, by the extravagance of passion, which these dramatists so habitually exhibit in the treatment of their favourite themes. All the tragic poets of this period are not equally amenable to this charge; in J. Webster,⁵ master as he is of the effects of the horrible, and in J. Ford,⁶ surpassingly seductive in his sweetness, the monotony of exaggerated passion is broken by those marvellously sudden and subtle touches through which their tragic genius creates its most thrilling effects. Nor will the tendency to excess of passion which F. Beaumont and J. Fletcher undoubtedly exhibit be confounded with their distinctive power of sustaining tenderly pathetic characters and irresistibly moving situations in a degree unequalled by any of their contemporaries—a power seconded by a beauty of diction and softness of versification which for a time raised them to the highest pinnacle of popular esteem, and which entitles them in their conjunction, and Fletcher as an independent worker, to an enduring pre-eminence among their fellows. In their morals Beaumont and Fletcher are not above the level of their age. The manliness of sentiment and occasionally greater width of outlook which enable the rhetorical genius of P. Massinger, and the gift of poetic illustration which entitles J. Shirley to be remembered not merely as the latest and the most fertile of this group of dramatists, have less direct bearing upon the general character of the tragic art of the period. The common features of the romantic tragedy of this age are sufficiently marked; but they leave unobscured the distinctive features in its individual writers of which a discerning criticism has been able to take note.

In comedy, on the other hand, the genius and the insight of Jonson pointed the way to a steady and legitimate advance. His theory of "humours" (which found the most palpable expression in two of his earliest plays⁷), if translated into the ordinary language of dramatic art, signifies the paramount importance in the comic drama of the presentation of distinctive human types. As such it survived by name into the Restoration age⁸ and cannot be said to have ever died out. In the actual reproduction of humanity in its infinite but never, in his hands, alien variety, it was impossible that Shakespeare should be excelled by Jonson; but in the consciousness with which he recognized and indicated the highest sphere of a comic dramatist's labours, he rendered to the drama a direct service which the greater master had left unperformed. By the rest of his contemporaries and his successors, some of whom, such as R. Brome, were content avowedly to follow in his footsteps, Jonson was only occasionally rivalled in individual instances of comic creations; in the entirety of its achievements his genius as a comic dramatist remained unapproached. The favourite types of Jonsonian comedy, to which Dekker, J. Marston and Chapman had, though to no large extent, added others of their own, were elaborated with incessant zeal and remarkable effect by their contemporaries and successors. It was after a very different fashion from that in which the Roman comedians reiterated the ordinary types of the New Attic comedy, that the inexhaustible *verve* of T. Middleton, the buoyant productivity of Fletcher, the observant humour of N. Field, and the artistic

¹ *Sejanus his Fall; Catiline his Conspiracy.*

² *Bussy d'Ambois; The Revenge of B. d'A.; The Conspiracy of Byron; The Tragedy of B.; Chabot, Admiral of France (with Shirley).*

³ *Arden of Feversham; A Yorkshire Tragedy.*

⁴ *A Woman killed with Kindness; The English Traveller.*

⁵ *Vittoria Coromboni; The Duchess of Malfi.*

⁶ *'Tis Pity She's a Whore; The Broken Heart.*

⁷ *Every Man in his Humour; Every Man out of his Humour.*

⁸ *Shadwell, The Humourists.*

versatility of Shirley—not to mention many later and not necessarily minor names¹—mirrored in innumerable pictures of contemporary life the undying follies and foibles of mankind. As comedians of manners more than one of these surpassed the old master, not indeed in distinctness and correctness—the fruits of the most painstaking genius that ever fitted a learned sock to the representation of the living realities of life—but in a lightness not incompatible with sureness of touch; while in the construction of plots the access of abundant new materials, and the greater elasticity in treatment resulting from accumulated experience, enabled them to advance from success to success. Thus the comic dramatic literature from Jonson to Shirley is unsurpassed as a comedy of manners, while as a comedy of character it at least defies comparison with any other national literary growth preceding or contemporaneous with it. Though the younger generation, of which W. Cartwright may be taken as an example, was unequal in originality or force to its predecessors, yet so little exhausted was the vitality of the species, that its traditions survived the *interregnum* of the Revolution, and connected themselves more closely than is sometimes assumed with later growths of English comedy.

Such was also the case with a special growth which had continued side by side, but in growing frequency of contact, with the progress of the national drama. The *The Inter-academical drama.* academical drama of the later Elizabethan period and of the first two Stuart reigns by no means fell off either in activity or in variety from that of the preceding generations. At Oxford, after an apparent break of several years—though in the course of these one or two new plays, including a *Tamored* by Sir Henry Wotton at Queen's, seem to have been produced—a long succession of English plays, some in Latin doubtless from time to time intervening, were performed, from the early years of the 17th century onwards to the dark days of the national theatre and beyond. The production of these plays was distributed among several colleges, among which the most conspicuously active were Christ Church and St John's, where a whole series of festal performances took place under the collective title of *The Christmas Prince* (i.e. master of the Christmas revels). They included a wide variety of pieces, from the treatment by an author unnamed of the story of "Ovid's own Narcissus" (1602) and S. Daniel's *Queen's Arcadia* (1606) to Barten Holiday's *Technogamia* (1618), a complicated allegory on the relations between the arts and sciences quite in the manner of the moralities; interspersed by romantic dramas of the ordinary contemporary type by T. Goffe (1591–1629), W. Cartwright, J. Maine (1604–1672) and others. At Cambridge the list of Latin and English academical plays, performed in the latter half of Elizabeth's reign at Trinity, St John's, Queen's and a few other colleges, contains several examples in each language which for one reason or another possess a special interest. Thus E. Forsett's *Pedantius*, probably acted at Trinity in 1581, ridicules a personage who lived very near the rose—the redoubtable Gabriel Harvey;² a *Ladla*, acted at Queen's in 1590 and again in 1598, resembles *Twelfth Night* in part of its plot; while in *Silvanus*, performed in 1596, probably at St John's, there are certain striking similarities to *As You Like It*. These are in Latin, as are the comedies *Hispanus* (containing some curious allusions to the Armada, Drake and Dr Lopez) and *Machiavelus*, acted at St John's in 1597.³ By far the most interesting of the English plays of the later Cambridge series, and, it may be averred, of the remains of the English academical drama as a whole, are the *Parnassus Plays* (q.v.), successively produced at St John's in 1598–1602, which illustrate

with much truthfulness as well as fancy the relations between university life and the outside world, including the world of letters and of the stage. Upon a different, but also a very notable, aspect of English university life—the relations between town and gown—a partisan light is thrown by *Club-Law*, acted at Clare in 1599—and in G. Ruggle's celebrated Latin comedy of *Ignoramus*, twice acted by members of Clare at Trinity in 1615 before King James I. On one of these occasions were also produced in English T. Tomkiss' comedy *Albumazar* (a play absurdly attributed to Shakespeare), and Phineas Fletcher's *Sicelides*, a "piscatory" (i.e. a pastoral drama in which the place of the shepherds is taken by fishermen). Latin and English plays continued to be brought out in Cambridge till the year of the outbreak of the Civil War, T. Randolph and A. Cowley⁴ being among the authors of some of the latest so produced; and with the Restoration the usage recommenced, the *Adelphi* of Terence and other Latin comedies being performed as they had been a century earlier. A complete survey and classification of the English academical drama, for which the materials are at last being collected and compared, will prove of an importance which is only beginning to be recognized to the future historian of the English drama.

To return to the general current of that drama. The rivals against which it had to contend in the times with which its greatest epoch came to an end have in their turn been *The stage.* noticed. From the masks and triumphs at court and at the houses of the nobility, with their Olympuses and Parnassuses built by Inigo Jones, and filled with goddesses and nymphs clad in the gorgeous costumes designed by his inventive hand, to the city pageants and shows by land and water—from the tilts and tournaments at Whitehall to the more philosophical devices at the Inns of Court and the academical plays at the universities—down even to the brief but thrilling theatrical excitements of Bartholomew Fair and the "Ninevitical motions" of the puppets—in all these ways the various sections of the theatrical public were tempted aside. Foreign performers—French and Spanish actors, and even French actresses—paid visits to London. But the national drama held its ground. The art of acting maintained itself at least on the level to which it had been brought by Shakespeare's associates and contemporaries, Burbage and Heminge, Alleyn, Lewin, Taylor, and others "of the older sort." The profession of actor came to be more generally than of old separated from that of playwright, though they were still (as in the case of Field) occasionally combined. But this rather led to an increased appreciation of the artistic merit of actors who valued the dignity of their own profession and whose co-operation the authors learnt to esteem as of independent significance. The stage was purged from the barbarism of the old school of clowns. Women's parts were still acted by boys, many of whom attained to considerable celebrity; and a practice was thus continued which must assuredly have placed the English theatre at a considerable disadvantage as compared with the Spanish (where it never obtained), and which may, while it has been held to have facilitated freedom of fancy, more certainly encouraged the extreme licence of expression cherished by the dramatists. The arrangement of the stage, which facilitated a rapid succession of scenes without any necessity for their being organically connected with one another, remained essentially what it had been in Shakespeare's days; though the primitive expedients for indicating locality had begun to be occasionally exchanged for scenery more or less appropriate to the place of action. Costume was apparently cultivated with much greater care; and the English stage of this period had probably gone a not inconsiderable way in a direction to which it is obviously in the interests of the dramatic art to set some bounds, if it is to depend for its popular success upon its qualities as such, and upon the interpretation of its agents upon the stage. At the same time, the drama had begun largely to avail itself of adventitious aids to favour. The system of prologues and epilogues, and of dedications to published plays, was more

¹ It is impossible in a summary survey to seek to discriminate by any kind of evidence the respective shares in many Elizabethan plays, and the respective credit due to them, of the joint writers. Yet some such inquiry is necessary before judging the claims to remembrance of highly-gifted dramatists such as William Rowley, his namesake Samuel, John Day, and not a few others.

² The Latin comedy *Victoria* by Abraham Fraunce of St John's was written some time before 1583, and dedicated to Sir Philip Sidney; but there is no evidence to show that it was ever acted.

³ (Bishop) Hacket's *Loyola* was acted at Trinity in 1623.

⁴ *Naufragium jocularè*—*The Guardian* (rewritten later as *The Cutter of Coleman Street*).

uniformly employed than it had been by Shakespeare as the conventional method of recommending authors and actors to the favour of individual patrons, and to that of their chief patron, the public.

Up to the outbreak of the Civil War the drama in all its forms continued to enjoy the favour or good-will of the court,

although a close supervision was exercised over all *The drama and Puritanism.* attempts to make the stage the vehicle of political references or allusions. The regular official agent of this supervision was the master of the revels; but under James I. a special ordinance, in harmony with the king's ideas concerning the dignity of the throne, was passed "against representing any modern Christian king in plays on the stage." The theatre could hardly expect to be allowed a liberty of speech in reference to matters of state denied to the public at large; and occasional attempts to indulge in the freedom of criticism dear to the spirit of comedy met with more or less decisive repression and punishment.¹ But the sympathies of the dramatists were so entirely on the side of the court that the real difficulties against which the theatre had to contend came from a directly opposite quarter. With the growth of Puritanism the feeling of hostility to the stage increased in a large part of the population, well represented by the civic authorities of the capital. This hostility found many ways of expressing itself. The attempts to suppress the Blackfriars theatre (1619, 1631, 1633) proved abortive; but the representation of stage-plays continued to be prohibited on Sundays, and during the prevalence of the plague in London in 1637 was temporarily suspended altogether. The desire of the Puritans of the more pronounced type openly aimed at a permanent closing of the theatres. The war between them and the dramatists was accordingly of a life-and-death kind. On the one hand, the drama heaped its bitterest and often coarsest attacks upon whatever savoured of the Puritan spirit; gibes, taunts, caricatures in ridicule and aspersion of Puritans and Puritanism make up a great part of the comic literature of the later Elizabethan drama and of its aftergrowth in the reigns of the first two Stuarts. This feeling of hostility, to which Shakespeare was no stranger,² though he cannot be connected with the authorship of one of its earliest and coarsest expressions,³ rose into a spirit of open defiance in some of the masterpieces of Ben Jonson;⁴ and the comedies of his contemporaries and successors⁵ abound in caricatured reproductions of the more common or more extravagant types of Puritan life. On the other hand, the moral defects, the looseness of tone, the mockery of ties sanctioned by law and consecrated by religion, the tendency to treat middle-class life as the hunting-ground for the diversions of the upper classes, which degraded so much of the dramatic literature of the age, intensified the Puritan opposition to all and any stage plays. A patient endeavour to reform instead of suppressing the drama was not to be looked for from such adversaries, should they ever possess the means of carrying out their views; and whenever Puritanism should victoriously assert itself in the state, the stage was doomed. Among the attacks directed against it in its careless heyday of prosperity Prynne's *Histrio-Mastix* (1632), while it involved its author in shamefully cruel persecution, did not remain wholly without effect upon the tone of the dramatic literature of the subsequent period; but the quarrel between Puritanism and the theatre was too old and too deep to end in any but one way, so soon as the latter was deprived of its protectors. The Civil War began in August 1642; and early in the following month was published the ordinance of the Lords and Commons, which, after a brief and solemn preamble, commanded "that while these sad causes and set-times of humiliation do continue, public stage plays shall cease and be forborne." Many actors

Closing of the theatres.

¹ Chapman, Marston (and Jonson), *Eastward Hoe* (1605); Middleton, *A Game at Chess* (1624); Shirley and Chapman, *The Ball* (1632); Massinger(?), *The Spanish Viceroy* (1634). ² Twelfth Night.

³ *The Puritan, or the Widow of Walling Street*, by "W. S." (Wentworth Smith?). ⁴ *The Alchemist*; *Bartholomew Fair*.

⁵ Chapman, *An Humorous Day's Mirth*; Marston, *The Dutch Courtesan*; Middleton, *The Family of Love*.

and playwrights followed the fortunes of the royal cause in the field; some may have gone into a more or less voluntary exile; upon those who lingered on in the familiar haunts the hand of power lay heavy; and, though there seems reason to believe that dramatic entertainments of one kind or another continued to be occasionally presented, stringent ordinances gave summary powers to magistrates against any players found engaged in such proceedings (1647), and bade them treat all stage-players as rogues, and pull down all stage galleries, seats and boxes (1648). A few dramatic works were published in this period;⁶ while at fairs about the country were acted farces called "drolls," consisting of the most vulgar scenes to be found in popular plays. Thus, the life of the drama was not absolutely extinguished; and its darkest day proved briefer than perhaps either its friends or its foes could have supposed.

Already "in Oliver's time" private performances took place from time to time at nobleman's houses and (though not undisturbed) in the old haunt of the drama, the Red Bull. In 1656 the ingenuity of Sir William Davenant whose name (though not really so significant in the dramatic as in another field of English literature) is memorable as connecting together two distinct periods in it, ventured on a bolder step in the production of a quasi-dramatic entertainment "of declamation and music"; and in the following year he brought out with scenery and music a piece which was afterwards in an enlarged form acted and printed as the first part of his opera, *The Siege of Rhodes*. This entertainment he afterwards removed from the private house where it had been produced to the Cockpit, where he soon ventured upon the performance of regular plays written by himself. Thus, under the cover of two sister arts, whose aid was in the sequel to prove by no means altogether beneficial to its progress, the English drama had boldly anticipated the Restoration, and was no longer hiding its head when that much-desired event was actually brought about. Soon after Charles II.'s entry into London, two theatrical companies are known to have been acting in the capital. For these companies patents were soon granted, under the names of "the Duke (of York)'s" and "the King's Servants," to Davenant and one of the brothers Killigrew respectively—the former from 1662 acting at Lincoln's Inn Fields, then at Dorset Garden in Salisbury Court, the latter from 1663 at the Theatre Royal near Drury Lane. These companies were united from 1682, a royal licence being granted in 1695 to a rival company which performed in Lincoln's Inn Fields, and which migrated to Covent Garden in 1733. Meanwhile, Vanbrugh had in 1705 built the theatre in the Haymarket; and a theatre in Goodman's Fields—afterwards rendered famous by the first appearance of Garrick—led a fitful existence from 1729 to 1733. The act of 1737 deprived the crown of the power of licensing any more theatres; so that the history of the English stage for a long period was confined to a restricted area. The rule which prevailed after the Restoration, that neither of the rival companies should ever attempt a play produced by the other, operated beneficially both upon the activity of dramatic authorship and upon the progress of the art of acting, which was not exposed to the full effects of that deplorable spirit of personal rivalry which too often leads even most intelligent actors to attempt parts for which they have no special qualification. There can be little doubt that the actor's art has rarely flourished more in England than in the days of T. Betterton and his contemporaries, among whose names those of Hart, Mohun, Kynaston, Nokes, Mrs Barry, Mrs Betterton, Mrs Bracegirdle and Mrs Eleanor Gwyn have, together with many others, survived in various connexions among the memories of the Restoration age. No higher praise has ever been given to an actor than that which Addison bestowed upon Betterton, in describing his performance of *Othello* as a proof that Shakespeare could not have written the most striking passages of the character otherwise than he has done.

⁶ Among these was Sir Richard Fanshawe's English version of the *Pastor fido* (1646); after his death were published his translations of two plays by A. de Mendoza.

Revival of the drama.

It may here be noticed that the fortunes of the Irish theatre in general followed those of the English, of which of course it was merely a branch. Of native dramatic compositions in earlier times not a trace remains in Ireland; and the drama was introduced into that country as an English exotic—apparently already in the reign of Henry VIII., and more largely in that of Elizabeth. The first theatre in Dublin was built in 1635; but in 1641 it was closed, and even after the Restoration the Irish stage continued in a precarious condition till near the end of the century. About that time an extraordinarily strong taste for the theatre took possession of Irish society, and during the greater part of the 18th century the Dublin stage rivalled the English in the brilliancy of its stars. Betterton's rival, R. Wilks, Garrick's predecessor in the homage paid to Shakespeare, Macklin, and his competitor for favour, the "silver-tongued" Barry, were alike products of the Irish stage, as were Mrs Woffington and other well-known actresses. Nor should it be forgotten that three of the foremost English writers of comedy in its later days, Congreve, Farquhar and Sheridan, were Irish, the first by education, and the latter two by birth also.

Already in the period preceding the outbreak of the Civil War the English drama had perceptibly sunk from the height to which it had been raised by the great Elizabethans. When it had once more recovered possession of that arena with which no living drama can dispense, it would have been futile to demand that the dramatists should return altogether into the ancient paths, unaffected by the influences, native or foreign, in operation around them. But there was no reason why the new drama should not, like the Elizabethan, have been true in spirit to the higher purposes of the dramatic art, to the nobler tendencies of the national life, and to the demands of moral law. Because the later Stuart drama as a whole proved untrue to these, and, while following its own courses, never more than partially returned from the aberrations to which it condemned itself, its history is that of a decay which the indisputable brilliancy, borrowed or original, of many of its productions is incapable of concealing.

Owing in part to the influence of the French theatre, which by this time had taken the place of the Spanish as the ruling drama of Europe, the separation between tragedy and comedy is clearly marked in post-Restoration plays. Comic scenes are still occasionally introduced into tragedies by some dramatists who adhered more closely to the Elizabethan models (such as Otway and Crowne), but the practice fell into disuse; while the endeavour to elevate comedy by pathetic scenes and motives is one of the characteristic marks of the beginning of another period in English dramatic literature. The successive phases through which English tragedy passed in the later Stuart times cannot be always kept distinct from one another; and the guidance offered by the theories put forth by some of the dramatists in support of their practice is often delusive. Following the example of Corneille, Dryden and his contemporaries and successors were fond of proclaiming their adherence to this or that principle of dramatic construction or form, and of upholding, with much show of dialectical acumen, maxims derived by them from French or other sources, or elaborated with modifications and variations of their own, but usually amounting to little more than what Scott calls "certain romantic whimsical imitations of the dramatic art." Students of the drama will find much entertainment and much instruction in these prefaces, apologies, dialogues and treatises. They will acknowledge that Dryden's incomparable vigour does not desert him either in the exposing or in the upholding of fallacies, while *le bon sens*, which he hardly ever fails to exhibit, and which is a more eclectic gift than common-sense, serves as a sure guide to the best intelligence of his age. Even Rymer,¹ usually regarded as having touched the nadir of dramatic criticism, will be found to be not wholly without grains of salt. But Restoration tragedy itself must not be studied by the light of Restoration criticism. So long as any dramatic power remained in the tragic poets—

¹ *A Short View of Tragedy* (1693).

and it is absent from none of the chief among them from Dryden to Rowe—the struggle between fashion (disguised as theory) and instinct (tending in the direction of the Elizabethan traditions) could never wholly determine itself in favour of the former.

Lord Orrery, in deference, as he declares, to the expressed tastes of his sovereign King Charles II. himself, was the first to set up the standard of *heroic plays*.² This new species of tragedy (for such it professed to be) commended itself by its novel choice of themes, to a large extent supplied by recent French romance—the *romans de longue haleine* of the Scudérys and their contemporaries—and by French plays treating similar themes. It likewise borrowed from France that garb of rhyme which the English drama had so long abandoned, and which now reappeared in the heroic couplet. But the themes which to readers of novels might seem of their nature inexhaustible could not long suffice to satisfy the more capricious appetite of theatrical audiences; and the form, in the application which it was more or less sought to enforce for it, was doomed to remain an exotic. In conjunction with his brother-in-law Sir R. Howard,³ and afterwards more confidently by himself,⁴ Dryden threw the incomparable vigour and brilliancy of his genius into the scale, which soon rose to the full height of fashionable popularity. At first he claimed for English tragedy the right to combine her native inheritance of freedom with these valuable foreign acquisitions.⁵ Nor was he dismayed by the ridicule which the celebrated burlesque (by the duke of Buckingham and others) of *The Rehearsal* (1671) cast upon heroic plays, without discriminating between them and such other materials for ridicule as the contemporary drama supplied to its facetious authors, but returned⁶ to the defence of a species which he was himself in the end to abandon.⁷ The desire for change proved stronger than the love of consistency—which in Dryden was never more than theoretical. After summoning tragedy to rival the freedom (without disdaining the machinery) of opera—with whose birth its own revival was as a matter of fact simultaneous—he came to recognize in characterization the truest secret of the master-spirit of the Elizabethan drama,⁸ and after audaciously, but in one instance not altogether unhappily, essaying to rival Shakespeare on his own ground,⁹ produced under the influence of the same views at least one work of striking merit.¹⁰ But he was already growing weary of the stage itself as well as of the rhymed heroic drama; and, though he put an end to the species to which he had given temporary vitality, he failed effectively to point the way to a more legitimate development of English tragedy. Among the other tragic poets of this period, N. Lee, in the outward form of his dramas, accommodated his practice to that of Dryden, with whom he occasionally co-operated as a dramatist, and like whom he allowed political partisanship to intrude upon the stage.¹¹ His rhetorical genius was not devoid of genuine energy, nor is he to be regarded as a mere imitator. T. Otway, the most gifted tragic poet of the younger generation contemporary with Dryden, inherited something of the spirit of the Elizabethan drama; he possessed a real gift of tragic pathos and melting tenderness; but his genius had a worse alloy than stageyess, and, though he was often happy in his novel choice of themes, his most successful efforts fail to satisfy tests supplementary to that of the stage.¹² Among dramatists who contributed to the vogue of the "heroic" play may be mentioned J. Bankes, J. Weston, C. Hopkins, E. Cooke, R. Gould, S. Portage, T. Rymer and Elkanah Settle. The productivity of J. Crowne (d. c. 1703)¹³ covers part of the earlier period as well as of the later, to which properly belong T. Southerne, a writer gifted with much

² *The Black Prince; Tryphon; Herod the Great; Altemira.*

³ *The Indian Queen.*

⁴ *The Indian Emperor; Tyrannic Love; The Conquest of Granada.*

⁵ *Essay of Dramatic Poesy.* ⁶ *Essay of Heroic Plays.*

⁷ A direct satirical invective against rhymed tragedy of the "heroic" type is to be found in Arrowsmith's comedy *Reformation* (1673).

⁸ *All for Love (Antony and Cleopatra).* ⁹ *The Grounds of Criticism in Tragedy.*

¹⁰ *The Royal Queens; Lucius Junius Brutus; The Massacre of Paris.* ¹¹ *Don Carlos; The Orphan; Venice Preserved.*

¹² *Oroonoko; The Fatal Marriage.*

pathetic power, but probably chiefly indebted for his long-lived popularity to his skill in the discovery of "sensational" plots; and Lord Lansdowne ("Granville the polite") (c. 1667-1735). Congreve, by virtue of a single long celebrated but not really remarkable tragedy;¹ and N. Rowe, may be further singled out from the list of the tragic dramatists of this period, many of whom were, like their comic contemporaries, mere translators or adapters from the French. The tragedies of Rowe, whose direct services to the study of Shakespeare deserve remembrance, indicate with singular distinctness the transition from the fuller declamatory style of Dryden to the calmer and thinner manner of Addison.² In tragedy (as to a more marked degree in comedy) the excesses (both of style and subject) of the past period of the English drama had produced an inevitable reaction; decorum was asserting its claims on the stage as in society; and French tragedy had set the example of sacrificing what passion—and what vigour—it retained in favour of qualities more acceptable to the "reformed" court of Louis XIV. Addison, in allowing his *Cato* to take its chance upon the stage, when a moment of political excitement (April 1713) ensured to it an extraordinary success, to which no feature in it corresponds, except an unusual number of lines predestined to become familiar quotations, unconsciously sealed the doom of English national tragedy. The "first reasonable English tragedy," as Voltaire called it, had been produced, and the oscillations of the tragic drama of the Restoration were at an end.

English comedy in this period displayed no similar desire to cut itself off from the native soil, though it freely borrowed the materials for its plots and many of its figures from the *Comedy*. Spanish, and afterwards more generally from French, originals. The spirit of the old romantic comedy had long since fled; the graceful artificialities of the pastoral drama, even the light texture of the mask, ill suited the demands of an age which made no secret to itself of the grossness of its sensuality. With a few unimportant exceptions, such poetic elements as admitted of being combined with the poetic drama were absorbed by the opera and the ballet. No new species of the comic drama formed itself, though towards the close of the period may be noticed the beginnings of modern English farce. Political and religious partisanship, generally in accordance with the dominant reaction against Puritanism, were allowed to find expression in the directest and coarsest forms upon the stage, and to hasten the necessity for a more systematic control than even the times before the Revolution had found requisite. At the same time the unblinking indecency which the Restoration had spread through court and capital had established its dominion over the comic stage, corrupting the manners, and with them the morals, of its dramatists, and forbidding them, at the risk of seeming dull, to be anything but improper. Much of this found its way even into the epilogues, which, together with the prologues, proved so important an adjunct of the Restoration drama. These influences determine the general character of what is with a more than chronological meaning termed the comedy of the Restoration. In construction, the national love of fulness and solidity of dramatic treatment induced its authors to alter what they borrowed from foreign sources, adding to complicated Spanish plots characters of native English directness, and supplementing single French plots by the addition of others.³ At the same time, the higher efforts of French comedy of character, as well as the refinement of expression in the list of their models, notably in Molière, were alike seasoned to suit the coarser appetites and grosser palates of English patrons. The English comic writers often succeeded in strengthening the borrowed texture of their plays, but they never added comic

¹ *The Mourning Bride*.

² *The Fair Penitent; Jane Shore*.

³ A notable influence was exercised upon English comedy as well as upon other branches of literature by C. de Saint-Evremond, a soldier and man of fashion who was possessed of great intellectual ability and of a charming style. Though during his long exile in England—from 1670 to his death—he never learned English, his critical works included *Remarks on English Comedy* (1677), and one of his own comedies, the celebrated *Sir Politick Would-be*, professed to be composed "à la manière angloise."

humour without at the same time adding coarseness of their own. Such were the productions of Sir George Etherege, Sir Charles Sedley, and the "mob of gentlemen who wrote with ease"; nor was there any signal difference between their productions and those of a playwright-actor such as J. Lacy (d. 1681), and a professional dramatist of undoubted ability such as J. Crowne. Such, though often displaying the brilliancy of a genius which even where it sank could never wholly abandon its prerogative, were, it must be confessed, the comedies of Dryden himself. On the other hand, the lowest literary depths of the Restoration drama were sounded by T. D'Urfey, while of its moral degradation the "divine Astraea," the "unspeakable" Mrs Aphra Behn, has an indefeasible title to be considered the most faithful representative. T. Shadwell, fated, like the tragic poet Elkanah Settle, to be chiefly remembered as a victim of Dryden's satire, deserves more honourable mention. Like J. Wilson, whose plays seem to class him with the pre-Restoration dramatists, Shadwell had caught something not only of the art, but also of the spirit, of Ben Jonson; but in most of his works he was, like the rest of his earlier contemporaries, and like the brilliant group which succeeded them, content to take his moral tone from the reckless society for which, or in deference to the tastes of which, he wrote.⁴ The absence of a moral sense, which, together with a grossness of expression often defying exaggeration, characterizes English comic dramatists from the days of Dryden to those of Congreve, is the main cause of their failure to satisfy the demands which are legitimately to be made upon their art. They essayed to draw character as well as to paint manners, but they rarely proved equal to the former and higher task; and, while choosing the means which most readily commended their plays to the favour of their immediate public, they achieved but little as interpreters of those essential distinctions which their art is capable of illustrating.⁵ Within these limits, though occasionally passing beyond them, and always with the same deference to the immoral tone which seemed to have become an indispensable adjunct of the comic style, even the greatest comic authors of this age moved. W. Wycherley was a comic dramatist of real power, who drew his characters with vigour and distinctness, and constructed his plots and chose his language with natural ease. He lacks gaiety of spirit, and his wit is of a cynical turn. But, while he ruthlessly uncloaks the vices of his age, his own moral tone is affected by their influence in as marked a degree as that of the most light-hearted of his contemporaries.⁶ The most brilliant of these was indisputably W. Congreve, who is not only one of the very wittiest of English writers, but equally excels in the graceful ease of his dialogue, and draws his characters and constructs his plots with the same masterly skill. His chief fault as a dramatist is one of excess—the brilliancy of the dialogue, whoever be the speaker, overpowers the distinction between the "humours" of his personages. Though he is less brutal in expression than "manly" Wycherley, and less coarse than the lively Sir J. Vanbrugh, licentiousness in him as in them corrupts the spirit of his comic art; but of his best though not most successful play⁷ it must be allowed that the issue of the main plot is on the side of virtue. G. Farquhar, whose morality is on a par with that of the other members of this group, is inferior to them in brilliancy; but as pictures of manners in a wider sphere of life than that which contemporary comedy usually chose to illustrate, two of his plays deserve to be noticed, in which we already seem to be entering the atmosphere of the 18th-century novel.⁸ His influence upon Lessing is a remarkable fact in the international history of dramatic literature.

The improvement which now begins to manifest itself in the moral tone and spirit of English comedy is partly due to the reaction against the reaction of the Restoration, partly to the punishment which the excesses of the comic stage had brought

⁴ *Epsom Wells; The Squire of Alsatia; The Volunteers*.

⁵ A dramatic curiosity of a rare kind would be *The Female Rebellion* (1682), which has been, on evidence rather striking at first sight, attributed to Sir Thomas Browne. It is more likely to have been by his son.

⁶ *The Country Wife; The Plain-Dealer*.

⁷ *The Recruiting Officer; The Beaus' Stratagem*.

⁸ *The Double Dealer*.

upon it in the invective of Jeremy Collier¹ (1698), of all the assaults the theatre in England has had to undergo the best-founded, and that which produced the most perceptible results. The comic poets, who had always been more or less conscious of their sins, and had at all events not defended them by the ingenious sophistries which it has pleased later literary criticism to suggest on their behalf, now began with uneasy merriment to allude in their prologues to the reformation which had come over the spirit of the town. Writers like Mrs Centlivre became anxious to reclaim their offenders with much emphasis in the fifth act; and Colley Cibber—whose *Apology for his Life* furnishes a useful view of this and the subsequent period of the history of the stage, with which he was connected as author, manager and actor (excelling in this capacity as representative of those fools with which he peopled the comic stage)²—may be credited with having first deliberately made the pathetic treatment of a moral sentiment the basis of the action of a comic drama. But he cannot be said to have consistently pursued the vein which in his *Careless Husband* (1704) he had essayed. His *Non-Juror* is a political adaptation of *Tartuffe*; and his almost equally celebrated *Provoked Husband* only supplied a happy ending to Vanbrugh's unfinished play. Sir R. Steele, in accordance with his general tendencies as a writer, pursued a still more definite moral purpose in his comedies; but his genius perhaps lacked the sustained vigour necessary for a dramatist, and his humour naturally sought the aid of pathos. From partial³ he passed to more complete⁴ experiment; and thus these two writers, who transplanted to the comic stage a tendency towards the treatment of domestic themes noticeable in such writers of Restoration tragedy as Southerne and Rowe, became the founders of *sentimental comedy*, a species which exercised a most depressing influence upon the progress of English drama, and helped to hasten the decline of its comic branch. With *Cato* English tragedy committed suicide, though its pale ghost survived; with *The Conscious Lovers* English comedy sank for long into the tearful embraces of artificiality and weakness.

During the 18th century the productions of dramatic literature were still as a rule legitimately designed to meet the demands of the stage, from which its higher efforts afterwards to so large an extent became dissociated. The goodwill of most sections of the public continued to be steadily accorded to a theatre which had ceased to defy the accepted laws and traditions of morality; and the opposition still aroused by it was confined to a small

minority of thinkers, though these included some who were far from being puritans. John Dennis was not thought to have the worst of the controversy, when he defended the stage against the attack of an opponent far above him in stature—the great mystic William Law⁵—and to John Wesley himself it seemed that “a great deal more might be said in defence of seeing a serious tragedy” than of taking part in the amusements of bear-baiting and cock-fighting. On the other hand, the demands of the stage and those of its patrons and of the public of the “Augustan” age, and of that which succeeded it, were, in general, fast bound by the trammels of a taste with which a revival of the poetic drama long remained irreconcilable. There is every reason to conclude that the art of acting progressed in the same direction of artificiality, and became stereotyped in forms corresponding to the “chant” which represented tragic declamation in a series of actors ending with Quin and Macklin. In the latter must be recognized features of a precursor, but it was reserved to the genius of Garrick, whose theatrical career extended from 1741 to 1776, to open a new era in his art. His unparalleled success was due in the first instance to his incomparable natural gifts; yet these were indisputably enhanced by a careful and continued

¹ *A Short View of the Immorality and Profaneness of the English Stage.*
² Sir Novelty Fashion (Lord Foppington), &c.
³ *The Lying Lover; The Tender Husband.*
⁴ *The Conscious Lovers.*
⁵ *The Absolute Unlawfulness of Stage Entertainments fully Demonstrated; The Stage defended, &c.* (1726).

literary training, and ennobled by a purpose which prompted him to essay the noblest, as he was capable of performing the most various, range of English theatrical characters. By devoting himself as actor and manager with special zeal to the production of Shakespeare, Garrick permanently popularized on the national stage the greatest creations of English drama, and indirectly helped to seal the doom of what survived of the tendency to maintain in the most ambitious walks of dramatic literature the nerveless traditions of the pseudo-classical school. A generation of celebrated actors and actresses, many of whom live for us in the drastic epigrams of Churchill's *Rasciad* (1761), were his helpmates or his rivals; but their fame has faded, while his is destined to endure as that of one of the typical masters of his-art.

The contrast between the tragedy of the 18th century and those plays of Shakespeare and one or two other Elizabethans which already before Garrick were known to the English stage, was weakened by the mutilated form Decline of
tragedy. in which the old masterpieces generally, if not always, made their appearance there. Even so, however, there are perhaps few instances in theatrical history in which so unequal a competition was so long sustained. In the hands of the tragic poets of the age of Pope, as well as that of Johnson, tragedy had hopelessly stiffened into the forms of its accepted French models. Direct reproductions of these continued, as in Ambrose Philips's and Charles Johnson's (1679-1748) translations from Racine, and Aaron Hill's from Voltaire. Among other tragic dramatists of the earlier part of the century may be mentioned J. Hughes, who, after assisting Addison in his *Cato*, produced at least one praiseworthy tragedy of his own; E. Fenton, a joint translator of “Pope's *Homers*” and the author of one extremely successful drama on a theme of singularly enduring interest,⁶ and L. Theobald the first hero of the *Dunciad*, who, besides translations of Greek dramas, produced a few more or less original plays, one of which he was daring enough to father upon Shakespeare.⁷ A more distinguished name is that of J. Thomson, whose unlucky *Sophonisba* and subsequent tragedies are, however, barely remembered by the side of his poems (*The Seasons*, &c.). The literary genius of E. Young, on the other hand, possessed vigour and variety enough to distinguish his tragedies from the ordinary level of Augustan plays; in one of them he seems to challenge comparison in the treatment of his theme with a very different rival,⁸ but by his main characteristics as a dramatist he belongs to the school of his contemporaries. The endeavour of G. Lillo, in his *London Merchant*, or *George Barnwell* (1731), to bring the tragic lessons of terror and pity directly home to his fellow-citizens exercised an extraordinarily widespread as well as enduring effect on the history of the 18th-century drama. At home, they gave birth to the new, or, more properly speaking, to the revived, species of domestic tragedy, which connects itself more or less closely with a notable epoch in the history of English prose-fiction as well as of English painting. Abroad, this play—whose success was of the kind which nothing can kill—supplied the text to the teachings of Diderot, as well as an example to his own dramatic attempts; and through Diderot the impulse communicated itself to Lessing, and long exercised a great effect upon the literature of the German stage. At the same time, it must be allowed that Lillo's pedestrian muse failed in the end to satisfy higher artistic demands than those met in his most popular play, while in another⁹ she was less consciously guilty of an aberration towards that “tragedy of destiny,” which, in the modern drama at least, obscures the ethical character of all tragic actions. “Classical” tragedy in the generation of Dr Johnson pursued the even tenor of its way, the dictator himself treading with solemn footfall in the accustomed path,¹⁰ and W. Mason making the futile attempt to produce a close imitation of Greek

⁶ *The Siege of Damascus.*

⁷ *The Double Falsehood.*

⁸ *Fatal Curiosity.*

⁹ *Irene* (1749); *The Patriot* attributed to Theobald, is by Joseph Simpson.

¹⁰ *Marianna.*

¹¹ *The Revenger (Othello).*

models.¹ The best-remembered tragedy of the century, Home's *Douglas* (1757), was the production of an author whose famous kinsman, David Hume (though no friend of the contemporary English stage), had advised him "to read Shakespeare, but to get Racine and Voltaire by heart." The indisputable merits of the play cannot blind us to the fact that *Douglas* is the offspring of *Merope*.

While thus no high creative talent arose to revive the poetic genius of English tragedy, comedy, which had to contend against the same rivals, naturally met the demands of the conflict with greater buoyancy. The history of the most formidable of those rivals, Music, forms no part of this sketch; but the points of contact between its progress and the history of dramatic literature cannot be altogether left out of sight. H. Purcell's endeavours to unite English music to the words of English poets were now a thing of the past, analogous attempts in the direction of musical dialogue, which have been insufficiently noticed, had likewise proved transitory; and the isolated efforts of Addison² and others to recover the operatic stage for the native tongue had proved powerless. Italian texts, which had first made their entrance piecemeal, in the end asserted themselves in their entirety; and the marvellously assimilative genius of Handel completed the triumphs of a form of art which no longer had any connexion with the English drama, and which reached the height of its fashionable popularity about the time when Garrick began to adorn the national stage. In one form, however, the English opera was preserved as a pleasing species of the popular drama. The pastoral drama had (in 1725) produced an isolated aftergrowth in Allan Ramsay's *Gentle Shepherd*, which, with genuine freshness and humour, but without a trace of burlesque, transferred to the scenery of the Pentland Hills the lovely tale of Florizel and Perdita. The dramatic form of this poem is only an accident, but it doubtless suggested an experiment of a different kind to the most playful of London wits. Gay's "Newgate Pastoral" of *The Beggar's Opera* (1728), in which the amusing text of a burlesque farce was interspersed with songs set to popular airs, caught the fancy of the town by this novel combination, and became the ancestor of a series of agreeable productions, none of which, however, not even its own continuation, *Polly* (amazingly successful in book form, after its production was forbidden by the lord chamberlain), have ever rivalled it in success or celebrity. Among these may be mentioned the pieces of I. Bickerstaffe³ and C. Dibdin.⁴ The opera in England, as elsewhere, thus absorbed what vitality remained to the pastoral drama, while to the ballet and the pantomime (whose glories in England began at Covent Garden in 1733, and to whose popularity even Garrick was obliged to defer) was left (in the 18th century at all events) the inheritance of the external attractions of the mask and the pageant.

In the face of such various rivalries it is not strange that comedy, instead of adhering to the narrow path which Steele and others had marked out for her, should have permitted herself some vagaries of her own. Gay's example pointed the way to a fatally facile form of the comic art; and burlesque began to contribute its influence to the decline of comedy. In an age when party-government was severely straining the capabilities of its system, dramatic satire had not far to look for a source of effective seasonings. The audacity of H. Fielding, whose regular comedies (original or adapted) have secured no enduring remembrance, but whose love of parody was afterwards to suggest to him the theme of the first of the novels which have made his name immortal, accordingly ventured in two extravaganzas⁵ (so we should call them in these days) upon a larger admixture of political with literary and other satire. A third attempt⁶ (which never reached the stage) furnished the offended minister, Sir Robert Walpole, with the desired occasion for

placing a curb upon the licence of the theatre, such as had already been advocated by a representative of its old civic adversaries. The famous act of 1737 asserted no new principle, but converted into legal power the customary authority hitherto exercised by the lord chamberlain (to whom it had descended from the master of the revels). The regular censorship which this act established has not appreciably affected the literary progress of the English drama, and the objections which have been raised against it seem to have addressed themselves to practice rather than to principle. The liberty of the stage is a question differing in its conditions from that of the liberty of speech in general, or even from that of the liberty of the press, and occasional lapses of official judgment weigh lightly in the balance against the obvious advantages of a system which in a free country needs only the vigilance of public opinion to prevent its abuse. The policy of the restraint which the act of 1737 put upon the number of playhouses is a different, but has long become an obsolete, question.⁷

Brought back into its accustomed grooves, English comedy seemed inclined to leave to farce the domain of healthy ridicule, and to coalesce with domestic tragedy in the attempt to make the stage a vehicle of homespun didactic morality. Farce had now become a genuine English species, and has as such retained its vitality through all the subsequent fortunes of the stage; it was actively cultivated by Garrick as both actor and author; and he undoubtedly had more than a hand in the very best farce of this age, which is ascribed to clerical authorship.⁸ S. Foote, whose comedies⁹ and farces are distinguished both by wit and by variety of characters (though it was an absurd misapplication of a great name to call him the English Aristophanes), introduced into comic acting the abuse of personal mimicry, for the exhibition of which he ingeniously invented a series of entertainments, the parents of a long progeny of imitations. Meanwhile, the domestic drama of the sentimental kind achieved, though not immediately, a success only inferior to that of *The London Merchant*, in *The Gamberger* of E. Moore, to which Garrick seems to have directly contributed;¹⁰ and sentimental comedy courted sympathetic applause in the works of A. Murphy, the single comedy of W. Whitehead,¹¹ and the earliest of H. Kelly.¹² It cannot be said that this species was extinguished, as it is sometimes assumed to have been, by O. Goldsmith; but he certainly published a direct protest against it between the production of his admirable character-comedy of *The Good-Natured Man*, and his delightfully brisk and fresh *She Swoops to Conquer*, which, after startling critical propriety from its self-conceit, taught comedy no longer to fear being true to herself. The most successful efforts of the elder G. Colman¹³ had in them something of the spirit of genuine comedy, besides a finish which, however playwrights may shut their eyes to the fact, is one of the qualities which ensure a long life to a play. And in the masterpieces of R. B. Sheridan some of the happiest features of the comedy of Congreve were revived, together with its too uniform brilliancy of dialogue, but without its indecency of tone. The varnish of the age is indeed upon the style, and the hollowness of its morality in much of the sentiment (even where that sentiment is meant for the audience) of *The Rivals* and *The School for Scandal*; but in tact of construction, in distinctness of characters, and in pungency of social satire, they are to be ranked among the glories

¹ The first dramatic performance licensed by the lord chamberlain after the passing of the act was appropriately entitled *The Nest of Plays*, and consisted of three comedies named respectively *The Prodigal Reformed*, *In Happy Constancy* and *The Trial of Conjugal Love*. It is a curious fact that in the first decade of the reign of George III. a severe control of the theatre was very actively exerted after a positive as well as a negative fashion—objectionable passages being ruthlessly suppressed and plays actually written and licensed for the purpose of upholding the existing régime.

² J. Townley, *High Life Below Stairs* (1759).

³ *The Minor; Taste; The Author, &c.*

⁴ This celebrated play was at first persistently attributed to Miss Elizabeth Carter.

⁵ *The School for Lovers.*

⁶ *False Delicacy.*

⁷ *The Jealous Wife; The Clandestine Marriage.*

¹ *Elfrida; Caractacus.*

² *Rosamunda.*

³ *Love in a Village, &c.*

⁴ *The Waterman, &c.*

⁵ *Pasquin; The Historical Register for 1730.*

⁶ *The Golden Rump.*

Comedy in the latter half of the 18th century.

of English comedy. Something in Sheridan's style, but quite without his brilliancy, is the most successful play¹ of the unfortunate General Burgoyne. R. Cumberland, who too consciously endeavoured to excel both in sentimental morality and in comic characterization, in which he was devoid of depth, closes the list of authors of higher pretensions who wrote for the theatre.² Like him, Mrs Cowley³ ("Anna Matilda"), T. Holcroft,⁴ and G. Colman the younger,⁵ all writers of popular comedies, as well as the prolific J. O'Keefe (1746-1833), who contributed to nearly every species of the comic drama, survived into the 19th century. To an earlier date along the favourite burlesques of O'Keefe's countryman K. O'Hara⁶ (d. 1782), good examples of a species the further history of which may be left aside. In the hands of at least one later writer, J. R. Planché, it proved capable of satisfying a more refined taste than his successors have habitually consulted.

The decline of dramatic composition of the higher class, perceptible in the history of the English theatre about the beginning of the 19th century, was justly attributed by Sir Walter Scott to the wearing out of the French model that had been so long wrought upon; but when he asserted that the new impulse which was sought in the dramatic literature of Germany was derived from

The English drama of the 19th century.

some of its worst, instead of from its noblest, productions—from Kotzebue rather than from Lessing, Schiller and Goethe—he showed a very imperfect acquaintance with a complicated literary movement which was obliquely reflected in the stage-plays of Iffland and his contemporaries. The change which was coming over English literature was in truth of a wider and deeper nature than it was possible for even one of its chief representatives to perceive. As that literature freed itself from the fetters so long worn by it as indispensable ornaments, and threw aside the veil which had so long obscured both the full glory of its past and the lofty capabilities of its future, it could not resort except tentatively to a form which like the dramatic is bound by a hundred bonds to the life of the age itself. Soon, the poems with which Scott and Byron, and the unrivalled prosefictions with which Scott, both satisfied and stimulated the imaginative demands of the public, diverted the attention of the cultivated classes from dramatic literature, which was unable to escape, with the light foot of verse or prose fiction, into "the new, the romantic land." New themes, new ideas, new forms occupied a new generation of writers and readers; nor did the drama readily lend itself as a vessel into which to pour so many fermenting elements. In Byron the impressions produced upon a mind not less open to impulses from without than subjective in its way of recasting them, called forth a series of dramatic attempts betraying a more or less wilful ignorance of the demands of dramatic compositions; his beautiful *Manfred*, partly suggested by Goethe's *Faust*, and his powerful *Cain*, have but the form of plays; his tragedies on Italian historical subjects show some resemblance in their political rhetoric to the contemporary works of Alfieri; his *Sardanapalus*, autobiographically interesting, fails to meet the demands of the stage; his *Werner* (of which the authorship has been ascribed to the duchess of Devonshire) is a hastily dramatized sensation novel. To Coleridge (1772-1834), who gave to English literature a splendidly loose translation of Schiller's *Wallenstein*, the same poet's *Rodgers* (to which Wordsworth's only dramatic attempt, the *Borderers*, is likewise indebted) had probably suggested the subject of his tragedy of *Osorio*, afterwards acted under the title of *Remorse*. Far superior to this is his later drama of *Zapolya*, a genuine homage to Shakespeare, out of the themes of two of whose plays it is gracefully woven. Scott, who in his earlier days had translated Goethe's *Götz von Berlichingen*, gained no reputation by his own dramatic compositions. W. S. Landor, apart from those *Imaginary Conversations* upon which he best loved to expend powers of observation and characterization such as have been given to

few playwrights, cast in a formally dramatic mould studies of character of which the value is far from being confined to their wealth in beauties of detail. Of these the magnificent, but in construction altogether undramatic, *Count Julian*, is the most noteworthy. Shelley's *The Cenci*, on the other hand, is not only a poem of great beauty, but a drama of true power, abnormally revolting indeed in theme, but singularly pure and delicate in treatment. A humbler niche in the temple of dramatic literature belongs to some of the plays of C. R. Maturin,⁷ Sir T. N. Talfourd,⁸ and Dean Milman.⁹

Divorced, except for passing moments, from the stage, English dramatic literature could during much the greater part of the 19th century hardly be regarded as a connected national growth; though, already in the last decades of the Victorian age, the revival of public interest in the theatre co-operated with a gradual change in poetic taste to awaken the hope of a future living reunion. Among English poets who lived in this period, Sir Henry Taylor probably approached nearest to the objective treatment and the amplitude of style characteristic of the Elizabethan drama.¹⁰ R. H. Horne, long an almost solitary survivor of the romantic school, was able in at least one memorable dramatic attempt to revive something of the early Elizabethan spirit.¹¹ Of the chief poets of the age, Tennyson only in his later years addressed himself to a form of composition little suited to his genius, though the very fact of the homage paid by him to the national forms of the historic drama and of romantic comedy could not fail to ennoble the contemporary stage.¹² Matthew Arnold's stately revival of the traditions of classical tragedy proper, on the other hand, deliberately excluded itself from any such contact;¹³ while Longfellow's refined literary culture and graceful facility of form made ready use of a quasi-dramatic medieval vesture.¹⁴ William Morris's single "morality," too, cannot be regarded as a contribution to dramatic literature proper.¹⁵ Of very different importance are the excursions into dramatic composition of Robert Browning, whose place in the living inheritance of the English drama has in one instance at least been not unsuccessfully vindicated by a later age, and some of whose greatest gifts are beyond a doubt displayed in his dramatic work;¹⁶ and the sustained endeavours of A. C. Swinburne, after adding a flower of exquisite beauty to the wreath which the lovers of the Attic muse have laid at her feet, to enrich the national historic drama by a trilogy instinct with the ardent eloquence of passion.¹⁷ Until a date too near the times in which we live to admit of its being fixed with precision, most of the English writers who sought to preserve a connexion between their dramatic productions and the demands of the stage addressed themselves to the theatrical rather than the literary public—for the distinction, in those times at all events, was by no means without a difference. The modestly simple and judiciously concentrated efforts of Joanna Baillie deserve a respectful remembrance in the records of literature as well as of the stage, though the day has passed when the theory which suggested her *Plays on the Passions* could find acceptance among critics, or her exemplifications of it satisfy the demands of playgoers. Sheridan Knowles, on the other hand, composed his conventional semblances of genuine tragedy and comedy with a thorough knowledge of stage effect, and some of them can hardly yet be said to have vanished from the stage.¹⁸ The first Lord Lytton, though his plays were for the most part of a lighter texture, showed even more artificiality of sentiment in their conception and execution; but the romantic touch which he imparted to at least one of them accounts for its long-lived popularity. Among later Victorian playwrights T. W. Robertson brought back a breath of naturalness into the acted comic drama; Tom Taylor, rivalling Lope in fertility, made little pretence to original invention, but adapted with an instinct that rarely failed him, and materially helped to keep the theatrical diversions of his

⁷ *Bertram.* ⁸ *Ton.* ⁹ *Fazio.* ¹⁰ *Philip van Artevelde.*

¹¹ *The Death of Marlowe.* ¹² *Becket; The Cup.*

¹³ *The Golden Legend.* ¹⁴ *Love is Enough.*

¹⁵ *Strafford; The Blot on the Scutcheon.*

¹⁶ *Atlanta in Calydon; Bothwell; Chastelard; Mary Stuart.*

¹⁷ *Virginius; The Hunchback.*

¹ *The Heiress.* ² *The West Indian; The Jew.*

³ *The Belle's Stratagem; A Bold Stroke for a Husband, &c.*

⁴ *The Road to Ruin, &c.* ⁵ *John Bull; The Heir at Law, &c.*

⁶ *Midus; The Golden Pippin.*

age sound and pure; an endeavour in which he had the co-operation of Charles Reade and that of most of those who competed with them for the favour of generations of playgoers more easily contented than their successors. The one deplorable aspect of this age of the English drama was to be found neither in the sphere of tragedy nor in that of comedy—nor even in that of farce. It was presented in the low depths of contemporary burlesque, which had degenerated from the graceful extravaganza of J. R. Planché into witless and tasteless emptiness.

Curiously enough, it was at this point that something like real originality—discovering a new sub-species of its own—first began, with the aid of a sister-art, to renovate the English popular comic stage. At the beginning of the 19th century the greatest tragic actress of the English theatre, Mrs Siddons, had passed her prime; and before its second decade had closed, not only she (1812) but her brother John Kemble (1817), the representative of a grand style of acting which later generations might conceivably find overpowering, had withdrawn from the boards. Mrs Siddons was soon followed into retirement by her successor Miss O'Neill (1819); while Kemble's brilliant later rival, Edmund Kean, an actor the intuitions of whose genius seem to have supplied, so far as intuition ever can supply, the absence of a consecutive self-culture, remained on the stage till his death in 1833. Young, Macready, and others handed down some of the traditions of the older school of acting to the very few artists who remained to suggest its semblance to a later generation. Even these—among them S. Phelps, whose special merit it was to present to a later age, accustomed to elaborate theatrical environments, dramatic masterpieces as dependent upon themselves and adequate interpretation; and the foremost English actress of the earlier Victorian age, Helen Faucit (Lady Martin)—were unable to leave a school of acting behind them. Still less was this possible to Charles Kean the younger, with whom the decorative production of Shakespearean plays really had its beginning; or even to Sir Henry Irving, an actor of genius, but also an irrepressible and almost eccentric theatrical personality, whose great service to the English drama was his faith in its masterpieces. The comic stage was fortunate in an ampler aftergrowth, from generation to generation, of the successors of the old actors who live for us all in the reminiscences of Charles Lamb; nor were the links suddenly snapped which bound the humours of the present to those of the past. In the first decade of the 20th century a generation still survived which could recall, with many other similar joys, the brilliant levity of Charles Mathews the younger; the not less irresistible stolidity of J. B. Buckstone; the solemn fooling of H. Compton (1805-1877); the subtle humours of J. L. Toole, and the frolic charm of Marie Wilton (Lady Bancroft), the most original comic actress of her time. (A. W. W.)

Recent English Drama.—In England the whole mechanism of theatrical life had undergone a radical change in the middle decades of the 19th century. At the root of this change lay the immense growth of population and the enormously increased facilities of communication between London and the provinces. Similar causes came into operation, of course, in France, Germany and Austria, but were much less distinctly felt, because the numerous and important subventioned theatres of these countries remained more or less unaffected by economic influences. Free trade in theatricals (subject only to certain licensing regulations and to a court censorship of new plays) was established in England by an act of 1843, which abolished the long moribund monopoly of the "legitimate drama" claimed by the "Patent Theatres" of Drury Lane and Covent Garden. The drama was thus formally subjected to the operation of the law of supply and demand, like any other article of commerce, and managers were left, unaided and unhampered by any subvention or privilege, to cater to the tastes of a huge and growing community. Theatres very soon multiplied, competition grew ever keener, and the long run, with its accompaniments of ostentatious decoration and lavish advertisement, became the one object of managerial effort. This process of evolution may be said to have begun in the second quarter of the 19th century and completed itself in

the 3rd. The system which obtains to-day, almost unforeseen in 1825, was in full operation in 1875. The repertory theatre, with its constant changes of programme, maintained on the continent partly by subventions, partly by the mere force of artistic tradition, had become in England a faint and far-off memory. There was not a single theatre in London at which plays, old and new, were not selected and mounted solely with a view to their continuous performance for as many nights as possible, anything short of fifty nights constituting an ignominious and probably ruinous failure. It was found, too, that those theatres were most successful which were devoted exclusively to exploiting the talent of an individual actor. Thus when the fourth quarter of the century opened, the long "run" and the actor-manager were in firm possession of the field.

The outlook was in many ways far from encouraging. It was not quite so black, indeed, as it had been in the late 'fifties and early 'sixties, when the "legitimate" enterprises of Phelps at Sadler's Wells and Charles Kean at the Princess's had failed to hold their ground, and when modern comedy and drama were represented almost exclusively by adaptations from the French. There had been a slight stirring of originality in the series of comedies produced by T. W. Robertson at the Prince of Wales's theatre, where, under the management of Bancroft (*q.v.*) a new school of mounting and acting, minutely faithful (in theory at any rate) to everyday reality, had come into existence. But the hopes of a revival of English comedy seemed to have died with Robertson's death. One of his followers, James Albery, possessed both imagination and wit, but had not the strength of character to do justice to his talent, and sank into a mere adapter. In the plays of another disciple, H. J. Byron, the Robertsonian or "cup-and-saucer" school declined upon sheer inanity. Of the numerous plays signed by Tom Taylor some were original in substance, but all were cast in the machine-made French mould. Wilkie Collins, in dramatizing some of his novels, produced somewhat crude anticipations of the modern "problem play." The literary talent of W. S. Gilbert displayed itself in a group of comedies both in verse and prose; but Gilbert saw life from too peculiar an angle to represent it otherwise than fantastically. The Robertsonian impulse seemed to have died utterly away, leaving behind it only five or six very insubstantial comedies and a subdued, unrhetoical method in acting. This method the Bancrofts proceeded to apply, during the 'seventies, to revivals of stage classics, such as *The School for Scandal*, *Money and Masks and Faces*, and to adaptations from the French of Sardou.

While the modern drama appeared to have relapsed into a comatose condition, poetic and romantic drama was giving some signs of life. At the Lyceum in 1871 Henry Irving had leapt into fame by means of his performance of Mathias in *The Bells*, an adaptation from the French of Erckmann-Chatrian. He followed this up by an admirably picturesque performance of the title-part in *Charles I.* by W. G. Wills. In the autumn of 1874 the great success of Irving's Hamlet was hailed as the prelude to a revival of tragic acting. As a matter of fact, it was the prelude to a long series of remarkable achievements in romantic drama and melodrama. Irving's lack of physical and vocal resources prevented him from scaling the heights of tragedy, and his Othello, Macbeth, and Lear could not be ranked among his successes; but he was admirable in such parts as Richard III., Shylock, Iago and Wolsey, while in melodramatic parts, such as Louis XI. and the hero and villain of *The Lyons Mail*, he was unsurpassed. Mephistopheles in a version of *Faust* (1885), perhaps the greatest popular success of his career, added nothing to his reputation for artistic intelligence; but on the other hand his Becket in Tennyson's play of that name (1893) was one of his most masterly efforts. His management of the Lyceum (1878-1899) did so much to raise the status of the actor and to restore the prestige of poetic drama, that the knighthood conferred upon him in 1895 was felt to be no more than an appropriate recognition of his services. But his managerial career had scarcely any significance for the living English drama. He seldom experimented with a new play,

and, of the few which he did produce, only *The Cup and Becks* by Lord Tennyson have the remotest chance of being remembered.

To trace the history of the new English drama, then, we must go back to the Prince of Wales's theatre. Even while it seemed that French comedy of the school of Scribe was resuming its baneful predominance, the seeds of a new order of things were slowly germinating. *Diplomacy*, an adaptation of Sardou's *Dora*, produced in 1878, brought together on the Prince of Wales's stage Mr and Mrs Bancroft, Mr and Mrs Kendal, John Clayton and Arthur Cecil—in other words, the future managers of the Haymarket, the St James's and the Court theatres, which were destined to see the first real stirrings of a literary revival. Mr and Mrs Kendal, who, in conjunction with John Hare, managed the St James's theatre from 1879 to 1888, produced A. W. Pinero's first play of any consequence, *The Money-Spinner* (1881), and afterwards *The Squire* (1882) and *The Hobby Horse* (1887). The Bancrofts, who, after entirely rebuilding the Haymarket theatre, managed it from 1880 till their retirement in 1885, produced in 1883 Pinero's *Lords and Commons*; and Messrs Clayton and Cecil produced at the Court theatre between 1885 and 1887 his three brilliant farces, *The Magistrate*, *The Schoolmistress* and *Dandy Dick*, which, with the sentimental comedy, *Sweet Lavender*, produced at Terry's theatre in 1888, assured his position as an original and fertile dramatic humorist of no small literary power. It is to be noted, however, that Pinero was almost the only original playwright represented under the Bancroft, Hare-Kendal and Clayton-Cecil managements, which relied for the rest upon adaptations and revivals. Adaptations of French vaudevilles were the staple productions of Charles Wyndham's management at the Criterion from its beginning in 1876 until 1893, when he first produced an original play of any importance. When Herbert Beerbohm Tree went into management at the Haymarket in 1887, he still relied largely on plays of foreign origin. George Alexander's first managerial ventures (Avenue theatre, 1890) were two adaptations from the French. Until well on in the 'eighties, indeed, adaptation from the French was held the normal occupation of the British playwright, and original composition a mere episode. Robertson, Byron, Alberty, Gilbert, Tom Taylor, Charles Reade, Herman Merivale, G. W. Godfrey, all produced numerous adaptations; Sydney Grundy was for twenty years occupied almost exclusively in this class of work; Pinero himself has adapted more than one French play. The 'eighties, then, may on the whole be regarded as showing a very gradual decline in the predominance of France on the English stage, and an equally slow revival of originality, so far as comedy and drama were concerned, manifesting itself mainly in the plays of Pinero.

The reaction against French influence, however, was no less apparent in the domain of melodrama and opera than in that of comedy and drama. Until well on in the 'seventies, D'Ennery and his disciples, adapted and imitated by Dion Boucicault and others, ruled the melodramatic stage. The reaction asserted itself in two quarters—in the East End at the Grecian theatre, and in the West End at the Princess's. In *The World*, produced at Drury Lane in 1880, Paul Meritt (d. 1895) and Henry Pettitt (d. 1893) brought to the West End the "Grecian" type of popular drama; and at Drury Lane it survived in the elaborately spectacular form imparted to it by Sir Augustus Harris, who managed that theatre from 1879 till his death in 1896. The production of G. R. Sims's *Lights o' London* at the Princess's in 1881, under Wilson Barrett's management, also marked a new departure. This style of melodrama was chiefly cultivated at the Adelphi theatre, from 1882 until the end of the century, when it died out there as a regular institution, apparently because a host of suburban theatres drew away its audiences. Of all these English melodramas, only one, *The Silver King*, by Henry Arthur Jones (Princess's, 1882), could for a moment compare in invention or technical skill with the French dramas they supplanted. The fact remains, however, that even on this lowest level of dramatic art the current of the time set decisively towards home-made pictures of English life, however crude and puerile.

For twenty-five years, from 1865 to 1890, the English stage was overrun with French operettas of the school of Offenbach. Hastily adapted by slovenly hacks, their librettos (often witty in the original) became incredible farragos of metreless doggerel and punning ineptitude. The great majority of them are now so utterly forgotten that it is hard to realize how, in their heyday, they swarmed on every hand in London and the provinces. The reaction began in 1875 with the performance at the Royalty theatre of *Trial by Jury*, by W. S. Gilbert and Arthur Sullivan. This was the prelude to that brilliant series of witty and melodious extravaganzas which began with *The Sorcerer* at the Opera Comique theatre in 1877, but was mainly associated with the Savoy theatre, opened by R. D'Oyly Carte (d. 1901) in 1881. Little by little the Gilbert and Sullivan operettas (of which the most famous, perhaps, were *H.M.S. Pinafore*, 1878, *Patience*, 1881, and *The Mikado*, 1885) undermined the popularity of the French opera-bouffes, and at the same time that of the indigenous "burlesques" which, graceful enough in the hands of their inventor J. R. Planché, had become mere incoherent jumbles of buffoonery, devoid alike of dramatic ingenuity and of literary form. When, early in the 'nineties, the collaboration between Gilbert and Sullivan became intermittent, and the vogue of the Savoy somewhat declined, a new class of extravaganza arose, under the designation of "musical comedy" or "musical farce." It first took form in a piece called *In Town*, by Messrs "Adrian Ross" and Osmond Carr (Prince of Wales's theatre, 1892), and rapidly became very popular. In these plays the scene and costumes are almost always modern though sometimes exotic, and the prose dialogue, setting forth an attenuated and entirely negligible plot, is frequently interrupted by musical numbers. The lyrics are often very clever pieces of rhyming, totally different from the inane doggerel of the old opera-bouffes and burlesques. In other respects there is little to be said for the literary or intellectual quality of "musical farce"; but, being an entirely English (or Anglo-American) product, it falls into line with the other indications we have noted of the general decline—one might almost say extinction—of French influence on the English stage.

To what causes are we to trace this gradual disuse of adaptation? In the domain of modern comedy and drama, to two causes acting simultaneously: the decline in France of the method of Scribe, which produced "well-made," exportable plays, more or less suited to any climate and environment; and the rise in England of a generation of playwrights more original, thoughtful and able than their predecessors. It is not at all to be taken for granted that the falling off in the supply of exportable plays meant a decline in the absolute merit of French drama. The historian of the future may very possibly regard the movement in France, no less than the movement in England, as a step in advance, and may even see in the two movements co-ordinate manifestations of one tendency. Be this as it may, the fact is certain that as the playwrights of the Second Empire gradually died off, and were succeeded by the authors of the "new comedy," plays which would bear transplantation became ever fewer and farther between. Of recent years Henri Bernstein, author of *Le Voleur* and *Samson*, has been almost the only French dramatist whose works have found a ready and steady market in England. Attempts to acclimatize French poetical drama—*Pour la Couronne*, *Le Chemineau*, *Cyrano de Bergerac*—were all more or less unsuccessful.

Having noted the decline of adaptation, we may now trace a stage farther the development of the English drama. The first stage, already surveyed, ends with the production of *Sweet Lavender* in 1888. Up to this point its author, Pinero (b. 1855), stood practically alone, and had won his chief successes as a humorist. Henry Arthur Jones (b. 1851) was known as little more than an able melodramatist, though in one play, *Saints and Sinners* (1884), he had made some attempt at a serious study of provincial life. R. C. Carton (b. 1856) had written, in collaboration, one or two plays of slight account. Sydney Grundy (b. 1848) had produced scarcely any original work. The second stage may be taken as extending from 1889 to 1893.

On the 24th of April 1889 John Hare opened the new Garrick theatre with *The Profligate*, by Pinero—an unripe and superficial piece of work in many ways, but still a great advance, both in ambition and achievement, upon any original work the stage had seen for many a year.

With all its faults, it may be said that *The Profligate* notably enlarged at one stroke the domain open to the English dramatist. And it did not stand alone. The same year saw the production of two plays by H. A. Jones, *Wealth and The Middlemarch*, in which a distinct effort towards a serious criticism of life was observable, and of two plays by Sydney Grundy, *A Fool's Paradise* and *A White Lie*, which, though very French in method, were at least original in substance. Jones during the next two years made a steady advance with *Judah* (1890), *The Dancing Girl* and *The Crusaders* (1891). Pinero in these years was putting forth less than his whole strength in *The Cabinet Minister* (1890), *Lady Bountiful* and *The Times* (1891), and *The Amazons* (March 1893). But meanwhile new talents were coming forward. The management of George Alexander, which opened at the Avenue theatre in 1890, but was transferred in the following year to the St James's, brought prominently to the front R. C. Carton, Haddon Chambers and Oscar Wilde. Carton's two sentimental comedies, *Sunlight and Shadow* (1890) and *Liberty Hall* (1892), showed excellent workmanship, but did not yet reveal his true originality as a humorist. Haddon Chambers's work (notably *The Idler*, 1891) was as yet sufficiently commonplace; but in *Lady Windermere's Fan* (1892) Oscar Wilde showed himself at his first attempt a brilliant and accomplished dramatist. Wilde's subsequent plays, *A Woman of No Importance* (1893) and *An Ideal Husband* and *The Importance of being Earnest* (1895), though marred by mannerism and insincerity, did much to promote the movement we are here tracing.

As the production of *The Profligate* marked the opening of the second period in the revival of English drama, so the production of the same author's *The Second Mrs Tanqueray* is very clearly the starting-point of the third period. Before attempting to trace its course we may do well to glance at certain conditions which probably influenced it.

In the first place, economic conditions. The Bancroft-Robertson movement at the old Prince of Wales's, between 1865 and 1870, was of even more importance from an economic than from a literary point of view. By making their little theatre a luxurious place of resort, and faithfully imitating in their productions the accent, costume and furniture of upper and upper-middle class life, the Bancrofts had initiated a reconciliation between society and the stage. Throughout the middle decades of the century it was the constant complaint of the managers that the world of wealth and fashion could not be tempted to the theatre. The Bancroft management changed all that. It was at the Prince of Wales's that half-guinea stalls were first introduced; and these stalls were always filled. As other theatres adopted the same policy of upholstery, both on and off the stage, fashion extended its complaisance to them as well. In yet another way the reconciliation was promoted—by the ever-increasing tendency of young men and women of good birth and education to seek a career upon the English stage. The theatre, in short, became at this period one of the favourite amusements of fashionable (though scarcely of intellectual) society in London. It is often contended that the influence of the sensual and cynical stall audience is a pernicious one. In some ways, no doubt, it is detrimental; but there is another side to the case. Even the cynicism of society marks an intellectual advance upon the sheer rusticity which prevailed during the middle years of the 19th century and accepted without a murmur plays (original and adapted) which bore no sort of relation to life. In a celebrated essay published in 1879, Matthew Arnold (whose occasional dramatic criticisms were very influential in intellectual circles) dwelt on the sufficiently obvious fact that the result of giving English names and costumes to French characters was to make their sayings and doings utterly unreal and "fantastic." During the years of French ascendancy, audiences had quite forgotten that it was possible for the stage to be other than "fantastic"

in this sense. They no longer thought of comparing the mimic world with the real world, but were content with what may be called abstract humour and pathos, often of the crudest quality. The cultivation of external realism, coinciding with, and in part occasioning, the return of society to the playhouse, gradually led to a demand for some approach to plausibility in character and action as well as in costume and decoration. The stage ceased to be entirely "fantastic," and began to essay, however imperfectly, the representation, the criticism of life. It cannot be denied that the influence of society tended to narrow the outlook of English dramatists and to trivialize their tone of thought. But this was a passing phase of development; and cleverly trivial representations of reality are, after all, to be preferred to brainless concoctions of sheer emptiness.

Quite as important, from the economic point of view, as the reconciliation of society to the stage, was the reorganization of the mechanism of theatrical life in the provinces which took place between 1865 and 1875. From the Restoration to the middle of the 19th century the system of "stock companies" had been universal. Every great town in the three kingdoms had its established theatre with a resident company, playing the "legitimate" repertory, and competing, often by illegitimate means, for the possession of new London successes. The smaller towns, and even villages, were grouped into local "circuits," each served by one manager with his troupe of strollers. The "circuits" supplied actors to the resident stock companies, and the stock companies served as nurseries to the patent theatres in London. Metropolitan "stars" travelled from one country theatre to another, generally alone, sometimes with one or two subordinates in their train, and were "supported," as the phrase went, by the stock company of each theatre. Under this system, scenery, costumes and appointments were often grotesquely inadequate, and performances almost always rough and unfinished. On the other hand, the constant practice in a great number and variety of characters afforded valuable training for actors, and developed many remarkable talents. As a source of revenue to authors, the provinces were practically negligible. Stageright was unprotected by law; and even if it had been protected, it is doubtful whether authors could have got any considerable fees out of country managers, whose precarious ventures usually left them a small enough margin of profit.

The spread of railways throughout the country gradually put an end to this system. The "circuits" disappeared early in the 'fifties, the stock companies survived until about the middle of the 'seventies. As soon as it was found easy to transport whole companies, and even great quantities of scenery, from theatre to theatre throughout the length and breadth of Great Britain, it became apparent that the rough makeshifts of the stock company system were doomed. Here again we can trace to the old Prince of Wales's theatre the first distinct impulse towards the new order of things. Robertson's comedies not only encouraged but absolutely required a style of art, in mounting, stage-management and acting, not to be found in the country theatres. To entrust them to the stock companies was well-nigh impossible. On the other hand, to quote Sir Squire Bancroft, "perhaps no play was ever better suited than *Castle* to a travelling company; the parts being few, the scenery and dresses quite simple, and consequently the expenses very much reduced." In 1867, then, a company was organized and rehearsed in London to carry round the provincial theatres as exact a reproduction as possible of the London performance of *Castle* and Robertson's other comedies. The smoothness of the representation, the delicacy of the interplay among the characters, were new to provincial audiences, and the success was remarkable. About the same time the whole Haymarket company, under Buckstone's management, began to make frequent rounds of the country theatres; and other "touring combinations" were soon organized. It is manifest that the "combination" system and the stock company system cannot long coexist, for a manager cannot afford to keep a stock company idle while a London combination is occupying his theatre. The stock companies, therefore, soon dwindled away, and were probably quite extinct before the end

of the 'seventies. Under the present system, no sooner is a play an established success in London than it is reproduced in one, two or three exact copies and sent round the provincial theatres (and the numerous suburban theatres which have sprung up since 1895), Company A serving first-class towns, Company B the second-class towns, and so forth. The process is very like that of taking plaster casts of a statue, and the provincial companies often stand to their London originals very much in the relation of plaster to marble. Even the London scenery is faithfully reproduced in material of extra strength, to stand the wear-and-tear of constant removal. The result is that, instead of the square pegs in round holes of the old stock company system, provincial audiences now see pegs carefully adjusted to the particular holes they occupy, and often incapable of fitting any other. Instead of the rough performances of old, they are now accustomed to performances of a mechanical and soulless smoothness.

In some ways the gain in this respect is undeniable, in other ways the loss is great. The provinces are no longer, in any effective sense, a nursery of fresh talents for the London theatres, for the art acquired in touring combinations is that of mimicry rather than of acting. Moreover provincial playgoers have lost all personal interest and pride in their local theatres, which have no longer any individuality of their own, but serve as a mere frame for the presentation of a series of ready-made London pictures. Christmas pantomime is the only theatrical product that has any really local flavour in it, and even this is often only a second-hand London production, touched up with a few topical allusions. Again, the railways which bring London productions to the country take country playgoers by the thousand to London. The wealthier classes, in the Lancashire, Yorkshire and Midland towns at any rate, do almost all their theatre-going in London, or during the autumn months when the leading London companies go on tour. Thus the better class of comedy and drama has a hard fight to maintain itself in the provinces, and the companies devoted to melodrama and musical farce enjoy an ominous preponderance of popularity.

On the whole, however—and this is the main point to be observed with regard to the literary development of the drama—the economic movement of the five- and twenty years between 1865 and 1890 was enormously to the advantage of the dramatic author. A London success meant a long series of full houses at high prices, on which he took a handsome percentage. The provinces, in which a popular playwright would often have three or four plays going the rounds simultaneously, became a steady source of income. And, finally, it was found possible, even before international copyright came into force, to protect stageright in the United States, so that about the beginning of the 'eighties large receipts began to pour in from America. Thus successful dramatists, instead of living from hand to mouth, like their predecessors of the previous generation, found themselves in comfortable and even opulent circumstances. They had leisure for reading, thought and careful composition, and they could afford to gratify their ambition with an occasional artistic experiment. Failure might mean a momentary loss of prestige, but it would not spell ruin. A distinctly progressive spirit, then, began to animate the leading English dramatists—a spirit which found intelligent sympathy in such managers as John Hare, George Alexander, Beerbohm Tree and Charles Wyndham. Nor must it be forgotten that, though the laws of literary property, internal and international, remained far from perfect, it was found possible to print and publish plays without incurring loss of stageright either at home or in America. The playwrights of the present generation have accordingly a motive for giving literary form and polish to their work which was quite inoperative with their predecessors, whose productions were either kept jealously in manuscript or printed only in miserable and totally unreadable stage editions. It is no small stimulus to ambition to know that even if a play prove to be in advance of the standards of taste or thought among the public to which it is originally presented, it will not perish utterly, but will, if it have any inherent vitality, continue to live as literature.

Having now summed up the economic conditions which made for progress, let us glance at certain intellectual influences which tended in the same direction. The establishment of the Théâtre Libre in Paris, towards the close of 1887, unquestionably marked the beginning of a period of restless experiment throughout the theatrical world of Europe. A. Antoine and his supporters were in open rebellion against the artificial methods of Scribe and the Second Empire playwrights. Their effort was to transfer to the stage the realism, the so-called "naturalism," which had been dominant in French fiction since 1870 or earlier; and this naturalism was doubtless, in its turn, the outcome of the scientific movement of the century. New methods (or ideals) of observation, and new views as to the history and destiny of the race, could not fail to produce a profound effect upon art; and though the modern theatre is a cumbrous contrivance, slow to adjust its orientation to the winds of the spirit, even it at last began to revolve, like a rusty windmill, so as to fill its sails in the main current of the intellectual atmosphere. Within three or four years of its inception, Antoine's experiment had been imitated in Germany, England and America. The "Freie Bühne" of Berlin came into existence in 1889, the Independent Theatre of London in 1891. Similar enterprises were set on foot in Munich and other cities. In America several less formal experiments of a like nature were attempted, chiefly in Boston and New York. Nor must it be forgotten that in Paris itself the Théâtre Libre did not stand alone. Many other *théâtres d'art* sprang up, under such titles as "Théâtre d'Art," "Théâtre Moderne," "Théâtre de l'Avenir Dramatique." The most important and least ephemeral was the "Théâtre de l'Œuvre," founded in 1893 by Alex. Lugné-Poë, which represented mainly, though not exclusively, the symbolist reaction against naturalism.

The impulse which led to the establishment of the Théâtre Libre was, in the first instance, entirely French. If any foreign influence helped to shape its course, it was that of the great Russian novelists. Tolstoi's *Puissance des ténèbres* was the only "exotic" play announced in Antoine's opening manifesto. But the whole movement was soon to receive a potent stimulus from the Norwegian poet Henrik Ibsen.

Ibsen's early romantic plays had been known in Germany since 1875. In 1878 *Pillars of Society* and in 1880 *A Doll's House* achieved wide popularity, and held the German stage side by side with *A Bankruptcy*, by Björnsterne Björnson. But these plays had little influence on the German drama. Their methods were, indeed, not essentially different from those of the French school of the Second Empire, which were then dominant in Germany as well as everywhere else. It was *Ghosts* (acted in Augsburg and Meiningen 1886, in Berlin 1887) that gave the impulse which, coalescing with the kindred impulse from the French Théâtre Libre, was destined in the course of a few years to create a new dramatic literature in Germany. During the middle decades of the century Germany had produced some dramatists of solid and even remarkable talent, such as Friedrich Hebbel, Heinrich Laube, Karl Gutzkow and Gustav Freytag. Even the generation which held the stage after 1870, and included Paul Heyse, Paul Lindau and Adolf Wilbrandt, with numerous writers of light comedy and farce, such as E. Wichert, O. Blumenthal, G. von Moser, A. L'Arronge and F. von Schönthan, had produced a good many works of some merit. But, in the main, French artificiality and frivolity predominated on the German stage. In point of native talent and originality, the Austrian popular playwright Ludwig Anzengruber was well ahead of his North German contemporaries. It was in 1889, with the establishment of the Berlin Freie Bühne, that the reaction definitely set in. In Berlin, as afterwards in London, *Ghosts* was the first play produced on the outpost stage, but it was followed in Berlin by a very rapid development of native talent. Less than a month after the performance of Ibsen's play, Gerhart Hauptmann came to the front with *Ver Sonnenaufgang*, an immature piece of almost unrelieved Zolaism, which he soon followed up, however, with much more important works. In *Das Friedensfest* (1890) and *Einsame Men-*

(1891) he transferred his allegiance from Zola to Ibsen. His true originality first manifested itself in *Die Weber* (1892); and subsequently he produced plays in several different styles, all bearing the stamp of a potent individuality. His most popular productions have been the dramatic poems *Hannele* and *Die versunkene Glocke*, the low-life comedy *Der Biberpels*, and the low-life tragedy *Fuhrmann Henschel*. Other remarkable playwrights belonging to the Freie Bühne group are Max Halbe (b. 1865), author of *Jugend* and *Mutter Erde*, and Otto Erich Hartleben (b. 1864), author of *Hanna Jagert* and *Rosenmontag*. These young men, however, so quickly gained the ear of the general public, that the need for a special "free stage" was no longer felt, and the Freie Bühne, having done its work, ceased to exist. Unlike the French Théâtre Libre and the English Independent theatre, it had been supported from the outset by the most influential critics, and had won the day almost without a battle. The productions of the new school soon made their way even into some of the subventioned theatres; but it was the unsubventioned Deutsches Theater of Berlin that most vigorously continued the tradition of the Freie Bühne. One or two playwrights of the new generation, however, did not actually belong to the Freie Bühne group. Hermann Sudermann produced his first play, *Die Ehre*, in 1888, and his most famous work, *Heimat*, in 1892. In him the influence of Ibsen is very clearly perceptible; while Arthur Schnitzler of Vienna, author of *Liebelein*, may rather be said to derive his inspiration from the Parisian "new comedy." Originality, verging sometimes on abnormality, distinguishes the work of Frank Wedekind (b. 1864), author of *Eräcrist* and *Frühlingserwachen*. Hugo von Hofmannsthal (b. 1874), in his *Elektra* and *Ödipus*, rehandles classic themes in the light of modern anthropology and psychology.

The promoters of the Théâtre Libre had probably never heard of Ibsen when they established that institution, but three years later his fame had reached France, and *Les Renoués* was produced by the Théâtre Libre (20th May 1890). Within the next two or three years almost all his modern plays were acted in Paris, most of them either by the Théâtre Libre or by L'Œuvre. Close upon the heels of the Ibsen influence followed another, less potent, but by no means negligible. The exquisite tragic symbolism of Maurice Maeterlinck began to find numerous admirers about 1890. In 1891 his one-act play *L'Intruse* was acted; in 1893, *Pelléas et Mélisande*. By this time, too, the reverberation of the impulse which the Théâtre Libre had given to the Freie Bühne began to be felt in France. In 1893 Hauptmann's *Die Weber* was acted in Paris, and, being frequently repeated, made a deep and lasting impression.

The English analogue to the Théâtre Libre, the Independent theatre, opened its first season (March 13, 1891) with a performance of *Ghosts*. This was not, however, the first introduction of Ibsen to the English stage. On the 7th of June 1889 (six weeks after the production of *The Profligate*) *A Doll's House* was acted at the Novelty theatre, and ran for three weeks, amid a storm of critical controversy. In the same year *Pillars of Society* was presented in London. In 1891 and 1892 *A Doll's House* was frequently acted; *Rosmersholm* was produced in 1891, and again in 1893; in May and June 1891 *Hedda Gabler* had a run of several weeks, and early in 1893 *The Master Builder* enjoyed a similar passing vogue. During these years, then, Ibsen was very much "in the air" in England, as well as in France and Germany. The Independent theatre, in the meantime, under the management of J. T. Grein, found but scanty material to deal with. It presented translations of Zola's *Thérèse Raquin*, and of *A Visité*, by the Danish dramatist Edward Brandes; but it brought to the front only one English author of any note, in the person of George Bernard Shaw, whose "didactic realistic play," *Widowers' Houses*, it produced in December 1892.

None the less it is true that the ferment of fresh energy, which between 1887 and 1893 had created a new dramatic literature both in France and in Germany, was distinctly felt in England as well. England did not take at all kindly to it. The productions of Ibsen's plays, in particular, were received with an outcry of reprobation. A great part of this clamour was due to sheer

misunderstanding; but some of it, no doubt, arose from genuine and deep-seated distaste. As for the dramatists of recognized standing, they one and all, both from policy and from conviction, adopted a hostile attitude towards Ibsen, expressing at most a theoretical respect overborne by practical dislike. Yet his influence permeated the atmosphere. He had revealed possibilities of technical stagecraft and psychological delineation that, once realized, were not to be banished from the mind of the thoughtful playwright. They haunted him in spite of himself. Still subtler was the influence exerted over the critics and the more intelligent public. Deeply and genuinely as many of them disliked Ibsen's works, they found, when they returned to the old-fashioned play, the adapted frivolity or the home-grown sentimentalism, that they disliked this still more. On every side, then, there was an instinctive or deliberate reaching forward towards something new; and once again it was Pinero who ventured the decisive step.

On the 27th of May 1893 *The Second Mrs Tanqueray* was produced at the St James's theatre. With *The Second Mrs Tanqueray* the English acted drama ceased to be a merely insular product, and took rank in the literature of Europe. Here was a play which, whatever its faults, was obviously comparable with the plays of Dumas, of Sudermann, of Björnson, of Echegaray. It might be better than some of these plays, worse than others; but it stood on the same artistic level. The fact that such a play could not only be produced, but could brilliantly succeed, on the London stage gave a potent stimulus to progress. It encouraged ambition in authors, enterprise in managers. What *Hernani* was to the romantic movement of the 'thirties, and *La Dame aux camélias* to the realistic movement of the 'fifties, *The Second Mrs Tanqueray* was to the movement of the 'nineties towards the serious stage-portraiture of English social life. All the forces which we have been tracing—Robertsonian realism of externals, the leisure for thought and experiment involved in vastly improved financial conditions, the substitution in France of a simpler, subtler technique for the outworn artifices of the Scribe school, and the electric thrill communicated to the whole theatrical life of Europe by contact with the genius of Ibsen—all these slowly converging forces coalesced to produce, in *The Second Mrs Tanqueray*, an epoch-marking play.

Pinero followed up *Mrs Tanqueray* with a remarkable series of plays—*The Notorious Mrs Ebb-smith*, *The Benefit of the Doubt*, *The Princess and the Butterfly*, *Trelawny of the "Wells"*, *The Gay Lord Quesz*, *Iris*, *Lelly*, *His House in Order* and *The Thunder-bolt*—all of which show marked originality of conception and intellectual force. In January 1893 Charles Wyndham initiated a new policy at the Criterion theatre, and produced an original play, *The Bauble-Shop*, by Henry Arthur Jones. It belonged very distinctly to the pre-Tanqueray order of things; but the same author's *The Case of Rebellious Susan*, in the following year, showed an almost startlingly sudden access of talent, which was well maintained in such later works as *Michael and his Lost Angel* (1896), that admirable comedy *The Liars* (1897), and *Mrs Dane's Defence* (1900). Sydney Grundy produced after 1893 by far his most important original works, *The Greatest of These* (1896) and *The Debt of Honour* (1900). R. C. Carton, breaking away from the somewhat laboured sentimentalism of his earlier manner, produced several light comedies of thoroughly original humour and of excellent literary workmanship—*Lord and Lady Aley*, *Wheels within Wheels*, *Lady Huntworth's Experiment*, *Mr Hopkinson* and *Mr Preedy and the Countess*. Haddon Chambers, in *The Tyranny of Tears* (1899) and *The Awakening* (1901), produced two plays of a merit scarcely overshadowed in his earlier efforts.

What was of more importance, a new generation of playwrights came to the front. Its most notable representatives were J. M. Barrie, who displayed his inexhaustible gift of humorous observation and invention in *Quality Street* (1902), *The Admirable Crichton* (1903), *Little Mary* (1903), *Peter Pan* (1904), *Alice Sit-by-the-Fire* (1905) and *What Every Woman Knows* (1908); Mrs Craigie ("John Oliver Hobbes"), who produced in *The Ambassador* (1898) a comedy of fine accomplishment;

and H. V. Esmond, Alfred Sutro, Hubert Henry Davies, W. S. Maugham, Rudolf Besier, Roy Horniman and J. B. Fagan.

Meanwhile, the efforts to relieve the drama from the pressure of the long-run system had not been confined to the Independent theatre. Several other enterprises of a like nature had proved more or less short-lived; but the Stage Society, founded in 1900, was conducted with more energy and perseverance, and became a real force in the dramatic world. After two seasons devoted mainly to Bernard Shaw, Ibsen, Maeterlinck and Hauptmann, it produced in its third season *The Marrying of Ann Leete*, by Granville Barker (b. 1877), who had developed in its service his remarkable gifts as a producer of plays. A year or two later, Barker staged for another organization, the New Century theatre, Professor Gilbert Murray's rendering of the *Hippolytus* of Euripides; and it was partly the success of this production that suggested the Vedrenne-Barker partnership at the Court theatre, which, between 1904 and 1907, gave an extraordinary impulse to the intellectual life of the theatre. Adopting the "short-run" system, as a compromise between the long-run and the repertory systems, the Vedrenne-Barker management made the plays of Bernard Shaw (both old and new) for the first time really popular. Of the plays already published *You Never Can Tell* and *Man and Superman* were the most successful; of the new plays, *John Bull's Other Island*, *Major Barbara* and *The Doctor's Dilemma*. But though Shaw was the mainstay of the enterprise, it gave opportunities to several other writers, the most notable being John Galsworthy (b. 1867), author of *The Silver Box* and *Strife*, St John Hankin (1869-1909), author of *The Return of the Prodigal* and *The Charity that began at Home*, and Granville Barker himself, whose plays *The Voyage Inheritance* and *Waste* (1907) were among the most important products of this movement. It should also be noted that the production of the *Hippolytus* was followed up by the production of the *Trojan Women*, the *Electra* and the *Medea* of Euripides, all translated by Gilbert Murray.

The impulse to which were due the Independent theatre, the Stage Society and the Vedrenne-Barker management, combined with local influences to bring about the foundation in Dublin of the Irish National theatre. Its moving spirit was the poet W. B. Yeats (b. 1865), who wrote for it *Cathleen ni-Hoolihan*, *The Hour-Glass*, *The King's Threshold* and one or two other plays. Lady Gregory, Padraic Collum, Boyle and other authors also contributed to the repertory of this admirable little theatre; but its most notable products were the plays of J. M. Synge (1871-1909), whose *Riders to the Sea*, *Well of the Saints* and *Playboy of the Western World* showed a fine and original dramatic faculty combined with extraordinary beauty of style.

Both in Manchester and in Glasgow endeavours have been made, with considerable success, to counteract the evils of the touring system, by the establishment of resident companies acting the better class of modern plays on a "short-run" plan, similar to that of the Vedrenne-Barker management. The Manchester enterprise was to some extent subsidized by Miss E. Horniman, and may therefore claim to be the first endowed theatre in England. The need for endowment on a much larger scale was, however, strongly advocated in the early years of the 20th century by the more progressive supporters of English drama, and in 1908 found a place in the scheme for a Shakespeare National theatre, which was then superimposed on the earlier proposal for a memorial commemorating the Shakespeare tercentenary, organized by an influential committee under the chairmanship of the Lord Mayor of London. The scheme involved the raising of £500,000, half to be devoted to the requisite site and building, while the remainder would be invested so as to furnish an annual subvention.

It remains to say a few words of the English literary drama, as opposed to the acted drama. The two classes are not nearly so distinct as they once were; but plays continue to be produced from time to time which are wholly unfitted for the theatre, and others which, though they may be experimentally placed on the stage, make their appeal rather to the reading public. Tennyson had essayed in his old age an art which is scarcely

to be mastered after the energy of youth has passed. He continued to the last to occupy himself more or less with drama, and all his plays, except *Harold*, found their way to the stage. *The Cup and Becket*, as we have seen, met with a certain success, but *The Promise of May* (1882), an essay in contemporary drama, was a disastrous failure, while *The Falcon* (1879) and *The Foresters* (acted by an American company in 1893) made little impression. Lord Tennyson was certainly not lacking in dramatic faculty, but he worked in an outworn form which he had no longer the strength to renovate. Swinburne continued now and then to cast his creations in the dramatic mould, but it cannot be said that his dramas attained either the vitality or the popularity of his lyrical poems. *Mary Stuart* (1881) brought his Marian trilogy to a close. In *Lochnire* he produced a tragedy in heroic couplets—a thing probably unattempted since the age of Dryden. *The Sisters* is a tragedy of modern date with a mediæval drama inserted by way of interlude. *Rosamund, Queen of the Lombards* (1899), perhaps approached more nearly than any of his former works to the concentration essential to drama. It may be doubted, however, whether his copious and ebullient style could ever really subject itself to the trammels of dramatic form. Of other dramas on the Elizabethan model, the most notable, perhaps, were the works of two ladies who adopt the pseudonym of "Michael Field"; *Callirrhoe* (1884), *Bruis Ullor* (1887), and many other dramas, show considerable power of imagination and expression, but are burdened by a deliberate artificiality both of technique and style. Alfred Austin put forth several volumes in dramatic form, such as *Savonarola* (1882), *Prince Lucifer* (1887), *England's Darling* (1896), *Flodden Field* (1905). They are laudable in intention and fluent in utterance. Notable additions to the purely literary drama were made by Robert Bridges in his *Prometheus* (1883), *Nero* (1885), *The Feast of Bacchus* (1889), and other solid plays in verse, full of science and skill, but less charming than his lyrical poems. Sir Lewis Morris made a dramatic experiment in *Gycia*, but was not encouraged to repeat it.

From the outset of his career, John Davidson (1857-1909) was haunted by the conviction that he was a born dramatist; but his earlier plays, such as *Smith: a Tragedy* (1886), *Bruce: a Chronicle Play* (1884) and *Scaramouch in Nazos* (1888), contained more poetry than drama; and his later pieces, such as *Self's the Man* (1901), *The Theocrat* (1905) and *The Triumph of Mammon* (1907), showed a species of turbulent imagination, but became more and more fantastic and impracticable. Stephen Phillips (b. 1867), on the other hand, having had some experience as an actor, wrote always with the stage in view. In his first play, *Paolo and Francesca* (1899; produced in 1902), he succeeded in combining great beauty of diction with intense dramatic power and vitality. The same may be said of *Herod* (1900); but in *Ulysses* (1902) and *Nero* (1906) a great falling-off in constructive power was only partially redeemed by the fine inspiration of individual passages.

The collaboration of Robert Louis Stevenson with William Ernest Henley produced a short series of interesting experiments in drama, two of which, *Beau Austin* (1883) and *Admiral Guinea* (1884), had more than a merely experimental value. The former was an emotional comedy, treating with rare distinction of touch a difficult, almost an impossible, subject; the latter was a nautical melodrama, raised by force of imagination and diction into the region of literature. Incomparably the most important of recent additions to the literary drama is Thomas Hardy's vast panorama of the Napoleonic wars, entitled *The Dynasts* (1904-1908). It is rather an epic in dialogue than a play; but however we may classify it we cannot but recognize its extraordinary intellectual and imaginative powers.

United States.—American dramatists have shown on their own account a progressive tendency, quite as marked as that which we have been tracing in England. Down to about 1890 the influence of France had been even more predominant in America than in England. The only American dramatist of eminence, Bronson Howard (1842-1908), was a disciple, though a very able one, of the French school. A certain stirring of native

originality manifested itself during the 'eighties, when a series of semi-improvised farces, associated with the names of two actor-managers, Harrigan and Hart, depicted low life in New York with real observation, though in a crude and formless manner. About the same time a native style of popular melodrama began to make its appearance—a play of conventional and negligible plot, which attracted by reason of one or more faithfully observed character-types, generally taken from country life. *The Old Homestead*, written by Denman Thompson, who himself acted in it, was the most popular play of this class. Rude as it was, it distinctly foreshadowed that faithfulness to the external aspects, at any rate, of everyday life, in which lies the strength of the native American drama. It was at a sort of free theatre in Boston that James A. Herne (1840-1901) produced in 1891 his realistic drama of modern life, *Margaret Fleming*, which did a great deal to awaken the interest of literary America in the theatrical movement. Herne, an actor and a most accomplished stage-manager, next produced a drama of rural life in New England, *Shore Acres* (1892), which made an immense popular success. It was a play of the *Old Homestead* type, but very much more coherent and artistic. His next play, *Griffith Davenport* (1898), founded on a novel, was a drama of life in Virginia during the Civil War, admirable in its strength and quiet sincerity; while in his last work, *Sag Harbour* (1900), Herne returned to the study of rustic character, this time in Long Island. Herne showed human nature in its more obvious and straightforward aspects, making no attempt at psychological subtlety; but within his own limits he was an admirable craftsman. The same preoccupation with local colour is manifest in the plays of Augustus M. Thomas, a writer of genuine humour and originality. His localism announces itself in the very titles of his most popular plays—*Alabama*, *In Mizouza*, *Arizona*. He also made a striking success in *The Witching Hour*, a play dealing with the phenomena of hypnotism and suggestion. Clyde Fitch (1865-1909), an immensely prolific playwright of indubitable ability, after becoming known by some experiments in quasi-historic drama (notably *Nathan Hale*, 1898; *Barbara Frietchie*, 1899), devoted himself mainly to social drama on the French model, in which his most notable efforts have been *The Climbers* (1900), *The Truth* (1906), and *The Girl with the Green Eyes* (1902). In popular drama, with elaborate scenic illustration, William Gillette (b. 1856), David Belasco (b. 1859) and Charles Klein (b. 1867) have done notable work. William Vaughn Moody (b. 1869) produced in *The Great Divide* (1907) a play of somewhat higher artistic pretensions; Eugene Walter in *Paid in Full* (1908) and *The Easiest Way* (1909) dealt vigorously with characteristic themes of modern life; and Edward Sheldon produced in *Salvation Nell* a slum drama of very striking realism. The poetic side of drama was mainly represented by Percy Mackaye (b. 1875), whose *Jeanne d'Arc* (1906) and *Sappho and Phaon* showed a high ambition and no small literary power. On the whole it may be said that, though the financial conditions of the American stage are even more unfortunate than those which prevail in England, they have failed to check a very strong movement towards nationalism in drama. Season by season, America writes more of her own plays, good or bad, and becomes less dependent on imported work, whether French or English.

(g) German Drama.

The history of the German drama differs widely from that of the English, though a close contact is observable between them at an early point, and again at relatively recent points, in their annals. The dramatic literature of Germany, though in its beginnings intimately connected with the great national movement of the Reformation, soon devoted its efforts to a sterile imitation of foreign models; while the popular stage, persistently suiting itself to a robust but gross taste, likewise largely due to the influence of foreign examples, seemed destined to a hopeless decay. The literary and the acted drama were thus estranged from one another during a period of extraordinary length; nor was it till the middle of the 18th century that, with the opening of a more hopeful era for the life and literature of the

nation, the reunion of dramatic literature and the stage began to accomplish itself. Before the end of the same century the progress of the German drama in its turn began to influence that of other nations, and by the widely comprehensive character of its literature, as well as by the activity of its stage, to invite a steadily increasing interest.

It should be premised that in its beginnings the modern German drama might have seemed likely to be influenced even more largely than the English or the French by the copious imitation of classical models which marked *The Latin drama in Germany.* the periods of the Renaissance and the Reformation; but here the impulse of originality was wanting to bring about a speedy and gradually a complete emancipation, and imitative reproduction continued in an all but endless series. The first German (and indeed the earliest transalpine) writer to follow in the footsteps of the modern Latin drama of the Italians was the famous Strassburg humanist Jacob Wimpfeling (1450-1528), whose comedy of *Syphilo* (1480), an attack upon the ignorance of the pluralist benefited clergy, marks a kind of epoch in the history of German dramatic effort. It was succeeded by many other Latin plays of various kinds, among which may be mentioned J. Kerckmeister's *Codrus* (1485), satirizing pedantic schoolmasters; a series of historical dramas in a moralizing vein, partly on the Turkish peril, as well as of comedies, by Jacob Locher (1471-1528); two plays by the great Johann Reuchlin, of which the so-called *Henno* went through more than thirty editions; and the *Ludus Daniæ*, with another play likewise in honour of the emperor Maximilian I., by the celebrated Viennese scholar Conrad Celtis (1459-1508). Sebastian Brant's *Hercules in Bivio* (1512) is lost; but Willibald Pirckheimer's *Eckius dololatus* (1520) survives as a dramatic contribution to Luther's controversy with one of his most active opponents. The *Acolastus* (1525) of W. Gnaphæus (*alias* Fullonius, his native name was de Volder) should also be mentioned in the present connexion, as, though a Dutchman by birth, he spent most of his literary life in Germany. This Terentian version of the parable of the Prodigal Son was printed in an almost endless number of editions, as well as in various versions in modern tongues, among which reference has already been made to the English, for the use of schools, by J. Palsgrave (1540). Macropeidius (Langhveldt) belongs wholly to the Low Countries. In Germany the stream of these compositions continued to flow almost without abatement throughout the earlier half of the 16th century; but in the days of the Reformation it takes a turn to scriptural subjects, and during the latter part of the century remains on the whole faithful to this preference.¹ These Latin plays may be called school-dramas in the most precise sense; for they were both performed in the schools and read in class with commentaries specially composed for them; nor was it except very reluctantly that in this age the vernacular drama was allowed to intrude into scholastic circles. It should be noticed that the Jesuit order, which afterwards proved so keenly alive to the influence which dramatic performances exercise over the youthful mind, only very gradually abandoned the principle, formally sanctioned in their *Ratio studiorum*, that the acting of plays (these being always in the Latin tongue) should only rarely be permitted in their seminaries. The flourishing period of the Jesuit drama begins with the spread of the order in the west and south-west of the Empire in the last decade of the 16th century, and then continues, through the vicissitudes of good and evil, with a curious intermixture of Latin and German plays, during the whole of the 17th and the better part of the 18th. These productions, which ranged in their subjects from biblical and classical story to themes of contemporary history (such as the relief of Vienna by Sobiesky and the peace of Ryswick), seem generally to bear the mark of their authorship—that of teachers appointed by their superiors to execute this among other tasks allotted to them; but, as it seems unnecessary to return to this special growth, it may be added that the

¹ A drama entitled *Speculum vitæ humanæ* is mentioned as produced by Archduke Ferdinand of the Tirol in 1584.

extraordinary productiveness of the Jesuit dramatists, and the steadiness of self-repetition which is equally characteristic of them, should warn us against underrating its influence upon a considerable proportion of the nation's educational life during a long succession of generations.

While the scholars of the German Renaissance, who became so largely the agents of the Reformation, eagerly dramatized scriptural subjects in the Latin, and sometimes (as in the case of Luther's protégé P. Rebhun¹) in the native tongue, the same influence made itself felt in another sphere of dramatic activity. Towards the close of the middle ages, as has been seen, dramatic performances had in Germany, as in England, largely fallen into the hands of the civic guilds, and the composition of plays was more especially cultivated by the master-singers of Nuremberg and other towns. It was thus that, under the influence of the Reformation, and of the impulse given by Luther and others to the use of High German as the popular literary tongue, Hans Sachs, the immortal shoemaker of Nuremberg, seemed destined to become the father of the popular German drama. In his plays, "spiritual," "secular," and *Fastnachtsspiele* alike, the interest indeed lies in the dialogue rather than in the action, nor do they display any attempt at development of character. In their subjects, whether derived from Scripture or from popular legend and fiction,² there is no novelty, and in their treatment no originality. But the healthy vigour and fresh humour of this marvellously fertile author, and his innate sympathy with the views and sentiments of the burgher class to which he belonged, were elements of genuine promise—a promise which the event was signally to disappoint. Though the manner of Hans Sachs found a few followers, and is recognizable in the German popular drama even of the beginning of the 17th century, the literature of the Reformation, of which his works may claim to form part, was soon absorbed in labours of a very different kind. The stage, after admitting novelties introduced from Italy or (under Jesuit supervision) from Spain, was subjected to another and enduring influence. Among the foreign actors of various nations who flitted through the innumerable courts of the empire, or found a temporary home there, special prominence was acquired, towards the close of the 16th and in the early years of the 17th century, by the "English comedians," who appeared at Cassel, Wolfenbüttel, Berlin, Dresden, Cologne, &c. Through these players a number of early English dramas found their way into Germany, where they were performed in more or less imperfect versions, and called forth imitations by native authors. Duke Henry Julius of Brunswick-Lüneburg³ (1564-1613) and Jacob Ayrer (a citizen of Nuremberg, where he died, 1605) represent the endeavours of the early German drama to suit its still uncouth forms to themes suggested by English examples; and in their works, and in those of contemporary playwrights, there reappears no small part of what we may conclude to have been the "English comedians'" *répertoire*.⁴ (The converse influence of German themes brought home with them by the English actors, or set in motion by their strolling ubiquity, cannot have been equal in extent, though Shakespeare himself may have derived the idea of one of his plots⁵ from such a source). But, though welcome to both princes and people, the exertions of these foreign comedians, and of the native imitators who soon arose in the earliest professional companies of actors known in Germany, instead of bringing about a union between the stage and literature, led to a directly opposite result. The popularity of these strollers was owing partly to the (very real) blood and other horrors with which their plays were deluged, partly to the buffoonery with which they seasoned, and the various tricks and feats with which they diversified, their per-

Hans Sachs.

¹ *Susanna (Geistliches Spiel)* (1536), &c. Sixt Birk also brought out a play on the story of *Susanna*, which he had previously treated in a Latin form, in the vernacular (1552).

The English comedians.

² *Siefried; Eulenspiegel, &c.*

³ *Susanna; Vincentius Ladislaus, &c.*

⁴ *Mahomet; Edward III.; Hamlet; Romeo and Juliet, &c.*

⁵ *The Tempest* (Ayrer, *Comedia v. d. schönen Sida*).

formances. The representatives of the English clowns had learnt much on their way from their brethren in the Netherlands, where in this period the art of grotesque acting greatly flourished. Nor were the aids of other arts neglected,—to this day in Germany professors of the "equestrian drama" are known by the popular appellation of "English riders." From these true descendants of the mimes, then, the professional actors in Germany inherited a variety of tricks and traditions; and soon the favourite figures of the popular comic stage became conventional, and were stereotyped by the use of masks. Among these an acknowledged supremacy was acquired by the native *Hans Wurst* (Jack Pudding)—of whose name Luther disavowed the invention, and who is known already to Hans Sachs—the privileged buffoon, and for a long series of generations the real lord and master, of the German stage. If that stage, with its grossness and ribaldry, seemed likely to become permanently estranged from the tastes and sympathies of the educated classes, the fault was by no means entirely its own and that of its patron the populace. The times were evil times for a national effort of any kind; and poetic literature was in all its branches passing into the hands of scholars who were often pedants, and whose language was a jargon of learned affectations. Thus things continued, till the awful visitation of the Thirty Years' War cast a general blight upon the national life, and the traditions of the popular theatre were left to the guardianship of the marionettes (*Puppenspiele*)!

When, in the midst of that war, German poets once more began to essay the dramatic form, the national drama was left outside their range of vision. M. Opitz, who holds an honoured place in the history of the German language and literature, in this branch of his labours contented himself with translations of classical dramas and of Italian pastorals—among the latter one of Rinuccini's *Daphne*, with which the history of the opera in Germany begins.

A. Gryphius, though as a comic dramatist lacking neither vigour nor variety, and acquainted with Shakespearian⁶ as well as Latin and Italian examples, chiefly devoted himself to the imitation of Latin, earlier French, and Dutch tragedy, the rhetorical dialogue of which he effectively reproduced in the Alexandrine metre.⁷ Neither the turgid dramas of D. C. von Lohenstein (1665-1684), for whose *Cleopatra* the honour of having been the first German tragedy has been claimed, nor even the much healthier comedies of Chr. Weise (1642-1708) were brought upon the stage; while the religious plays of J. Klay (1616-1656) are mere recitations connected with the Italian growth of the *oratorio*. The frigid allegories commemorative of contemporary events, with which the learned from time to time supplied the theatre, and the pastoral dramas with which the idyllic poets of Nuremberg—"the shepherds of the Pegnitz"—after the close of the war gratified the peaceful longings of their fellow-citizens, were alike mere scholastic efforts. These indeed continued in the universities and *gymnasias* to keep alive the love of both dramatic composition and dramatic representation, and to encourage the theatrical taste which led so many students into the professional companies. But neither these dramatic exercises nor the *ludi Caesares* in which the Jesuits at Vienna revived the pomp and pageantry, and the mixture of classical and Christian symbolism, of the Italian Renaissance, had any influence upon the progress of the popular drama.

The history of the German stage remains to about the second decennium of the 18th century one of the most melancholy, as it is in its way one of the most instructive, chapters of theatrical history. Ignored by the world of letters, the actors in return deliberately sought to emancipate their art from all dependence upon literary material. Improvisation reigned supreme, not only in farce, where *Hans Wurst*, with the aid of Italian examples, never ceased to charm

⁶ *Herr Peter Squenz (Pyramus and Thisbe); Horribilicribrifax (Pistol?)*.

⁷ His son, Christian Gryphius, was author of a curious dramatic summary (or *revue*) of German history, both literary and political; but the title of this school-drama is far too long for quotation.

Separation between the stage and literature.

The literary drama of the 17th century.

The stage before its reform.

his public, but in the serious drama likewise (in which, however, he also played his part) in those *Haupt- und Staatsactionen* (high-matter-of-state-dramas), the plots of which were taken from the old stores of the English comedians, from the religious drama and its sources, and from the profane history of all times. The hero of this period is "Magister" J. Velthen (or Veltheim), who at the head of a company of players for a time entered the service of the Saxon court, and, by reproducing comedies of Molière and other writers, sought to restrain the licence which he had himself carried beyond all earlier precedent, but who had to fall back into the old ways and the old life. His career exhibits the climax of the efforts of the art of acting to stand alone; after his death (c. 1693) chaos ensues. The strolling companies, which now included actresses, continued to foster the popular love of the stage, and even under its most degraded form to uphold its national character against the rivalry of the opera, and that of the Italian *commedia dell' arte*. From the latter was borrowed Harlequin, with whom *Hans Wurst* was blended, and who became a standing figure in every kind of popular play.¹ He established his sway more especially at Vienna, where from about 1712 the first permanent German theatre was maintained. But for the actors in general there was little permanence, and amidst miseries of all sorts, and under the growing ban of clerical intolerance, the popular stage seemed destined to hopeless decay. A certain vitality of growth seems, under clerical guidance, to have characterized the plays of the people in Bavaria and parts of Austria.

The first endeavours to reform what had thus apparently passed beyond all reach of recovery were neither wholly nor generally successful; but this does not diminish the honour due to two names which should never be mentioned without respect in connexion with the history of the drama. Friederike Karoline Neuber's (1697-1760) biography is the story of a long-continued effort which, notwithstanding errors and weaknesses, and though, so far as her personal fortunes were concerned, it ended in failure, may almost be described as heroic. As directress of a company of actors which from 1727 had its headquarters at Leipzig (hence the new school of acting is called the Leipzig school), she resolved to put an end to the formlessness of the existing stage, to separate tragedy and comedy, and to extinguish Harlequin. In this endeavour she was supported by the Leipzig professor J. Chr. Gottsched, who induced her to establish French tragedy and comedy as the sole models of the regular drama. Literature and the stage thus for the first time joined hands, and no temporary mischance or personal misunderstanding can obscure the enduring significance of the union. Not only were the abuses of a century swept away from a representative theatre, but a large number of literary works, designed for the stage, were produced on it. It is true that they were but versions or imitations from the French (or in the case of Gottsched's *Dying Cato* from the French and English),² and that at the moment of the regeneration of the German drama new fetters were thus imposed upon it, and upon the art of acting at the same time. But the impulse had been given, and the beginning made. On the one hand, men of letters began to subject their dramatic compositions to the test of performance; the tragedies and comedies of J. E. Schlegel, the artificial and sentimental comedies of Chr. F. Gellert and others, together with the vigorous popular comedies of the Danish dramatist Holberg, were brought into competition with translations from the French. On the other hand, the

Leipzig school exercised a continuous effect upon the progress of the art of acting, and before long K. Ekhof began a career which made his art a fit subject for the critical study of scholars, and his profession one to be esteemed by honourable men.

Among the authors contributing to Mme. Neuber's Leipzig enterprise had been a young student destined to complete, after ¹One of his *aliases* was *Pickelhärnig*. In 1702 the electress Sophia is found requesting Leibniz to see whether a more satisfactory specimen of this class cannot be procured from Berlin than is at present to be found at Hanover.

² Deschamps and Addison.

a very different fashion and with very different aims, the work which she and Gottsched had begun. The critical genius of G. E. Lessing is peerless in its comprehensiveness, as in its keenness and depth; but if there was any branch of literature and art which by study and practice he made pre-eminently his own, it was that of the drama. As bearing upon the progress of the German theatre, his services to its literature, both critical and creative, can only be described as inestimable. The *Hamburgische Dramaturgie*, a series of criticisms of plays and (in its earlier numbers) of actors, was undertaken in furtherance of the attempt to establish at Hamburg the first national German theatre (1767-1769). This fact alone would invest these papers with a high significance; for, though the theatrical enterprise proved abortive, it established the principle upon which the progress of the theatre in all countries depends—that for the dramatic art the immediate theatrical public is no sufficient court of appeal. But the direct effect of the *Dramaturgie* was to complete the task which Lessing had in previous writings begun, and to overthrow the dominion of the arbitrary French rules and the French models established by Gottsched. Lessing vindicated its real laws to the drama, made clear the difference between the Greeks and their would-be representatives, and established the claims of Shakespeare as the modern master of both tragedy and comedy. His own dramatic productivity was cautious, tentative, progressive. His first step was, by his *Miss Sara Sampson* (1755), to oppose the realism of the English domestic drama to the artificiality of the accepted French models, in the forms of which Chr. F. Weisse (1726-1804) was seeking to treat the subjects of Shakespearian plays.³ Then, in his *Minna von Barnhelm* (1767), which owed something to Farquhar, he essayed a national comedy drawn from real life, and appealing to patriotic sentiments as well as to broad human sympathies. It was written in prose (like *Miss Sara Sampson*), but in form held a judicious mean between French and English examples.

The note sounded by the criticisms of Lessing met with a ready response, and the productivity displayed by the nascent dramatic literature of Germany is astonishing, both in the efforts inspired by his teachings and in those ^{Efforts of the theatre which continued to controvert or which aspired and of Harlequin.} to transcend them. On the stage, Harlequin and his surroundings proved by no means easy to suppress, more especially at Vienna, the favourite home of frivolous amusement; but even here a reform was gradually effected, and, under the intelligent rule of the emperor Joseph II., a national stage grew into being. The mantle of Ekhof fell upon the shoulders of his eager younger rival, F. L. Schröder, who was the first to domesticate Shakespeare upon the German stage. In dramatic literature few of Lessing's earlier contemporaries produced any works of permanent value, unless the religious dramas of F. G. Klopstock—a species in which he had been preceded by J. J. Bodmer—and the patriotic *Bardiellen* of the same author be excepted. S. Gessner, J. W. L. Gleim, and G. K. Pfeffel (1736-1809) composed pastoral plays. But a far more potent stimulus prompted the efforts of the younger generation. The translation of Shakespeare, begun in 1762 by C. M. Wieland, whose own plays possess no special significance, and completed in 1775 by Eschenburg, which furnished the text for many of Lessing's criticisms, helps to mark an epoch in German literature. Under the influence of Shakespeare, or of their conceptions of his genius, arose a youthful group of writers who, while worshipping their idol as the representative of nature, displayed but slight anxiety to harmonize their imitations of him with the demands of art. The notorious *Ugolino* of H. W. von Gerstenberg seemed a premonitory sign that the coming flood might merely rush back to the extravagances and horrors of the old popular stage; and it was with a sense of this danger in prospect that Lessing in his third important drama, the prose tragedy *Emilia Galotti* (1772), set the example of a work of incomparable nicety in its adaptation of means to end. But successful as it proved, it could not stay the excesses of the *Sturm und Drang* period

³ *Richard III.: Romeo and Juliet.*

which now set in. Lessing's last drama, *Nathan der Weise* (1779), was not measured to the standard of the contemporary stage; but it was to exercise its influence in the progress of time—not only by causing a reaction in tragedy from prose to blank verse (first essayed in J. W. von Brawe's *Brutus*, 1770), but by ennobling and elevating by its moral and intellectual grandeur the branch of literature to which in form it belongs.

Meanwhile the young geniuses of the *Sturm und Drang* had gone forth, as worshippers rather than followers of Shakespeare, to conquer new worlds. The name of this group of writers, more remarkable for their collective significance than for their individual achievements, was derived from a drama by one of the most prolific of their number, M. F. von Klinger;¹ other members of the fraternity were J. A. Leisewitz² (1752-1806), M. R. Lenz³ and F. Müller⁴ the "painter." The youthful genius of the greatest of German poets was itself under the influences of this period, when it produced the first of its masterpieces. But Goethe's *Göts von Berlichingen* (1773), both by the choice and treatment of its national theme, and by the incomparable freshness and originality of its style, holds a position of its own in German dramatic literature. Though its defiant irregularity of form prevented its complete success upon the stage, yet its influence is far from being represented by the series of mostly feeble imitations to which it gave rise. The *Ritterdramen* (plays of chivalry) had their day like similar fashions in drama or romance; but the permanent effect of *Göts* was, that it crushed as with an iron hand the last remnants of theatrical conventionality (those of costume and scenery included), and extinguished with them the lingering respect for rules and traditions of dramatic composition which even Lessing had treated with consideration. Its highest significance, however, lies in its having been the first great dramatic work of a great national poet, and having definitively associated the national drama with the poetic glories of the national literature.

Thus, in the classical period of that literature, of which Goethe and Schiller were the ruling stars, the drama had a full share of the loftiest of its achievements. Of these, the dramatic works of Goethe vary so widely in form and character, and connect themselves so intimately with the different phases of the development of his own self-directed poetic genius, that it was impossible for any of them to become the starting-points of any general growths in the history of the German drama. His way of composition was, moreover, so peculiar to himself—conception often preceding execution by many years, part being added to part under the influence of new sentiments and ideas and views of art, flexibly followed by changes of form—that the history of his dramas cannot be severed from his general poetic and personal biography. His *Clavigo* and *Stella*, which succeeded *Göts*, are domestic dramas in prose; but neither by these, nor by the series of charming pastorals and operas which he composed for the Weimar court, could any influence be exercised upon the progress of the national drama. In the first conception of his *Faust*, he had indeed sought the suggestion of his theme partly in popular legend, partly in a domestic motive familiar to the authors of the *Sturm und Drang* (the story of Gretchen); the later additions to the First Part, and the Second Part generally, are the results of metaphysical and critical studies and meditations belonging to wholly different spheres of thought and experience. The dramatic unity of the whole is thus, at the most, external only; and the standard of judgment to be applied to this wondrous poem is not one of dramatic criticism. *Egmont*, originally designed as a companion to *Göts*, was not completed till many years later; there are few dramas more effective in parts, but the idea of a historic play is lost in the elaboration of the most graceful of love episodes. In *Iphigenia* and *Tasso*, Goethe exhibited the perfection of form of which his classical period had

enabled him to acquire the mastery; but the sphere of the action of the former (perfect though it is as a dramatic action), and the nature of that of the latter, are equally remote from the demands of the popular stage. Schiller's genius, unlike Goethe's, was naturally and consistently suited to the claims of the theatre. His juvenile works, *The Robbers*, *Fiesco*, *Kabale und Liebe*, vibrating under the influence of an age of social revolution, combined in their prose form the truthful expression of passion with a considerable admixture of extravagance. But, with true insight into the demands of his art, and with unequalled single-mindedness and self-devotion to it, Schiller gradually emancipated himself from his earlier style; and with his earliest tragedy in verse, *Don Carlos*, the first period of his dramatic authorship ends, and the promise of the second announces itself. The works which belong to this—from the *Wallenstein* trilogy to *Tell*—are the acknowledged masterpieces of the German poetic drama, treating historic themes reconstructed by conscious dramatic workmanship, and clothing their dialogue in a noble vestment of rhetorical verse. The plays of Schiller are the living embodiment of the theory of tragedy elaborated by Hegel, according to which its proper theme is the divine, or, in other words, the moving ethical, element in human action. In one of his later plays, *The Bride of Messina*, Schiller attempted a new use of the chorus of Greek tragedy; but the endeavour was a splendid error, and destined to exercise no lasting effect. The reaction against Schiller's ascendancy began with writers who could not reconcile themselves with the cosmopolitan and non-national elements in his genius, and is still represented by eminent critics; but the future must be left to settle the contention.

Schiller's later dramas had gradually conquered the stage, over which his juvenile works had in this time triumphantly passed, but on which his *Don Carlos* had met with a cold welcome. For a long time, however, its favourites were authors of a very different order, who suited themselves to the demands of a public tolerably indifferent to the literary progress of the drama. After popular tastes had oscillated between the imitators of *Göts* and those of *Emilia Galotti*, they entered into a more settled phase, as the establishment of standing theatres at the courts and in the large towns increased the demand for good "acting" plays. Famous actors, such as Schröder and A. W. Ifland, sought by translations or compositions of their own to meet the popular likings, which largely took the direction of that irrepressible favourite of theatrical audiences, the sentimental domestic drama.⁵ But the most successful purveyor of such wares was an author who, though not himself an actor, understood the theatre with a professional instinct—August von Kotzebue. His productivity ranged from the domestic drama and comedy of all kinds to attempts to rival Schiller and Shakespeare in verse; and though his popularity (which ultimately proved his doom) brought upon him the bitterest attacks of the romantic school and other literary authorities, his self-conceit is not astonishing, and the time has come for saying that there is some exaggeration in the contempt which has been lavished upon him by posterity.⁶ Nor should it be forgotten that German literature had so far failed to furnish the comic stage with any successors to *Minna von Barnhelm*; for Goethe's efforts to dramatize characteristic events or figures of the Revolutionary age⁷ must be dismissed as failures, not from a theatrical point of view only. The joint efforts of Goethe and Schiller for the Weimar stage, important in many respects for the history of the German drama, at the same time reveal the want of a national dramatic literature sufficient

¹ Ifland's best play is *Die Jäger* (1785), which recently still held the stage. From Mannheim he in 1796 passed to Berlin by desire of King Frederick William II., who thus atoned for the hardships which he had allowed the pietistic tyranny of his minister Wöllner to inflict upon the Prussian stage as a whole.

² *Die deutschen Kleinstädter* is his most celebrated comedy and *Menschenkass und Reus* one of the most successful of his sentimental dramas. According to one classification he wrote 163 plays with a moral tendency, 5 with an immoral, and 48 doubtful.

³ *Der Grossophobus* (Cagliostro); *Der Bürgergeneral*.

⁴ *Die Zwillinge* (The Twins); *Die Soldaten*, &c.

⁵ *Julius von Iarenz*.

⁶ *Der Hofmeister* (The Governor), &c.

⁷ *Genoève*, &c.

to supply the needs of a theatre endeavouring to satisfy the demands of art.

Meanwhile the so-called romantic school of German literature was likewise beginning to extend its labours to original dramatic composition. From the universality of sympathies proclaimed by this school, to whose leaders Germany owed its classical translation of Shakespeare,¹ and an introduction to the dramatic literatures of so many ages and nations,² a variety of new dramatic impulses might be expected; while much might be hoped for the future of the national drama (especially in its mixed and comic species) from the alliance between poetry and real life which they preached, and which some of them sought personally to exemplify. But in practice universality presented itself as peculiarity or even as eccentricity; and in the end the divorce between poetry and real life was announced as authoritatively as their union had been. Outside this school, the youthful talent of Th. Körner, whose early promise as a dramatist³ might perhaps have ripened into a fulness enabling him not unworthily to occupy the seat left vacant by his father's friend Schiller, was extinguished by a patriotic death. The efforts of M. von Collin (1779-1824) in the direction of the historical drama remained isolated attempts. But of the leaders of the romantic school, A. W.⁴ and F. von Schlegel⁵ contented themselves with frigid classicities; and L. Tieck, in the strange alembic of his *Phantasus*, melted legend and fairy-tale, novel and drama,⁶ poetry and satire, into a compound, enjoyable indeed, but hardly so in its entirety, or in many of its parts, to any but the literary mind.

F. de La Motte Fouqué infused a spirit of poetry into the chivalry drama. Klemens Brentano was a fantastic dramatist unsuited to the stage. Here a feeble outgrowth of the romanticists, the "destiny dramatists" Z. Werner⁷—the most original of the group—A. Müllerer,⁸ and Baron C. E. v. Houwald,⁹ achieved a temporary *suavore*; and it was with an attempt in the same direction¹⁰ that the Austrian dramatist F. Grillparzer began his long career. He is assuredly, what he pronounced himself to be, the foremost of the later dramatic poets of Germany, unless that tribute be thought due to the genius of H. von Kleist, who in his short life produced, besides other works, a romantic drama¹¹ and a rustic comedy¹² of genuine merit, and an historical tragedy of singular originality and power.¹³ Grillparzer's long series of plays includes poetic dramas on classical themes¹⁴ and historical subjects from Austrian history,¹⁵ or treated from an Austrian point of view. The romantic school, which through Tieck had satirized the drama of the *bourgeoisie* and its offshoots, was in its turn satirized by Count A. von Platen-Hallermund's admirable imitations of Aristophanic comedy.¹⁶ Among the objects of his banter were the popular playwright E. Raupach, and K. Immermann, a true poet, who is, however, less generally remembered as a dramatist. F. Hebbel¹⁷ is justly ranked high among the foremost later dramatic poets of his country, few of whom equal him in intensity. The eminent lyrical (especially ballad) poet L. Uhland left behind him a large number of dramatic fragments, but little or nothing really complete. Other names of literary mark are those of C. D. Grabbe, J. Mosen, O. Ludwig¹⁸ (1813-1865), a dramatist of great power, and "F. Halm"¹⁹ (Baron von Münch-Bellinghausen) (1806-1871), and among writers of a more

modern school, K. Gutzkow,²⁰ G. Freytag,²¹ and H. Laube.²² L. Anzengruber, a writer of real genius though restricted range, imparted a new significance to the Austrian popular drama,²³ formerly so commonplace in the hands of F. Raimund and J. Nestroy.

During the long period of transition which may be said to have ended with the establishment of the new German empire, the German stage in some measure anticipated the developments which more spacious times were to witness in the German drama. The traditions of the national theatre contemporary with the great epoch of the national literature were kept alive by a succession of eminent actors—such as the nephews of Ludwig Devrient, himself an artist of the greatest originality, whose most conspicuous success, though nature had fitted him for Shakespeare, was achieved in Schiller's earliest play.²⁴ Among the younger generation of Devrient's most striking personality was that of Emil; his elder brother Karl August, husband of Wilhelmine Schröder-Devrient, the brilliant star of the operatic stage, and their son Friedrich, were also popular actors; yet another brother, Eduard, is more widely remembered as the historian of the German stage. Partly by reason of the number and variety of its centres of intellectual and artistic life, Germany was long enabled both to cherish the few masterpieces of its own drama, and, with the aid of a language well adapted for translation, to give admittance to the dramatic masterpieces of other nations also, and to Shakespeare in particular, without going far in the search for theatrical novelty or effect. But a change came over the spirit of German theatrical management with the endeavours of H. Laube, from about the middle of the century onwards, at Vienna (and Leipzig), which avowedly placed the demands of the theatre as such above those of literary merit or even of national sentiment. In a less combative spirit, F. Dingelstedt, both at Munich, which under King Maximilian he had made a kindly nurse of German culture, and, after his efforts there had come to an untimely end,²⁵ at Weimar and at Vienna, raised the theatre to a very high level of artistic achievement. The most memorable event in the annals of his managements was the production on the Weimar stage of the series of Shakespeare's *histories*. At a rather later period, of which the height extended from 1874 to 1890, the company of actors in the service, and under the personal direction, of Duke George of Saxe-Meiningen, created a great effect by their performances both in and outside Germany—not so much by their artistic improvements in scenery and decoration, as by the extraordinary perfection of their *ensemble*. But no dramaturgic achievement in the century could compare in grandeur either of conception or of execution with Richard Wagner's Bayreuth performances, where, for the first time in the history of the modern stage, the artistic instinct ruled supreme in all the conditions of the work and its presentment. Though the *Ring of the Nibelungs* and its successors belong to opera rather than drama proper, the importance of their production (1876) should be overlooked by no student of the dramatic art. Potent as has been the influence of foreign dramatic literatures—whether French or Scandinavian—and that of a movement which has been common to them all, and from which the German was perhaps the least likely to exclude itself, the most notable feature in the recent history of the German drama has been its quick response to wholly new demands, which, though the attempt was made with some persistence, could no longer be met without an effort to span the widths and sound the depths of a more spacious and more self-conscious era.²⁶

The German stage of the latter half of the 19th century.

¹ A. W. von Schlegel and Tieck's (1797-1833).

² A. W. von Schlegel, *Lectures on Dramatic Art and Literature*, &c.

³ *Zriny*, &c. ⁴ *Ion*. ⁵ *Alarcos*.

⁶ *Kaiser Octavianus; Der gestiefelte Kater (Puss in Boots)*, &c.

⁷ *Der 24. Februar* (produced on the Weimar stage with Goethe's sanction).

⁸ *Der 29. Februar; Die Schuld (Guilt)*.

⁹ *Das Bild (The Picture); Der Leuchthurm (The Lighthouse)*.

¹⁰ *Die Anfrau (The Ancestress)*.

¹¹ *Das Käthchen (Kate) von Heilbronn*.

¹² *Der zerbrochene Krug (The Broken Pitcher)*.

¹³ *Prinz Friedrich von Homburg*. ¹⁴ *Sappho, Medea*, &c.

¹⁵ *König Ottokar's Glück und Ende (Fortune and Fall); Der Brudermord (Paternal Fend) in Habsburg*.

¹⁶ *Die verhängnisvolle Gabel (The Fatal Fork); Der romantische Oedipus*.

¹⁷ *Die Nibelungen; Judith*, &c.

¹⁸ *Der Erbforster*.

¹⁹ *Uriel Acosta; Der Königsleutenant*.

²⁰ *Die Valentine*. ²¹ *Die Karlsruhler*.

²² *Der Pfarrer von Kirchfeld; Der Meiseldauer; Die Kreuzschreiber; Das vierte Gebot*.

²³ *The Robbers (Franz Moor)*. His next most famous part was Lear.

²⁴ In connexion with the production in 1855 of "F. Halm's"

Fechler von Raecenna, of which the authorship was claimed by a half-demented schoolmaster.

²⁵ As to more recent developments of German theatrical literature see the article GERMAN LITERATURE, and the remarks on the influence of foreign works in the section on *Recent English Drama* above.

h. Dutch Drama.

Among other modern European dramas the Dutch is interesting both in its beginnings, which to all intents and purposes form part of those of the German, and because of the special influence of the so-called chambers of the *redrykers* (rhetoricians), from the early years of the 15th century onwards, which bear some resemblance to the associations of the master-singers in contemporary higher Germany. The earliest of their efforts, which so effectively tempered the despotism of both church and state, seem to have been of a dramatic kind; and a manifold variety of allegories, moralities and comic entertainments (*esbatementen* or comedies, *kluiten* and *factien* or farces) enhanced the attractions of those popular pageants in which the Netherlands surpassed all other countries of the North. The Low Countries responded more largely to the impulse of the Renaissance than, with some local exceptions, any other of the Germanic lands. They necessarily had a considerable share in the cultivation of the modern Latin drama; and, while the author of *Acolastus* may be claimed as its own by the country of its adoption as well as by that of his birth, G. M. Macropedius (Langhvelde) (c. 1475-1508), who may be regarded as the foremost Latin dramatist of his age, was born and died at Hertogenbosch or in its immediate vicinity. Macropedius, who belonged to the fraternity of the Common Life, was a writer of great realistic power as well as of remarkable literary versatility.¹ The art of acting flourished in the Low Countries even during the troubles of the great revolt; but the birth of the regular drama was delayed till the advent of quieter times. Dutch dramatic literature begins, under the influence of the classical studies cherished in the seats of learning founded before and after the close of the war, with the classical tragedies of S. Koster (c. 1585-c. 1650). The romantic dramas and farces of Gerbrand Bredero (1585-1618) and the tragedies of P. Hooft (1581-1647) belong to the same period; but its foremost dramatic poet was J. van den Vondel, who from an imitation of classical models passed to more original forms of dramatic composition, including a patriotic play and a dramatic treatment of part of what was to form the theme of *Paradise Lost*.² But Vondel had no successor of equal mark. The older form of Dutch tragedy—in which the chorus still appeared—was, especially under the influence of the critic A. Pels, exchanged for a close imitation of the French models, Corneille and Racine; nor was the attempt to create a national comedy successful. Thus no national Dutch drama was permanently called into life.

i. Scandinavian Drama.

Still more distinctly, the dramatic literature of the Scandinavian peoples springs from foreign growths. In Denmark, where the beginnings of the drama in the plays of the schoolmaster Chr. Hansen recall the mixture of religious and farcical elements in contemporary German efforts, the drama in the latter half of the 16th century remained essentially scholastic, and treated scriptural or classical subjects, chiefly in the Latin tongue. J. Ranch (1539-1607) and H. S. Sthen were authors of this type. But often in the course of the 17th century, German and French had become the tongues of Danish literature and of the Danish theatre; in the 18th Denmark could boast a comic dramatist of thorough originality and of a wholly national cast. L. Holberg, one of the most noteworthy comic poets of modern literature, not only marks an epoch in the dramatic literature of his native land, but he contributed to overthrow the trivialities of the German stage in its worst period, which he satirized with merciless humour,³ and set an example, never surpassed, of a series of comedies⁴ deriving their types from popular life and ridiculing with healthy directness those vices and follies which are the proper theme of the most widely effective species of the comic drama. Among

his followers, P. A. Heiberg is specially noted. Under the influence of the Romantic school, whose influence has nowhere proved so long-lived as in the Scandinavian north, A. Ohlenschläger began a new era of Danish literature. His productivity, which belongs partly to his native and partly to German literary history, turned from foreign⁵ to native themes; and other writers followed him in his endeavours to revive the figures of Northern heroic legend. But these themes have in their turn given way in the Scandinavian theatre to subjects coming nearer home to the popular consciousness, and treated with a direct appeal to the common experience of human life, and with a searching insight into the actual motives of human action. The most remarkable movement to be noted in the history of the Scandinavian drama, and one of the most widely effective of those which mark the more recent history of the Western drama in general, had its origin in Norway. Two Norwegian dramatists, H. Ibsen and Bjørnsterne Björnson, standing as it were side by side, though by no means always judging eye to eye, have vitally influenced the whole course of modern dramatic literature in the direction of a fearlessly candid and close delineation of human nature. The lesser of the pair in inventive genius, and in the power of exhibiting with scornful defiance the conflict between soul and circumstance, but the stronger by virtue of the conviction of hope which lies at the root of achievement, is Björnson.⁶ Ibsen's long career as a dramatist exhibits a succession of many changes, but at no point any failure in the self-trust of his genius. His early masterpieces were dramatic only in form.⁷ His world-drama of *Emperor and Galilean* was still unsuited to a stage rarely trodden to much purpose by idealists of Julian's type. The beginnings of his real and revolutionary significance as a dramatist date from the production of his first plays of contemporary life, the admirable satirical comedy *The Pillars of Society* (1877), the subtle domestic drama *A Doll's House* (1879), and the powerful but repellent *Ghosts* (1881),⁸ which last, with the effects of its appearance, modern dramatic literature may even to this day be said to have failed altogether to assimilate. Ibsen's later prose comedies—(verse, he writes, has immensely damaged the art of acting, and a tragedy in iambics belongs to the species Dodo)—for the most part written during an exile which accounts for the note of isolation so audible in many of them, succeeded one another at regular biennial intervals, growing more and more abrupt in form, cruel in method, and intense in elemental dramatic force. The prophet at last spoke to a listening world, but without the amplitude, the grace and the whole-heartedness which are necessary for subduing it. But it may be long before the art which he had chosen as the vehicle of his comments on human life and society altogether ceases to show the impress of his genius.

j. Drama of the Slav Peoples.

As to the history of the Slav drama, only a few hints can be here given. Its origins have not yet—at least in works accessible to Western students—been authoritatively traced. The Russian drama in its earliest or religious beginnings is stated to have been introduced from Poland early in the 12th century; and, again, it would seem that, when the influence of the Renaissance touched the east of Europe, the religious drama was cultivated in Poland in the 16th, but did not find its way into Russia till the 17th century. It is probable that the species was, like so many other elements of culture, imported into the Carpathian lands in the 15th or 16th century from Germany. How far indigenous growths, such as the Russian popular puppet-show called *vertep*, which about the middle of the 17th century began to treat secular and popular themes, helped to foster dramatic tendencies and tastes, cannot here be estimated. The regular drama of eastern Europe is to all intents and purposes of Western origin. Thus, the history of the Polish drama may be fairly

¹ *Aluta; Acolus; Hecastus, &c.*² *Gysbrecht van Aemstel; Lucifer.*³ *Ulysses of Ithaca.*⁴ *The Politician-Tinman; Jean de France or Hans Fransens; The Lying-In, &c.*⁵ *Aladdin; Corregio.*⁶ *Maria Stuart; A Bankruptcy; Leonarda.*⁷ *Brand; Peer Gynn.*⁸ *Samfundets Støttere; Et Dukkehjem; Gengangere.*

dated as beginning with the reign of the last king of Poland, Stanislaus II. Augustus, who in 1765 solemnly opened a national theatre at Warsaw. This institution was carried on till the fatal year 1794, and saw the production of a considerable number of Polish plays, mostly translated or adapted, but in part original—as in the case of one or two of those from the active pen of the secretary to the educational commission, Zabłonski. But it was not till after the last partition that, paradoxically though not wholly out of accordance with the history of the relations between political and literary history, the attempts of W. Bogulawski and J. N. Kaminski to establish and carry on a Polish national theatre were crowned with success. Its literary mainstay was a gifted Franco-Pole, Count Alexander Fredro (1793–1876), who in the period between the Napoleonic revival and the long exodus fathered a long-lived species of modern Polish comedy, French in origin (for Fredro was a true disciple of Molière), and wholly out of contact with the sentiment that survived in the ashes of a doomed nation.¹ His complaint as to the exiguity of the Polish literary public—a brace of theatres and a bookseller's handcart—may have been premature; but a national drama was most certainly impossible in a denationalized and dismembered land, in whose historic capital the theatre in which Polish plays continued to be produced seemed garrisoned by Cossack officers.

Much in the same way, though with a characteristic difference, the Russian regular drama had its origin in the cadet corps at St Petersburg, a pupil of which, A. Sumarokov (1718–1777), has been regarded as the founder of the modern Russian theatre. As a tragic poet he seems to have imitated Racine and Voltaire, though treating themes from the national history, among others the famous dramatic subject of the False Demetrius. He also translated *Hamlet*. As a comic dramatist he is stated to have been less popular than as a tragedian; yet it is in comedy that he would seem to have had the most noteworthy successors. Among these it is impossible to pass by the empress Catherine II., whose comedies seem to have been satirical sketches of the follies and foibles of her subjects, and who in one comedy as well as in a tragedy had the courage to imitate Shakespeare. Comedy aiming at social satire long continued to temper the conditions of Russian society, and had representatives of mark in such writers as A. N. Ostrovsky of Moscow and Griboyedov, the author of *Gore et uma*.

In any survey of the Slav drama that of the Czech peoples, whose national consciousness has so fully reawakened, must not be overlooked. A Czech theatre was called into life at Prague as early as the 18th century; and in the 19th its demands, centring in a sense of nationality, were met by J. N. Stepanek (1783–1844), W. C. Klicpera (1792–1859) and J. C. Tyl (1808–1856); and later writers continued to make use of the stage for a propaganda of historical as well as political significance.

BIBLIOGRAPHY.—The following works treat the general theory of the drama and the dramatic art, together with the principles of dramaturgy and of the art of acting. Works which have reference to the drama of a particular period or of a particular nation only are mentioned separately. Works which deal with special authors only have been intentionally omitted in this bibliography, as being mentioned in the articles in the several authors.

Aristotle's *Poetics* (text and transl. by S. H. Butcher, London, 1895; transl. by T. Twining, London, 1812; see also Donaldson's *Theatre of the Greeks*); H. Baumgart, *Aristoteles, Lessing, u. Goethe. Über das ästhetische u. ästhetische Princip der Tragödie* (Leipzig, 1877); H. A. Bultaupt, *Dramaturgie des Schauspiels* (4 vols., Oldenburg u. Leipzig, 1893–1902); L. Campbell, *Tragic Drama in Aeschylus, Sophocles and Shakespeare* (London, 1904); P. Corneille, *Discours du poëme dramatique—de la tragédie—des trois unités, Œuvres*, vol. i. (Paris, 1862); W. L. Courtney, *The Idea of Tragedy in Ancient and Modern Drama* (Westminster, 1900); Diderot, *De la poésie dramatique. Entrétiens sur le Fils Naturel, Œuvres complètes*, vii. (Paris, 1875); J. Dryden, *Essay of Dramatic Poesy and other critical essays* (*Essays of J. Dryden*, ed. W. P. Ker, 2 vols., Oxford, 1900); G. Freytag, *Die Technik des Dramas* (5th ed., Leipzig, 1886); G. W. F. Hegel, *Vorlesungen über Ästhetik*, ed. H. G. Hotho, bd. 3, chap. iiii. c. *Die dramatische Poesie* (Werke, x. 3; Berlin, 1838); G. Larroumet, *Études d'histoire et de critique dramatiques*, 2 sér. (Paris, 1892–1899); G. E. Lessing, *Hamburgische Dramaturgie.*

Erläutert von F. Schröter u. R. Thiele (Halle, 1877); *Materialien zu Lessing's Hamburgische Dramaturgie*, von W. Cosack (Paderborn, 1876); G. H. Lewes, *On Actors and the Art of Acting* (London, 1875); Sir T. Martin, *Essays on the Drama* (London, 1874); K. Mantzius, *History of Theatrical Art in Ancient and Modern Times*, transl. by L. von Cossel (London, 1903, &c.); G. Meredith, *Essay on Comedy* (Westminster, 1897); R. Pröls, *Katechismus der Dramaturgie* (Leipzig, 1877); H. T. Rotscher, *Die Kunst der dramatischen Darstellung* (3 vols., Berlin, 1841–1846); *Jahrbücher für dramatische Kunst u. Literatur*, (Berlin and Frankfurt, 1846–1849); P. de Saint-Victor, *Les Deux Mages, tragédie—comédie* (3rd ed., 3 vols., Paris, 1881, &c.); Saint-Marc Girardin, *Cours de littérature dramatique* (7th ed., 5 vols., Paris, 1868); A. W. von Schlegel, *Lectures on Dramatic Art and Literature* (Eng. transl., London, 1845); Sir W. Scott, *Essays on Chivalry, Romance and the Drama* (including his article "Drama" written for the Supplement to the 4th edition of the *Ency. Brit.*, and reprinted in the 5th, 6th, 7th and 8th editions); F. T. Vischer, *Ästhetik*, vol. iv. (Stuttgart, 1857).

The fullest general history of the drama extant is J. L. Klein's *Geschichte des Dramas*, 13 vols. and index (Leipzig, 1865–1886). See also, for encyclopaedic information, W. Davenport Adams, *A Dictionary of the Drama*, vol. i. (London, 1904); C. M. E. Bèquet, *Encyclopédie de l'art dramatique* (Paris, 1886); A. Pougin, *Dictionnaire historique et pittoresque du théâtre et des arts qui s'y rattachent* (Paris, 1885).

The drama of the Eastern nations is generally treated in—A. P. Brozzi, *Teatri e spettacoli dei popoli orientali Ebrei, Arabi, Persiani, Indiani, Cinesi, Giapponesi e Giapponesi* (Milan, 1887); Comte J. A. de Gobineau, *Les Religions et les philosophies dans l'Asie centrale* (2nd ed., Paris, 1866).

The following works deal with the Indian drama:—M. Schuyter, *Bibliography of the Sanskrit Drama* (Columbia Univ., Indo-Iranian, ser. iii., New York, 1906); H. H. Wilson, *Select Specimens of the Theatre of the Hindus*, transl. from the original Sanskrit (with introduction on the dramatic system of the Hindus), 3rd ed., 2 vols. (London, 1871); S. Levi, *Le Théâtre indien* (supplements Wilson) (Paris, 1891).

For Chinese:—Tscheng-Ki-Tong, *Le Théâtre des Chinois* (Paris, 1886); see also H. A. Giles, *History of Chinese Literature* (London, 1901).

For Japanese:—C. Florenz, *Gesch. d. japan. Litteratur*, vol. i. j (Leipzig, 1905); see also F. Brinkley, *Japan, its History, Arts and Literature*, vol. iii. (Boston and Tokyo, 1901).

For Persian:—A. Chodzko, *Théâtre persan. Choix de basis on drames, traduits pour la première fois du persan par A. Chodzko* (Paris, 1878); E. Montet, *Le Théâtre en Perse* (Geneva, 1888); Sir L. Pelley, *The Miracle Play of Hasan and Husain, collected from oral tradition; revised with explanatory notes by A. N. Wollaston* (2 vols., London, 1879).

Of works treating of the ancient Greek and Roman drama only a small selection can be given here. In the case of the Greek drama, the chief histories of literature—such as G. Bernhardy's, K. O. Müller's (Eng. tr. by Sir G. C. Lewis, with continuation by J. W. Donaldson) and G. Murray's—and general histories—such as Grote's, Thirlwall's, Curtius's, &c.—should also be consulted; and for the administration and finance of the Attic theatre, Boeckh's *Public Economy of Athens*, Eng. tr. (London, 1842). Much useful information will be found in *A Companion to Greek Studies*, ed. by L. Whibley (Cambridge, 1905). The standard collective edition of the ancient Greek dramatic poets is the *Poetae scenici Graeci*, ed. C. W. Dindorf (5th ed., Leipzig, 1869), and that of the Comic poets A. Meineke's *Historia critica comicorum Graecorum. Cum fragmentis* (5 vols., Berlin, 1839–1857). Aristotle's *Poetics*, cited above, will of course be consulted for the theory of the Greek drama in particular; and much valuable critical matter will be found in passages of Bentley's *Phalaris* (1699), which are reprinted in Donaldson's *Theatre of the Greeks*. The following later works, some of which treat of the ancient classical drama in general, may be noted:—E. A. Chaignet, *La Tragédie grecque* (Paris, 1877); J. Denys, *Histoire de la comédie grecque* (2 vols., Paris, 1886); W. Donaldson, *The Theatre of the Greeks* (7th ed., London, 1860); Du Ménil, *Histoire de la comédie. Période primitive* (Paris, 1864); *Histoire de la comédie ancienne* (Paris, 1869); A. E. Haigh, *The Tragic Drama of the Greeks* (Oxford, 1896); *The Attic Theatre* (Oxford, 1898); G. Körting, *Gesch. des Theaters in seinen Beziehungen zur Kunstentwicklung der dramatischen Dichtkunst*, Bd. i. *Gesch. des griechischen u. römischen Theaters* (Paderborn, 1897); R. G. Moulton, *The Ancient Classical Drama* (Oxford, 1898); M. Patin, *Étude sur les tragiques grecs* (3 vols., Paris, 1861); C. M. Rapp, *Gesch. des griechischen Schauspiels vom Standpunkt der dramatischen Kunst* (Tübingen, 1862); H. Weil, *Études sur le drame antique* (Paris, 1897); F. G. Welcker, "Die griechischen Tragödien, mit Rücksicht auf den epischen Cyklus" (*Rhein. Mus. Suppl.* ii.) 3 pts. (Bonn, 1839–1841).

In addition to the works of individual Roman dramatists, and the critical writings concerning them, see *Scenaeica Romanorum poësis fragmenta*, 2 vols. (I. Tragic, II. Comic) ed. by O. Ribbeck (3rd ed., Leipzig, 1897–1898). W. S. Teuffel's *History of Roman Literature*, Eng. tr. (2 vols., London, 1891–1892), and M. Schanz' *Gesch. der römischen Literatur bis Justinian* (2 vols., Munich, 1890–1892), may be consulted for a complete view of the course of the Roman drama. For its later developments consult Dean Merivale's *History of the*

¹ Pan Jowialski; *Oludki i Poeta* (*The Misanthrope and the Poet*).

Romans under the Empire, and S. Dill's *Roman Society in the Last Days of the Western Empire* (London, 1898). See also L. Friedländer, *Darstellungen aus der Sittengeschichte Roms*, 6th ed., vol. ii. (Leipzig, 1899); M. Meyer, *Étude sur le théâtre latin* (Paris, 1847); O. Ribbeck, *Die römische Tragödie im Zeitalter der Republik* (Leipzig, 1875).

The following works treat of the medieval drama, religious or secular, of its origins and of usages connected with it—H. Anz, *Die lateinischen Magierspiele* (Leipzig, 1905); E. K. Chambers, *The Medieval Stage* (2 vols., Oxford, 1903), with full bibliography; E. de Coussemaker, *Dramas liturgiques du moyen âge* (Paris, 1861); de Méril, *Théâtre liturgique quae Latina supersunt monumenta* (Caen and Paris, 1849); C. A. Hase, *Miracle Plays and Sacred Dramas* (Engl. tr.) (London, 1880); Hilarius, *Versus et Iudi*, ed. Champollion-Figeac (Paris, 1838); R. Froning, *Das Drama des Mittelalters* (3 vols., Stuttgart, 1891, &c.); Edwin Norris, *Ancient Cornish Drama* (ed. and tr. 2 vols., 1859); W. Home, *Ancient Mysteries Described* (London, 1823); A. von Keller, *Fasnachtsstücke aus dem 15. Jahrhundert* (Stuttgart, 1858); C. Magnin, *Les Origines du théâtre moderne*, vol. i. only (Paris, 1838); F. J. Mone, *Schauspiele des Mittelalters* (2 vols., Karlsruhe, 1846); A. Reiners, *Die Tropen-, Prosen- u. Präfatons-Gesänge* (Luxemburg, 1884); J. de Rothschild, *Le Mystère du Viel Testament*, ed. J. de Rothschild (6 vols., Paris, 1878-1891); M. Sepet, *Le Drama chrétien au moyen âge* (Paris, 1878); *Origines catholiques du théâtre moderne. Les drames liturgiques* (Paris, 1901); T. Wright, *Early Mysteries and other Latin Poems of the 12th and 13th Centuries* (London, 1838); C. A. G. von Zeschwitz, *Das mittelalterliche Drama* (Leipzig, 1881).

For French medieval drama in particular—L. Clédat, *Le Théâtre en France au moyen âge* (Paris, 1896); E. Fournier, *Le Théâtre français avant la Renaissance* (Paris, 1872); *Miracles de Notre Dame par personnages*, ed. G. Paris and U. Robert (8 vols., Paris, 1876-1893); L. J. N. Monmerqué and F. Michel, *Théâtre français au moyen âge* (Paris, 1830); L. Petit de Julleville, *Histoire du théâtre en France au moyen âge* (5 vols., Paris, 1880-1886); E. L. N. Viollet-le-Duc, *Ancien Théâtre français* (10 vols., Paris, 1854-1857).

For the medieval Italian in particular—A. d'Ancona, *Sacre rappresentazioni dei secoli XIV., XV. e XVI.* (Florence, 1872).

For medieval English in particular—Ahn, *English Mysteries and Miracle Plays* (Trèves, 1867); S. W. Clarke, *The Miracle Play in England* (London, 1897); F. W. Fairholt, *Lord Mayors' Pageants*, 2 vols. (Percy Soc.) (London, 1843-1844); A. W. Pollard, *English Miracle Plays, Moralties and Interludes* (3rd ed., Oxford, 1893); *Chester Plays*, ed. T. Wright, 2 vols. (Shakespeare Soc.) (London, 1843), re-ed. by H. Deimling (part only) (E. E. T. S.) (London, 1893); *Coventry Play Ludus Coventriae*, ed. J. O. Halliwell (Phillips) (Shakespeare Soc.) (London, 1841); *Coventry Plays. Dissertation on the pagans or mysteries at Coventry*, by T. Sharp (Coventry, 1825); *Digby Plays*, ed. F. J. Furnival (E. E. T. S.) (London, 1896); *Towneley Mysteries*, ed. G. England and A. W. Pollard (E. E. T. S.) (London, 1897); *York Plays*, ed. L. T. Smith (Oxford, 1885).

For the German in particular—F. J. Mone, *Altteutsche Schauspiele* (Quedlinburg, 1841); H. Reidt, *Das geistliche Schauspiel des Mittelalters in Deutschland* (Frankfurt, 1868); E. Wilken, *Gesch. der geistlichen Spiele in Deutschland* (Cöttingen, 1872).

The revival of the classical drama in the Renaissance age is treated in P. Bahlmann's *Die Erneuerer des antiken Dramas und ihre ersten dramatischen Versuche, 1314-1478* (Münster, 1896); A. Chassignat's *Des essais dramatiques imités de l'antiquité au XIV^e et XV^e siècle* (Paris, 1852), and in V. de Amitus' *L'Imitatione latina nella commedia del XVI secolo* (Pisa, 1871).

Both the medieval and portions of the later drama are treated in W. Cloetta, *Beiträge zur Literaturgeschichte des Mittelalters und der Renaissance* (2 vols., Halle, 1890-1892); W. Creizenach, *Geschichte des neueren Dramas*, vol. i.-iii. (Halle, 1893-1903); R. Pröls, *Geschichte des neueren Dramas* (3 vols., Leipzig, 1881-1883). See also L.-V. Goffiot, *Le Théâtre au collège, du moyen âge à nos jours*, Préface par Jules Claretie (Paris, 1907).

The history of the modern Italian drama, in its various stages, is treated by A. d'Ancona, *Origini del teatro italiano* (2nd ed., 2 vols., Turin, 1891); J. Formis, *Le Théâtre italien contemporains* (Paris, 1904); H. Lyonnet, *Le Théâtre en Italie* (Paris, 1900); L. Roccombi, *Histoire du théâtre italien* (2 vols., Rome, 1728-1731); J. C. Walker, *Historical Memoir on Italian Tragedy* (London, 1799). See also A. Gaspari, *History of Early Italian Literature*, transl. by H. Oelsner (London, 1901).

Some information as to the modern Greek drama is given in R. Nicolai, *Geschichte der neugriechischen Literatur* (Leipzig, 1876).

Modern Spanish drama—M. A. Fée, *Études sur l'ancien théâtre espagnol* (Paris, 1873); A. Gassier, *Le Théâtre espagnol* (Paris, 1898); G. H. Lewes, *The Spanish Drama* (London, 1846); H. Lyonnet, *Le Théâtre en Espagne* (Paris, 1897); A. Schaffer, *Gesch. des spanischen Nationaldramas* (2 vols., Leipzig, 1890); L. de Viel-Castel, *Essai sur le théâtre espagnol* (2 vols., Paris, 1882). See also A. Ticknor, *History of Spanish Literature* (3 vols., London, 1863).

Modern Portuguese—H. Lyonnet, *Le Théâtre au Portugal* (Paris, 1898); see also K. von Reinhardtsoetner's *Portugiesische Literaturgeschichte* (Sammlung Goschen) (Leipzig, 1904), which contains a useful bibliography.

Regular French drama (tragedy and comedy)—F. Brunetière, *Les Époques du théâtre français, 1630-1850* (Paris, 1892); E. Chasles,

La Comédie en France au XVI^e siècle (Paris, 1862); E. Faguet, *La Tragédie française au XVI^e siècle* (Paris, 1883); A. Filon, *Le Modern French Drama* (London, 1898); V. Fournel, *Le Théâtre au XVII^e siècle* (Paris, 1892); E. Fournier, *Le Théâtre français au XVI^e et au XVII^e siècle* (2 vols., Paris, s.d.); F. Hawkins, *Annals of the French Stage* (London, 1884); H. Lucas, *Hist. philosophique et littéraire du théâtre français depuis son origine* (3 vols., Paris), Parfait, *Hist. du théâtre français* (15 vols., Paris, 1745-1749); L. Petit de Julleville, *Le théâtre en France depuis ses origines jusqu'à nos jours* (Paris, 1899); E. Rigal, *Le théâtre français avant la période classique* (Paris, 1901); E. Roy, *Études sur le théâtre français du XV^e et du XVI^e siècle* (Dijon, 1901).

The connexion between the Italian and French theatre in the 17th century is traced in L. Moland, *Molière et la comédie italienne* (2nd ed., Paris, 1867). See also J. C. Démogot's, H. von Laun's and Sainsbury's histories of French Literature.

Of the ample literature concerned with the modern English drama the following works may be specially mentioned, as dealing with the entire range of the English drama, or with more than one of its periods—D. E. Baker, *Biographia Dramatica* (continued to 1811 by J. Reed and S. Jones) (3 vols., London, 1812); J. P. Collier, *History of English Dramatic Poetry*, new ed. (3 vols., London, 1879); C. Dibdin, *A complete History of the English Stage* (5 vols., London, 1800); J. J. Jusserand, *Le Théâtre en Angleterre* (2nd ed., Paris, 1881); G. Langbaine, *Lines and Characters of the English Dramatic Poets* (London, 1699); *The Poetical Register, or lives and characters of the English dramatic poets* (London, 1719); C. M. Rapp, *Studien über das englische Theater*, 2 parts (Tübingen, 1862); "G. S. B." *Study of the Prologue and Epilogue in English Literature* (London, 1884); *The Thespian Dictionary; or dramatic biography of the 18th century* (London, 1820); A. W. Ward, *History of English Dramatic Literature to the Death of Queen Anne* (2nd ed., 3 vols., London, 1899); see also the histories of English Literature or Poetry, by Warton, Taine, ten Brinck, Courthouse, Sainsbury, &c.

The following works contain the most complete lists of English plays—W. W. Greg, *A List of English Plays written before 1643 and published before 1700* (Bibliogr. Soc.) (London, 1900); J. O. Halliwell (Phillips), *Dictionary of Old English Plays* (London, 1860); W. C. Hazlitt, *A Manual for the Collector and Amateur of Old English Plays* (London, 1892); R. W. Lowe, *Bibliographical Account of English Dramatic Literature* (London, 1888) is a valuable handbook for the whole of English theatrical literature and matters connected with it. The unique work of Genes, *Some Account of the English Stage from 1660-1830* (10 vols., Bath, 1832), includes, with a chronological series of plays acted on the English stage, notices of unacted plays, and critical remarks on plays and actors. "A Complete List" of English dramatic poets and plays to 1747 was published with T. Whincom's *Scanderbeg* in that year.

The following are the principal collections of English plays—*Ancient British Drama*, ed. Sir W. Scott (3 vols., London, 1810); *Modern British Drama*, ed. Sir W. Scott (5 vols., London, 1811); W. Bang, *Materialien zur Kunde des älteren englischen Dramas* (Louvain, 1902, &c.); A. H. Bullen, *Collection of Old English Plays* (4 vols., London, 1882); R. Dodsley, *A Select Collection of Old Plays*, 4th ed. by W. C. Hazlitt (15 vols., London, 1874-1876); *Dramatists of the Restoration* (14 vols., Edinburgh, 1872-1879); *Early English Dramatists*, ed. J. S. Farmer (London, 1905, &c.); C. M. Gayley, *Representative English Comedies* (vol. i., New York, 1903); T. Hawkins, *Origin of the English Drama* (3 vols., Oxford, 1773); Mrs Inghald, *British Theatre*, new ed. (20 vols., London, 1824); *Modern Theatre* (10 vols., London, 1811); *Collection of Farces and Afterpieces* (7 vols., London, 1815); Malone Society publications (London, 1907, &c.); J. M. Manly, *Specimens of the Pre-Shakespearean Drama* (3 vols., London, 1897); *Mermaid Series of Old Dramatists*, ed. Havoclock Ellis (London, 1887, &c.); *Old English Drama* (2 vols., London, 1825); *Pearson's Reprints of Elizabethan and Jacobean Plays* (London, 1871, &c.).

The following deal with the Elizabethan and Jacobean drama in especial—W. Creizenach, *Die Schauspiele der englischen Komödianten* (Berlin, 1895); J. W. Cunliffe, *The Influence of Seneca on Elizabethan Tragedy* (London, 1893); F. G. Fleay, *A Chronicle History of the London Stage, 1559-1642* (London, 1890); A. Biographical Chronicle of the English Drama, 1559-1642 (London, 1891); W. C. Hazlitt, *The English Drama and Stage under the Tudor and Stuart Princes, 1543-1664* (London, 1860); W. Hazlitt, *Dramatic Literature of the Age of Elizabeth* (Works, ed. A. R. Waller vol. v.) (London, 1902); A. F. von Schack, *Die englischen Dramatiker vor, neben, und nach Shakespeare* (Stuttgart, 1893); J. A. Symonds, *Shakespeare's Predecessors in the English Drama* (London, 1884).

As to the Latin academical drama of the Elizabethan age see G. B. Churchill and W. Keller, "Die latein. Universitäts-Dramen Englands in der Zeit d. Königin Elizabeth" in *Jahrbuch der deutschen Shakespeare-Gesellschaft*. For a short bibliography of the Oxford academical drama, 1547-1663, see the introduction to Miss M. L. Lee's edition of *Narcissus* (London, 1893). A list of Oxford plays will also be found in *Notes and Queries*, ser. vii., vol. ii. For a list of Cambridge plays from 1534 to 1671, the writer of this article is indebted to Prof. G. C. Moore-Smith of the university of Sheffield.

For an account of the Mask see R. Brotanek, *Die englischen Maskenspiele* (Vienna and Leipzig, 1902); H. A. Evans, *English Mask-*

(London, 1897); W. W. Greg, *A List of Masques, Pageants, &c.* (Bibliogr. Soc.) (London, 1902).

As to early London theatres see T. F. Ordis, *Early London Theatres* (London, 1894).

Some information as to puppet-plays, &c., will be found in Henry Morley's *Memoirs of Bartholomew Fair* (London, 1859).

Among earlier critical essays on the Elizabethan and Stuart drama should be mentioned those of Sir Philip Sidney, G. Puttenham and W. Webbe, T. Rymer and Dryden. For recent essays and notes on the Elizabethan drama in general see, besides the essays of Coleridge, Lamb (including the introductory remarks in the *Specimens*), Hazlitt, &c., and the remarkable series of articles in the *Retrospective Review* (1820-1828), the Publications and Transactions of the Old and New Shakespeare Societies (1841, &c., 1874, &c.), which also contain reprints of early works of great importance for the history of the Elizabethan drama and stage, such as Henslowe's *Diary*, &c., and the *Jahrbuch der deutschen Shakespeare-Gesellschaft* (1865, &c.), as well as the German journals *Anglia*, *Englische Studien*, &c., and the *Modern Language Review* (Cambridge).

The later English drama from the reopening of the theatres (1660) is treated in L. N. Chase, *The English Heroic Play* (New York, 1903); C. Cibber, *Apology for the Life of C. Cibber*, written by himself, new ed. by R. W. Lowe (2 vols., London, 1889), who has also edited Churchill's *Rosciad* and *Apology* (London, 1891); J. Doran, *Their Majesties' Servants: annals of the English Stage* (3 vols., London, 1888); A. Filon, *Le Théâtre anglais: hier, aujourd'hui, demain* (Paris, 1896); W. Hazlitt, *A View of the English Stage* (Works, ed. A. R. Waller, vol. viii.) (London, 1903); W. Nicholson, *The Struggle for a Free Stage in London* (Westminster, 1907).

The following treat of the modern German drama in particular periods:—R. Pröls, *Gesch. der deutschen Schauspielkunst von den Anfängen bis 1850* (Leipzig, 1900); R. E. Prutz, *Vorlesungen über die Geschichte des deutschen Theaters* (Berlin, 1847); R. Froning, *Das Drama der Reformationszeit* (Stuttgart, 1900); C. Heine, *Das Schauspiel der deutschen Wanderbühnen vor Götsche* (Halle, 1889); J. Minor, *Die Schicksalsstragödie in ihren Hauptvertretern* (Frankfurt, 1883); M. Martersteig, *Das deutsche Theater im XIX. u. XX. Jahrhundert* (1904). See also G. G. Gervinus, *Geschichte der deutschen Dichtung* (5th ed., 5 vols., Leipzig, 1871-1874); and the literary histories of K. Goedeke (*Grundriss*), A. Koberstein, &c. A special aspect of the drama in modern Germany is dealt with in P. Bahlmann, *Die lateinischen Dramen von Wimpfeling's Sylphio bis zur Mülle des XVI. Jahrhunderts, 1480-1550* (Münster, 1893), and the same author's *Jesuiten-Dramen der niedererheinischen Ordensprovinz* (Leipzig, 1896).

The standard history of the modern German stage is Eduard Devrient, *Gesch. der deutschen Schauspielkunst* (2 vols., Leipzig, 1848-1861); see also R. Pröls, *Gesch. der deutschen Schauspielkunst von den Anfängen bis 1850* (Leipzig, 1900); O. G. Flügel, *Biographisches Bühnen-Lexikon der deutschen Theater* (Munich, 1892).

A good account of the history of the Dutch drama is F. von Hellwald's *Geschichte des holländischen Theaters* (Rotterdam, 1874). See also the authorities under J. van den Vondel.

Information concerning the Danish drama will be found in the autobiographies of Holberg, Ohlenschläger and Andersen; see also vol. i. of G. Branden's *Main Currents in Nineteenth Century Literature* (Eng. tr., London, 1901). As to the modern Norwegian drama see the same writer's *Ibsen-Bjørnson Studies* (Eng. tr., London, 1899), also E. Tissot, *Le Dramme norvégien* (Paris, 1893).

The Russian drama is treated in P. O. Morozov's *Istoria Russkogo Teatra* (*History of the Russian Theatre*), vol. i. (St Petersburg, 1889); see also P. de Corvin, *Le Théâtre en Russie* (Paris, 1890). A Brückner, *Geschichte der russischen Literatur* (Leipzig, 1905), may be consulted with advantage. Information as to the dramatic portions of other Slav literatures will be found in A. Pipin and V. Spasovich's *Istoria Slavianstikh Literatur* (*History of Slavonic Literatures*), German translation by T. Pech (2 vols., Leipzig, 1880-1884). (A. W. W.)

DRAMBURG, a town of Germany in the kingdom of Prussia, on the Drage, a tributary of the Oder, 50 m. E. of Stettin, on the railway Ruhnow-Neustettin. Pop. 5800. It contains an Evangelical church, a gymnasium, a hospital and various administrative offices, and carries on cotton and woollen weaving, tanning, brewing and distilling.

DRAMMEN, a seaport of Norway, in Buskerud and Jarlsberg-Laurvik amt (counties), at the head of Drammen Fjord, a western arm of Christiania Fjord, 33 m. by rail S.W. from Christiania. Pop. (1900) 23,093. Its situation, at the mouth of the broad Drammen river, between lofty hills, is very beautiful. It is the junction of railways from Christiania to Haugsund, Kongsberg and Hønefoss, and to Laurvik and Skien. The town is modern, having suffered from fires in 1866, 1870 and 1880. It consists of three parts: Bragernes on the north, divided by the river from Strømsø and the port, Tangen, on the south. The prosperity of Drammen depends mainly on the timber trade; and saw-milling is an active industry, the logs being

floated down the river from the upland forests. Timber and wood-pulp are exported (over half of each to Great Britain), with paper, ice and some cobalt and nickel ore. The chief imports are British coal and German machinery. Salmon are taken in the upper reaches of the Drammen.

DRANE, AUGUSTA THEODOSIA (1823-1894), English writer, was born at Bromley, near Bow, on the 20th of December 1823. Brought up in the Anglican creed, she fell under the influence of Tractarian teaching at Torquay, and joined the Roman Catholic Church in 1850. She wrote, and published anonymously, an essay questioning the *Morality of Tractarianism*, which was attributed to John Henry Newman. In 1852, after a prolonged stay in Rome, she joined the third order of St Dominic, to which she belonged for over forty years. She was prioress (1872-1881) of the Stone convent in Staffordshire, where she died on the 20th of April 1894. Her chief works in prose and verse are: *The History of Saint Dominic* (1857; enlarged edition, 1891); *The Life of St Catherine of Siena* (1880; 2nd ed., 1899); *Christian Schools and Scholars* (1867); *The Knights of St John* (1858); *Songs in the Night* (1876); and *The Three Chancellors* (1859), a sketch of the lives of William of Wykeham, William of Waynflete and Sir Thomas More.

A complete list of her writings is given in the *Memoir of Mother Francis Raphael, O.S.D., Augusta Theodosia Drane*, edited by B. Wülfers, O.P. (London, 1895).

DRAPER, JOHN WILLIAM (1811-1882), American scientist, was born at St Helen's, near Liverpool, on the 5th of May 1811. He studied at Woodhouse Grove, at the University of London, and, after removing to America in 1832, at the medical school of the University of Pennsylvania in 1835-1836. In 1837 he was elected professor of chemistry in the University of the City of New York, and was a professor in its school of medicine in 1840-1850, president of that school in 1850-1873, and professor of chemistry until 1881. He died at Hastings, New York, on the 4th of January 1882. He made important researches in photochemistry, made portrait photography possible by his improvements (1839) on Daguerre's process, and published a *Text-book on Chemistry* (1846), *Text-book on Natural Philosophy* (1847), *Text-book on Physiology* (1866), and *Scientific Memoirs* (1878) on radiant energy. He is well known also as the author of *The History of the Intellectual Development of Europe* (1862), applying the methods of physical science to history, a *History of the American Civil War* (3 vols., 1867-1870), and a *History of the Conflict between Religion and Science* (1874).

His son, HENRY DRAPER (1837-1882), graduated at the University of New York in 1858, became professor of natural science there in 1860, and was professor of physiology (in the medical school) and dean of the faculty in 1866-1873. He succeeded his father as professor of chemistry, but only for a year, dying in New York on the 20th of November 1882. Henry Draper's most important contributions to science were made in spectroscopy; he ruled metal gratings in 1869-1870, made valuable spectrum photographs after 1871, and proved the presence of oxygen in the sun in a monograph of 1877. Edward C. Pickering carried on his study of stellar spectra with the funds of the Henry Draper Memorial at Harvard, endowed by his widow (*née* Mary Anna Palmer).

See accounts by George F. Barker in *Biographical Memoirs of the National Academy of Science*, vols. 2 and 3 (Washington, 1886, 1888).

DRAPER, one who deals in cloth or textiles generally. The Fr. *drap*, cloth, from which *draper* and Eng. "draper" are derived, is of obscure origin. It is possible that the Low Lat. *drappus* or *trappus* (the last form giving the Eng. "trappings") may be connected with words such as "drub," Ger. *treffen*, beat; the original sense would be fulled cloth. "Drab," dull, pale, brown, is also connected, its first meaning being a cloth of a natural undyed colour. The Drapers' Company is one of the great livery companies of the city of London. The fraternity is of very early origin. Henry Fitz-Alwyn (d. 1212?), the first mayor of London, is said to have been a draper. The first charter was granted in 1364. The Drapers' Guild was one of the

numerous subdivisions of the clothing trade, and appeared to have been confined to the retailing of woollen cloths, the linen-draperies forming in the 15th century a separate fraternity, which disappeared or was merged in the greater company. It is usual for drapers to combine the sale of "drapery," i.e. of textiles generally, with that of millinery, hosiery, &c. In *Wills v. Adams* (reported in *The Times*, London, Nov. 20, 1908), the term "drapery" in a restrictive covenant was held not to include all goods that a draper might sell, such as furs or fur-lined goods.

DRAUGHT (from the common Teutonic word "to draw"; cf. Ger. *Tracht*, load; the pronunciation led to the variant form "draft," now confined to certain specific meanings), the act or action of drawing, extending, pulling, &c. It is thus applied to animals used for drawing vehicles or loads, "draught oxen," &c., to the quantity of fish taken by one "drag" of a net, to a quantity of liquid taken or "drawn in" to the mouth, and to a current of air in a chimney, a room or other confined space. In furnaces the "draught" is "natural" when not increased artificially, or "forced" when increased by mechanical methods (see *BOTTLER*). The water a ship "draws," or her "draught," is the depth to which she sinks in the water as measured from her keel. The word was formerly used of a "move" in chess or similar games, and is thus, in the plural, the general English name of the game known also as "checkers" (see *DRAUGHTS*). The spelling "draft" is generally employed in the following usages. It is a common term for a written order "drawn on" a banker or other holder of funds for the payment of money to a third person; thus a cheque (*q.v.*) is a draft. A special form of draft is a "banker's draft," an instruction by one bank to another bank, or to a branch of the bank making the instruction, to pay a sum of money to the order of a certain specified person. Other meanings of "draft" are an outline, plan or sketch, or a preliminary drawing up of an instrument, measure, document, &c., which, after alteration and amendment, will be embodied in a final or formal shape; an allowance made by merchants or importers to those who sell by retail, to make up a loss incurred in weighing or measuring; and a detachment or body of troops "drawn off" for a specific purpose, usually a reinforcement from the depot or reserve units to those abroad or in the field. For the use of the term "draft" or "draught" in masonry and architecture see *DRAFTED MASONRY*.

DRAUGHTS (from A.S. *dragan*, to draw), a game played with pieces (or "men") called draughtsmen on a board marked in squares of two alternate colours. The game is called Checkers in America, and is known to the French as *Les Dames* and to the Germans as *Damenspiel*. Though the game is not mentioned in the *Complete Gamester*, nor the *Académie de jeux*, and is styled a "modern invention" by Strutt, yet a somewhat similar game was known to the Egyptians, some of the pieces used having been found in tombs at least as old as 1600 B.C., and part of Anect Hat-Shepsa's board and some of her men are to be seen in the Egyptian gallery of the British Museum. An Egyptian vase also shows a lion and an antelope playing at draughts, with five men each, the lion making the winning move and seizing the bag or purse that contains the stakes. Plato ascribes the invention of the game of *resool*, or draughts, to Thoth, the Egyptian Hermes Trismegistus, and Homer represents Penelope's suitors as playing it (*Odys. i. 107*). In one form of the game as played by the Greeks there were 25 squares, and each player had 5 men which were probably moved along the lines. In another there were 4 men and 16 squares with a "sacred enclosure," a square of the same size as the others, marked in the exact centre and bisected by one of the horizontal lines, which was known as the "sacred line." From the incident in the game of a piece hemmed in on this line by a rival piece having to be pushed forward as a last resort, arose the phrase "to move the man from the sacred line" as synonymous with being hard pressed. This and other phrases based on incidents in the game testify to the vogue the game enjoyed in ancient Greece. The Roman game of *Latranclui* was similar, but there were officers (kings in modern draughts) as well as men. When a player's pieces were all hemmed in he was stale-mated, to

use a chess phrase (*ad incitibus redactus est*), and lost the game. Other explanations of this phrase are, however, given (see *Les Jeux des anciens*, by Beq de Fouquieres). The fullest account of the Roman game is to be found in the *De ludeo Pisonis*, written by an anonymous contemporary of Nero (see *CALPURNIUS, TRIVS*). Unfortunately the texts are full of obscurities, so that it is difficult to make any definite statements as to how the game was played.

As early as the 11th century some form of the game was practised by the Norsemen, for in the Icelandic saga of Grettir the Strong the board and men are mentioned more than once.

The history of the modern forms of the game starts with *El Ingenio o juego de marro, de punto o damas*, published by Torquemada at Valencia in 1547. Another Spaniard, Juan Garcia Canalejas, is said to have published in 1610 the first edition of his work, a better-known edition of which appeared in 1650. The third Spanish classic, that of Joseph Carlos Garcez, was printed in Madrid in 1684. It is noteworthy that in an illustration in Garcez's book the pieces depicted resemble somewhat some of those used by the Egyptians, and are not unlike the pawns used in chess.

In 1668 Pierre Mallet had published the first French work on the game, and elementary though his knowledge of the game seems to have been, even in comparison with that of Canalejas or Garcez, the historical notes, rules and instructions which he gave, served as a basis for many later works. Mallet wrote on *Le Jeu de dames à la française*, which was almost identical with the modern English game. The old French game is, however, no longer practised in France, having been superseded by *Le Jeu de dames à la polonoise*. Manoury gives reasons for believing that the latter game originated in Paris about 1727.

About 1736 a famous player named Laclef published the first book on Polish draughts, but the first important book on the game is Manoury's *Jeu de dames à la polonoise*, in the production of which it is said that the author had the assistance of Diderot and other *encyclopédistes*. This book, which appeared in 1787, was to the new game all that Mallet's was to the old French game, and until the appearance of Poinson Prugneaux's *Encyclopédie du jeu de dames* in 1855 it remained the standard authority on so-called Polish draughts. The Polish game early attained popularity in Holland, and in 1785 the standard Dutch work, Ephraim van Embden's *Verhandeling over het Damspel*, was produced. In German-speaking countries the progress of the new game was slower, and the works produced in the first half of the 19th century generally treat of the older game as well as the Polish game. This is also the case with Petroff's book published in St Petersburg in 1827; and similarly Zongono's, which dates from 1832, deals with the new game and with the older Italian game.

In 1604 Hyde wrote *Historia dami ludi seu latrinclorum*, in which he tried to prove the identity of draughts with *ludus latrinclorum*. This work is historical and descriptive, but contains nothing concerning the game as played in Great Britain. The authentic history of draughts in England commences with William Payne's *Introduction to the Game of Draughts*, the dedication of which was written by Samuel Johnson. Payne's games and problems were incorporated in a much more important work, namely Sturges's *Guide to the Game of Draughts*, which appeared in 1800 and has gone through a score of editions. About this time the game was much practised in both England and Scotland, but the first important production of the Scottish school was Drummond's *Scottish Draught Player*, the first part of which dates from 1838, additional volumes appearing in 1851-1853 and 1861. In 1852 Andrew Anderson published his *Game of Draughts Simplified*. A first edition had appeared in 1848, but the later print is the important one, as it standardized the laws of the game, fixed the nomenclature of the openings, introduced a better arrangement of the play, and, since Anderson was one of the finest players of the game, excelled in accuracy. In Anderson's time little was known about the openings commencing with any move other than 11-15, and it was not until more than thirty years later that the other openings received

more adequate recognition. This was done in Robertson's *Guide to the Game of Draughts*, and perhaps better in Lees' *Guide* (1892).

Andrew Anderson was the first recognized British champion player of the game. He and Wyllie, better known as "the herd laddie," contested five matches for the honour, Anderson winning four to Wyllie's one. After his victory in 1847 Anderson retired from match play and the title fell to Wyllie, who made the game his profession and travelled all over the English-speaking world to play it. In 1872 he successfully defended his position against Martins, the English champion, and in 1874 against W. R. Barker, the American champion, but two years later he was beaten by Yates, a young American. On the latter's retirement from the game, the championship lapsed to Wyllie, who held it successfully until his defeat by Ferrie, the Scottish champion, in 1894. Two years later Ferrie was beaten in his turn by Richard Jordan of Edinburgh, who had just gained the Scottish championship, and the new holder defeated Stewart, who challenged him in 1897, and successfully defended his title against C. F. Barker, the American champion, to meet whom he visited Boston in 1900 and played a drawn match.

In 1884 the first international match between England and Scotland took place, and resulted in so decisive a victory for the northerners that the contest was not renewed for ten years. The matches played in 1894 and 1899 also went strongly in favour of the Scots, but in 1903 the Englishmen gained their first victory.

In 1905 a British team visited America and defeated a side representing the United States.

The tournament for the Scottish championship has been held annually in Glasgow since 1803. The number and skill of the Scottish players have given this tournament its pre-eminence; but if the levelling up of the standards of play in Scotland and England continues, the competition which is held biennially by the English Draughts Association is likely to rank as a serious rival to the Glasgow tourney.

The English Game.—Draughts as played now in English-speaking countries is a game for two persons with a board and twenty-four men—twelve white and twelve black—which at starting are placed as follows: the black men on the squares numbered 1 to 12, and the white men on the squares numbered 21 to 32 on the diagram below. In printed diagrams the men are usually shown on the white squares for the sake of clearness,

but in actual play the black squares are generally used now. In playing on the black squares the board must be placed with a black square in the left-hand corner. The game is played by moving a man forward, one square at a time except when making a capture, along the diagonals to the right or left. Thus a white man placed on square 18 in the diagram can move to 15 or 14. Each player moves alternately, black always moving first. If a player touch a

piece he must move that piece and no other. If the piece cannot be moved, or if it is not the player's turn to move, he forfeits the game. As soon as a man reaches one of the squares farthest from his side of the board, he is "crowned" by having one of the unused or captured men of his own colour placed on him, and becomes a "king." A king has the power of moving and taking backwards as well as forwards.

If a man is on the square adjacent to an opponent's man, and there is an unoccupied square beyond, the unprotected man must be captured and removed from the board. Thus if there is a white man on square 18, and a black man on square 14, square 9 being vacant, and white having to move, he jumps over 14 and remains on square 9, and the man on 14 is taken up.

If two or more men are so placed that one square intervenes

between each they may all be taken at one move. Thus if white having to move has a man on 28, and black men on 24, 16 and 8, the intermediate squares and square 3 being vacant, white could move from 28 to 3, touching 19 and 12 en route, and take the men on 24, 16, and 8, but if there is a piece on 7 and square 10 is vacant, the piece on 7 cannot be captured, for becoming a king ends the move.

It is compulsory to take if possible. If a player can take a man (or a series of men) but makes a move that does not capture (or does not capture all that is possible), his adversary may allow the move to stand, or he may have the move retracted and compel the player to take, or he may allow the move to stand and remove the piece that neglected to capture from the board (called "huffing"). "Huff and move" go together, i.e. the player who huffs then makes his move. When one player has lost all his pieces, or has all those left on the board blocked, he loses the game.

The game is drawn when neither of the players has sufficient advantage in force or position to enable him to win.

The losing game, or "first off the board," is a form of draughts not much practised now by expert draught players. The player wins who gets all his pieces taken first. There is no "huffing": a player who can take must do so.

Draughts Openings.—As there are seven possible first moves, with seven possible replies to each, or forty-nine in all, there is an abundant variety of openings; but as two of these (9-14, 21-17 and 10-14, 21-17) are obviously unsound, the number is really reduced to forty-seven. Much difference of opinion exists regarding the relative strength of the various openings. It was at one time generally held that for the black side 11-15 was the best opening move.

Towards the end of the 19th century this view became much modified, and though 11-15 still remained the favourite, it was recognized that 10-15, 9-14 and 11-16 were little, if at all, inferior; 10-14 and 12-16 were rightly rated as weaker than the four moves named above, whilst 9-13, the favourite of the "unscientific" player, was found to be weakest of all.

The white replies to 11-15 have gone through many vicissitudes. The seven possible moves have each at different times figured as the general favourite. Thus 24-19, which analysis proved to be the weakest of the seven, was at one period described by the title of "Wyllie's Invincible." In course of time it came to be regarded as decidedly weak, and its name was altered to the less pretentious title of "Second Double Corner." In the Scottish Tournament of 1894 this opening was played between Ferrie and Stewart, and the latter won the game with white, introducing new play which has stood the test of analysis, and so rehabilitating the opening in public favour. The 21-17 reply to 11-15 was introduced by Wyllie, who was so successful with it that it became known as the "Switcher." This opening perhaps lacks the solid strength of some of the others, but it so abounds in traps as to be well worthy of its name. The other five replies to 11-15, namely 24-20, 23-19, 23-18, 22-18 and 22-17, are productive of games which give equal chances to both sides.

The favourite replies to 10-15 are 23-18, 22-18 and 21-17, but they do not appear to be appreciably stronger than the others, with the possible exception of 24-20.

In response to 11-16, 23-18 is held to give white a trifling advantage, but it is more apparent than real. With the exception of 23-19, which is weak, the other replies are of equal strength, and are only slightly, if at all, inferior to the more popular 23-18. 9-14 is most frequently encountered by 22-18, but all white's replies are good, except of course 21-17 which loses a man, and 23-18 which weakens the centre of white's position.

Against 10-14 the most popular move is 22-17, which gives white an advantage. Next in strength come 23-18 and 24-19. 23-18 is weak.

The strongest reply to 12-16 is 24-20. The others, except 23-19, which is weak, give no initial advantage to either side.

As already mentioned, 9-13 is black's weakest opening move, both 22-18 and 24-19 giving white a distinct advantage. Nevertheless 9-13 is a favourite debut with certain expert players, especially when playing with inferior opponents.

The term "opening" is frequently applied in a more restricted sense than that used above. When practically all games started with 11-15 it was convenient to assign names to the more popular lines of play. Thus 11-15, 23-19, 8-11, 22-17 if followed by 11-16, was called the "Glasgow", if followed by 9-13, 17-14, the "Laird and Lady", if by 3-8, the "Alma".

The variety possible in the opening is a fair reply to the objection sometimes heard that the game does not afford sufficient scope for variation. As a matter of fact a practically unlimited number of different games might be played on any one opening.

The three following games are typical examples of the play arising from three of the most frequently played openings:—

Game No. 1.—"Ayrshire Lassie" Opening.

a 11-15	25-18	10-15	22-17	b 15-18	24-6
a 24-20	3-8	23-19	13-22	24-20	2-9
8-11	26-22	6-10	26-17	18-27	17-10
28-24	5-9	c } 27-23	11-16	31-24	8-11
9-13	30-26	9-14	20-11	16-23	Drawn.
22-18	1-5	18-9	7-16	20-16	R. Jordan.
15-22	32-28	5-14	29-25	12-19	

a. 11-15, 24-20 forms the "Ayrshire Lassie" opening, so named by Wyllie. It is generally held to admit of unusual scope for the display of critical and brilliant combinations.

b. 16-20, 25-22, 20-27, 31-24, 8-11, 17-13, 2-6, 21-17, 14-21, 22-17, 21-25, 17-14, 10-17, 19-1.

(c)

26-23	28-19	20-16	7-11	14-10	15-10
9-14	2-6	6-10	19-24	26-23	23-18
18-9	20-11	16-11	11-18	10-7	10-15
5-14	8-24	10-15	24-27	4-8	20-16
29-25	27-20	11-7	18-15	7-3	15-22
11-16	10-15	14-18	27-31	8-12	16-7
20-11	31-26	7-3	22-18	3-7	Drawn.
7-16	15-19	18-23	31-27	27-24	A. B. Scott.
24-20	23-16	3-7	18-14	7-11	b.
15-24	12-19	23-30	30-26	24-20	R. Jordan.

(d)

19-16	7-10	23-19	11-15	16-11	25-30
12-19	6-1	15-24	27-24	18-25	20-16
22-17	9-14	28-19	22-25	17-14	Drawn.
15-22	26-23	8-11	29-22	10-17	R. Jordan.
24-6	11-15	19-16	14-18	21-14	

Game No. 2.—"Kelso-Cross" Opening.

a 10-15	8-12	13-22	5-9	14-18	22-25
a 23-18	25-21	26-17	20-16	17-14	29-22
12-16	1-6	d 19-26	2-7	10-17	17-26
21-17	32-27	30-23	24-19	21-14	5-1
9-13	12-16	15-22	15-24	6-10	26-30
17-14	27-23	24-19	23-19	14-9	1-5
16-19	7-10	9-14	24-27	10-14	30-26
24-20	14-7	19-12	31-24	19-15	5-9
6-9	3-10	11-15	9-13	14-17	26-23
b 27-24	c 22-17	28-24	24-20	9-5	Drawn.

a. These two moves form the "Kelso-Cross" opening.

b. 27-23 is also a strong line for white to adopt.

c. 30-25, 4-8, 18-14, 9-27, 22-18, 15-22, 24-15, 11-18, 20-4, 27-32, 26-17, 13-22, 4-8, 22-26, and black appears to have a winning advantage. R. Jordan.

d. Taking the piece on 18 first seems to lose, thus:—

15-22	e 9-13	13-17	6-9	5-14	
24-8	17-14	23-18	14-10	10-7	White wins.
4-11	10-17	17-21	9-14	2-6	
31-27	21-14	28-24	18-9	7-2	Dallas.

c. 2-7, 27-24, 22-26, 23-18, 26-31, 18-15, 11-18, 20-2, 9-13, 2-9, 5-14, 24-19, 13-22, 30-26. White wins.

Game No. 3.—"Dundee" Opening.

12-16	11-15	c 8-12	4-8	9-14	1-26
24-20	20-11	17-13	18-15	26-22	31-22
8-12	7-16	5-9	2-7	14-17	19-23
28-24	24-20	22-18	30-26	21-14	13-9
9-14	b 16-19	15-22	10-14	18-23	12-19
22-17	23-16	25-18	29-25	27-18	9-6
3-8	12-19	14-23	14-18	6-10	7-11
a 26-22	20-16	27-18	32-27	15-6	Drawn.

R. Jordan.

a. This move is the favourite at this point on account of its "trappiness," but 25-22 is probably stronger, thus: 25-22, 16-19, 24-15, 11-25, 29-22, 8-11, 17-13, 11-16, 20-11, 7-16, and white can with advantage continue by 27-24, 22-17, 23-19 or 22-18.

b. 15-19, 20-11, 8-15, 23-16, 12-19, 17-13, 5-9, 30-26, 4-8, 27-23, 8-12, 23-16, 12-19, 31-27, 1-5, 27-23, 19-24, 32-27, 24-31, 22-17. White wins. C. F. Barker.

c 8-11	27-18	15-18	14-10	24-27	7-10
16-7	15-22	14-10	19-24	31-24	27-31
2-11	25-18	6-15	10-7	16-20	10-26
22-18	10-15	17-14	18-23	3-7	31-22
14-23	18-14	11-16	7-3	20-27	30-25

Drawn. R. Stewart v. R. Jordan.

Problem No. 1 is the simplest form of that known to draughts-players as the "First Position." It is of more frequent occurrence in actual play than any other end-game, and is, besides, typical of a class of draughts problems which may be described as analytical, in contradistinction to "strokes."

Problem No. 1, by Wm. Payne. BLACK.

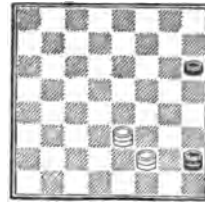

WHITE.

White to move and win.

Solution:—

27-32	18-15	15-11	11-15	28-32	19-24
28-24	2-28-24	12-16	19-24	27-31	White wins.
23-18	32-28	28-32	32-28	15-19	
3-6-24-28	1-24-20	16-19	24-27	31-26	

a. 12-16 same as Var. I. at 5th move.

Var. I.

24-27	18-15	19-16	28-32	8-12	15-11
15-18	b 16-20	18-23	8-12	23-18	White wins.
12-16	15-18	16-11	32-27	12-8	
28-32	24-19	23-19	12-8	18-15	
27-24	32-28	11-8	27-23	8-12	

b. 24-28 same as Var. II. at 1st move.
 Var. II. 12-16, 15-11, 16-19, 32-27, 28-32, 27-31, 32-28, 11-16, 19-23, 16-19. White wins.
 Var. III. 24-19, 32-28, c 19-16, 28-24, 16-11, 24-20, 11-8, 18-15. White wins.

c. 12-16, 28-32, 19-24 or 16-20, same as Var. II. at 5th and 9th moves respectively. White wins.

Problem No. 2.

BLACK.

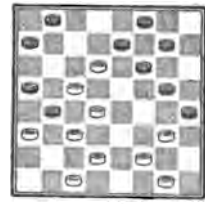

WHITE.

White to move and win.

Problem No. 2 is a fine example of another class of problems, namely, "strokes." It is formed from the "Paisley" opening, thus:—

11-16	22-17	11-16	26-19	9-13	15-10
24-19	9-13	25-21	4-8	25-22	a 2-7
8-11	17-14	6-9	29-25	7-11	
28-24	10-17	23-18	13-17	19-15	
16-20	21-14	16-23	31-26	12-16	

a. This forms the position on the diagram. The solution is as follows:—

27-23	7-14	18-9	14-23	26-3
20-27	9-6	5-14	21-7	27-31
14-9	1-10	23-18	3-10	3-7

White wins. Jacques and Campbell.

Other Varieties.—The forms of draughts practised on the European continent differ in some respects from the English variety, chiefly in respect of the power assigned to a man after "crowning." The game of Polish Draughts is played in France, Holland, Belgium and Poland, where it has entirely superseded *Le Jeu de dames à la française*. It is played on a board of 100 squares with 20 men a side. The men move and capture as in English draughts, except that in capturing they move either forward or backward. A crowned man becomes a queen, and can move any number of squares along the diagonal. In her capture she takes any unguarded man or queen in any diagonal she commands, leaping over the captured man or queen and remaining on any unoccupied square she chooses of the same diagonal, beyond the piece taken. But if there is another unguarded man she is bound to choose the diagonal on which it can be taken. For example (using an English draught-board) place a queen on square 29 and adverse men at squares 22, 16, 24, 14. The queen is bound to move from 29 to 11, 20, 27, and having made the captures to remain at 9 or 5, whichever she prefers. The capturing queen or man must take all the adverse pieces that are *en prise*, or

that become so by the uncovering of any square from which a piece has been removed during the capture, e.g. white queen at square 7, black at squares 10, 18, 19, 22 and 27, the queen captures at 10, 22, 27 and 19, and the piece at 22 being now removed, she must go to 15, take the man at 18, and stay at 22, 25 or 29. In consequence of the intricacy of some of these moves, it is customary to remove every captured piece as it is taken. If a man arrives at a crowning square when taking, and he can still continue to take, he must do so, and not stay on the crowning square as at draughts. Passing a crowning square in taking does not entitle him to be made a queen. In capturing, the player must choose the direction by which he can take the greatest number of men or queens, or he may be huffed. Numerical power is the criterion, e.g. three men must be taken in preference to two queens. If the numbers are equal and one force comprises more queens than the other, the player may take whichever lot he chooses. This form of draughts, played on a board of 144 squares with 30 men a side, is extensively practised by British soldiers in India.

The German *Damenspiel* is Polish draughts played on a board of the same size and with the same number of men as in the English game. It is sometimes called Minor Polish draughts, and is practised in Germany and Russia.

The *Italian game* differs from the English in two important particulars—a man may not take a king, and when a player has the option of capturing pieces in more than one way he must take in the manner which captures most pieces. There is a difference too in the placing of the board, the black square in the corner of the board being at the player's right hand, but until a king is obtained the differences from the English system are unimportant in practice.

In *Spanish draughts* the board is set as for the Italian game. The men move as in English draughts, but, in capturing, the largest possible number of pieces must be taken, and the king has the same powers as in the Polish game. The game does not differ essentially from the English game until a king is obtained, and many games from Spanish works will be found incorporated in English books. Sometimes the game is played with 11 men and a king, or 10 men and 2 kings a side, instead of the regulation 12 men.

Turkish draughts differs widely from all other modern varieties of the game. It is played on a board of 64 squares, all of which are used in play. Each player has 16 pieces, which are not placed on the two back rows of squares, as in chess, but on the second and third back rows. The pieces do not move diagonally as in other forms of the game, but straight forward or to the right or left horizontally. The king has the same command of a horizontal or vertical row of squares that the queen in Polish draughts has over a diagonal. Capturing is compulsory, and the greatest possible number of pieces must be taken, captured pieces being removed one at a time as taken.

AUTHORITIES.—Falkner's *Games Ancient and Oriental*; Lees' *Guide to the Game of Draughts*; Drummond's *Scottish Draught Players* (Kear's reprint); Gould's *Memorable Matches and Book of Problems*, &c. The *Draughts World* is the principal magazine devoted to the game. In Duncun's *Draught Players' Guide and Companion* a section is devoted to the non-English varieties. (J. M. M. D.; R. J.)

DRAUPADI, in Hindu legend, the daughter of Drupada, king of Panchala, and wife of the five Pandava princes. She is an important character in the *Mahabharata*.

DRAVE, or **DRAVA** (Ger. *Drav*, Hung. *Dráva*, Lat. *Dravus*), one of the principal right-bank affluents of the Danube, flowing through Austria and Hungary. It rises below the Innichner Eck, near the Toblacher Feld in Tirol, at an altitude of a little over 4000 ft., runs eastward, and forms the longest longitudinal valley of the Alps. The Drave has a total length of 450 m., while the length of its Alpine valley to Marburg is 150 m., and to its junction with the Mur 250 m. Owing to its great extent and easy accessibility the valley of the Drave was the principal road through which the invading peoples of the East, as the Huns, the Slavs and the Turks, penetrated the Alpine countries. The Drave flows through Carinthia and Styria, and enters Hungary near Friedau, where up to its confluence with the Danube, at Almas, 14 m. E. of Esseg, it forms the boundary between that country and Croatia-Slavonia. At its mouth the Drave attains a breadth of 1055 ft. and a depth of 20 ft. The Drave is navigable for rafts only from Villach, and for steamers from Báracs, a distance of 95 m. The principal affluents of the Drave are: on the left the Isel, the Gurk, the Lavant, and the largest of all, the Mur; and on the right the Gail and the Drann.

DRAVIDIAN (Sanskrit *Dravida*), the name given to a collection of Indian peoples, and their family of languages¹ comprising all

¹ In Dravidian words a line above a vowel shows that it is long. The dotted consonants *l*, *ḷ*, and *ṇ* are pronounced by striking the tip of the tongue against the centre of the hard palate. The dotted *l* is distinguished from *l* in a similar way. Its sound, however, differs

the principal forms of speech of Southern India. Their territory, which also includes the northern half of Ceylon, extends northwards up to an irregular line drawn from a point on the Arabian Sea about 100 m. below Goa along the Western Ghats as far as Kolhapur, thence north-east through Hyderabad, and farther eastwards to the Bay of Bengal. Farther to the north we find Dravidian dialects spoken by small tribes in the Central Provinces and Chota Nagpur, and even up to the banks of the Ganges in the Rajmahal hills. A Dravidian dialect is, finally, spoken by the Brāhūis of Baluchistan in the far north-west. The various Dravidian languages, with the number of speakers returned at the census of 1901, are as follows:—

Tamil	17,494,901
Malayālam	6,022,131
Kanarese	10,368,515
Tulu	535,210
Koḍagu	39,191
Toda	805
Kōta	1,300
Kurux	609,721
Malto	60,777
Gōḍḍī	1,125,479
Kui	494,099
Telugu	20,697,264
Brāhūi	48,589
Total	57,497,982

Of these Tamil and Malayālam can be considered as two dialects of one and the same language, which is, in its turn, closely related to Kanarese. Tulu, Koḍagu, Toda and Kōta can be described as lying between Tamil-Malayālam and Kanarese, though they are more nearly related to the latter than to the former. The same is the case with Kurux and Malto, while Kui and Gōḍḍī gradually approach Telugu, which latter language seems to have branched off from the common stock at an early date. Finally, the Brāhūi dialect of Baluchistan has been so much influenced by other languages that it is no longer a pure Dravidian form of speech.

The Dravidian languages have for ages been restricted to the territory they occupy at the present day. Moreover, they are gradually losing ground in the north, where they meet with Aryan forms of speech. If we compare the caste tables and the language tables in the Indian census of 1901 we find that only 1,125,479 out of the 2,286,913 Gōḍḍis returned were stated to speak the Dravidian Gōḍḍī. Similarly only 1505 out of 17,187 Kōlāms entered their language as Kōlāmi. Such tribes are gradually becoming Hinduized. Their language adopts an ever-increasing Aryan element till it is quite superseded by Aryan speech. In the north-eastern part of the Dravidian territory, to the east of Chanda and Bhandara, the usual state of affairs is that Dravidian dialects are spoken in the hills while Aryan forms of speech prevail in the plains. The Dravidian Kui thus stands out as an isolated island in the sea of Aryan speech.

This process has been going on from time immemorial. The Dravidians were already settled in India when the Aryans arrived from the north-west. The fair Aryans were at once struck by their dark hue, and named them accordingly *kṛiṣṇa ita*, the black skin. In the course of time, however, the two races began to mix, and it is still possible to trace a Dravidian element in the Aryan languages of North India.

The teaching of anthropology is to the same effect. Most speakers of Dravidian languages belong to a distinct anthropological type which is known as the Dravidian. "The Dravidian race," says Sir H. Risley, "the most primitive of the Indian types, occupies the oldest geological formation in India, the medley of forest-clad ranges, terraced plateaus, and undulating plains which stretches, roughly speaking, from the Vindhya to Cape Comorin. On the east and west of the peninsular area the domain of the Dravidian is continuous with the Ghats, in the different districts. A Greek *x* marks the sound of *ch* in "loch"; *ḡ* is the English *sh*; *c* the *ch* in "church"; and *ri* is an *r* which is used as a vowel. In the list of Dravidian languages the names are spelt fully, with all the necessary diacritical marks. In the rest of the article dots under consonants have been omitted in these words.

while farther north it reaches on one side to the Aravallis and on the other to the Rajmahal hills."

This territory is the proper home of the race. A strong Dravidian element can, however, also be traced in the population of northern India. In Kashmir and Punjab, where the Aryans had already settled in those prehistoric times when the Vedic hymns were composed, the prevailing type is the Aryan one. The same is the case in Rajputana. From the eastern frontier of the Punjab, on the other hand, and eastwards, a Dravidian element can be traced. This is the case in the valleys of the Ganges and the Jumna, where the Aryans only settled at a later period. Anthropologists also state that there is a Dravidian element in the population of western India, from Gujarat to Coorg.

It is thus probable that Dravidian languages have once been spoken in many tracts which are now occupied by Aryan forms of speech. The existence of a Dravidian dialect in Baluchistan seems to show that Dravidian settlers have once lived in those parts. The tribe in question, the Brāhūis, are, however, now Eranians and not Dravidians by race, and it is not probable that there has ever been a numerous Dravidian population in Baluchistan. The Brāhūis are most likely the descendants of settlers from the south.

There is no indication that the Dravidians have entered India from outside or superseded an older population. For all practical purposes they can accordingly be considered as the aborigines of the Deccan, whence they appear to have spread over part of northern India. Their languages from an isolated group, and it has not been possible to prove a connexion with any other family of languages. Such attempts have been made with reference to the Munda family, the Tibeto-Burman languages, and the dialects spoken by the aborigines of the Australian continent. The arguments adduced have not, however, proved to be sufficient, and only the Australian hypothesis can still lay claim to some probability. Till it has been more closely tested we must therefore consider the Dravidian family as an isolated group of languages, with several characteristic features of its own.

The pronunciation is described as soft and mellifluous. Abruptness and hard combinations of sounds are avoided. There is, for example, a distinct tendency to avoid pronouncing a short consonant at the end of a word, a very short vowel being often added after it. Thus the pronoun of the third person singular, which is *avan*, "he," in Tamil, is pronounced *avanu* in Kanarese; the Sanskrit word *vāk*, "speech," is borrowed in the form *vāku* in Tamil; the word *gurram*, "horse," is commonly pronounced *gurramu* in Telugu, and so on. Combinations of consonants are further avoided in many cases where speakers of other languages do not experience any difficulty in pronouncing them. This tendency is well illustrated by the changes undergone by some borrowed words. Thus the Sanskrit word *brāhmana*, "a Brahmin," becomes *brādmāna* in Kanarese and *pirādmāna* in Tamil; the Sanskrit *Dramiḍa*, "Dravidian," is borrowed by Tamil under the form *Tirāmiḍa*. *Dramiḍa*, which also occurs as *Draviḍa*, is in its turn developed from an older *Damiḷa*, which is identical with the word *Tamiḷ*, Tamil.

The forms *pirādmāna* and *Tirāmiḍa* in Tamil illustrate another feature of Dravidian enunciation. There is a tendency in all of them, and in Tamil and Malayalam it has become a law, against any word being permitted to begin with a stopped vowel consonant (*g, j, ḡ, d, h*), the corresponding voiceless sounds (*k, c, ḷ, t, p*, respectively) being substituted. In the middle of a word or compound, on the other hand, every consonant must be voiced. Thus the Sanskrit word *danta*, "tooth," has been borrowed by Tamil in the form *ṭandam*, and the Telugu *anna*, "elder brother," *ṭammulu*, "younger brother," become when compounded *annadammulu*, "elder and younger brothers."

There is no strongly marked accent on any one syllable, though there is a slight stress upon the first one. In some dialects this equilibrium between the different parts of a word is accompanied by a tendency to approach to each other the sound of vowels in consecutive syllables. This tendency, which has been called the "law of harmonic sequence," is most apparent in Telugu, where the short *u* of certain suffixes is replaced by *i* when the preceding syllable contains one of the vowels *i* (short and long) and *ei*. Compare the dative suffix *ku, ki*, in *gurramu-ku*, "to a horse"; but *ṭammuni-ki*, "to a younger brother." This tendency does not, however, play a prominent rôle in the Dravidian languages.

Words are formed from roots and bases by means of suffixed formative additions. The root itself generally remains unchanged throughout. Thus from the Tamil base *per*, "great," we can form adjectives such as *per-ya* and *per-um*, "great"; verbs such as

per-u-gu, "to become increased"; *per-u-kku*, "to cause to increase," and so on.

Many bases can be used as will as nouns, as adjectives, and as verbs. Thus the Tamil *kaḍu* can mean "sharpness," "sharp," and "to be sharp." Other bases are of course more restricted in their respective spheres.

The inflection of words is effected by agglutination, i.e. various additions are suffixed to the base in order to form what we would call cases and tenses. Such additions have probably once been separate words. Most of them are, however, now only used as suffixes. Thus from the Tamil base *kōn*, "king," we can form an accusative *kōn-ai*, a verb *kōn-en*, "I am king," and so on.

Dravidian nouns are divided into two classes, which Tamil grammarians called high-caste and casteless respectively. The former includes those nouns which denote beings endowed with reason, the latter all others. Gender is only distinguished in the former class, while all casteless nouns are neuter. The gender of animals (which are irrational) must accordingly be distinguished by using different words for the male and the female, or else by adding words, meaning male, female, respectively, to the name of the animal—processes which do not, strictly speaking, fall under the head of grammar.

There are two numbers, the singular and the plural. The latter is formed by adding suffixes. It, however, often remains unmarked in the case of casteless nouns.

Cases are formed by adding postpositions and suffixes, usually to a modified form of the noun which is commonly called the oblique base. Thus we have the Tamil *maram*, "tree"; *marai-ḍi*, "from a tree"; *marai-tu-kku*, "to a tree"; *vīḍu*, "a house"; *vīḍi-ḍi*, "from a house." The case terminations are the same in the singular and in the plural. The genitive, which precedes the governing noun, is often identical with the oblique base, or else it is formed by adding suffixes.

The numeral system is decimal and higher numbers are counted in tens; thus Tamil *paḷu*, "ten"; *iru-badu*, "two tens," "twenty."

The personal pronoun of the first person in most dialects has a double form in the plural, one including and the other excluding the person addressed. Thus, Tamil *nānu*, "we," i.e. I and you; *nāṅgal*, "we," i.e. I and they.

There is no relative pronoun. Relative clauses are effected by using relative participles. Thus in Telugu the sentence "the book which you gave to me" must be translated *mīru nāku iccina pustakamu*, i.e. "you me-to given book." There are several such participles in use. Thus from the Telugu verb *koḷḷa*, "to strike," are formed *koḷḷi-ṭu-anna*, "that strikes," *koḷḷi-ṭu*, "that struck," *koḷḷi*, "that would strike," "that usually strikes." By adding pronouns, or the terminations of pronouns, to such forms, nouns are derived which denote the person who performs the action. Thus from Telugu *koḷḷi* and *vāḍu*, "he," is formed *koḷḷi-vāḍu*, "one who usually strikes." Such forms are used as ordinary verbs, and the usual verbal forms of Dravidian languages can broadly be described as such nouns of agency. Thus, the Telugu, *koḷḷiṇḍu*, "he struck," can be translated literally "a striker in the past."

Verbal tenses distinguish the person and number of the subject by adding abbreviated forms of the personal pronouns. Thus in Kanarese we have *māḍid-enu*, "I did"; *māḍid-i*, "thou didst"; *māḍid-eyu*, "we did"; *māḍid-aru*, "they did."

One of the most characteristic features of the Dravidian verb is the existence of a separate negative conjugation. It usually has only one tense and is formed by adding the personal terminations to a negative base. Thus, Kanarese *māḍ-enu*, "I did not"; *māḍ-eyu*, "we did not"; *māḍ-aru*, "they did not."

The vocabulary has adopted numerous Aryan loan-words. This was a necessary consequence of the early connexion with the superior Aryan civilization.

The oldest Dravidian literature is largely indebted to the Aryans, though it goes back to a very early date. Tamil, Malayalam, Kanarese and Telugu are the principal literary languages. The language of literature in all of them differs considerably from the colloquial. The oldest known specimen of a Dravidian language occurs in a Greek play which is preserved in a papyrus of the 2nd century A.D. The exact period to which the indigenous literature can be traced back, on the other hand, has not been fixed with certainty.

BIBLIOGRAPHY.—Bishop R. Caldwell, *A Comparative Grammar of the Dravidian or South-Indian Family of Languages* (London, 1856; 2nd edition, 1875); Dr Friedrich Müller, *Reise der österreichischen Fregate Novara um die Erde im Jahre 1857, 1858, 1859, unter dem Befehle des Commodore B. von Willerstorf-Urbair: Linguistischer Theil* (Wien, 1867, pp. 73 and ff.); Dr Friedrich Müller, *Grundriss der Sprachwissenschaft*, vol. iii. (Wien, 1882), pp. 106 and ff.; G. A. Grierson, *Linguistic Survey of India*, vol. iv. "Munda and Dravidian Languages" (Calcutta, 1906), pp. 277 and ff. by Sten Konow. (S. K.)

DRAWBACK, in commerce, the paying back of a duty previously paid upon the exportation of excisable articles or upon the re-exportation of foreign goods. The object of a drawback is to enable commodities which are subject to taxation to be exported

and sold in a foreign country on the same terms as goods from countries where they are untaxed. It differs from a bounty in that the latter enables commodities to be sold abroad at less than their cost price; it may occur, however, under certain conditions that the giving of a drawback has an effect equivalent to that of a bounty, as in the case of the so-called sugar bounties in Germany (see SUGAR). The earlier tariffs contained elaborate tables of the drawbacks allowed on the exportation or re-exportation of commodities, but so far as the United Kingdom is concerned the system of "bonded warehouses" practically abolished drawbacks, as commodities can be warehoused (placed "in bond") until required for subsequent exportation.

DRAWING, in art. Although the verb "to draw" has various meanings, the substantive *drawing* is confined by usage to its artistic sense, delineation or design. The word "draw," from a root common to the Teutonic languages (Goth. *dragan*, O.H.G. *drāhen*, Mod. Ger. *tragen*, which all have the sense of "carry," O. Norse *druga*, A.S. *drasan*, *drænan*, "draw," cf. Lat. *trahere*), means to pull or "drag" (a word of the same origin) as distinct from the action of pushing. It is thus used of traction generally, whether by men, animals or machines. The same idea is preserved in "drawing" as applied to the fine arts. We do not usually say, or think, that a sculptor is drawing when he is using his chisel, although he may be expressing or defining forms, nor that an engraver is drawing when he is pushing the burin with the palm of the hand, although the result may be the rendering of a design. But we do say that an artist is drawing when he uses the lead pencil, and here we have a motion bearing some resemblance to that of traction generally. The action of the artist in drawing the pencil point with his fingers along the paper is analogous, e.g., to that of a horse or man drawing a pole over soft ground and leaving a mark behind. The same analogy may be observed between two of the senses in which the French verb *tirer* is frequently employed. This word, the origin of which is quite uncertain, was formerly used by good writers in the two senses of the verb to draw. Thus Lafontaine says, "Six forts chevaux tiraient un coche"; and Caillières wrote, "Il n'y a pas longtemps que je me suis fait tirer par Rigaud," meaning that Rigaud had drawn or painted his portrait. At the present day the verb *tirer* has fallen into disuse amongst cultivated Frenchmen with regard to drawing and painting, but it is still universally used for all kinds of design and even for photography by the common people. The cultivated use it still for printing, as for example "cette gravure sera tirée à cent exemplaires," in the sense of pulling. A verb much more nearly related to the English verb to draw is the French *traire* (Lat. *trahere*), which has *trait* for its past participle. *Traire* is now used exclusively for milking cows and other animals, and though the analogy between this and artistic drawing is not obvious at first, nevertheless there is a certain analogy of motion, since the hand passing down the teat draws the milk downwards. The word *trait* is much more familiar in connexion with art as "les traits du visage," the natural markings of the face, and it is very often used in a figurative sense, as we say "traits of character." It is familiar in the English *portrait*, derived from *protrahere*. The ancient Romans used words which expressed more clearly the conception that drawing was done in line (*delineare*) or in shade (*adumbrare*), though there are reasons for believing that the words were often indiscriminately applied. Although the modern Italians have both *trarre* and *trarre*, they use *delineare* still in the sense of artistic drawing, and also *adumbrare*. The Greek verb *γράφειν* appears in English in "graphic" and in many compounds, such as photograph, &c. It is worth observing that the Greeks seem to have considered drawing and writing (*γράφειν*) as essentially the same process, since they used the same word for both. This points to the early identity of the two arts when drawing was a kind of writing, and when such writing as men had learned to practise was essentially what we should call drawing, though of a rude and simple kind. Even in the present day picture writing is not unfrequently resorted to by travellers as a means of making themselves intelligible. There is also a kind of art which is writing in the modern sense and

drawing at the same time, such as the work of the mediæval illuminators in their manuscripts. (X.)

The Art of Drawing.—Rather than attempt here a historical survey of the various so-called "styles" of drawing, or write a personal appreciation of them, it seems of greater use to give a logical account of drawing as an art, applicable to all times and countries. Reference to the teaching of drawing will be occasionally given rather to illustrate the argument than with a view to its being of practical use.

At the outset a distinction must be made between drawing as a means of symbolic or literary expression and drawing as the direct and only means of expressing the beauty of form. If Pharaoh wants to have it known that a hundred ducks were consumed at one meal in his court, he employs a draughtsman to register the fact on a frieze by picturing a row of cooks occupied in preparing the hundred ducks. The artist in this case does not represent the scene as he must have known it in the kitchen, with all its variety of movement and composition (as an early Greek vase painter conceived the interior of a vase factory), but all he does and is required to do is to give the sufficient number of figures and ducks. The more uniform the figures the greater will be the effect of number. Drawing has been employed here to tell a story, and it succeeds in so far as it tells the spectator plainly what could be told, perhaps less conveniently, in words. It matters not whether the figures and objects be feelingly rendered and harmoniously composed. So, to-day, a child, or any one who has a simple trick of symbolizing figures and objects in nature, can describe any event or moral by this process, provided the plot be not too elaborate to be expressed by a scene, or series of scenes, enacted by dumb symbolic figures. It is plain that the amusing pictures in *Punch* or *Fliegende Blätter* would be none the more amusing if they were done by the hand of Michelangelo, nor would the mystic designs of Blake be more full of meaning if drawn by Rembrandt, for in neither case do these works depend upon any subtle rendering of the forms of nature for their success, but upon the dramatic or intellectual imagination of the man who conceived them. When the witty or ethical man is at the same time a master draughtsman his work has two values, the "literary" content and the beauty of his drawing of natural objects. But it must be borne in mind that these values are fundamentally distinct; so much so that the spectator who has no appreciation of the forms of nature enjoys the story told and remains blind to the qualities of draughtsmanship, whilst the lover of nature's forms may or may not trouble to unravel the literary plot but finds perfect satisfaction in the drawing. By far the greater part of illustration, and of artistic production generally, must be classed as symbolic art. Magazine stories to-day are sometimes illustrated even by photography, for the hand of the artist is not required. Symbolic art describes indirectly and in a necessarily limited scope what literature can do directly and with unlimited powers. The only content of symbolic drawing is its literary meaning; as drawing it may be quite worthless.

Pure drawing, however, whether it represent a dramatic event or a knee-joint, has a content that cannot be expressed by words, and is not necessarily directed towards literary expression. Just as a fragment of good sculpture pleases the connoisseur without any reference either to the whole original or to its spiritual significance, fine drawing can appeal to the lover of nature independently of indirect considerations.

What is the content of pure drawing? It is held by some that drawing or monochrome can suggest colour, and many people, some consciously, others unconsciously, attempt to represent in drawings the colours of figures and landscape. It seems a strange aberration to argue that by different intensities of the one colour various other colours can be suggested: it would not be more unreasonable to maintain that E flat and F could be suggested by striking the note G with varying strength. Now the draughtsman employs various intensities of his monochrome as light and shade by which to give roundness to his forms. But if on the same drawing he uses the same means in his attempt to express colour, a conflict would be at once set up

between that which makes for form and that which would make for colour, and the result would generally be a confusion. Again, let one attempt to give red hair to a monochrome drawing of a man, and if the red be plain and unmistakable to all who are not the artist's accomplices, then the artist has succeeded; otherwise it is bootless to treat of colour and colour values (which of course must depend upon the existence of colour) in monochrome. Apart from theory, if we examine the drawings, etchings and monochromes of great artists, where do we find them attempting to give colour or colour values? The hundreds of costume studies by Rembrandt might have been done from white plaster models, and there are only a few exceptions where a man has, for instance, a black hat or cloak. But in these few instances the "colour" tone is applied with such discretion that the true representation of the form is scarcely, perhaps only theoretically, impaired: they certainly have gained nothing in colour value because no specific colour is manifest in them. In Rembrandt's, Claude's or Turner's drawings of landscapes the formation of the country, the architecture, &c., is expressed by line, light and shade, and enhanced by shadows cast from clouds

dimension in all objects causes light and shade, which in their turn bring about radical changes of the local colour, even in uniformly coloured objects. Now since drawing cannot suggest colour, local or atmospheric, any attempt to effect an illusion by a monochrome is at once defeated. If the end of drawing were to approach imitation or illusion as nearly as possible, how is it that a mere "sketch" by a master draughtsman can be for itself as valuable as his highly finished drawing? And surely a masterly outline drawing of a figure or landscape does not pretend to be an illusion. If then the draughtsman does not, and cannot hope to imitate nature, he is compelled to state only his *ideas* of it, ideas of three-dimensional form. For this reason only drawing must be treated as an art, and not as a mechanical act of getting an illusion.

It is interesting to trace in the history of an indigenous art the development of drawing that shall ultimately express ideas of three-dimensional form. Prof. Emanuel Loewy, in his *Rendering of Nature in Early Greek Art*, demonstrates how the early Greek sculpture (and that of all primitive peoples, children and ungifted artists) shows an aversion from depth. Their reliefs



(From a Greek vase in the British Museum (E. 46).)

FIG. 1.



(From *Bullentino arch. Napoli* (1863, tom. 1, tav. 7).)

FIG. 2.



(From a drawing by Michelangelo (1854, 5, 13, L), Print Room, British Museum).

FIG. 3.

and trees. If, in the drawings of masters, we should find objects darker or lighter than their position in the light would warrant, they have value (perhaps not quite a legitimate one) for balancing the composition as a flat pattern. They were never intended to suggest colour, nor do they. Yet, in spite of the failure to succeed, and contrary to logical argument and the practice of great draughtsmen, the student of most of the schools of Europe and America still persists in doing the hair dark, and, by attempting to give colour values to the clothes, breaks up the consistency of the whole. For the same reason that the sculptor uses uniformly coloured material in order that the natural light and shade may have full opportunity of making his forms manifest to the spectator, the draughtsman confines himself to giving light and shade only. If a monochrome has "colour tones," the effect is similar to that produced by a draped statue made out of variously coloured marbles—an inartistic jumble.

As the immediate purpose and content of drawing there remains the representation of form only. Drawing is, therefore, essentially the same activity as sculpture, and has no additional scope. "Pupils," says Donatello, "I give you the whole art of sculpture when I tell you to draw" (cited by Holroyd, *Michel Angelo*, p. 295), and the only practical teaching of drawing might be summed up by the inversion of the above.

Now if everything in nature—men, mountains or clouds—were as flat targets, *i.e.* two-dimensional, drawing could be legitimately reduced to a mechanical process,—to trace their contours upon a glass screen or even photograph them would be all that would be required. Indeed, provided the size of the drawing, the local colour and the texture be the same as those of the original, a complete illusion would be the result, in fact the proper end of one's labours. But the presence of the third

are of the flattest description, almost raised contours, and their figures in the round have at first only one aspect, or flat façade, so to speak, then three and four aspects, and finally at the date of Lysippus the figures are fully rounded out, and the members project at liberty in all directions. Then for the first time Greek sculpture showed a complete conception of the body's corporeity (*Körperlichkeit*). The primitive artist, however well he may be *intellectually* aware of the three dimensions of an object, does not fully apprehend its true aspect as offered to the eye from one point of view. Following this conclusion, it is easy to see also in the drawing of the early Greeks, children and so on, the same lack of idea of the third dimension. The figures on the vases of the "finest period" (about 475 B.C.), despite occasional foreshortenings, have, when considered as representations of solid forms, a papery appearance. They have not half the draughtsmanship shown by the later period of the vase industry, where the figures, though careless, stereotyped and ill-composed, come forwards (to use Prof. Loewy's description of later sculpture), go backwards, twist and turn in space in a manner which cannot be extolled. The reproductions in figs. 1, 2, 3 will illustrate the development. The primitive draughtsman is at first bound by the silhouette. Later, he desires to fill out the interior, but this cannot be done without in great part modifying his contour lines, because they are generally merely indications of the disappearing and reappearing inner modelling, *i.e.* of the figure's third dimension. Finally, the draughtsman in full possession of a feeling for the corporeity of the object will determine his contour entirely from within, a procedure which is the exact opposite to that of his first beginnings. He conceives the length, breadth and depth of an object and all its parts as solid wholes. To him a body in violent foreshortening is as easy as a simple

profile, and, though it may not be as attractive, it is perhaps more interesting because its contours are more bound up with, and dependent upon, the inner modelling; in other words, it has more depth. The draughtsman's idea of a form in nature is not a "flat idea," but one containing three dimensions. This idea he seeks to express either by line alone or by light and shade. If an artist has not a three-dimensional "grasp" of forms, and, like a child, confines himself to the primitive tracing of the silhouette, his compositions may be of excellent flat pattern, and equal to any of the designs of ancient carpets or early Greek vases; but in the light of the above argument, and when compared with the productions of mature draughtsmen of all ages and countries, they cannot be said to be complete drawings, any more than the early unifacial statues of the Greeks can be called true plastic, simply because in neither case has the artist yet reached the highest possible development of corporeal conception, by which truly to interpret the solid objects of nature as we know them, and as master draughtsmen see them.

An attempt should be made to explain the psycho-physiological process that must take place in the mind of the real draughtsman. When we look at an object in nature we know its length and breadth by the flat image on the retina; we see also the light and shade, which at once gives us a correct idea of the object's depth or relief. But we do not, nor could we, have this idea from the flat image on the retina alone, *i.e.* from the mere perception of the light and shade: our knowledge of its depth is the result of experience, *i.e.* of our having from infancy remarked a certain dispensation of light and shade on, and peculiar to, every form we have touched or traversed, and so, by association and inference, being early enabled to have ideas of the depth of things by their various arrangements of lights and darks without having to touch or traverse them. Nevertheless the act (generally, but by no means always, an unconscious one) of visually touching a form must necessarily take place before we can apprehend the third dimension of a form. It is, then, by the combination of the ideas derived from pure vision and the ideas derived from touch that we know the length, breadth and depth of a solid form. We have shown that the art of drawing is not an imitation, but an expression of the artist's ideas of form; therefore all drawing of forms that merely reproduces the image on the retina, and leaves unconsulted the ideas of touch, is incomplete and primitive, because it does not express a conception of form which is the result of an association of the two senses; in other words, it does not contain an idea of the object's relief or solidity. And all teaching of drawing that does not impress upon the student the necessity of combining the sense of vision with that of touch is erroneous, for it is thereby limiting him to a mechanical task, *viz.* the tracing of the flat image on the retina, which could be equally well done by mechanical means, or by photography alone.

In most of the schools of Europe and America it is true that great stress is laid upon the importance of giving life-like relief to

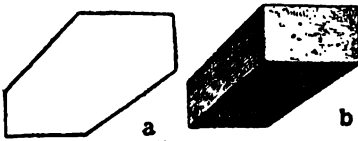

FIG. 4.

drawings, but the method by which the students are allowed to get the relief is by employing the sense of vision only. Tracing the silhouette of the figure as minutely as possible, they then fill it out with inner-modelling, which also is done by vision alone, for the lights and darks of the original are copied down as so many flat patterns fitted together and gradated like a child's puzzle, and are not used merely as indication by which to "feel" the depth of the object. Such a procedure is as if in drawing a brick of which three sides were visible, one were first to draw the entire contour (fig. 4, a), the subtle perspective of which he might get correct with some mechanical apparatus or by infinite mechanical pains, and then fill up the interior with its "shading" (fig. 4, b). The method would be plainly laborious, unintelligent

and unifying, and in drawing the most complicated foreshortened forms of the human body it would seem still more illogical. That this principle of instruction does not help the student to grasp the three-dimensional character properly can be proved by the twenty-minute studies of the average student who in his fourth year has won a gold medal for an astounding piece of life-like stippling. They are still unintelligent contour tracings, as if of cardboard figures, with a few irrelevant patches of dark here and there within the silhouette.

But high modelling that would make for illusion of reality is not the first aim of draughtsmanship, nor have the best draughtsmen employed it save by exception. Michelangelo, Ingres, Holbein and Rembrandt have shown us that it is possible to give sufficient relief with a mere outline drawing. Again, the desire for salience often blunts the student's sense of the real character of the forms he is rounding out. So his elaborately modelled portrait may look very "life-like," but when compared with the original it will generally be seen that the whole and each of the individual forms of the drawing lack the peculiar character of those of the original. It is by carefully watching for the character of each fresh variety in figure and feature that great draughtsmen have excelled, and not by "life-like" relief, or even a sophisticated exposition of anatomical details at the expense of character. Can it be seriously maintained that a masterly sudden grasp of true formal character can be developed in a student by a system in which he patiently spends many days and weeks in stippling into plastic appearance one drawing which has originally been "laid in" by a mechanical process?

It has been shown that to attempt to make an illusion of nature is neither within the power of monochrome nor has been the chief aim of draughtsmen, but that the art of drawing consists in giving a plain statement of one's ideas, be they slight or studied, of the solid forms of nature. But the question may still be asked: Why is it that a rigorously accurate and finished drawing by a student or artist with no such ideas or conception is not good drawing, containing as it must do all that can be seen in the original, missing only its complete illusion? Why, in a word, is not a photograph a work of art?

The common explanation of the above important question is that the artist "selects and eliminates from the forms of nature." But surely this is the principle of the caricaturist and virtuoso? A beautiful drawing, however slight, is but the precipitate of the whole in the artist's mind. And a highly finished drawing by a master does not show even any apparent selection or elimination. The adoption of the principle of selection to differentiate art from mechanical reproduction is fundamentally vicious, and could be shown to be wholly inapplicable to the so-called formative arts. Nor could the theory of "selection" be used as a principle of teaching, for if to the first question the pupil would make, "What am I to select?" it were answered, "Only the important things," then the next question, "What are the important things?" could be answered only by saying, "That alone the real artist knows, but cannot teach." Certainly there are important things that can be taught the student in the initial stage of "laying-in" a figure, but when to begin selecting or eliminating no teacher could tell him, simply because he must be aware that a true draughtsman can afford to eliminate nothing when the truth of the whole is at stake. The artist's conception and its expression may be slight or elaborate, but in neither case can selection or elimination take place, for a true conception must be founded upon the character of the whole, which is determined by the entire complex of all the parts.

To explain the essential difference between art and mechanical drawing or mechanical reproduction, a more applicable theory must be found. Compare the art of telling a story. If, to describe an incident in the street you had the entire affair re-enacted on the same spot, you would have but made a mechanical reproduction of it, leaving the spectator to simplify the affair, and construct his own conception of it. You have not given your ideas of the event, and so you have not made a work of art. So, if a man draws an object detail for detail by any mechanical process, or traces over its photograph, he has but reduplicated

the real aspect of the object, and has failed to give the spectator a simple and intelligible idea of it. Starting out with the generous notion of giving all, that there may be "something for everyone," he has given nothing. He did not originally form an intelligible and simplified idea of the figure, so how can his drawing be expected to give one to others?

But how can forms be made *more* simple and intelligible than by reproducing their aspect with absolute accuracy? Our combined sense of vision and touch comprehends very easily certain elementary solid forms, the sphere, the cube, the pyramid and the cylinder. No forms but these, and their modifications, can be apprehended by the mind in one and the same act of vision. Every complex form, even so simple as that of a kidney, for instance, must be first broken up into its component parts before it can be fully apprehended or remembered. Analogously with the above, Prof. Wundt has shown how the mind can apprehend *as separate units* any number, of marbles for instance, up to five, after which every number must be split up into lots of two, three, four and five, or twenties, thirties and so on, before it can realize the full content of that number in one and the same mental picture. So the only way to receive an intelligible idea of a complex form, such as a human figure, is first to discover in the figure itself, and then in all its parts, only modifications of the above elementary solid forms, and the drawing of a conception thus informed must needs be a very clear and intelligible one. The more the artist is capable and practised, the more clearly will he conceive and distinguish in nature each subtle modification of these elementary forms, their direction, their relation to, and their dependence upon one another. The only difference between a good draughtsman and a bad one is the degree of subtlety of his apprehension. Unless the draughtsman has seen some such clear forms in his original, his labour to produce a work of art will be grievous and fruitless. All good drawing is stamped with this kind of structural insight. The more the artist adheres to nature, and the more finished his drawing, the more will the lines and forms that he makes be, so to speak, *in excess* of those of nature, or dull imitation or photography. It is not to be supposed that able draughtsmen work, or need ever have worked, consciously in this manner. It is, indeed, the virtue peculiar to the artist, as interpreter of form, that he instinctively comprehends the real elemental character of complex forms, whilst the majority of people (on the showing of their own drawings) entertain but confused or *no* ideas of them. It is because a good drawing reduces the chaos of ideas supplied by the raw material of nature, to one intelligible manner of seeing it, that all lovers of nature welcome it with joy. It is this process of discovery and interpretation that marks the essential difference between art and mechanical drawing or reproduction. Art gives intelligible ideas of the forms of nature, mechanism attempts to reduplicate their aspects.

There are some who hold that drawing is not exclusively a matter of interpreting form, but that great artists have their own "personalities" which they infuse into their work. They will ask, How is it otherwise to be explained that two equally good draughtsmen will invariably make different drawings of the same figure? Is it not for the same reason that one man will divide up a row of eight marbles into groups of four, and another into five and three? The subjectivity of experience governs the different conceptions that good draughtsmen will form of the same object. Accordingly as a draughtsman feels form so will he draw it, and it is only because our sense apparatuses are more or less similarly constituted that we can understand and appreciate one another's conceptions.

But if the master draughtsman gives the true character of his model's form why is it that his drawings are not pleasing to all alike? Whence the doubts and criticism that have been called forth by all original artists? If we first examine the attitude of the average man, artist or layman, towards nature, we can better explain his attitude towards works of art. The average man or artist has not a highly developed appreciation of form *per se*, whether it be the form of natural or manufactured objects. And it would seem that he is still less a disinterested

spectator of the forms and features of his fellow beings and animals, their movements, their colour, their value in a room or landscape. He has sentimental, moral or intellectual preferences. In other words, he likes or dislikes only those faces or figures which hundreds of personal associations have taught him to like or dislike. The riding man's admiration for the look of a particular horse is based upon the fact that it looks like "a horse to go," and hence it is what he calls beautiful, while the artist, in the capacity of artist and not of sportsman, is not particular in his choice of horse-flesh, but finds each animal equally interesting for itself alone. Consequently in art any face, figure or object that does not come into the category of what the average man cares for is condemned by him even as it would be in real life, since he is no lover of form for form's sake, but provided the subject or moral be pleasing the quality of the draughtsmanship is of small account. The picture of a dwarf, or of an anatomy lesson, or of a group of ordinary bourgeois folk would not really please him, even though he were told that the work was by Velazquez, Rembrandt or Manet. We have only to listen to the common criticism of works of art to know that it is founded upon personal predilection only. We do not hear such personal criticism upon drawings of landscape, not because artists do them better, but because natural landscape has no interest for any one other than for its form, or, at least, people do not hold such definite personal likes or dislikes with regard to its various manifestations. But the artist, though his own personal predilections may, and generally do, lead him to work within that agreeable *milieu*, has, in the capacity of artist, no subjective prejudices; indeed, if he had them, he could not represent them by line, light and shade. He seeks always new varieties of form; hence his subjects, and his manner of posing them, are often unpleasing to the man who is busy with other affairs, and has no great experience of nature's forms. Let a good draughtsman make a successful likeness of the mother of some average man, and the latter will be delighted, but it by no means follows that he will delight in a drawing of the wife of the artist, though done by the same hand and with equal skill.

If drawing is the art of giving one's ideas of the forms of nature, then all criticism of drawing must be based upon the question, "How far does such and such a work show an intimate knowledge of or intelligent visualization of the forms we know in nature?" and no other principle of judgment can be applicable to all drawing alike. Hence only those who have by natural endowment a clear sense of the forms of things, and who have made more than ordinary study of them, are in a position to apply to drawings the above criterion with any approach to infallibility. It is a fact that there are, and always have been, a certain number of people who agree perfectly in their appreciation of the works of certain draughtsmen of different times and countries, and who can state reasons for their appreciation in definite and almost identical terms, for it is based upon knowledge and experience. To such people all fine draughtsmanship owes its public fame, and its immortality lies in their safe keeping.

It may be argued, that each has a right to his own opinion about form and its representation, on the supposed ground that we all see form in different ways. But there is a fallacy in this argument. If we take the average man's drawing of any form more complex than a loaf of bread as a fair and only testimony of his power of visualization of forms, we must conclude that most of us see not differently, but *wrongly*, or rather confusedly and disconnectedly, and that some can visualize form scarcely at all. If this be true, the average person's sight and ability to judge drawing is seriously diminished. If, then, drawing can be judged and appreciated only by knowledge and experience of the forms of nature, no critical formula could be made out so as to enable a child or savage or ordinary civilized adult to estimate or enjoy it. If it be argued that drawings are to be judged from some abstract or symbolic point of view, independently of its subtle representation of form, then incompetent drawing might be as beautiful as the competent, which would be absurd. However, if the competent characterization of form were admitted as at least the first condition of beautiful drawing, it would follow

that any abstract value it might have must be wholly dependent upon the manner in which form is represented, and so it would be superfluous to judge it by any standard other than the direct, definite and concrete one of form. Abstract beauty, since no one has yet defined it agreeably to all, is, apparently, with those who affect a feeling for it, a matter of individual taste, and therefore cannot be questioned. But the clear visualization of the forms of nature is based upon a special endowment and knowledge, and can be criticized by demonstration. People may differ in their tastes, but they may not, nor do they, differ upon questions of real knowledge. Drawing, as the activity of giving one's ideas of form, must therefore be judged not by taste but by knowledge.

In view of the purpose and content of drawing as here demonstrated, there is no other principle of judgment that is relevant. Yet we often hear drawing judged by criteria which are founded upon no such concrete base but upon certain vague abstractions; or, again, upon a literary or moral base which could be applicable only to symbolic art.

It is said that this or that draughtsman excels in "beauty of line." Now in spite of the labours of many painters and theorists, it cannot reasonably be held that one purely abstract line or curve is more beautiful than another, for the simple reason that people have no common ground upon which to establish the nature of abstract beauty. It may be, however, that even as certain simple forms are more easily apprehended than complex ones, there is the same distinction with regard to lines. If then an artist of clean vision sees in an object of reality such clear characteristic lines, he draws them not for their abstract beauty, but merely because by them alone can he express his idea of the form before him. The early Greek vase painters, and all great artists of primitive periods, being attracted only by the silhouette, became very subtle to observe nature's outlines in their most intelligible character, and to this capacity is due their "beauty of line," and not to any preconceived notion of an abstract line of perfect beauty, and nowhere will "beauty of line" be found on Greek vases, or elsewhere, that is not informed by, and does not express, a fine conception of nature's contours. So too in later three-dimensional drawing there is no beauty of line which does not intelligibly express not only the directions and angles of the main contour, but the inner modelling, *i.e.* the relief of the figure. It is only a superficial judgment that would prefer one drawing to another, even if both may be equally good, because the line of one is neat and the other "tormented." Contour being *in nature* an ideal line between one form and another, it is illogical to treat it or criticize it in a *drawing* as an actual and specific thing, apart from the forms that make it and are made by it. If an artist drew a dragon with deliberate disregard for animal construction, his drawing would be silly, and only by a profound knowledge of the forms of nature could it be made to have beautiful lines. Truth to nature is always originality, and it is the only originality worth the name.

Again, some people judge one drawing as better than another in that it shows more "individuality" or "temperament." Now a man's individuality is, presumably, a vague feeling in our minds produced by the net result of the ways in which he sees, hears, loves, thinks and so on, so that we could not tell a man's individuality from any single one of his manifestations. With his entire work as an artist before us, *i.e.* his manner of seeing, we could do no more than infer, with the help of outside data, from the subjects he chooses, and the neatness or boldness of his line, something about his general character, and that with small degree of certainty. To regard a man's works of art, or indeed any of his manifestations, from this point of view, is, after all, nothing but a kind of inquisitive chremomyancy. Those who pretend to like the drawings of Watteau or Michelangelo "because they show more individuality" than the incompetent work of a beginner or poor artist cannot be skilled in their own business, because the lady who tells your character by your handwriting finds as much individuality in bad writing as in good,—sometimes even more. It may be entertaining to some to guess at the artist's character from his works by this process of inference

and comparison, but it is unreasonable to imagine that "individuality," as such, can be made a serious criterion of aesthetic judgment. The only individuality a draughtsman can show directly by his drawing is his individual way of conceiving the forms of nature, and even this is immaterial provided the conception and drawing be good.

A word or two are necessary upon "style," which unfortunate word has made much mystery in criticism. The great draughtsmen of every time and country are known by their own words, as well as their works, to have been infinitely respectful to the form of every detail in nature. Their drawings always recall to our minds reality as we ourselves have seen it (provided we have studied from nature and not from pictures). The drawing of a hand, for instance, by Hokusai, Ingres or Dürer, revives in us our own impressions of the forms and aspects of real hands. In short there is manifest in all good drawings, whatever their difference of medium or superficial appearance, an entire dependence upon the forms of nature. Hence we cannot imagine that they were conceived and executed with the conscious effort to obtain some abstract style independent of the material treated. The style they plainly have can spring from this common quality, their truthful and well understood representation of forms. Style, then, is the expression of a clear understanding of the material from which the artist works. Unless a drawing shows this understanding it would be as impossible as it would be gratuitous to argue that it could have style. But it would seem that some people mean by style nothing more than the mere superficial appearance of the work. They would have a draughtsman draw "in the style of Holbein," but not "in the style" of Rembrandt. This kind of preference, as remarked above, is superficial, for it overlooks the main issue and purpose of drawing, *viz.* the representation, by any means whatever, of the artist's ideas of form. It is as though one should prefer a letter from Holbein to one from Rembrandt, though both were equally expressive, simply because Holbein's handwriting was prettier than Rembrandt's. Each draughtsman manifests a kind of handwriting peculiar to himself even in his most faithful rendering of form; and by this we can immediately recognize the artist; many, for instance Hogarth and some Japanese, seem to have let their quirks, full stops and so on, get the upper hand at the expense of serious, sensitive draughtsmanship.

It is fair to suppose that all abstract principles of aesthetic judgment, such as beauty of line, personality, style, nobility of thought, romanticism, are merely pretexts set up by people who would still affect to admire the drawings of recognized masters when they have neither the knowledge of, nor the care for, the forms of nature by virtue of which alone these drawings are what they are, and by which alone they can be immediately appreciated.

(J. R. F. O.)

Drawing-Office Work.—In modern engineering, few pieces of mechanism are ever produced in the shops until their design has been settled in the "drawing office," and embodied in suitable drawings showing general and detailed views. This is a broad statement to which there are exceptions, to be noted presently.

Drawing-office work is divisible into four principal groups. First, there is the actual designing, by far the most difficult work, which is confined to relatively few well-paid men. The qualifications necessary for it are a good scientific, mathematical and engineering training, and a specialized experience gathered in the particular class of mechanism to which the designing relates. Second, there is the work of the rank and file who take instructions from the chiefs, and elaborate the smaller details and complete the drawings. Third, there are the tracers, either youths or girls, who copy drawings on tracing paper without necessarily understanding them. Fourth, there is a printing department in which phototypes are produced on sensitized paper from tracings.

The character of the drawings used includes the general drawings, or those which show a mechanism complete; and the detailed drawings, which illustrate portions isolated from their connexions and relationships. The first are retained in the office

for reference, and copies are only sent out to the men who have to assemble or erect and complete mechanisms. The second are distributed to the several shops and departments where sectional portions are being prepared, as pattern shop, smithy, turnery, machine shop, &c. General drawings are, as a rule, drawn to a small scale, ranging say from $\frac{1}{4}$ in. to 1 in. to the foot; but details are either to actual size, or to a large scale, as from $1\frac{1}{2}$ in. to the foot or 3 in. or 6 in. to the foot.

A large number of minutiae are omitted from general drawings, but in the detailed ones that are sent into the shops nothing is apparently too trivial for insertion. In this respect, however, there is much difference observable in the practice of different firms, and in the best practice of the present compared with that of former years. In the detailed drawings issued by many firms now, every tiny element and section is not only drawn to actual size, but also fully dimensioned, and the material to be used is specified in every case. This practice largely adds to the work of the drawing-office staff, but it pays.

The present tendency therefore is to throw more responsibility than of old on the drawing-office staff, in harmony with the tendency towards greater centralization of authority. Much of detail that was formerly left to the decision of foremen and skilled hands is now determined by the drawing-office staff. Heterogeneity in details is thus avoided, and the drawings reflect accurately and fully the past as well as the present practice of the firm. To so great an extent is this the case that the preparation of the tools, appliances, templets, jigs and fixtures used in the shops is often now not permitted to be undertaken until proper drawings have been prepared for them, though formerly the foreman's own hand sketches generally sufficed. The practice of turret work has been contributory to this result. In many establishments now the designing of shop tools and fixtures is done in a department of the office specially set apart for that kind of work.

The growing specialization of the engineer's work is reflected in the drawing office. Specialists are sought after, and receive the highest rates of pay. A man is required to be an expert in some one branch, as electric cranes or hydraulic machines, steel works plant, lathes, or heavy or light machine tools. The days are past in which all-round men were in request. In those firms which manufacture a large range of machinery, the drawing-office staff is separated into departments, each under its own chief, and there is seldom any transference of men from one to another.

Although in the majority of instances designs and drawings are completed before the manufacture is undertaken, exceptions to this rule occur in connexion with the work of standardizing machines and motors, for repetitive and interchangeable manufacture on a large scale. Here it is so essential to secure the most minute economies in manufacture that the first articles made are of a more or less experimental character. Only after no further improvement seems for the time being possible are the drawings made or completed for standard use and reference. In some modern shops even standardized drawings are scarcely used, but their place is taken by the templets, jigs and fixtures which are employed by the workmen as their sole guides in machining and assembling parts. By the employment of these aids locations and dimensions are embodied and fixed absolutely for any number of similar parts; reference to drawings thus becomes unnecessary, and they therefore fall into disuse.

The mechanical work of the drawing office is confined strictly to orthographic projections and sections of objects. Perspective views are of no value, though occasionally an object is sketched roughly in perspective as an aid to the rapid grasp of an idea. Drawings involve plans, elevations, and sectional views, in vertical and angular relations.

There are a good many conventionalities adopted which have no correspondences in fact, with the object of saving the draughtsman's time; or else, as in the case of superposition of plans and sections, to show in one view what would otherwise require two drawings. Among the convenient conventionalities are the indications of toothed wheels by their pitch lines only, of screws

by parallel lines and by diagonal shade lines; and of rivets, bolts and studs by their centres only. The adoption of this practice never leads to error.

In the preliminary preparation of drawings in pencil no distinction is made between full or unbroken lines, and dotted or centre lines, and the actual outlines of the objects. These differences are made when the inking-in is being done. Indian or Chinese ink is used, because it does not run when colours are applied. There are conventional colours used to indicate different materials. But colouring is not adopted so much as formerly, because of the practice of making sun prints instead of the more expensive tracings for the multiplication of drawings. When tracings are coloured the colour is applied on the back instead of on the side where the ink lines are drawn.

The economical importance of the printing department of the drawing office cannot be overestimated. Before its introduction drawings could only be reproduced by laborious tracing on paper or cloth, the first being flimsy, the second especially liable to absorb grease from the hands of the workmen. By the sun copying processes (see *SUN COPYING*) any number of prints can be taken from a single tracing. But even the fickle sun is being displaced by electricity, so that prints can be made by night as well as day, on cloudy days as well as on bright ones. Twenty minutes of bright sunshine is required for a print, but the electric light produces the same result within five minutes. Prints are blue, white or brown. The advantage of white is that they can be coloured. But the majority are blue (white lines on blue ground). All can be had on stout, thin or medium paper.

An innovation in drawing-office equipment is that of vertical boards, displacing horizontal or sloping ones. They have the advantage that the draughtsman is able to avoid a bending posture at his work. The objection on the ground that the tea-square must be held up constantly with one hand is overcome by supporting and balancing it with cords and weights. (J. G. H.)

DRAWING AND QUARTERING, part of the penalty anciently ordained in England for treason. Until 1870 the full punishment for the crime was that the culprit be dragged on a hurdle to the place of execution; that he be hanged by the neck but not till he was dead; that he should be disembowelled or drawn and his entrails burned before his eyes; that his head be cut off and his body divided into four parts or quartered. This brutal penalty was first inflicted in 1284 on the Welsh prince David, and on Sir William Wallace a few years later. In Richard III.'s reign one Collingbourne, for writing the famous couplet "The Cat, the Rat and Lovel the Dog, Rule all England under the Hog," was executed on Tower Hill. Stow says, "After having been hanged, he was cut down immediately and his entrails were then extracted and thrown into the fire, and all this was so speedily done that when the executioners pulled out his heart he spoke and said 'Jesus, Jesus.'" Edward Marcus Despard and his six accomplices were in 1803 hanged, drawn and quartered for conspiring to assassinate George III. The sentence was last passed (though not carried out) upon the Fenians Burke and O'Brien in 1867. There is a tradition that Harrison the regicide, after being disembowelled, rose and boxed the ears of the executioner.

DRAWING-ROOM (a shortened form of "with-drawing room," the longer form being usual in the 16th and 17th centuries), the English name generally employed for a room used in a dwelling-house for the reception of company. It originated in the setting apart of such a room, as the more private and exclusive preserve of the ladies of the household, to which they withdrew from the dining-room. The term "drawing-room" is also used in a special sense of the formal receptions or "courts" held by the British sovereign or his representative, at which ladies are presented, as distinguished from a "levee," at which men are presented.

DRAYTON, MICHAEL (1563-1637), English poet, was born at Hartshill, near Atherstone, in Warwickshire in 1563. Even in childhood it was his great ambition to excel in writing verses. At the age of ten he was sent as page into some great family, and a little later he is supposed to have studied for some time at Oxford. Sir Henry Goodere of Powlesworth became his patron, and introduced him to the countess of Bedford, and for

several years he was esquire to Sir Walter Aston. How the early part of his life was spent, however, we possess no means of ascertaining. It has been surmised that he served in the army abroad. In 1590 he seems to have come up to London, and to have settled there.

In 1591 he produced his first book, *The Harmony of the Church*, a volume of spiritual poems, dedicated to Lady Devereux. The best piece in this is a version of the Song of Solomon, executed with considerable richness of expression. A singular and now incomprehensible fate befell the book; with the exception of forty copies, seized by the archbishop of Canterbury, the whole edition was destroyed by public order. It is probable that he had come up to town laden with poetic writings, for he published a vast amount within the next few years. In 1593 appeared *Idea: The Shepherd's Garland*, a collection of nine pastorals, in which he celebrated his own love-sorrows under the poetic name of Rowland. The circumstances of this passion appear more distinctly in the cycle of 64 sonnets, published in 1594, under the title of *Idea's Mirror*, by which we learn that the lady lived by the river Anker in Warwickshire. It appears that he failed to win his "Idea," and lived and died a bachelor. In 1593 appeared the first of Drayton's historical poems, *The Legend of Piers Gaveston*, and the next year saw the publication of *Malinda*, an epical poem in rhyme royal. It was about this time, too, that he brought out *Endimion and Phoebe*, a volume which he never republished, but which contains some interesting autobiographical matter, and acknowledgments of literary help from Lodge, if not from Spenser and Daniel also. In his *Fig for Momus*, Lodge has reciprocated these friendly courtesies. In 1596 Drayton published his long and important poem of *Mortimerades*, which deals with the Wars of the Roses, and is a very serious production in *ottava rima*. He afterwards enlarged and modified this poem, and republished it in 1603 under the title of *The Barons' Wars*. In 1596 also appeared another historical poem, *The Legend of Robert, Duke of Normandy*, with which *Piers Gaveston* was reprinted. In 1597 appeared *England's Heroical Epistles*, a series of historical studies, in imitation of those of Ovid. These last poems, written in the heroic couplet, contain some of the finest passages in Drayton's writings.

With the year 1597 the first half of the poet's literary life closes. He had become famous by this rapid production of volumes, and he rested on his oars. It would seem that he was much favoured at the court of Elizabeth, and he hoped that it would be the same with her successor. But when, in 1603, he addressed a poem of compliment to James I., on his accession, it was ridiculed, and his services rudely rejected. His bitterness of spirit found expression in a satire, *The Owl*, which he printed in 1604, although he had no talent in this kind of composition. Not much more entertaining was his scriptural narrative of *Moses in a Map of his Miracles*, a sort of epic in heroics printed the same year. In 1605 Drayton reprinted his most important works, that is to say, his historical poems and the *Idea*, in a single volume which ran through eight editions during his lifetime. He also collected his smaller pieces, hitherto unedited, in a volume undated, but probably published in 1605, under the title of *Poems Lyric and Pastoral*; these consisted of odes, eclogues, and a fantastic satire called *The Man in the Moon*. Some of the odes are extremely spirited. In this volume he printed for the first time the famous *Ballad of Agincourt*.

He had adopted as early as 1598 the extraordinary resolution of celebrating all the points of topographical or antiquarian interest in the island of Great Britain, and on this laborious work he was engaged for many years. At last, in 1613, the first part of this vast work was published under the title of *Poly-Olbion*, eighteen books being produced, to which the learned Selden supplied notes. The success of this great work, which has since become so famous, was very small at first, and not until 1622 did Drayton succeed in finding a publisher willing to undertake the risk of bringing out twelve more books in a second part. This completed the survey of England, and the poet, who had hoped "to crown Scotland with flowers," and arrive at last at the Orcaades, never crossed the Tweed. In 1627 he published

another of his miscellaneous volumes, and this contains some of his most characteristic and exquisite writing. It consists of the following pieces: *The Ballad of Agincourt*, an historical poem in *ottava rima* (not to be confused with his ballad on the same subject), and *The Miseries of Queen Margara*, written in the same verse and manner; *Nymphidia, the Court of Faery*, a most joyous and graceful little epic of fairyland; *The Quest of Cynthia* and *The Shepherd's Sirena*, two lyrical pastorals; and finally *The Moon Calf*, a sort of satire. Of these *Nymphidia* is perhaps the best thing Drayton ever wrote, except his famous ballad on the battle of Agincourt; it is quite unique of its kind and full of rare fantastic fancy.

The last of Drayton's voluminous publications was *The Muses' Elizium* in 1630. He died in London on the 23rd of December 1631, was buried in Westminster Abbey, and had a monument placed over him by the countess of Dorset, with memorial lines attributed to Ben Jonson. Of the particulars of Drayton's life we know almost nothing but what he himself tells us; he enjoyed the friendship of some of the best men of the age. He corresponded familiarly with Drummond; Ben Jonson, William Browne, George Wither and others were among his friends. There is a tradition that he was a friend of Shakespeare, supported by a statement of John Ward, once vicar of Stratford-on-Avon, that "Shakespeare, Drayton and Ben Jonson had a merry meeting, and it seems, drank too hard, for Shakespeare died of a feavour there contracted." In one of his poems, an "elegy" or epistle to Mr Henry Reynolds, he has left some valuable criticisms on poets whom he had known. He was even engaged in the labour of the dramatists; at least he had a share, with Munday, Chettle and Wilson, in writing *Sir John Oldcastle*, which was printed in 1600. That he was a restless and discontented, as well as a worthy, man may be gathered from his own admissions.

The works of Drayton are bulky, and, in spite of the high place that he holds in critical esteem, it cannot be pretended that he is much read. For this his ponderous style is much to blame. The *Poly-Olbion*, the most famous but far from the most successful of his writings, is tedious and barren in the extreme. It was, he tells us, a "Herculean toil" to him to compose it, and we are conscious of the effort. The metre in which it is composed, a couplet of alexandrines, like the French classical measure, is wholly unsuited to the English language, and becomes excessively wearisome to the reader, who forgets the learning and ingenuity of the poet in labouring through the harsh and overgrown lines. His historical poems, which he was constantly re-writing and improving, are much more interesting, and often rise to a true poetic eloquence. His pastorals are brilliant, but overladen with colour and sweet to insipidity. He is, with the one magnificent exception of "Since there's no help, come let us kiss and part," which was first printed in 1619, an indifferent sonneteer. The poet with whom it is most natural to compare him is Daniel; he is more rough and vigorous, more varied and more daring than the latter, but Daniel surpasses him in grace, delicacy and judgment. In their elegies and epistles, however, the two writers frequently resemble each other. Drayton, however, approaches the very first poets of the Elizabethan era in his charming *Nymphidia*, a poem which inspired Herrick with his sweet fairy fancies and stands alone of its kind in English literature; while some of his odes and lyrics are inspired by noble feeling and virile imagination.

In 1748 a folio edition of Drayton's complete works was published under the editorial supervision of William Oldys, and again in 1753 there appeared an issue in four volumes. But these were very unintelligently and inaccurately prepared. A complete edition of Drayton's works with variant readings was projected by Richard Hooper in 1876, but was never carried to a conclusion; a volume of selections, edited by A. H. Bullen, appeared in 1883. See especially Oliver Elton, *Michael Drayton* (1906). (E. G.)

DREAM (from a root *dreug*, connected with Germ. *trügen*, to deceive), the state of consciousness during sleep; it may also be defined as a hallucination or illusion peculiarly associated with the condition of sleep, but not necessarily confined to that state. In sleep the withdrawal of the mind from the external

world is more complete and the objectivity of the dream images is usually unquestioned, whereas in the waking state the hallucination is usually recognized as such; we may, however, be conscious that we are dreaming, and thus in a measure be aware of the hallucinatory character of our percepts. The physiological nature of sleep (*q.v.*; see also **MUSCLE AND NERVE**) and of dreaming is obscure. As a rule the control over the voluntary muscles in dreams is slight; the sleep-walker is the exception and not the rule, and the motor activity represented in the dream is seldom realized in practice, largely, no doubt, because we are ignorant, under these circumstances, of the spatial relations of our bodies. Among the psychological problems raised by dreams are the condition of attention, which is variously regarded as altogether absent or as fixed, the extent of mental control, and the relation of ideas and motor impulses. There is present in all dreams a certain amount of dissociation of consciousness, or of obstructed association, which may manifest itself in the preliminary stage of drowsiness by such phenomena as the apparent transformation or inversion of the words of a book. We may distinguish two types of dreams, (a) representative or centrally initiated, (b) presentative or due to the stimulation of the end organs of sense. In both cases, the dream having once been initiated, we are concerned with a process of reasoning, *i.e.* the combination of ideas suggested by resemblances or other associative elements. The false reasoning of dreams is due in the first place to the absence, to a large extent, of the memory elements on which our ordinary reasoning depends, and, secondly, to the absence of sensory elements.

Objectivity of Dreams.—In waking life we distinguish ideas or mental images from real objects by the fact that we are able under normal circumstances to dismiss the former at will. In sleep, on the other hand, we have, in the first place, no real objects with which to compare the images, which therefore take on a character of reality comparable to the hallucination of waking life; moreover, powers of visualization and other faculties are enhanced in sleep, so that the strength of dream images considerably exceeds those of the mental images of the ordinary man; changes in powers of attention, volition and memory help to increase the hallucinatory force of the dream. In the second place, the ideas of our dreams are presented in the form of images, which we are unable to dismiss; we therefore mistake them for realities, exactly as the sufferer from delirium tremens in waking life is apt to regard his phantoms as real.

Relations of Dreaming and Sleep.—It has been maintained by Hamilton and others (see below, *Modern Views*) that dreams invariably accompany sleep, and that we always find ourselves dreaming when we are awakened. But even if it were true that dreams were invariably experienced at the moment of waking, this would not by any means establish the invariable concomitance of dreams and sleep of all sorts; at most it would show that imperfect sleep is a condition of dreaming; in the same way, dreams before waking, known to have taken place either from the recollection of the dreamer or from the observation of another person, may clearly be due to imperfect waking, followed by a deepening of sleep. It is, however, by no means true that awakening from sleep is invariably accompanied by a dream; in considering the question it must be recollected that it is complicated by the common experience of very rapid forgetfulness of even a vivid and complicated dream, only the fact of having dreamt remaining in the memory; it is clear that amnesia may go so far that even the fact of dreaming may be forgotten. On the whole, however, there appear to be no good grounds for the assertion that we always dream when we are asleep. On the other hand, there is no proof that partial awakening is a necessary condition of dreaming.

Representative Dreams.—Centrally initiated dreams may be due to a kind of automatic excitation of the cerebral regions, especially in the case of those clearly arising from the occupations or sensations of the day or the hours immediately preceding the dream. To the same cause we may attribute the recalling of images apparently long since forgotten. Some of these revivals of memory may be due to the fact that links of association which

are insufficient to restore an idea to consciousness in the waking state may suffice to do so in sleep. Just as a good visualizer in his waking moments may call up an object never clearly seen and yet distinguish the parts, so in sleep, as L. F. A. Maury (1817-1892) and others have shown, an image may be more distinct in a dream than it was when originally presented (see also below, *Memory*).

Presentative Dreams.—The dreams due to real sensations, more or less metamorphosed, may arise (a) from the states of the internal organs, (b) from muscular states, (c) from subjective sensations due to the circulation, &c., or (d) from the ordinary cause of the action of external stimuli on the organs of sense.

(a) The state of the stomach, heart, &c., has long been recognized as important in the causation of dreams (see below, *Classical Views*). The common sensation of flying seems to be due in many cases to the disturbance of these organs setting up sensations resembling those felt in rapidly ascending or descending, as in a swing or a lift. Indigestion is a frequent cause of nightmare—the term given to oppressive and horrible dreams—and bodily discomfort is sometimes translated into the moral region, giving rise to the dream that a murder has been committed.

(b) Dreams of flying, &c., have also been attributed to the condition of the muscles during sleep; W. Wundt remarks that the movements of the body, such as breathing, extensions of the limbs and so on, must give rise to dream fancies; the awkward position of the limbs may also excite images. (c) Especially important, probably, for the dreams of the early part of the night are the retinal conditions to which are due the *illusions hypnagogiques* of the preliminary drowsy stage; but probably Ladd goes too far in maintaining that entoptic stimuli, either intra- or extra-organic in origin, condition all dreams. *Illusions hypnagogiques*, termed popularly “faces in the dark,” of which Maury has given a full account, are the not uncommon sensations experienced, usually visual and seen with both open and closed eyes, in the interval between retiring to rest and actually falling asleep; they are comparable to the crystal-gazing visions of waking moments; though mainly visual they may also affect other senses. Besides the eye the ear may supply material for dreams, when the circulation of the blood suggests rushing waters or similar ideas. (d) It is a matter of common observation that the temperature of the surface of the body determines in many cases the character of the dreams, the real circumstances, as might be expected from the general character of the dream state, being exaggerated. In the same way the pressure of bed-clothes, obstruction of the supply of air, &c., may serve as the starting-point of dreams. The common dream of being unclothed may perhaps be due to this cause, the sensations associated with clothing being absent or so far modified as to be unrecognizable. In the same way the absence of foot-gear may account for some dreams of flying. It is possible to test the influence of external stimuli by direct experiment; Maury made a number of trials with the aid of an assistant.

Rapidity of Dreams.—It has often been asserted that we dream with extreme rapidity; but this statement is by no means borne out by experiment. In a trial recorded by J. Clavière the beginning of the dream was accurately fixed by the sounding of an alarm clock, which rang, then was silent for 22 seconds, and then began to ring continuously; the dream scene was in a theatre, and he found by actual trial that the time required in ordinary life for the performance of the scenes during the interval of silence was about the same as in ordinary life. Spontaneous dreams seem to show a different state of things; it must be remembered that (1) dreams are commonly a succession of images, the number of which cannot be legitimately compared with the number of extra-organic stimuli which would correspond to them in ordinary life; the real comparison is with mental images; and (2) the rapidity of association varies enormously in ordinary waking life. No proof, therefore, that some dreams are slow can show that this mentation in others is not extremely rapid. The most commonly quoted case is one of Maury's; a bed-pole fell on his neck, and (so it is stated)

he dreamt of the French Revolution, the scenes culminating in the fall of the guillotine on his neck; this has been held to show that (1) dreams are extremely rapid; and (2) we construct a dream story leading up to the external stimulus which is assumed to have originated the dream. But Maury's dream was not recorded till many years after it had occurred; there is nothing to show that the dream, in this as in other similar cases, was not in progress when the bed-pole fell, which thus by mere coincidence would have intervened at the psychological moment; Maury's memory on waking may have been to some extent hallucinatory. But there are records of waking states, not necessarily abnormal, in which time-perception is disturbed and brief incidents seem interminably long; on the other hand, it appears from the experiences of persons recovered from drowning that there is great rapidity of ideation before the extinction of consciousness; the same rapidity of thought has been observed in a fall from a bicycle.

Reason in Dreams.—Studies of dreams of normal individuals based on large collections of instances are singularly few in number; such as there are indicate great variations in the source of dream thoughts and images, in the coherence of the dream, and in the powers of memory. In ordinary life attention dominates the images presented; in dreams heterogeneous and disconnected elements are often combined; a resemblance need not even have been consciously recognized for the mind to combine two impressions in a dream; for example, an aching tooth may (according to the dream) be extracted, and found to resemble rocks on the sea-shore, which had not struck the waking mind as in any way like teeth. Incongruence and incoherence are not, however, a necessary characteristic of dreams, and individuals are found whose dream ideas and scenes show a power of reasoning and orderliness equal to that of a scene imagined or experienced in ordinary life. In some cases the reasoning power may attain a higher level than that of the ordinary conscious life. In a well-authenticated case Professor Hilprecht was able in a dream to solve a difficulty connected with two Babylonian inscriptions, which had not previously been recognized as complementary to each other; a point of peculiar interest is the dramatic form in which the information came to him—an old Babylonian priest appeared in his dream and gave him the clue to the problem (see also below, *Personality*).

Memory in Dreams.—Although prima facie the dream memory is fragmentary and far less complete than the waking memory, it is by no means uncommon to find a revival in sleep of early, apparently quite forgotten, experiences: more striking is the recollection in dreams of matters never supraliminally (see **SUBLIMINAL SELF**) apperceived at all.

The relation between the memory in dreams and in the hypnotic trance is curious: suggestions given in the trance may be accepted and then forgotten or never remembered in ordinary life; this does not prevent them from reappearing occasionally in dreams; conversely dreams forgotten in ordinary life may be remembered in the hypnotic trance. These dream memories of other states of consciousness suggest that dreams are sometimes the product of a deeper stratum of the personality than comes into play in ordinary waking life. It must be remembered in this connexion that we judge of our dream consciousness by our waking recollections, not directly, and our recollection of our dreams is extraordinarily fragmentary; we do not know how far our dream memory really extends. Connected with memory of other states is the question of memory in dreams of previous dream states; occasionally a separate chain of memory, analogous to a secondary personality, seems to be formed. We may be also conscious that we have been dreaming, and subsequently, without intermediate waking, relate as a dream the dream previously experienced. In spite of the irrationality of dreams in general, it by no means follows that the earlier and later portions of a dream do not cohere; we may interpolate an episode and again take up the first motive, exactly as happens in real life. The strength of the dream memory is shown by the recurrence of images in dreams; a picture, the page of a book, or other image may be reproduced before our eyes several times

in the course of a dream without the slightest alteration, although the waking consciousness would be quite incapable of such a feat of visualizing. In this connexion may be mentioned the phenomenon of redreaming; the same dream may recur either on the same or on different nights; this seems to be in many cases pathological or due to drugs, but may also occur under normal conditions.

Personality.—As a rule the personality of the dreamer is unchanged; but it also happens that the confusion of identity observed with regard to other objects embraces the dreamer himself; he imagines himself to be some one else; he is alternately actor and observer; he may see himself playing a part or may divest himself of his body and wander incorporeally. Ordinary dreams, however, do not go beyond a splitting of personality; we hold conversations, and are intensely surprised at the utterances of a dream figure, which, however, is merely an *alter ego*. As in the case of Hilprecht (see above) the information given by another part of the personality may not only appear but actually be novel.

Supernormal Dreams.—In addition to dreams in which there is a revival of memory or a rise into consciousness of facts previously only subliminally cognized, a certain number of dreams are on record in which telepathy (*q.v.*) seems to play a part; much of the evidence is, however, discounted by the possibility of hallucinatory memory. Another class of dreams (prodromic) is that in which the abnormal bodily states of the dreamer are brought to his knowledge in sleep, sometimes in a symbolical form; thus a dream of battle or sanguinary conflict may presage a haemorrhage. The increased power of suggestion which is the normal accompaniment of the hypnotic trance may make its appearance in dreams, and exercise either a curative influence or act capriciously in producing hysteria and the tropic changes known as "stigmata." We may meet with various forms of hyperaesthesia in dreams; quite apart from the recovery of sight by those who have lost it wholly or in part (see below, *Dreams of the Blind*), we find that the powers of the senses may undergo an intensification, and, *e.g.*, the power of appreciating music be enormously enhanced in persons usually indifferent to it. Mention must also be made of the experience of R. L. Stevenson, who tells in *Across the Plains* how by self-suggestion he was able to secure from his dreams the motives of some of his best romances.

Voluntary Action in Dreams.—Connected with dreams voluntarily influenced is the question of how far dreams once initiated are modifiable at the will of the dreamer. Some few observers, like F. W. H. Myers and Dr F. van Eeden, record that they can at longer or shorter intervals control their actions in their dreams, though usually to a less extent than their imagined actions in waking life. Dr van Eeden, for example, tells us that he has what he calls a "clear dream" once a month and is able to predetermine what he will do when he becomes aware that he is dreaming.

Dreams of Children.—Opinions differ widely as to the age at which children begin to dream; G. Compayré maintains that dreaming has been observed in the fourth month, but reflex action is always a possible explanation of the observed facts. S. de Sanctis found that in boys of eleven only one out of eight said that he dreamt seldom, as against four out of seven at the age of six; but we cannot exclude the possibility that dreams were frequent but forgotten. If correct, the observation suggests that dreams appear comparatively late. Individual cases of dreaming, or possibly of waking hallucination, are known as early as the age of two and a half years; according to de Sanctis dreams occur before the fifth year, but are seldom remembered; as a rule the conscious dream age begins with the fourth year; speech or movement, however, in earlier years, though they may be attributed to reflex action, are more probably due to dreams.

Dreams of the Old.—In normal individuals above the age of sixty-five de Sanctis found dreams were rare; atmospheric influences seem to be important elements in causing them; memory of them is weak; they are emotionally poor, and deal with long past scenes.

Dreams of Adults.—Any attempt to record or influence our dreams may be complicated by (a) direct suggestion, leading to the production of the phenomena for which we are looking, and (b) indirect suggestion leading to the more lively recollection of dreams in general and of certain dreams in particular. Consequently it cannot be assumed that the facts thus ascertained represent the normal conditions. According to F. Heerwagen's statistics women sleep more lightly and dream more than men; the frequency of dreams is proportional to their vividness; women who dream sleep longer than those who do not; dreams tend to become less frequent with advancing age. The total number of remembered dreams varies considerably with different observers, some attaining an average of ten per night. The senses mainly active in dreams are, according to one set of experiments, vision in 60%, hearing in 5%, taste in 3%, and smell in 1.5%, where the dreamers had looked at coloured papers before falling asleep; when taste or smell had been stimulated, the visual dreams fell to about 50%, and the sense stimulated was active twice as often as it would otherwise be; dreams in which motion was a prominent feature were 10% of the former class, 14% and 18% of the two latter. Experiments by J. Mourly Vold show even more distinctly the influence of suggestion both as to the form, visual or otherwise, and the content (colours and forms of objects) of dreams. According to most observers dreams are most vivid and frequent between the ages of 20 and 25, but H. Maudsley puts the maximum between 30 and 35. De Sanctis got replies from 165 men and 55 women: the proportion between the sexes closely agrees with the results attained by Heerwagen and M. W. Calkins; 13% of men and 33% of women said they always dreamt, 27% and 45% often, 50% and 13% rarely, and the remainder (precisely the same percentage for men and women—9.09) either did not dream or did not remember that they dreamt. Nearly twice as many women as men had vivid dreams; in the matter of complication of the dream experiences the sexes are about equal; daily life supplies more material in the dreams of men; nearly twice as many women as men remember their dreams clearly, a fact which hangs together to some extent with the vividness of the dreams, though it by no means follows that a vivid dream is well remembered. There are great variations in the emotional character of dreams; some observers report twice as many unpleasant dreams as the reverse; in other cases the emotions seem to be absent; others again have none but pleasing dreams. Individual experience also varies very largely as to the time when most dreams are experienced; in some cases the great majority are subsequent to 6.30 A.M.; others find that quite half occur before 4.0 A.M.

Dreams of the Neuropathic, Insane, Idiots, &c.—Much attention has been given to the dreams of hysterical subjects. It appears that their dreams are specially liable to exercise an influence over their waking life, perhaps because they do not distinguish them, any more than their waking hallucinations, from reality. P. Janet maintains that the cause of hysteria may be sought in a dream. The dreams of the hysterical have a tendency to recur. Epileptic subjects dream less than the hysterical, and their dreams are seldom of a terrifying nature; certain dreams seem to take the place of an epileptic attack. Dreaming seems to be rare in idiots. De Sanctis divides paranoiacs into three classes: (a) those with systematized delusions, (b) those with frequent hallucinations, and (c) degenerates;—the dreams of the first class resemble their delusions; the second class is distinguished by the complexity of its dreams; the third by their vividness, by their delusions of megalomania, and by their influence on daily life. Alcoholic subjects have vivid and terrifying dreams, characterized by the frequent appearance of animals in them, and delirium tremens may originate during sleep.

Dreams of the Blind, Deaf, &c.—As regards visual dreams the blind fall into three classes:—(1) those who are blind from birth or become blind before the age of five; (2) those who become blind at the "critical age" from five to seven; (3) those who become blind after the age of seven. The dreams of the first class are non-visual; but in the dreams of Helen Keller there are traces of

a visual content; the second class sometimes has visual dreams; the third class does not differ from normal persons, though visual dreams may fade away after many years of blindness. In the case of the partially blind the clearness of vision in a dream exceeds that of normal life when the partial loss of sight occurred in the sixth or later years. The education of Helen Keller is interesting from another point of view; after losing the senses of sight and hearing in infancy she began her education at seven years and was able to articulate at eleven; it is recorded that she "talked" in her dreams soon after. This accords with the experience of normal individuals who acquire a foreign language. Her extraordinary memory enables her to recall faintly some traces of the sunlit period of her life, but they hardly affect her dreams, so far as can be judged. The dreams of the blind, according to the records of F. Hirschmann, present some peculiarities; animals as well as man speak; toothache and bodily pains are perceived as such; impersonal dreaming, taking the form of a drama or reading aloud, is found; and he had a strong tendency to reproduce or create verse.

Dreams of Animals.—We are naturally reduced to inference in dealing with animals as with very young children; but various observations seem to show that dreams are common in older dogs, especially after hunting expeditions; in young dogs sleep seems to be quieter; dogs accustomed to the chase seem to dream more than other kinds.

Dreams among the Non-European Peoples.—In the lower stages of culture the dream is regarded as no less real and its personages as no less objective than those of the ordinary waking life; this is due in the main to the habit of mind of such peoples (see ANIMISM), but possibly in some measure also to the occurrence of veridical dreams (see TELEPATHY). In either case the savage explanation is animistic, and animism is commonly assumed to have been developed very largely as a result of theorising dreams. Two explanations of a dream are found among the lower races: (1) that the soul of the dreamer goes out, and visits his friends, living or dead, his old haunts or unfamiliar scenes and so on; or (2) that the souls of the dead and others come to visit him, either of their own motion or at divine command. In either of the latter cases or at a higher stage of culture when the dream is regarded as god-sent, though no longer explained in terms of animism, it is often regarded as oracular (see ORACLE), the explanation being sometimes symbolical, sometimes simple.

There are two classes of dreams which have a special importance in the lower cultures: (1) the dream or vision of the initiation fast; and (2) the dream caused by the process known as incubation, which is often analogous to the initiation fast. In many parts of North America the individual Indian acquires a tutelary spirit, known as *manito* or *nagual*, by his initiation dream or vision; the idea being perhaps that the spirit by the act of appearing shows its subjection to the will of the man. Similarly, the magician acquires his familiar in North America, Australia and elsewhere by dreaming of an animal. Incubation consists in retiring to sleep in a temple, sometimes on the top of a mountain or other unusual spot, in order to obtain a revelation through a dream. Fasting, continence and other observances are frequently prescribed as preliminaries. Certain classes of dreams have, especially in the middle ages, been attributed to the influence of evil spirits (see DEMONOLOGY).

Classical and Medieval Views of Dreams.—Side by side with the prevalent animistic view of dreams we find in antiquity and among the semi-civilized attempts at philosophical or physiological explanations of dreams. Democritus, from whom the Epicureans derived their theory, held the cause of them to be the simulacra or phantasms of corporeal objects which are constantly floating about the atmosphere and attack the soul in sleep—a view hardly distinguishable from animism. Aristotle, however, refers them to the impressions left by objects seen with the eyes of the body; he further remarks on the exaggeration of slight stimuli when they are incorporated into a dream; a small sound becomes a noise like thunder. Plato, too, connects dreaming with the normal waking operations of the mind; Pliny, on the other hand, admits this only for dreams which take

place after meals, the remainder being supernatural. Cicero, however, takes the view that they are simply natural occurrences no more and no less than the mental operations and sensations of the waking state. The pathological side of dreams attracted the notice of physicians. Hippocrates was disposed to admit that some dreams might be divine, but held that others were premonitory of diseased states of the body. Galen took the same view in some of his speculations.

Symbolical interpretations are combined with pathological no less than animistic interpretations of dreams; they are also extremely common among the lower classes in Europe at the present day, but in this case no consistent explanation of their importance for the divination of future events is usually discoverable. Among the Greeks Plato in the *Timæus* (ch. xlvii., xlviii.) explains dreams as prophetic visions received by the lower appetitive soul through the liver; their interpretation requires intelligence. The Stoics seem to have held that dreams may be a divine revelation, and more than one volume on the interpretation of dreams has come down to us, the most important being perhaps the *Ὀνειροκρίσις* of Daldianus Artemidorus. We find parallels to this in a Mussulman work by Gabdorrahman, translated by Pierre Vattier under the name of *Onirocritie mussulman*, and in the numerous books on the interpretation of dreams which circulate at the present day. In Siam dream books are found (*Intern. Archiv für Anthr.* viii. 150); one of the functions of the Australian medicine man is to decide how a dream is to be interpreted.

Modern Views.—The doctrine of Descartes that existence depended upon thought naturally led his followers to maintain that the mind is always thinking and consequently that dreaming is continuous. Locke replied to this that men are not always conscious of dreaming, and it is hard to be conceived that the soul of the sleeping man should this moment be thinking, while the soul of the waking man cannot recollect in the next moment a jot of all those thoughts. That we always dream was maintained by Leibnitz, Kant, Sir W. Hamilton and others; the latter refutes the argument of Locke by the just observation that the somnambulist has certainly been conscious, but fails to recall the fact when he returns to the normal state.

It has been commonly held by metaphysicians that the nature of dreams is explained by the suspension of volition during sleep; Dugald Stewart asserts that it is not wholly dormant but loses its hold on the faculties, and he thus accounts for the incoherence of dreams and the apparent reality of dream images.

Cudworth, from the orderly sequence of dream combinations and their novelty, argues that the state arises, not from any "fortuitous dancings of the spirits," but from the "phantastical power of the soul." According to K. A. Scherner, dreaming is a decentralization of the movement of life; the ego becomes purely receptive and is merely the point around which the peripheral life plays in perfect freedom. Hobbes held that dreams all proceed from the agitation of the inward parts of a man's body, which, owing to their connexion with the brain, serve to keep the latter in motion. For Schopenhauer the cause of dreams is the stimulation of the brain by the internal regions of the organism through the sympathetic nervous system. These impressions the mind afterwards works up into quasi-realities by means of its forms of space, time, causality, &c.

BIBLIOGRAPHY.—For full lists of books and articles see J. M. Baldwin's *Dictionary of Philology*, bibliography volume (1906), and S. de Sanctis, *I Sogni*, also translated in German with additions as *Die Träume*. Important works are:—Binz, *Über den Traum*; Gieseler, *Aus den Tiefen des Traumlebens*; Maury, *Le Sommeil et les rêves*; Radestock, *Schlaf und Traum*; Tesaie, *Les Rêves*; Spitta, *Schlaf und Traumzustände*. For super-normal dreams see F. W. H. Myers, *Human Personality*, vol. 1., and *Proc. S.P.R.* viii. 362. For voluntary dreams see *Proc. S.P.R.* iv. 241, xvii. 112. On prophetic dreams see *Monist*, xi. 161; *Bull. Soc. Anth.* (Paris, 1901), 196, (1902), 228; *Rev. de synthèse historique* (1901), 151, &c. On incubation see Deubner, *De incubatione*; Maury, *La Magie*. On the dreams of American Indians see *Handbook of American Indians* (Washington, 1907), s.v. "Dreams" and "Manito." On the interpretation of dreams see Freud, *Die Traumdeutung*. Other works are F. Greenwood, *Imagination in Dreams*; Hutchinson, *Dreams and their Meanings*. (N. W. T.)

DREDGE AND DREDGING. The word "dredge" is used in two senses. (1) From Mid. Eng. *dragge*, through Fr. *dragée*, from Gr. *σπαγγαρά*, sweetmeats, it means a confection of sugar formed with seeds, bits of spice or medicinal agents. The word in this sense is obsolete, but survives in "dredger," a box with a perforated top used for sprinkling such a sugar-mixture, flour or other powdered substance. "Dredge" is also a local term for a mixed crop of oats and barley sown together ("maslin" or "meslin," cf. Fr. *dragée*), and in mining is applied to ore of a mixed value. (2) Connected with "drag," or at least derived from the same root, dredge or dredger is a mechanical appliance for collecting together and drawing to the surface ("dredging") objects and material from the beds of rivers or the bottom of the sea. In the following account the operations of dredging in this sense are discussed (1) as involved in hydraulic engineering, (2) in connexion with the work of the naturalist in marine biology.

1. HYDRAULIC ENGINEERING

Dredging is the name given by engineers to the process of excavating materials under water, raising them to the surface and depositing them in barges, or delivering them through a shoot, a longitudinal conveyor, or pipes, to the place where it is desired to deposit them. It has long been useful in works of marine and hydraulic engineering, and has been brought in modern times to a state of high perfection.

The employment of dredging plant and the selection of special appliances to be used in different localities and in varying circumstances require the exercise of sound judgment on the part of the engineer. In rivers and estuaries where the bottom is composed of light soils, and where the scour of the tide can be governed by training walls and other works constructed at reasonable expense, so as to keep the channel clear without dredging, it is manifest that dredging machinery with its large cost for working expenses and for annual upkeep should be as far as possible avoided. On the other hand, where the bottom consists of clay, rock or other hard substances, dredging must, in the first instance at any rate, be employed to deepen and widen the channel which it is sought to improve. In some instances, such as the river Mississippi, a deep channel has for many years been maintained by jetties, with occasional resort to dredging to preserve the required channel section and to hasten its enlargement. The bar of the river Mersey is 11 m. from land, and the cost of training works would be so great as to forbid their construction; but, by a capital expenditure of £120,000 and an annual expense of £20,000 for three years, the depth of water over the bar at low tide has been increased by dredging from 11 ft. to 27 ft., the channel being 1500 ft. wide.

"Bag and Spoon" Dredger.—The first employment of machinery for dredging is, like the discovery of the canal lock, claimed by Holland and Italy, in both of which countries it is believed to have been in use before it was introduced into Britain. The Dutch, at an early period, used what is termed the "bag and spoon" dredger for cleansing their canals. The "spoon" consisted of a ring of iron about 2 ft. in diameter flattened and steeled for about a third of its circumference and having a bag of strong leather attached to it by leathern thongs. The ring and bag were fixed to a pole which was lowered to the bottom from the side of a barge moored in the canal or river. The "spoon" was then dragged along the bottom by a rope made fast to the iron ring actuated by a windlass placed at the other end of the barge, the pole being prevented from rising by a hitched rope which caused the "spoon" to penetrate the bottom and fill the bag. When the "spoon" reached the end of the barge where the windlass was placed, the winding was still continued, and the suspended rope being nearly perpendicular the "bag" was raised to the gunwale of the barge and the excavated material emptied into the barge. The "bag" was then hauled back to the opposite end to be lowered for another supply. This system is still in use, but is only adaptable to a limited depth of water and a soft bottom; it has been largely used in canals and frequently in the Thames. At the Fosdyke Canal in Lincolnshire 135,000 tons were raised in the manner described. According

to J. J. Webster (*Proc. Inst. C. E.* vol. 89), the first application of steam power for dredging operations was to a "spoon & bag" dredger for cleansing Sunderland harbour, the engine being made by Messrs Boulton & Watt of Soho, Birmingham.

Dredging by Bucket between Two Lighters.—Another plan of dredging, practised at an early period in rivers of considerable breadth, was to moor two barges, one on each side of the river. Between them was slung an iron dredging bucket, which was attached to both barges by chains wound on the barrels of a crab winch worked by six men in one barge and round a simple windlass worked by two men in the other barge. The bucket, being lowered at the side of the barge carrying the windlass, was drawn across the bottom of the river by the crab winch on the other barge; and having been raised and emptied, it was hauled across by the opposite windlass for repetition of the process. This process was in use in the River Tay until 1833.

Bucket Ladder Dredgers.—The earliest record of a bucket ladder dredger is contained in the first paper of the first volume (1836) of the *Transactions* of the Institution of Civil Engineers. This machine was brought into use at the Hull Docks about 1782. The bucket chain was driven by two horses working a horse-gear on the deck of the vessel. The buckets were constructed of $\frac{3}{4}$ in. bars of iron spaced $\frac{1}{2}$ in. apart, and were 4 ft. long, 13 in. deep, 12 in. wide at the mouth and about 6 in. wide at the bottom. This dredger raised about 30 tons per hour at the cost of 2½d. per ton, which covered the wages of three men working the dredger, eight men working the lighters and the keep of three horses. A dredger of this kind and power would only work in ballast, mud or other soft material, but the machine was gradually improved and increased in capacity and power by different manufacturers until it became a very efficient machine in skilful hands, excavating and raising material from depths of 5 ft. to 60 ft. of water at a cost not very different from, and in many cases less than, that at which the same work could be performed on land. With the powerful dredgers now constructed, almost all materials, except solid rock or very large boulders, can be dredged with ease. Loose gravel is perhaps the most favourable material to work in, but a powerful dredger will readily break up and raise indurated beds of gravel, clay and boulders, and has even found its way through the surface of soft rock, though it will not penetrate very far into it. In some cases steel diggers alternating with the buckets on the bucket frame have been successfully employed. The construction of large steam dredgers is now carried on by many engineering firms. The main feature of the machine is the bucket ladder which is hung at the top end by eye straps to the frame of the vessel, and at the lower end by a chain riveted in purchase blocks and connected to the hoisting gear, so that the ladder may be raised and lowered to suit the varying depths of water in which the dredger works. The upper tumbler for working the bucket chain is generally square or pentagonal in form and made of steel with loose steel wearing pieces securely bolted to it. The tumbler is securely keyed to the steel shaft which is connected by gearing and shafting to the steam engine, a friction block being inserted at a convenient point to prevent breakage should any hidden obstacle causing unusual strain be met with in the path of the buckets. The lower tumbler is similar in construction to the upper tumbler, but is usually pentagonal or hexagonal in shape. The buckets are generally made with steel backs to which the plating of the buckets is riveted; the cutting edge of the buckets consists of a strong steel bar suitably shaped and riveted to the body. The intermediate links are made of hammered iron or steel with removable steel bushes to take the wear of the connecting pins, which are also of steel. The hoisting gear may be driven either from the main engine by frictional gearing or by an independent set of engines. Six anchors and chains worked by powerful steam crabs are provided for regulating the position of the dredger in regard to its work.

Barge-loading Dredgers used formerly to be provided with two ladders, one on each side of the vessel, or contained in wells formed in the vessel near each side. Two ladders were adopted, partly to permit the dredger to excavate the material close to a

quay or wall, and partly to enable one ladder to work while the other was being repaired. Bucket ladder dredgers are now, however, generally constructed with one central ladder working in a well; frequently the bucket ladder projects at either the head or stern of the vessel, to enable it to cut its own way through a shoal or bank, a construction which has been found very useful. In one modification of this method the bucket ladder is supported upon a traversing frame which slides along the fixed framing of the dredger and moves the bucket ladder forward as soon as it has been sufficiently lowered to clear the end of the well. In places where a large quantity of dredging has to be done, a stationary dredger with three or four large hopper barges proves generally to be the most economical kind of plant. It has, however, the disadvantage of requiring large capital expenditure, while the dredger and its attendant barges take up an amount of space which is sometimes inconvenient where traffic is large and the navigable width narrow. The principal improvements made in barge-loading dredgers have been the increase in the size of the buckets and the strength of the dredging gear, the application of more economical engines for working the machinery, and the use of frictional gearing for driving the ladder-hoisting gear. It is very important that the main drive be fitted with the friction blocks or clutches before alluded to.

Up to the year 1877 dredgers were seldom made with buckets of a capacity exceeding 9 cub. ft., but since that time they have been gradually increased in capacity. In the dredger "Melbourne," constructed by Messrs William Simons & Co. to the design and specification of Messrs Coode, Son & Matthews, about the year 1886, the buckets had a capacity of 22 cub. ft., the dredger being capable of making 37 ft. of water. The driving power consists of two pairs of surface-condensing engines, each of 250 i.h.p., having cylinders 20 in. and 40 in. in diameter respectively, with a 30 in. stroke, the boiler pressure being 90 lb per sq. in. The vessel is 200 ft. long by 36 ft. wide and 11 ft. 6 in. deep, and is driven by twin screw propellers. The gearing is arranged so that either pair of engines can be employed for dredging. The speed under steam is 7 knots, and in free-getting material 800 tons per hour can be dredged with ease. On one occasion the dredger loaded 400 tons in 20 minutes. The speed of the bucket chain is 8½ in. per minute. The draught of the dredger in working trim is 7 ft. forward and 9 ft. aft. The efficiency of the machine, or the net work in raising materials compared with the power exerted in the cylinders, is about 25%. The dredged material is delivered into barges moored alongside. Contrasting favourably with former experience, the "Melbourne" worked for the first six months without a single breakage. She is fitted with very powerful mooring winches, a detail which is of great importance to ensure efficiency in working.

The "St Austell" (Plate I. fig. 3), a powerful barge-loading dredger 195 ft. long by 35 ft. 6 in. beam by 13 ft. deep, fitted with twin-screw compound surface-condensing propelling engines of 1000 i.h.p., either set of engines being available for dredging, was constructed for H.M. Dockyard, Devonport, by Messrs Wm. Simons & Co. in 1896. This dredger loaded thirty-five 500-ton hopper barges in the week ending April 2, 1898, dredging 17,500 tons of material in the working time of 29 hours 5 minutes.

An instance of a still larger and more powerful dredger is the "Devalant," constructed by Messrs Wm. Simons & Co., for Nicolaiev, South Russia. She is a bow-well, barge-loading, bucket ladder dredger, with a length of 186 ft., a breadth, moulded, of 36 ft., and a depth, moulded, of 13 ft. The bucket ladder is of sufficient length to dredge 36 ft. below the water level. The buckets are exceptionally large, each having a capacity of 36 cub. ft., or fully two tons weight of material, giving a lifting capacity of 1800 tons per hour. At the dredging trials 2000 tons of spoil were lifted in one hour with an expenditure of 250 i.h.p. The propelling power is supplied by one pair of compound surface-condensing marine engines of 850 i.h.p., having two cylindrical boilers constructed for a working pressure of 120 lb per sq. in. Each boiler is capable of supplying steam to either the propelling or dredging machinery, thus allowing the vessel to always have a boiler in reserve. On the trials a speed of 8½ knots was obtained. The bucket ladder, which weighs over 100 tons, exclusive of dredgings, is raised and lowered by a set of independent engines. For manoeuvring, powerful winches driven by independent engines are placed at the bow and stern. The vessel is fitted throughout with electric light, arc lamps being provided above the deck to enable dredging to be carried on at night. Steam steering gear, a repairing shop, a three-ton crane, and all the latest appliances are installed on board.

The "Dérocheuse" (Plate II. fig. 12), constructed by Messrs Lobnitz & Co., is a good example of the dredger fitted with their patent rock cutters, as used on the Suez Canal. These rock cutters consist of stamps passing down through the bottom of the dredger, slightly in advance of the bucket chain, and are employed for breaking up rock in front of the bucket ladder so that it may be raised by

buckets afterwards. This system of subaqueous rock cutting plant, on Messrs Lobnitz's patent system, was effectively employed in deepening the Manchester Ship Canal, and removed a considerable length of rock, increasing the depth of water from 26 ft. to 28 ft., at a cost of about 9d. per cub. yd. A full and illustrated description of this plant, and of a similar plant supplied to the Argentine Government, was published in *Engineering* of August 17, 1906. An illustration of a bucket of 54 cub. ft. capacity constructed by Messrs Lobnitz & Co. is given (Plate II. fig. 11), from which some idea of the size of dredging machinery as developed in recent practice may be obtained. In regard to the depth of water that can be obtained by dredging, it is interesting to note that the dredger "Diver," constructed by Messrs. Hunter & English for Mr Samuel Williams of London, is capable of working in 60 ft. of water. In this vessel an ingenious arrangement was devised by Mr Williams, by which part of the weight of the dredger was balanced while the ladder itself could be drawn up through the bucket well and placed upon the deck, enabling a long ladder to be used for a comparatively short vessel. The "Tilbury" dredger, also constructed by Messrs Hunter & English, was able to dredge to a depth of 45 ft. below the surface of the water.

Hopper Barges.—To receive the materials excavated by barge-loading dredgers, steam hopper barges are now generally employed, capable of carrying 500 tons or more of excavation and of steaming loaded at a speed of about 9 m. per hour. These hopper barges are made with hinged flaps in their bottoms, which can be opened when the place of deposit is reached and the dredgings easily and quickly discharged.

Good examples of these vessels are the two steam hopper barges built for the Conservators of the river Thames in 1898. The dimensions are: length 190 ft., breadth 30 ft., depth 13 ft. 3 in., hopper capacity 900 tons. They are propelled by a set of triple expansion engines of 1200 i.h.p., with two return-tube boilers having a working pressure of 160 lb. Special appliances are provided to work the hopper doors by steam power from independent engines placed at the forward end of the hopper. A steam windlass is fixed forward and a steam capstan aft. The vessels are fitted with cabins for the officers and crew. On their trial trip, the hoppers having their full load, a speed of 11 knots was obtained, the coal consumption being 1.44 lb per i.h.p.

Methods of Dredging.—In river dredging two systems are pursued. One plan consists in excavating a series of longitudinal furrows parallel to the axis of the stream; the other in dredging cross furrows from side to side of the river. It is found that inequalities are left between the longitudinal furrows when that system is practised, which do not occur, to the same extent, in side or cross dredging; and cross dredging leaves a more uniform bottom. In either case the dredger is moored from the head and stern by chains about 250 fathoms in length. These chains in improved dredgers are wound round windlasses worked by the engine, so that the vessel can be moved ahead or astern by simply throwing them into or out of gear. In longitudinal dredging the vessel is worked forward by the head chain, while the buckets are at the same time performing the excavation, so that a longitudinal trench is made in the bottom of the river. After proceeding a certain length, the dredger is stopped and permitted to drop down and commence a new longitudinal furrow, parallel to the first one. In cross dredging, on the other hand, the vessel is supplied with four additional moorings, two on each side, and these chains are, like the head and stern chains, wound round barrels worked by steam power. In cross dredging we may suppose the vessel to be moored at one side of the channel to be excavated. The bucket frame is set in motion, but instead of the dredger being drawn forward by the head chain, she is drawn across the river by the starboard chains, and, having reached the extent of her work in that direction, she is then drawn a few feet forward by the head chain, and the bucket frame being still in motion the vessel is hauled across by the port chains to the side whence she started. By means of this transverse motion of the dredger a series of cross cuts is made; the dredger takes out the whole excavation from side to side to a uniform depth and leaves no protuberances such as are found to exist between the furrows in longitudinal dredging, even when it is executed with great care. The two systems will be understood by reference to fig. 1, where A and B are the

head and stern moorings, and C, D, E and F the side moorings. The arc *e f* represents the course of the vessel in cross dredging;

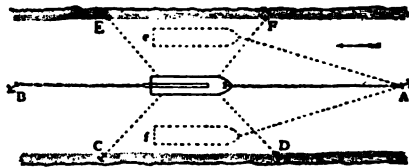

FIG. 1.—Diagram showing Moorings for Transverse Dredging.

while in longitudinal dredging, as already explained, she is drawn forward towards A, and again dropped down to commence a new longitudinal furrow.

Hopper Dredgers.—In places where barge-loading dredgers are inconvenient, owing to confined space and interference with navigation, and where it is necessary to curtail capital expenditure, hopper dredgers are convenient and economical. These dredgers were first constructed by Messrs. Wm. Simons & Co. of Renfrew, who patented and constructed what they call the "Hopper Dredger," combining in itself the advantages of a dredger for raising material and a scow hopper vessel for conveying it to the place of discharge, both of which services are performed by the same engines and the same crew.

The vessel for this type of dredger is made of sufficient length and floating capacity to contain its own dredgings, which it carries out to the depositing ground as soon as its hopper is full. Considerable time is of course occupied in slipping and recovering moorings, and conveying material to the depositing ground, but these disadvantages are in many instances counterbalanced by the fact that less capital is required for plant and that less room is taken up by the dredger. If the depositing ground is far away, the time available for dredging is much curtailed, but the four-screw hopper dredger constructed by Messrs Wm. Simons & Co. for Bristol has done good work at the cost of 5d. per ton, including wages, repairs, coals, grease, sundries and interest on the first cost of the plant, notwithstanding that the material has to be taken 10 m. from the Bristol Dock. She can lift 400 tons of stiff clay per hour from a depth of 36 ft. below the water line, and the power required varies from 120 i.h.p. to 150 i.h.p., according to the nature of the material. The speed is 9 knots, and 4 propellers are provided, two at the head and two at the stern, to enable the vessel to steam equally well either way, as the river Avon is too narrow to permit her to be turned round.

The hopper dredger "La Puissante" (Plate I. fig. 4), constructed by Messrs Wm. Simons & Co. for the Suez Canal Co. for the improvement of Port Said Roads, is a fine example of this class of dredger. She is 275 ft. long by 47 ft. beam by 19 ft. deep. The hopper capacity is 2000 tons, and the draught loaded 16 ft. 5 in. The maximum dredging depth is 40 ft., and the minimum dredging depth is only limited by the vessel's draught, she being able to cut her own way. The bucket ladder works through the well in the stern and weighs with buckets 120 tons. The buckets have each a capacity of 30 cub. ft. and raised on trial 1600 tons per hour. The dredger is propelled by two sets of independent triple expansion surface-condensing engines of 1800 i.h.p. combined, working with steam at 160 lb pressure, supplied by two mild steel multitubular boilers. Each set of engines is capable of driving the buckets independently at speeds of 16 and 20 buckets per minute. The bucket ladder is fitted with buffer springs at its upper end to lessen the shock when working in a sea way. The dredger can deliver the dredged material either into its own hopper or into barges lying on either side. The vessel obtained a speed of 9 knots per hour on trial. The coal consumption during 6 hours' steaming trial was 1.66 lb per i.h.p. per hour. Fig. 9 (Plate I.) shows a still larger hopper dredger by the same constructors.

Dredgers fitted with Long Shoot or Shore Delivering Apparatus.—The first instance of dredgers being fitted with long shoots was in the Suez Canal. The soil in the lakes was very variable, the surface being generally loose mud which lay in some places in the sand, but frequently more or less on hard clay. Resort was had to shoots 230 ft. long, supported on pontoons connected with the hull of the dredger. The sand flowed away with a moderate supply of water to the shoots when they were fixed

at an inclination of about 1 in 20, but when the sand was mixed with shells these formed a coating which prevented the stream of water from washing out the shoot, and even with an inclination of 1 in 10 material could not be delivered. A pair of endless chains working down the long shoot overcame the difficulty, and also enabled hard clay in lumps to be dealt with. One dredger turned out about 2000 cub. yds. of thick clay in 15 hours, and when the clay was not hard it could deliver 150,000 cub. yds. in a month for several consecutive months.

Shore delivery has been successfully effected by raising the material by buckets in the ordinary way and delivering it into a vertical cylinder connected with floating jointed pipes through which the dredgings pass to the shore. This, of course, can only be done where the place of deposit is near the spot where the material is dredged. Two plans have been satisfactorily employed for this operation. At the Amsterdam Canal the stuff was discharged from the buckets into a vertical cylinder, and after being mingled with water by a revolving Woodford pump was sent off under a head of pressure of 4 or 5 ft. to the place of deposit in a semi-fluid state through pipes made of timber, hooped with iron. These wooden pipes were made in lengths of about 15 ft., connected with leather joints, and floated on the surface of the water. A somewhat similar process was also employed on the Suez Canal.

A dredger (Plate I. fig. 5), constructed by Messrs Hunter & English for reclamation works on Lake Copais in Greece was fitted with delivery belts running on rollers in steel lattice frames on each side of the vessel supported by masts and ropes. It could deliver 100 cub. metres per hour at 85 ft. from the centre of the dredger, at a cost of 1-82d. per cub. metre for working expenses, with coal at 45s. per ton, including 0-66d. per cub. metre for renewal of belts, upon which the wear and tear was heavy.

Another instance of the successful application of shore delivery apparatus is that of a dredger for Lake Titicaca, Peru, constructed by Messrs Hunter & English, which was fitted with long shoots on both sides, conveying the dredged material about 100 ft. from the centre of the dredger upon either side. The shoots were supported by shear legs and ropes, and were supplied with water from a central pump in the engine room. This dredger could excavate and deliver 120 cub. yds. per hour at a cost of 1-72d. per cub. yd. with coal costing 40s. per ton. If coal had been available at the ordinary rate in England of 20s. per ton, the cost of the dredging and delivery would have been 0-82d. per cub. yd. for wages, coal, oil, &c., but not including the salary of the superintendent.

An interesting example of a shore delivering dredger is a light draught dredger constructed by Messrs Hunter & English for the Lakes of Albufera at the mouth of the river Ebro in Spain (Plate I. fig. 6). The conditions laid down for this dredger were that it should float in 18 in. of water and deliver the dredged material at 90 ft. from the centre of its own hull. In order to meet these requirements the vessel was made of steel plates $\frac{1}{2}$ in. thick, and longitudinal girders from end to end of the vessel, the upward strain of flotation being conveyed to them from the skin plating by transverse bulkheads at short intervals. The dredger was 94 ft. long, 25 ft. wide, and 3 ft. deep, and the height of the top tumbler above the water was 25 ft. When completed the dredger drew 17 in. of water. The dredgings were delivered by the buckets upon an endless belt, driven from the main compound surface-condensing engine, which ran over pulleys supported upon a steel lattice girder, the outer end of which rested upon an independent pontoon. This belt delivered the dredgings at 90 ft. from the centre of the dredger round an arc of 180°. The dredger delivered 125 cub. yds. per hour of compact clay at a cost of 1-16d. per cub. yd. or 0-86d. per ton for wages, coal and stores. Another method of delivering dredgings is that of pneumatic delivery, introduced by Mr F. E. Duckham of the Millwall Dock Co., by which the dredgings are delivered into cylindrical tanks in the dredger, closed by airtight doors, and are expelled by compressed air either into the sea or through long pipes to the land. The Millwall Dock dredger is 113 ft. long, with a beam of 17 ft. and a depth of 12 ft. The draught loader is 8 ft. It contains two cylindrical tanks, having a combined capacity of 240 cub. yds., and is fitted with compound engines of about 200 i.h.p., with a 20 in. air-compressing cylinder. The discharge pipe is 15 in. diameter by 150 yds. long. The nozzles of the air-injection pipes must not be too small, otherwise the compressed air, instead of driving out the material, simply pierces holes through it and escapes through the discharging pipe, carrying with it all the liquid and thin material in the tanks. The cost of working the Millwall Dock dredger is given by Mr Duckham at 1-75d. per cub. yd. of mud lifted, conveyed and deposited on land 450 ft. from the water-side, for working expenses only. This dredger is believed to be the first machine constructed with a traversing ladder, as suggested by Captain Gibson when dock-master of the Millwall Docks.

Blasting combined with Dredging.—In some cases it has been found that the bottom is too hard to be dredged until it has been to some extent loosened and broken up. Thus at Newry, John Rennie, after blasting the bottom in a depth of from 6 to 8 ft. at low water, removed the material by dredging at an expense of from 4s. to 5s. per cub. yd. The same process was adopted by Messrs Stevenson at the bar of the Erne at Ballyshannon, where, in a situation exposed to a heavy sea, large quantities of boulder stones were blasted, and afterwards raised by a dredger worked by hand at a cost of 10s. 6d. per cub. yd. Sir William Cubitt also largely employed blasting in connexion with dredging on the Severn (see *Proc. Inst. C.E. vol. iv. p. 362*). The cost of blasting and dredging the marl beds is given as being 4s. per cub. yd. A combination of blasting and dredging was employed in 1875 by John Fowler of Stockton at the river Tees. The chief novelty was in the barge upon which the machinery was fixed. It was 58 ft. by 28 ft. by 4 ft., and had eight legs which were let down when the barge was in position. The legs were then fixed to the barge, so that on the tide falling it became a fixed platform from which the drilling was done. Holes were bored and charged, and when the tide rose the legs were heaved up and the barge removed, after which the shots were discharged. There were 24 boring tubes on the barge, and that was the limit which could at any time be done in one tide. The area over which the blasting was done measured 500 yds. in length by 200 in breadth, a small part being uncovered at low water. The depth obtained in mid-channel was 14 ft. at low water, the average depth of rock blasted being about 4 ft. 6 in. The holes, which were bored with the diamond drill, varied in depth from 7 to 9 ft., the distance between them being 10 ft. Dynamite L1 tin canisters fired by patent fuse was used as the explosive, the charges being 2 lb and under. The rock is oolite shale of variable hardness, and the average time occupied in drilling holes 5 ft. deep was 12 minutes. The dredger raised the blasted rock. The cost for blasting, lifting and discharging at sea was about 4s. per cub. yd., including interest on dredging and other plant employed. The dredger sometimes worked a face of blasted material of from 7 to 8 ft. The quantity blasted was 110,000 cub. yds., and the contract for blasting so as to be lifted by the dredger was 3s. 1d. per cub. yd. A similar plan was adopted at Blyth Harbour (see *Proc. Inst. C.E. vol. 81, p. 302*). The cost of the explosives per cub. yd. was 1s. 4d., of boring 1s. 9d. per cub. yd., and of dredging 3s. per cub. yd., including repairs, but nothing for the use of plant. The whole cost worked out at 6s. 1d. per cub. yd. on the average.

Sand-pump Dredgers.—Perhaps the most important development which has taken place in dredging during recent years has been the employment of sand-pump dredgers, which are very useful for removing sandy bars where the particular object is to remove quickly a large quantity of sand or other soft material. They are, however, apt to make large holes, and are therefore not fitted for positions where it is necessary to finish off the dredging work to a uniform flat bottom, for which purpose bucket dredgers are better adapted. Pump dredgers are, however, admirable and economical machines for carrying out the work for which they are specially suited.

In the discussion upon Mr J. J. Webster's paper upon "Dredging Appliances" (*Proc. Inst. C.E. vol. 89*) at the Institution of Civil Engineers in 1886, Sir John Coode stated that he had first seen sand-pump dredgers at the mouth of the Maas in Holland. The centrifugal pump was placed against the bulkheads in the after part of the vessel, and the sand and water were delivered into a horizontal breeches-piece leading into two pipes running along the full length of the hopper. The difficulty of preventing the sand from running overboard was entirely obviated by its being propelled by the pump through these pipes, the bottoms of which were perforated by a series of holes. In addition, there were a few small flap-doors fixed at intervals, by means of which the men were able to regulate the discharge. On being tested, the craft pumped into its hopper 400 tons of sand in 22 minutes. The coamings round the well of the hoppers were constructed with a dip, and when the hopper was full the water ran over in a steady stream on either side. The proportion of sand delivered into the hopper was about 20% of the total capacity of the pump. The dredger was constructed by Messrs

Smit of Kinderdijk, near Rotterdam. In the same discussion Mr. A. A. Langley, then engineer to the Great Eastern railway, gave particulars of a sand pump upon the Bazin system, which had been used successfully at Lowestoft. The boat was 60 ft. long by 20 ft. wide, and the pump was 2 ft. in diameter, with a two-bladed disk. The discharge pipe was 12 in. in diameter. The pump raised 400 tons of sand, gravel and stones per hour as a maximum quantity, the average quantity being about 200 tons per hour. The depth dredged was from 7 ft. to 25 ft. The pump was driven by a double-cylinder engine, having cylinders of 9 in. diameter by 10 in. stroke, and making 120 revolutions per minute. An important improvement was made by fitting the working faces of the pump with india-rubber, which was very successful and largely reduced the wear and tear. The cost of the dredging at Lowestoft was given by Mr Langley at 2d. per ton, including delivery 2 m. out at sea. The quantity dredged was about 200,000 tons per annum.

One of the earliest pumps to be applied to dredging purposes was the Woodford, which consisted of a horizontal disk with two or more arms working in a case somewhat similar to the ordinary centrifugal pump. The disk was keyed to a vertical shaft which was driven from above by means of belts or other gear coupled to an ordinary portable engine. The pump within rested on the ground; the suction pipe was so arranged that water was drawn in with the sand or mud, the proportions being regulated to suit the quality of the material. The discharge pipe was rectangular and carried a vertical shaft, the whole apparatus being adjustable to suit different depths of water. This arrangement was very effective, and has been used on many works. Burt & Freeman's sand pump, a modification of the Woodford pump, was used in the construction of the Amsterdam Ship Canal, for which it was designed. The excavations from the canal had to be deposited on the banks some distance away from the dredgers, and after being raised by the ordinary bucket dredger, instead of being discharged into the barges, they were led into a vertical chamber on the top side of the pump, suitable arrangements being made for regulating the delivery. The pump was 3½ ft. in diameter, and made about 230 revolutions per minute. The water was drawn up on the bottom side and mixed with the descending mud on the top side, and the two were discharged into a pipe 15 in. in diameter. The discharge pipe was a special feature, and consisted of a series of wooden pipes jointed together with leather hinges and floated on buoys from the dredger to the bank. In some cases this pipe was 300 yds. long, and discharged the material 8 ft. above the water level. Each dredger and pump was capable of discharging an average of 1500 cub. yds. per day of 12 hours. Schmidt's sand pump is claimed to be an improvement on the Burt & Freeman pump. It consists of a revolving wheel 6 ft. in diameter, with cutters revolving under a hood which just allows the water to pass underneath. To the top side of the hood a 20 in. suction pipe from an ordinary centrifugal pump is attached. The pump is driven by two 16 in. by 20 in. cylinders, at 134 revolutions per minute, the boiler pressure being 95 lb per sq. in. This apparatus is capable of excavating sticky blue clayey mud, and will deliver the material at 500 to 650 yds. distance. The best results are obtained when the mixture of mud and water is as 1 to 6-5. The average quantity excavated per diem by the apparatus is 1300 cub. yds., the maximum quantity being 2500 cub. yds.

Kennard's sand pump is entirely different from the pumps already described, and is a direct application of the ordinary lift pump. A wrought iron box has a suction pipe fitted at the bottom, rising about half way up the inside of the box; on the top of the box is fitted the actual pump and the flap valves. The apparatus is lowered by chains, and the pump lowered from above. As soon as the box is filled with sand it is raised, the catches holding up the bottom released, and the contents discharged into a punt.

Sand-pump dredgers, designed and arranged by Mr Darnton Hutton, were extensively used on the Amsterdam Ship Canal. A centrifugal pump with a fan 4 ft. in diameter was employed, the suction and delivery pipes, each 18 in. in diameter, being attached to an open wrought-iron framework. The machine was suspended between guides fixed to the end of the vessel, which was fitted with tackle for raising, lowering and adjusting the machine. The vessel was fitted with a steam engine and boiler for working and manipulating the pumps and the heavy side chains for the guidance of the dredger. The engine was 70 h.p., and the total cost of one dredger was £8000. The number of hands required for working this sand-pump dredger was one captain, one engineer, one stoker and four sailors. Each machine was capable of raising about 1300 tons of material per day, the engines working at 60 and the pump at 180 revolutions per minute. The sand was delivered into barges alongside the dredger. The cost of raising the material and depositing it in barges was about 1d. per ton when the sand pumps were working, but upon the year's work the cost was 2-4d. per cub. yd. for working expenses and repairs, and 1-24d. per cub. yd. for interest and depreciation of 3-64d. per cub. yd. of the plant, making a total cost for dredging of 3-64d. per cub. yd. The cost for transport was 3-588d. per cub. yd., making a total cost for dredging and transport of 7-234d. per cub. yd. Dredging and transport on the same works by an ordinary bucket dredger and barges cost 8-328d. per cub. yd.

Two of the largest and most successful instances of sand-pump dredgers are the "Brancier" and the "G. B. Crow," belonging

to the Mersey Docks and Harbour Board. Mr A. G. Lyster gave particulars of the work done by these dredgers in a paper read before the Engineering Congress in 1899. They are each 320 ft. long, 47 ft. wide and 20-5 ft. deep, the draught loaded being 16 ft. They are fitted with two centrifugal pumps, each 6 ft. in diameter, with 26 in. suction and delivery pipes, united into a 45 in. diameter pipe, hung by a ball and socket joint in a trunnion, so as to work safely in a seaway when the waves are 10 ft. high. The suction pipe is 76 ft. long and will dredge in 53 ft. of water. The eight hoppers hold 3000 tons, equivalent when solid to 2000 cub. yds.; they can be filled in three-quarters of an hour and discharged in five minutes. Mr Lyster stated that up to May 1899, the quantity removed from bar and main-channel shoals amounted to 41,240,360 tons, giving a width of channel of 1500 ft. through the bar, with a minimum depth of 27 ft. The cost of dredging on the bar by the "G. B. Crow" during 1898, when 4,309,350 tons of material were removed, was 6-61d. per ton for wages, supplies and repairs. These figures include all direct working costs and a proportion of the charge for actual superintendence, but no allowance for interest on capital cost or depreciation. On an average, 20% of the sand and mud that are raised escapes over the side of the vessel. Mr Lyster has, however, to a considerable extent overcome this difficulty by a special arrangement added to the hoppers (see *Proc. Inst. C.E. vol. 188*).

At the Engineering Conference, 1907, Mr Lyster read a note in which he stated that the total quantity of material removed from the bar of the Mersey, from the Crosby channel, and from other points of the main channel by the "G. B. Crow" and "Brancier" suction dredgers amounted to 108,675,570 tons up to the 1st of May 1907. "In the note of 1899 (he added) it was pointed out that the Mersey was a striking instance of the improvement of a river by dredging rather than by permanent works, and the economy of the system as well as the advantage which its elasticity and adaptability to varying circumstances permit, was pointed out. . . . The most recent experience, which has resulted in the adoption of the proposal to revet the Taylor's bank, indicates that the dredging method has its limitations and cannot provide for every contingency which is likely to arise; at the same time, the utility and economy of the dredging system is in no way diminished. . . . Having regard to the ever-increasing size of vessels, a scheme for new docks and entrances on a very large scale received the authority of parliament during the session of 1905-1906. In this scheme it was considered necessary to make provision for vessels of 1000 ft. in length and 40 ft. in draught, and having regard to this prospective growth of vessels it has been determined still further to deepen and improve the outer channel of the Mersey. No fixed measure of improvement has been decided on, but after careful survey of existing conditions and a comparison with probable requirements, it has been determined to construct a dredger of 10,000 tons capacity, provided with pumping power equivalent to about three times that of any existing dredgers. By the use of this vessel it is anticipated that it will be possible to deal with very much larger quantities of sand at a cheaper rate, and to 10 ft. greater depth than the existing plant permits.

The vessel in question was launched on the Mersey from the yard of Messrs Cammell, Laird & Co. in October 1908, and was named the "Leviathan." Her length is 487 ft., beam 60 ft., and depth 30 ft. 7 in. Her dredging machinery consists of four centrifugal pumps driven by four sets of inverted triple expansion engines, and connected to four suction tubes 90 ft. long and 42 in. in internal diameter. Her propelling machinery, consisting of two acts of triple expansion engines, is capable of driving her at a speed of 10 knots.

Another powerful and successful sand-pump dredger, "Kate" (Plate I, fig. 7), was built in 1897 by Messrs Wm. Simons & Co. Ltd. for the East London Harbour Board, South Africa. Its dimensions are: length 200 ft., breadth 39 ft., depth 14 ft. 6 in., hopper capacity 1000 tons. The pumping arrangements for filling the hopper with sand or discharging overboard consist of two centrifugal pumps, each driven from one of the propelling engines. The suction pipes are each 27 in. in diameter, and are so arranged that they may be used for pumping either forward or aft, as the state of the weather may require. Four steam cranes are provided for manipulating the suction pipes. Owing to the exceptional weather with which the vessel had to contend, special precautions were taken in designing; the attachments of the suction pipes to the vessel. The attachments is above deck and consists of a series of joints, which give a perfect free and universal movement to the upper ends of the pipes. The joints, on each side of the vessel, are attached to a carriage, which is traversed laterally by hydraulic gear. By this means the pipes are pushed out well clear of the vessel's sides when pumping, and brought inboard when not in work. Hydraulic cushioning cylinders are provided to give any required resistance to the fore and aft movements of the pipes. When the vessel arrived at East London on the 18th of July 1897, there was a depth of 14 ft. on the bar at high tide. On the 10th of October, scarcely three months afterwards, there was a depth of 20 ft. on the bar at low water. Working 22 days in rough weather during the month of November 1898, the "Kate" raised and deposited 2½ m. at sea 60,000 tons of dredgings. Her best day's work (12 hours) was on the 7th of November, when she dredged and deposited 6440 tons.

A large quantity of sand-pump dredging has been carried out at Boulogne and Calais by steam hopper pump dredgers, workable when

the head waves are not more than 3 ft. high and the cross waves not more than 1½ ft. high. The dredgings are taken 2 m. to sea, and the price for dredging and depositing from 800,000 to 900,000 cub. metres in 5 or 6 years was 7-25d. per cub. yd. The contractor offered to do the work at 4-62d. per cub. yd. on condition of being allowed to work either at Calais or Boulogne, as the weather might permit. Sand-pump dredging has also been extensively carried out at the mouth of the ports of Amsterdam, Rotterdam and on the north coast of France by sand dredgers constructed by Messrs L. Smit & Son and G. & K. Smit. The largest dredger, the "Amsterdam," is 14½ ft. by 27 ft. by 10 ft. 8 in., and has engines of 100 i.h.p. The hopper capacity is 10,600 cub. ft., and the vessel can carry 600 tons of dredgings. The pump fan is 6 ft. 3 in. in diameter by 10 in. wide, the plates being of wrought iron, and makes 130 revolutions a minute. The pump can raise 230 cub. ft. a minute from a depth of 33 ft., which, taking the proportion of 1 of sand to 7 of water, gives a delivery of 29 cub. ft. of sand per minute. The hopper containing 10,600 cub. ft. was under favourable circumstances filled in 40 minutes. The vessels are excellent sea boats.

Combined Bucket-Ladder and Sand-Pump Dredgers.—Bucket ladders and sand pumps have also been fitted to the same dredger. A successful example of this practice is furnished by the hopper dredger "Percy Sanderson" (Plate I. fig. 8), constructed under the direction of Sir C. A. Hartley, engineer of the Danube Commission for the deepening of the river Danube and the Sulina bar. This dredger is 220 ft. by 40 ft. by 17 ft. 2 in., and has a hopper capacity for 1250 tons of dredgings. The buckets have each a capacity of 25 cub. ft., and are able to raise 1000 tons of ordinary material per hour. The suction pump, which is driven by an independent set of triple expansion engines, is capable of raising 700 tons of sand per hour, and of dredging to a depth of 35 ft. below the water-line. The lower end of the suction pipe is controlled by special steam appliances by which the pipe can be brought entirely inboard. The "Percy Sanderson" raises and deposits on an average 5000 tons of material per day.

Grab Dredgers.—The grab dredger was stated by Sir Benjamin Baker (*Proc. Inst. C.E. vol. 113, p. 38*) to have been invented by Gouffé in 1703, and was worked by two ropes and a bar. Various kinds of apparatus have been designed in the shape of grabs or buckets for dredging purposes. These are usually worked by a steam crane, which lets the open grab down to the surface of the ground to be excavated and then closes it by a chain which forces the tines into the ground; the grab is then raised by the crane, which deposits the contents either into the hopper of the vessel upon which the crane is fixed or into another barge.

The Priestman grab has perhaps been more extensively used than any other apparatus of this sort. It is very useful for excavating mud, gravel and soft sand, but is less effective with hard sand or stiff clay—a general defect in this class of dredger. It is also capable of lifting large loose pieces of rock weighing from 1 to 2 tons. A dredger of this type, with grab holding 1 ton of mud, dredged during six days, in 19 ft. of water, an average of 5½ tons and a maximum of 68½ tons per hour, and during 12 days, in 16 ft. of water, an average of 48 tons and a maximum of 58 tons per hour, at a cost of 1-63d. per ton, excluding interest on the capital and depreciation. The latest dredger to which this apparatus has been applied is the grab bucket hopper dredger "Miles K. Burton" (Plate I. fig. 9), belonging to the Mersey Docks and Harbour Board. It is equipped with 5 grabs on Morsey's patent system, which is a modification of Priestman's, the grabs being worked by 5 hydraulic cranes. It raised and deposited, 12 to 15 m. at sea, 11 loads of about 1450 tons each with a double shift of hands, at a cost of about 1s. 5d. per cub. yd. of spoil, including the working expenses for wages of crew, fuel and stores. Mr R. A. Marillier of Hull has stated that "the efficiency of these grabs is not at all dependent upon the force of the blow in falling for the penetration and grip in the material, as they do their work very satisfactorily even when lowered quite gently on to the material to be cut out, the jaws being so framed as to draw down and penetrate the material as soon as the upward strain is put on the lifting chain. Even in hard material the jaws penetrate so thoroughly as to cause the bucket to be well filled. The grab is found to work successfully in excavating hard clay from its natural bed on dry land." It is claimed on behalf of grabs that they lift a smaller proportion of water than any other class of dredger.

Since the beginning of the 20th century considerable advance has been made in the use of Priestman grabs, not only for dredging and excavating (for which work they were originally designed), but also in discharging bulk cargo. The first quadruple dredger used by the Liverpool Docks Board had grabs of a capacity of 30 cub. ft., but subsequently second and third quadruple dredgers were put to work in the Liverpool Docks, with grabs having a capacity of 70 and 100 cub. ft. respectively. In discharging coal at Southampton, Havre,

Erith, as well as at the coaling station at Purfleet on the Thames, grabs having a capacity of about 80 cub. ft. are in constant use. Perhaps the most difficult kind of bulk cargo to lift is "Narvick" iron ore, which sets into a semi-solid body in the holds of the vessels, and for this purpose one of the largest grabs, having about 150 cub. ft. capacity and weighing about 8 tons, has been adopted. This grab was designed as a result of experiments extending over a long period in lifting iron ore. It is fitted with long, forged, interlocked steel teeth for penetrating the compact material, which is very costly to remove by hand labour. The Priestman grab is made to work with either one or two chains or wire ropes. Grabs worked with two chains or ropes have many advantages, and are therefore adopted for large undertakings.

Wild's single chain half-tine grab works entirely with a single chain, and has been found very useful in excavating the cylinders in Castries harbour. Upon experimenting with an ordinary grab a rather curious condition of things was observed with respect to sinking. On penetrating the soil to a certain depth the ground was found as it were nested, and nothing would induce the grab to sink lower. Sir W. Matthews suggested that a further set of external tines might possibly get over this difficulty. A new grab having been made with this modification, and also with a large increase of weight—all the parts being of steel—it descended to any required depth with ease, the outside tines loosening the ground effectually whilst the inside bucket or tines picked up the material.

Miscellaneous Appliances.—There are several machines or appliances which perhaps can hardly be called dredgers, although they are used for cleansing and deepening rivers and harbours.

Kingfoot's dredger, used for cleansing the river Stour, consisted of a boat with a broad rake fitted to the bow, capable of adjustment to different depths. At the sides of the boat were hinged two wings of the same depth as the rake and in a line with it. When the rake was dropped to the bottom of the river and the wings extended to the side, they formed a sort of temporary dam, and the water began to rise gradually. As soon as a sufficient head was raised, varying from 6 to 12 in., the whole machine was driven forward by the pressure, and the rake carried the mud with it. Progress at the rate of about 3 m. an hour was made in this manner, and to prevent the accumulation of the dredgings, operations were begun at the mouth of the river and carried on backwards. The apparatus was very effective and the river was cleaned thoroughly, but the distance travelled by the dredger must have been great.

In 1876 J. J. Rietschoten designed a "propeller dredger" for removing the shoals of the river Maas. It consisted of an old gunboat fitted with a pair of trussed beams, one at each side, each of which carried a steel shaft and was capable of being lowered or raised by means of a crab. An ordinary propeller 3 ft. 6 in. in diameter was fixed to the lower end of the shaft, and driven by bevel gear from a cross shaft which derived its motion by belting from the fly-wheel of a 12 h.p. portable engine. The propellers were lowered until they nearly reached the shoals, and were then worked at 150 revolutions per minute. This operation scoured away the shoal effectively, for in about 40 minutes it had been lowered about 3 ft. for a space of 150 yds. long by 8 yds. wide.

A. Lavalley in 1877 designed an arrangement for the harbour of Dunkirk to overcome the difficulty of working an ordinary bucket-ladder dredger when there is even a small swell. A pump injects water into the sand down a pipe terminating in three nozzles to stir up the sand, and another centrifugal pump draws up the mixed sand and water and discharges it into a hopper, the pumps and all machinery being on board the hopper. To allow for the rising and falling of the vessel—either by the action of the tide or by the swell—the ends of the pipes are made flexible. The hopper has a capacity of 190 cub. yds., and is propelled and the pumps worked by an engine of 150 i.h.p. From 50 to 80 cub. yds. per hour can be raised by this dredger.

The "Aquamotrice," designed by Popie, and used on the Garonne at Agen, appears to be a modification of the old bag and spoon arrangement. A flat-bottomed boat 5½ ft. long by 6½ ft. wide was fitted at the bow with paddles, which were actuated by the tide. Connected with the paddles was a long chain, passing over a pulley on uprights and under a roller, and a beam was attached to the chain 14 ft. 8 in. long, passing through a hole in the deck. At the end of the beam was an iron scoop 2 ft. wide and 2 ft. 6 in. deep. When the tide was strong enough it drew the scoop along by means of the paddles and chains, and the scoop when filled was opened by a lever and discharged. About 65 cub. yds. of gravel could be raised by the apparatus in 12 hours. When the tide failed the apparatus was worked by men.

The Danube Steam Navigation Co. removed the shingle in the shallow parts of the river by means of a triangular rake with wrought-iron sides 18 ft. long, and fitted with 34 teeth of chilled cast iron 12 in. deep. This rake was hung from the bow of a steamer 180 ft. long by 21 ft. beam, and dragged across the shallows, increasing the depth of water in one instance from 5 ft. 6 in. to 9 ft., after passing over the bank 355 times.

A combination of a harrow and high pressure water jets, arranged by B. Tydeman, was found very efficacious in removing a large

quantity of mud which accumulated in the Tilbury Dock basin, which has an area of about 17 acres, with a depth of 26 ft. at low-water spring tides. In the first instance chain harrows merely were used, but the addition of the water jets added materially to the success of the operation. The system accomplished in six tides more than was done in twelve tides without the water jets which worked at about 80 lb pressure per sq. in. at the bottom of the dock.

Ive's excavator consists of a long weighted spear, with a sort of spade at the end of it. The spade is hinged at the top, and is capable of being turned at right angles to the spear by a chain attached to the end of the spear. The spade is driven into the ground, and after releasing the catch which holds it in position during its descent, it is drawn up at right angles to the spear by the chain, carrying the material with it. Milroy's excavator is similar, but instead of having only one spade it generally has eight, united to the periphery of an octagonal iron frame fixed to a central vertical rod. When these eight spades are drawn up by means of chains, they form one flat table or tray at right angles to the central rod. In operation the spades hang vertically, and are dropped into the material to be excavated; the chains are then drawn up, and the table thus formed holds the material on the top, which is lifted and discharged by releasing the spade. This apparatus has been extensively used both in Great Britain and in India for excavating in bridge cylinders.

The clam shell dredger consists of two hinged buckets, which when closed form one semi-cylindrical bucket. The buckets are held open by chains attached to the top of a cross-head, and the machine is dropped on to the top of the material to be dredged. The chains holding the bucket open are then released, while the spears are held firmly in position, the buckets being closed by another chain. Bull's dredger, Gattmell's excavator, and Fouracre's dredger are modifications with improvements of the clam shell dredger, and have all been used successfully upon various works.

Bruce & Batho's dredger, when closed, is of hemispherical form, the bucket being composed of three or four blades. It can be worked by either a single chain or by means of a spear, the latter being generally used for stiff material. The advantage of this form of dredger bucket is that the steel points of the blades are well adapted for penetrating hard material. Messrs Bruce & Batho also designed a dredger consisting of one of these buckets, but worked entirely by hydraulic power. This was made for working on the Tyne. The excavator or dredger is fixed to the end of a beam which is actuated by two hydraulic cylinders, one being used for raising the bucket and the other for lowering it; the hydraulic power is supplied by the pumps in the engine-room. The novelty in the design is the ingenious way in which the lever in ascending draws the shoot under the bucket to receive its contents, and draws away again as the bucket descends. The hydraulic cylinder at the end of the beam is carried on gimbals to allow for irregularities on the surface being dredged. The hydraulic pressure is 700 lb per sq. in., and the pumps are used in connexion with a steam accumulator.

An unloading apparatus was designed by Mr A. Manning for the East & West India Dock Co. for unloading the dredged materials out of barges and delivering it on the marsh at the back of the bank of the river Thames at Crossness, Kent. A stage constructed of wooden piles commanded a series of barge beds, and the unloading dredger running from end to end of the stage, lifted and delivered the materials on the marsh behind the river wall at the cost of 1 d. per cub. yd.

Dredging on the River Scheldt below Antwerp.—This dredging took place at Krankeloon and the Belgian Sluis under the direction of L. Van Gansberghe. At Melsele there is a pronounced bend in the river, causing a bar at the Pass of Port Phillip, and just below the pass of Lillo there is a cross-over in the current, making a neutral point and forming a shoal. After dredging to 8 metres (26-24 ft.) below low tide, in clay containing stone and ferruginous matter, a sandstone formation was encountered, which was very compact and difficult to raise. A suction dredger being unsuited to the work, a bucket-ladder dredger was employed. The dredging was commenced at Krankeloon in September 1804 and continued to the end of 1807. A depth of 6 metres (19-68 ft.) was excavated at first, but was afterwards increased to 8 metres (26-24 ft.). The place of deposit was at first on lands acquired by the State, 2-17 m. above Krankeloon, and placed at the disposal of the contractor. The dredgings excavated by the bucket-ladder dredger were deposited in scows, which were towed to the front of the deposit ground and discharged by a suction pump fixed in a special boat, moored close to the bank of the river. The material brought by the suction dredger in its own hull was discharged by a plant fixed upon the dredger itself. In both instances the material was deposited at a distance of 1640 ft. from the river, the spoil bank varying in depth from 2 to 7 metres. The water thrown out behind the dyke with the excavated material returned to the river.

After settlement, by a special discharge lock built under the dyke. After 1806 the material was delivered into an abandoned pass by means of barges with bottom hopper doors or by the suction dredger. One suction dredger and three bucket-ladder dredgers were employed upon the work, and a vessel called "Scheidt I." used for discharging the material from the scows. Four tug-boats and twenty scows were also employed.

The largest dredger, "Scheidt III.," was 147-63 ft. long by 22-96 ft. wide by 10-98 ft. deep, and had buckets of 21-18 cub. ft. capacity. The output per hour was 10,594 cub. ft. This dredger had also a complete installation as a suction dredger, the suction pipe being 24 in. diameter. The fan of the centrifugal pump was 5-25 ft. diameter, and was driven by the motor of the bucket ladder. The three bucket dredgers worked with head to the ebb-tide. They could also work with head to the flood tide, but it took so long a time to turn them about that it was impracticable. The work was for from 13 to 14 hours a day on the ebb tide. The effective daily excavation averaged 4839 cub. yds. Each dredger was fitted with six anchors. The excavated cut was 164 ft. wide by 6-56 ft. deep. "Scheidt III." was capable of lifting a mass 9-84 ft. thick. The suction dredger "Scheidt II." was of the multiple type, and is stated to be unique in construction. It can discharge material from a scow alongside, fill its own hopper with excavations, discharge its own load upon the bank or into a scow by different pipes provided for the purpose, and discharge its own load through hopper doors. The machinery is driven by a triple expansion engine of 300 i.h.p. working the propeller by a clutch. Owing to the rise and fall in the tide of 23 ft. the suction pipe is fitted with spherical joints and a telescopic arrangement. The vessel is 157-5 ft. by 28-2 ft. by 12-8 ft. The diameter of the pump is 5-25 ft. The wings of the pump are curved, the surface being in the form of a cylinder parallel to the axis of rotation, the directrix of which is an arc of a circle of 2-62 ft. radius with the straight part beyond. The suction and discharge pipes are 2 ft. diameter. A centrifugal pump is provided for throwing water into the scows to liquify the material during discharge. The dredger, which is fitted with electric lights for work at night, is held by two anchors, to prevent lurching backwards and forwards; it can work on the flood as well as on the ebb tide, and can excavate to a depth of 42-65 ft., the output depending upon the nature of the material. With good material it can fill its tanks in thirty minutes. To empty the tanks by suction and discharge upon the bank over the dyke takes about fifty minutes, depending upon the height and distance to which the material requires to be delivered. The daily work has averaged eighteen hours, ten trips being made when the distance from the dredging ground to the point of delivery is about 1 m. When the dredged material is discharged into the Scheidt, a quantity of 5886 cub. yds. has been raised and deposited in a day, the mean quantity being 4700 cub. yds. When the distance of transportation is increased to 24 m., six voyages were made in a day, and the day's work amounted to 3530 cub. yds.

Gold Dredgers.—Dredgers for excavating from river beds soil containing gold are generally fitted with a screen and elevator.

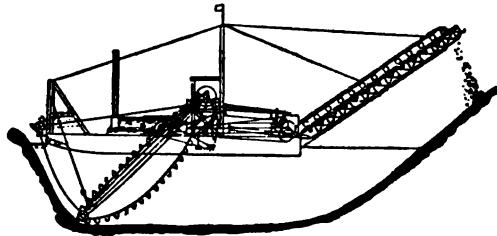

FIG. 2.—Diagram showing Action of Lobnitz Gold Dredger.

They have been extensively designed and built by Messrs Lobnitz & Co. (fig. 2) and also by Messrs Hunter & English.

The writer is indebted to the *Proceedings* of the Institution of Civil Engineers, and especially to the paper of Mr J. J. Webster (*Proc. Inst. C.E.* vol. 89), for much valuable information upon the subject treated. He is also indebted to many manufacturers who have furnished him with particulars and photographs of dredging plant. (W. H.)

2. MARINE BIOLOGY

The naturalist's dredge is an instrument consisting essentially of a net or bag attached to a framework of iron which forms the mouth of the net. When in use as the apparatus is drawn over the sea-bottom mouth forwards, some part of the framework passes beneath objects which it meets and so causes them to

enter the net. It is intended for the collection of animals and plants living on or near the sea-bottom, or sometimes of specimens of the sea-bottom itself, for scientific purposes.

Until the middle of the 18th century, naturalists who studied the marine fauna and flora relied for their materials on shore collection and the examination of the catches of fishing boats. Their knowledge of creatures living below the level of low spring tides was thus gained only from specimens cast up in storms, or caught by fishing gear designed for the capture of certain edible species only. The first effort made to free marine biology from these limitations was the use of the dredge, which was built much on the plan of the oyster dredge.



FIG. 13.—Otho Frederick Müller's Dredge (1770).

Where these two portions of the bag meet a wooden beam is fastened. In use the frame is towed forward by its apex; the shere passes below oysters, &c., which pass back on to the iron netting. The length of each side of the triangular frame is about 6 ft., the width of the shere 3 in. and the height of the mouth just under a foot. The rings vary in size, but are usually some 2½ in. in diameter. The weight is about 60 lb. This dredge was soon abandoned: its weight was prohibitive for small boats, from which the naturalist usually worked, its wide rings allowed precious specimens to fall through, and its shallow net favoured the washing out of light objects on hauling through the moving water of the surface. Moreover, it sometimes fell on its back and was then useless, although when the apex or towing point was weighted no great skill is needed to avoid this.

Otho Müller used a dredge (fig. 13) consisting of a net with a square iron mouth, each of whose sides was furnished with a thin edge turned slightly away from the dredge's centre. As any one of these everted lips could act as a scraper it was a matter of indifference which struck the bottom when the dredge was lowered. The chief defect of the instrument was the ease with which light objects could be washed out on hauling, owing to the size of the mouth. However, with this instrument Müller obtained from the often stormy Scandinavian seas all the material for his celebrated *Zoologia Danica*, a description of the marine fauna of Denmark and Norway which was published with excellent coloured plates in 1778; and historical interest attaches to the dredge as the first made specially for scientific work.

Ball's Dredge.—About 1838 a dredge devised by Dr Ball of Dublin was introduced. It has been used all over the world, and is so apt for its purpose that it has suffered very little modification during its 70 years of life. It is known as Ball's dredge or more generally simply "the dredge."

Ball's dredge (fig. 14) consists of a rectangular net, attached to a rectangular frame much longer than high, and furnished with rods stretching from the four corners to meet at a point where they are attached to the dredge rope. It differs from Müller's dredge in the slit-like shape of the opening, which prevents much of the "washing out" suffered by the earlier pattern, and in the edges. The long edges only are fashioned as scrapers, being wider and heavier than Müller's, especially in later dredges. The short edges are of round iron bar.

Like Müller's form, Ball's dredge will act whichever side touches the bottom first, as its frame will not remain on its short edge, and either of the long edges acts as a scraper. The scraping lips thicken gradually from free edge to net; they are set at 110° to the plane of the mouth, and in some later patterns curve outwards instead of merely sloping. All dredge frames are of wrought iron.

The thick inner edges of the scrapers are perforated by round holes at distances of about an inch, and through these strong iron rings about an inch in diameter are passed, and two or three similar rings run on the short rods which form the ends of the dredge-frame.

A light iron rod, bent to the form of the dredge opening, usually runs through these rings, and to this rod and to the rings the mouth of the dredge-bag is securely attached by stout cord or strong copper wire. Various materials have been used for the bag, the chief of which are hide, canvas and netting. The hide was recommended by its strength, but it is now abandoned. Canvas bags fill quickly with mud or sand and then cease to operate: on the other hand wide mesh net fails to retain small specimens. Probably the most suitable material is hand-made netting of very strong twine, the meshes half an inch to the side, the inter-spaces contracting to a third of an inch across when the twine is thoroughly soaked, with an open canvas or "bread-bag" lining to the last 6 in. of the net. A return to canvas covering has latterly occurred in the small dredge called the mud-bag, trailed behind the trawl of the "Albatross" for obtaining a sample of the bottom, and in the conical dredge.

The dimensions of the first dredges were as follows: Frame about 12 in. by about 4 in.; scraping lips about 2 in. wide; all other iron parts of round iron bar 1 in. diameter; bag rather more than 1 ft. long. These small dredges were used from rowing boats. Larger dredges were subsequently made for use from yaws or cutters. The mouth of these was 18 by 5 in., the scraping lips about 2 in. wide and bag 2 ft. deep; such a dredge weighs about 20 lb. The dredge of the "Challenger" had a frame 4 ft. 6 in. by 1 ft. 3 in. and the bag had a length of 4 ft. 6 in.; the "Porcupine" used a dredge of the same size weighing 225 lb. Doubtless the size of Ball's dredge would have grown still more had it not been proved by the "Challenger" expedition that for many purposes trawls could be used advantageously instead of dredges.

Operation of the Dredge from Small Vessels. For work round the coasts of Europe, at depths attainable from a row-boat or yawl, probably the best kind of line is bolt-rope of the best Russian hemp, not less than 1½ in. in circumference, containing 18 to 20 yarns in 3 strands. Each yarn should be nearly a hundredweight, so that the breaking strain of such a rope ought to be about a ton. Of course it is never voluntarily exposed to such a strain, but in shallow water the dredge is often caught among rocks or coral, and the rope should be strong enough in such a case to bring up the boat, even if there were some little way on. It is always well, when dredging, to ascertain the approximate depth with the lead before casting the dredge; and the lead ought always to be accompanied by a registering thermometer, for the subsequent haul of the dredge will gain greatly in value as an observation in geographical distribution, if it be accompanied by an accurate note of the bottom temperature. For depths under 100 fathoms the amount of rope paid out should be at least double the depth; under 30 fathoms, where one usually works more rapidly, it should be more nearly three times; this gives a good deal of slack before the dredge if the boat be moving very slowly, and keeps the lip of the dredge well down. When there is anything of a current, from whatever cause, it is usually convenient to attach a weight, varying from 14 lb to half a hundredweight, to the rope 3 or 4 fathoms in front of the dredge. This prevents in some degree the lifting of the mouth of the dredge; if the weight be attached nearer the dredge it is apt to injure delicate objects passing in.

In dredging in sand or mud, the dredge-rope may simply be passed through the double eye formed by the ends of the two arms of the dredge-frame; but in rocky or unknown ground it is better to fasten the rope to the eye of one of the arms only, and to tie the two eyes together with three or four turns of rope-yarn. This stop breaks much more readily than the dredge-rope, so that if the dredge get caught it is the first thing to give way under the strain, and in doing so it often alters the position of the dredge so as to allow of its extrication.

The dredge is slipped gently over the side, either from the bow or from the stern—in a small boat more usually the latter—while there is a little way on, and the direction which the rope takes indicates roughly whether the dredge is going down properly. When it reaches the ground and begins to scrape, an experienced hand upon the rope can usually detect at once a tremor given to the dredge by the scraper passing over the irregularities of the bottom. The due amount of rope is then paid out, and the rope hitched to a bench or rowlock-pin. The boat should move very slowly, probably not faster than a mile an hour. In still water or with a very slight current the dredge of course anchors the boat, and oars or sails are necessary; but if the boat be moving at all it is all that is required. It is perhaps



FIG. 14.—Ball's Naturalist's Dredge.

most pleasant to dredge with a close-reefed sail before a light wind, with weights, against a very slight tide or current; but these are conditions which cannot be commanded. The dredge may remain down from a quarter of an hour to twenty minutes, by which time, if things go well, it ought to be fairly filled. In dredging from a small boat the simplest plan is for two or three men to haul in, hand over hand, and coil in the bottom of the boat. For a large yawl or yacht, and for depths over 50 fathoms, a winch is a great assistance. The rope takes a couple of turns round the winch, which is worked by two men, while a third hand takes it from the winch and coils it down.

It is easier to operate a dredge from a steam vessel than a sailing boat, but if the steamer is of any size great care should be taken that the dredge does not move too rapidly.

Two ingenious cases of dredging under unusual conditions are worthy of mention, one case from shore, one from ice. In the Trondhjem Fjord, Canon A. M. Norman in 1890 worked by hauling the dredge up the precipitous shores of the fjord. The dredge was shot from a boat close to the shore, to which after paying out some hundreds of fathoms of line it returned. The dredge was then hauled from the top of the cliffs up whose side it scraped. Hitches against projecting rocks were frequent and were overcome by suddenly paying out line for a time. The dredge was lifted into a boat when it reached the surface of the sea. The other case occurred during the Antarctic expedition of the "Discovery." Hodgson dropped loops of line along cracks which occasionally formed in the ice. The ice always joined up again, but with the line below it, and a hole being cleared at each place at which the end of the line emerged, the dredge could be worked between them.

The dredge comes up variously freighted according to the locality, and the next step is to examine its contents and to store the objects of search for future use. In a regularly organized dredging expedition a frame or platform is often erected with a ledge round it to receive the contents of the dredge, but it does well enough to capsize it on an old piece of tarpaulin. There are two ways of emptying the dredge; we may either turn it up and pour out its contents by the mouth, or we may have a contrivance by which the bottom of the bag is made to unlace. The first plan is the simpler and the one more usually adopted, the second has the advantage of letting the mass slide out more smoothly and easily, but the lacing introduces rather a damaging complication, as it is apt to loosen or give way. Any objects visible on the surface of the heap are now carefully removed, and placed for identification in jars or tubs of sea-water, of which there should be a number secured in some form of bottle basket, standing ready. The heap should not be much disturbed, for the delicate objects contained in it have already been unavoidably subjected to a good deal of rough usage, and the less friction among the stones the better.

Examination of the Catch. Sifting.—The sorting of the catch is facilitated by sifting. The sieves used in early English expeditions were of various sizes and meshes, each sieve having a finer mesh than the sieve smaller than itself. In use the whole were put together in the form of a nest, the smallest one with the coarsest mesh being on top. A little of the dredge's contents were then put in the top sieve, and the whole set moved gently up and down in a tub of sea water by handles attached to the bottom one. Objects of different sizes are thus left in different sieves. A simple but effective plan is to let the sieves of various sized mesh fit accurately on each other like lids, the coarsest on top, and to pour water upon material placed on the top one. In the United States Bureau of Fisheries ship "Albatross" these sieves are raised to form a table and the water is led on them from a hose: the very finest objects or sediments are retained by the waste water escaping from a catchment tub by muslin bags let into its sides. Any of these methods are preferable to sifting by the agitation of a sieve hung over the side, as in the last anything passing through the sieve is gone past recall.

Preservation of Specimens.—The preservation of specimens will of course depend on the purpose for which they are intended. For microscopic observation formaldehyde has some advantages.

It can be stored in 40% solution and used in 2%, thus saving space, and it preserves many animals in their colours for a time: formalin preparations do not, however, last as well as do those in spirit. The suitable fluids for various histological inquiries are beyond the scope of the present article; but for general marine histology Bies' fluid is useful, being simple to prepare and not necessitating the removal of the specimen to another fluid. It is composed of 70% alcohol 90 parts, glacial acetic acid 7 parts, 4% formaldehyde 7 parts.

The scientific value of a dredging depends mainly upon two things, the care with which the objects procured are preserved and labelled for future identification and reference, and the accuracy with which all the circumstances of the dredging—the position, the depth, the nature of the ground, the date, the bottom-temperature, &c.—are recorded. In the British Marine Biological Association's work in the North Sea, a separate sheet of a printed book with carbon paper and duplicate sheets (which remain always on the ship) is used for the record of the particulars of each haul, depth, gear, &c., being filled into spaces indicated in the form. This use of previously prepared forms has been found to be a great saving of time and avoids risk of omission. Whether labelled externally or not, all bottles should contain parchment or good paper labels written with a soft pencil. These cannot be lost. The more fully details of reference number of station, gear, date, &c., are given the better, as should a mistake be made in one particular it can frequently be traced and rectified by means of the rest.

Growth of Scope of Operations.—At the Birmingham meeting of the British Association in 1839 an important committee was appointed "for researches with the dredge with a view to the investigation of the marine zoology of Great Britain, the illustration of the geographical distribution of marine animals, and the more accurate determination of the fossils of the Pliocene period." Of this committee Edward Forbes was the ruling spirit, and under the genial influence of his contagious enthusiasm great progress was made during the next decade in the knowledge of the fauna of the British seas, and many wonderfully pleasant days were spent by the original committee and by many others who from year to year were "added to their number." Every annual report of the British Association contains communications from the English, the Scottish, or the Irish branches of the committee, and in 1850 Edward Forbes submitted its first general report on British marine zoology. This report, as might have been anticipated from the eminent qualifications of the reporter, was of the highest value; and, taken along with his remarkable memoirs previously published, "On the Distribution of the Mollusca and Radiata of the Aegean Sea," and "On the Zoological Relations of the existing Fauna and Flora of the British Isles," may be said to mark an era in the progress of human thought.

The dredging operations of the British Association committee were carried on generally under the idea that at the 100-fathom line, by which amateur work in small boats was practically limited, the zero of animal life was approached—a notion which was destined to be gradually undermined, and finally overthrown. From time to time, however, there were not wanting men of great skill and experience to maintain, with Sir James Clark Ross, that "from however great a depth we may be enabled to bring up mud and stones of the bed of the ocean we shall find them teeming with animal life." Samples of the sea-bottom procured with great difficulty and in small quantity from the first deep soundings in the Atlantic, chiefly by the use of Brooke's sounding machine, an instrument which by a neat contrivance disengaged its weights when it reached the bottom, and thus allowed a tube, so arranged as to get filled with a sample of the bottom, to be recovered by the sounding line, were eagerly examined by microscopists; and the singular fact was established that these samples consisted over a large part of the bed of the Atlantic of the entire or broken shells of certain foraminifera. Dr Wallich, the naturalist to the "Bulldog" sounding expedition under Sir Leopold M'Clintock, reported that star-fishes, with their stomachs full of the deep-sea foraminifera, had come

up from a depth of 1200 fathoms on a sounding line; and doubts began to be entertained whether the bottom of the sea was in truth a desert, or whether it might not present a new zoological region open to investigation and discovery, and peopled by a peculiar fauna suited to its special conditions.

In the year 1867, while the question was still undecided, two testing investigations were undertaken independently. In America Count L. F. de Pourtales (1824-1880), an officer employed in the United States Coast Survey under Benjamin Peirce, commenced a series of deep dredgings across the Gulf Stream off the coast of Florida, which were continued in the following year, and were productive of most valuable results; and in Great Britain the Admiralty, on the representation of the Royal Society, placed the "Lightning," a small gun-vessel, at the disposal of a small committee to sound and dredge in the North Atlantic between Shetland and the Farøe Islands.

In the "Lightning," with the help of a donkey-engine for winding in, dredging was carried on with comparative ease at a depth of 600 fathoms, and at that depth animal life was found to be still abundant. The results of the "Lightning's" dredgings were regarded of so great importance to science that the Royal Society pressed upon the Admiralty the advantage of continuing the researches, and accordingly, during the years 1869 and 1870, the gun-boat "Porcupine" was put under the orders of a committee consisting of Dr W. B. Carpenter, Dr Gwyn Jeffreys, and Professor (afterwards Sir Charles) Wyville Thomson, one or other of whom superintended the scientific work of a series of dredging trips in the North Atlantic to the north and west of the British Islands, which occupied two summers.

In the "Porcupine," in the summer of 1869, dredging was carried down successfully to a depth of 2435 fathoms, upwards of two miles and a half, in the Bay of Biscay, and the dredge brought up well-developed representatives of all the classes of marine invertebrates. During the cruises of the "Porcupine" the fauna of the deep water off the western coasts of Great Britain and of Spain and Portugal was tolerably well ascertained, and it was found to differ greatly from the fauna of shallow water in the same region, to possess very special characters, and to show a very marked relation to the faunae of the earlier Tertiary and the later Cretaceous periods.

In the winter of 1872, as a sequel to the preliminary cruises of the "Lightning" and "Porcupine," by far the most considerable expedition in which systematic dredging had ever been made a special object left Great Britain. H.M.S. "Challenger," a corvette of 2306 tons, with auxiliary steam working to 1234 h.p., was despatched to investigate the physical and biological conditions of the great ocean basins.

The "Challenger" was provided with a most complete and liberal organization for the purpose; she had powerful deck engines for hauling in the dredge, workrooms, laboratories and libraries for investigating the results on the spot, and a staff of competent naturalists to undertake such investigations and to superintend the packing and preservation of the specimens reserved for future study. Since the "Challenger" expedition the use of wire rope has enabled far smaller vessels to undertake deep sea work. The "Challenger," however, may be said to have established the practicability of dredging at any known depth.

Operating Dredges and Trawls in deep Seas.—Dredging operations from large vessels in deep seas present numerous difficulties. The great weight of the ship makes her motion, whether of progress or rolling, irresistible to the dredge. The latter tends to jump, therefore, which both lowers its efficiency and causes it to exert a sudden strain on the dredge rope.

The efficiency or evenness of dredging was secured, therefore, by the special device of fastening a heavy weight some 200 or 300 fathoms from the dredge end of the dredge rope. This was either lowered with the dredge or sent down after by means of a "messenger," a ring of rope fixed round, but running freely on, the dredge rope. The latter plan was used on the "Challenger"; the weights were six 28 lb leads in canvas

covers: their descent was arrested by a toggle or wooden cross-bar previously attached to the rope at the desired point. When, however, the rope used is of wire this front weight is unnecessary.

The possibility of sudden strain necessitates a constant watching of the dredge rope, as the ship's engines may at any moment be needed to ease the tension by stopping the vessel's way, and the hauling engines by paying out more rope. The use of accumulators both renders the strain more gradual and gives warning of an increase or decrease; indeed they can be calibrated and used as dynamometers to measure the strain. One of the best forms of accumulator consists of a pile of perforated rubber disks, which receive the strain and become compressed in doing so. The arrangement is in essence as follows. The disks form a column resting on a cross-bar or base, from which two rods pass up one on each side of the column. Another cross-bar rests on the top disk, and from it a rod passes freely down the centre perforation of disks and base. Eyes are attached to the lower end of this rod and to a yoke connecting the side rods at the top: a pull exerted on these eyes is thus modified by the elasticity of the dredge. In the "Porcupine" and other early expeditions the accumulator was hung from the main yard arm, and the block through which the dredge rope ran suspended from it. In more recent ships a special derrick boom is rigged for this block, and a second accumulator is sometimes inserted between the topping lift by which this is raised and the end of the boom.

The margin of safety of steel wire rope is much larger than is that of hempen rope, a fact of importance both in towing in a rough sea and in hauling. Galvanized steel wire with a hempen core was first used by Agassiz on the "Blake." He states that his wire weighed one pound per fathom, against two pounds per fathom of hempen rope, and had a breaking strain nearly twice that of hempen rope, which bore two tons. Thus in hauling the wire rope has both greater capability and less actual strain. It has also the advantages of occupying a mere fraction ($\frac{1}{4}$) of the storage space needed for rope, of lasting much longer, and its vibrations transmit much more rapid and minute indications of the conduct of the dredge.

Wire rope is kept wound on reels supplied with efficient brakes to check or stop its progress, and an engine is often fitted for winding it in and veering it out. From the reel it passes to the drum of the hauling engine, round which it takes some few turns; care is taken by watching or by the use of an automatic regulator (Tanner) that it is taken at a rate equal to that at which it is moving over the side. From the hauling engine it passes over leading wheels (one of which should preferably be a registering wheel and indicate the amount of rope which has passed it), and so it reaches the end of the derrick boom.

The dredge is lowered from the derrick boom, which has been previously trained over to windward so that its end is well clear of the ship, while the ship is slowly moving forward. The rope is checked until the net is seen to be towing clear, and then lowered rapidly. Where a weight is used in front of the trawl Captain Calver successfully adopted the plan of backing after sufficient line had been paid out: the part of the rope from weight to surface thus became more vertical, while the shorter remainder, previously in line with it, sank to the bottom without change of relative position of weight and dredge. The ship was then ready for towing. When no front weight is used the manœuvre is unnecessary.

There should be a relation maintained between speed of vessel onward and of rope downward, or a foul haul may result owing to the gear capsizing (in the case of a trawl), or getting the net over the mouth (in a dredge). The most satisfactory method of ensuring this relation seems to be so to manage the two speeds that the angle made by the dredge rope is fairly constant. This angle can be observed with a simple clinometer. The following table abridged from Tanner most usefully brings together the requisite angles with other useful quantities.

Depth of water.	Speed of ship while shooting dredge or trawl.	Length of rope required.	Angle of dredge rope while lowering trawl.	Angle of dredge rope while dragging trawl.
Fathoms.	Knots.	Fathoms.		
100	3	200	60	55
200	3	400	60	55
400	3	700	60	52
800	2½	1000	55	50
1000	2½	1200	50	44
1500	2½	1500	50	40
2000	2	2166	50	40
3000	2	2670	45	35
	2	4000	40	35

The speed of towing, always slow, may be assumed to be approximately correct if the appropriate angle is maintained. Hauling should at first be slow from great depths, but may increase in speed as the gear rises.

For further details of deep-sea dredging, especially of the hauling machinery and management of the gear, the special reports of the various expeditions must be consulted. Commander Tanner, U.S.N., has given in *Deep Sea Exploration* (1897) a very full and good account of the equipment of an exploring ship; and to this book the present article is much indebted.

Modifications and Additions to the Dredge.—From 1818, when Sir John Ross brought up a fine *Astrophyton* from over 800 fathoms on a sounding line in Baffin's Bay, instances gradually accumulated of specimens being obtained from great depths without nets or traps. The naturalists of the "Porcupine" and other expeditions found that echinoderms, corals and sponges were often carried up adhering to the outer surface of the dredge and the last few fathoms of dredge rope. In order to increase the effectiveness of this method of capture a bar was fastened to the bottom of the dredge, to which bunches of teased-out hemp were tied. In this way specimens of the greatest interest, and frequently of equal importance with those in the dredge

bag, were obtained. The tangle bar was at first attached to the back of the net. From the "Challenger" expedition onward it has been fixed behind the net by iron bars stretching back from the short sides of the dredge frame which pass through eyes in their first ends (fig. 15). The swabs are thus unable to fold over the mouth of the dredge. Rope lashings to the lips of the dredge are sometimes added, and a weight is tied to the larger bar to keep it down.



FIG. 15.—Deep-sea Dredge, with Tangle Bar.

Occasionally the tangle bar is used alone (Agassiz), and one form (Tanner) has two bars, stretching back like the side strokes of the letter A from a strong steel spring in the form of an almost complete circle. The whole is pulled forward from a spherical sinker fastened in front of the spring apex; and should the apex enter a crevice between rock masses, the side bars are closed by the pressure instead of catching and bringing up. This is said to be a very useful instrument among corals.

The Blake Dredge.—In the soft ooze which forms the bottom of deep seas the common dredge sinks and digs much too deeply for its ordinary purpose, owing partly to its chief weight bearing on the frame only, partly to its everted lips. To obviate these defects Lieutenant Commander Sigbee of the "Blake" devised the Blake dredge. Its novel features were the frame and lips. The former was in the form of a skeleton box; that is, a rectangle of iron bars was placed at the back as well as the front or mouth of the net and four more iron bars connected the two rectangles. The lips instead of being everted were in parallel planes—those, namely, of the top and bottom of the net. The effect of this was to minimize digging and somewhat spread the incidences of the weight. Another advantage was that the net being constantly distended by its frame, and, moreover, protected top and bottom by an external shield of canvas, quite delicate specimens reached the surface uninjured. The dredge weighed 80 lb and was 4 ft. square and 9 in. deep.

Rake Dredges.—These are devices for collecting burrowing creatures without filling the dredge with the soil in which they live. Holt used, at Plymouth, a dredge whose side bars and lower lip were of iron, the latter armed with forward and downward pointing teeth which stirred up the sand and its denizens in front of the dredge mouth. The upper lip of the dredge was replaced by a bar of wood. The bag was of cheese-cloth or light open canvas, and the whole was of light construction. The apparatus was very useful in capturing small burrowing crustacea. The Chester rake dredge is a Blake dredge in front of which is secured a heavy iron rectangle with teeth placed almost at right angles to its long sides and in the plane of the rectangle. Each of these instruments has a width along the scraping edge of about 3 ft.

Triangular and Conical Dredges.—Two other dredges are worthy of mention. The triangular dredge, much resembling Muller's but with a triangular mouth, and hung by chains from its angles, is an

old fashion now not in general use. It is, however, very useful for rocky ground. At the Plymouth marine laboratory was also devised the conical dredge (1901), the circular form being the suggestion of Garstang. This dredge (fig. 16) was intended for digging deeply. It is of wrought iron, and of the following dimensions: diameter of mouth 16 in., length 33 in., depth of ring at mouth 9 in., its weight is 67 lb. As at first used the spaces between the bars are closed by wire netting; if used for collecting bottom samples it is furnished with a lining of strong sail-cloth.

Its weight and the small length of edge in contact with the ground cause this dredge to dig well, and enable the user to obtain many objects which though quite common are of rare occurrence in an ordinary dredge. Thus on the Brown Ridges, a fishing-ground west of Holland, although *Donax vittatus* is known from examination of fish stomachs to be abundant, it is rarely taken except in the conical dredge; the same is true of *Echinocyamus pusillus*, which is in many parts of the North Sea abundant in bottom samples and in no ordinary dredgings.

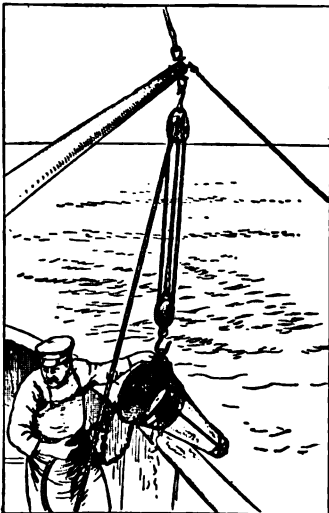

FIG. 16.—Conical Dredge being hoisted in.

With the sail-cloth lining the conical dredge fills in about 10 minutes on most ground, and no material washing out of fine sediment occurs on hauling. In shallow seas such as the North Sea commercial beam and other trawls are now used as quantitative instruments in the estimation of the fish population, especially of the *Pleuronectidae*.

Use of Small Trawls for Dredging.—Although these trawls do not here concern us, certain adaptations of small beam trawls for biological exploration are of such identical use with the dredge, and differ from it so little in structure and size, that they may be here described.

A small beam trawl was first used from the "Challenger" (fig. 17). It was sent down in 600 fathoms off Cape St Vincent, the reason for its use being the frequency with which the dredge sank into the sea-bottom and there remained until hauling. The experiment was entirely successful. The sinking of the net was avoided, the net had a much greater spread than the dredge, and in addition to invertebrates it captured several fish. After this the trawl was frequently used instead of the dredge. Indeed tangle bar, dredge and trawl form a series which are fitted for use on the roughest, moderately rough and fairly firm, and the softest ground respectively, although the dredge can be used almost anywhere.

The frame of the "Challenger" trawl consisted of a 15 ft. wooden beam which in use was drawn over the sea-bed on two runners resembling those of a sledge, by means of two ropes or bridle attached to eyes in the front of the runners or "trawl heads." A net 30 ft. long was suspended by one side to the beam by half-a-dozen stops. The remainder of the net's mouth was of much greater length than the beam, and was weighted with close-set rolls of sheet lead; it thus dragged along the bottom in a curve approximately to a semicircle, behind the beam. The net tapers towards the hinder end, and contains a second net with open bottom, which, reaching about three-quarters of the way down the main net, acts as a valve or pocket. Both heels (or hinder ends) of the trawl heads and the tail of the net were weighted to assist the net in digging sufficiently and to maintain its balance—an important point, since if the trawl lands on its beam the net's mouth remains closed, and nothing is caught.

The main differences of this trawl from the dredge are the replacement of scraping lip by ground rope, the position of this ground rope



From Sir Charles Wyville Thomson's *Report of the "Challenger"*. By permission of Macmillan & Co., Ltd.

FIG. 17.—Trawl of the "Challenger."



Fig. 3.—Barge-loading dredger, "St Austell," constructed for the British Government by Wm. Simons & Co.



Fig. 4.—Stern-well hopper-dredger "La Puissante," by Wm. Simons & Co. Length 275 ft., breadth 47 ft., depth 19 ft.



Fig. 5.—Dredger constructed for the Lake Copais Co. by Hunter & English.



Fig. 6.—Light-draught dredger, with delivery apparatus working round an arc of 210° , by Hunter & English.



Fig. 7.—Twin-screw sand-pump dredger, "Kate," built for the East London Harbour Board by Wm. Simons & Co.



Fig. 8.—Twin-screw hopper-dredger, "Percy Sanderson," built for the European Danube Commission by Wm. Simons & Co.



Fig. 9.—Twin-screw grab-dredger, "Miles K. Burton," built for the Mersey Docks and Harbour Board by Wm. Simons & Co.



Fig. 10.—Hopper-dredger, "David Dale," with buckets of 54 cub. ft. capacity (see fig. 11) built for the North Eastern Railway Company by Lobnitz & Co.

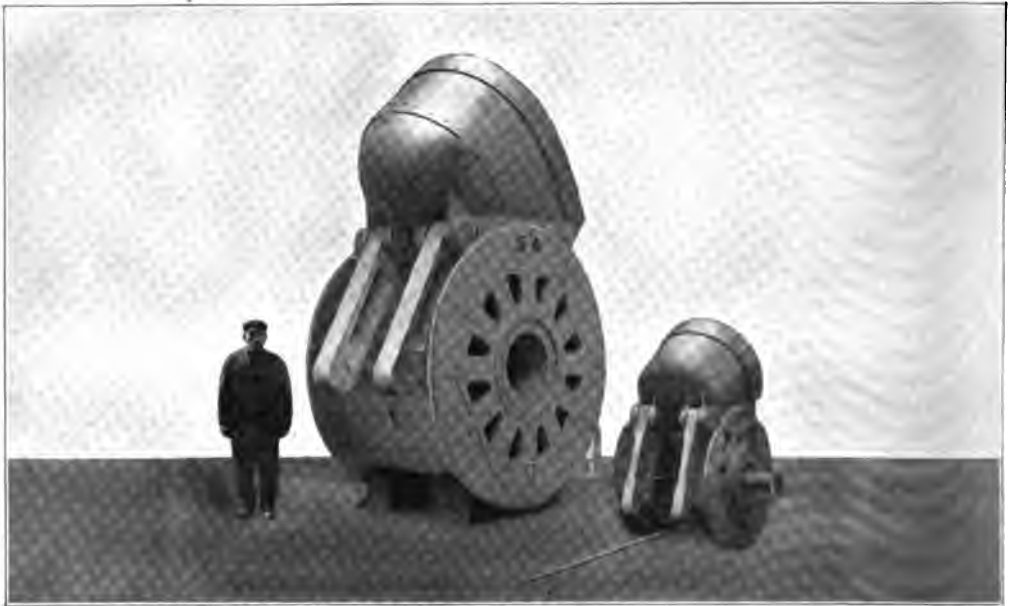

Fig. 11.—Buckets of 5 and 54 Cubic Feet Capacity Compared. The latter, the largest ever made, were for the hopper-dredger "David Dale" (Plate I, fig. 10), built by Lobnitz & Co.

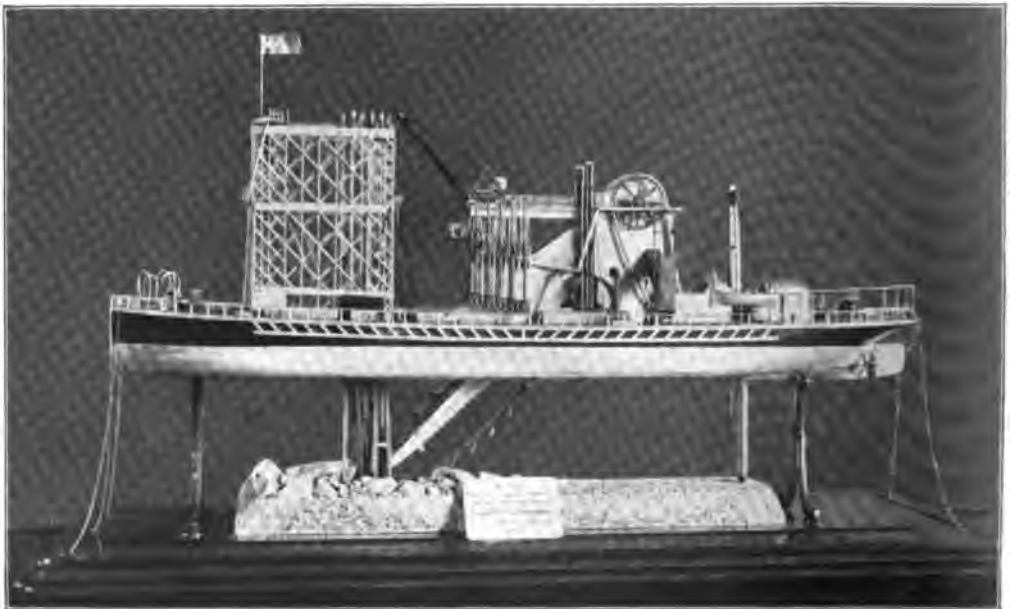

Fig. 12.—Model of Rock-cutting Dredger, "Dérocheuse." Built for special work on the Suez Canal by Lobnitz & Co. Length 180 ft., breadth 40 ft., depth 12 ft.

and the greater size of the mouth. The absence of a lip makes it less effective for burrowing and sessile creatures, but the weighted ground rope nevertheless secures them to a very surprising extent. The position of the ground rope is an important feature, as any free swimming creature not disturbed until the arrival of the ground rope cannot escape by simply rising or "striking" up. This and the greater spread make the trawl especially suitable for the collection of fishes and other swiftly moving animals. The first haul of the "Challenger" trawl brought up fishes, and most of our knowledge of fish of the greatest depths is due to it.

A tendency to return to the use of the small beam trawl for deep-sea work has lately shown itself. That used by Tanner on the "Albatross" has runners more heart-shaped than the "Challenger's" instrument; the net is fastened to the downward and backward sloping edge of the runner as well as to the beam, being thus fixed on three sides instead of one; and a Norwegian glass float is fastened in a network cover to that part of the net which is above and in front of the ground rope in use, to assist in keeping the opening clear.

These floats can stand the pressure at great depths, and do not become waterlogged as do cork floats. The largest "Albatross" trawl has a beam 11 ft. long, runners 2 ft. 5 in. high, and its frame weighs 275 lb.

Agassiz or Blake Trawl.—This is generally considered to possess advantages over the preceding, and is decidedly better for those not experts in trawling. Its frame (fig. 18) consists of two iron runners each the shape of a capital letter D, joined by iron rods or pipes which connect the middle of each stroke with the corresponding point on the other letter. The net is a tapering one, its mouth being a strong rope bound with finer rope for protection till the whole reaches a thickness of some 2 in. It is fastened to the frame at four points only, the ends of the curved rods, and thus has a rectangular opening.

From Alexander E. Agassiz's *Three Crustacea of the "Blake"*. By permission of Houghton, Mifflin & Co.
FIG. 18.—Agassiz or Blake Trawl.

The chief advantage of this frame is that it does not matter in the least which side lands first on the bottom; it is to the other trawls what Ball's dredge is to an oyster dredge. The course can also be altered during shooting or towing the Blake trawl with far greater ease than in the case with others. An Agassiz trawl very successful in the North Sea has the following dimensions: length of the connecting rods and therefore of the mouth 8 ft., height of runners and of mouth 1 ft. 9 in., extreme length of runners 2 ft., length of net 11 ft. 3 in., weight of whole trawl 94 lb, 63 of which are due to the frame.

It is instructive to note how closely our knowledge of bottom-living forms has been associated with the instruments of capture in use. As long as small vessels were used in dredging, the belief that life was limited to the regions accessible to them was widely spread. The first known denizens of great depths were the foraminifera and few echinoderms brought up by various sounding apparatus. Next with the dredge and tangles the number of groups obtained was much greater. As soon as trawls were adopted fish began to make their appearance. The greatest gaps in our knowledge still probably occur in the large and swiftly moving forms, such as fish and cephalopods. As we can hardly hope to move apparatus swiftly over the bottom in great depths, the way in which improvement is possible probably is that of increasing the spread of the nets; and a start in this direction appears to have been made by Dr Petersen, who has devised a modified otter sieve which catches fish at all events very well, and has been operated already at considerable depths.

Of the economy of quite shallow seas, however, we are still largely ignorant. Much as has been learnt of the bionomics of the sea, it is but a commencement; and this is of course especially true of deep seas. The dredge and its kindred have, however, in less than a century enabled naturalists to compile an immense mass of knowledge of the structure, development, affinities and distribution of the animals of the sea-bed, and in the most accessible seas to produce enumerations and morphological accounts of them of some approach to completeness. (J. O. B.)

DREINCOURT, CHARLES (1595-1669), French Protestant divine, was born at Sedan on the 10th of July 1595. In 1618 he undertook the charge of the French Protestant church at Langres, but failed to receive the necessary royal sanction, and early in 1620 he removed to Paris, where he was nominated

minister of the Reformed Church at Charenton. He was the author of a large number of works in devotional and polemical theology, several of which had great influence. His *Catechism* (*Catéchisme ou instruction familière*, 1652) and his *Christian's Defense against the Fears of Death* (*Consolations de l'âme fidèle contre les frayeurs de la mort*, 1651) became well known in England by means of translations, which were very frequently reprinted. It has been said that Daniel Defoe wrote his fiction of Mrs Veal (*A True Relation of the Apparition of Mrs Veal*), who came from the other world to recommend the perusal of *Dreincourt on Death*, for the express purpose of promoting the sale of an English translation of the *Consolations*; Defoe's contribution is added to the fourth edition of the translation (1706). Another popular work of his was *Les Visites charitables pour toutes sortes de personnes affligées* (1669). Dreincourt's controversial works were numerous. Directed entirely against Roman Catholicism, they did much to strengthen and consolidate the Protestant party in France. He died on the 3rd of November 1669.

Several of his sons were distinguished as theologians or physicians. Laurent (1626-1681) became a pastor, and was the author of *Sonnets chrétiens sur divers sujets* (1677); Charles (1633-1697) was professor of physic at the university of Leiden, and physician to the prince of Orange; Peter (1644-1722) was ordained a priest in the Church of England, and became dean of Armagh.

DRENTE, a province of Holland, bounded N. and N.E. by Groningen, S.E. by the Prussian province of Hanover, S. and S.W. by Overysel, and N.W. by Friesland; area, 1128 sq. m.; pop. (1900) 149,551. The province of Drente is a sandy plateau forming the kernel of the surrounding provinces. The soil consists almost entirely of sand and gravel, and is covered with bleak moorland, patches of wood, and fen. This is only varied by the strip of fertile clay and grass-land which is found along the banks of the rivers, and by the areas of high fen in the south-eastern corner and on the western borders near Assen. The surface of the province is a gentle slope from the south-west towards the north-east, where it terminates in the long ridge of hills known as the Hondsrug (Dog's Back) extending along the eastern border into Groningen. The watershed of the province runs from east to west across the middle of the province, along the line of the Orange canal. The southern streams are all collected at two points on the southern borders, namely, at Meppel and Koeverden, whence they communicate with the Zwart Water and the Vecht respectively by means of the Meppeler Diep and the Koeverden canal. The Stenwyker Aa, however, enters the Zuider Zee independently. The northern rivers all flow into Groningen. The piles of granite rocks somewhat in the shape of cromlechs which are found scattered about this province, and especially along the western edge of the Hondsrug, have long been named *Hunebedden*, from a popular superstition that they were "Huns' beds." Possibly the word originally meant "beds of the dead," or tombs.

Two industries have for centuries been associated with the barren heaths and sodden fens so usually found together on the sand-grounds, namely, the cultivation of buckwheat and peat-digging. The work is conducted on a regular system of fen colonization, the first operation being directed towards the drainage of the country. This is effected by means of drainage canals cut at regular intervals and connected by means of cross ditches. These draining ditches all have their issue in a main drainage canal, along which the transport of the peat and peat-litter takes place and the houses of the colonists are built. The heathlands when sufficiently drained are prepared for cultivation by being cut into sods and burnt. This system appears to have been practised already at the end of the 17th century. After eight years, however, the soil becomes exhausted, and twenty to thirty years are required for its refertilization. The cultivation of buckwheat on these grounds has decreased, and large areas which were formerly thus treated now lie waste. Potatoes, rye, oats, beans and peas are also largely cultivated. In connexion with the cultivation of potatoes, factories are established for making spirits, treacle, potato-meal, and straw-paper.

Furthermore, agriculture is everywhere accompanied on the sand-grounds by the rearing of sheep and cattle, which assist in fertilizing the soil. Owing to the meagreness of their food these animals are usually thin and small, but are quickly restored when placed on richer grounds. The breeding of pigs is also widely practised on the sand-grounds, as well as forest culture. Of the fen-colonies in Drente the best known are those of Frederiksoord and Veenhuizen.

Owing to the general condition of poverty which prevailed after the French evacuation in the second decade of the 19th century, attention was turned to the means of industry offered by the unreclaimed heath-lands in the eastern provinces, and in 1818 the Society of Charity (*Maatschappij van Weldadigheid*) was formed with Count van den Bosch at its head. This society began by establishing the free agricultural colony of Frederiksoord, about 10 m. N. of Meppel, named after Prince Frederick, son of William I., king of the Netherlands. An industrious colonist could purchase a small farm on the estate and make himself independent in two years. In addition to this, various industries were set on foot for the benefit of those who were not capable of field work, such as mat and rope making, and jute and cotton weaving. In later times forest culture was added, and the Gerard Adriaan van Swieten schools of forestry, agriculture and horticulture were established by Major van Swieten in memory of his son. A Reformed and a Roman Catholic church are also attached to the colony. To this colony the Society of Charity later added the adjoining colonies of Willemsoord and Kolonie VII. in Overysel, and Wilhelminasoord partly in Friesland. The colony of Veenhuizen lies about 7 m. N.W. of Assen, and was founded by the same society in 1823. In 1859, however, the Veenhuizen estates were sold to the government for the purpose of a penal establishment for drunkards and beggars.

Owing to its geographical isolation, the development of Drente has remained behind that of every other province in the Netherlands, and there are few centres of any importance, either agricultural or industrial. Hence the character and customs of the people have remained peculiarly conservative. Assen is the chief town. In the south Meppel and Koevorden absorb the largest amount of trade. Hooerveen, situated between these two, owes its origin to the fen reclamation which was begun here in 1625 by Baron van Echten. In the following year it was erected into a barony which lasted till 1795. The original industry has long since moved onwards to other parts, but the town remains a prosperous market centre, and has a considerable industrial activity. Extensive fir woods have been laid out in the neighbourhood. Zuidlaren is a picturesque village at the northern end of the Hondsrug, with an important market. The railway from Amsterdam to Groningen traverses Drente; branch lines connect Meppel with Leeuwarden and Assen with Delfzijl.

History.—The early history of Drente is obscure. That it was inhabited at a remote date is proved by the prehistoric sepulchral mounds, the *Hunebedden* already mentioned. In the 5th and 6th centuries the country was overrun by Saxon tribes, and later on was governed by counts under the Frankish and German kings. Of these only three are recorded, Eberhard (943–944), Balderic (1006) and Temmo (1025). In 1046 the emperor Henry III. gave the countship to the bishop and chapter of Utrecht, who governed it through the burgrave, or châtelain, of Koevorden, a dignity which became hereditary after 1143 in the family of Ludolf or Roelof, brother of Heribert of Bierum, bishop of Utrecht (1138–1150). This family became extinct in the male line about 1232, and was succeeded by Henry I. of Borculo (1232–1261), who had married the heiress of Roelof III. of Koevorden. In 1395 Reinald IV. (d. 1410) of Borculo-Koevorden was deposed by Bishop Frederick of Utrecht, and the country was henceforth administered by an episcopal official (*amptman*), who was, however, generally a native. With its popularly elected assembly of twenty-four Etten (*jurati*) Drente remained practically independent. This state of things continued till 1522, when it was conquered by Duke Charles of Gelderland, from whom it was taken by the emperor Charles V. in 1536, and became part of the Habsburg dominions.

Drente took part in the revolt of the Netherlands, and being a district covered by waste heath and moor was, on account of its poverty and sparse population, not admitted into the union as a separate province, and it had no voice in the assembly of the states-general. It was subdued by the Spaniards in 1580, but reconquered by Maurice of Nassau in 1594. During the years that followed, Drente, though unrepresented in the states-general, retained its local independence and had its own stadtholder. William Louis of Nassau-Siegen (d. 1620) held that office, and it was held later by Maurice, Frederick Henry, William II. and William III., princes of Orange. At the general assembly of 1651 Drente put forward its claim to admission as a province, but was not admitted. After the deaths of William II. (1650) and of William III. (1702) Drente remained for a term of years without a stadtholder, but in 1722 William Charles Henry of the house of Nassau-Siegen, who, through the extinction of the elder line, had become prince of Orange, was elected stadtholder. His descendants held that office, which was declared hereditary, until the French conquest in 1795. In the following year Drente at length obtained the privilege, which it had long sought, of being reckoned as an eighth province with representation in the states-general. Between 1806 and 1813 Drente, with the rest of the Netherlands, was incorporated in the French empire, and, with part of Groningen, formed the department of Ems Occidental. With the accession of William I. as king of the Netherlands it was restored to its old position as a province of the new kingdom.

DRESDEN, a city of Germany, capital of the kingdom of Saxony, 71 m. E.S.E. from Leipzig and 111 m. S. from Berlin by railway. It lies at an altitude of 402 ft. above the Baltic, in a broad and pleasant valley on both banks of the Elbe. The prospect of the city with its cupolas, towers, spires and the copper green roofs of its palaces, as seen from the distance, is one of striking beauty. On the left bank of the river are the Altstadt (old town) with four old suburbs and numerous new suburbs, and the Friedrichstadt (separated from the Altstadt by a long railway viaduct); on the right, the Neustadt (new town), Antonstadt, and the modern military suburb Alberstadt. Five fine bridges connect the Altstadt and Neustadt. The beautiful central bridge—the Alte or Augustusbrücke—with 16 arches, built in 1727–1731, and 1420 ft. long, has been demolished (1906) and replaced by a wider structure. Up-stream are the two modern Albert and Königin Carola bridges, and, down-stream, the Marien and the Eisenbahn (railway) bridges. The streets of the Altstadt are mostly narrow and somewhat gloomy, those of the Neustadt more spacious and regular.

On account of its delightful situation and the many objects of interest it contains, Dresden is often called "German Florence," a name first applied to it by the poet Herder. The richness of its art treasures, the educational advantages it offers, and its attractive surroundings render it a favourite resort of people with private means. There are a large number of foreign residents, notably Austro-Hungarians and Russians, and also a considerable colony of English and Americans, the latter amounting to about 1500. The population of the city on the 1st of December 1905 was 516,996, of whom 338,776 lived on the left bank (Altstadt) and 158,220 on the right (Neustadt). The royal house belongs to the Roman Catholic confession, but the bulk of the inhabitants are Lutheran Protestants.

Dresden is the residence of the king, the seat of government for the kingdom of Saxony, and the headquarters of the XII. (Saxon) Army Corps. Within two decades (1880–1900) the capital almost at a single bound advanced into the front rank of German commercial and industrial towns; but while gaining in prosperity it has lost much of its medieval aspect. Old buildings in the heart of the Altstadt have been swept away, and their place occupied by modern business houses and new streets. Among the public squares in the Altstadt must be mentioned the magnificent Theaterplatz, with a fine equestrian statue of King John, by Schilling; the Altmarkt, with a monument commemorative of the war of 1870–71; the Neumarkt, with a bronze statue of King Frederick Augustus II., by E. J. Hähnel;

the Postplatz, adorned by a Gothic fountain, by Semper; and the Bismarckplatz in the Anglo-American quarter. In the Neustadt are the market square, with a bronze equestrian statue of Augustus the Strong; the Kaiser Wilhelmplatz; and the Albertplatz. The continuous Schloss-, See- and Prager-Strasse, and the Wildstruffer- and König Johann-Strasse are the main streets in the Altstadt, and the Hauptstrasse in the Neustadt.

The most imposing churches include the Roman Catholic Hofkirche, built (1739-1751) by C. Chiaveri, in the rococo style, with a tower 300 ft. high. It contains a fine organ by Silbermann and pictures by Raphael Mengs and other artists, the outside being adorned with 59 statues by Mattielli. On the Neumarkt is the Frauenkirche, with a stone cupola rising to the height of 311 ft.; close to the Altmarkt, the Kreuzkirche, rebuilt after destruction by fire in 1897, also with a lofty tower surmounted by a cupola; and near the Postplatz the Sophienkirche, with twin spires. In the Neustadt is the Dreikönigskirche (dating from the 18th century) with a high pinnacled tower. Among more modern churches may be mentioned: in the Altstadt, the Johanneskirche, with a richly decorated interior; the Lukas-kirche; and the Trinitatiskirche; and in the Neustadt, the Martin Luther-Kirche and the new garrison church. Apart from the chapels in the royal palaces, Dresden contains in all 32 churches, viz. 21 Evangelical, 6 Roman Catholic, a Reformed, a Russian, an English (erected by Gilbert Scott) with a graceful spire, a Scottish (Presbyterian), and an American (Episcopal) church, the last a handsome building, with a pretty parsonage attached.

Of secular buildings, the most noteworthy are grouped in the Altstadt near the river. The royal palace, built in 1530-1535 by Duke George (and thus called Georgenschloss), was thoroughly restored, and in some measure rebuilt between 1890 and 1902, in German Renaissance style, and is now an exceedingly handsome structure. The Georgentor has been widened, and through it, and beneath the royal apartments, vehicular traffic from the centre of the town is directed to the Augustusbrücke. The whole is surmounted by a lofty tower—387 ft.—the highest in Dresden. The interior is splendidly decorated. In the palace chapel are pictures by Rembrandt, Nicolas Poussin, Guido Reni and Annibale Caracci. The adjoining Prinzen-Palais on the Taschenberg, built in 1715, has a fine chapel, in which are various works of S. Torelli; it has also a library of 20,000 volumes. The Zwinger, begun in 1711, and built in the rococo style, forms an enclosure, within which is a statue of King Frederick Augustus I. It was intended to be the vestibule to a palace, but now contains a number of collections of great value. Until 1846 it was open at the north side; but this space has since been occupied by the museum, a beautiful Renaissance building, the exterior of which is adorned by statues of Michelangelo, Raphael, Giotto, Dante, Goethe and other artists and poets by Rietschel and Hähnel, and it contains the famous picture gallery. The Brühl palace, built in 1737 by Count Brühl, the minister of Augustus II., has been in some measure demolished to make room for the new Ständehaus (diet house), with its main façade facing the Hofkirche; before the main entrance there is an equestrian statue (1906) of King Albert. Close by is the Brühl Terrace, approached by a fine flight of steps, on which are groups, by Schilling, representing Morning, Evening, Day and Night. The terrace commands a view of the Elbe and the distant heights of Loschwitz and the Weisser Hirsch, but the prospect has of late years become somewhat marred, owing to the extension of the town up the river and to the two new up-stream bridges. The Japanese palace in the Neustadt, built in 1715 as a summer residence for Augustus II., receives its name from certain oriental figures with which it is decorated; it is sometimes called the Augusteum and contains the royal library. Among other buildings of note is the Hoftheatre, a magnificent edifice in the Renaissance style, built after the designs of Semper, to replace the theatre burnt in 1869, and completed in 1878. A new town hall of huge dimensions, also in German Renaissance, with an octagon tower 400 ft. in height, stands on the former southern ramparts of the inner town, close to the Kreuzkirche. In the Altstadt the most striking of the newer edifices is the Kunstakademie, constructed

from designs by K. Lipsius in the Italian Renaissance style—1890-1894. The Albertinum, formerly the arsenal, built in 1559-1563, was rebuilt 1884-1889, and fitted up as a museum of oriental and classical antiquities, and as the depository of the state archives. On the right bank of the Elbe in Neustadt stand the fine buildings of the ministries of war, of finance, justice, the interior and education. The public monuments of Dresden also include the Moritz Monument, a relief dedicated by the elector Augustus to his brother Maurice, a statue of Weber the composer by Rietschel, a bronze statue of Theodor Körner by Hähnel, the Rietschel monument on the Brühl Terrace by Schilling, a bust of Gutzkow, and a statue of Bismarck on the promenade. In the suburbs which encircle the old town are to be noted the vast central Hauptbahnhof (1893-1898) occupying the site of the old Böhmischer railway station, the new premises of the municipal hospital and the Ausstellungen-Halle (exhibition buildings).

The chief pleasure-ground of Dresden is the Grosser Garten, in which there are a summer theatre, the Rietschel museum, and a château containing a museum of antiquities. The latter is composed chiefly of objects removed from the churches in consequence of the Reformation. Near the château is the zoological garden, formed in 1860, and excellently arranged. A little to the south of Dresden, on the left bank of the Elbe, is the village Räcknitz, in which is Moreau's monument, erected on the spot where he was mortally wounded in 1813. The mountains of Saxon Switzerland are seen from this neighbourhood.

Art.—Dresden owes a large part of its fame to its extensive artistic, literary and scientific collections. Of these the most valuable is its splendid picture gallery, founded by Augustus I. and increased by his successors at great cost. It is in the museum, and contains about 2500 pictures, being especially rich in specimens of the Italian, Dutch and Flemish schools. The gem of the collection is Raphael's "Madonna di San Sisto," for which a room is set apart. There is also a special room for the "Madonna" of the younger Holbein. Other paintings with which the name of the gallery is generally associated are Correggio's "La Notte" and "Mary Magdalene"; Titian's "Tribute Money" and "Venus"; "The Adoration" and "The Marriage in Cana," by Paul Veronese; Andrea del Sarto's "Abraham's Sacrifice"; Rembrandt's "Portrait of Himself with his Wife sitting on his Knee"; "The Judgment of Paris" and "The Boar Hunt," by Rubens; Van Dyck's "Charles I., his Queen, and their Children."

Of modern painters, this magnificent collection contains masterpieces by Defregger, Vautier, Makart, Munkacsy, Fritz von Uhde, Böcklin, Hans Thoma; portraits by Leon Pohle, Delaroche and Sargent; landscapes by Andreas and Oswald Achenbach and allegorical works by Sascha Schneider. In separate compartments there are a number of crayon portraits, most of them by Rosalba Carriera, and views of Dresden by Canaletto and other artists. Besides the picture gallery the museum includes a magnificent collection of engravings and drawings. There are upwards of 400,000 specimens, arranged in twelve classes, so as to mark the great epochs in the history of art. A collection of casts, likewise in the museum, is designed to display the progress of plastic art from the time of the Egyptians and Assyrians to modern ages. This collection was begun by Raphael Mengs, who secured casts of the most valuable antiquities in Italy, some of which no longer exist.

The Japanese palace contains a public library of more than 400,000 volumes, with about 3000 MSS. and 20,000 maps. It is especially rich in the ancient classics, and in works bearing on literary history and the history of Germany, Poland and France. There are also a valuable cabinet of coins and a collection of ancient works of art. A collection of porcelains in the "Museum Johanneum" (which once contained the picture gallery) is made up of specimens of Chinese, Japanese, East Indian, Sèvres and Meissen manufacture, carefully arranged in chronological order. There is in the same building an excellent Historical Museum. In the Grüne Gewölbe (Green Vault) of the Royal Palace, so called from the character of its original decorations, there is an unequalled collection of precious stones, pearls and works of art in gold, silver, amber and ivory. The objects, which are about 3000

in number, are arranged in eight rooms. They include the regalia of Augustus II. as king of Poland; the electoral sword of Saxony; a group by Dinglinger, in gold and enamel, representing the court of the grand mogul Aurangzebe, and consisting of 132 figures upon a plate of silver 4 ft. 4 in. square; the largest onyx known, 6½ in. by 2½ in.; a pearl representing the dwarf of Charles II. of Spain; and a green brilliant weighing 40 carats. The royal palace also has a gallery of arms consisting of more than 2000 weapons of artistic or historical value. In the Zwinger are the zoological and mineralogical museums and a collection of instruments used in mathematical and physical science. Among other collections is that of the Körner museum with numerous reminiscences of the Goethe-Schiller epoch, and of the wars of liberation (1813-15), and containing valuable manuscripts and relics. Founded by Hofrath Dr Emil Peschel, it has passed into the possession of the city.

Education.—Dresden is the seat of a number of well-known scientific associations. The educational institutions are numerous and of a high order, including a technical high school (with about 1100 students), which enjoys the privilege of conferring the degrees of doctor of engineering, doctor of technical sciences, &c., a veterinary college, a political-economic institution (Gehestiftung), with library, a school of architects, a royal and four municipal gymnasia, numerous lower grade and popular schools, the royal conservatorium for music and drama, and a celebrated academy of painting. Dresden has several important hospitals, asylums and other charitable institutions.

Music and the Theatres.—Beside the two royal theatres, Dresden possesses several minor theatres and music halls. The pride of place in the world of music is held by the orchestra attached to the court theatre. Founded by Augustus II., it has become famous throughout the world, owing to the masters who have from time to time been associated with it—such as Paër, Weber, Reissiger and Wagner. Symphony and popular concerts are held throughout the year in various public halls, and, during the winter, concerts of church music are frequently given in the Protestant Kreuz- and Frauen-Kirchen, and on Sundays in the Roman Catholic church.

Communications and Industries.—Dresden lies at the centre of an extensive railway system, which places it in communication with the chief cities of northern and central Germany as well as with Austria and the East. Here cross the grand trunk lines Berlin-Vienna, Chemnitz-Görlitz-Breslau. It is connected by two lines of railway with Leipzig and by local lines with neighbouring smaller towns. The navigation on the Elbe has of recent years largely developed, and, in addition to trade by river with Bohemia and Magdeburg-Hamburg, there is a considerable pleasure-boat traffic during the summer months. The communications within the city are maintained by an excellent system of electric trams, which bring the more distant suburbs into easy connexion with the business centre. A considerable business is done on the exchange, chiefly in local industrial shares, and the financial institutions number some fifty banks, among them branches of the Reichs Bank and of the Deutsche Bank. Among the more notable industries may be mentioned the manufacture of china (see CERAMICS), of gold and silver ornaments, cigarettes, chocolate, coloured postcards, perfumery, straw-plaiting, artificial flowers, agricultural machinery, paper, photographic and other scientific instruments. There are several great breweries; corn trade is carried on, and an extensive business is done in books and objects of art.

Surroundings.—The environs of the city are delightful. To the north are the vine-clad hills of the Lössnitz commanding views of the valley of the Elbe from Dresden to Meissen; behind them, on an island in a lake, is the castle of Moritzburg, the hunting box of the king of Saxony. On the right bank of the Elbe, 3 m. above the city, lies the village of Loschwitz, where Schiller, in the summer of 1786, wrote the greater part of his *Don Carlos*: above it on the fringe of the Dresdner Heide, the climatic health resort Weisser-Hirsch; farther up the river towards Pirna the royal summer palace Pillnitz; to the south the Plauensche Grund, and still farther the Rabenauer Grund.

History.—Dresden (Old Slav *Draga*, forest, *Dragojan*, forest-dwellers), which is known to have existed in 1206, is of Slavonic origin, and was originally founded on the right bank of the Elbe, on the site of the present Neustadt, which is thus actually the *old* town. It became the capital of Henry the Illustrious, margrave of Meissen, in 1270, but belonged for some time after his death, first to Wenceslaus of Bohemia, and next to the margrave of Brandenburg. Early in the 14th century it was restored to the margrave of Meissen. On the division of Saxony in 1485 it fell to the Albertine line, which has since held it. Having been burned almost to the ground in 1491, it was rebuilt; and in the 16th century the fortifications were begun and gradually extended. John George II., in the 17th century, formed the Grosser Garten, and otherwise greatly improved the town; but it was in the first half of the 18th century, under Augustus I. and Augustus II., who were kings of Poland as well as electors of Saxony, that Dresden assumed something like its present appearance. The Neustadt, which had been burned down in the 17th century, was founded anew by Augustus I.; he also founded Friedrichstadt. The town suffered severely during the Seven Years' War, being bombarded in 1760. Some damage was also inflicted on it in 1813, when Napoleon made it the centre of his operations; one of the buttresses and two arches of the old bridge were then blown up. The dismantling of the fortifications had been begun by the French in 1810, and was gradually completed after 1817, the space occupied by them being appropriated to gardens and promenades. Many buildings were completed or founded by King Anthony, from whom Antonstadt derives its name. Dresden again suffered severely during the revolution of 1849, but all traces of the disturbances which then took place were soon effaced. In 1866 it was occupied by the Prussians, who did not finally evacuate it until the spring of the following year. Since that time numerous improvements have been carried out.

See Lindau, *Geschichte der Haupt- und Residenzstadt Dresden* (2 vols., Dresden, 1884-1885); Pfäfers, *Geschichte des Hoftheaters in Dresden* (Dresden, 1877); Schumann, *Führer durch die königl. Sammlungen zu Dresden* (1903); Woerl, *Führer durch Dresden*; Daniel, *Deutschland* (1894).

BATTLE OF DRESDEN. The battle of Dresden, the last of the great victories of Napoleon, was fought on the 26th and 27th of August 1813. The intervention of Austria in the War of Liberation, and the consequent advance of the Allies under the Austrian field-marshal Prince Schwarzenberg from Prague upon Dresden, recalled Napoleon from Silesia, where he was engaged against the Prussians and Russians under Blücher. Only by a narrow margin of time, indeed, was he able to bring back sufficient troops for the first day's battle. He detached a column under Vandamme to the mountains to interpose between Schwarzenberg and Prague (see NAPOLEONIC CAMPAIGNS); the rest of the army pressed on by forced marches for Dresden, around which a position for the whole army had been chosen and fortified, though at the moment this was held by less than 20,000 men under Gouvion St Cyr, who retired thither from the mountains, leaving a garrison in Königstein, and had repeatedly sent reports to the emperor as to the allied masses gathering to the southward. The battle of the first day began late in the afternoon, for Schwarzenberg waited as long as possible for the corps of Klénau, which formed his extreme left wing on the Freiberg road. At last, about 6 P.M. he decided to wait no longer, and six heavy columns of attack advanced against the suburbs defended by St Cyr and now also by the leading troops of the main army. Three hundred guns covered the assault, and Dresden was set on fire in places by the cannonade, while the French columns marched unceasingly over the bridges and through the Altstadt. On the right the Russians under Wittgenstein advanced from Striesen, the Prussians under Kleist through the Grosser Garten, whilst Prussians under Prince Augustus and Austrians under Colloredo moved upon the Moczniski redoubt, which was the scene of the most desperate fighting, and was repeatedly taken and retaken. The attack to the westward was carried out by the other Austrian corps; Klénau, however, was still far distant. In the end, the French defences remained unshaken. Ney led a counter-attack against the Allies' left,

the Moczinski redoubt was definitely recaptured from Colloredo, and the Prussians were driven out of the Grosser Garten. The coup of the Allies had failed, for every hour saw the arrival of fresh forces on the side of Napoleon, and at length the Austrian leader drew off his men to the heights again. He was prepared to fight another battle on the morrow—indeed he could scarcely have avoided it had he wished to do so, for behind him lay the mountain defiles, towards which Vandamme was marching with all speed.

Napoleon's plan for the 27th was, as usual, simple in its outline. As at Friedland, a ravine separated a part of the hostile line of battle from the rest. The villages west of the Plauen ravine and even Löbda were occupied in the early morning by General Metzko with the leading division of Klenau's corps from Freiberg, and upon Metzko Napoleon intended first to throw the weight of his attack, giving to Victor's infantry and the cavalry of Murat, king of Naples, the task of overwhelming the isolated Austrians. The centre, aided by the defences of the Dresden suburbs, could hold its own, as the events of the 26th had shown, the left, now under Ney, with whom served Kellermann's

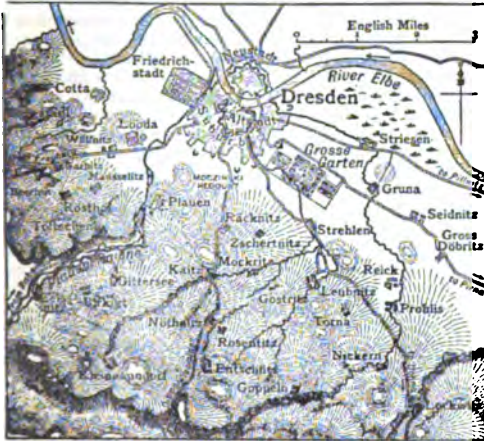

cavalry and the Young Guard, was to attack Wittgenstein's Russians on the Pirna road. Thus, for once, Napoleon decided to attack both flanks of the enemy. His motives in so doing have been much discussed by the critics; Vandamme's movements, it may be suggested, contributed to the French emperor's plan, which if carried out would open the Pirna road. Still, the left attack may have had a purely tactical object, for in that quarter was the main body of the Prussians and Russians, and Napoleon's method was always to concentrate the fury of the attack on the heaviest masses of the enemy, i.e. the best target for his own artillery. A very heavy rainstorm during the night seriously affected the movements of troops on the following day, but all to Napoleon's advantage, for his more mobile artillery, reinforced by every horse available in and about Dresden, was still able to move where the Allied guns sank in mud. Further, if the cavalry had to walk, or at most trot, through the fields the opposing infantry was almost always unable to fire their muskets. "You cannot fire; surrender," said Murat to an Austrian battalion in the battle. "Never," they replied; "you cannot charge us." On the appearance of Murat's horse artillery, however, they had to surrender at once. Under such conditions, Metzko, unsupported either by Klenau or the main army beyond the ravine, was an easy victim. Victor from Löbda drove in the advanced posts and assaulted the line of villages Wolfnitz-Töltschen; Metzko had to retire to the higher ground S.W. of the first line, and Murat, with an overwhelming cavalry force from Cotta and Burgstädt, outflanked his left, broke up

whole battalions, and finally, with the assistance of the renewed frontal attack of Victor's infantry, annihilated the division. The Austrian corps of Gyulai arrived too late to save it. A few formed bodies escaped across the ravine, but Metzko and three-fourths of his men were killed or taken prisoners.

Meanwhile Ney on the other flank, with his left on the Pillnitz road and his right on the Grosser Garten, had opened his attack. The Russians offered a strenuous resistance, defending Seidnitz, Gross Döbritz and Reick with their usual steadiness, and Ney was so far advanced that several generals at the Allied headquarters suggested a counter-attack of the centre by way of Strehlen, so as to cut off the French left from Dresden. This plan was adopted, but, owing to various misunderstandings, failed of execution. Thus the Allied centre remained inactive all day, cannonaded by the Dresden redoubts. One incident only, but that of great importance, took place here. The tsar, the king of Prussia, Schwarzenberg and a very large headquarter staff watched the fighting from a hill near Räcknitz and offered an easy mark to the French guns. In default of formed bodies to fire at, the latter had for a moment ceased fire; Napoleon, riding by, half carelessly told them to reopen, and one of their first shots, directed at 2000 yards range against the mass of officers on the sky-line, mortally wounded General Moreau, who was standing by the emperor Alexander. A council of war followed. The Allied sovereigns were for continuing the fight; Schwarzenberg, however, knowing the exhaustion of his troops decided to retreat. As at Bautzen, the French cavalry was unable to make any effective pursuit.

The forces engaged were 96,000 French, Saxons, &c., and 200,000 Austrians, Russians and Prussians. The French losses were about 10,000, or a little over 10%, those of the Allies 38,000 killed, wounded and prisoners (the latter 23,000) or 19%. They lost also 15 colours and 26 guns.

DRESS (from the Fr. *dresser*, to set out, arrange, formed from Lat. *directus*, arranged, *dirigere*, to direct, arrange), a substantive of which the current meaning is that of clothing or costume in general, or, specifically, the principal outer garment worn by a woman (see **COSTUME**). The verb "to dress" has various applications which can be deduced from its original meaning. It is thus used not only of the putting on of clothing, but of the preparing and finishing of leather, the preparation of food for eating, the application of cleansing and healing substances or of bandages, &c., to a wound, the drawing up in a correct line of a body of troops, and, generally, adorning or decking out, as of a ship with flags. In the language of the theatre the "dresser" is the person who looks after the actor's wardrobe and assists him in the changing of his costumes. For the printer's use of "dresser" see **TYPOGRAPHY**.

DRESSER, in furniture, a form of sideboard. The name is derived from the Fr. *dressoir*, a piece of furniture used to range or *dresser* the more costly appointments of the table. The appliance is the direct descendant of the credence and the buffet, and is, indeed, a much more legitimate inheritor of their functions than the modern sideboard, which, as we know it, is practically an 18th-century invention. It developed into its present shape about the second quarter of the 17th century, and has since then changed but little. As a piece of movable furniture it was made rarely, if at all, after the beginning of the 19th century until the revival of interest in what is called "farmhouse furniture" at the very beginning of the 20th century led in the first place to the construction of many imitation antique dressers from derelict pieces of old oak, and especially from panels of chests, and in the second to the making of avowed imitations. The dresser conformed to a model which varied only in detail and in ornament. Its simple and agreeable form consisted of a long and rather narrow table or slab, with drawers or cupboards beneath and a tall upright closed-in back arranged with a varying number of shallow shelves for the reception of plates; hooks for mugs were often fixed upon the face of these shelves. Towards the end of the 17th century small cupboards were often added to the superstructure. The majority of these dressers were made of oak, but when, early in the Georgian period

mahogany came into general use, they were frequently inlaid with that wood; holly and box were also used for inlaying, most frequently in the shape of plain bands or lines. A peculiarly effective combination of oak and mahogany is found in the dressers, as in other "farmhouse furniture," made on the borders of Staffordshire and Shropshire. The excellence of the work of this kind in that district and in the country lying west of it may perhaps explain the expression "Welsh dresser," which is now no more than a trade term, not necessarily suggestive of the place of origin, and applied to all dressers of this type. They are most frequently found in the houses of small yeomen and substantial farmers, into which fashion penetrated slowly. The dresser is now most familiar as necessary plenishing of the kitchen, in which it is invariably a fixture. In form it is essentially identical with the movable variety, but it is usually much larger, is made of deal or other soft wood, and the superstructure has no back.

DREUX, a town of north-western France, capital of an arrondissement in the department of Eure-et-Loir, 27 m. N.N.W. of Chartres by rail. Pop. (1906) 8209. It is situated on the Blaise, which at this point divides into several arms. It is overlooked from the north by an eminence on which stands a ruined medieval castle; within the enclosure of this building is a gorgeous chapel, begun in 1316 by the dowager duchess of Orleans, and completed and adorned at great cost by Louis Philippe. It contains the tombs of the Orleans family, chief among them that of Louis Philippe, whose remains were removed from England to Dreux in 1876. The sculptures on the tombs and the stained glass of the chapel windows are masterpieces of modern art. The older of the two hôtels-de-ville of Dreux was built in the early 16th century, chiefly by Clément Métezeau, the founder of a famous family of architects, natives of the town. It is notable both for the graceful carvings of the façade and for the fine staircase and architectural details of the interior. The church of St Pierre, which is Gothic in style, contains good stained glass and other works of art. The town has a statue of the poet Jean de Rotrou, born there in 1609. Dreux is the seat of a subprefect. Among the public institutions are tribunals of first instance and of commerce, and a communal college. The manufacture of boots and shoes, metal-founding and tanning, are carried on, and there is trade in wheat and other agricultural products and poultry.

Dreux was the capital of the Gallic tribe of the *Durocasses*. In 1188 it was taken and burnt by the English; and in 1562 Gaspard de Coligny, and Louis I., prince of Condé, were defeated in its vicinity by Anne de Montmorency and Francis, duke of Guise. In 1593 Henry IV. captured the town after a fortnight's siege. It was occupied by the Germans on the 9th of October 1870, was subsequently evacuated, and was again taken, on the 17th of November, by General Von Tresckow. In the 10th century Dreux was the chief town of a countship, which Odo, count of Chartres, ceded to king Robert, and Louis VI. gave to his son Robert, whose grandson Peter of Dreux, younger brother of Count Robert III., became duke of Brittany by his marriage with Alix, daughter of Constance of Brittany by her second husband Guy of Thouars. By the marriage of the countess Jeanne II. with Louis, viscount of Thouars (d. 1370), the Capetian countship of Dreux passed into the Thouars family. In 1377 and 1378, however, two of the three co-heiresses of Jeanne, Perronelle and Marguerite, sold their shares of the countship to King Charles V. Charles VI. gave it to Arnaud Amanien d'Albret, but took it back in order to give it to his brother Louis of Orleans (1407); later he gave it back to the lords of Albret. Francis of Cleves laid claim to it in the 16th century as heir of the d'Albrets of Orval, but the parlement of Paris declared the countship to be crown property. It was given to Catherine de' Medici (1530), then to Francis, duke of Alençon (1569); it was pledged to Charles de Bourbon, count of Soissons, and through him passed to the houses of Orleans, Vendôme and Condé.

DREW, the name of a family of American actors. **JOHN DREW** (1827-1862) was born in Dublin and made his first New York appearance in 1846. He played Irish and light comedy parts with success in all the American cities, and was manager

of the Arch Street theatre in Philadelphia. He visited England in 1855, and Australia in 1859, and died in Philadelphia. His wife, **LOUISE LANE DREW** (1820-1897), was the daughter of a London actor, and in 1827 went to America, appearing as the Duke of York to the elder Booth's Richard III., and as Albert to Edwin Forrest's William Tell. After this she starred as a child actress, and then as leading lady. She had been twice married before she became Mrs Drew in 1850. From 1861 to 1892 she had the management of the Arch Street theatre in Philadelphia. In 1880 she toured with Joseph Jefferson in his elaborate revival of *The Rivals*, playing Mrs Malaprop to perfection. She had three children, John, Sidney and Georgiana, wife of Maurice Barrymore (1847-1905), and mother of Lionel and Ethel Barrymore, all actors. The eldest son, **JOHN DREW** (b. 1853), began his stage career under his mother's management in Philadelphia as Plumper in *Cool as a Cucumber*, on the 22nd of March 1873; and after playing with Edwin Booth and others, became leading man in Augustin Daly's company in 1879. His association with this company, and with Ada Rehan as the leading lady, constituted a brilliant period in recent stage history, his Petruccio being only one, though perhaps the most striking, of a series of famous impersonations. In 1892 he left Daly's company, and began a career as a "star."

DREW, SAMUEL (1765-1833), English theologian, was born in the parish of St Austell, in Cornwall, on the 6th of March 1765. His father was a poor farm labourer, and could not afford to send him to school long enough even to learn to read and write. At ten he was apprenticed to a shoemaker, and at twenty he settled in the town of St Austell, first as manager for a shoemaker, and in 1787 began business on his own account. He had already gained a reputation in his narrow circle as a keen debater and a jovial companion, and it is said that he had several smuggling adventures. He was first aroused to serious thought in 1785 by a funeral sermon preached over his elder brother by Adam Clarke. He joined the Methodists, was soon employed as a class leader and local preacher, and continued to preach till a few months before his death. His opportunities of gaining knowledge were very scanty, but he strenuously set himself to make the most of them. It is stated that an accidental introduction to Locke's great essay determined the ultimate direction of his studies. In 1798 the first part of Thomas Paine's *Age of Reason* was put into his hands; and in the following year he made his first appearance as an author by publishing his *Remarks* on that work. The book was favourably received, and was republished in 1820. Drew had begun to meditate a greater attempt before he wrote his *Remarks on Paine*; and, encouraged by the antiquary John Whitaker, he published his *Essay on the Immateriality and Immortality of the Soul* in 1802. This work made the "Cornish metaphysician," as he was called, widely known, and for some time it held a high place in the judgment of the religious world as a conclusive argument on its subject. A fifth edition appeared in 1831. Drew continued to work at his trade till 1805, when he entered into an engagement with Dr Thomas Coke, a prominent Wesleyan official, which enabled him to devote himself entirely to literature. In 1800 he published his *Essay on the Identity and General Resurrection of the Human Body*, perhaps the most original of his works, which reached a second edition in 1822. In 1814 he completed a history of Cornwall begun by F. Hitchens. In 1819 he removed to Liverpool, being appointed editor of the *Imperial Magazine*, then newly established, and in 1821 to London, the business being then transferred to the capital. Here he filled the post of editor till his death, and had also the supervision of all works issued from the Caxton Press. He was an unsuccessful competitor for the Burnett prize offered in 1811 for an essay on the existence and attributes of God. The work which he then wrote, and which in his own judgment was his best, was published in 1820, under the title of *An Attempt to demonstrate from Reason and Revelation the Necessary Existence, Essential Perfections, and Superintending Providence of an Eternal Being, who is the Creator, the Supporter, and the Governor of all Things* (2 vols. 8 vo). This procured him the degree of M.A. from the university of Aberdeen.

Among Drew's lesser writings are a *Life of Dr Thomas Coke* (1817), and a work on the deity of Christ (1813). He died at Helston in Cornwall on the 29th of March 1833. He was a man of strong mind, honourable spirit and affectionate disposition, energetic both in speech and in writing.

A memoir of his life by his eldest son appeared in 1834.

DREWENZ, a river of Germany, a right-bank tributary of the Vistula. It rises on the plateau of Hohenstein in East Prussia, 5 m. S.W. of the town of Hohenstein. After passing through the lake of Drewenz (7 m. long), it flows S.W. through flat marshy country, and forms, from just below the town of Strassburg to that of Leibtsch, a distance of 30 m., the frontier between Prussia and Russian Poland. After a course of 148 m. it enters the Vistula from the right, a little above the fortress of Thorn. It is navigable only for rafts. Lake Drewenz is connected with Elbing (and so with the Baltic) by the navigable Elbing-Oberland Canal.

DREXEL, ANTHONY JOSEPH (1826-1893), American banker, was born in Philadelphia, Pennsylvania, on the 13th of September 1826. He was the son of Francis M. Drexel (1792-1863), a native of Austrian Tirol, who emigrated to America in 1817, and, after some years spent as a portrait-painter, became a banker and the founder of the house of Drexel & Company. Anthony, who entered his father's counting-house in 1839, eventually, with his brothers Francis and Joseph, succeeded to the control of the business, and organized the banking houses of Drexel, Morgan & Company, New York, of which his brother Joseph W. (1833-1888) was long the resident head, and of Drexel, Harjes & Company, Paris. In 1864 he joined his friend George W. Childs in the purchase of the Philadelphia *Public Ledger*, and with him in 1862 founded the Printers' Home for union men at Colorado Springs. In 1891 he founded, and endowed with \$2,000,000, the Drexel Institute of Art, Science and Industry in Philadelphia, the buildings for which he constructed at a cost of \$750,000. This institution provides technical instruction for both night and day classes and public lecture courses, and has a good museum and a library of 35,000 volumes. Drexel died at Carlsbad, Germany, on the 30th of June 1893.

DREYFUS, ALFRED (1859-), French soldier, of Jewish parentage, the scandal of whose condemnation for treason and subsequent rehabilitation convulsed French political life between 1894 and 1899, and only ended in 1906, was born in Mülhausen, Upper Alsace, removing to Paris in 1874. After going through the usual course of military instruction with credit, he became a sous-lieutenant in the artillery in 1882, and was promoted captain in 1889; and, after passing through the *École de Guerre* with distinction, he was appointed to the general staff. His name was, however, unknown to the general public till he was arrested on the 15th of October 1894 on a charge of selling military secrets to Germany, condemned, publicly degraded (January 4, 1895), and transported (March 10) to the Ile du Diable, French Guiana. The story of the subsequent proceedings in this celebrated case is told in the article **ANTI-SEMITISM**, and need not here be repeated. It was not till 1899 that the unfortunate prisoner was brought back to France for retrial by court-martial, and even then, so strong was the anti-Semitic and military prejudice, he was again found guilty "with extenuating circumstances" at Rennes (September 9), though ten days later he was "pardoned" by President Loubet. It was not till the Cour de Cassation ordered a further investigation, and on the 12th of July 1906 decided that his conviction had been based on a forgery and that Dreyfus was innocent, that the agitation came to a final conclusion. He was then restored to his rank in the army and promoted major. But the anti-Semitic and anti-Dreyfusard spirit in certain French circles could not easily be quelled even then; and on the occasion of the translation of the remains of Emile Zola (Dreyfus's determined champion) to the Pantheon on the 4th of June 1908, Major Dreyfus was shot at and wounded by a fanatical journalist named Gregori, who was subsequently acquitted by a Paris jury of the charge of attempted murder, his own plea being that he had merely intended a "demonstration."

See Dreyfus's own *Five Years of my Life* (1901), and literature cited under **ANTI-SEMITISM**.

DRIBURG, a town and spa of Germany, in Prussian Westphalia, pleasantly situated on the Aa and the railway Soest-Höxter-Berlin. Pop. 2600. It has an Evangelical and a Roman Catholic church and some glass manufactures. It is celebrated for its saline-ferruginous springs, discovered in 766, and since 1779 largely frequented in summer. In the vicinity are the ruins of Iburg, a castle destroyed by Charlesmagne in 775, and bestowed by him upon the bishopric of Paderborn.

DRIFFIELD (officially Great Driffield), a market town in the Buckrose parliamentary division of the East Riding of Yorkshire, England, 19½ m. N. by W. from Hull, the junction of several branch lines of the North Eastern railway. Pop. of urban district (1901) 5766. It is pleasantly situated at the foot of the Wolds, and is connected with Hull by a navigable canal. The church of All Saints is of various dates from Norman onwards. The town is the centre of a rich agricultural district, and large markets and fairs are held. There are works for the manufacture of oil-cake. Driffield is of high antiquity, and numerous tumuli are seen in the vicinity, while there is an excellent private antiquarian museum in the town.

DRIFT (from "drive"), a verb or noun used in various connexions with the sense of propelled motion, especially (but not necessarily) of an aimless sort, undirected. Thus it is possible to speak of a snow-drift, an accumulation driven by the wind; of a ship drifting out of its course; of the drift of a speech, i.e. its general tendency. The word is also used in some technical senses, more immediately resulting from the action of driving something in. But the most important technical use of the word is in geology, as introduced by C. Lyell in 1840 in place of "Diluvium." The earlier geologists had been in the habit of dividing the Quaternary deposits into an older Diluvium and a younger Alluvium; the latter is still employed in England, but the former has dropped out of use, though it is still retained by some continental writers. The Alluvium was distinguished from Diluvium by the fact that its mammalian fossils were representatives of still living forms, but it is a matter of great difficulty to separate these two divisions in practice. "The term drift is now applied generally to the Quaternary deposits, which consist for the most part of gravel, sand, loam or brickearth and clay; it naturally refers to strata laid down at some distance from the rocks to whose destruction they are largely due; but, although applied to river deposits, the word drift is more appropriately used in reference to the accumulations of the Glacial period.

"The occurrence of stones and boulders far removed from their parent source early attracted the attention of geologists, but for a long period the phenomena, now known as of glacial origin, were unexplained, and the drifts were looked upon as little more than 'extraneous rubbish,' the product of geological agents, quite distinct from those which helped to form the more 'solid' rocks that underlie them." (See H. B. Woodward, *The Geology of England and Wales*, 2nd ed., 1887.) The conception of an underlying "solid" geological structure covered by a superficial mantle of "drift" is still retained for certain practical purposes; thus, the Geological Survey of Great Britain issues many of the maps in two forms, the "Solid Edition," showing the "solid geology," which embraces all igneous rocks and the stratified rocks older than Pleistocene, and the "Drift Edition," which shows only such older strata as are unobscured by drift.

In writing and in conversation the geological expression "drift" is now usually understood to mean Glacial drift, including boulder clay and all the varieties of sand, gravel and clay deposits formed by the agency of ice sheets, glaciers and icebergs. But in the "Drift" maps many other types of deposit are indicated, such, for instance, as the ordinary modern alluvium of rivers, and the older river terraces (River-drift of various ages), including gravels, brickearth and loam; old raised sea beaches and blown-sand (Aeolian-drift); the "Head" of Cornwall and Devon, an angular detritus consisting of stones with clay or loam; clay-with-flints, rainwash (landwash), scree and talus;

the "Warp," a marine and estuarine silt and clay of the Humber; and also beds of peat and diatomite.

See GLACIAL PERIOD; PLEISTOCENE; BOULDER CLAY. (J. A. H.)

DRILL. (1) A tool for boring or making holes in hard substances, such as stone, metal, &c. (an adaptation in the 17th century from the Dutch *dril* or *drille*, from *drillen*, to turn, bore a hole; according to the New English Dictionary the word is not to be connected with the English "thrill"). The word *drillen* was used in Dutch, German and Danish, from the 17th century for training in military exercises and was adopted into English in the same sense. The origin of the application seems to be in the primary sense of "to turn round," from the turning of the troops in their evolutions and from the turning of the weapons in the soldiers' hands. Drill is, formally, the preparation of soldiers for their duties by the practice or rehearsal of movements in military order and the handling of arms, and, psychologically, the method of producing in the individual soldier habits of self-control and of mechanically precise actions under disturbing conditions, and of rendering the common instinctive will of a body of men, large or small, amenable to the control of, and susceptible to a stimulus imparted by its commander's will.

(2) A furrow made in the soil in which seed may be sown, and a machine used for sowing seed in such furrows (see SOWING). The word is somewhat doubtful in origin. It may be the same as an obsolete word "drill," to trickle, flow in drops, also a small stream or flow of water, a rill, and is possibly an altered form of "trill."

(3) In zoology, the native name of a large short-tailed west African baboon, *Papio leucophaeus*, closely allied to the mandrill (*q.v.*), but distinguished by the absence of brilliant blue and scarlet on the jaws of the fully adult males.

(4) The name of a fabric made in both linen and cotton, and commonly bleached and finished stiff. The word is a shortened form of "drilling," from the German *drillich*, or "three-threaded," and is so named because the weave originally used in its construction is what is termed the three-leaf twill, nine repeats of which appear in the accompanying figure, while immediately below the design is an intersection



of all the nine threads with the first pick. It is essentially a warp-faced fabric; that is, the upper surface is composed mostly of warp threads. In the figure it will be seen that two out of every three threads appear on the surface, and, by introducing a greater number of threads per inch than picks per inch, the weft is made to occupy a still more subordinate position so far as the upper surface of the cloth is concerned. Although the weave shown is still extensively used in this branch, there are others, e.g. the 4-thread and the 5-thread weaves, which are employed for the production of this cloth. Large quantities of drill are shipped to the Eastern markets and to other sub-tropical centres, from which it is sold for clothing. In temperate climates it forms a satisfactory material for ladies' and children's summer clothing, and it is used by chefs, hairdressers, provision merchants, grocers, buttermen, painters and decorators, &c., while many of the long jackets or overalls, such as those worn by many mill and factory managers, are made from the same material.

DRINKING VESSELS.¹ The use of special vessels for drinking purposes may fairly be assumed to have had a natural origin and development. From a practical point of view it would soon be found desirable to provide vessels for liquids in addition to those serving to hold food. As in many other commonplace details of modern life, we must turn to the primitive races to understand how our present conditions were reached. In almost all parts of the world many of the products of nature are capable of serving such purposes, with little or no change at the hands of man; in tropical and sub-tropical climates the coco-nut and the gourd or calabash require but little change to adapt them as the most convenient of drinking utensils, the eggs of the larger birds, such as the ostrich or the emu, shells, like the nautilus and other univalves, as well as the deeper bivalves,

are equally convenient. Such natural objects are in fact used by the uncivilized tribes of Africa, America and Polynesia, as well as, in some cases, by the white races who have intruded into those parts of the world, and adopted some of the native habits. In Paraguay, for example, the so-called "Paraguay tea," an infusion of the *yerba mate* (*Ilex paraguayensis*), is drunk through a tube from a small gourd held in the hand, and often handsomely mounted in silver or even gold. In the same way, as we shall see, civilized man has adopted nearly all the natural forms that were found convenient by the savage, altering and adorning them in accordance with the taste of the time or country where they were used.

Another line of development, however, has been found to be the natural outcome of the human mind. Nothing could form a more practical drinking cup than the half of a coco-nut shell or part of a gourd. Such cups, however, in the countries where the plants producing them are common, would be easily obtained, and every one, rich or poor, could possess one or more. In order, therefore, to distinguish the chief's possessions from those of his inferiors, his cup is often made with great labour, from some more intractable material, wood or stone, though in practically the same form as that of the natural object.

Among European races in medieval times the same lines have been followed, though for different reasons. Human ingenuity, though perhaps originally inspired by natural forms, is apt to turn aside into more artificial channels. The invention of the potter's art (see CERAMICS), where the plastic nature of the raw material renders it capable of infinite changes of form, gave rise to types of vessels having no obvious or necessary relation to the productions of nature. In Britain and in northern Europe generally, the interments of the races of the Neolithic and Bronze Ages have furnished vessels of pottery of a beaker-like form, to which the name of "drinking-cups" has been given. It must be confessed that the evidence for attributing such a use to them is slender, and mainly consists of the fact that their thin lips would render them better adapted for the purpose than the other pottery vessels found with them, some of which, on equally slight grounds, have been called food vessels. The general use and acceptance of the term by two generations of archaeologists is, however, an adequate reason for a passing mention in this place. In the later prehistoric times of Europe vessels of gold, bronze and other materials, including amber, were made, sometimes of elegant forms, and would seem to have been used as drinking vessels; still, this is again an assumption, though a fairly probable one. A small gold cup with handle was found in a barrow at Rillaton, Cornwall, one of amber of a similar form was found at Hove, and a third of shale near Honiton. All of these doubtless may be referred to the Bronze Age.

Schliemann found many drinking vessels in his exploration of the superimposed cities of Troy. A pretty form is that found in the first city. It is of clay, and closely resembles an early Victorian tea cup on a high foot. This form is of interest, as Schliemann discovered the same both at Tiryns and Mycenae, five from the latter site being of gold, while the type also occurs from Ialysus in Rhodes in association with bronze swords. This Trojan cup was found at a depth of 50 ft. below the present surface and about 18 ft. below the stratum of what Schliemann claimed to be the Homeric Troy. In his second city appears a different type of ware, somewhat fantastic in form, one vessel being in the form of a sow, while others foreshadow the *crater* and *amphora* of later and more familiar Greek wares.

But the drinking vessel to which Schliemann draws most attention is the tall cup of a trumpet form furnished with two earlike loop handles. This curious and original type occurs also in the Third (or Homeric), Fourth and Sixth Cities, with little if any change. Schliemann devotes some pages to the discussion of the form, in which he sees the *δέρας ἀμφικύπελλον*¹ of Homer, which has been more usually understood to mean an hour-glass shaped cup, in which the distinguishing feature

Early drinking cups.

New forms found by Schliemann.

¹The verb "to drink" is Common Teut., cf. Ger. *trinken*, &c.

¹See PLATE, Plate I.

DRINKING VESSELS

PLATE I.



Fig. 1.—Roman Glass Cup. With representation of a chariot race. Found at Colchester.



Fig. 2.—Teutonic Glass Cup. From a grave at Selzen, Rhenish Hesse.



Fig. 3.—Saxon Glass "Tumbler."



Fig. 4.—Frankish Glass Drinking Horn. Bingerbrück.



Fig. 5.—Saxon Cow's Horn. Mounted in silver. Taplow.



Fig. 6.—Saxon Trumpet-shaped Drinking Vessel of Glass. With hollow tubular ornamentation. Found in a barrow at Taplow.



Fig. 7.—The Royal Gold Enamelled Hanap. Made about 1380.



Fig. 8.—Saracenic Enamelled Goblet. With French silver mountings. Fourteenth century.



Fig. 8.—A Glass "Yard of Ale" (English). Eighteenth century.



Fig. 1.—Venetian Glass Goblet. With enamelled decoration. Fifteenth century.



Fig. 2.—English "Blackjack." With initials of Charles I. and date 1646.

All the objects represented on these two plates are in the British Museum



Fig. 3.—The Rochester Mazer. Presented by Brother Robert Peacham. Sixteenth century.



Fig. 4.—Chinese Cup. Carved from rhinoceros horn. Eighteenth century.



Fig. 5.—English Glass Tankard. Bearing the Arms of Lord Burligh.



Fig. 6.—Coco-nut Cup. With silver mountings. German, about 1600-



Fig. 7.—Swiss "Tanzenmann." Carved in wood. Seventeenth century. The German name for this type is "Buttenmann."

was two cups, not two handles. He applies the same term to a drinking vessel of a very different form, found with several others in the Third City. This is a sauce-boat shaped vessel¹ of gold, made with a lip for pouring or drinking at either end, and with two loop handles. This equals those previously mentioned in originality of form; with it were found others of gold, silver and electrum (*i.e.* 4 parts of gold to 1 of silver). Of these three were shaped like 18th-century coffee cups but wanting handles. In the Sixth City appear forms more nearly approaching those of later times, particularly prototypes of the *castharus* and *scyphus*.

These discoveries in the various strata of Troy may be taken as the analogues in the Mediterranean and hither Asia of the later Stone and Bronze Ages of northern Europe, with an allowance of some centuries of greater antiquity for the former.

It is not proposed in this article to deal with the ceramic and metallic drinking vessels of the Greeks and Romans, of what is generally known as the classical period (see CERAMICS and PLATE). It may be mentioned, however, that both on the Rhine and in various places in Britain, notably at Castor in Northamptonshire and in the New Forest, were factories where large numbers of *pocula* or drinking cups were made; those made on the Rhine and at Castor bearing legends to indicate their use. Many of these are to be seen in the British Museum and in the Wallraf-Richartz Museum in Cologne.

After the decline of Roman power, the Gothic and Scandinavian races who replaced the Romans in central and northern Europe brought with them their own forms and types of drinking vessels. These, from about the 4th century, replaced the well-known Roman vessels. The northern barbarians were as great drinkers as fighters, and their literature recites with equal zest the richness of their drinking cups as the power and deadly qualities of their arms. Fortunately the practice of burying with the dead warrior all his property, or at least as much of it as he would be supposed to need, has preserved to our day the actual vessels in use by the pagan northmen who pervaded northern Europe from the 4th century onward. Saxon graves in Britain have furnished great numbers of drinking cups and horns, in many cases quite unbroken. From the remains, of which the chief series are in the British and Liverpool Museums, we can learn a great deal to amplify the references in literature. The richest single interment that has yet been found was within the present churchyard at Taplow. Here under a huge mound lay buried a Saxon chieftain surrounded by his belongings; arms defensive and offensive, his drinking cups, and even his game of draughts. The drinking vessels consisted of five cows' horns and four glass cups. The former were of great size, 2 ft. long, richly mounted at the mouth and at the point with silver bands embossed and gilt. The glasses also were of great size and of a type familiar in Saxon interments. Each was of a trumpet shape, with a small foot, while the sides were ornamented with hollow pointed tubes bent downwards, and open on the inner side, so that the liquid would fill them. Such a plan is most unpractical, and it must have been very difficult to keep the vessels clean. Glasses of this uncommon form have not been found elsewhere than in Saxon graves, either in England or in the north of the continent. Other types are perhaps nearly as characteristic, though of simpler construction. One of these is a simple cone of glass, sometimes quite plain, at others ornamented with an applied spiral glass thread, or more rarely with festoons of white glass embedded in the body of the vessel. A third form is a plain cup or bowl widely expanded at the mouth and with a rounded base, so that it could only be set down when empty, in fact a true "tumbler." This feature is in fact a very common one in the drinking vessels of the Saxon race. There are many other varieties, plain cylindrical goblets, generally with ornamental glass threads on the outside, and a more usual type has a rounded body somewhat of the shape of an orange with a wide plain mouth. Many of all these classes were found in the famous cemetery known as the King's Field at Faversham in Kent (the relics from which are now in the British Museum), at Chessel

Down in the Isle of Wight, and in the cemetery within the ancient camp on High Down, near Worthing. In Belgium, France and Germany the same types occur, and even as far north as Scandinavia, where they are found in association with Roman coins of the 4th century. On the continent, however, additional types are found that do not occur in Britain—one of these is a drinking glass in the form of a hunting horn with glass threads forming an ornamental design on the outside. From the wide distribution of these types, it seems certain that they sprang originally from a common centre, and the slender evidence available on the subject seems to point to that centre having been somewhere on the lower Rhine. Although glass seems to have been popular and by no means rare as a material for drinking vessels, other materials also were used. A large number of the smaller pottery vessels would serve such a purpose, and in one grave at Broomfield in Essex two small wooden cups were found which, from their small size and thinness, were no doubt used for liquid.

Of the later Saxon domestic utensils nothing remains, the habit of burying such objects with the dead having ceased on the gradual introduction of Christianity through the country. Manuscripts are our only resource, and they are not only of great rarity, but in the main rudely and conventionally drawn in their details. In those of the 9th to the 11th century various simple forms are seen, some resembling our modern tumbler in shape, others like a dice box. Horns as drinking vessels certainly retained their popularity at all times, surviving especially among the northern nations, and many of the vessels of this form were no doubt actual horns, though horn-shaped vessels were often made of other materials. Until we come to the 13th and 14th centuries there is an absolute dearth of the actual objects used in domestic life. And here we begin with plate used in the service of the church.

The drinking vessel possessing the most unbroken history is doubtless the chalice of the Christian Church.² Like other ceremonial objects it was no doubt differentiated from the drinking cups in ordinary use by a gradual transition, and in the early centuries it is unlikely that it differed either in form or material from the ordinary domestic vessel of the time. Figures of such vessels, apparently with a symbolic intention, are found upon early Christian tombstones, and it has been contended that the vessel indicated the grave of a priest. While this may be the case, the similarity of the vessel represented to the ordinary non-liturgical form renders the conclusion somewhat weak. Among objects found under conditions which lend colour to their specific use as chalices are the bottoms of glass vessels found inserted in plaster in the Catacombs at Rome; but here again the Jesuit Padre Garrucci was unable to find any evidence to support such a conclusion. It is not in fact until the 6th century that the sacred vessel would appear to have assumed a definite form. From about that time date the lost golden chalices of Monza, representations of which still exist in that city; and the famous chalice of Gourdon in the Bibliothèque Nationale in Paris is probably of about the same time. All of these are two-handled with a vase-shaped body and supported on a high foot; and thus quite unlike the more recent medieval types. Two glass vases of exactly this two-handled form are in the Slade collection at the British Museum, and may well have been chalices. Another chalice, in the same collection, of the 6th or 7th century, was found with a silver treasure at Lampsacus on the Hellespont. It is of silver, with a cylindrical body and small expanding foot; with it were found a number of silver spoons and dishes, the former inscribed with the names of Apostles, Greek hexameters and lines from Virgil's Eclogues. No doubt the whole was the treasure of a monastery, buried and never reclaimed. So far as evidence exists for the form of the chalice, the vase-shape with two handles seems to have been mainly succeeded by a goblet with straight sides and without handles; these latter in great part disappeared. Then came the rounded cup-shaped bowl as seen in the well-known Kressmünster chalice. An

¹ See PLATE, Plate I.

² For two illustrations see PLATE, Plate II.

interesting silver vessel, probably a chalice, found at Trehiddle in Cornwall, is in the British Museum. It is of plain semi-oviform shape, and dates from the 9th century. The 13th century chalice was usually a broad somewhat shallow cup, on a conical base, and squat in its general lines as compared with those of later date. These gradually became taller, and with a bowl smaller in proportion, following the tendency of the civil vessels towards more elegant lines. Both civil and religious vessels eventually carried this tendency to an extreme point, so that in the 17th century the continental chalices and standing cups had lost all sense of true artistic proportions; the bowl of the chalice had greatly shrunk in size while the foot had become huge and highly elaborate, both in general form and in ornamental details. In Britain chalices ceased to be used in the English church in the reign of Edward VI., and were replaced by communion cups. These were much plainer in make, recalling in their outlines the goblet form of about a thousand years earlier, the sides of the bowl being concave, or nearly straight, as opposed to the convexity of the chalice, while the paten was reversed over the mouth and so arranged as to form a closely fitting cover. With the beginning of the 17th century English communion cups again followed the civil fashion in adapting the outline of the Venetian drinking glass, a shape which has survived to our own days.

The materials of which chalices were made in the early centuries seem to have been as various as those of ordinary vessels. Glass was undoubtedly a favourite substance, perhaps from its lending itself readily to scrupulous cleanliness; but wood, horn, ivory and similar materials were undoubtedly in use, and were from time to time condemned as improper by the Fathers of the Church. Pewter was in common use, and it was not an unusual practice in the 12th and 13th centuries to place sacramental vessels, of this or more precious metal, in the grave of an ecclesiastic. Bronze was also used, and the Krensmünster chalice is of that metal, which was a favourite one in the Celtic church. But gold or silver chalices were no doubt always preferred when they could be obtained.

It may be mentioned here that it was a common practice in the 16th century and later in England for laymen to make gifts to the church of vessels of an entirely domestic character for use in the service. Many of these from their associations, and in the character of the designs upon them, were entirely unsuited for such purposes, and in our own time, when a healthy desire has sprung up for the proper investigation of such matters, many such unsuitable vessels have been withdrawn from use. Domestic plate, however, being much more highly appreciated by collectors, there has been a regrettable tendency on the part of the holders of such pieces to sell them to the highest bidders; the tendency is to be deplored, for while they remain the property of the church, they are a national asset; if sold by auction, there is a great probability of their going abroad.

It would seem fairly certain that the ordinary drinking vessel of medieval times was, like the trenchers of wood, turned on the lathe. Of these the commoner varieties have entirely disappeared, having become useless from distortion or other damage. Such as have come down to our own time owe their preservation to the added refinement of a silver mount. Vessels of this kind are known as *mazer* bowls, a word of uncertain origin, but undoubtedly, in the medieval sense, indicating wood of some more or less valuable kind, and not improbably, in the 16th century, maple or a wood of that appearance. Spenser in the "Shepherd's Kalendar" speaks of "a mazer ywrought of the maple warre." Although such vessels are mentioned in the inventories and other contemporary records as far back as the 12th century, no example is known to exist of an earlier date than the 14th century, of which date there are two in the possession of Harbledown hospital. This type of drinking vessel was in common use in well-to-do households until the 16th century, when a change of fashion and the greater luxury and refinement dictated the adoption of more elegant and complex forms. The ordinary mazer was a shallow bowl (see **PLATE**,

Plate II.) about 6 in. in diameter, with a broad expanding rim of silver gilt often engraved with a motto in black letter or Lombardic capitals, at times referring to the function of the cup, such as:—

"In the name of the Trinity
File the Kup and drinke to me."

or,

"Potum et nos benedicat Agioa."

Within the bowl, in the centre is often found a circular medallion called a "print" with some device upon it, engraved and filled with enamel. The reason of this addition may conceivably be found in the fact that such bowls were sometimes made from the lower half of a gourd or calabash, in the centre of which would be a rough projection whence the fibres of the fruit had diverged. A rarer form of mazer has the characters just mentioned and in addition is mounted upon a high foot, bringing it nearer to the category of standing cups or "hanaps." The famous Scrope mazer belonging to York Minster (early 15th century) stands upon three small feet. Of the hanap type examples are in the possession of Pembroke College, Cambridge (the Foundress' Cup), and All Souls' College, Oxford, the former an exceedingly fine specimen, of the third quarter of the 15th century. The form dictated originally by the simple wooden cup was at times carried out entirely in silver, or even in stone, mazer-like cups being found either entirely in metal or with the main portion made of serpentine or some other ornamental stone. An example of the former from the Hamilton Palace collection, as well as several ordinary mazers, are to be seen in the British Museum. The types above described are of English origin, with the exception of that made entirely of silver, which is thought to be French. Most of the continental forms differed from the English, and were more elaborately finished. One of the finest is that which belonged to Louis de Male, last count of Flanders. It is an exceedingly thin, shallow bowl of fine-grained wood, with a cover of the same make. The latter is surmounted by a silver figure of a falcon holding a shield in its mouth with the arms of the count. The foot is of silver with lozenge-shaped panels inserted, bearing in enamel the arms of the count. A German form of the 16th century consisted of a depressed sphere of wood for the bowl, with a silver rim, and a cover formed of a similarly shaped sphere, called in France a "creusequin." Such mazers were furnished in addition with a short metal handle turned up at the end, a feature unknown in the English types. All of these again are to be seen in the British Museum series.

Although the use of wooden vessels more or less elaborately mounted was continued well into the 16th century as a fashion, many other materials of far greater value were in use among the wealthy long before that time. Crystal, agate and other hard stones, ivory, Chinese porcelain, as well as more ordinary wares, were all in use, as well as the precious metals. The inventories of the 14th and 15th centuries are full of entries showing that such precious cups were fairly common. Of gold cups of any antiquity naturally but few remain; the intrinsic value of the metal probably is a sufficient explanation. One of the most important in existence is however preserved in the British Museum, viz. the royal gold cup of the kings of England and France. It is of nearly pure gold with a broad bowl and a high foot, the cover pyramidal. The whole is ornamented with translucent enamels of the most perfect quality, and with a little damage in one part, absolutely well preserved. The subjects represented on it are scenes from the life of St Agnes, in two rows, one on the cover and one outside the bowl; on the foot are the symbols of the four Evangelists, and around the base a coronal of leaves alternating with pearls; the cover originally had a similar adjunct, but it has unfortunately been cut away. This is the only piece of royal plate of the treasures of the kings of England and France that now remains, and its history has been traced from the time it was made, about the year 1380, to the present time. It was made by one of the goldsmiths of the luxurious Duc de Berri, the brother of Charles V. of France, no doubt to offer as a gift to the king, whose

birthday was St Agnes' day. It was, however, never presented, probably owing to the death of Charles V. in 1380. The duc de Berri was not on friendly terms with his nephew Charles VI., but on their being reconciled he presented the young king with this cup. The troubles of his reign led to the invasion of France by Henry V. of England, and the ultimate appointment of his brother, John, duke of Bedford, as regent. The necessities of the half-insane Charles doubtless caused this cup and other valuables to pass into the possession of the regent in exchange for ready money, for it appears in the duke of Bedford's will, under which it passed into the treasury of Henry VI. There it remained and appears in all subsequent royal inventories up to the time of James I. This monarch, whose motto was "Beati pacifici," received with joy the embassy sent from Spain in the year 1610 to conclude the first treaty of peace with England since the Armada, and showered upon the envoy, Don Juan de Velasco, constable of Castile, the most lavish and extravagant gifts. The constable, in fact, was so impressed by the warmth of his reception that he printed an account of his embassy, and from this work the main story of the cup has eventually been traced. On his return to Spain the constable, a piously disposed man, presented this cup, with many other valuable gifts, to the convent of Santa Clara Medina de Pomar at Burgos, of which his sister was Superior. Although it was a domestic vessel, a "hanap" in fact, the constable elected that it should be consecrated and made use of as a chalice at great festivals. And so it continued to be used from the early years of the 17th century until about the year 1882, when the convent having fallen upon evil times, it was decided to sell this precious relic. A priest from the Argentine being at the time in Burgos, it was confided to him to sell in Paris, and he deposited the sum of £100 by way of security. This was all that the unfortunate nuns at Burgos ever received in return for their chalice, for they never saw the priest again. He took the cup to Paris, arriving in the month of September, when the majority of the well-to-do are away from town. After many failures to dispose of it, he ultimately succeeded in selling it to Baron Jerome Pichon for the sum of about £400, practically its weight in gold. The baron, after vainly trying to resell it at various sums from £20,000 downwards, eventually parted with it to Messrs Wertheimer of Bond Street for £8000, and that firm very liberally ceded it to Sir Wollaston Franks for the same sum, and it was finally secured by a subscription for the British Museum.

Such is the story of one of the most remarkable "hanaps" in existence. The word "hanap" is translated by Cotgrave in his French dictionary of 1660 as "a drinking cup or goblet," and probably was intended to mean what would be called a standing cup, that is, raised on a foot, to distinguish it from a bowl of the mazer class. Such vessels were chiefly used to ornament the dinner table or sideboard, in the way that loving-cups are now used at civic banquets, where, almost alone in fact, the ancient ceremonial of the table is still observed to some extent; and the loving-cup is the direct descendant of the hanap of the middle ages.

Of all the ornaments of the table in medieval times the most conspicuous was probably the "nef." This was in the form of a ship (*navis*), as its name implies, and originally was designed to hold the table utensils of the host—knives, napkins, and at times even the wine. Some of the later examples which alone survive are carried out with the greatest elaboration, the sails and rigging being carefully finished and with a number of figures on the deck. The reason for the existence of such an article of table furniture was doubtless the fear of poison. As in course of time this became less, the nef changed its character, and became either a mere ornament, or sometimes was capable of being used as a drinking vessel. The former, however, was much more common, and the number of nefes that can be practically used as drinking cups is small.

In the 15th and 16th centuries the shapes, decoration and materials of drinking vessels were almost endless. A favourite object to be so adapted was an ostrich egg, and many can be seen in museums in elaborate silver mounts; coco-nuts were also

used in the same way, and Chinese and other Oriental wares then of great variety, were often turned into cups and vases by ingeniously devised silver mounting. The use of drinking vessels either formed of actual horns or of other materials was common in the 15th and 16th centuries, especially in the north. They were usually provided with feet so as to serve as standing cups, and some of them were mounted with great richness. An excellent example is the famous drinking-horn in the possession of Queen's College, Oxford, dating from the 14th century. The medieval beliefs about "griffins' claws" still survived to this late date, and a horn cup in the British Museum bears the inscription "Ein Greifen Klau bin ich genannt, In Asia, Africa wohl bekannt." Another horn, probably that of an ibex, is in the same institution, and has a silver mount inscribed "Gryphi unguis divo Cuthberto dunelmensi sacer." The elegant natural curve of the horn adds greatly to the charm of the vessel. In Germany the ingenuity of the silversmith was turned in the direction of making vessels in the forms of animals, at times in allusion to the coat of arms of the patron. Stags, lions, bears and various birds are often found; the head generally removable so as to form a small cup. Switzerland and south Germany had a special type, in the form of the figure of a peasant, generally in wood, carrying on his back a large basket, which edged with silver formed the drinking cup. This type is only found in wine-growing districts, the basket being used for carrying grapes. In Germany such cups are called "Buttenmann," in Switzerland "Tanzenmann." The royal and princely museums of Germany contain great numbers of such vessels, the Green Vault in Dresden in particular, while a good number are to be seen in our own great museums. A curious fancy, combining instruction with conviviality, was to make cups in the form of a globe, terrestrial or celestial, which are still useful as showing the state of geographical or astronomical knowledge at the time. Several of those made in the 16th century are still in existence, one in the British Museum, a second at Nancy, and others are in Copenhagen and Zürich and in private collections. The upper half of the globe is removable, leaving the lower as the drinking cup. Ivory both from the beauty of its colour and the evenness of its structure has been a favourite material for drinking vessels at all times, and would seem to have been continuously used from the earliest period, whether derived from Asia or Africa, while the semi-fossil mammoth ivory of Siberia has not been neglected. In general, however, the vessels made from this material presented no essential differences of form from those in wood, until the art of lathe-turning attained great perfection, when a wide field was opened for ingenuity and even extravagance of form. The most remarkable examples of the possibilities of this kind of mechanical skill are seen in the productions of the Nuremberg turners of the 17th century, whose elaborate and entirely useless *tours de force* comprise among many other things standing cups of ivory sometimes 2 ft. high, exemplifying every eccentricity of which the lathe is capable. Peter Zick (d. 1632) and his three sons were celebrated for such work. Several pieces, doubtless from their hands, are in the British Museum.

The use of glass cups was not common in England until the 16th century, Venice having practically the monopoly of the supply. A silver-mounted glass goblet which belonged to the great Lord Burghley is, however, in the British Museum, where there is also a very large series of Venetian drinking glasses of various kinds, clear and lace glass as well as some of the 15th-century goblets with enamelled designs, now of the greatest rarity. The relations of Venice with the East were of so intimate a character that the earlier forms of Venetian glasses were nearly identical with those of the Mahomedan East.

A common type of Arab drinking glass resembled our modern tumbler (a beaker), but gradually expanding in a curve towards the mouth, and often enamelled. The enamelled designs were at times related to the purpose of the vessel, figures drinking and the like, but more commonly bore either a mark of ownership—such as the armorial device of an emir, or some simple decor

design. This simple form probably has its origin in the horn cup made from the base of a cow's horn and closed at the smaller end. The later forms in the late 15th century and after, followed the fashion in other materials, and were raised on a tall foot, so that from the 16th century onwards the type of wine glass has hardly changed, except in details. An interesting variety in one detail is seen in the German fashion of providing an elaborate silver stand into which the foot of such an ordinary-shaped glass was made to fit. Frequently, as might be expected, such stands are found without glasses, and their use then seems difficult to explain.

Another characteristic German type is the "wiederkom," a vessel more conspicuous for capacity than for its artistic qualities. It is usually a cylindrical vessel of green glass often holding as much as a quart, elaborately enamelled with coats of arms and views of well-known places; and at times when the cup was a wedding gift the figures of the bride and bridegroom are seen upon it.

A very fanciful kind of cup was known in England as a "yard of ale," a long tube of glass generally shaped like a coach horn, but ending sometimes in three prongs as a trident, the opening in the latter being at the end of the handle, which was about a yard in length.

Small silver cups were often made in dozens with various devices, differing in each, such as the signs of the zodiac, the occupations of the months, or figures of the classical gods and goddesses, engraved upon them.

The tankard came into fashion in the 16th century, a practical, but seldom graceful object. At first some attempt was made, by shaping the sides, to attain to some artistic quality, but usually the tankard from the late 16th century to the present time is found with straight sides, either vertical or contracting towards the top, which is of course always furnished with a hinged lid.

A material that has one obvious merit, that of being practically unbreakable, is leather, and drinking cups were often made of it. The flagon called a "black jack" is the best-known, and examples are very common, mostly of the 17th and 18th centuries. A quaint fashion was to have a leather cup made in the form of a lady's shoe; this, however, was confined to Germany and might be thought in somewhat questionable taste.

In the 17th and 18th centuries a great impetus was given to the production of curious drinking vessels in pottery. In England at various potting centres a great number of cups called "tygs" were made: capacious mugs with several handles, three or four, round the sides, so that the cup could be readily passed from one to the other. Many of these have quaint devices and inscriptions upon them. Another favourite plan is to make a jug with openwork round the neck and a variety of spouts, one only communicating with the liquid. These "puzzle jugs" no doubt caused a good deal of amusement when attempted by a novice, who would inevitably spill some of the contents.

The horn of the rhinoceros is much favoured by the Chinese as a material for drinking cups often of a somewhat archaic form. The dense structure of the horn is well adapted for the purpose, and its beautiful amber hue makes the vessel a very agreeable object to the eye. The usual form is of a boat shape on a square foot, and the carved decoration is often copied from that of the bronze vessels of the earlier dynasties. Others are treated in a freer and more naturalistic manner, the bowl being formed as the flower of the magnolia, and the entire horn, at times more than 2 ft. in length, is utilized in carrying out the design. One of this kind is in the Victoria and Albert Museum. Cups of the former type are commonly found imitated in ivory-white porcelain, and are known as "libation cups." Rhinoceros horn is held by the Chinese to be an antidote against poison, a belief shared by other nations.

There is but little to be said about the vessels used in the drinking of tea and coffee. In Europe the type has practically remained unchanged since the introduction of tea and coffee drinking, except that in the 18th century the tea-cups imported from China had no handles, and were generally thinner than the

coffee cups. In Japan there is a ceremonial way of drinking tea, known as *Cha no yu*. Here powdered green tea is used; the party assembles in a small pavilion in a garden, and the tea is made in accordance with a rigid etiquette. The infusion is stirred with a whisk in a rudely fashioned bowl, holding about a pint, and passed from one guest to another. The bowls are of very thick pottery, never of porcelain, and the most valued kind is that made in Korea. In the drinking of rice spirit (*saké*) in Japan small wide shallow cups are used, made generally of porcelain, but sometimes of finely lacquered wood. Both kinds are usually ornamented with elaborate and sometimes allusive designs.

Tea and coffee cups.

Among savage races the most peculiar drinking ceremony is that of kava drinking in Polynesia, principally in the Fijian, Tongan and Samoan groups. The best description of the process is given in Mariner's *Tonga*. The principal vessel is usually a large bowl, sometimes measuring 2 or 3 ft. in diameter, cut from a solid block of wood. It has four short legs and an ear at one side to which a rope of coco-nut fibre is generally attached. The liquid is prepared in this bowl and ladled out in small cups often made of coco-nut shells, and these are handed round with great ceremony. Both the bowl and the cups become coated in the inside with a highly polished layer, pale blue in colour; but this beautiful tint fades when the vessel is out of use, and it is therefore very rarely seen in specimens in Europe. The kava itself is prepared from the root of a tree of the pepper family (*Piper methysticum*); the root is cut into pieces of a convenient size, and these are given to young men and women of the company, who masticate them, and the lumps thus shredded are placed in the large bowl, water is poured over them, and the mass is strained with great care by wringing it in strips of the inner bark of the *hibiscus*. The liquor is slightly intoxicating.

If the Polynesian method of preparing kava as a drink is distasteful to our ideas, the favourite drinking bowl of the old Tibetans is even more so. Friar Odoric (14th century), quoted by Yule, describes how the Tibetan youth "takes his father's head and straightway cooks and eats it, and of the skull he makes a goblet from which he and all his family always drink devoutly to the memory of the deceased father." This recalls Livy's account of the Boii in Upper Italy, who made a drinking vessel of the head of the Roman consul Postumus. Among the Tibetans skulls are still used, but generally for libations only; for this purpose great care is exercised in the selection of the skull, and the "points" of a good skull are well understood by the Lamas. (C. H. Rd.)

DRIPSTONE, in architecture, a projecting moulding weathered on the upper surface and throated underneath so as to form a drip. The term is more correctly applied to a string course. When carried round an arch its more correct description would be a hood (*q.v.*). When employed inside a building it serves a decorative purpose only.

DRISLER, HENRY (1818-1897), American classical scholar, was born on the 27th of December 1818, on Staten Island, New York. He graduated at Columbia College in 1839, taught classics in the Columbia grammar school for four years, and was then appointed tutor in classics in the college. In 1845 he became adjunct professor of Latin and Greek there, in 1857 was appointed to the new separate chair of Latin language and literature, and ten years later succeeded Dr Charles Anthon as Jay professor of Greek language and literature. He was acting president in 1867 and in 1888-1889, and from 1890 to his retirement as professor emeritus in 1894 was dean of the school of arts. He died in New York City on the 30th of November 1897. Dr Drisler completed and supplemented Dr Anthon's labours as an editor of classical texts. His criticisms and corrections of Liddell and Scott's *Greek-English Lexicon*, of which he brought out a revised American edition in 1846, won his name a place on the title-page of the British edition in 1879, and in 1870 he published a revised and enlarged edition of Yonge's *English-Greek Lexicon*. He was ardently opposed to slavery, and brilliantly refuted *The Bible View of Slavery*, written by Bishop

J. H. Hopkins of Vermont, in a *Reply* (1863), which meets the bishop on purely Biblical ground and displays the wide range of Dr Dristler's scholarship.

DRIVER, SAMUEL ROLLES (1846—), English divine and Hebrew scholar, was born at Southampton on the 2nd of October 1846. He was educated at Winchester and New College, Oxford, where he had a distinguished career, taking a first class in Literae Humaniores in 1869. He was awarded the Pusey and Ellerton scholarship in 1866, the Kennicott scholarship in 1870 (both Hebrew), and the Houghton Syriac prize in 1872. From 1870 he was a fellow, and from 1875 also a tutor, of New College, and in 1883 succeeded Pusey as regius professor of Hebrew and canon of Christ Church. He was a member of the Old Testament Revision Committee (1876-1884) and examining chaplain to the bishop of Southwell (1884-1904); received the honorary degrees of doctor of literature of Dublin (1892), doctor of divinity of Glasgow (1901), doctor of literature of Cambridge (1905); and was elected a fellow of the British Academy in 1902. Dr Driver devoted his life to the study, both textual and critical, of the Old Testament. Among his numerous works are commentaries on Joel and Amos (1897); Deuteronomy (1902); Daniel (1901); Genesis (1909); the Minor Prophets, Nahum to Malachi (1905); Job (1905); Jeremiah (1906); Leviticus (1894 Hebrew text, 1898 trans. and notes); Samuel (Hebrew text, 1890). Among his more general works are: *Treatise on the Use of the Tenses in Hebrew* (1892); *Isaiah, his Life and Times* (1893); *Intro. to the Literature of the Old Test.* (1897, ed. 1909); *Sermons on Subjects connected with the Old Testament* (1892); *The Parallel Psalter* (1904); *Heb. and Eng. Lexicon of the O. T.* (in collaboration, 1906); *Modern Research as illustrating the Bible* (1909); articles in the *Ency. Brit.*, *Ency. Bibl.* and *Hastings' Dict. of the Bible*.

DRIVING (from "to drive," *i. e.* generally to propel, force along or in, a word common in various forms to the Teutonic languages), a word used in a restricted sense for the art of controlling and directing draught animals from a coach or other conveyance or movable machine to which they are harnessed for the purpose of traction. This has been an occupation practised since domesticated animals were first put to this use. In various parts of the world a number of different animals have been, and still are, so employed; of these the horse, ox, mule and ass are the most common, though their place is taken by the reindeer in northern latitudes, and by the Eskimo dog in arctic and antarctic regions. The driving of each of these requires special skill, only to be acquired by practice combined with knowledge of the characteristics peculiar to the several animals employed. The most accomplished driver of spirited horses would probably be in difficulties if called upon to drive sixteen or twenty dogs in an arctic sledge, or a team of oxen or mules drawing the guns of a mountain battery; and the adept in either of these branches of the art might provoke the compassion of a farmer from Lincolnshire or Texas by his attempts to manage a pair of Clydesdale horses in the plough or the reaping machine.

Under all these different conditions driving is a work of utility, of economic value to civilized society. But from very early times driving, especially of horses, has also been regarded as a sport or pastime. This probably arose in the first instance from its association with battle. In the earliest historical records, such as the Old Testament and the Homeric poems, the driver of the chariot fills a place of importance in the economy of war; and on his skill and efficiency the fate of kings, and even of kingdoms, must often have depended. The statement in the *Book of Kings* that Jehu the son of Nimshi was recognized from a distance by his style of driving appears to indicate that the warrior himself on occasion took the place of the professional charioteer; and although it would be unsafe to infer from the story that the pleasure derived from the occupation was his motive for doing so, the name of this king of Israel has become the eponym of drivers. Among the Greeks at an equally early period driving was a recognized form of sport, to the popularity of which Horace afterwards made allusion. Racing between teams of horses harnessed to war-chariots took the place occupied

by saddle-horse racing and American trotting races (see *HORSE-RACING*) in the sport of modern times. The element of danger doubtless gave pleasurable excitement to chariot racing and kept alive its association with incidents familiar in war; just as at a later period, when the institution of chivalry had given the armed knight on horseback a conspicuous place in medieval warfare, the tournament became the most popular sport of the aristocracy throughout Europe.

This element of danger cannot be said to enter usually into the enjoyment of driving at the present day. Though accidents occasionally happen, the pastime is practically unattended by serious risk; and the source of the pleasure it affords the driver must be sought in the skill it requires, combined with the love of the horse which is common to sportsmen, and of exercise of power. The art of driving as practised to-day for pleasure without profit, and without the excitement of racing, is of quite modern development. Oliver Cromwell, indeed, met with a mishap in Hyde Park while driving a team of four horses presented to him by the count of Oldenburg, which was the subject of more than one satirical allusion by contemporary royalist writers; but two things were needed before much enjoyment could be found in driving apart from utility. These were the invention of carriages on springs, and the construction of roads with smooth and solid surface. The former did not come into general use till near the end of the 18th century, and it was about the same period that the engineering skill of Thomas Telford and the invention of John London Macadam combined to provide the latter. The influence on driving of these two developments was soon apparent. Throughout the 18th century stage-coaches, ponderous unwieldy vehicles without springs, had toiled slowly over rough and deeply rutted tracks as a means of communication between different parts of Great Britain; but those who made use of them did so as a matter of necessity and not for enjoyment. But by the beginning of the 19th century the improvement in carriage-building and road-construction alike had greatly diminished the discomfort of travel; and interest in driving for its own sake grew so rapidly that in 1807 the first association of amateur coachmen was formed. This was the Bensington Driving Club, the forerunner of many aristocratic clubs for gentlemen interested in driving as a pastime.

In modern driving one, two or four horses are usually employed. When a greater number than four is put in harness, as in the case of the state equipages of royal personages on occasions of ceremony, the horses are not driven but are controlled by "postillions" mounted on the near-side horse of each pair. When two horses are used they may either be placed side by side, in "double harness," which is the commoner mode of driving a pair of horses, or one following the other, in a "tandem." Four horses, or "four-in-hand," are harnessed in two pairs, one following the other, and called respectively the "leaders" and the "wheelers"—the same terms being used for the two horses of a tandem.

Though it is a less difficult accomplishment to drive a single horse than a tandem or four-in-hand, or even a pair, it nevertheless requires both knowledge and the skill that practice alone confers. The driver should have some knowledge of equine character, and complete familiarity with every part of the harness he uses, and with the purpose which each buckle or strap is intended to serve. The indefinable quality known in horsemanship as "good hands" is scarcely less desirable on the box-seat than in the saddle. It is often said to be unattainable by those who do not possess it by nature; but though this may be true to some extent, "good hands" are partly at least the result of learning the correct position for the arm and hand that holds the reins. The reins are held in the left hand, which should be kept at about the level of the lowest button of the driver's waistcoat, and near the body though not pressed against it. The driving hand should never be reached forward more than a few inches, nor raised as high as the breast. The upper arm should lie loosely against the side, the forearm horizontal across the front of the body, forming a right angle or

thereabouts at the elbow-joint, the wrist very slightly bent inwards, and the back of the hand and knuckles facing outwards towards the horses. In this position the three joints of the arm form a kind of automatic spring that secures the "give" to the movement of the horse's mouth which, in conjunction with firmness, is a large part of what is meant by "good hands." But this result is only obtained if the reins be also held with the proper degree of bearing on the bit. What the proper degree may be depends greatly on the character of the horses and the severity of the bit. Pulling horses must be restrained by a strong draw on their bits, such as would bring other animals to a standstill. But under no circumstances, no matter how sluggish the horses may be, should the reins be allowed to lie slack; for if this is done the horse receives no support in the event of a sudden stumble, and no control if he shies unexpectedly. The driver should therefore always just "feel his horse's mouth" as lightly as possible; he then has the animal well under control in readiness for every emergency, while avoiding such a pull on the mouth as would cause a high-spirited horse to chafe and fret. Well-broken carriage horses should always be willing to run into their bits, and those that draw back when lightly held in hand should be kept up to the bit with the whip.

These principles are common to all branches of the art of driving, whether of one, two or four horses. When they are observed no great difficulty confronts the coachman who is content with single or double harness, provided he has acquired the eye for pace and distance, and the instinctive realization of the length of the carriage behind him, without which he may suffer collision with other vehicles, or allow insufficient room in turning a corner or entering a gateway. For before he can have had the practice by which alone this knowledge is to be gained, the beginner will have learnt such elementary facts as that his horses must be held well in hand going down hill and given their heads on an ascent, and that on no account should the horse's mouth be "jobbed" by the driver jerking the reins; he will also have learnt a good deal about the character and temperament of the horse, on which so much of the art of driving depends, and which can best be studied on the box-seat and not at all in the library. If he has pursued this study with any degree of insight, he will have learnt further to be sparing in the use of the hand-brake with which most modern carriages are provided. This apparatus is most useful in case of emergency, or for taking weight off the carriage on a really steep descent; but the habit which too many coachmen fall into of using the brake on every trifling decline should be avoided. Its effect is that the horses are continually doing collar-work, and are thus deprived of the relief which ought to be given them by occasional light pole or shaft work instead.

When the ambition of the amateur coachman leads him to attempt a tandem or four-in-hand he enters on a much more complex department of the art of driving. In the first place he has now four reins instead of two to manipulate, and the increase of weight on his hand, especially when four horses are being driven, requires considerable strength of wrist to support it without tiring. It is of the first importance, moreover, that he should know instinctively the position in his hand of each of the reins, and be able automatically and instantaneously to lay a finger on any one of them. The driver who has to look at his reins to find the off-side leader's rein, or who touches the near-side wheeler's in mistake for it, is in peril of a catastrophe. It is therefore essential that the reins should be correctly disposed between the fingers of the left hand, and that the driver should as quickly as possible accustom himself to handle them automatically. This is somewhat more difficult in driving tandem than in driving four-in-hand, because in the latter case there is greater spread of the reins in front of the hand than with tandem, where the reins lie much more nearly parallel one above the other. The actual holding of the reins is the same in both cases. The coachman should be careful to take the reins in his hand before mounting to the box-seat, as otherwise his team may make a start without

his having the means to control them. It is customary to hitch the reins, ready for him to take them, on the outside terret (the ring on the pad through which the rein runs) of the wheeler—the off-side wheeler in four-in-hand. Standing on the ground beside the off-side wheel of his carriage, ready to mount to the box-seat, the coachman, after drawing up his reins till he almost feels the horses' mouths, must then let out about a foot of slack in his off-side reins, in order that when on his seat he may find all the reins as nearly as possible equal in length in his hand. He mounts with them disposed in his right hand precisely as they will be in his left when ready to start. The leaders' reins should be separated by the forefinger, and the wheelers' by the middle finger. The near-leader's rein will then be uppermost of the four, between the forefinger and thumb; then between the forefinger and middle finger are two reins together—the off-leader's and the near-wheeler's in the order named; while at the bottom, between the middle and third fingers, is the off-wheeler's rein. It will be found that held thus the reins spread immediately in front of the hand in such a way that each several rein, and each pair of reins—two near-side, two off-side, two wheelers' or two leaders—can be conveniently manipulated; and the proficient driver can instinctively and instantaneously grasp any of them he chooses with his right hand without having to turn his eyes from the road before him to the reins in his hand. Having seated himself on the box and transferred the reins, thus disposed, from the right to the left hand, the coachman should shorten them till he just feels his wheelers' mouths and holds back his leaders sufficiently to prevent them quite tightening their traces; then, when he has taken the whip from its socket in his right hand, he is ready to start. This is an operation requiring careful management, to secure that leaders and wheelers start simultaneously; for if the leaders start first they will be drawn up sharp by their bits, or, what is worse, if their reins have not been sufficiently shortened they will jump into their collars and possibly break a swinging bar, and in either case they will be fretted and disconcerted and will possibly in consequence either kick or rear; if the wheelers start before the leaders they will ram the swinging bars under the tails of the latter, with results equally unfortunate. The worst possible method of starting is suddenly to give the horses their heads and use the whip. But no positive rule can be laid down, for it is just one of those points which depend largely on familiarity with the horses forming the team. Horses even moderately accustomed to the work will generally start best in obedience to the voice, and their attention may simultaneously be aroused by gently feeling their mouths. When once started the driver should at once see that his team is going straight. If the leaders and wheelers are not exactly on the same line, this or that rein must be shortened or lengthened as the case may require; and it is to be noticed that as the near-wheeler's and off-leader's reins lie together between the same fingers, a simultaneous shortening or lengthening of these two reins will usually produce the desired result. With rare exceptions, reins should be shortened or lengthened by pushing them back or drawing them forward with the right hand from in front of the driving hand, and not from behind it. As soon as the team is in motion the leaders may be let out till they draw their traces taut; but draught should be taken off them on falling ground or while rounding a corner. Good drivers touch the reins as little as possible with the whip-hand, and nothing is less workmanlike than for a coachman to act as if he were an angler continually letting out or reeling in his line. In rounding a corner a loop of an inch or two of the leaders' rein on the side to which the turn is to be made is taken up by the right hand and placed under the left thumb. This "points the leaders," who accordingly make the required turn, while at the same time the right hand bears lightly on the wheelers' rein of the opposite side, to prevent them making the turn too sharply for safety to the coach behind them. As soon as the turn is made—and all this applies equally to the passing of other vehicles or obstacles on the road—the driver's left thumb releases the loop, which runs out of itself, and the team returns to the straight formation. A circumstance

*Tandem
and four-
in-hand.*

useful to bear in mind is that the swinging bars are wider than the maximum width of the coach; consequently the driver knows that wherever the swinging bars can pass through with safety—and as they are before his eyes the calculation is easy—the coach will safely follow.

A necessary part of driving four horses or tandem is the proper use of the whip. The novice, before beginning to drive, should

acquire the knack—which can only be learnt by practical instruction and experiment—of catching up the thong of the whip on to the stick by a flick of the wrist. With practice this is done almost automatically and without looking at the whip. It is not merely an ornamental accomplishment, but a necessary one; for in no other way can the whip be kept in constant readiness for use either on wheelers or leaders as the need of the moment may dictate. The point of the thong is confined in the whip-hand when striking the wheelers (which should be done in front of the pad), and is released for reaching the leaders. Considerable dexterity is required in using the whip on the leaders without at the same time touching, or at all events alarming or fretting, the wheelers. The thong of the whip should reach the leaders from beneath the swinging bar; and proficient “whips” can unerringly strike even the near leader from under the off-side bar without disturbing the equanimity of any other member of the team. This demands great skill and accuracy; but no coachman is competent to drive four horses until he is able to touch with the whip any particular horse that may require it, and no other.

Essential as is proficiency in the use of the whip when driving four horses, it is even more imperative for the driver of tandem. For in four-in-hand the leaders act in some measure as a restraint upon each other's freedom of action, whereas the leader in tandem is entirely independent and therefore more difficult to control. If he takes it into his head to turn completely round and face the driver, there is no effectual means of preventing him. It is here that a prompt and accurate use of the whip is important. A sharp cut with the thong of the whip on the side to which he is turning will often drive the leader back into his place. But it must be done instantaneously, and the driver who has got his thong coiled round the stick of his whip, or who cannot make certain of striking the horse on precisely the desired spot, will miss the opportunity and may find his team in a sad mess, possibly with disastrous results. If the leader, in spite of a stroke from the whip at the right moment and on the right spot, still persists in turning, the only thing to be done is to turn the wheeler also; and then when the tandem has been straightened, to turn the horses back once more to their original direction. For this reason it is never safe to harness a tandem to a four-wheeled vehicle; because if it should be necessary to turn the wheeler sharply round, the fore-carriage would probably lock and the trap be overturned. Of comparatively recent years a great improvement has been effected in the harnessing of a tandem by the introduction of swinging bars similar to those used in four-in-hand. Formerly the leading traces in tandem drew direct from tugs on the wheeler's hames, or less frequently from the stops on the shafts. This left a considerable length of trace which, when draught was taken off the leader, hung slack between the two horses; with the result that either of them might get a leg over the leading trace, with dangerous consequences. In the more modern arrangement short traces attached to the wheeler's tugs hold a bar, which is kept in place by a few inches of chain from the kidney-link on the wheeler's collar. This bar is connected by short traces or chains with a second bar to which the leader's true traces are hooked in the usual way, allowing him a comfortable distance clear of the bar precisely as in four-in-hand. The leader thus draws as before from the wheeler's tugs; but the length of trace is broken up by the two swinging bars, and as these are prevented from falling low by their attachment to the wheeler's collar, the danger from a too slack leading trace is reduced to a minimum; though care is needed when the leader is not pulling to prevent the bar falling on his hocks.

Expert tandem driving, owing to the greater freedom of the

leader from control, is a more difficult art than the driving of four horses, in spite of the fact that the weight on the hand is much less severe; but the general principles of the two are the same. In Great Britain, however, the coach-and-four is the more popular. It is more showy than tandem; it keeps alive the romantic associations of the days when the stagecoach was the ordinary means of locomotion; and a coach, or “drag,” accommodates a larger party of passengers to a race-meeting or other expedition for pleasure than a dogcart. But for those whose means do not permit the more costly luxury of a four-horse team, a tandem will be found to make all the demand on skill and nerve which, in combination with the taste for horses, makes the art of driving a source of enjoyment.

See Donald Walker, *British Manly Exercises: in which Riding, Driving, Racing are now first described* (London, 1834); Fuller, *Essay on Wheel Carriages* (London, 1828); William Bridges Adams, *English Pleasure Carriages: their Origin, History, Materials, Construction* (London, 1837); *The Equitarian: A Handbook of Horsemanship, containing Plain Rules for Riding, Driving and the Management of the Horse* (London, 1854); a Cavalry Officer, *The Handy Horse Book; or Practical Instruction in Driving and the Management of the Horse* (London, 1865-1867, 1871-1881); H. J. Helm, *American Roadsters and Trotting Horses* (Chicago, 1878); E. M. Stratton, *The World on Wheels* (New York, 1878); J. H. Walsh (“Stonehenge”), *Riding and Driving* (London, 1863); James A. Garland, *The Private Stable* (2nd ed., Boston, 1902); the Duke of Beaufort, *Driving* (The Badminion Library, London, 1889), containing a bibliography; F. H. Huth, *Works on Horses and Equitation: A Bibliographical Record of Hippology* (London, 1887). (R. J. M.)

DROGHEDA, a municipal borough, seaport and market town, on the southern border of Co. Louth, Ireland, in the south parliamentary division, on the river Boyne, about 4 m. from its mouth in Drogheda Bay, and $3\frac{1}{2}$ m. N. by W. from Dublin on the Great Northern main line. Pop. (1901) 12,760. It occupies both banks of the river; but the northern division is the larger of the two, and has received greater attention in modern times. The ancient fortifications, still extant in the beginning of the 19th century, have disappeared almost entirely, but of the four gateways one named after St Lawrence remains nearly perfect, consisting of two looped circular towers; and there are considerable ruins of another, the West or Butler Gate. Among the public buildings are a mansion-house or mayoralty, with a suite of assembly rooms attached; and the Tholsel, a square building with a cupola. St Peter's chapel formerly served as the cathedral of the Roman Catholic archbishopric of Armagh; and in the abbey of the Dominican nuns there is still preserved the head of Oliver Plunkett, the archbishop who was executed at Tyburn in 1681 on an unfounded charge of treason. There was formerly an archiepiscopal palace in the town, built by Archbishop Hampton about 1620; and the Dominicans, the Franciscans, the Augustinians, the Carmelites and the knights of St John have monastic establishments. Of the Dominican monastery (1224) there still exists the stately Magdalen tower; while of the Augustinian abbey of St Mary d'Urso (1206) there are the tower and a fine pointed arch. At the head of the educational institutions there is a classical school endowed by Erasmus Smith. There is also a blue-coat school, founded about 1727 for the education of freemen's sons. The present building was erected in 1870. Benjamin Whitworth, M.P., was a generous benefactor to the town, who built the Whitworth Hall, furnished half the funds for the construction of waterworks, established a cotton factory, and is commemorated by a statue in the Mall. The industrial establishments comprise cotton, flax and flour mills, sawmills, tanneries, salt and soap works, breweries, chemical manure and engineering works. The town is the headquarters of the valuable Boyne salmon-fishery. A brisk trade is carried on mainly in agricultural produce, especially with Liverpool (which is distant 135 m. due E.) and with Glasgow. Many works of improvement have been effected from time to time in the harbour, the quays of which occupy both sides of the river, the principal, 1000 yds. in length, being on the north side. Here is a depth of 27 ft. at the highest and 14 ft. at the lowest tides. The tide reaches 2½ m. above the town to Oldbridge; and barges of 50 tons burden can proceed 19 m. inland to Navan. The river is crossed by a bridge for ordinary traffic, and by a

fine railway viaduct. The town is governed by a mayor, 6 aldermen and 18 councillors.

In the earliest notices the town of Drogheda is called Inver-Colpa or the Port of Colpa; the present name signifies "The Bridge over the Ford." In 1152 the place is mentioned as the seat of a synod convened by the papal legate, Cardinal Paparo; in 1224 it was chosen by Lucas de Netterville, archbishop of Armagh, for the foundation of the Dominican friary of which there are still remains; and in 1228 the two divisions of the town received separate incorporation from Henry III. But there grew up a strong feeling of hostility between Drogheda *versus Uriel* and Drogheda *versus Midium*, in consequence of trading vessels lading their cargoes in the latter or southern town, to avoid the pontage duty levied in the former or northern town. At length, after much blood had been shed in the dispute, Philip Bennett, a monk residing in the town, succeeded by his eloquence, on the festival of Corpus Christi, 1412, in persuading the authorities of the two corporations to send to Henry IV. for a new charter sanctioning their combination, and this was granted on the 1st of November. Drogheda was always considered by the English a place of much importance. In the reign of Edward III. it was classed along with Dublin, Waterford and Kilkenny as one of the four staple towns of Ireland. Richard II. received in its Dominican monastery the submissions of O'Neal, O'Donnell and other chieftains of Ulster and Leinster. The right of coining money was bestowed on the town, and parliaments were several times held within its walls. In the reign of Edward IV. the mayor received a sword of state and an annuity of £20, in recognition of the services rendered by the inhabitants at Malpas Bridge against O'Reilly; the still greater honour of having a university with the same privileges as that of Oxford remained a mere paper distinction, owing to the poverty of the town and the unsettled state of the country; and an attempt made by the corporation in modern times to resuscitate their rights proved unsuccessful. In 1495 Poyning's laws were enacted by a parliament held in the town. In the civil wars of 1641 the place was besieged by O'Neal and the Northern Irish forces; but it was gallantly defended by Sir Henry Tichbourne, and after a long blockade was relieved by the Marquess of Ormond. The same nobleman relieved it a second time, when it was invested by the Parliamentary army under Colonel Jones. In 1649 it was captured by Cromwell, after a short though spirited defence; and nearly every individual within its walls, without distinction of age or sex, was put to the sword. Thirty only escaped, who were afterwards transported as slaves to Barbados. In 1690 it was garrisoned by King James's army; but after the decisive battle of the Boyne (*q.v.*) it surrendered to the conqueror without a struggle, in consequence of a threat that quarter would not be granted if the town were taken by storm.

Drogheda ceased to be a parliamentary borough in 1835, and a county of a town in 1898. Before 1885 it returned one member, and before the Union in 1800 it returned four members to the Irish parliament.

From the close of the 12th century, certainly long before the Reformation and for some time after it, the primates of Ireland lived in Drogheda. Being mostly Englishmen, they preferred to reside in the portion of their diocese within the gate, and Drogheda, being a walled town, was less liable to attack from the natives. From 1417 onwards Drogheda was their chief place of residence and of burial. Its proximity to Dublin, the seat of government and of the Irish parliament, in which the primates were such prominent figures, induced them to prefer it to *Ardmacha inter Hibernicos*. Archbishop O'Scanlain, who did much in the building of the cathedral at Armagh, preferred to live at Drogheda, and there he was buried in 1270. Near Drogheda in later times was the primates' castle and summer palace at Termonfeckin, some ruins of which remain. In Drogheda itself there is now not a vestige of the palace, except the name "Palace Street." It stood at the corner of the main street near St Lawrence's gate, and its grounds extended back to St Peter's church. The primates of the 15th century were

buried in or near Drogheda. After the Reformation five in succession lived in Drogheda and there were buried, though there is now nothing to fix the spot where any of them lies. The last of these—Christopher Hampton—who was consecrated to the primacy in 1613, repaired the ruined cathedral of Armagh. He built a new and handsome palace at Drogheda, and he repaired the old disused palace at Armagh and bestowed on it a demesne of 300 acres.

DROIT (Fr. for "right," from Lat. *directus*, straight), a legal title, claim or due; a term used in English law in the phrase *droits of admiralty*, certain customary rights or perquisites formerly belonging to the lord high admiral, but now to the crown for public purposes and paid into the exchequer. These *droits* (see also **WRECK**) consisted of flotsam, jetsam, ligan, treasure, deodand, derelict, within the admiral's jurisdiction; all fines, forfeitures, ransoms, recognizances and pecuniary punishments; all sturgeons, whales, porpoises, dolphins, grampuses and such large fishes; all ships and goods of the enemy coming into any creek, road or port, by durance or mistake; all ships seized at sea, salvage, &c., with the share of prizes—such shares being afterwards called "tenths," in imitation of the French, who gave their admiral a *droit de dixième*. The *droits of admiralty* were definitely surrendered for the benefit of the public by Prince George of Denmark, when lord high admiral of England in 1702. American law does not recognize any such *droits*, and the disposition of captured property is regulated by various acts of Congress.

The term *droit* is also used in various legal connexions (for *French law*, see **FRANCE: Law**), such as the *droit of angary* (*q.v.*), the *droit d'achat* (right of pre-emption) in the case of contraband (*q.v.*), the feudal *droit de bris* (see **WRECK**), the *droit de régale* or ancient royal privilege of claiming the revenues and patronage of a vacant bishopric, and the feudal *droits of seignory* generally.

DROITWICH, a market town and municipal borough in the Droitwich parliamentary division of Worcestershire, England, 5½ m. N.N.E. of Worcester, and 126 m. N.W. by W. from London by the Great Western railway. Pop. (1901) 4201. It is served by the Bristol-Birmingham line of the Midland railway, and by the Worcester-Shrewsbury line of the Great Western. It stands on the river Salwarpe, an eastern tributary of the Severn. There is connexion with the Severn by canal. There are three parish churches, St Andrew, St Peter and St Michael, of which the two first are fine old buildings in mixed styles, while St Michael's is modern. The principal occupation is the manufacture of the salt obtained from the brine springs or *weyches*, to which the town probably owes both its name and its origin. The springs also give Droitwich a considerable reputation as a health resort. There are Royal Brine baths, supplied with water of extreme saltness, St Andrew's baths, and a private bath hospital. The water is used in cases of gout, rheumatism and kindred diseases. Owing to the pumping of the brine for the salt-works there is a continual subsidence of the ground, detrimental to the buildings, and new houses are mostly built in the suburbs. In the pleasant well-wooded district surrounding Droitwich the most noteworthy points are Hindlip Hall, 3 m. S., where (in a former mansion) some of the conspirators in the Gunpowder Plot defied search for eight days (1605); and Westwood, a fine hall of Elizabethan and Carolean date on the site of a Benedictine nunnery, a mile west of Droitwich, which offered a retreat to many Royalist cavaliers and churchmen during the Commonwealth. Droitwich is governed by a mayor, 4 aldermen and 12 councillors. Arc. 1856 acres.

A Roman villa, with various relics, has been discovered here, but it is doubtful how far the Romans made use of the brine springs. Droitwich (*Wic, Salluric, Wich*) probably owed its origin to the springs, which are mentioned in several charters before the Conquest. At the time of the Domesday Survey all the salt springs belonged to the king, who received from them a yearly farm of £65, but the manor was divided between several churches and tenants-in-chief. The burgesses of Droitwich are mentioned in the Domesday Survey, but they probably only had certain franchises in connexion with the salt trade. The

town is first called a borough in the pipe roll of a Henry II., when an aid of 20s. was paid, but the burgesses did not receive their first charter until 1215, when King John granted them freedom from toll throughout the kingdom and the privilege of holding the town at a fee-farm of £100. The burgesses appear to have had much difficulty in paying this large farm; in 1227 the king pardoned twenty-eight marks of the thirty-two due as tallage, while in 1237 they were £23 in arrears for the farm. They continued, however, to pay the farm until the payment gradually lapsed in the 18th century. In medieval times Droitwich was governed by two bailiffs and twelve jurors, the former being elected every year by the burgesses; Queen Mary granted the incorporation charter in 1554 under the name of the bailiffs and burgesses. James I. in 1625 granted another and fuller charter, which remained the governing charter until the Municipal Reform Act. King John's charter granted the burgesses a fair on the feast of St. Andrew and Nicholas lasting for eight days, but Edward III. in 1330 granted instead two fairs on the vigil and day of St. Thomas the Martyr and the vigil and day of St. Simon and Jude. Queen Mary granted three new fairs, and James I. changed the market day from Monday to Friday.

DRÔME, a department in the south-east of France, formed of parts of Dauphiné and Provence, and bounded W. by the Rhone, which separates it from Ardèche, N. and N.E. by Isère, E. by Hautes-Alpes, S.E. by Basses-Alpes, and S. by Vaucluse; area 2533 sq. m.; pop. (1906) 297,270. Drôme is traversed from east to west by numerous rivers of the Rhone basin, chief among which are the Isère in the north, the Drôme in the centre and the Aygues in the south. The left bank of the Rhone is bordered by alluvial plains and low hills, but to the east of this zone the department is covered to the extent of two-thirds of its surface by spurs of the Alps, sloping down towards the west. To the north of the Drôme lie the Vercors and the Royans, a region of forest-clad ridges running uniformly north and south. South of that river the mountain system is broken, irregular and intersected everywhere by torrents. The most easterly portion of the department, where it touches the mountains of the Dévoluy, contains its culminating summit (7890 ft.). North of the Isère stretches a district of low hills terminating on the limits of the department in the Valloire, its most productive portion. The climate, except in the valleys bordering the Rhone, is cold, and winds blow incessantly. Snow is visible on the mountain-tops during the greater part of the year.

The agriculture of the department is moderately prosperous. The main crops are wheat, which is grown chiefly on the banks of the Isère and Rhone, oats and potatoes. Large flocks of sheep feed on the pastures in the south; cattle-raising is carried on principally in the north-east. Good wines, among which the famous Hermitage growth ranks first, are grown on the hills and plains near the Rhone and Drôme. Fruit culture is much practised. Olives and figs are grown in the south; the cultivation of mulberries and walnuts is more widely spread. In the rearing of silkworms Drôme ranks high in importance among French departments. The Montélimar district is noted for its truffes, which are also found elsewhere in the department. The mineral products of Drôme include lignite, blende, galena, calamine, freestone, lime, cement, potter's clay and kaolin. Brick and tile works, potteries and porcelain manufactories exist in several localities. The industries comprise flour-milling, distilling, wood-sawing, turnery and dyeing. The chief textile industry is the preparation and weaving of silk, which is carried on in a number of towns. Woollen and cotton goods are also manufactured. Leather working and boot-making, which are carried on on a large scale at Romans, are important, and the manufacture of machinery, hats, confectionery and paper employs much labour. Drôme exports fruit, oil, cheese, wine, wool, live stock and its manufactured articles; the chief import is coal. It is served by the Paris-Lyon railway, and the Rhone and Isère furnish over 100 m. of navigable waterway. The canal de la Bourne, the only one in the department, is used for purposes of irrigation only. Drôme is divided into the arrondissements

of Valence, Die, Montélimar and Nyons, comprising 29 cantons and 379 communes. The capital is Valence, which is the seat of a bishopric of the province of Avignon. The department forms part of the académie (educational division) of Grenoble, where its court of appeal is also located, and of the region of the XIV. army corps.

Besides Valence, the chief towns of the department are Die, Montélimar, Crest and Romans (q.v.). Nyons is a small industrial town with a medieval bridge and remains of ramparts. Suze-la-Rousse is dominated by a fine château with fortifications of the 12th and 14th centuries; in the interior the buildings are in the Renaissance style. At St Donat there are remains of the palace of the kings of Cisjuran Burgundy; though but little of the building is of an earlier date than the 12th century, it is the oldest example of civil architecture in France. The churches of Léoncel, St Restitut and La Garde-Adhémar, all of Romanesque architecture, are also of antiquarian interest. St Paul-Trois-Châteaux, an old Roman town, once the seat of a bishopric, has a Romanesque cathedral. At Grignan there are remains of the Renaissance château where Madame de Sévigné died. At Tain there is a sacrificial altar of A.D. 184.

DROMEDARY (from the Gr. *δρομάς*, *δρομάδος*, running, *δρομῆν*, to run), a word applied to swift riding camels of either the Arabian or the Bactrian species. (See CAMEL.)

DROMORE, a market town of Co. Down, Ireland, in the west parliamentary division, on the upper Lagan, 17½ m. S.W. of Belfast by a branch of the Great Northern railway. Pop. of urban district (1901) 2307. It is in the linen manufacturing district. The town is of high antiquity, and was the seat of a bishopric, which grew out of an abbey of Canons Regular attributed to St Colman in the 6th century, and was united in 1842 to Down and Connor. The town and cathedral were wholly destroyed during the insurrection of 1641, and the present church was built by Bishop Jeremy Taylor in 1661, who is buried here, as also is Thomas Percy, another famous bishop of the diocese, who laid out the fine grounds of the palace. Remains of a castle and earthworks are to be seen, together with a large rath or encampment known as the Great Fort. The town gives its name to a Roman Catholic diocese.

DROMOS (Gr. for running-place), in architecture, the name of the entrance passage leading down to the beehive tombs in Greece, open to the air and enclosed between stone walls.

DRONE, in music¹ (corresponding to Fr. *bourdon*; Ger. *Summer*, *Stimmer*, *Hummel*; Ital. *bordone*), the bass pipe or pipes of the bagpipe, having no lateral holes and therefore giving out the same note without intermission as long as there is wind in the bag, thus forming a continuous pedal, or drone bass. The drone consists of a jointed pipe having a cylindrical bore and usually terminating in a bell. During the middle ages bagpipes are represented in miniatures with conical drones,² and M. Praetorius³ gives a drawing of a bagpipe, which he calls *Grosser Bock*, having two drones ending in a curved ram's horn. The drone pipe has, instead of a mouthpiece, a socket fitted with a reed, and inserted into a stock or short pipe immovably fixed in an aperture of the bag. The reed is of the kind known as beating reed or *squeaker*, prepared by making a cut in the direction of the circumference of the pipe and splitting back the reed from the cut towards a joint or knot, thus leaving a flap or tongue which vibrates or beats, alternately opening and closing the aperture. The sound is produced by the stream of air forced from the bag by the pressure of the performer's arm causing the reed tongue to vibrate over the aperture, thus setting the whole column of air in vibration. Like all cylindrical pipes with reed mouthpiece, the drone pipe has the acoustic properties of the closed pipe and produces a note of the same pitch as that of an open pipe twice its length. The conical drones mentioned above

¹ For the "drone," the male of the honey bee, see *BEES*. The musical sense, both for the noise made and for the instrument, comes from the buzzing of the bee.

² British Museum, Add. MS. 12,228 (Italian work), *Roman du Roy Meliadus*, 14th century, fol. 221 b., and Add. MS. 18,851, end 15th century (Spanish work illustrated by Flemish artists), fol. 13.

³ *Synlogia musicum. Theatrum instrumentorum*, pl. xi. No. 6.

would, therefore, speak an octave higher than a cylindrical drone of the same length. The drones are tuned by means of sliding tubes at the joints.

The drones of the old French *cornemuse* played in concert with the *hautbois de Poitou* (see BAGPIPE), and differing from the shepherd's *cornemuse* or *chalmie*, formed an exception to this method of construction, being furnished with double reeds like that of the oboe. The drones of the musette and of the union pipes of Ireland are also constructed on an altogether different plan. Instead of having long cumbersome pipes, pointing over the shoulder, the musette drones consist of a short barrel containing lengths of tubing necessary for four or five drones, reduced to the most compact form and resembling the rackett (*q.v.*). The narrow bores are pierced longitudinally through the thickness of the barrel in parallel channels communicating with each other in twos or threes—and so arranged as to provide the requisite length for each drone. The reeds are double reeds all set in the wooden stock within the bag. By means of regulating slides (called in English *regulators* and in French *layettes*), which may be pushed up and down in longitudinal grooves round the circumference of the barrel, the length of each drone tube can be so regulated that a simple harmonic bass consisting of the common chord is obtainable. In the union pipes the drones are separate pipes having keys played by the elbow, which correspond to the sliders in the musette drone and produce the same kind of harmonic bass. The modern Egyptian arghool consists of a kind of clarinet with a drone attached to it by means of waxed thread; in this case the beating reed of the drone is set in vibration directly by the breath of the performer, who takes both mouthpieces into his mouth, without the medium of a wind reservoir. Mersenne gave very clear descriptions of the construction of *cornemuse* and musette, with clear illustrations of the reeds and stock.¹ There are allusions in the Greek classics which point to the existence of a pipe with a drone, either of the arghool or the bagpipe type.²

(K. S.)

DRONFIELD, an urban district in the north-eastern parliamentary division of Derbyshire, England, 6 m. S. of Sheffield, on the Midland railway. Pop. (1901) 3809. It lies on the small river Drona, a tributary of the Rother, in a busy industrial district in which are numerous coal-mines, and there are iron foundries and manufactures of tools and other iron and steel goods. The church of St John the Baptist, with a lofty spire, is a good example of Decorated work, with Perpendicular additions.

DROPSY (contracted from the old word *hydropisy*, derived from the Gr. ὑδρωψ; ὕδωρ, water, and ὄψ, appearance), the name given to a collection of simple serous fluid in all or any of the cavities of the body, or in the meshes of its tissues. Dropsy of the subcutaneous connective tissue is termed *oedema* when it is localized and limited in extent; when more diffuse it is termed *anasarca*; the term *oedema* is also applied to dropsies of some of the internal organs, notably to that of the lungs. *Hydrocephalus* signifies an accumulation of fluid within the ventricles of the brain or in the arachnoid cavity; *hydrothorax*, a collection of fluid in one or both pleural cavities; *hydropericardium*, in the pericardium; *ascites*, in the peritoneum; and, when *anasarca* is conjoined with the accumulation of fluid in one or more of the serous cavities, the dropsy is said to be general (see also **PATHOLOGY**).

Dropsy (excluding "epidemic dropsy," for which see below) is essentially a symptom and not a specific disease, and is merely an exaggeration of a certain state of health. Fluid, known as lymph, is continually passing through the capillary walls into the tissues, and in health this is removed as fast as it is exuded, in one or more of three ways: part of it is used in the nutrition

¹ *L'Harmonie universelle* (Paris, 1636-1637), t. ii. bk. 5, pp. 282-287 and p. 305.

² Plato, *Cratylus*, 54; Aristophanes, *Acharnians*, 865, where some musicians are in derision dubbed "bumblebee pipers." See BAGPIPE; also Kathleen Schlesinger, "Researches into the Origin of the Organs of the Ancients," *Intern. Mus. Ges.* vol. ii. (1901), *Sammelband* ii. pp. 188-202.

of the tissues, part is returned to the general circulation by the veins, and part by the lymphatics. Any accumulation constitutes dropsy and is a sign of disease, though not a disease in itself. The serous effusions due to inflammation are not included under the term dropsy. A dropical fluid varies considerably in composition according to its position in the body, but varies only slightly according to the disease which has given rise to it. Its specific gravity ranges between 1008 and 1018; the mineral salts present are the same and in about the same proportion as those of blood, nor do they vary with the position of the exudation. The quantity of albumin, however, depends much on the position of the fluid, and slightly on the underlying disease. In oedema the fluid contains only traces, whereas a pleural or peritoneal effusion is always highly albuminous. Also an effusion due to heart disease contains more albumin than one due to kidney disease. In appearance it may be colourless, greenish or reddish from the presence of blood pigment, or yellowish from the presence of bile pigment; transparent or opalescent or milky from the presence of fatty matter derived from the chyle. The membrane from which the dropical fluid escapes is healthy, or at least not inflamed, and only somewhat sodden by long contact with the fluid—the morbid condition on which the transudation depends lying elsewhere.

The simplest cause of dropsy is purely mechanical, blood pressure being raised beyond a certain point owing to venous obstruction. This may be due to thrombosis of a vein as in phlegmasia dolens (white leg), retardation of venous circulation as in varicose veins, or obstruction of a vein due to the pressure of an aneurism or tumour. Cardiac and renal dropsy are more complicated in origin, but cardiac dropsy is probably due to diminished absorption, and renal dropsy, when unassociated with heart failure, to increased exudation. But the starting point of acute renal dropsy, of the dropsy sometimes occurring in diabetes, and that of chlorosis is the toxic condition of the blood. For accounts of the various local dropsies see **HYDROCEPHALUS**; **ASCITES**; **LIVER**, &c.; general dropsy, or dropsy which depends on causes acting on the system at large, is due chiefly to diseases of the heart, kidneys or lungs, occasionally on lardaceous disease, more rarely still on diabetes or one of the anaemias.

Broadly speaking, 50% of cases of general dropsy are due to disease of the heart or aorta, and 25% to renal troubles. The natural tendency of all diseases of the heart is to transfer the blood pressure from the arteries to the veins, and, so soon as this has reached a sufficient degree, dropsy in the form of local *oedema* commences to appear at whatever may be the most depending part of the body—the instep and ankle in the upright position, the lower part of the back or the lungs if the patient be in bed—and this tends gradually to increase till all the cavities of the body are invaded by the serous accumulation. The diseases of the lungs which produce dropsy are those which obstruct the passage of the blood through them, such as emphysema and fibrosis, and thus act precisely like disease of the heart in transferring the blood pressure from the arteries to the veins, inducing dropsy in exactly a similar manner. The dropsy of renal disease is dependent for the most part on an excess of exudation, due largely to an increase of arterial and cardiac tension. This in its turn produces arterial thickening and cardiac hypertrophy, which, if the case be sufficiently prolonged, brings about a natural removal of the fluid. In kidney cases, in the absence of cardiac disease, the dropsy will be found to appear first about the loose cellular tissue surrounding the eyes, where the vessels, turgid with watery blood, have less efficient support. The dropsy of chlorosis is very similar to renal dropsy, a toxic condition of blood being present in both; also other forms of anaemia, as also hydraemia, tend to produce or assist in the production of dropical effusions.

For the treatment of dropsy the reader is referred to the articles on the several diseases of which it is a symptom. Briefly, however, tapping of the abdomen or puncture of the legs are constantly resorted to in severe cases. Dehydration by diet is very valuable under certain circumstances when the dropsy

is other than renal. And there is the routine treatment by drugs, purgative, diaphoretic and diuretic as the symptoms of the case may demand.

It may be well to mention that there are certain affections which may be termed *spurious dropsies*, such as *ovarian dropsy*, which is only a cystic disease of the ovary; *hydrometria*, dropsy of the uterus, due to inflammatory occlusion of the os uteri; *hydromephrasis*, dropsy of the kidney, due to obstruction of the ureter, and subsequent distension of these organs by serous accumulations; other hollow organs may also be similarly affected.

Having no known relation to the preceding is *epidemic dropsy*, the first recorded outbreak of which occurred in Calcutta in the year 1877. It disappeared during the hot weather of the following year, only to recur over a wider area in the cold months of 1878 to 1879, and once again in the cold of 1879 to 1880. Since then only isolated cases have been recorded in the immediate neighbourhood of Calcutta, though epidemics have broken out in other places both by land and sea. At the end of 1902 an outbreak occurred in the Barisal gaol, Bengal, in which nearly one-third of the cases ended fatally. Dropsy was an invariable feature of the disease, and was either the first symptom or occurred early. The lower limbs were first affected, trunk and upper limbs later in severe cases, the face very rarely. It was accompanied by pyrexia, gastro-enteritis, deep-seated pains in limbs and body, and burning and pricking of the skin. Various rashes appeared early in the attack, while eczema, desquamation and even ulceration supervened later. Anæmia was very marked, giving rise in Mauritius to the name of acute anæmic dropsy. The duration of the disease was very variable, the limits being three weeks and three months. Death was often sudden, resulting chiefly from cardiac and respiratory complications. The cause of the disease has remained obscure, but there is reason to suppose that it was originally imported from the Madras famine tracts.

DROPWORT, in botany, the common name for a species of *Spiræa*, *S. filipendula* (nat. ord. *Rosaceæ*), found in dry pastures. It is a perennial herb, with much divided radical leaves and an erect stem 2 to 3 ft. high bearing a loose terminal inflorescence of small white flowers, closely resembling those of the nearly allied species *S. Ulmaria*, or meadowsweet.

Water Dropwort, *Oenanthe crocata* (nat. ord. *Umbelliferae*), is a tall herbaceous plant growing in marshes and ditches. The stem, which springs from a cluster of thickened roots, is stout, branched, hollow and 2 to 5 ft. high; the leaves are large and pinnately divided, and the flowers are borne in a compound umbel, the long rays bearing dense partial umbels of small white flowers. The plant, which is very poisonous, is often mistaken for celery.

DROSHKY (Russ. *droszki*, diminutive of *drogi*, a wagon), a light four-wheeled uncovered carriage used in Russia. Properly it consists of two pairs of wheels joined by a board. This forms a seat for the passengers who sit sideways, while the driver sits astride in front. The word *Droschke*, however, is applied especially in Germany to light carriages generally which ply for hire.

DROSTE-HÜLSHOFF, ANNETTE ELISABETH, FREIH VON (1797-1848), German poet, was born at the family seat of Hülshoff near Münster in Westphalia on the 10th of January 1797. Her early mental training was largely influenced by her cousin, Clemens August, Freiherr von Droste zu Vischering, who, as archbishop of Cologne, became notorious for his extreme ultramontane views (see below); and she received a more liberal education than in those days ordinarily fell to a woman's lot. After prolonged visits among the intellectual circles at Coblenz, Bonn and Cologne, she retired to the estate of Ruschhaus near Münster, belonging to her mother's family. In 1841, owing to delicate health, she went to reside in the house of her brother-in-law, the well-known scholar, Joseph, Freiherr von Lassberg (1770-1855), at Schloss Meersburg on the Lake of Constance, where she met Levin Schücking (q.v.); and there she died on the 24th of May 1848. Annette von Droste-Hülshoff

is, beyond doubt, the most gifted and original of German women poets. Her verse is strong and vigorous, but often unmusical even to harshness; one looks in vain for a touch of sentimentality or melting sweetness in it. As a lyric poet, she is at her best when she is able to attune her thoughts to the sober landscape of the Westphalian moorlands of her home. Her narrative poetry, and especially *Das Hospiz auf dem Grassen St Bernard* and *Die Schlacht im Loemer Bruch* (both 1838), belongs to the best German poetry of its kind. She was a strict Roman Catholic, and her religious poems, published in 1852, after her death, under the title *Das geistliche Jahr, nebst einem Anhang religiöser Gedichte*, enjoyed great popularity.

Annette von Droste-Hülshoff's *Gedichte* were first published in 1844 during her lifetime, and a number of her poems were translated into English by Thomas Medwin. The most complete edition of her works is that in 4 vols. edited by E. von Droste-Hülshoff (Münster, 1886). The *Ausgewählte Gedichte* were edited by W. von Scholz (Leipzig, 1901). See Levin Schücking, *Annette von Droste-Hülshoff, ein Lebensbild* (2nd ed., Hanover, 1871)—her letters to L. Schücking were published at Leipzig in 1893; also H. Huefner, *Annette von Droste-Hülshoff und ihre Werke* (Gotha, 1887), and W. Kreiten, *Annette von Droste-Hülshoff* (2nd ed., Paderborn, 1900).

DROSTE-VISCHERING, CLEMENS AUGUST, BARON VON (1773-1845), German Roman Catholic divine, was born at Münster on the 21st of January 1773. He was educated in his native town and entered the priesthood in 1798; in 1807 the local chapter elected him vicar-general. This office he resigned in 1813 through his opposition to Napoleon, but assumed it again after the battle of Waterloo (1815) until a disagreement with the Prussian government in 1820 led to his abdication. He remained in private life until 1835, when he was appointed archbishop of Cologne. Here again his zeal for the supremacy of the church led him to break the agreement between the state and the Catholic bishops which he had signed at his installation, and he was arrested by the Prussian government in November 1837. A battle of pamphlets raged for some time; Droste was not re-installed but was obliged to accept a coadjutor. His chief works were: *Über die Religionsfreiheit der Katholiken* (1817), and *Über den Frieden unter der Kirche und den Staaten* (1843).

See Carl Mirbt's article in *Herzog-Hauck, Realencyk. für prot. Theol.* v. 23.

DROUAI, JEAN GERMAIN (1763-1788), French historical painter, was born at Paris on the 25th of November 1763. His father, François Hubert Drouais, and his grandfather, Hubert Drouais, were well-known portrait painters; and it was from his father that he received his first artistic instruction. He was afterwards entrusted to the care of Brent, an excellent teacher, though his own pictures did not take high rank. In 1780 David, who had just returned from Rome, opened a school of painting in Paris, and Drouais was one of his earliest and most promising pupils. He adopted the classical style of his master, and gave his whole time to study—painting during the day, and spending a great part of every night in designing. For weeks together it is said that he never left his studio. In 1783 he was admitted to compete for the great prize of painting offered by the Academy, the subject being the "Widow of Nain." After inspecting the works of his fellow-competitors, however, he lost hope and destroyed his own canvas, but was consoled by the assurance of his master David that had he not done so he would have won the prize. Next year he was triumphantly successful, the "Woman of Canaan at the Feet of Christ," with which he gained the prize, being compared by competent critics with the works of Poussin. He was carried shoulder high by his fellow-students through the streets to his mother's house, and a place was afterwards found for his picture in the Louvre. His success making him only the more eager to perfect himself in his art, he accompanied David to Rome, where he worked even more assiduously than in Paris. He was most strongly influenced by the remains of ancient art and by the works of Raphael. Goethe, who was at Rome at the time it was finished, has recorded the deep impression made by his "Marius at Minturno," which he characterizes as in some respects superior to the work of David, his master. The last picture which he completed was his "Philoctetus on the

Island of Lemnos." He died on the 15th of July 1788. A monument to his memory was erected by his fellow-students in the church of Santa Maria in the Via Lata.

DROUET, JEAN BAPTISTE (1763-1824), French Revolutionist, chiefly noted for the part he played in the arrest of Louis XVI. at Varennes, was born at Sainte-Menehould. He served for seven years in the army, and afterwards assisted his father, who was post-master of his native town. The carriages conveying the royal family on their flight to the frontier stopped at his door on the evening of the 21st of June 1791; and the passengers, travelling under assumed names, were recognized by Drouet, who immediately took steps which led to their arrest and detection on reaching Varennes. For this service the Assembly awarded him 30,000 francs, but he appears to have declined the reward. In September 1792 he was elected deputy to the Convention, and took his place with the most violent party. He voted the death of the king without appeal, showed implacable hostility to the Girondins, and proposed the slaughter of all English residents in France. Sent as commissioner to the army of the north, he was captured at the siege of Maubeuge and imprisoned at Spielberg till the close of 1795. He then became a member of the Council of Five Hundred, and was named secretary. Drouet was implicated in the conspiracy of Babeuf, and was imprisoned; but he made his escape into Switzerland, and thence to Teneriffe. There he took part in the successful resistance to the attempt of Nelson on the island, in 1797, and later visited India. The first empire found in him a docile sub-prefect of Sainte-Menehould. After the second Restoration he was compelled to quit France. Returning secretly he settled at Macon, under the name of Merger and a guise of piety, and preserved his incognito till his death on the 11th of April 1824.

See G. Lenotre, *Le Drame de Varennes* (Paris, 1905).

DROWNING AND LIFE SAVING. To "drown" (a verb used both transitively and intransitively, of which the origin, though traced to earlier forms, is unknown) is to suffer or inflict death by submersion in water, or figuratively to submerge entirely in water or some other liquid. As a form of ancient capital punishment, the method of drowning is referred to at the end of this article, but the interest of the subject is mainly associated with rescue-work in cases of accident.

Death from drowning is the result of asphyxia, due to the stoppage of a supply of fresh air to the lungs. There is a certain amount of stationary air in the lungs, and into this is diffused oxygen from the fresh air taken in, while the carbonic acid which it has taken from the blood through the walls of the capillaries is driven out. This process of exchange is ever proceeding, the whole of it being regulated from the nervous centre at the base of the brain. When a person gets under water and cannot swim, there is a natural tendency to struggle, and in the efforts to respire water is drawn into the windpipe and cough is brought on. This expels the air from the lungs with the water which threatened to suffocate him, and as further efforts are made to respire more water is taken in and has to be swallowed. Meanwhile, the oxygen in the lungs is gradually diminishing, the quantity of carbonic acid is increasing, and at length the air in the lungs becomes too impure to effect an exchange with the blood. Then the blood passing into the heart becomes venous and the heart begins to send out venous instead of arterial blood to all parts of the body. Immediately a dull, sickening pain becomes apparent at the base of the neck, and insensibility rapidly ensues. This arises from the affection of the respiratory nerve centre. In a short space of time the face becomes dark and congested through the veins being gorged with blood, and the heart ultimately ceases to beat.

When a person unable to swim falls into the water, he usually rises to the surface, throws up his arms and calls for help. This, with the water swallowed, will make him sink, and if the arms are moved above the head when under water, he will, as a natural consequence, sink still lower. The struggle will be prolonged a few seconds, and then probably cease for a time, allowing him to rise again, though perhaps not sufficiently high to enable him

to get another breath of air. If still conscious, he will renew his struggle, more feebly perhaps, but with the same result. As soon as insensibility occurs, the body sinks altogether, owing to the loss of air and the filling of the stomach with water. There is a general belief that a drowning person must rise three times before he finally sinks, but this is a fallacy. The question whether he rises at all, or how often he does so, entirely depends upon circumstances. A man may get entangled among weeds, which prevent his coming to the surface, or he may die through heart failure from the shock or fright of entering the water.

On seeing a person struggling in the water in danger of drowning, no time should be lost in going to his assistance, for he may sink at once, and then there is danger of missing the body when searching under water for it, or it may get entangled among weeds and then the rescuer's task is rendered doubly dangerous. Before diving in to the rescue the boots and heavy clothing should be discarded if possible, and in cases where a leap has to be made from a height, such as a bridge, high embankment, vessel or pier, or where the depth of the water is not known, it is best to drop in feet first. Where weeds abound there is always danger of entanglement, and therefore progress should be made in the direction of the stream. When approaching a drowning man there is always the danger of being clutched, but a swimmer who knows the right way to deal with a man in the water can easily avoid this; but if through some mistake he finds himself seized by the drowning person, a necessary thing for the swimmer to do is to take advantage of his knowledge of the water and keep uppermost, as this weakens the drowning person and makes the effort of effecting a release much easier than would otherwise be the case. To the Royal Life Saving Society in England is due the credit of disseminating, throughout the entire world, the ideas of swimmers, based on practical experience, as to the safest methods which should be adopted for release and rescue, and their methods, as well as the approved ones for resuscitation, are now taught in almost every school and college.

If the rescuer be held by the wrists, he must turn both arms simultaneously against the drowning person's thumbs, and bring his arms at right angles to the body, thus dislocating the thumbs of the drowning person if he does not leave go (fig. 1)

If he be clutched round the neck he must take a deep breath and lean well over the drowning person, at the same time placing one hand in the small of his back, then raise the other arm in line with the shoulder, and pass it over the drowning person's arm, then pinch the nostrils close with the fingers, and at the same time place the palm of the hand on the chin and push away with all possible force. By the firm holding of the nose the drowning person is made to open his mouth for breathing, and as he will then be under water, choking ensues and he gives way to the rescuer, who then gains complete control (fig. 2). One of



FIG. 1.—1st Release Method.



FIG. 2.—2nd Release Method.

the most dangerous clutches is that round the body and arms or round the body only. When so tackled the rescuer should lean well over the drowning person, take a breath as before, and either withdraw both arms in an upward direction in front of his body, or else act in the same way as when releasing oneself



FIG. 3.—3rd Release Method.

when clutched round the neck. In any case one hand must be placed on the drowning man's shoulder, and the palm of the other hand against his chin, and at the same time one knee should be brought up against the lower part of his chest. Then, with a strong and sudden push, the arms and legs should be stretched out straight and the whole weight of the body thrown backwards. This sudden and totally unexpected action will break the clutch and leave the rescuer free to get hold of the drowning person in such a manner as to be able to bring him to land (fig. 3).

There are several practical methods of carrying a person through the water, the easiest assistance to render being that to a swimmer attacked by cramp or exhaustion, or a drowning person who may be obedient and remain quiet when approached and assured of safety. Then the person assisted should place his arms on the rescuer's shoulders, close to the neck, with the arms at full stretch, lie on his back perfectly still, with the head well back. The rescuer will then be uppermost, and having his arms and legs free can, with the breast stroke, make rapid progress to the shore; indeed a good pace can easily be made (fig. 4). In this, as in the other methods afterwards described, every care should be taken to keep the face of the drowning person above the water. All jerking, struggling or tugging should be avoided, and the stroke of the legs be regular and well timed, thus husbanding strength for further effort. The drowning person being able to breathe with freedom is reassured, and is likely to cease struggling, feeling that he is in safe hands.



FIG. 4.—Easiest method of carrying a person not struggling.

When a drowning person is not struggling, but yet seems likely to do so when approached, the best method of rescue is to swim straight up, turn him on his back, and then place the



FIG. 5.—1st Rescue Method.

hands on either side of his face. Then the rescuer should lie on his back, holding the drowning man in front of him, and swim with the back stroke, always taking care to keep the man's face above water (fig. 5). If the man be struggling and in a condition difficult to manage, he should be turned on his back as before, and a firm hold taken of his arms just above his elbows. Then

the man's arms should be drawn up at right angles to his body and the rescuer should start swimming with the back stroke (fig. 6). He should take particular care not to go against the current or stream, and thereby avoid exhaustion. If the arms be difficult to grasp, or the struggling so violent as to prevent a firm hold, the rescuer should slip his hands under the armpits



FIG. 6.—2nd Rescue Method.

of the drowning person, and place them on his chest or round his arms, then raise them at right angles to his body, thus placing the drowning person completely in his power. The journey to land can then be made by swimming on the back as in the other methods (fig. 7). In carrying a person through the water, it will be of much advantage to keep his elbows well out from the sides, as this expands the chest, inflates the lungs and adds to his buoyancy. The legs should be kept well up to the surface and the whole body as horizontal as possible. This avoids a drag through the water, and will considerably help the rescuer. In some cases it may happen that the drowning person has sunk to the bottom and does not rise again. In that event the rescuer should look for bubbles rising to the surface before diving in. In still water the bubbles rise perpendicularly; in running water they rise obliquely, so that the rescuer must look for his object higher up the stream than where the bubbles rise. It is also well to remember that in running water a body may be carried along by the current and must be looked for in the direction in which it flows. When a drowning person is recovered on the bottom, the rescuer should seize him by the head or shoulders, place the left foot on the ground and the right knee in the small of his back, and then, with a vigorous push, come to the surface.

When the rescuer reaches land with an insensible person, no time should be lost in sending for a medical man, but in the meantime an attempt to induce artificial respiration may be made. The first recorded cases of resuscitating the apparently drowned are mentioned in the notes to William Derham's *Physico-Theology*, as having occurred at Troningsholm and Oxford, about 1650. In 1745 Dr J. Fothergill read a paper on the subject before the Royal Society. It dealt with the recovery of a man dead in appearance by distending the lungs by Mr William Tossack, surgeon in Allos, in 1744. In 1767 several cases of resuscitation were reported in Switzerland, and shortly after a society was formed at Amsterdam for recovery of the apparently drowned, and to instruct the common people as to the best manner of treating them when rescued, and to reward the people for their services. In 1773 Dr A. Johnson suggested the formation of a similar society in England, and Dr Thomas Cogan translated the memoirs of the Amsterdam society. Dr William Hawes secured a copy and tried to form a society. There was, however, a strong prejudice against the idea, but he publicly offered rewards to persons who, between Westminster and London Bridges, should rescue drowning persons and bring them to certain places on shore in order that resuscitation might be attempted. In this way he was instrumental in the saving of several lives, and paid the rewards out of his own pocket, until his zeal brought him sympathy and the Royal Humane Society was founded. This was in 1774. The system then in vogue was a means of inducing artificial respiration by inserting the pipe



FIG. 7.—3rd Rescue Method.

of a pair of bellows into one nostril and closing the other. Air was forced into the lungs and then expelled by pressing the chest, thus imitating respiration. Dr Hawes used for his resuscitation work a kind of cradle, in which the subject was placed, and then raised over a furnace. Bleeding, holding up by the heels, rolling on casks, &c. were at various times resorted to. Simple means are often as effective as the official ones. In 1891 a subject was restored in Australia by being held over a smoky fire, which is the native method of restoring life; while a few years back, at an English riverside town, a patient was saved by the placing of a handkerchief over his mouth and the alternate blowing into and drawing air out of the lungs until natural breathing was restored.

One of the oldest methods of resuscitation was that of Dr Marshall Hall (1790-1857), introduced in 1856. In this method the operator takes his place at the patient's left side, and places a roll of clothing or pillow (which must be the same length as that used in the previous methods), so that it may be in position under the chest when the patient is turned over. The assistant at the head pays particular attention to the patient's arms, that they may not be laid upon or twisted at the wrists, elbows, hands or shoulders. The patient is then turned face downwards, with the body reclining over the pillow, the operator makes a firm pressure with the hand upon the back, between and on the shoulder blades, he then pulls the patient slowly up on to the side towards himself. Once in position, the operator pushes the patient back again until the face is downward, when the pressure on the back is to be repeated. These three movements must be continued at the rate of about fifteen times a minute, until natural breathing has been restored.

Then came the methods of Dr H. R. Silvester and Dr Benjamin Howard, of New York.

When using the Silvester method, or, for the matter of that, any other method, the first thing to do is to send for medical assistance. Dr Silvester recommended that the patient should not be carried face downwards or held up by his feet. All rough usage should be avoided, especially twisting or bending of limbs, and the patient must not be allowed to remain on the back unless the tongue is pulled forward. In the event of respiration not being entirely suspended when a person is lifted out of the water, it may not be necessary to imitate breathing, but natural respiration may be assisted by the application of an irritant substance to the nostrils and tickling the nose. Smelling-salts, pepper and snuff may be used, or hot and cold water alternately dashed on the face or chest. Provided no sign of life can be seen or felt or the heart's action heard, promotion of breathing, *not* circulation must be the first aim and effort. Lay the patient flat on his back, with the head at a slightly higher level than the feet. Remove all tight clothing about the neck, chest and abdomen, and loosen the braces, belts or corsets. The operator taking his place at the head, with an assistant on one side, will turn the patient over until he is lying face downwards, his head resting upon one arm. He should then, after the assistant has given one or two sharp blows with the open hand between the shoulder blades, wipe and clear the mouth, throat and nostrils of all matter that may prevent the air from entering the lungs, using a handkerchief for this purpose. This being done, the patient should be turned upon his back, the tongue pulled forward and kept in position by means of a dry cloth, handkerchief or piece of string tied round the jaw. Every care must be taken not to let it fall back into the mouth and thus obstruct the air passages. When this work has been accomplished (it should only last a few seconds) the operator at the head should lift the patient, handling the head and shoulders very carefully, in order that the assistant may place a roll of clothing or pillow under the shoulder blades. The roll being placed in position, the operator will lean forward and grasp the arms below the elbows. He will then draw the patient's arms steadily upwards and outwards, above the head, until fully extended in line with the body. Having held the arms in this position for about one second, the operator will carry them back again and press them firmly against the side and front of the chest for another second. By these means an exchange of

air is produced in the lungs similar to that effected by natural respiration. These movements must be repeated carefully and deliberately about fifteen times a minute, and persevered in. When natural respiration is once established, the operator should cease to imitate the movements of breathing, and proceed with the treatment for the *promotion of warmth and circulation*.

Friction over the surface of the body must be at once resorted to, using handkerchiefs, flannels, &c., so as to propel the blood along the veins towards the heart, while the operator attends to the mouth, nose and throat. The friction along the legs, arms and body should all be towards the heart and should be continued after the patient has been wrapped in blankets or some dry clothing. As soon as possible, the patient should be removed to the nearest house and further efforts made to promote warmth by the application of hot flannels to the pit of the stomach, and bottles or bladders of hot water, heated bricks, &c. to the armpits, between the thighs and to the soles of the feet. If there be pain or difficulty in breathing, apply a hot linseed meal poultice to the chest. On the restoration of life, a teaspoonful of warm water should be given; and then, if the power of swallowing has returned, very small quantities of wine, warm brandy and water, beef tea or coffee administered, the patient kept in bed, and a disposition to sleep encouraged. The patient should be carefully watched for some time to see that breathing does not fail, and, should any signs of failure appear, artificial respiration should at once be resumed. While the patient is in the house, care should be taken to let the air circulate freely about the room and all overcrowding should be prevented.

In the Howard method there are only two movements; its knowledge is said to be necessary in case the patient's arm be in any way injured, or a more vigorous method than the "Silvester" deemed necessary, *but care should be exercised not to injure the patient by too forcible pressure*. The patient is laid on his back, the roll is larger than that used in the Silvester method, and is placed farther under the back in order that the lower part of the chest may be highest. After adjusting the roll, the operator kneels astride of the patient, while his assistant goes to the head, lifts the patient's arms beyond the head, and holds them to the ground, cleans the mouth and nose, and attends to the tongue. The operator, with his fingers spread well apart, taking care that the thumbs do not press into the pit of the stomach, grasps the most compressible part of the lower ribs, and with both hands applies pressure firmly by leaning over the patient; then he springs back, lifting his hands off the patient. Artificial respiration is thus effected, and continued at the rate of about fifteen times a minute. When natural breathing has been restored, the treatment is the same as in the Silvester method.

These methods have now been superseded by the Schäfer method, which has been taken up by the Royal Life Saving Society, a body instituted in 1891 for the promotion of technical education in life saving and resuscitation of the apparently drowned. The Schäfer method has much to recommend it, owing to its extreme simplicity and the ease with which the physical operations necessary to carry on artificial respiration may be performed, hardly any muscular exertion being required. It involves no risk of injury to the congested liver or to any other organ, and as the patient is laid face downwards, there is no possibility of the air passages being blocked by the falling back of the tongue into the pharynx. The water and mucus can also be expelled much more rapidly from the air passages through the mouth and nostrils.

It was due to the happy selection of Professor E. A. Schäfer, as chairman of a committee appointed by the Royal Medical & Chirurgical Society for the investigation of the methods in use for resuscitation of the apparently drowned, that the new method was devised. This committee made many experiments upon the cadaver but failed to arrive at any definite conclusion by that means. The necessity then appeared of thorough investigation of the subject by experiments upon animals, so that the phenomena attendant upon drowning might be better known, and the various methods of resuscitation properly tried. These experiments were made in Edinburgh by Professor

Schäfer, with the co-operation of Dr P. T. Herring, and the results obtained were embodied in the report of the committee, which was presented to the Royal Medical and Chirurgical Society in 1904, and published as a supplement to volume 86 of the *Transactions* of the society. As the direct outcome of these experiments, Professor Schäfer was led to believe that a pressure method of resuscitation was not only simpler to perform but also more efficacious than any other. This conclusion was put to the test by measurements of the results obtained upon the normal human subject by the various methods in vogue; from these measurements, which were published in the *Proceedings* of the Royal Society of Edinburgh in December 1903, it appeared that when such pressure is exerted in the prone position the highest degree of efficiency as well as simplicity is obtained. The description of this method was communicated to the Royal Medical and Chirurgical Society, and was published in the following year (1904) in volume 87 of the *Transactions* of the society.

Thus it came about that by investigating the phenomena of drowning, and the means of resuscitation in dogs, and by applying the results obtained to man, the method which the society now advocates as the best was arrived at. In the experiments referred to, it was found necessary to drown 38 dogs, all but two of which were from first to last in a complete state of anaesthesia, the two exceptions having been simply drowned without anaesthesia. It is important that the public should understand that the evolution of a method which will probably be the means of saving thousands of lives has resulted from the painless sacrifice of less than 40 dogs, a number which would doubtless in any case have been destroyed by drowning or some other form of suffoca-



FIG. 8.—Schäfer method of treatment of the apparently drowned. Position A.

tion, but without the benefit of the anaesthetics which were employed in the experiments.

Professor Schäfer describes the method as follows:—Lay the subject face downwards on the ground, then without stopping to remove the clothing the operator should at once place himself in position astride or at one side of the subject, facing his head and kneeling upon one or both knees. He then places his hands flat over the lower part of the back (on the lowest ribs), one on each side (fig. 8), and then gradually throws the weight of his body forward on to them so as to produce firm pressure (fig. 9) which must not be violent, or upon the patient's chest. By this means the air, and water if any, are driven out of the patient's lungs. Immediately thereafter the operator raises his body slowly so as to remove the pressure, but the hands are



FIG. 9.—Schäfer method of treatment of the apparently drowned. Position B.

left in position. This forward and backward movement is repeated every four or five seconds; in other words, the body

of the operator is swayed slowly forwards and backwards upon the arms from twelve to fifteen times a minute, and should be continued for at least half an hour, or until the natural respirations are resumed. Whilst one person is carrying out artificial respiration in this way, others may, if there be opportunity, busy themselves with applying hot flannels to the body and limbs, and hot bottles to the feet, but no attempt should be made to remove the wet clothing or to give any restoratives by the mouth until natural breathing has recommenced.

In his paper read before the Royal Society of Edinburgh in December 1903 Professor Schäfer gave the following table of the relative exchanges of air under different methods:—

Mode of Respiration.	Number per minute.	Amount of air exchanged per respiration.	Amount of air exchanged per minute.
Natural respiration (supine)	13	489 c.c.	6.460 c.c.
Natural " (prone)	12.5	422 "	5.240 "
Prone (pressure), " Schäfer "	13	520 "	6.760 "
Supine (pressure), " Howard "	13.6	295 "	4.020 "
Rolling (with pressure), " Marshall Hall "	13	254 "	3.300 "
Rolling (without pressure), " Marshall Hall "	12	192 "	2.300 "
Traction (with pressure), " Silvester "	12.8	178 "	2.280 "

These experiments all tend to show that by far the most efficient method of performing artificial respiration is that of intermittent pressure upon the lower ribs with the subject in the prone position or face downward. It is also the easiest to perform, requiring practically no exertion, as the weight of the operator's body produces the effect, and the swinging forwards and backwards of the body some thirteen times a minute, which alone is required, is by no means fatiguing, and has the further great advantage that it can be effectively carried out by one person.

See Taylor, *Medical Jurisprudence*: "Description of a simple and efficient method of performing artificial respiration in the human subject, especially in cases of drowning," by E. A. Schäfer, F.R.S. (vol. 87, *Medico-Chirurgical Society's Transactions*): "The relative efficiency of certain methods of performing artificial respiration in man," by E. A. Schäfer, F.R.S. (vol. 23, part 1, *Proceedings of the Royal Society of Edinburgh*): *A Method for the Treatment of the Apparently Drowned*, by R. S. Bowles (London, 1903); *Handbook of Instruction*, Royal Life Saving Society (London, 1908).

(W. Hy.)

Penal Use of Drowning.—As a form of capital punishment, drowning was once common throughout Europe, but it is now only practised in Mahomedan countries and the Far East. Tacitus states that the ancient Germans hanged criminals of any rank, but those of the low classes were drowned beneath hurdles in fens and bogs. The Romans also drowned convicts. The Lex Cornelia ordained that parricides should be sewn in a sack with a dog, cock, viper and ape, and thrown into the sea. The law of ancient Burgundy ordered that an unfaithful wife should be smothered in mud. The Anglo-Saxon punishment for women guilty of theft was drowning. So usual was the penalty in the middle ages that grants of life and death jurisdiction were worded to be "*cum fossa et furca*" (i.e. "with drowning-pit and gallows"). The owner of Baynard's Castle, London, in the reign of John, had powers of trying criminals, and his descendants long afterwards claimed the privileges, the most valued of which was the right of drowning in the Thames traitors taken within their jurisdiction. Drowning was the punishment ordained by Richard Cœur de Lion for any soldier of his army who killed a fellow-crusader during the passage to the Holy Land. Drowning was usually reserved for women as being the least brutal form of death-penalty, but occasionally a male criminal was so executed as a matter of favour. Thus in Scotland in 1526 a man convicted of theft and sacrilege was ordered to be drowned "by the queen's special grace." In 1611 a man was drowned at Edinburgh for stealing a lamb, and in 1623 eleven gipsy women suffered there. By that date the penalty was obsolete in England. It survived in Scotland till 1685 (the year of the drowning of the Wigtoun martyrs). The last

execution by drowning in Switzerland was in 1652, in Austria 1776, in Iceland 1777; while in France during the Revolution the penalty was revived in the terrible *Noyades* carried out by the terrorist Jean Baptiste Carrier at Nantes. It was abolished in Russia at the beginning of the 18th century.

DROYSEN, JOHANN GUSTAV (1808-1884), German historian, was born on the 6th of July 1808 at Treptow in Pomerania. His father, Johann Christoph Droysen, was an army chaplain, in which capacity he was present at the celebrated siege of Kolberg in 1806-7. As a child young Droysen witnessed some of the military operations during the War of Liberation, for his father was pastor at Greifenhagen, in the immediate neighbourhood of Stettin, which was held by the French during the greater part of 1813. The impressions of these early years laid the foundation of the ardent attachment to Prussia which distinguished him, like so many other historians of his generation. He was educated at the gymnasium of Stettin and at the university of Berlin; in 1829 he became a master at the Graue Kloster (or Grey Friars), one of the oldest schools in Berlin; besides his work there he gave lectures at the university, from 1833 as *privat-docent*, and from 1835 as professor, without a salary. During these years he was occupied with classical antiquity; he published a translation of Aeschylus and a paraphrase of Aristophanes, but the work by which he made himself known as a historian was his *Geschichte Alexanders des Grossen* (Berlin, 1833, and other editions), a book which still remains probably the best work on the subject. It was in some ways the herald of a new school of German historical thought, for it shows that idealization of power and success which he had learnt from the teaching of Hegel. It was followed by other volumes dealing with the successors of Alexander, published under the title of *Geschichte des Hellenismus* (Hamburg, 1836-1843). A new and revised edition of the whole work was published in 1885; it has been translated into French, but not into English.

In 1840 Droysen was appointed professor of history at Kiel. He was at once attracted into the political movement for the defence of the rights of the Elbe duchies, of which Kiel was the centre. Like his predecessor F. C. Dahlmann, he placed his historical learning at the service of the estates of Schleswig-Holstein and composed the address of 1844, in which the estates protested against the claim of the king of Denmark to alter the law of succession in the duchies. In 1848 he was elected a member of the Frankfort parliament, and acted as secretary to the committee for drawing up the constitution. He was a determined supporter of Prussian ascendancy, and was one of the first members to retire after the king of Prussia refused the imperial crown in 1849. During the next two years he continued to support the cause of the duchies, and in 1850, with Carl Samwer, he published a history of the dealings of Denmark with Schleswig-Holstein, *Die Herzogthümer Schleswig-Holstein und das Königreich Dänemark seit dem Jahre 1806* (Hamburg, 1850). A translation was published in London in the same year under the title *The Policy of Denmark towards the Duchies of Schleswig-Holstein*. The work was one of great political importance, and had much to do with the formation of German public opinion on the rights of the duchies in their struggle with Denmark.

After 1851 it was impossible for him to remain at Kiel, and he was appointed to a professorship at Jena; in 1859 he was called to Berlin, where he remained till his death. In his later years he was almost entirely occupied with Prussian history. In 1851 he brought out a life of Count Yorck von Wartenburg (Berlin, 1851-1852, and many later editions), one of the best biographies in the German language, and then began his great work on the *Geschichte der preussischen Politik* (Berlin, 1855-1886). Seven volumes were published, the last not till after his death. It forms a complete history of the growth of the Prussian monarchy down to the year 1756. This, like all Droysen's work, shows a strongly marked individuality, and a great power of tracing the manner in which important dynamic forces worked themselves out in history. It was this characteristic quality of comprehensiveness that also gave him so much influence as a teacher.

Droysen, who was twice married, died in Berlin on the 19th of June 1884. His eldest son, Gustav, is the author of several well-known historical works, namely, *Gustav Adolf* (Leipzig, 1860-1870); *Herzog Bernhard von Weimar* (Leipzig, 1885); an admirable *Historischer Handatlas* (Leipzig, 1885), and several writings on various events of the Thirty Years' War. Another son, Hans Droysen, is the author of some works on Greek history and antiquities.

See M. Duncker, *Johann Gustav Droysen, ein Nachruf* (Berlin, 1885); and Dahlmann-Waitz, *Quellenkunde der deutschen Geschichte* (Leipzig, 1906). (J. W. Hk.)

DROZ, ANTOINE GUSTAVE (1832-1895), French man of letters, son of the sculptor J. A. Droz (1807-1872), was born in Paris on the 9th of June 1832. He was educated as an artist, and began to exhibit in the Salon of 1857. A series of sketches dealing gaily and lightly with the intimacies of family life, published in the *Vie parisienne* and issued in book form as *Monsieur, Madame et Bébé* (1866), won for the author an immediate and great success. *Entre nous* (1867) was built on a similar plan, and was followed by some psychological novels: *Le Cahier bleu de Mlle Cibot* (1868); *Autour d'une source* (1869); *Un Paquet de lettres* (1870); *Babolein* (1872); *Les Étangs* (1875); *L'Enfant* (1885). His *Tristesses et sourires* (1884) is a delicate analysis of the niceties of family intercourse and its difficulties. Droz's first book was translated into English under the title of *Papa, Mamma and Baby* (1887). *Un Été à la campagne*, a book which caused considerable scandal, was erroneously attributed to him. He died on the 22nd of October 1895.

DROZ, FRANÇOIS-XAVIER JOSEPH (1773-1850), French writer on ethics and political science, was born on the 31st of October 1773 at Besançon, where his family had furnished men of considerable mark to the legal profession. His own legal studies led him to Paris in 1792; he arrived on the very day after the dethronement of the king, and was present during the massacres of September; on the declaration of war he joined the volunteer *bataillon* of the Doubs, and for the next three years served in the Army of the Rhine. Receiving his discharge on the score of ill-health, he obtained a much more congenial post in the newly-founded *école centrale* of Besançon; and in 1799 he made his first appearance as an author by an *Essai sur l'art oratoire* (Paris, Fructidor, An VII.), in which he acknowledges his indebtedness more especially to Hugh Blair. Removing to Paris in 1803, he became intimate not only with the like-minded Ducis, but also with the sceptical Cabanis; and it was on this philosopher's advice that, in order to catch the public ear, he produced the romance of *Lina*, which Sainte-Beuve has characterized as a mingled echo of Florian and *Werther*. Like several other literary men of the time, he obtained a post in the revenue office known as the *Droits réunis*; but from 1814 he devoted himself exclusively to literature and became a contributor to various journals. Already favourably known by his *Essai sur l'art d'être heureux* (Paris, 1806), his *Éloges de Montaigne* (1812), and his *Essai sur le beau dans les arts* (1815), he not only gained the Monthy prize in 1823 by his work *De la philosophie morale ou des différents systèmes sur la science de la vie*, but also in 1824 obtained admission to the Académie Française. The main doctrine inculcated in this last treatise is that society will never be in a proper state till men have been educated to think of their duties and not of their rights. It was followed in 1825 by *Application de la morale à la philosophie et à la politique*, and in 1829 by *Économie politique, ou principes de la science des richesses*, a methodical and clearly written treatise, which was edited by Michel Chevalier in 1854. His next and greatest work was a *Histoire du règne de Louis XVI* (3 vols., Paris, 1830-1842). As he advanced in life Droz became more and more decidedly religious, and the last work of his prolific pen was *Penées du Christianisme* (1842). Few have left so blameless a reputation: in the words of Sainte-Beuve, he was born and he remained all his life of the race of the good and the just.

See Guizot, *Discours académiques*; Montalembert, "Discours de réception," in *Mémoires de l'Académie française*; Sainte-Beuve, *Causeries du lundi*, t. iii.; Michel Chevalier, Notice prefixed to the *Économie politique*.

DRUG, a district and town of British India, in the Chhattisgarh division of the Central Provinces. The district was formed in 1906 out of portions of the districts of Bilaspur and Raipur. It has an area of 3807 sq. m., and the population on that area in 1901 was 628,885, showing a heavy decrease in the preceding decade, owing to the famines of 1897 and 1900. The district is a long narrow tract, with lofty ridges of gravel in the centre and north, but otherwise consisting of open rolling country. The Tendula and Seonath are the principal rivers. Rich black soil covers a large part of the district, and rice, wheat and other crops are grown. The main line of the Bengal-Nagpur railway passes through the district. **DRUG**, the capital of the district, is on the railway, 68½ m. from Bombay, and had in 1901 a population of 4002. Bell-metal-founding and cotton-weaving are carried on.

DRUG (from Fr. *drogue*, a word common in Romance languages, cf. Span. and Ital. *droga*; the origin of the word is obscure, but may possibly be connected with Dutch *droog*, dry), any organic and inorganic substance used in the preparation of medicines, by itself or in combination with others, and either prepared by some method or used in a natural state (see PHARMACOLOGY and PHARMACOPOEIA). In a particular sense "drug" is often used synonymously for narcotics or poisonous substances, and hence "to drug" means to stupefy or poison. The word is also applied to any article for which there is no sale, or of which the value has greatly depreciated—a "drug in the market."

DRUIDISM, the name usually given to the religious system of the ancient inhabitants of Gaul and the British Islands. The word Druid (Lat. *druida*) probably represents a Gaulish *druid-s*, Irish *drui*, gen. sing. *druid*. On the analogy of Irish *sí* < *suid-s* the word has been analysed into *druid-s*-, "very knowing, wise." The ancient Welsh form of the word does not exist. Welsh *derwydd* and *dryw* are probably to be regarded as of recent coinage, as also the Breton forms *drovius*, *dris*. The important part played by the oak in the religious cults of other countries suggests a connexion with Greek *δρῦς*, oak, but this etymology is rather in disfavour at the present time.

We find in Caesar the first and at the same time the most circumstantial account of the Druids to be met with in the classical writers. He tells us that all men of any rank and dignity in Gaul were included among the Druids or the nobles. In other words, the Druids constituted the learned and the priestly class, and they were in addition the chief expounders and guardians of the law. We are, however, informed by Diodorus and Strabo that this class was composed of Druids, bards and soothsayers. Hence Caesar seems to assign more extensive functions to the Druids than they actually possessed. The substance of Caesar's account is as follows. On those who refused to submit to their decisions they had the power of inflicting severe penalties, of which excommunication from society was the most dreaded. As they were not a hereditary caste and enjoyed exemption from service in the field as well as from payment of taxes, admission to the order was eagerly sought after by the youth of Gaul. The course of training to which a novice had to submit was protracted, extending sometimes over twenty years. All instruction was communicated orally, but for ordinary purposes they had a written language in which they used the Greek characters. The president of the order, whose office was elective and who enjoyed the dignity for life, had supreme authority among them. They taught that the soul was immortal. Astrology, geography, physical science and natural theology were their favourite studies.

Britain was the headquarters of Druidism, but once every year a general assembly of the order was held within the territories of the Carnutes in Gaul. The Gauls were accustomed to offer human sacrifices, usually criminals. Cicero remarks on the existence among the Gauls of augurs or soothsayers, known by the name of Druids, with one of whom, Divitiacus, an Aeduan, he was acquainted. Diodorus informs us that a sacrifice acceptable to the gods must be attended by a Druid, for they are the intermediaries. Before a battle they often throw themselves between two armies to bring about peace. They are said to

have had a firm belief in the immortality of the soul and in metempsychosis, a fact which led several ancient writers to conclude that they had been influenced by the teaching of the Greek philosopher Pythagoras.

A rescript of Augustus forbade Roman citizens to practise druidical rites. In Strabo we find the Druids still acting as arbiters in public and private matters, but they no longer deal with cases of murder. Under Tiberius the Druids were suppressed by a decree of the senate, but this had to be renewed by Claudius in A.D. 54. In Mela we find the Druids teaching in the depths of a forest or in caverns. In Pliny their activity is limited to the practice of medicine and sorcery. According to this writer the Druids held the mistletoe in the highest veneration. Groves of oak were their chosen retreat. Whatever grew on that tree was thought to be a gift from heaven, more especially the mistletoe. When thus found, the mistletoe was cut with a golden knife by a priest clad in a white robe, two white bulls being sacrificed on the spot. Tacitus, in describing the attack made on the island of Mona (Anglesea) by the Romans under Suetonius Paulinus, represents the legionaries as being awestruck on landing by the appearance of a band of Druids, who, with hands uplifted towards heaven, poured forth terrible imprecations on the heads of the invaders. The courage of the Romans, however, soon overcame such fears; the Britons were put to flight; and the groves of Mona, the scene of many a sacrifice and bloody rite, were cut down.

After this the continental Druids disappear entirely, and are only referred to on very rare occasions. Ausonius, for instance, apostrophizes the rhetorician Attius Patera as sprung from a race of Druids.

When we turn to the British Islands we find, as we should expect, no traces of the Druids in England and Wales after the conquest of Anglesea mentioned above, except in the story of Vortigern as recounted by Nennius. After being excommunicated by Germanus the British leader invites twelve Druids to assist him. These probably came from North Britain. In Irish literature, however, the Druids are frequently mentioned, and their functions in the island seem to correspond fairly well to those of their Gaulish brethren described by classical writers. The functions of Caesar's Druids we here find distributed amongst Druids, bards and poets (*filii*), but even in very early times the poet has usurped many of the duties of the Druid and finally supplants him with the spread of Christianity. The following is the position of the Druid in the pagan literature. The most important documents are contained in MSS. of the 12th century, but the texts themselves go back in large measure to about A.D. 700. In the heroic cycles the Druids do not appear to have formed any corporation, nor do they seem to have been exempt from military service. Cathbu (Cathbad), the Druid connected with Conchobar, king of Ulster, in the older cycle is accompanied by a number of youths (100 according to the oldest version) who are desirous of learning his art, though what this consisted in we are not told. The Druids are represented as being able to foretell the future and to perform magic. Before setting out on the great expedition against Ulster, Medb, queen of Connaught, goes to consult her Druid, and just before the famous heroine Derdriu (Deirdre) is born, Cathbu prophesies what sort of a woman she will be. We may cite two instances of the magical skill of the Druids. The hero Cuchulinn has returned from the land of the fairies after having been enticed thither by a fairy-woman named Fand, whom he is now unable to forget. He is given a potion by some Druids, which banishes all memory of his recent adventures and which also rids his wife Emer of the pangs of jealousy. More remarkable still is the story of Etain. This lady, now the wife of Eochaid Airem, high-king of Ireland, was in a former existence the beloved of the god Mider, who again seeks her love and carries her off. The king has recourse to his Druid Dalán, who requires a whole year to discover the haunt of the couple. This he accomplished by means of four wands of yew inscribed with ogham characters. The following description of the hand of Cathbu's Druids occurs in the epic tale, the *Cattle-spoiling of Cuulnge* (Cooley): "The attendants raises his

eyes towards heaven and observes the clouds and answers the band around him. They all raise their eyes towards heaven, observe the clouds, and hurl spells against the elements, so that they arouse strife amongst them and clouds of fire are driven towards the camp of the men of Ireland." We are further told that at the court of Conchobar no one had the right to speak before the Druids had spoken. In other texts the Druids are able to produce insanity.

In the religious literature they are almost exclusively represented as magicians and diviners opposing the Christian missionaries, though we find two of them acting as tutors to the daughters of Laegaire, the high-king, at the coming of St Patrick. They are represented as endeavouring to prevent the progress of St Patrick and St Columba by raising clouds and mist. Before the battle of Culdremne (561) a Druid made an *airbe druid* (fence of protection?) round one of the armies, but what is precisely meant by the phrase is obscure. The Irish Druids seem to have had a peculiar tonsure. The word *druid* is always used to render the Latin *magus*, and in one passage St Columba speaks of Christ as his *Druid*.

See D'Arbois de Jubainville, *Les Druides et les dieux celtiques à forme d'animaux* (Paris, 1906), and *Introduction à l'étude de la littérature celtique* (Paris, 1883); P. W. Joyce, *A Social History of Ancient Ireland* (London, 1903).

(E. C. Q.)
DRUIDS, ORDER OF, a friendly society founded, as an imitation of the ancient Druids, in London in 1781. They adopted Masonic rites and spread to America (1833) and Australia. Their lodges are called "Groves." In 1872 the Order was introduced into Germany. (See FRIENDLY SOCIETIES.)

DRUM (early forms *drome* or *dromme*, a word common to many Teut. languages, cf. Dan. *tromme*, Ger. *Trommel*: the word is ultimately the same as "trumpet," and is probably onomatopoeic in origin; it appears late in Eng. about the middle of the 16th century), the name given to the well-known musical instrument (see below) and also to many objects resembling it in shape. Thus it is used of any receptacle of similar shape, as a "drum" of oil, &c.; in machinery, of a revolving cylinder, round which belting is passed; of the *tympansum* or cylindrically shaped middle ear, and specially of the membrane that closes the external auditory meatus; and, in architecture, of the sub-structure of a dome when raised to some height above the pendentives. The architectural drum had a twofold object; first, to give greater elevation to the dome externally so that it should rise well above the surrounding building, and secondly, to allow of the interior being lighted with vertical windows cut in the drum, instead of forming penetrations in the dome itself, as in St Sophia, Constantinople. The term is also applied to the circular blocks of stone, which in columns of large dimensions were built with a series of drums. At Selinus in Sicily some of these great circular blocks are found on the road between the quarries and the temples; they vary from 8 to 10 ft. in diameter, being about 6 ft. high. The term *frusta* is sometimes applied to them.

In music the drum (Fr. *tambour*; Ger. *Trommel*; Ital. *tamburo*) is an instrument of percussion common in some form to all nations and ages. It consists of a frame or vessel forming a resonant cavity, over one or both ends of which is stretched a skin or vellum set in vibration by direct percussion of hand or stick. Drums fall into two divisions according to the nature of their sonority:—(1) instruments producing sounds of definite musical pitch, and qualified thereby to take part in the harmony of the orchestra, such as the kettledrum (*q.v.*); (2) instruments of indefinite sonorosity, and therefore excluded from the harmony of the orchestra; such are the bass drum, the side or snare drum, the tenor drum, the tambourine, all used for marking the rhythm and adding tone colour.

Drums are further divided into three classes according to special features of construction:—(1) instruments having a skin stretched over one end of the resonant cavity, the other being open, such as the tambourine (*q.v.*) and the *darabukkeh* or Egyptian drum, shaped like a mushroom; (2) instruments consisting of a cup-shaped receptacle of metal, wood or earthenware entirely closed by a skin or vellum stretched across the

opening, as in the kettledrum; (3) a receptacle in the shape of a cylinder closed at both ends by skins, as in the bass drum, side drum, &c.

Skin or parchment only acquires the elasticity requisite to produce vibration by tension; the vibrations of the parchment are taken up by the air enclosed in the receptacle, which thus reinforces the sound produced by the parchment. The *tone* of the instrument whether definite or indefinite depends upon the dimensions of the vellum, the shape of the resonant receptacle, and the method of percussion. The *intensity* of the sound depends upon the degree of percussive force used and the diameter of the vellum in proportion to the dimensions of the resonant receptacle; the material of which the latter consists has little or no influence on the tone of the instrument. The *pitch* of the sound is determined by the dimensions of the vellum taken in conjunction with the degree of tension, the pitch varying in acuteness directly with the degree of tension and inversely with the size of the vellum.

The *bass drum* or Turkish drum (Fr. *grosse caisse*; Ger. *Grosse Trommel*; Ital. *gran cassa* or *tamburo grande*) consists of a short cylinder of very wide diameter covered at both ends by vellum stretched over thin hoops, which in turn are kept in place

by larger hoops fitting tightly over them. At regular intervals in the two large hoops are bored holes through which passes an endless cord stretched in zig-zag round the cylinder and connecting the two hoops. The tension of the vellum is controlled by means of leather braces which are made to slide up and down the zig-zag of cord, slackening or tightening the large hoops, and with them the vellum, at the will of the performer. Systems of rods and screws are also used for the purpose. The

bass drum is mounted on a stand when used in the orchestra. The sound is produced by striking the centre of the vellum on the one end of the drum with a stick having a large soft round knob composed of wood covered with cork, sponge or felt. The bass drum cannot be tuned since it gives out no definite note, but the pitch may be varied, according as a rich full tone or a mere dull thud be required, by tightening or loosening the braces; the instrument can, moreover, be muffled by covering it with a piece of cloth. The music for the bass drum is generally written on a staff with a bass clef, , the C being merely used to show the rhythm and accents. Sometimes the staff is dispensed with, a single note on a single line being sufficient. The bass drum has a place in every orchestra, although it is used but sparingly to accentuate the rhythm. It is possible to make gradations in *forte* and *piano* on the bass drum, and to play quavers and semi-quavers in moderate tempo. A roll is sometimes played by holding a short stick, furnished with a knob at each end, in the middle and striking in quick succession with each knob alternately; two kettledrum sticks answer the purpose still better. It is understood that the cymbals play the same music as the bass drum unless the composer has written *senza piatti* over the part. Wagner did not once score for the bass drum after he composed *Rienzi*, but Verdi, Gounod, Berlioz and Sullivan used it effectively. The bass drum was formerly known as the *long drum*, the cylinder being long in proportion to the diameter.

The *side or snare drum* (Fr. *tambour militaire*; Ger. *Militär-trommel*; Ital. *tamburo militare*) is an instrument consisting of



FIG. 1.—Military Bass Drum
 Besson & Co.)

a small wooden or brass cylinder with a vellum at each end. The parchments are lapped over small hoops and pressed firmly down by larger hoops. As in the bass drum, these and the vellums are tightened or slackened by means of cords and leather braces, or by a system of rods and screws. Across the lower head are stretched two or more catgut strings called snares, which produce a rattling sound at each stroke on the upper head, owing to the sympathetic vibration of the lower head which jars against the snares. The upper head, set in vibration by

the pipe. The tambourin and galoubet are in fact a survival of the pipe and tabor (*q.v.*).

The popularity of all kinds of drums in the most ancient civilizations is established beyond a doubt by the numerous representations of the instrument in a variety of shapes and sizes on the monuments and paintings of Egypt, Assyria, India and Persia. The *symphonon*, under which name seem to have been included tambourines and kettledrums, as well as the dulcimer (during the middle ages), was in use among Greeks and Romans chiefly in the worship of Cybele and Bacchus; it was introduced through the medium of the Roman civilization into western Europe. It is often said that the drum was introduced by the crusaders, but it was certainly known in England long before the crusades, for Bede (*Musica practica*) mentions it in his list of instruments, and Cassiodorus (ii. p. 507) describes it. The side drum was, until the reign of Elizabeth, of a much larger size than now and was held horizontally and beaten on one head only. It is not known at what date snares were added; Praetorius (*Synlogus musicum*, 1618) and Merseune (*L'Harmonie universelle*, Paris, 1636) both mention them. A drawing of a side drum showing a snare appears in a book² from the printing press of J. Badius Ascensius (1510); the instrument also has cords and braces. Another woodcut of the same century is given as frontispiece to an edition of Flavius Vegetius Renatus.³ An actual side drum with two curved drumsticks belonging to the ancient Egyptians was found during the excavations conducted at Thebes in 1823.⁴ It measured 1½ ft. in height by 2 ft. in diameter; the tension of the heads was regulated by cords braced by means of catgut encircling both ends of the drum, and wound separately round each cord so that these could be tightened or slackened at will by pulling the catgut bands closer together or pushing them farther apart. The Berlin Museum possesses some ancient Egyptian straight drumsticks with handle and knob. Drums were used at the battle of Halidon Hill (1133). An old ballad celebrating Edward III.'s victory on this occasion appears in a chronicle of the 14th century, preserved in the British Museum (Harl. MS. 4690),

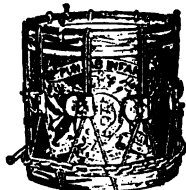

FIG. 2.—Guards pattern Side Drum (Besson & Co.).



FIG. 3.—Regulation Side Drum (Besson & Co.).

direct percussion from the sticks, induces sympathetic vibrations in the air contained within the resonating receptacle, and these vibrations are communicated to the lower head. The presence of the snares across the diameter of the latter produces a phenomenon which gives the side drum its peculiar timbre, changing the nature of the vibrations, now no longer free: the snares form a kind of nodal contact, inducing double the number of vibrations and a sound approximately an octave higher than would be the case were the heads left to vibrate freely. Moreover, the vibrations of the upper head being weaker, the latter is compelled to vibrate synchronously with the lower vellum.¹

The side drum, so called because it is worn at the side, is struck in the centre by two small wooden sticks with elongated heads or knobs of hard wood, producing a hard rasping sound when the drum is played singly and in close proximity to the hearer; when, however, several drums are played simultaneously or with other instruments the effect is brilliant and exhilarating. The roll is produced by striking two blows alternately with each hand quite regularly and very rapidly, the result being a rattling tremolo. This roll ("daddy-mammy") is very difficult to acquire, and requires long practice. The side drum can be muffled by loosening the snares or by inserting a piece of silk or cloth between the snares and the parchment. An impressive effect is produced by a continued roll on muffled drums in funeral marches. The notation for the side drum is similar to that in use for the bass drum; the value of the note is alone of importance; the place of the note on the staff is immaterial and purely a matter of custom. In orchestral scores, a single line is often used, or the part for side and bass drum is written on the same staff. A great variety of rhythmical figures can be played on the side drum, such as

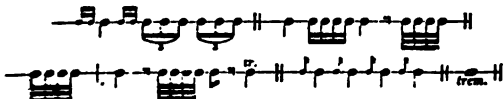

The *tenor drum* (Fr. *caisse roulante*; Ger. *Roll- or Rührtrommel*; Ital. *tamburo roulante*) is similar to the side drum but has a larger cylinder of wood and no snares; consequently its timbre lacks the brilliancy and incisiveness of the side drum. It is used for the roll in military bands, in some theatre orchestras, and on the stage.

The *tambourin de Provence* is a small drum with a long cylinder of narrow diameter used in the Basque provinces with a small pipe (*galoubet*) having three holes. The drum is beaten with one stick only, the performer steadying it with the hand which fingers

¹ See Victor Mahillon, *Catalogue descriptif* (Ghent, 1880), vol. I. pp. 19 and 20.

"This was do with merry sone,
With pipes trumpes and tabers thereto,
And loud clarions they blew also."

A prose account of the battle in the same MS. states that the "Englische mynstrelles beaten their tabers and blewen their trompes and pipers pipenede loude and made a great schowte upon the Skottes."

Froissart, under date 1338, gives details of the means taken by the Scots to intimidate the soldiers of Edward III.⁵ Having mentioned their great horns, he adds, "ils font si grand' noise avec grands tambours qu'ils ont assés." The same chronicler, describing the triumphal entry of Edward III. into Calais (1347), gives the following list of instruments used: "trompes, tambours, nacaires, chalemies, muses."⁶

Drums were used in the British army in the 16th century to give signals in war and peace—side drums by the infantry and dragoons, and kettledrums by the cavalry.⁷ In the reign of Henry VIII. two drummers were allowed to every company of 100 men. The chief drum beats used by the infantry in the 17th century⁸ were *call*, *troop*, *preparative*, *march*, *bataille* and *retreat*; these were later⁹ changed to *general*, *réveille*, *assembly* or *troop*, *tattoo*, *chamade*, &c. The side drum was admitted into the orchestra in the 17th century, when Marais (1636-1728) scored for it in his opera *Alcione*. (K. S.)

² Joannes Mauburnius, *Rosetum exercitiorum spiritualium et sacrament meditationum* (Paris, 1510), Alphabetum, ix.

³ *Vier Bücher der Ritterschaft; mit manicherleyen gerüsten, &c.*; (Augsburg, 1534).

⁴ Carl Engel, *The Music of the Most Ancient Nations* (London, 1864), p. 219.

⁵ *Chron.* ii. p. 737, see also Grose's *Military Antiquities*, ii. 41.

⁶ See Froissart in J. A. Buchon, *Pantheon litt.* (Paris, 1837), vol. I. cap. 322, p. 273.

⁷ Sir John Smythe, *A Brief Discourse* (London, 1594), pp. 158-159.

⁸ Lieut.-Col. W. Baraffe, *Military Discipline, or the Young Artilleryman* (London, 1643).

⁹ Sir James Turner, *Pallas armata* (1685), xxi. 302.

DRUMMOND, HENRY (1786-1860), English banker, politician and writer, best known as one of the founders of the Catholic Apostolic or "Irvingite" Church, was born at the Grange, near Alresford, Hampshire, on the 5th of December 1786. He was the eldest son of Henry Drummond, a prominent London banker, by a daughter of the first Lord Melville. He was educated at Harrow and at Christ Church, Oxford, but took no degree. His name is permanently connected with the university through the chair of political economy which he founded in 1825. He entered parliament in early life, and took an active interest from the first in nearly all departments of politics. Thoroughly independent and often eccentric in his views, he yet acted generally with the Conservative party. His speeches were often almost inaudible but were generally lucid and informing, and on occasion caustic and severe. From 1847 until his death in 1860 he represented West Surrey in parliament. Drummond took a deep interest in religious subjects, and published numerous books and pamphlets on such questions as the interpretation of prophecy, the circulation of the Apocrypha, the principles of Christianity, &c., which attracted considerable attention. In 1817 he met Robert Haldane at Geneva, and continued his movement against the Socinian tendencies then prevalent in that city. In later years he was intimately associated with the origin and spread of the Catholic Apostolic Church. Meetings of those who sympathized with the views of Edward Irving were held for the study of prophecy at Drummond's seat, Albury Park, in Surrey; he contributed very liberally to the funds of the new church; and he became one of its leading office-bearers, visiting Scotland as an "apostle" and being ordained as an "angel" for that kingdom. The numerous works he wrote in defence of its distinctive doctrines and practice were generally clear and vigorous, if seldom convincing. He died on the 20th of February 1860.

DRUMMOND, HENRY (1851-1897), Scottish evangelical writer and lecturer, was born in Stirling on the 17th of August 1851. He was educated at Edinburgh University, where he displayed a strong inclination for physical and mathematical science. The religious element was an even more powerful factor in his nature, and disposed him to enter the Free Church of Scotland. While preparing for the ministry, he became for a time deeply interested in the evangelizing mission of Moody and Sankey, in which he actively co-operated for two years. In 1877 he became lecturer on natural science in the Free Church College, which enabled him to combine all the pursuits for which he felt a vocation. His studies resulted in his writing *Natural Law in the Spiritual World*, the argument of which was that the scientific principle of continuity extended from the physical world to the spiritual. Before the book issued from the press (1883), a sudden invitation from the African Lakes Company drew Drummond away to Central Africa. Upon his return in the following year he found himself famous. Large bodies of serious readers, alike among the religious and the scientific classes, discovered in *Natural Law* the common standing-ground which they needed; and the universality of the demand proved, if nothing more, the seasonableness of its publication. Drummond continued to be actively interested in missionary and other movements among the Free Church students. In 1888 he published *Tropical Africa*, a valuable digest of information. In 1890 he travelled in Australia, and in 1893 delivered the Lowell Lectures at Boston. It had been his intention to reserve them for mature revision, but an attempted piracy compelled him to hasten their publication, and they appeared in 1894 under the title of *The Ascent of Man*. Their object was to vindicate for altruism, or the disinterested care and compassion of animals for each other, an important part in effecting "the survival of the fittest," a thesis previously maintained by Professor John Fiske. Drummond's health failed shortly afterwards, and he died on the 11th of March 1897. His character was full of charm. His writings were too nicely adapted to the needs of his own day to justify the expectation that they would long survive it, but few men exercised more religious influence in their own generation, especially on young men.

DRUMMOND, THOMAS (1797-1840), British inventor and administrator, was born at Edinburgh on the 10th of October 1797, and was educated at the high school there. He was appointed to a cadetship at the Royal Military Academy, Woolwich, in 1813; and in 1815 he entered the Royal Engineers. In 1819, when meditating the renunciation of military service for the bar, he made the acquaintance of Colonel T. F. Colby (1784-1852), from whom in the following year he received an appointment on the trigonometrical survey of Great Britain. During his winters in London he attended the chemical lectures of W. T. Brande and M. Faraday at the Royal Institution, and the mention at one of these of the brilliant luminosity of lime when incandescent suggested to him the employment of the lime light for making distant surveying stations visible. In 1825, when he was assisting Colby in the Irish survey, his lime-light apparatus ("Drummond light") was put to a practical test, and enabled observations to be completed between Divis mountain, near Belfast, and Slieve Snaght, a distance of 67 m. About the same time he also devised an improved heliostat, and in 1829 he was employed in adopting his light for lighthouse purposes. In 1831 he entered political life and was appointed superintendent of the boundary commission. Four years later he was made under-secretary of state for Ireland, where he proved himself a most successful administrator, and did much to promote law and order. It was he who in 1838 told the Irish landlords that "property has its duties as well as its rights." In 1836 he proposed the appointment of a commission on railways in Ireland, and took a large share in its work, which resulted in the recommendation, not, however, carried out, that the state should construct a system of lines throughout the island. Drummond's health was undermined by overwork, and he died at Dublin on the 15th of April 1840.

See *Life* by J. F. M'Lennan (1867); *Life and Letters* by R. Barry O'Brien (1889); and Sir T. A. Larcom in *Papers on the Duties of the Royal Engineers*, vol. iv. (1840).

DRUMMOND, WILLIAM (1585-1649), called "of Hawthornden," Scottish poet, was born at Hawthornden, near Edinburgh, on the 13th of December 1585. His father, John Drummond, was the first laird of Hawthornden; and his mother was Susannah Fowler, sister of William Fowler (q.v.), poet and courtier. Drummond received his early education at the high school of Edinburgh, and graduated in July 1605 as M.A. of the recently founded university of Edinburgh. His father was a gentleman usher at the English court (as he had been at the Scottish court from 1590) and William, in a visit to London in 1606, describes the festivities in connexion with the visit of the king of Denmark. Drummond spent two years at Bourges and Paris in the study of law; and, in 1609, he was again in Scotland, where, by the death of his father in the following year, he became laird of Hawthornden at the early age of twenty-four. The list of books he read up to this time is preserved in his own handwriting. It indicates a strong preference for imaginative literature, and shows that he was keenly interested in contemporary verse. His collection (now in the library of the university of Edinburgh) contains many first editions of the most famous productions of the age. On finding himself his own master, Drummond naturally abandoned law for the muses; "for," says his biographer in 1711, "the delicacy of his wit always run on the pleasantness and usefulness of history, and on the fame and softness of poetry." In 1612 began his correspondence with Sir William Alexander of Menstrie, afterwards earl of Stirling (q.v.), which ripened into a life-long friendship after Drummond's visit to Menstrie in 1614.

Drummond's first publication appeared in 1613, an epy on the death of Henry, prince of Wales, called *Tears on the Death of Meliades* (*Mœliades*, 3rd edit. 1614). The poem shows the influence of Spenser's and Sidney's pastoralism. In the same year he published an anthology of the elegies of Chapman, Wither and others, entitled *Mausoleum, or The Choicest Flowers of the Epitaphs*. In 1616, the year of Shakespeare's death, appeared *Poems: Amorous, Funeral, Divine, Pastoral: in Sonnets, Songs, Sestains, Madrigals*, being substantially the

story of his love for Mary Cunningham of Barns, who was about to become his wife when she died in 1615. The poems bear marks of a close study of Sidney, and of the Italian poets. He sometimes translates direct from the Italian, especially from Marini. *Forth Feasting: A Panegyricke to the King's Most Excellent Majestie* (1617), a poem written in heroic couplets of remarkable facility, celebrates James's visit to Scotland in that year. In 1618 Drummond began a correspondence with Michael Drayton. The two poets continued to write at intervals for thirteen years, the last letter being dated in the year of Drayton's death. The latter had almost been persuaded by his "dear Drummond" to print the later books of *Poly-Olbiou* at Hart's Edinburgh press. In the winter of 1618-1619, Drummond had included Ben Jonson in his circle of literary friends, and at Christmas 1618 was honoured with a visit of a fortnight or more from the dramatist. The account of their conversations, long supposed to be lost, was discovered in the Advocates' Library, Edinburgh, by David Laing, and was edited for the Shakespeare Society in 1842 and printed by Gifford & Cunningham. The conversations are full of literary gossip, and embody Ben's opinion of himself and of his host, whom he frankly told that "his verses were too much of the schooles, and were not after the fancie of the time," and again that he "was too good and simple, and that oft a man's modestie made a fool of his wit." But the publication of what was obviously intended merely for a private journal has given Jonson an undeserved reputation for harsh judgments, and has cast blame on Drummond for blackening his guest's memory.

In 1623 appeared the poet's fourth publication, entitled *Flowers of Sion: By William Drummond of Hawthorndenne: to which is adjoyned his Cypress Grove*. From 1625 till 1630 Drummond was probably for the most part engaged in travelling on the Continent. In 1627, however, he seems to have been home for a short time, as, in that year, he appears in the entirely new character of the holder of a patent for the construction of military machines, entitled "Littera Magistri Gulielmi Drummond de Fabrica Machinarum Militarum, Anno 1627." The same year, 1627, is the date of Drummond's munificent gift (referred to above) of about 500 volumes to the library of the university of Edinburgh.

In 1630 Drummond again began to reside permanently at Hawthornden, and in 1632 he married Elizabeth Logan, by whom he had five sons and four daughters. In 1633 Charles made his coronation-visit to Scotland; and Drummond's pen was employed in writing congratulatory speeches and verses. As Drummond preferred Episcopacy to Presbytery, and was an extremely loyal subject, he supported Charles's general policy, though he protested against the methods employed to enforce it. When Lord Balmerino was put on his trial on the capital charge of retaining in his possession a petition regarded as a libel on the king's government, Drummond in an energetic "Letter" (1635) urged the injustice and folly of the proceedings. About this time a claim by the earl of Menteth to the earldom of Strathearn, which was based on the assertion that Robert III., husband of Annabella Drummond, was illegitimate, roused the poet's pride of blood and prompted him to prepare an historical defence of his house. Partly to please his kinsman the earl of Perth, and partly to satisfy his own curiosity, the poet made researches in the genealogy of the family. This investigation was the real secret of Drummond's interest in Scottish history; and so we find that he now began his *History of Scotland during the Reigns of the Five Jameses*, a work which did not appear till 1655, and is remarkable only for its good literary style. His next work was called forth by the king's enforced submission to the opposition of his Scottish subjects. It is entitled *Irene: or a Remonstrance for Concord, Amity, and Love amongst His Majesty's Subjects* (1638), and embodies Drummond's political creed of submission to authority as the only logical refuge from democracy, which he hated. In 1639 Drummond had to sign the Covenant in self-protection, but was uneasy under the burden, as several political squibs by him testify. In 1643 he published *Συμπλαχία: or a Defence of a Petition tendered to the Lords of the Council of*

Scotland by certain Noblemen and Gentlemen, a political pamphlet in support of those royalists in Scotland who wished to espouse the king's cause against the English parliament. Its burden is an invective on the intolerance of the then dominant Presbyterian clergy.

His later works may be described briefly as royalist pamphlets, written with more or less caution, as the times required. Drummond took the part of Montrose; and a letter from the Royalist leader in 1646 acknowledged his services. He also wrote a pamphlet, "A Vindication of the Hamiltons," supporting the claims of the duke of Hamilton to lead the Scottish army which was to release Charles I. It is said that Drummond's health received a severe shock when news was brought of the king's execution. He died on the 4th of December 1649. He was buried in his parish church of Lasswade.

Drummond's most important works are the *Cypresse Grove* and the poems. The *Cypresse Grove* exhibits great wealth of illustration, and an extraordinary command of musical English. It is an essay on the folly of the fear of death. "This globe of the earth," says he, "which seemeth huge to us, in respect of the universe, and compared with that wide pavilion of heaven, is less than little, of no sensible quantity, and but as a point." This is one of Drummond's favourite moods; and he uses constantly in his poems such phrases as "the All," "this great All." Even in such of his poems as may be called more distinctively Christian, this philosophic conception is at work.

A noteworthy feature in Drummond's poetry, as in that of his courtier contemporaries Ayton (*q.v.*), Lord Stirling and others, is that it manifests no characteristic Scottish element, but owes its birth and inspiration rather to the English and Italian masters. Drummond was essentially a follower of Spenser, but, amid all his sensuousness, and even in those lines most conspicuously beautiful, there is a dash of melancholy thoughtfulness—a tendency deepened by the death of his first love, Mary Cunningham. Drummond was called "the Scottish Petrarch"; and his sonnets, which are the expression of a genuine passion, stand far above most of the contemporary Petrarchan imitations. A remarkable burlesque poem *Polemnia-Middinia inter Vitaroom et Nebernam* (printed anonymously in 1684) has been persistently, and with good reason, ascribed to him. It is a mock-heroic tale, in dog-Latin, of a country feud on the Fifeshire lands of his old friends the Cunninghams.

Drummond's *Poems*, with *Cypresse Grove*, the *History*, and a few of the minor tracts, were collected in 1656 and edited by Edward Phillips, Milton's nephew. *The Works of William Drummond, of Hawthornden* (1711), edited by Bishop Sage and Thomas Ruddiman, contains a life by the former, and some of the poet's letters. A handsome edition of the *Poems* was printed by the Maitland Club in 1832. Later editions are by Peter Cunningham (1833), by William R. Turnbull in "The Library of Old Authors" (1856), and by W. C. Ward (1894) for "The Muses' Library." The standard biography of Drummond is by David Masson (1873). Extracts from the Hawthornden MSS. preserved in the Library of the Society of Antiquaries of Scotland were printed by David Laing in *Archæologia Scotica*, vol. iv.

DRUNKENNESS, a term signifying generally a state resulting from excessive drinking, and usually associated with alcoholic intoxication, or alcohol poisoning. It may represent either an *act* or a *habit*, the latter consisting in frequent repetitions of the former. As an act it may be an accident, most usually arising from the incautious use of one or other of the commonly employed intoxicating agents; as a habit (as in the form of chronic alcoholism) it is one of the most degrading forms of vice which can result from the enfeeblement of the moral principle by persistent self-indulgence.

What appears to be "intoxication" may arise from many different causes (e.g. epilepsy, fractured skull, intracranial hæmorrhage, and the toxæmic coma of diabetes and uræmia), and the close resemblance between the pathological and the toxic phenomena has been the cause of many untoward accidents. Cold alone may produce such peculiar effects that Captain Farry said in his *Journal*, "I cannot help thinking that many a man may have been punished for intoxication who was only suffering from the benumbing effects of frost; for I have more than once

seen our people in a state so exactly resembling that of the most stupid intoxication, that I should certainly have charged them with the offence had I not been quite sure that no possible means were afforded them on Melville Island to procure anything stronger than snow water." The same confusion is frequently found in cases which come before the police-courts, people being arrested as "drunk and disorderly" who can prove that the symptoms were not due to over-indulgence in drink at all. Some individuals have, moreover, a special idiosyncrasy or susceptibility to alcohol, due to heredity or to one of the sequelae of sunstroke or cranial injury. The children of drunkards are usually very susceptible to the poison, becoming intoxicated by a far smaller quantity than is needed by a normal person.

But, as a rule, the phenomena of drunkenness are actually due to excessive consumption of some intoxicating liquid. The physiological action of all such agents may be described as a cumulative production of paralysis of various parts of the nervous system, but this effect results only in doses of a certain amount—a dose which varies with the agent, the race and the individual. Even the cup so often said to "cheer, but not inebriate," cannot be regarded as altogether free from the last-named effect. Tea-sots are well known to be affected with palpitation and irregularity of the heart, as well as with more or less sleeplessness, mental irritability and muscular tremors, which in some culminate in paralysis; while positive intoxication has been known to be the result of the excessive use of strong tea. In short, from tea to haschisch we have, through hops, alcohol, tobacco and opium, a sort of graduated scale of intoxicants, which stimulate in small doses and narcotize in larger,—the narcotic dose having no stimulating properties whatever, and only appearing to possess them from the fact that the agent can only be gradually taken up by the blood, and the system thus comes primarily under the influence of a stimulant dose. In certain circumstances and with certain agents—as in the production of chloroform narcosis—this precursory stage is capable of being much abbreviated, if not altogether annihilated; while with other agents—as tea—the narcotic stage is by no means always or readily produced.

No subject in modern times has led to more extreme opinions than this of indulgence in "intoxicants" to any degree whatever. It is well to remember that (in spite of apparently authoritative modern views to the contrary) there is not a shadow of proof that the moderate use of any one of these agents as a stimulant has any definite tendency to lead to its abuse; it is otherwise with their employment as narcotics, which, once indulged in, is almost certain to lead to repetition, and to a more or less rapid process of degradation, though there are many exceptions to this latter statement. It is interesting to know that a former English judge, who lived to nearly ninety years of age, believed he had prolonged his life and added greatly to his comfort by the moderate use of ether, which he was led to employ because neither wine nor tobacco agreed with him; while the immoderate use of the same agent has given rise to a most deleterious form of drunkenness, both in parts of Ireland and in some of the large industrial centres in Great Britain.

Various modern biologists have discussed, with more or less acceptance in certain circles, the historical conditions in various races and in different countries as to the use and abuse of intoxicants, and have drawn varying conclusions from their theories. It has even been contended, with much show of learned authority, that since drunkenness leads to disease and early death, the proneness to strong drink in the long run causes the elimination of the unfit, and results in a general sobering of the community, a race being therefore temperate in proportion to its past sufferings through alcohol. But on this subject it may be said that, at least, no agreement has been reached.

The effects of intoxicants are variously modified by the temperament of the individual and the nature of the inebriant. When that is alcohol, its action on an average individual is first to fill him with a serene and perfect self-complacency. His feelings and faculties are exalted into a state of great activity and buoyancy, so that his language becomes enthusiastic, and

his conversation vivacious if not brilliant. The senses gradually become hazy, a soft humming seems to fill the pauses of the conversation, and modify the tones of the speaker, a filmy haze obscures the vision, the head seems lighter than usual, the equilibrium unstable. By-and-by objects appear double, or fit confusedly before the eyes; judgment is abolished, secretiveness annihilated, and the drunkard pours forth all that is within him with unrestrained communicativeness; he becomes boisterous, ridiculous, and sinks at length into a mere animal. Every one around him, the very houses, trees, even the earth itself, seem drunken and unstable, he alone sober, till at last the final stage is reached, and he falls on the ground insensible—*dead drunk* (alcoholic coma)—a state from which, after profound slumber, he at last awakes feverish, exhausted, sick and giddy, with ringing ears, a throbbing heart and a violent headache.

The poison primarily affects the cerebral lobes, and the other parts of the cerebro-spinal system are consecutively involved, till in the state of *dead drunkenness* the only parts not invaded by a benumbing paralysis are those automatic centres in the medulla oblongata which regulate and maintain the circulation and respiration. But even these centres are not unaffected; the paralysis of these as of the other sections of the cerebro-spinal system varies in its incompleteness, and at times becomes complete, the coma of drunkenness terminating in death. More usually the intoxicant is gradually eliminated, and the individual restored to consciousness, a consciousness disturbed by the secondary results of the agent he has abused, which vary with the nature of that agent. Whether, however, directly or indirectly through the nervous system, the stomach suffers in every case; thus nutrition is interfered with by the defective ingestion of food, as well as by the mal-assimilation of that which is ingested; and from this cause, as well as by the peculiar local action of the various poisons, the various organic degenerations are induced (cirrhosis of the liver, &c.) which in most cases shorten the drunkard's days.

The primary discomforts of an act of drunkenness are readily removed for the time by a repetition of the cause. Thus what has been an act may readily become a habit, all the more readily that each repetition more and more enfeebles both the will and the judgment, till they become utterly unfit to resist the temptation to indulgence supplied by the knowledge of the temporary relief to suffering which is sure to follow, and in spite of the consciousness that each repetition of the act only forges their chains more tightly. From this condition there is no hope of relief but in enforced abstinence; any one in this condition must be regarded as temporarily insane (see *INSANITY* and *NEUROPATHOLOGY*), and ought to be placed in an inebriate asylum till he regain sufficient self-control to enable him to overcome his love for drink. Numerous "cures" have been started in recent years, which have often succeeded in individual cases. An anti-alcoholic serum obtained from alcoholized horses has been advocated by Dr Sapelier.

For the law concerning drunkenness the reader is referred to *INEBRIETY, LAW OF*. Its prevalence as a vice has varied considerably according to the state of education or comfort in different classes of society. In considering the extent to which intemperance has prevailed, the statistics of prosecutions upon which such comparisons are usually based are far from being completely satisfactory, but, inasmuch as they constitute the only possible data for such comparisons, we are compelled to accept them. The following table gives the average number of persons per 1000 of the population proceeded against for drunkenness in England and Wales for quinquennial periods, dating from 1857, the first year of the Judicial Statistics:—

1857-1861	4.28
1862-1866	4.78
1867-1871	5.47
1872-1876	7.83
1877-1881	7.25
1882-1886	6.90
1887-1891	6.19
1892-1896	5.84
1897-1901	6.42
1902-1906	6.51

The figures, it will be seen, show a steady decline from 1872-1876 (when the consumption of alcohol was quite abnormal) to 1892-1896. After that year, however, the figures again rose. The increase was especially marked in 1899, when a tide of exceptional prosperity was again accompanied by great drunkenness. It is also disquieting to discover that the average number of prosecutions for drunkenness in the three years 1897-1899 was 51% higher than the average for 1857-1861, and 35% higher than the average for 1862-1866. That the increase was partly due to more efficient police administration is probable, but that this is not a complete explanation of the figures is made evident by an analysis of the general statistics of crime during the same period, from which it may be seen that, while crime generally (excluding drunkenness) decreased 28% in England and Wales since 1857-1861, drunkenness increased 51%. Speaking generally, it may be said that in the United Kingdom drunkenness appears chiefly prevalent in the seaport and mining districts. If a line be drawn from the mouth of the Severn to the Wash, it will be found that the "black" counties, without exception, lie to the north-west of this line. The worst counties in England and Wales in the matter of drunkenness are Northumberland, Durham and Glamorganshire, while Pembrokeshire and Lancashire follow close behind. The most sober counties, on the other hand, are Cambridgeshire, Suffolk, Oxfordshire and Wiltshire. Averages based upon the returns of entire counties do not, however, afford a complete guide to the distribution of drunkenness, inasmuch as offences are not equally distributed over the whole area of a county. A heavy ratio of drunkenness in a small district may often give a county an unfavourable position in the general averages, notwithstanding favourable conditions in the rest of its area.

Analysis of the prosecutions for drunkenness shows that about 24% of the total number of offences are committed by women. In the larger towns the proportion, as a rule, is higher. In London, 38% of the drunkenness is attributable to women; in Manchester, 36%; in Belfast and Glasgow, 32%. In Liverpool, on the other hand, the proportion is only 24%. The much-controverted question as to whether intemperance is increasing among women can hardly, however, be decided by an appeal to the criminal statistics. So far as these statistics throw any light at all upon the question, they suggest important local differences. A more direct clue is afforded by the registrar-general's annual returns of deaths directly attributed to intemperance. The figures are given below. In order to eliminate accidental variations, the comparison is based upon the average mortality during consecutive periods:—

Years.	Average No. of deaths (England and Wales).	Males per cent.	Females per cent.
1877-1881	1071	69	31
1882-1886	1320	66	34
1887-1891	1710	64	36
1892-1896	2044	61	39
1897-1899	2577	61	39
1899	2871	60	40

For the ten years ending 1904, out of 26,426 deaths from alcoholism, 59.34% were males and 40.66% females.

The figures are certainly striking. They show, it will be noticed, that out of every 100 deaths from alcoholic excess in England and Wales women contributed nine more at the end of the century than they did in 1880. If, instead of taking the total number of deaths, we take the ratio per million persons living, the increase is seen even more clearly:—

Years.	Males per million living.	Females per million living.
1877-1881	60	25
1882-1886	67	32
1887-1891	79	42
1892-1896	86	51
1897-1899	103	63
1899	112	70

It appears that, while the ratio of mortality from alcoholic excess increased 87% among males during the last two decades of the century, among females it increased by no less than 180%.

See also LIQUOR LAWS and TEMPERANCE.

DRURY, SIR WILLIAM (1527-1579), English statesman and soldier, was a son of Sir Robert Drury of Hedgerley in Buckinghamshire, and grandson of another Sir Robert Drury (d. 1536), who was speaker of the House of Commons in 1495. He was born at Hawkstead in Suffolk on the 2nd of October 1527, and was educated at Gonville Hall, Cambridge. Fighting in France, Drury was taken prisoner in 1544; then after his release he helped Lord Russell, afterwards earl of Bedford, to quell a rising in Devonshire in 1549, but he did not come to the front until the reign of Elizabeth. In 1559 he was sent to Edinburgh to report on the condition of Scottish politics, and five years later he became marshal and deputy-governor of Berwick. Again in Scotland in January 1570, it is interesting to note that the regent James Stewart, earl of Murray, was proceeding to keep an appointment with Drury in Linlithgow when he was mortally wounded, and it was probably intended to murder the English envoy also. After this event Drury led two raids into Scotland; at least thrice he went to that country on more peaceable errands, during which, however, his life was continually in danger from assassins; and he commanded the force which compelled Edinburgh Castle to surrender in May 1573. In 1576 he was sent to Ireland as president of Munster, where his stern rule was very successful, and in 1578 he became lord justice to the Irish council, taking the chief control of affairs after the departure of Sir Henry Sidney. The rising of the earl of Desmond had just broken out when Sir William died in October 1579.

Drury's letters to Lord Burghley and others are invaluable for the story of the relations between England and Scotland at this time.

DRUSES, or DRUZES (Arab. *Druza*), a people of mid-Syria (for the derivation of the name see *History* section below), distributed nowadays into three isolated groups, of which the most numerous inhabits Jebel Hauran (Jebel Druz), E. of Jordan (about 55,000); the second, the *casas* of Shuf and Metn in Lebanon (about 50,000); the third, the *casas* of Hasbeya, Raasheya, W. al Ajem, Homs, Hamadiyeh and Selimiyyeh in Anti-Lebanon and Hermon (about 45,000). The first group, which has been greatly increased by migrants from the second, since the establishment of the privileged Lebanon province (1861) under Christian auspices, lives apart from other peoples in semi-independence. The second is now confined to the southern Lebanon, and even there is greatly outnumbered by Maronites, who, in the whole "Mountain," stand to Druses as 9 to 2. The third is counterbalanced everywhere by a large population of Moslem and Orthodox Syrians. The Hauran, therefore, has become the stronghold of the Druses, offering nowadays the best field for studying their peculiar customs and religion; and the group there still increases at the expense of the other groups, despite efforts on the part of the Ottoman government to check Druse migration by both conciliatory and repressive measures. The actual distinction of the Druses, as a racial unity, despite their dispersion, depends so exclusively on the peculiarity of their common religion, that it will be well at once to give an account of Druse creed and practice as they are understood to stand at the present day. How this religion may have grown up and come to be theirs will be considered later.

Religion.—Druse religion is a secret faith, and the following account is given with all reserves. There are many indications that a more primitive cult, containing elements of Nature worship, preceded it, and still survives in the popular practices of the more remote Druse districts, e.g. in the eastern Hauran. The *Muwahhidin* (Unitarians), as the Druses call themselves, believe that there is one and only one God, indefinable, incomprehensible, ineffable, passionless. He has made himself known to men by successive incarnations, of which the last was Hakim, the sixth Fatimite caliph. How many these incarnations have been is stated variously; but seventy, one for each period of the world, seems the best-attested number. Jesus appear--

be accepted as one such incarnation, but not Mahomet, although it is agreed that, in his time, the "Universal Intelligence" (see later) was made flesh, in the person of Mikdad al-Aswad. No further incarnation can now take place: in Hakim a final appeal was made to mankind, and after the door of mercy had stood open to all for twenty-six years, it was finally and for ever closed. When the tribulation of the faithful has reached its height, Hakim will reappear to conquer the world and render his religion supreme. Druses, believed to be dispersed in China, will return to Syria. The combined body of the Faithful will take Mecca, and finally Jerusalem, and all the world will accept the Faith. The first of the creatures of God is the Universal Intelligence or Spirit, impersonated in Hamza, Hakim's vizier. This Spirit was the creator of all subordinate beings, and alone has immediate communion with the Deity. Next in rank, and equally supporting the throne of the Almighty, are four Ministering Spirits, the Soul, the Word, the Right Wing and the Left Wing, who, in Hakim's time, were embodied respectively in Ismael Darazi, Mahommed ibn Wahab, Selama ibn Abd al-Wahab and Baha ud-Din; and beneath these again are spiritual agents of various ranks. The material world is an emanation from, and a "mirror" of, the Divine Intelligence. The number of human beings admits neither of increase nor of decrease, and a regular process of metempsychosis goes on continually. The souls of the virtuous pass after death into ever new incarnations of greater perfection, till at last they reach a point at which they can be re-absorbed into the Deity itself; those of the wicked may be degraded to the level of camels or dogs. All previous religions are mere types of the true, and their sacred books and observances are to be interpreted allegorically. The Gospel and the Koran are both regarded as inspired books, but not as religious guides. The latter function is performed solely by the Druse Scriptures. As the admission of converts is no longer permitted, the faithful are enjoined to keep their doctrine secret from the profane; and in order that their allegiance may not bring them into danger, they are allowed (like Persian mystics) to make outward profession of whatever religion is dominant around them. To this latter indulgence is to be attributed the apparent indifference which leads to their joining Moslems in prayers and ablutions, or sprinkling themselves with holy water in Maronite churches. Obedience is required to the seven commandments of Hamza, the first and greatest of which enjoins truth in words (but only those of Druse speaking with Druse); the second, watchfulness over the safety of the brethren; the third, absolute renunciation of every other religion; the fourth, complete separation from all who are in error; the fifth, recognition of the unity of "Our Lord" in all ages; the sixth, complete resignation to his will; and the seventh, complete obedience to his orders. Prayer, however, is regarded as an impertinent interference with the Creator; while, at the same time, instead of the fatalistic predestination of Mahommedanism, the freedom of the human will is distinctly maintained. Not only is the charge of secrecy rigidly obeyed in regard to the alien world, but full initiation into the deeper mysteries of the creed is permitted only to a special class designated *Akils*, (Arabic *Akl*, intelligence), in contradistinction from whom all other members of the Druse community, whatever may be their position or attainments, are called *Jahel*, the Ignorant. About 15% of the adult population belong to the order of *Akils*. Admission is granted to any Druse of either sex who expresses willingness to conform to the laws of the society, and during a year of probation gives sufficient proof of sincerity and stability of purpose. There appears to be no formal distinction of rank among the various members; and though the amir, Beshir Shehab, used to appoint a sheikh of the *Akils*, the person thus distinguished obtained no primacy over his fellows. Exceptional influence depends upon exceptional sanctity or ability. All are required to abstain from tobacco and wine; the women used not to be allowed to wear gold or silver, or silk or brocade, but this rule is commonly broken now; and although neither celibacy nor retirement from the affairs of the world is either imperative or customary, unusual respect

is shown to those who voluntarily submit themselves to ascetic discipline. While the *Akils* mingle frankly with the common people, and are remarkably free from clerical pretension, they are none the less careful to maintain their privileges. They are distinguished by the wearing of a white turban, emblematic of the purity of their life. Their food must be purchased with money lawfully acquired; and lest they should unwittingly partake of any that is ceremonially unclean, they require those *Jahels*, whose hospitality they share, to supply their wants from a store set apart for their exclusive use. The ideal *Akil* is grave, calm and dignified, with an infinite capacity of keeping a secret, and a devotion that knows no limits to the interests of his creed. On Thursday evening, the commencement of the weekly day of rest, the members of the order meet together in the various districts, probably for the reading of their sacred books and consultation on matters of ecclesiastical or political importance. Their meeting-houses, *khalwas*, are plain, unornamented edifices. These have property attached to them, the revenues of which are consecrated to the relief of the poor and the demands of hospitality. In the eastern Hauran, there are hill-top shrines containing each a black stone, on which rugs, &c., are hung, and these seem to perpetuate features of pre-Islamic Arabian cult, including the sacrifice of animals, e.g. goats. They are held in reverence by the Bedouins. The women assemble in the *khalwas* at the same time as the men, a part of the space being fenced off for them by a semi-transparent black veil. Even while the *Akils* are assembled, strangers are readily enough admitted to the *khalwas*; but as long as these are present the ordinary ceremonies are neglected, and the Koran takes the place of the Druse Scriptures. It has been frequently asserted that the image of a calf is kept in a niche, and traces of phallic and gynaeocratic worship have been vaguely suspected; but there is no authentic information in support of either statement. The calf, if calf there be, is probably a symbol of the execrable heresy of Darazi, who is frequently styled the calf by his Orthodox opponents. Ignorance is the mother of suspicion as well as of superstition; and accordingly the Christian inhabitants of the Lebanon have long been persuaded that the Druses in their secret assemblies are guilty of the most nefarious practices. For this allegation, so frequently repeated by European writers, there seems to be little evidence; and it is certain that the sacred books of the religion contain moral teaching of a high order on the whole.

As a formulated creed, the Druse system is not a thousand years old. In the year A.D. 906 (386 A.H.) Hakim Biamrillah (i.e. he who judges by the command of God), sixth of the Fatimite caliphs (third in Egypt), began to reign; and during the next twenty-five years he indulged in a tyranny at once so terrible and so fantastic that little doubt can be entertained of his insanity. He believed that he held direct intercourse with the deity, or even that he was an incarnation of the divine intelligence; and in A.D. 1016 (407 A.H.) his claims were made known in the mosque at Cairo, and supported by the testimony of Ismael Darazi. The people showed such bitter hostility to the new gospel that Darazi was compelled to seek safety in flight; but even in absence he was faithful to his god, and succeeded in winning over certain ignorant inhabitants of Lebanon. According to the Druses, this great conversion took place in A.D. 1019 (410 A.H.). Meanwhile the endeavours of the caliph to get his divinity acknowledged by the people of Cairo continued. The advocacy of Hasan ibn Haidara Fergani was without avail; but in 1017 (408 A.H.) the new religion found a more successful apostle in the person of Hamza ibn Ali ibn Ahmed, a Persian mystic, felt-maker by trade, who became Hakim's vizier, gave form and substance to his creed, and by an ingenious adaptation of its various dogmas to the prejudices of existing sects, finally enlisted an extensive body of adherents. In 1020 (411 A.H.) the caliph was assassinated by contrivance of his sister Sitt ul-Mulk; but it was given out by Hamza that he had only withdrawn for a season, and his followers were encouraged to look forward with confidence to his triumphant return. Darazi, who had acted independently in his apostolate, was branded

by Hamza as a heretic, and thus, by a curious anomaly, he is actually held in detestation by the very sect which perhaps bears his name. The propagation of the faith in accordance with Hamza's initiation was undertaken by Ismael ibn Mahomed Tamimi, Mahommed ibn Wahab, Abul-Khair Selama ibn Abd al-Wahab ibn Samurri, and Muktana Baha ud-Din, the last of whom became known by his writings from Constantinople to the borders of India. In two letters addressed to the emperors Constantine VIII. and Michael the Paphlagonian he endeavoured to prove that the Christian Messiah reappeared in the person of Hamza.

It is possible, even probable, that the segregation of the Druses as a people dates only from the adoption of Hamza's creed. But when it is recalled that other inhabitants of the same mountain system, e.g. the Maronites, the Ansarieh, the Mctawali and the "Isma'ilites," also profess creeds which, like the Druse system, differ from Sunni Islam in the important feature of admitting incarnations of the Deity, it is impossible not to suspect that Hamza's emissaries only gave definition and form to beliefs long established in this part of the world. Many of the fundamental ideas of Druse theology belong to a common West Asiatic stock; but the peculiar history of the Mountain is no doubt responsible for beliefs, held elsewhere by different peoples, being combined there in a single creed. Some allowance, too, must be made for the probability that Hamza's system owed something to doctrines Christian and other, with which the metropolitan position of Cairo brought Fatimite society into contact.

History—There is good reason to regard the Druses as, racially, a mixture of refugee stocks, in which the Arab largely predominates, grafted on to an original mountain population of Aramaic blood and Incarnationist tendencies. The latter is represented more purely by the Maronites (*q.v.*). The native tradition regards an immigration of Hira Arabs into S. Lebanon, under Khalid ibn Walid in the 9th century, as the beginning of Druse distinctiveness and power; but it also accepts Turkoman and Kurdish elements in the original Druse state. About the same time, or a little later (in the reign of Saladin), it believes that Hermon was colonized by a population of 15,000 Hira and Yemenite Arabs, who had sojourned awhile in Hauran. The name Druse is met with first in Benjamin of Tudela (*c. A.D. 1170*), and its origin has been much disputed. Some authorities see in it a descriptive epithet, derived from Arabic *darasa* (those who read the Book), or *darisa* (those in possession of Truth) or *durs* (the clever or initiated); but more connect it with the name of the first missionary, Ismael *Durasi*.

As soon as we begin to know anything of the Druses they were living in a feudal state of society, as village communities under *sheikhs*, themselves generally subordinate to one or more amirs. In the time of the first crusades the main power was in the hands of the Arslan family, which, however, suffered so severely in wars with the Franks, that it was superseded by the Tnuhs, who, holding Beirut and nearly all the Phoenician coast, came into conflict with the sultans of Egypt. One of these latter, Malik Ashraf, about A.D. 1300, forced outward compliance with Sunni Islam on the Mountain, after defeating the Druses at Ain Sofar. Meanwhile, however, the *Maan* family, lately immigrant from N. Arabia, was growing in power, and throwing in its lot with the Osmanli invaders in the reign of Selim I., it was promoted to the supreme amirate about 1517. Fakr ud-Din Maan II. increased Druse dominion until it included all the N. Syrian region from the edge of the Antioch plain to Acre, with part of the eastern desert, dominated by his castle at Tadmor (Palmyra), and the important towns of Latakia, Tripoli, Beirut and Saïda; and forming further ambitious designs, he intrigued with Christians and broke with the Turks. In 1614 the pasha of Damascus moved against him with a large force, and compelled him to fly from Syria. He sought the courts of Tuscany and Naples and tried to enlist Frank sympathies, inventing (probably) the curious myth, so often credited since, that the Druses are of crusading origin and owe their name to the counts of Dreux.¹

¹ Sophisticated Druses still sometimes claim connexion with Rosicrucians, and a special relation to Scottish freemasons.

He landed again at Saïda in 1610 and recovered his old position. But in 1633 Kuchuk Ahmed Pasha was sent against him with a large army, and succeeded in capturing him with his sons. The family was sent to Constantinople, and two years later strangled. The dynasty struggled on till the end of the century, amid civil war, in which the parties seem to have been divided by the earlier Arab factions of Kaisites (Qaisites) and Yemenites, the Maan belonging to the latter.

The Shehab family, originally Hira Arabs, which had governed Hauran under the early caliphs of Damascus, and thereafter held power in Hermon, intermarried with the Maan; and in the latter's day of weakness sided with the Kaisi faction and obtained the supreme amirate of the Mountain. But it appears never to have professed the Druse creed, remaining Sunnite. Haidar Shehab, third of the line, inflicted a notable defeat on the pasha of Saïda (capital of an Ottoman eyalet since 1688) and the Yemenite Druses at Ain Dara, near Zahleh, in 1711, and proceeded to consolidate Shehab power, breaking up the old feudal society and substituting for the sheikhs *mukatajis* (tax-contractors), who had penal jurisdiction. The Yemenite Druses thereupon emigrated in large numbers to the Hauran, and laid the foundation of Druse power there. The Turks recognized the *status quo*, and made terms with the Shehab amir in 1748; but his power was none too well secured against the opposition of the Kurdish *Jumblat* family, even though he was supported by the *Talhuq*, *Abd al-Malik* and *Yezbeki* families; and it appears that some members of the Shehab joined the Maronite faith in the middle of the 18th century, causing a suspicion of secret apostasy to fall on all the family.

It is said that the amir Beshir, who succeeded about 1786, was himself a crypto-Christian. This remarkable man, who ruled the Mountain for fifty-four years, maintained his power by taking the side of one rebel pasha after another, betraying each in turn, and cultivating relations with European admirals. His earliest ally was Ahmed "Jezzar," who established himself in Acre in contumacious independence late in the 18th century. Beshir supported Jezzar against Napoleon in 1799 and earned the friendship of Sir Sidney Smith. Falling out with Jezzar, Beshir fled to Cairo in 1805, attached himself to Mehemet Ali, and returned to take up the reins. Once more chased out by the Turks, he was again in the Mountain in 1823, allied with Abdallah, on whom Jezzar's mantle had ultimately fallen at Acre, and maintaining friendly relations with the "English Princess," Lady Hester Stanhope. He now finally worsted the Jumblat. The invasion of Syria by Mehemet Ali in 1831 caused Beshir to desert Abdallah and throw in his lot with Ibrahim Pasha; but he was not cordially followed by the Druses in general, and had good excuse for revolt in 1839, and intrigue with the British admiral in 1840. Ibrahim, however, by his possession of Druse hostages, restrained the amir, and after the bombardment of Acre, the Turks called him to account for his record of rebellion and treachery. He fled to Malta on a British ship, but was induced to go to Constantinople, where he died in 1851.

His successor, Beshir al-Kassim, openly joined the Maronites, and instigating these against the malcontents of his own people, brought enmities, which had been growing for a century, to a head, and initiated a devastating internecine warfare which was to continue for twenty years. The state of the Lebanon went from bad to worse, and at last, in January 1842, the Turkish government appointed Omar Pasha as administrator of the Druses and Maronites, with a council of four chiefs from each party; but the pasha, attempting to effect a disarming, was besieged in November in the castle of Beit ed-Din by the Druses under Shibli el-Arriani. At the instigation of the European powers he was recalled in December, and the Druses and Maronites were placed under separate *kaimakams* (governors), who, it was stipulated, were not to be of the family of Shehab. Disturbances again broke out in 1845, the native *mukatajis* refusing to obey the *kaimakams*. The Maronites flew to arms, but with the assistance of the Turks their opponents carried the day. A superficial pacification effected by Shekib Effendi, the Ottoman commissioner, lasted only till his departure; and t'

was obliged to despatch a force of 12,000 men to the Lebanon. Forty of the chiefs were seized, the people was nominally disarmed, and in 1846 a new constitution was inaugurated, by which the *kaimakam* was to be assisted by two Druses, two Maronites, four Greeks, two Turks and one Metawali. All, however, was in vain: the conflict was continued through 1858, 1859 and 1860; and the disturbance culminated in the famous Damascus massacre (see SYRIA). The European powers now determined to interfere; and, by a protocol of the 3rd of May 1860, it was decided that the Lebanon should be occupied by a force of 20,000 men, of whom half were to be French. A body of troops was accordingly landed on the 16th of August under General Beaufort d'Hautpoul; and Fuad Pasha, who had been appointed Turkish commissioner with full powers, proceeded to bring the leaders of the massacres to justice. The French occupation continued till the 5th of June 1861, and the French and English squadrons cruised on the coast for several months after. In accordance with the recommendation of the European powers the Porte determined to appoint a Christian governor not belonging to the district, and independent of the pasha of Beirut, to hold office for three years. The choice fell on Daud Pasha, an Armenian Catholic, who was installed on the 4th of July. In spite of many difficulties, and especially the ambitious conduct of the Maronite Jussuf Karam, he succeeded in restoring order; and by the formation of a military force from the inhabitants of the Lebanon he rendered unnecessary the presence of the Turkish soldiery.

The privileged province of Lebanon (*q.s.*) was finally constituted by the Organic Statute of the 6th of September 1864, and the subsequent history of the Lebanon Druses is one of gradual withdrawal from the jurisdiction of that state, in which they see their ancient independence irretrievably compromised, and their religion subordinated to Christian supremacy. Many now emigrate, when occasion offers, to America.

Meanwhile, the Hauran, the old seat of the Shehab family and Hermon Druses, had been steadily receiving a Druse influx, since the day of Ain Dara (see above). Towards the close of the 18th century some 600 families left Lebanon for the Hauran, in discontent with the rule of the Shehab dynasty, and their place and property were taken by 1500 families driven out of Jebel Ansarich by Topal Ali in 1811. The Hauran Druses increased by the middle of the 19th century to 7000 souls. They had successfully resisted Ibrahim, the Egyptian, in 1839 in the Lija, and asserted complete independence of the Turks, living under a theocratic government directed by the chief Akil in Suweda. A great effort, made by Kibrisi Pasha in 1852 to subdue the Hauran, came to nothing. In 1879 the population numbered 20,000, and by a murderous raid attracted the attention of Midhat Pasha, then vali of the province of Syria. After experiencing one disaster he defeated their forces and imposed a *kaimakam*, at first drawn from the Talhuks, but subsequently chosen from the Atrash family of Kunawat. But the Druses still refused to pay taxes, to serve in the Ottoman army, or to recognize the *kaimakam*, and maintained their contumacy under the lead of the Jumblat, till 1896; when, as the result of a military expedition under Tahir Pasha and a great defeat at Ijun, a compromise was arrived at, under which the Druses agreed to pay taxes, but to serve in their own territory only as a frontier guard. The government was put into the hands of a mutessarif resident at Sheikh Saad, under whom are *kaimakams* at Suweda and Salkhad. Since that epoch there has been comparative peace between the Druses and the government, largely because the latter, having learned wisdom, leaves the people very much to itself, maintaining only a small garrison of regular troops, and enlisting Druse police for service in Jebel Druz itself. The Druses are allowed to carry on their feuds with the Bedouins of the E. Desert as they will, so long as they do not disturb western districts. With the recent opening out of the W. Hauran by railway, the Druse sheikhs are beginning to acquire commercial ambitions, and to desire peace.

The Hauran Druses are a vigorous, independent folk, with a well-deserved reputation for courage, very astute, and hospitable

to Europeans, especially the British, with whom they have an old tradition of friendship. But, like most persecuted but semi-independent peoples, they are both cruel, and, by our standards, treacherous. They are a handsome race, the women being often beautiful. The latter no longer carry the head-horn which used to support the veil dropped over the face out of doors. But their dress is still black with the exception of red slippers, and the veil is never abandoned, not even, it is said, during sleep. An English lady, who has been much among them, states that the Druse women of the Hauran never unveiled before her. The men wear a *tarbush* with white roll, a black under-robe with white girdle, a short loose jacket, and when necessary an *aba* or parti-coloured cloak over all. They go habitually armed with scimitar and half-moon axe, besides gun or rifle.

Polygamy is forbidden. Marriage retains certain traces of the original system of capture; but Druse women enjoy much consideration, and are comparatively well educated, dignified and free in their bearing in spite of their close veiling. As has been stated above, they join the men in religious functions. Divorce is easy and can be initiated by the woman; but remarriage of the pair can only be effected by the good offices of a proxy (as in Moslem societies, after a third divorce). Burial takes place in family mausoleums, walled up after each interment; but Akils are buried in their own houses. The body is laid on its side, with its face to the south (Mecca).

Education is widely spread, and there is a considerable religious literature, much of which is known in Europe. A copy of the *Book of the Testimonies to the Mysteries of the Unity*, consisting of seventy treatises in four folio volumes, was found in the house of the chief Akil at Bakhlin, and presented in 1700 to Louis XIV. by Nusralla ibn Gilda, a Syrian doctor. Other manuscripts are to be found at Rome in the Vatican, at Oxford in the Bodleian, at Vienna, at Leiden, at Upsala and at Munich; and Dr J. L. Porter got possession of seven standard works of Druse theology while at Damascus. The Munich collection was presented to the king of Bavaria by Clot Bey, the chief physician in the Egyptian army during its occupation of Syria; and for a number of the other manuscripts we are indebted to the elder Niebuhr. A history of the Druse nation by the amir Haidar Shehab is quoted by Urquhart.

BIBLIOGRAPHY.—Adler, "Druze Catechism," in *Museum Asiaticum Borjonnium* (1782); Silvestre de Sacy, *Exposé de la religion des Druses* (1839); Ph. Wolff, *Reise in das gelobte Land, und Die Drusen und ihre Vorläufer* (1842); C. H. Churchill, *Ten Years' Residence in Hermon Lebanon* (2 vols., 1853); G. W. Chubbent, *The Druses of the Lebanon* (1855); E. G. Ray, *Voyage dans le Haouran, exécuté pendant les années 1857 et 1858*; C. H. Churchill, *The Druses and Maronites under the Turkish Rule from 1820 to 1860* (London, 1862); H. Guys, *Le Théogonie des Druses* (1863), and *La Nation Druse* (1864); M. von Oppenheim, *Vom Mittelmeer, &c.* (1899); Gertrude L. Bell, *The Desert and the Sown* (1907). (D. G. H.; G. B.)

DRUSTIUS (or VAN DEN DRIESCHE), JOHANNES (1550–1616), Protestant divine, distinguished specially as an Orientalist and exegete, was born at Oudenarde, in Flanders, on the 28th of June 1550. Being designed for the church, he studied Greek and Latin at Ghent, and philosophy at Louvain; but his father having been outlawed for his religion, and deprived of his estate, retired to England, where the son followed him in 1567. He found an admirable teacher of Hebrew in Chevalier, the celebrated Orientalist, with whom he resided for some time at Cambridge. In 1572 he became professor of Oriental languages at Oxford. Upon the pacification of Ghent (1576) he returned with his father to their own country, and was appointed professor of Oriental languages at Leiden in the following year. In 1585 he removed to Friesland, and was admitted professor of Hebrew in the university of Franeker, an office which he discharged with great honour till his death, which happened in February 1616. He acquired so extended a reputation as a professor that his class was frequented by students from all the Protestant countries in Europe. His works prove him to have been well skilled in Hebrew and in Jewish antiquities; and in 1600 the states-general employed him, at a salary of 400 florins a year, to write notes on the most difficult passages in the Old Testament; and this work was not published until after his death. As the friend of

Arminius, he was charged by the orthodox and dominant party with unfairness in the execution of the task, and the last sixteen years of his life were therefore somewhat embittered by controversy. He carried on an extensive correspondence with the learned in different countries; for, besides letters in Hebrew, Greek and other languages, there were found amongst his papers upwards of 2000 written in Latin. He had a son, John, who died in England at the age of twenty-one, and was accounted a prodigy of learning. He had mastered Hebrew at the age of nine, and Scaliger said that he was a better Hebrew scholar than his father. He wrote a large number of letters in Hebrew, besides notes on the Proverbs of Solomon and other works.

Paquet states the number of the printed works and treatises of the elder Drusus at forty-eight, and of the unprinted at upwards of twenty. Of the former more than two-thirds were inserted in the collection entitled *Critici sacri, sive annotata doctissimorum virorum in Vetus et Novum Testamentum* (Amsterdam, 1698, in 9 vols. folio, or London, 1660, in 10 vols. folio). Amongst the works of Drusus not to be found in this collection may be mentioned—(1) *Alphabetum Hebraicum vetus* (1584, 4to); (2) *Tabulae in grammaticam Chaldaicam ad usum juvenutis* (1602, 8vo); (3) An edition of Sulpicius Severus (Franker, 1807, 12mo); (4) *Opuscula quae ad grammaticam spectant omnia* (1609, 4to); (5) *Lacrymae in obitum J. Scaligeri* (1609, 4to); and (6) *Grammatica linguae sanctae nova* (1612, 4to).

DRUSUS, MARCUS LIVIUS, Roman statesman, was colleague of Gaius Gracchus in the tribuneship, 122 B.C. The proposal of Gracchus (*q.v.*) to confer the full franchise on the Latins had been opposed not only by the senate, but also by the mob, who imagined that their own privileges would thereby be diminished. Drusus threatened to veto the proposal. Encouraged by this, the senatorial party put up Drusus to outbid Gracchus. Gracchus had proposed to found colonies outside Italy; Drusus provided twelve in Italy, to each of which 3000 citizens were to be sent. Gracchus had proposed to distribute allotments to the poorer citizens subject to a state rent-charge; Drusus promised them free of all charge, and further that they should be inalienable. In addition to the franchise, immunity from corporal punishment (even in the field) was promised the Latins. The absence of Gracchus, and the inefficiency of his representative at Rome, led to the acceptance of these proposals, which were never intended to be carried. Drusus himself declined all responsibility in connexion with carrying them out. He was rewarded for his services by the consulship (112), and the title of *patronus senatus*. He received Macedonia for his province, where he distinguished himself in a campaign against the Scordisci, whom he drove across the Danube, being the first Roman general who reached that river. It is possible that he is the Drusus mentioned by Plutarch as having died in 109, the year of his censorship.

Appian, *Bell. Civ. i.* 23; Plutarch, *Gaius Gracchus*, 8-11; Florus *iii.* 4; A. H. J. Greenidge, *Hist. of Rome*, vol. i. (1904).

His son, **MARCUS LIVIUS DRUSUS**, became tribune of the people in 91 B.C. He was a thoroughgoing conservative, wealthy and generous, and a man of high integrity. With some of the more intelligent members of his party (such as Marcus Scaurus and L. Licinius Crassus the orator) he recognized the need of reform. At that time an agitation was going on for the transfer of the judicial functions from the equites to the senate; Drusus proposed as a compromise a measure which restored to the senate the office of judges, while its numbers were doubled by the admission of 300 equites. Further, a special commission was to be appointed to try and sentence all judges guilty of taking bribes. But the senate was lukewarm, and the equites, whose occupation was threatened, offered the most violent opposition. In order, therefore, to catch the popular votes, Drusus proposed the establishment of colonies in Italy and Sicily, and an increased distribution of corn at a reduced rate. By help of these riders the bill was carried. Drusus now sought a closer alliance with the Italians, promising them the long-coveted boon of the Roman franchise. The senate broke out into open opposition. His laws were abrogated as informal, and each party armed its adherents for the civil struggle which was now inevitable. Drusus was stabbed one evening as he was returning home. His assassin was never discovered.

See Rome: *History*, ii. "The Republic" (Period C); also Appian, *Bell. Civ. i.* 35; Florus *iii.* 17; Diod. Sic. *xxxvii.* 10; Livy, *Eph.* 70; Vell. Pat. *ii.* 13.

DRUSUS, NERO¹ CLAUDIUS (38-9 B.C.) Roman general, son of Tiberius Claudius Nero and Livia Drusilla, stepson of Augustus and younger brother of the emperor Tiberius. Having held the office of quaestor and acted as praetor for his brother during the latter's absence in Gaul, he began (in 15 B.C.) the military career which has made his name famous. In conjunction with Tiberius, he carried on a successful campaign against the Raeti and Vindelici, who, although repulsed from Italy, continued to threaten the frontiers of Gaul. The credit of the decisive victory, however, must be assigned to Tiberius. Two of the *Odes* of Horace (*iv.* 4 and 14) were written to glorify the exploits of the brothers. In 13 Drusus was sent as governor to the newly organized province of the three Gauls, where considerable discontent had been aroused by the exactions of the Roman governor Licinius. Drusus made a fresh assessment for taxation purposes, and summoned the Gallic representatives to a meeting at Lugdunum to discuss their grievances. It was of great importance to pacify the Gauls, in order to have his hands free to deal with the German tribes, one of which, the Sugambri, on the right bank of the Rhine, had seized the opportunity, during the absence of Augustus, to cross the river (12). Drusus drove them back and pursued them through the island of the Batavi and the land of the Usipetes (Usipes, Usipii) to their own territory, which he devastated. Sailing down the Rhine, he subdued the Frisii and, in order to facilitate operations against the Chauci, dug a canal (Fossa Drusiana) leading from the Rhenus (Rhine) to the Isala (Yssel)² into the lacus Flevis (Zuidersee) and the German Ocean. Making his way along the Frisian coast, he conquered the island of Burchanis (*Borkum*), defeated the Brueteri in a naval engagement on the Amisia (*Ems*), and went on to the mouth of the Visurgis (*Weser*) to attack the Chauci. On the way back his vessels grounded on the shallows, and were only got off with the assistance of the Frisii. Winter being close at hand, the campaign was abandoned till the following spring, and Drusus returned to Rome with the honour of having been the first Roman general to reach the German Ocean.

In his second campaign (11), Drusus defeated the Usipetes, threw a bridge over the Luppia (*Lippe*), attacked the Sugambri, and advanced through their territory and that of the Tencteri and Chatti as far as the Weser, where he gained a victory over the Cherusci. Lack of provisions, the approach of winter, and an insuspicious portent prevented him from crossing the Weser. While making his way back to the Rhine he fell into an ambush, but the carelessness of the enemy enabled him to inflict a crushing defeat upon them. In view of future operations, he built two castles, one at the junction of the Luppia and Aliso (*Alme*), the other in the territory of the Chatti on the Taunus, near Moguntiacum (*Mainz*).

The third campaign (10) was of little importance. The Chatti had joined the Sugambri in revolt; and, after some insignificant successes, Drusus returned with Augustus and Tiberius to Rome, and was elected consul for the following year. In spite of unfavourable portents at Rome, he determined to enter upon his fourth and last campaign (9) without delay. He attacked and defeated the Chatti, Suebi, Marcomanni and Cherusci, crossed the Weser and penetrated as far as the Albia (*Elbe*). Here trophies were set up to mark the farthest point ever reached by a Roman army. Various measures were taken to secure the possession of the conquered territory: fortresses were erected along the Elbe, Weser and Maas (*Meuse, Mos*); a flotilla was placed upon the Rhine and a dam built upon the right arm of its estuary to increase the flow of water into the canal mentioned above. Drusus was said to have been deterred from crossing the Elbe by the sudden appearance of a woman of supernatural size, who predicted his approaching end. On his return, probably between the Elbe and the Saale (*Sala*), his horse stumbled and threw him. His leg was fractured and he died thirty days after the accident,

¹ Originally Decimus.

² The district extending from Westervoort to Doesborgh.

on the 14th of September. Suetonius mentions an absurd rumour that he had been poisoned by order of Augustus, because he had refused to obey the order for his recall. The body was carried to the winter quarters of the army, whence it was escorted by Tiberius to Rome, the procession being joined by Augustus at Ticinum (Pavia). Tiberius delivered an oration over the remains in the Forum, whence they were conveyed to the Campus Martius and cremated, and ashes being deposited in the mausoleum of Augustus.

Drusus was one of the most distinguished men of his time. His agreeable manners, handsome person and brilliant military talents gained him the affection of the troops, while his sympathy with republican principles, endeared him to the people. It is not too much to say that, had he and his son lived long enough, they might have brought about the abolition of the monarchy. Although the successes of Drusus, resulting in the subjection of the German tribes from the Rhine to the Elbe, were too rapid to be lasting, they brought home the fact of the existence of the Romans to many who had never heard their name. For his victories he received the title of Germanicus. He married Antonia, the daughter of Marcus Antonius the triumvir, by whom he had three children: Germanicus, adopted by Tiberius; Claudius, afterwards emperor; and a daughter Livilla.

The chief ancient authorities for the life of Drusus are Dio Cassius, the epitomes of Livy, Suetonius (*Claudius*), Tacitus (portions of the *Annals*), Florus (whose chief source is Livy), Velleius Paterculus, and the *Consolatio ad Liviam*. The German campaigns were described in the last books of Livy and the lost *Bella Germaniae* of the elder Pliny. As would naturally be expected, they have produced an extensive literature in Germany, J. Asbach's "Die Feldzüge des Nero Claudius Drusus" (*Rhein. Jahrb.* lxxxv. 14-30) being especially recommended; see also Mommsen's *History of the Roman Provinces*, I.; Merivale, *History of the Romans under the Empire*, ch. 36; A. Stein in Pauly-Wissowa's *Realencyclopädie* (1899), where other authorities are given; J. C. Tarver, *Tiberius the Tyrant* (1902).

DRUSUS CAESAR (c. 15 B.C.—A.D. 23), commonly called Drusus junior, to distinguish him from his uncle Nero Claudius Drusus, was the only son of the emperor Tiberius by his first wife Vipsania Agrippina. After having held several curule offices, he was consul elect in A.D. 14, the year of Augustus's death. His father, on his accession to the throne, immediately sent him to put down a mutiny of the troops in Pannonia, a task which he successfully accomplished (Tacitus, *Annals*, i. 24-30). As governor of Illyricum (17), he set the Germanic tribes against one another, and encouraged Catualda, chief of the Gothones, to drive out Marbod (Maroboduus), king of the Marcomanni. On his return Drusus was consul a second time (21) and in the following year received the tribunician authority from Tiberius, which practically indicated him as heir to the throne. Sejanus, who also aspired to the supreme power, determined to remove Drusus. He endeavoured to poison Tiberius's mind against him, seduced Drusus's wife and persuaded her to assist him in murdering her husband. Her physician Eudemus prepared and the eunuch Lygdus administered a slow poison, from the effects of which Drusus died after a lingering illness. Although Tiberius is said to have received the news of his death with indifference, there is no reason to suppose that he had any hand in it; indeed, he seems to have entertained a genuine affection for his son. Drusus was a man of violent passions, a drunkard and a debauchee, but not entirely devoid of better feelings, as is shown by his undoubtedly sincere grief at the death of Germanicus. The cunning and reserve which he exhibited on occasion were probably due to the instructions or influence of Tiberius (*Annals*, iii. 8), since he was himself naturally frank and open, and for this reason, notwithstanding his vices, more popular than his father. He revelled in bloody gladiatorial displays, and the sharpest swords used on such occasions were called "Drusine."

See Tacitus, *Annals*, i. 76, iv. 8-11; Dio Cassius *lvi.* 13, 14; Suetonius, *Tiberius*, 62; J. C. Tarver, *Tiberius the Tyrant* (1902).

DRYADES, or **HAMADRYADES**, in Greek mythology, nymphs of trees and woods. Each particular tree (*δρῦς*) was the home of its own special Dryad, of whom was supposed to be born and to die with it (*δρῦα*):

DRYANDER, JONAS (1748-1810), Swedish botanist, was born in 1748. By his uncle, Dr Lars Montin, to whom his education was entrusted, he was sent to the university of Gothenburg, whence he removed to Lund. After taking his degree there in 1776, he studied at Upsala under Linnæus, and then became for a time tutor to a young Swedish nobleman. He next visited England, and, on the death of his friend Dr Daniel Charles Solander (1736-1782), succeeded him as librarian to Sir Joseph Banks. He was librarian to the Royal Society and also to the Linnean Society. Of the latter, in 1788, he was one of the founders, and, when it was incorporated by royal charter in 1802, he took a leading part in drawing up its laws and regulations. He was vice-president of the society till his death, which took place in London on the 10th of October 1810. Besides papers in the Transactions of the Linnean and other societies, Dryander published *Dissertatio gradualis Jungos vegetabilis vindicans* (Lund, 1776), and *Catalogo bibliothecae naturalis Josephi Banks, Bart.* (London, 1796-1800, 5 vols.). He also edited the first and part of the second edition of W. Aiton's *Hortus Kewensis* and W. Roxburgh's *Plants of the Coast of Coromandel*.

DRYBURGH ABBEY, a monastic ruin in the extreme south-west of Berwickshire, Scotland, about 5 m. S.E. of Melrose, and $1\frac{1}{2}$ m. E. of St Boswells station on the North British railway's Waverley route from Edinburgh to Carlisle. The name has been derived from the Gaelic *darach bruaich*, "oak bank," in allusion to the fact that the Druids once practised their rites here. The abbey occupies the spot where, about 522, St Modan, an Irish Culdee, established a sanctuary—a secluded position on a tongue of land washed on three sides by the Tweed. Founded in 1150 by David I.—though it has also been ascribed to Hugh de Morville (d. 1162), lord of Lauderdale and constable of Scotland—it enjoyed great prosperity until 1322, when it was partially destroyed by the English under Edward II. It suffered again at the hands of Richard II. in 1385, and was reduced to ruin during the expedition of the earl of Hertford in 1545. After the Reformation the estate was erected into a temporal lordship and given (1604) by James VI. to John Erskine, 2nd earl of Mar. At a later date it was sold, but reverted to a branch of the Erskines in 1786, when it was acquired by the 11th earl of Buchan. In 1700 the abbey lands belonged to Thomas Haliburton, Scott's great-grandfather, and, but for an extravagant grand-uncle who became bankrupt and had to part with the property, they would have descended to Sir Walter by inheritance. "We have nothing left of Dryburgh," he said, "but the right of stretching our bones there." The style in general is Early English, but the west door and the restored entrance from the nave to the cloisters are fine examples of transitional Norman. Though in various stages of decay, nearly every one of the monastic buildings is represented by a fragment. Of the cruciform church—190 ft. long by 75 broad at the transepts—there remain some of the outer walls, a segment of the choir, the east aisle of the north transept, the stumps of some of the pillars of the nave, the west gable, the south transept and its adjacent chapel of St Modan. The most beautiful of these relics is St Mary's aisle of the north transept, in which were buried Sir Walter Scott (1832), his wife, son, his son-in-law John Gibson Lockhart, and his ancestors, the Haliburtons of New Mains. Sir Walter's tomb is a plain block of polished Peterhead granite, inscribed only with his name and the dates of his birth and death. The next aisle is the burial-place of the Erskines of Shielhill and the Haigs of Bemersyde. On the south side of the church, at a lower level, stand the cloisters, about 100 ft. square, bounded on the west by the dungeons, on the south-west by the cellars and refectory, in the west wall of which is an exquisite ivy-clad rose window, and on the east by the chapter-house, on a still lower level. The chapter-house, a lofty building with vaulted roof, is the most complete structure of the group, and adjoining it on the south are, first the abbot's parlour and then the library, the three apartments communicating with each other, and constituting the oldest portion of the abbey. In the grounds are many venerable trees, a yew near the chapter-house being at least coeval with the abbey.

DRYDEN, JOHN (1631-1700), English poet, born on or about the 9th of August, 1631, at Aldwinkle, in Northamptonshire, was of Cumberland stock, though his family had been settled for three generations in Northamptonshire, had acquired estates and a baronetcy, and intermarried with landed families in that county. His great-grandfather, who first carried the name south, and acquired by marriage the estate of Canons Ashby, is said to have known Erasmus, and to have been so proud of the great scholar's friendship that he gave the name of Erasmus to his eldest son. The name Erasmus was borne by the poet's father, the third son of Sir Erasmus Dryden. The leanings and connexions of the family were Puritan and anti-monarchical. Sir Erasmus Dryden went to prison rather than pay loan money to Charles I.; the poet's uncle, Sir John Dryden, and his father Erasmus, served on government commissions during the Commonwealth. His mother's family, the Pickerings, were still more prominent on the Puritan side. Sir Gilbert Pickering, his cousin, was chamberlain to the Protector, and was summoned to Cromwell's House of Lords in 1657. A trustworthy tradition asserts that John Dryden was born at the rectory of Aldwinkle All Saints, of which his maternal grandfather, Henry Pickering, was rector.

Dryden's education was such as became a scion of these respectable families of squires and rectors, among whom the chance contact with Erasmus had left a certain tradition of scholarship. His father, whose own fortune, added to his wife's, was not large, procured for the poet, who was the eldest of fourteen children, admission to Westminster school as a king's scholar, under the famous Dr Busby. Some elegiac verses which Dryden wrote there on the death of a schoolfellow, Henry, Lord Hastings, son of the earl of Huntingdon, in 1649, were published in *Lacrymæ Musarum*, among other elegies by "divers persons of nobility and worth" in commemoration of the same event. He appeared soon after again in print, among writers of commendatory verses to a friend of his, John Hoddesdon, who published a volume of *Epigrams* in 1650. Dryden's contribution is signed "John Dryden of Trinity C.," as he had gone up from Westminster to Cambridge in May 1650. He was elected a scholar of Trinity on the Westminster foundation in October of the same year, and took his degree of B.A. in 1654. The only recorded incident of his college residence is some unexplained act of disobedience to the vice-master, for which he was "put out of commons" and "gated" for a fortnight. His father died in 1654, leaving him master of two-thirds of a small estate near Blakesley, worth about £60 a year. The next three years he is said to have spent at Cambridge. In any case they were spent somewhere in study; for his first considerable poem bears indisputable marks of scholarly habits, as well as of a command of verse that could not have been acquired without practice.

The middle of 1657 is given as the date of his leaving the university to take up his residence in London. In one of his many subsequent literary quarrels, it was said by Shadwell that he had been clerk to Sir Gilbert Pickering, his cousin, who was chamberlain to Cromwell; and nothing is more likely than that he obtained some employment under his powerful cousin when he came to London. He is said to have lived at first in the house of his first publisher, Herringman, with whom he was connected till 1679, when Jacob Tonson began to publish his books. He first emerged from obscurity with his *Heroic Stanzas* (1659) to the memory of the Protector. That these stanzas should have made him a name as a poet does not appear surprising when we compare them with Waller's verses on the same occasion. Dryden took some time to consider them, and it was impossible that they should not give an impression of his intellectual strength. Donne was his model; it is obvious that both his ear and his imagination were saturated with Donne's elegiac strains when he wrote; yet when we look beneath the surface we find unmistakable traces that the pupil was not without decided theories that ran counter to the practice of the master. It is plainly not by accident that each stanza contains one clear-cut brilliant point. The poem is an academic exercise, and it seems to be animated by an under-current of strong contumacious protest against the

irregularities tolerated by the authorities. Dryden had studied the ancient classics for himself, and their method of uniformity and elaborate finish commended itself to his robust and orderly mind. In itself the poem is a magnificent tribute to the memory of Cromwell.

To those who regard the poet as a seer with a sacred mission, and refuse the name altogether to a literary manufacturer to order, it comes with a certain shock to find Dryden, the hereditary Puritan, the panegyrist of Cromwell, hailing the return of King Charles in *Astræa Redux* (1660), deploring his long absence, and proclaiming the despair with which he had seen "the rebel thrive, the loyal crost." A *Panegyric on the Coronation* followed in 1661. From a literary point of view also, *Astræa Redux* is inferior to the *Heroic Stanzas*.

Dryden was compelled to supplement his slender income by his writings. He naturally first thought of tragedy,—his own genius, as he has informed us, inclining him rather to that species of composition; and in the first year of the Restoration he wrote a tragedy on the fate of Henry, duke of Guise. But some friends advised him that its construction was not suited to the requirements of the stage, so he put it aside, and used only one scene of the original play later on, when he again attempted the subject with a more practised hand. Having failed to write a suitable tragedy, he next turned his attention to comedy, although, as he admitted, he had little natural turn for it. "I confess," he said, in a short essay in his own defence, printed before *The Indian Emperor*, "my chief endeavours are to delight the age in which I live. If the humour of this be for low comedy, small accidents and rallery, I will force my genius to obey it, though with more reputation I could write in verse. I know I am not so fitted by nature to write comedy; I want that gaiety of humour which is required to it. My conversation is slow and dull; my humour saturnine and reserved; in short, I am none of those who endeavour to break jests in company or make repartees. So that those who decry my comedies do me no injury, except it be in point of profit; reputation in them is the last thing to which I shall pretend." He was really as well as ostentatiously a playwright; the age demanded comedies, and he endeavoured to supply the kind of comedy that the age demanded. His first attempt was unsuccessful. Bustle, intrigue and coarsely humorous dialogue seemed to him to be part of the popular demand; and, looking about for a plot, he found something to suit him in a Spanish source, and wrote *The Wild Gallant*. The play was acted in February 1663, by Thomas Killigrew's company in Vere Street. It was not a success, and Pepys showed good judgment in pronouncing the play "so poor a thing as ever I saw in my life." Dryden never learned moderation in his humour; there is a student's clumsiness and extravagance in his indecency; the plays of Etherege, a man of the world, have not the uncouth riotousness of Dryden's. Of this he seems to have been conscious, for when the play was revived, in 1667, he complained in the epilogue of the difficulty of comic wit, and admitted the right of a common audience to judge of the wit's success. Dryden, indeed, took a lesson from the failure of *The Wild Gallant*; his next comedy, *The Rival Ladies*, also founded on a Spanish plot, produced before the end of 1663, and printed in the next year, was correctly described by Pepys as "a very innocent and most pretty witty play," though there was much in it which the taste of our time would consider indelicate. But he never quite conquered his tendency to extravagance. *The Wild Gallant* was not the only victim. *The Assignment, or Love in a Nunnery*, produced in 1673, shared the same fate; and even as late as 1680, when he had had twenty years' experience to guide him, *The Kind Keeper, or Mr Limberham* was prohibited, after three representations, as being too indecent for the stage. Dislike to indecency we are apt to think a somewhat ludicrous pretext to be made by Restoration playgoers, and probably there was some other reason for the sacrifice of *Limberham*; still there is a certain savageness in the spirit of Dryden's indecency which we do not find in his most licentious contemporaries. The undisciplined force of the man carried him to an excess from which more dexterous writers held back.

After the production of *The Rival Ladies* in 1663, Dryden assisted Sir Robert Howard in the composition of a tragedy in heroic verse, *The Indian Queen*, produced with great splendour in January 1664. He married Lady Elizabeth Howard, Sir Robert's sister and daughter of the 1st earl of Berkshire, on the 1st of December 1663. Lady Elizabeth's reputation was somewhat compromised before this union, which was not a happy one, and there is some evidence for the scandal in a letter written by her before her marriage to Philip, 2nd earl of Chesterfield. *The Indian Queen* was a great success, one of the greatest since the reopening of the theatres. This was in all likelihood due much less to the heroic verse and the exclusion of comic scenes from the tragedy than to the magnificent scenic accessories—the battles and sacrifices on the stage, the spirits singing in the air, and the god of dreams ascending through a trap. The novelty of these Indian spectacles, as well as of the Indian characters, with the splendid Queen Zempoalla, acted by Mrs Marshall in a real Indian dress of feathers presented to her by Mrs Aphra Behn, as the centre of the play, was the chief secret of the success of *The Indian Queen*. These melodramatic properties were so marked a novelty that they could not fail to draw the town. Dryden was tempted to return to tragedy; he followed up *The Indian Queen* with *The Indian Emperor, or the Conquest of Mexico by the Spaniards*, which was acted in 1665, and also proved a success.

But Dryden was not content with writing tragedies in rhymed verse. He took up the question of the propriety of rhyme in serious plays immediately after the success of *The Indian Queen*, in the preface to an edition (1664) of *The Rival Ladies*. In that first statement of his case, he considered the chief objection to the use of rhyme, and urged his chief argument in its favour. Rhyme was not natural, some people had said; to which he answers that it is as natural as blank verse, and that much of its unnaturalness is not the fault of the rhyme but of the writer, who has not sufficient command of language to rhyme easily. In favour of rhyme he has to say that it at once stimulates the imagination, and prevents it from being too discursive in its flights.

During the Great Plague, when the theatres were closed, and Dryden was living at Charlton, Wiltshire, at the seat of his father-in-law, the earl of Berkshire, he occupied a considerable part of his time in thinking over the principles of dramatic composition, and threw his conclusions into the form of a dialogue, which he called an *Essay of Dramatick Poesie* and published in 1668. The essay takes the form of a dialogue between Neander (Dryden), Eugenius (Charles, Lord Buckhurst, afterwards earl of Dorset), Crites (Sir R. Howard), and Lisideius (Sir C. Sedley), who is made responsible for the famous definition of a play as a "just and lively image of human nature, representing its passions and humours, and the changes of fortune to which it is subject, for the delight and instruction of mankind." Dryden's form is of course borrowed from the ancients, and his main source is the critical work of Corneille in the prefaces and discourses contained in the edition of 1660, but he was well acquainted with the whole body of contemporary French and Spanish criticism. Crites maintains the superiority of the classical drama; Lisideius supports the exacting rules of French dramatic writing; Neander defends the English drama of the preceding generations, including, in a long speech, an examination of Ben Jonson's *Silent Woman*. Neander argues, however, that English drama has much to gain by the observance of exact methods of construction without abandoning entirely the liberty which English writers had always claimed. He then goes on to defend the use of rhyme in serious drama. Howard had argued against the use of rhyme in a "preface" to *Four New Plays* (1665), which had furnished the excuse for Dryden's essay. Howard replied to Dryden's essay in a preface to *The Duke of Lerma* (1668). Dryden at once replied in a masterpiece of sarcastic retort and vigorous reasoning, *A Defence of an Essay of Dramatick Poesie*, prefixed to the second edition (1668) of *The Indian Emperor*. It is the ablest and most complete statement of his views about the employment of rhymed couplets in tragedy.

Before his return to town at the end of 1666, when the theatres (which had been closed during the disasters of 1665 and 1666) were reopened, Dryden wrote a poem on the Dutch war and the Great Fire entitled *Annus Mirabilis*. The poem is in quatrains, the metre of his *Heroic Stanzas* in praise of Cromwell, which Dryden chose, he tells us, "because he had ever judged it more noble and of greater dignity both for the sound and number than any other verse in use amongst us." The preface to the poem contains an interesting discussion of what he calls "wit-writing," introduced by the remark that "the composition of all poems is or ought to be of wit." His description of the Great Fire is a famous specimen of this wit-writing, much more careless and daring, and much more difficult to sympathize with, than the graver conceits in his panegyric of the Protector. In *Annus Mirabilis* the poet apostrophizes the newly founded Royal Society, of which he had been elected a member in 1662.

From the reopening of the theatres in 1666 till November 1681, the date of his *Absalom and Achitophel*, Dryden produced nothing but plays. The stage was his chief source of income. *Secret Love, or the Maiden Queen*, a tragi-comedy, produced in March 1667, was based on an episode in the *Artamène, ou le Grand Cyrus* of Mlle de Scudéry, the historical original of the "Maiden Queen" being Christina, queen of Sweden. The prologue claims that the piece is written with pains and thought, by the exactest rules, with strict observance of the unities, and "a mingled chime of Jonson's humour and of Corneille's rhyme"; but it owed its success chiefly to the charm of Nell Gwyn's acting in the part of Florimel. It is noticeable that only the more passionate parts of the dialogue are rhymed, Dryden's theory apparently being that rhyme is then demanded for the elevation of the style. His next play, *Sir Martin Mar-all, or the Feigned Innocence*, an adaptation in prose of the duke of Newcastle's translation of Molière's *L'Étourdi*, was produced at the Duke's theatre, without the author's name, in 1667. It was about this time that Dryden became a retained writer under contract for the King's theatre, receiving from it £300 or £400 a year, till it was burnt down in 1672, and about £200 for six years more till the beginning of 1678. His co-operation with Davenant in a new version (1667) of Shakespeare's *Tempest*—for his share in which Dryden can hardly be pardoned on the ground that the chief alterations were happy thoughts of Davenant's, seeing that he affirms he never worked at anything with more delight—must also be supposed to be anterior to the completion of his contract with the Theatre Royal. He was engaged to write three plays a year, and he contributed only ten plays during the ten years of his engagement, finally exhausting the patience of his partners by joining in the composition of a play for the rival house. In adapting *L'Étourdi*, Dryden did not catch Molière's lightness of touch; his alterations go towards making the comedy into a farce. Perhaps all the more on this account *Sir Martin Mar-all* had a great run at the theatre in Lincoln's Inn Fields. There is always a certain coarseness in Dryden's humour, apart from the coarseness of his age,—a certain forcible roughness of touch which belongs to the character of the man. His *An Evening's Love, or the Mock Astrologer*, an adaptation from *Le Feint Astrologue* of the younger Corneille, produced at the King's theatre in 1668, seemed to Pepys "very smutty, and nothing so good as *The Maiden Queen* or *The Indian Emperor* of Dryden's making." Evelyn thought it foolish and profane, and was grieved "to see how the stage was degenerated and polluted by the licentious times." *Ladits à la Mode*, another of Dryden's contract comedies, produced in 1668, was "so mean a thing," Pepys says, that it was only once acted, and Dryden never published it. Of his other comedies, *Marriage à la Mode* (produced 1672), *The Assignment, or Love in a Nunncery* (1673), *The Kind Keeper, or Mr Limberham* (1678), only the first was moderately successful.

While Dryden met with such indifferent success in his willing efforts to supply the demand of the age for low comedy, he struck upon a really popular and profitable vein in heroic tragedy. *Tyrannic Love, or the Royal Martyr*, a Roman play

dealing with the persecution of the Christians by Maximin, in which St Catherine is introduced, and with her some supernatural machinery, was produced in 1669. It is in rhymed couplets, but the author again did not trust solely for success to them; for, besides the magic incantations, the singing angels, and the view of Paradise, he made Nell Gwyn, who had stabbed herself as Valeria, start to life again as she was being carried off the stage, and speak a riotous epilogue, in violent contrast to the serious character of the play. *Almansor and Almahide, or the Conquest of Granada*, a tragedy in two parts, was written in 1669 to 1670. The historical background is taken chiefly from Mlle de Scudéry's romance of *Almahide*, but Dryden borrows freely from other books of hers and her contemporaries. This piece seems to have given the crowning touch of provocation to the wits, who had never ceased to ridicule the popular taste for these extravagant heroic plays. Dryden almost invited burlesque in his epilogue to the second part of *The Conquest of Granada*, in which he charged the comedy of the Elizabethan age with coarseness and mechanical humour, and its conceptions of love and honour with meanness, and claimed for his own time and his own plays an advance in these respects. *The Rehearsal*, written by the duke of Buckingham, with the assistance, it was said, of Samuel Butler, Martin Clifford, Thomas Sprat and others, and produced in 1671, was a severe and just punishment for this boast. Davenant was originally the hero, but on his death in 1668 the satire was turned upon Dryden, who is here unmercifully ridiculed under the name of Bayes, the name being justified by his appointment in 1670 as poet laureate and historiographer to the king (with a pension of £300 a year and a butt of canary wine). It is said that *The Rehearsal* was begun in 1663 and ready for representation before the plague. But this probably only means that Buckingham and his friends had resolved to burlesque the absurdities of Davenant's operatic heroes in *The Siege of Rhodes*, and the extravagant heroics of *The Indian Queen*. Materials accumulated upon them as the fashion continued, and by the time Dryden had produced his *Tyrannic Love*, and his *Conquest of Granada*, he had so established himself as the chief offender as to become naturally the central figure of the burlesque. Later Dryden fully avenged himself on Buckingham by his portrait of Zimri in *Absalom and Achitophel*. His immediate reply is contained in the preface "Of Heroic Plays" and the "Defence of the Epilogue," printed in the first edition (1672) of his *Conquest of Granada*. In these, so far from laughing with his censors, he addresses them from the eminence of success. "But I have already swept the stakes; and, with the common good fortune of prosperous gamblers, can be content to sit quietly; to hear my fortune cursed by some, and my faults arraigned by others, and to suffer both without reply." Heroic verse, he assures them, is so established that few tragedies are likely henceforward to be written in any other metre. In the course of a year or two *The Conquest of Granada* was attacked also by Elkanah Settle, on whom Dryden revenged himself later, making him the "Doeg" of the second part of *Absalom and Achitophel*.

His next tragedy, *Amboyna* (1673), an exhibition of certain atrocities committed by the Dutch on English merchants in the East Indies, put on the stage to inflame the public mind in view of the Dutch war, was written, with the exception of a few passages, in prose, and those passages in blank verse. An opera which he wrote in rhymed couplets, called *The State of Innocence, and Fall of Man*, an attempt to turn part of *Paradise Lost* into rhyme, as a proof of its superiority to blank verse, was prefaced by an "Apology for Heroique Poetry and Poetique Licence," and entered at Stationers' Hall in 1674, but it was never acted. The redeeming circumstance about the performance is the admiration professed by the adapter for his original, which he pronounces "undoubtedly one of the greatest, most noble and most sublime poems which either this age or nation has produced." Dryden is said to have had the elder poet's leave "to tag his verses." In *Aurengzebe*, which was Dryden's last, and also his best, rhymed tragedy, he borrowed from contemporary history, for the Great Mogul was still living. In the prologue

he confessed that he had grown weary of his long-loved mistress rhyme and retreated, with characteristic frankness, his disparaging contrast of the Elizabethan with his own age. But the stings of *The Rehearsal* had stimulated him to do his utmost to justify his devotion to his mistress, and he claims that *Aurengzebe* is "the most correct" of his plays. It was entered at Stationers' Hall and probably acted in 1675, and published in the following year.

After the production of *Aurengzebe* he seems to have rested for an interval from writing, enabled to do so, probably by an additional pension of £100 granted to him by the king. During this interval he would seem to have reconsidered the principles of dramatic composition, and to have made a particular study of the works of Shakespeare. The fruits of this appeared in *All for Love, or the World Well Lost*, a version of the story of Antony and Cleopatra, produced in 1678, which must be regarded as a very remarkable departure for a man of his age, and a wonderful proof of undiminished openness and plasticity of mind. In his previous writings on dramatic theory, Dryden, while admiring the rhyme of the French dramatists as an advance in art, did not give unqualified praise to the regularity of their plots; he was disposed to allow the irregular structure of the Elizabethan dramatists, as being more favourable to variety both of action and of character. But now, in frank imitation of Shakespeare, he abandoned rhyme, and, if we might judge from *All for Love*, and the precepts laid down in his "Grounds of Criticism in Tragedy," prefixed to *Troilus and Cressida* (1679), the chief point in which he aimed at excelling the Elizabethans was in giving greater unity to his plot. He upheld still the superiority of Shakespeare to the French dramatists in the delineation of character, but he thought that the scope of the action might be restricted, and the parts bound more closely together with advantage. *All for Love* and *Antony and Cleopatra* are two excellent plays for the comparison of the two methods. Dryden gave all his strength to *All for Love*, writing the play for himself, as he said, and not for the public. Carrying out the idea expressed in the title, he represents the two lovers as being more entirely under the dominion of love than Shakespeare's Antony and Cleopatra. Shakespeare's Antony is moved by other impulses than the passion for Cleopatra; it is his master motive, but it has to maintain a struggle for supremacy; "Roman thoughts" strike in upon him even in the very height of the enjoyment of his mistress's love, he chafes under the yoke, and breaks away from her of his own impulse at the call of spontaneously reawakened ambition. Dryden's Antony is so deeply sunk in love that no other impulse has power to stir him; it takes much persuasion and skilful artifice to detach him from Cleopatra even in thought, and his soul returns to her violently before the rupture has been completed. On the other hand, Dryden's Cleopatra is so completely enslaved by love for Antony that she is incapable of using the calculated caprices and meretricious coquetries which Shakespeare's Cleopatra deliberately practises as the highest art of love, the surest way of maintaining her empire over her great captain's heart. It is with difficulty that Dryden's Cleopatra will agree, on the earnest solicitation of a wily counsellor, to feign a liking for Dolabella to excite Antony's jealousy, and she cannot keep up the pretence through a few sentences. The characters of the two lovers are thus very much contracted, indeed almost overwhelmed, beneath the pressure of the one ruling motive. And as Dryden thus introduces a greater regularity of character into the drama, so he also very much contracts the action, in order to give probability to this temporary subjugation of individual character. The action of Dryden's play takes place wholly in Alexandria, within the compass of a few days; it does not, like Shakespeare's, extend over several years, and present incessant changes of scene. Dryden chooses, as it were, a fragment of a historical action, a single moment during which motives play within a narrow circle, the culminating point in the relations between his two personages. He devotes his whole play, also, to those relations; only what bears upon them is admitted. In Shakespeare's play we get a certain historical perspective, in which the love of Antony and Cleopatra

appears in its true proportions beneath the firmament that overhangs human affairs. In Dryden's play this love is our universe; all the other concerns of the world retire into a shadowy, indistinct background. If we rise from a comparison of the plays with an impression that the Elizabethan drama is a higher type of drama, taking Dryden's own definition of the word as "a just and lively image of human nature," we rise also with an impression of Dryden's power such as we get from nothing else that he had written since his *Heroic Stanzas*, twenty years before.

It was twelve years before Dryden produced another tragedy worthy of the power shown in *All for Love*. *Don Sebastian* was acted and published in 1690. In the interval, to sum up briefly Dryden's work as a dramatist, he wrote *Oedipus* (pr. 1679) and *The Duke of Guise* (pr. 1683) in conjunction with Nathaniel Lee; *Troilus and Cressida* (1679); *The Spanish Friar* (1681); *Albion and Albanus*, an opera (1685); *Amphitryon* (1690). In *Troilus and Cressida* he follows Shakespeare closely in the plot, but the dialogue is rewritten throughout, and not for the better. The versification and the language of the first and the third acts of *Oedipus*, which with the general plan of the play were Dryden's contribution to the joint work, bear marked evidence of his recent study of Shakespeare. *The Duke of Guise* provided an obvious parallel with contemporary English politics. Henry III. was identified with Charles II., and Monmouth with the duke. The lord chamberlain refused to license it until the political situation was less disturbed. The plot of *Don Sebastian* is more intricate than that of *All for Love*. It has also more of the characteristics of his heroic dramas; the extravagance of sentiment and the suddenness of impulse remind us occasionally of *The Indian Emperor*; but the characters are much more elaborately studied than in Dryden's earlier plays, and the verse is sinewy and powerful. It would be difficult to say whether *Don Sebastian* or *All for Love* is his best play; they share the palm between them. Dryden's subsequent plays are not remarkable. Their titles and dates are—*King Arthur*, an opera (1691), for which Purcell wrote the music; *Cleomenes* (1692); *Love Triumphant* (1694).

Soon after Dryden's abandonment of heroic couplets in tragedy, he found new and more congenial work for his favourite instrument in satire. As usual the idea was not original to Dryden, though he struck in with his majestic step and energy divine, and immediately took the lead. The pioneer was Mulgrave in his *Essay on Satire*, an attack on Rochester and the court, which was circulated in MS. in 1679. Dryden himself was suspected of the authorship, and it is not impossible that he gave some help in revising it; but it is not likely that he attacked the king on whom he was dependent for the greater part of his income, and Mulgrave in a note to his *Art of Poetry* in 1717 expressly asserts Dryden's ignorance. Dryden, however, was attacked in Rose Street, Covent Garden, and severely cudgelled by a company of ruffians who were generally supposed to have been hired by Rochester. In the same year Oldham's satire on the Jesuits had immense popularity, chiefly owing to the excitement about the Popish plot. Dryden took the field as a satirist towards the close of 1681, on the side of the court, at the moment when Shaftesbury, baffled in his efforts to exclude the duke of York from the throne as a papist, and secure the succession of the duke of Monmouth, was waiting his trial for high treason. *Absalom and Achitophel* produced a great stir. Nine editions were sold in rapid succession in the course of a year. There was no compunction in Dryden's ridicule and invective. Delicate wit was not one of Dryden's gifts; the motions of his weapon were sweeping, and the blows hard and trenchant. The advantage he had gained by his recent studies of character was fully used in his portraits of Shaftesbury and Buckingham, Achitophel and Zimri. In these portraits he shows considerable art in the introduction of redeeming traits to the general outline of malignity and depravity. It is not impossible that the fact that his pension had not been paid since the beginning of 1680 weighed with him in writing this satire to gain the favour of the court. In a play produced in 1681, *The Spanish Friar*, he had

written on the other side, gratifying the popular feeling by attacking the Roman Catholic priesthood.

Three other satires followed *Absalom and Achitophel*, one of them hardly inferior in point of literary power. *The Medal; a Satyre against Sedition* (March 1682) was written in ridicule of the medal struck to commemorate Shaftesbury's acquittal. Then Dryden had to take vengeance on the literary champions of the Whig party who had opened upon him with all their artillery. Their leader, Shadwell, had attacked him in *The Medal of John Bayes*, which Dryden answered in October 1682 by *Mac Flecknoe, or a Satyre upon the True-Blew Protestant Poet, T.S.* This satire, in which Shadwell filled the title-rôle, served as the model of the *Dunciad*. To the second part of *Absalom and Achitophel* (November 1682), written chiefly by Nahum Tate, he contributed a long passage of invective against Robert Ferguson, one of Monmouth's chief advisers, Elkanah Settle, Shadwell and others. *Religio Laici*, which appeared in the same month, though nominally an exposition of a layman's creed, and deservedly admired as such, was not without a political purpose. It attacked the Papists, but declared the "fanatics" to be still more dangerous.

Dryden's next poem in heroic couplets was in a different strain. On the accession of James, in 1685, he became a Roman Catholic. There has been much discussion as to whether this conversion was or was not sincere. It can only be said that the coincidence between his change of faith and his change of patron was suspicious, and that Dryden's character for consistency is certainly not of a kind to quench suspicion. The force of the coincidence cannot be removed by such pleas as that his wife had been a Roman Catholic for several years, or that he was converted by his son, who was converted at Cambridge, even if there were any evidence for these statements. Scott defended Dryden's conversion,—as Macaulay denounced it, from party motives. It is worth while, however, to notice that in his earlier defence of the English Church he exhibits a desire for the definite guidance of a presumably infallible creed, and the case for the Roman Church brought forward at the time may have appeared convincing to a mind singularly open to new impressions. At the same time nothing can be clearer than that Dryden always regarded his literary powers as a means of subsistence, and had little scruple about accepting a brief on any side. *The Hind and the Panther*, published in 1687, is an ingenious argument for Roman Catholicism, put into the mouth of "a milk-white hind, immortal and unchanged." There is considerable beauty in the picture of this tender creature, and its enemies in the forest are not spared. One can understand the admiration that the poem received when such allegories were in fashion. It was the chief cause of the veneration with which Dryden was regarded by Pope, who, himself educated in the Roman Catholic faith, was taken as a boy of twelve to see the veteran poet in his chair of honour and authority at Wills's coffee-house. It was also very open to ridicule, and was treated in this spirit by Prior and Montagu, the future earl of Halifax, in *The Hind and the Panther transposed to the story of the Country Mouse and the City Mouse*. Dryden's other literary services to James were a savage reply to Stillingfleet—who had attacked two papers published by the king immediately after his accession, one said to have been written by his late brother in advocacy of the Church of Rome, the other by his late wife explaining the reasons for her conversion—and a translation of a life of Xavier in prose. He had written also a panegyric of Charles, *Threnodia Augustalis*, and a poem in honour of the birth of James II.'s heir, under the title of *Briannia rediviva* (1688).

Dryden did not abjure his new faith on the Revolution, and so lost his office and pension as laureate and historiographer royal. For this act of constancy he deserves credit, if the new powers would have considered his services worth having after his frequent apostasies. His rival Shadwell reigned in his stead. Dryden was once more thrown mainly upon his pen for support. He turned again to the stage and wrote the plays already enumerated. A great feature in the last decade of his life was his translations from the classics. *Ovid's Epistles translated* appeared

in 1680; and numerous translations from Virgil, Horace, Ovid, Lucretius and Theocritus appeared in the four volumes of *Miscellany Poems—Miscellany Poems* (1684), *Sylvæ* (1685), *Examen poeticum* (1693), *The Annual Miscellany* (1694 by the "most eminent hands"); in 1693 was published the verse translation of the *Satires* of Juvenal and of Persius by "Mr Dryden and several other eminent hands," which contained his "Discourse concerning the Original and Progress of Satire"; and in 1697 Jacob Tonson published his most important translation, *The Works of Virgil*. The book, which was the result of three years' labour, was a vigorous, rather than a close, rendering of Virgil into the style of Dryden. Among other notable poems of this period are the two "Songs for St Cecilia's Day," written for a London musical society for 1687 and 1697, and published separately. The second of these is the famous ode on "Alexander's Feast." The well-known paraphrase of *Veni, Creator Spiritus* was posthumously printed, and his "Ode to the memory of Anne Killigrew," called by Dr Johnson the noblest ode in the language, was written in 1686.

His next work was to render some of Chaucer's and Boccaccio's tales and Ovid's *Metamorphoses* into his own verse. These translations appeared in November 1699, a few months before his death, and are known by the title of *Fables, Ancient and Modern*. The preface, which is an admirable example of Dryden's prose, contains an excellent appreciation of Chaucer, and, incidentally, an answer to Jeremy Collier's attack on the stage. Thus a large portion of the closing years of Dryden's life was spent in translating for bread. He had a windfall of 500 guineas from Lord Abingdon for a poem on the death of his wife in 1691, and he received liberal presents from his cousin John Driden and from the duke of Ormonde, but generally he was in considerable pecuniary straits. Besides, his three sons held various posts in the service of the pope at Rome, and he could not well be on good terms with both courts. However, he was not molested in London by the government, and in private he was treated with the respect due to his old age and his admitted position as the greatest of living English poets. He held a small court at Will's coffee-house, where he spent his evenings; here he had a chair by the fire in winter and by the window in summer; Congreve, Vanbrugh and Addison were among his admirers, and here Pope saw the old poet of whom he was to be the most brilliant disciple. He died at his house in Gerrard Street, London, on the 1st of May 1700 and was buried on the 13th of the month in Westminster Abbey. Dryden's portrait, by Sir G. Kneller, is in the National Portrait Gallery.

BIBLIOGRAPHY.—*The Comedies, Tragedies and Operas written by John Dryden, Esq.* (2 vols., 1701) was published by Tonson, who also issued the poet's *Dramatic Works* (6 vols., 1717), edited by Congreve. *Poems on Various Occasions and Translations from Several Authors* (1701), also published by Tonson, was very incomplete, and although other editions followed there was no satisfactory collection until the edition of the *Works* (18 vols., 1808, 2nd ed. 1821) by Sir Walter Scott, who supplied historical and critical notes with a life of the author. This, as revised and corrected by G. Saintsbury (18 vols., Edinburgh, 1882-1893), remains the standard edition. His *Critical and Miscellaneous Prose Works* (4 vols., 1800) were edited by Edmund Malone, who collected industriously the materials for a life of Dryden. Convenient partial modern editions are the *Poetical Works* (Globe edition, 1876) edited by W. D. Christie with an excellent "life"; *The Best Plays of John Dryden* (Mermaid series, 2 vols.), edited by G. Saintsbury; and *Essays of John Dryden* (2 vols., 1900, Oxford), edited by W. P. Ker. Besides the critical and biographical matter in these editions see Dr Johnson's *Lives of the Poets*; *Dryden* (English Men of Letters series, 1881), by G. Saintsbury; A. Beljame, *Le Public et les hommes de lettres en Angleterre 1660-1744* (2nd ed. Paris, 1897); A. W. Ward, *History of English Dramatic Literature* (new ed. 1899), vol. iii. pp. 346-392; J. Churton Collins, *Essays and Studies*; W. J. Courthope, *History of English Poetry*, vol. iv. (1903), chap. xiv., and L. N. Chasé, *The English Heroic Play* (New York, 1903). See also ENGLISH LITERATURE. (W. M.; M. B.)

DRYOPITHECUS (Gr. *δρῖς*, oak, *πίθηκος*, ape, "the ape of the oak-woods"), the name of an extinct ape or monkey from Miocene deposits of France, believed to be allied to the baboons, but perhaps with some affinity to the higher apes.

DRY ROT, a fungoid disease in timber which occasions the destruction of its fibres, and reduces it eventually to a mass of dry

dust. It is produced most readily in a warm, moist, stagnant atmosphere, while common or wet rot is the result of the exposure of wood to repeated changes of climatic conditions. The most formidable of the dry rot fungi is the species *Merulius lacrymans*, which is particularly destructive of coniferous wood; other species are *Polyporus hybridus*, which thrives in oak-built ships, and *P. destructor* and *Thelephora putcana*, found in a variety of wooden structures.

The felling of trees when void of fresh sap, as a means of obviating the rotting of timber, is a practice of very ancient origin. Vitruvius directs (ii. cap. 9) that, to secure good timber, trees should be cut to the pith, so as to allow of the escape of their sap, which by dying in the wood would injure its quality; also that felling should take place only from early autumn until the end of winter. The supposed superior quality of wood cut in winter, and the early practice in England of felling oak timber at that season, may be inferred from a statute of James I., which enacted "that no person or persons shall fell, or cause to be felled, any oaken trees meet to be barked, when bark is worth 2s. a cart-load (timber for the needful building and reparation of houses, ships or mills only excepted), but between the first day of April and last day of June, not even for the king's use, out of barking time, except for building or repairing his Majesty's houses or ships." In giving testimony before a committee of the House of Commons in March 1771, Mr Barnard of Deptford expressed it as his opinion that to secure durable timber for shipbuilding, trees should be barked in spring and not felled till the succeeding winter. In France, so long ago as 1669, a royal decree limited the felling of timber from the 1st of October to the 15th of April; and, in an order issued to the commissioners of forests, Napoleon I. directed that the felling of naval timber should take place only from November 1 to March 15, and during the decrease of the moon, on account of the rapid decay of timber, through the fermentation of its sap, if cut at other seasons. The burying of wood in water, which dissolves out or alters its putrescible constituents, has long been practised as a means of seasoning. The old "Resistance" frigate, which went down in Malta harbour, remained under water for some months, and on being raised was found to be entirely freed from the dry rot fungus that had previously covered her; similarly, in the ship "Eden," the progress of rot was completely arrested by 18 months' submergence in Plymouth Sound, so that after remaining a year at home in excellent condition she was sent out to the East Indies. It was an ancient practice in England to place timber for thrashing-floors and oak planks for wainscoting in running water to season them. Whale and other oils have been recommended for the preservation of wood; and in 1737 a patent for the employment of hot oil was taken out by a Mr Emerson.

For the modern processes of preserving timber see **TIMBER**.

DUALISM (from rare Lat. *dualis*, containing two, from *duo*), a philosophical term applied to all theories which attempt to explain facts by reference to two coexistent principles. The term plays an important part in metaphysical, ethical and theological speculation.

In Metaphysics.—Metaphysical dualism postulates the eternal coexistence of mind and matter, as opposed to monism both idealistic and materialistic. Two forms of this dualism are held. On the one hand it is said that mind and matter are absolutely heterogeneous, and, therefore, that any causal relation between them is *ex hypothesi* impossible. On the other hand is a hypothetical dualism, according to which it is held that mind cannot bridge over the chasm so far as to *know* matter *in itself*, though it is compelled by its own laws of cause and effect to postulate matter as the origin, if not the motive cause, of its sensations. It follows that, for the thinking mind, matter is a necessary hypothesis. Hence the theory is a kind of monism, inasmuch as it confessedly does not assert the existence of matter save as an intellectual postulate for the thinking mind. Matter, in other words, must be assumed to exist, though mind cannot know it *in itself*. From this question there emerges a second and more difficult problem. Consciousness, it is held, is of two

main kinds, sensation and reason. Sensation alone is insufficient to explain all our intellectual phenomena; all sensation is momentary and individual (cf. EMPIRICISM). How then are we to account for memory and the principles of necessity, similarity, universality? It is argued that there must be in the mind an enduring, primary faculty whereby we retain, compare and group the presentations of sense. This faculty is *a priori*, transcendental, and entirely separate from all the data of experience and sense-perception. Here then we have a dualism within experience. The mind is not to be regarded as a sensitized film which automatically records the impressions of the senses. It contains within itself this modifying critical faculty which reacts upon and arranges the sense-given presentations.

In Ethics and Theology.—In the domain of morals, dualism postulates the separate existence of Good and Evil, as principles of existence. In theology the appearance of dualism is sporadic and has not the fundamental, determining importance which it has in metaphysics. It is a result rather than a starting-point. The old Zoroastrianism, and those Christian sects (e.g. Manichaeism) which were influenced by it, postulate two contending deities Ormuzd and Ahriman (Good and Evil), which war against one another in influencing the conduct of men. So, in Christianity, the existence of Satan as an evil influence, antagonistic to God, involves a kind of dualism. But generally speaking this dualism is permissive, inasmuch as it is always held that God will triumph over Satan in His own time. So in Zoroastrianism the dualism is not ultimate, for Ahriman and Ormuzd are represented as the twin sons of Zervana Akarana, i.e. limitless time, wherein both will be finally absorbed. The postulate of an Evil Being arises from the difficulty, at all times acutely felt by a certain type of mind, of reconciling the existence of evil with the divine attributes of perfect goodness, full knowledge and infinite power. John Stuart Mill (*Essay on Religion*) preferred to disbelieve in the omnipotence of God rather than forgo the belief in His goodness. It follows from such a view that Satan is not the creation of God, but rather a power coeval in origin, over whose activity God has no absolute control.

In Theology.—Dualism is also used in a special theological sense to describe a doctrine of the Nestorian heresy. According to this doctrine the personality of Christ is twofold; the divine Logos dwells as a distinct personality in the man Jesus Christ, the union of the two natures being analogous to the relation between the believer and the indwelling Holy Spirit.

History of the Doctrine.—The earliest European thinkers (see IONIAN SCHOOL OF PHILOSOPHY) endeavoured to reduce all the facts of the universe to a single material origin, such as Fire, Water, Air. It is only gradually that there appears any recognition of a spiritual principle exercising a modifying or causal influence over inert matter. Anaxagoras was the first to postulate the existence of Reason (*νοῦς*) as the source of change and progress. Yet even he did not conceive this Reason as incorporeal; it was in reality only the most highly rarefied form of matter in existence. In Plato for the first time we find a truly dualistic conception of the universe. Asserting that Ideas alone really exist, he yet found it necessary to postulate a second principle of not-being, the groundwork of sensuous existence and of imperfection and evil. Herein he identified metaphysics and ethics, combining the good with the truly existent and evil with the non-existent. Aristotle rebels against this conception and substitutes the idea of *πρώτη ὄλη* and development. Nevertheless he does not escape from the dualism of Form and Matter, *νοῦς* and *ὄλη*. The scholastic philosophers naturally held dualistic views resulting from their extreme devotion to formalism. This blind dualism found its natural consequence in the revolt of the Renaissance thinkers, Bruno and Paracelsus, who asserted the unity of mind and matter in all existence and were the precursors of the more intelligent monism of Leibnitz and the scientific metaphysics of his successors. The birth of modern physical science on the other hand in the investigations of Bacon and Descartes obscured the metaphysical issue by the predominance of the mechanical principles of natural philosophy. They attempted to explain

the fundamental problems of existence by the unaided evidence of the new natural science. Thus Descartes maintained the absolute dualism of the *res cogitans* and the *res extensa*. Spinoza realized the flaw in the division and preferred to postulate behind mind and matter a single substance (*unica substantia*) while Leibnitz explained the universe as a harmony of spiritual or semispiritual principles. Kant practically abandons the problem. He never really establishes a relation between pure reason and things-in-themselves (*Dinge an sich*), but rather seeks refuge in a dualism within consciousness, the transcendental and the empirical. Since Kant there are, therefore, two streams of dualism, dealing, one with the radical problem of the relation between mind and matter, the other with the relation between the pure rational and the empirical elements within consciousness. To the first problem there is one obvious and conclusive answer, namely that matter in itself is inherently unthinkable and comes within the vision of the mind only as an intellectual presentation. It follows that philosophy is in a sense both dualist and monist; it is a cosmic dualism inasmuch as it admits the possible existence of matter as a hypothesis, though it denies the possibility of any true knowledge of it, and is hence in regard of the only possible knowledge an idealistic monism. It is a self-destructive dualism, a confessedly one-sided monism, agnostic as to the fundamental problem. To the second problem there are two main answers, that of Associationism which denies to the mind any *a priori* existence and asserts that sensation is the only source of knowledge, and that which admits the existence of both transcendental and empirical knowledge.

DUALLA, one of the principal negro peoples of Cameroon estuary, West Africa. When the Germans established themselves in that region, the Dualla were under many petty chiefs, whose domains were usually restricted to one village. Over these were two greater chiefs, Bell (Mbeli) and Akwa, representing the principal families of the tribe. The Dualla are physically a fine race. They are proud of their racial purity, and it was formerly usual for all half-caste children to be strangled at birth. The Dualla tattoo themselves, the women the whole body, the men the face only. They also pull out their eyelashes, which they believe prevent sharp sight. The monarchical system is more developed among the Dualla than any other of the peoples of Cameroon. The kings, many of whom have grown rich through trade, retain part of their former power, subject to the German government. The Dualla, who are laborious, industrious and capable of great physical endurance, are great traders and are proportionately prosperous. The average price for a wife among the Dualla is from £90 to £120; but sometimes a great deal more is paid. Girls are usually betrothed young and may be divorced if sterile. The penalty for adultery is a fine imposed on the seducer; if he cannot pay he becomes the husband's slave. Cannibalism as a religious rite was formerly common among the Dualla. All accessions to power were preceded by a sacrifice, a king having no authority till his hands were stained with blood. The religion is fetish blended with ancestor-worship, and certain secret societies exist among them which seem to have a religious connexion. The dead are buried within the hut, which is abandoned shortly afterwards; slaves were formerly buried with men of importance. Missionary efforts have yielded many converts, and some churches have been built. Many of the natives can read. The Dualla are in possession of an interesting code, in accordance with which messages can be sent and even conversations maintained by means of drums, or rather gongs, giving two notes. (See CAMEROON.)

DU BARRY, MARIE JEANNE BÉCU, COMTESSE (1746-1793), French adventuress, mistress of Louis XV., was the natural daughter of a poor woman of Vaucouleurs, and was born there on the 19th of August 1746. Placed in a convent in Paris at an early age, she received a very slight education, learning little but the catechism and drawing; and at the age of sixteen entered a milliner's shop in the rue St Honoré. Subsequently she lived as a courtesan under the name of Mdle Lange. Her great personal charms led the adventurer Jean, comte du Barry, to take her into his house in order to make it more

attractive to the dupes whose money he won by gambling. Her success surpassing his expectations, his hopes took a higher flight, and through Label, valet de chambre of Louis XV., and the duc de Richelieu, he succeeded in installing her as mistress of the king. In order to present her at court it was necessary to find a title for her, and as Count Jean du Barry was married himself his brother Guillaume offered himself as nominal husband. The comtesse du Barry was presented at court on the 22nd of April 1769, and became official mistress of the king. Her influence over the monarch was absolute until his death, and courtiers and ministers were in favour or disgrace with him in exact accordance with her wishes. The duc de Choiseul, who refused to acknowledge her, was disgraced in 1771; and the duc d'Aiguillon, who had the reputation of being her lover, took his place, and in concert with her governed the monarch. Louis XV. built for her the magnificent mansion of Luciennes. At his death in 1774 an order of his successor banished her to the abbey of Pont-aux-Dames, near Meaux, but, the queen interceding for her, the king in the following year gave her permission to reside at Luciennes with a pension. Here she led a retired life with the comte de Cosé-Briassac, and was visited there by Benjamin Franklin and the emperor Joseph II., among many other distinguished men. Having gone to England in 1792 to endeavour to raise money on her jewels, she was on her return accused before the Revolutionary Tribunal of having dissipated the treasures of the state, conspired against the republic, and worn, in London, "mourning for the tyrant." She was condemned to death on the 7th of December 1793, and beheaded the same evening. Her contemporaries, scorning her low birth rather than her vices, attributed to her a malicious political rôle of which she was at heart incapable, and have done scant justice to her quick wit, her frank but gracious manners, and her seductive beauty. The volume of *Lettres et Anecdotes* (1779) which bears her name was not written by her.

See E. and J. de Goncourt, *La du Barry* (Paris, 1880); C. Vatel, *Histoire de Madame du Barry* (1882-1883), based on sources; R. Douglas, *The Life and Times of Madame du Barry* (London, 1896).

DU BARTAS, GUILLAUME DE SALUSTE, SEIGNEUR (1544-1590), French poet, was born near Auch in 1544. He was employed by Henry IV. of France in England, Denmark and Scotland; and he commanded a troop of horse in Gascony, under the marshal de Martingan. He was a convinced Huguenot, and cherished the idea of writing a great religious epic in which biblical characters and Christian sentiment were to supplant the pagan *mise en scène* then in fashion. His first epic, *Judith*, appeared in a volume entitled *La Muse chrétienne* (Bordeaux, 1573). This was followed five years later by his principal work, *La Sepmaine*, a poem on the creation of the world. This work was held by admirers of du Bartas to put him on a level with Ronsard, and thirty editions of it were printed within six years after its appearance. Its religious tone and fanciful style made it a great favourite in England, where the author was called the "divine" du Bartas, and placed on an equality with Ariosto. Spenser, Hall and Ben Jonson, all speak in the highest terms of what seems to us a most uninteresting poem. King James VI. of Scotland tried his "prentice hand" at the translation of du Bartas's poem *L'Uranie*, and the compliment was returned by the French writer, who translated, as *La Lepanthé*, James's poem on the battle of Lepanto. Du Bartas began the publication of the *Seconde Semaine* in 1584. He aimed at a great epic which should stretch from the story of the creation to the coming of the Messiah. Of this great scheme he only executed a part, marked by a certain elevation of style, but he did not succeed in acclimatizing the religious epic in France. The work is spoiled by a constant tendency to moralize, and is filled with the indiscriminate information that passed under the name of science in the 16th century. Du Bartas, perhaps more than any other writer, brought the Ronsardist tradition into dispute. He introduced many unwieldy compounds foreign to the genius of the French language, and in his borrowings from old French, from provincial dialects and from Latin, he failed to show the sure instinct and prudence of Ronsard and du Bellay. He was

also guilty of reduplicating the first syllables of words, producing such expressions as *pépétiller, sousoufflamies*. Du Bartas died in July 1590 in Paris from wounds received at the battle of Ivry.

Joshua Sylvester translated the *Sepmaine* in 1598; other English translations from du Bartas are *The Historie of Judith* . . . (1584), by Thomas Hudson; of portions of the "Weeks" (1625) by William Lisle (1560-1637); the Anglo-Saxon scholar; *Uranus* (1580), by Robert Ashley (1565-1641); and Sir Philip Sidney (see Florio's dedication of the second book of his translation of Montaigne to Lady Rich) wrote a translation of the first "Week," which is lost. The *Œuvres complètes* of du Bartas were printed at Paris (1579), Paris and Bordeaux (1611). See also G. Pellissier, *La Vie et les œuvres de du Bartas* (1883).

DUBAWNT, or DOOBAUNT (Indian *Toobawng*, i.e. turbid), a river of Mackenzie and Keewatin districts, Canada. It rises in Wholdaia (or Daly) Lake, in 104° 20' W. and 66° 15' N., and flows northward to its confluence with the Thelon river, and thence eastward to Chesterfield Inlet, an arm of Hudson Bay. It passes through numerous lake-expansions, including Dubawnt Lake, with an area of 1790 sq. m. and an altitude of 500 ft. above the sea; Aberdeen, altitude 130 ft.; and Baker, 30 ft. From the head of Wholdaia Lake to the head of Chesterfield Inlet is 750 m. and thence to the west coast of Hudson Bay 125 m. The river is shallow, and banks and bed are chiefly composed of boulders; grassy slopes, however, occur at intervals along its banks, especially on the shores of Dubawnt Lake, and are the feeding grounds of large bands of cariboo. Discovered in 1770 by Samuel Hearne, the Dubawnt was explored by J. B. Tyrrell in 1893, and the Thelon by David Hanbury in 1899.

See *Annual Report of the Geological Survey of Canada for 1896* (printed 1898).

DUBBO, a municipal town of Lincoln county, New South Wales, Australia, on the Macquarie river, 278 m. by rail N.W. of Sydney. Pop. (1901) 3409. It is a flourishing manufacturing town in a pastoral district, in part also cultivated. Coal and copper are found in the neighbourhood.

DU BELLAY, GUILLAUME, SIEUR DE LANGEY (1491-1543), French soldier and diplomat, was born at the château of Glatigny, near Montmirail, in 1491. His father, Louis du Bellay-Langey, was a younger son of the Angevin family of du Bellay, which from the 14th century was distinguished in the service of the dukes of Anjou and afterwards of the kings of France; and Louis had six sons, who were among the best servants of Francis I. Guillaume, the eldest, is one of the most remarkable figures of the time; a brave soldier, a humanist and a historian, he was above all the most able diplomat at the command of Francis I., prodigiously active, and excelling in secret negotiations. He entered the military service at an early age, was taken prisoner at Pavia (1525) and shared the captivity of Francis I. His skill and devotion attached him to the king. His missions to Spain, Italy, England and Germany were innumerable; sent three times to England in 1520-1530, he was occupied with the execution of the treaty of Cambrai and also with the question of Henry VIII.'s divorce, and with the help of his brother Jean, then bishop of Paris, he obtained a decision favourable to Henry VIII. from the Sorbonne (July 2, 1530). From 1532 to 1536, though he went three times to England, he was principally employed in uniting the German princes against Charles V.; in May 1532 he signed the treaty of Scheyern with the dukes of Bavaria, the landgrave of Hesse, and the elector of Saxony, and in January 1534 the treaty of Augsburg. During the war of 1537 Francis I. sent him on missions to Piedmont; he was governor of Turin from December 1537 till the end of 1539, and subsequently replacing Marshal d'Annebaut as governor of the whole of Piedmont, he displayed great capacity in organization. But at the end of 1542, overwhelmed by work, he was compelled to return to France, and died near Lyons on the 9th of February 1543. Rabelais, an eye-witness, has left a moving story of his death (*Pantagruel*, iii. ch. 21, and iv. ch. 27). He was buried in the cathedral of Le Mans, where a monument was erected to his memory, with the inscription, "Ci gît Langey, dont la plume et l'épée ont surmonté Cicéron et Pompée"; Charles V. is said to have remarked that Langey, by his own unaided efforts,

did more mischief and thwarted more schemes than all the French together.

Guillaume du Bellay was the devoted protector of freedom of thought; without actually joining the reformers, he defended the innovators against their fanatical opponents. In 1534-1535 he even tried, unsuccessfully, to bring about a meeting between Francis I. and Melancthon; and in 1541 he intervened in favour of the Vaudois. Rabelais was the most famous of his clients, and followed him to Piedmont from 1540 to 1542. Guillaume was himself a valuable historian, and a clear and precise writer. He imitated Livy in his *Ogdoades*, a history of the rivalry between Francis I. and the emperor from 1521, of which, though he had no time to finish it, important fragments remain, inserted by his brother Martin du Bellay (d. 1550) in his *Mémoires* (1569). The celebrated *Instructions*, reprinted as *Traité de la discipline militaire* in 1554 and 1592, was formerly attributed to him, but it has been proved that he could not have written it (see Bayle, *Dict. Hist.* i. 502, and Jähns, *Geschichte der Kriegswissenschaften*, i. 498 seq.); this work, however, is of the highest value for the study of the military art of the 16th century; in 1550 an Italian, in 1567 a Spanish, and in 1594 and 1619 German translations were published.

See also the edition of Martin du Bellay's *Mémoires* by Michaud and Poujoulat (1838), and Bourrilly's *Fragment de la première Ogdoade* (Paris, 1905). There is an excellent study of Guillaume du Bellay by V. L. Bourrilly (Paris, 1905).

DU BELLAY, JEAN (c. 1493-1560), French cardinal and diplomat, younger brother of Guillaume du Bellay, appears as bishop of Bayonne in 1536, member of the privy council in 1530, and bishop of Paris in 1532. Supple and clever, he was well fitted for a diplomatic career, and carried out several missions in England (1527-1534) and Rome (1534-1536). In 1535 he received his cardinal's hat; in 1536-1537 he was nominated "lieutenant-general" to the king at Paris and in the Île de France, and was entrusted with the organization of the defence against the imperialists. When Guillaume du Bellay went to Piedmont, Jean was put in charge of the negotiations with the German Protestants, principally through the humanist Johann Sturm and the historian Johann Sleidan. In the last years of the reign of Francis I., cardinal du Bellay was in favour with the duchesse d'Étampes, and received a number of benefices—the bishopric of Limoges (1541), archbishopric of Bordeaux (1544), bishopric of Le Mans (1546); but his influence in the council was supplanted by that of Cardinal de Tournon. Under Henry II., being involved in the disgrace of all the servants of Francis I., he was sent to Rome (1547), and he obtained eight votes in the conclave which followed the death of Pope Paul III. After three quiet years passed in retirement in France (1550-1553), he was charged with a new mission to Pope Julius III. and took with him to Rome his young cousin the poet Joachim du Bellay (q.v.). He lived in Rome therefore in great state. In 1555 he was nominated bishop of Ostia and dean of the Sacred College, an appointment which was disapproved of by Henry II. and brought him into fresh disgrace, lasting till his death in Rome on the 16th of February 1560. Less resolute and reliable than his brother Guillaume, the cardinal had brilliant qualities, and an open and free mind. He was on the side of toleration and protected the reformers. Budaeus was his friend, Rabelais his faithful secretary and doctor; men of letters, like Étienne Dolet, and the poet Salmon Macrin, were indebted to him for assistance. An orator and writer of Latin verse, he left three books of graceful Latin poems (printed with Salmon Macrin's *Odes*, 1546, by R. Estienne), and some other compositions, including *Francisci Francorum regis epistola apologetica* (1542). His voluminous correspondence, mostly in MS., is remarkable for its *verve* and picturesque quality.

BIBLIOGRAPHY.—The Bibliothèque Nationale at Paris has numerous unpublished letters of Jean du Bellay. See also Ribier, *Lettres et mémoires d'estat* (Paris, 1660); V. L. Bourrilly and P. de Vaisière, *Ambassade de Jean du Bellay en Angleterre*, vol. i. (Paris, 1895); Marquis de la Jonquière, *Le Cardinal du Bellay* (Alençon, 1897); Heulhard, *Rabelais, ses voyages en Italie* (Paris, 1891); Chamard, *Joachim du Bellay* (Lille, 1900); V. L. Bourrilly, *Guillaume du Bellay* (Paris, 1905); "Jean du Bellay, les protestants et la Sorbonne"

in the *Bulletin du Protestantisme français* (1903, 1904); and "Jean Sleidan et le Cardinal du Bellay," in the *Bulletin*, &c. (1901, 1906). (J. I.)

DU BELLAY, JOACHIM (c. 1522-1560), French poet and critic, member of the Pléiade, was born¹ at the château de La Turmelière, not far from Liré, near Angers, being the son of Jean du Bellay, seigneur de Gonnor, cousin-german of the cardinal Jean du Bellay and of Guillaume du Bellay. Both his parents died while he was still a child, and he was left to the guardianship of his elder brother, René du Bellay, who neglected his education, leaving him to run wild at La Turmelière. When he was twenty-three, however, he received permission to go to Poitiers to study law, no doubt with a view to his obtaining perferment through his kinsman the Cardinal Jean du Bellay. At Poitiers he came in contact with the humanist Marc Antoine Muret, and with Jean Salmon Macrin (1490-1557), a Latin poet famous in his day. There too he probably met Jacques Peletier du Mans, who had published a translation of the *Ars poetica* of Horace, with a preface in which much of the programme advocated later by the Pléiade is to be found in outline.

It was probably in 1547 that du Bellay met Ronsard in an inn on the way to Poitiers, an event which may justly be regarded as the starting-point of the French school of Renaissance poetry. The two had much in common, and immediately became fast friends. Du Bellay returned with Ronsard to Paris to join the circle of students of the humanities attached to Jean Daurat (q.v.) at the Collège de Coqueret. While Ronsard and Antoine de Baif were most influenced by Greek models, du Bellay was more especially a Latinist, and perhaps his preference for a language so nearly connected with his own had some part in determining the more national and familiar note of his poetry. In 1548 appeared the *Art poétique* of Thomas Sibilet, who enunciated many of the ideas that Ronsard and his followers had at heart, though with essential differences in the point of view, since he held up as models Clément Marot and his disciples. Ronsard and his friends dissented violently from Sibilet on this and other points, and they doubtless felt a natural resentment at finding their ideas forestalled and, moreover, inadequately presented. The famous manifesto of the Pléiade, the *Defence et illustration de la langue francoyse* (1549), was at once a complement and a refutation of Sibilet's treatise. This book was the expression of the literary principles of the Pléiade as a whole, but although Ronsard was the chosen leader, its redaction was entrusted to du Bellay. To obtain a clear view of the reforms aimed at by the Pléiade, the *Defence* should be further considered in connexion with Ronsard's *Abrégé d'art poétique* and his preface to the *Franciade*. Du Bellay maintained that the French language as it was then constituted was too poor to serve as a medium for the higher forms of poetry, but he contended that by proper cultivation it might be brought on a level with the classical tongues. He condemned those who despaired of their mother tongue, and used Latin for their more serious and ambitious work. For translations from the ancients he would substitute imitations. Not only were the forms of classical poetry to be imitated, but a separate poetic language and style, distinct from those employed in prose, were to be used. The French language was to be enriched by a development of its internal resources and by discreet borrowing from the Latin and Greek. Both du Bellay and Ronsard laid stress on the necessity of prudence in these borrowings, and both repudiated the charge of wishing to latinize their mother tongue. The book was a spirited defence of poetry and of the possibilities of the French language; it was also a declaration of war on those writers who held less heroic views.

The violent attacks made by du Bellay on Marot and his followers, and on Sibilet, did not go unanswered. Sibilet replied in the preface to his translation (1549) of the *Iphigenia* of Euripides; Guillaume des Autels, a Lyonnese poet, reproached du Bellay with ingratitude to his predecessors, and showed the weakness of his argument for imitation as opposed to translation in a digression in his *Réplique aux furieuses defenses de Louis Meigret* (Lyons, 1550); Barthélémy Aneau, regent of the

¹For the date of his birth, commonly given as 1525, see H. Chamard, *Joachim du Bellay* (Lille, 1900).

Collège de la Trinité at Lyons, attacked him in his *Quintil Horatian* (Lyons, 1551), the authorship of which was commonly attributed to Charles Fontaine. Aneau pointed out the obvious inconsistency of inculcating imitation of the ancients and depreciating native poets in a work professing to be a defence of the French language. Du Bellay replied to his various assailants in a preface to the second edition (1550) of his sonnet sequence *Olive*, with which he also published two polemical poems, the *Musagnæomachie*, and an ode addressed to Ronsard, *Contre les envieux poètes*. *Olive*, a collection of love-sonnets written in close imitation of Petrarch, first appeared in 1549. With it were printed thirteen odes entitled *Versa lyriques*. *Olive* has been supposed to be an anagram for the name of a Mlle Viole, but there is little evidence of real passion in the poems, and they may perhaps be regarded as a Petrarchan exercise, especially as, in the second edition, the dedication to his lady is exchanged for one to Marguerite de Valois, sister of Henry II. Du Bellay did not actually introduce the sonnet into French poetry, but he acclimatized it; and when the fashion of sonnetteering became a mania he was one of the first to ridicule its excesses.

About this time du Bellay had a serious illness of two years' duration, from which dates the beginning of his deafness. He had further anxieties in the guardianship of his nephew. The boy died in 1553, and Joachim, who had up to this time borne the title of sieur de Liré, became seigneur of Gonnor. In 1549 he had published a *Recueil de poésies* dedicated to the Princess Marguerite. This was followed in 1552 by a version of the fourth book of the *Aeneid*, with other translations and some occasional poems. In the next year he went to Rome as one of the secretaries of Cardinal du Bellay. To the beginning of his four and a half years' residence in Italy belong the forty-seven sonnets of his *Antiquités de Rome*, which were rendered into English by Edmund Spenser (*The Ruins of Rome*, 1591). These sonnets were more personal and less imitative than the *Olive* sequence, and struck a note which was revived in later French literature by Volney and Chateaubriand. His stay in Rome was, however, a real exile. His duties were those of an intendant. He had to meet the cardinal's creditors and to find money for the expenses of the household. Nevertheless he found many friends among Italian scholars, and formed a close friendship with another exiled poet whose circumstances were similar to his own, Olivier de Magny. Towards the end of his sojourn in Rome he fell violently in love with a Roman lady called Faustine, who appears in his poetry as Columba and Columbelle. This passion finds its clearest expression in the Latin poems. Faustine was guarded by an old and jealous husband, and du Bellay's eventual conquest may have had something to do with his departure for Paris at the end of August 1557. In the next year he published the poems he had brought back with him from Rome, the Latin *Poemata*, the *Antiquités de Rome*, the *Jeux rustiques*, and the 191 sonnets of the *Regrets*, the greater number of which were written in Italy. The *Regrets* show that he had advanced far beyond the theories of the *Defence*. The simplicity and tenderness specially characteristic of du Bellay appear in the sonnets telling of his unlucky passion for Faustine, and of his nostalgia for the banks of the Loire. Among them are some satirical sonnets describing Roman manners, and the later ones written after his return to Paris are often appeals for patronage. His intimate relations with Ronsard were not renewed; but he formed a close friendship with the scholar Jean de Morel, whose house was the centre of a learned society. In 1559 du Bellay published at Poitiers *La Nouvelle Manière de faire son profit des lettres*, a satirical epistle translated from the Latin of Adrien Turnèbe, and with it *Le Poète courtisan*, which introduced the formal satire into French poetry. These were published under the pseudonym of J. Quintil du Troussay, and the courtier-poet was generally supposed to be Melin de Saint-Gelais, with whom du Bellay had always, however, been on friendly terms.

A long and eloquent *Discours au roi* (detailing the duties of a prince, and translated from a Latin original written by Michel de l'Hôpital, now lost) was dedicated to Francis II. in 1559, and is said to have secured for the poet a tardy pension. In

Paris he was still in the employ of the cardinal, who delegated to him the lay patronage which he still retained in the diocese. In the exercise of these functions Joachim quarrelled with Eustache du Bellay, bishop of Paris, who prejudiced his relations with the cardinal, less cordial since the publication of the outspoken *Regrets*. His chief patron, Marguerite de Valois, to whom he was sincerely attached, had gone to Savoy. Du Bellay's health was weak; his deafness seriously hindered his official duties; and on the 1st of January 1560 he died. There is no evidence that he was in priest's orders, but he was a clerk, and as such held various preferments. He had at one time been a canon of Notre Dame of Paris, and was accordingly buried in the cathedral. The statement that he was nominated archbishop of Bordeaux during the last year of life is unauthenticated by documentary evidence and is in itself extremely improbable.

BIBLIOGRAPHY.—The best edition of the works of J. du Bellay is *Œuvres françaises* (2 vols., 1866-1867), edited with introduction and notes by C. Marty-Laveaux in his *Pliade française*. His *Œuvres choisies* were published by L. Beq de Fouquieres in 1876. The chief source of his biography is his own poetry, especially the Latin elegy addressed to Jean de Morel, "*Elegia ad Janum Morellum Ebrodunensem, Pyladem suum*," printed with a volume of *Xenia* (Paris, 1569). A study of his life and writings by H. Chamard, forming vol. viii. of the *Travaux et mémoires de l'université de Lille* (Lille, 1900), contains all the available information and corrects many common errors. See also Sainte-Beuve, *Tableau de la poésie française au XVI^e siècle* (1828); *La Défense et illust. de la langue française* (1905), with biographical and critical introduction by Léon Sché, who also wrote *Joachim du Bellay, documents nouveaux et inédits* (1880), and published in 1903 the first volume of a new edition of the *Œuvres*; *Lettres de Joachim du Bellay* (1884), edited by P. de Nolhac; G. Wyndham, *Ronsard and La Pliade* (1906); H. Belloc, *Avril* (1905); A. Tilley, *The Literature of the French Renaissance* (2 vols., 1904).

DUBLIN, a county of Ireland in the province of Leinster, bounded N. by Co. Meath, E. by the Irish Sea, S. by Wicklow, and W. by Kildare and Meath. With the exception of Louth and Carlow, Dublin is the smallest county in Ireland, having an area of 218,873 acres, or about 342 sq. m. The northern portion is flat, and the soil good, particularly on the borders of Meath; but on the southern side the land rises into elevations of considerable height. The mountains are chiefly covered with heath, except where a subsidence in the ground affords a nucleus for the formation of bog, with which about 2000 acres are covered. There are also a few small tracts of bog in the northern part of the county. The mountain district is well adapted for timber. The northern coast of the county from Balbriggan to Howth has generally a sandy shore, and affords only the small harbours of Balbriggan and Skerries. In the promontory of Howth, the coast suddenly assumes a bolder aspect; and between the town of Howth and the rocky islet of Ireland's Eye an unsuccessful artificial harbour was constructed. Kingstown harbour on the south side of Dublin Bay superseded this, and is by far the best in the county. Dalkey Island, about 22 acres in extent, lies about midway between Kingstown harbour and the beautiful bay of Killiney. North of Howth lies Lambay Island, about 600 acres in area. Shell fish, especially lobsters, are taken here in abundance. Small islets lie farther north off Skerries; the most interesting of which is that known as Inispatrick, reputed as the first landing-place of St Patrick, and having the ruins of a church said to be the saint's first foundation, though it shares this reputation with other sites. Ireland's Eye, off Howth, is a very picturesque rock with about 54 acres of grass land. It has afforded great room for geological disquisition. The chief river in the county is the Liffey, which rises in the Wicklow mountains about 12 m. S.W. of Dublin, and, after running about 50 m., empties itself into Dublin Bay. The course of the river is so tortuous that 40 m. may be traversed and only 10 gained in direction. The scenery along the banks of the Liffey is remarkably beautiful. The mountains which occupy the southern border of the county are the extremities of the great group belonging to the adjacent county Wicklow. The principal summits are the group containing Glendoo (1919 ft.) and Two Rock (1699 ft.) within the county, and the border group of Kippure, reaching in that summit a height of 2475 ft. The grandest features of these hills are the great natural ravines

which open in them, the most extraordinary being the Scalp through which the traveller passes from Dublin to Wicklow.

Geology.—On the north a Silurian upland stretches, falling to the sea at Balbriggan, where fossiliferous strata contain contemporaneous volcanic rocks. A limestone of Bala age comes out under shales and andesites in the promontory of Portrane, and rocks of the same series occur in the bold island of Lambay, associated with a large mass of dark green porphyritic andesite (the "Lambay porphyry"). Silurian rocks reappear at Tallaght in the south-west, where the granite of Leinster rises through them, forming a moorland 2000 ft. in height only a few miles south of Dublin. Old Red Sandstone, seen at Donabate and Newcastle, leads up into Carboniferous Limestone, which is often darkened by mud and even shaly ("calpy" type). This rock produces a fairly level country, both north and south of the valley of the Liffey, although the beds are greatly folded. Beds of a higher Carboniferous zone are retained in synclinals near Rush. The rugged peninsula of Howth, connected by a raised bench with the mainland, is formed of old quartzites and shales, crushed and folded, and probably of Cambrian age. The rocks of the county show many signs of ice-action, and boulder-clays and drift-gravels cover the lowland, the latter being banked up on the mountain-slopes to heights of 1200 ft. or more. Much of this glacial material has been imported from the area of the Irish Sea. Lead-ore has been mined at the granite-contact at Ballycorus.

Industries.—The extension of Dublin city and its suburbs has no doubt had its influence on the decrease of acreage under both tillage and pasture. Oats and potatoes are the principal crops, but live stock, especially cattle, receives greater attention. A large proportion of holdings are of the smallest, nearly one-half of those beneath fifteen acres being also beneath one acre. The manufactures of the county are mainly confined to the city and suburbs, but there is manufacture of cotton hosiery at Balbriggan. The haddock, herring and other fisheries, both deep-sea and coastal, are important, and Kingstown is the headquarters of the fishery district. The salmon fishery district of Dublin also affords considerable employment. As containing the metropolis of Ireland, the communications of the county are naturally good, several important railways and two canals converging upon the city of Dublin, under the head of which they are considered.

Population and Administration.—The population (148,210 in 1891; 157,568 in 1901) shows a regular increase, which, however, is not consistent from year to year. About 70% are Roman Catholics, the Protestant Episcopalians (24%) standing next. The chief towns, apart from the capital, are Balbriggan (pop. 2336), Blackrock (8710), Dalkey (3398), Killiney and Ballybrack (2744), Pembroke (25,799), Rathmines and Rathgar (32,602), and the important port of Kingstown (17,377). These are urban districts. Skerries, Howth and Rush are small maritime towns. There are nine baronies in the county, which, including the city of Dublin, are divided into 100 parishes, all within the Protestant and Roman Catholic dioceses of Dublin. Assizes are held in Dublin, and quarter sessions also in the capital, and at Balbriggan, Kilmainham, Kingstown and Swords. Previous to the union with Great Britain, this county returned ten representatives to the Irish Parliament,—two for the county, two for the city, two for the university, and two for each of the boroughs of Swords and Newcastle. The county parliamentary divisions are now two, north and south, each returning one member. The city of Dublin constitutes a separate county.

History.—Dublin is among the counties generally considered to have been formed by King John, and comprised the chief portion of country within the English pale. The limits of the county, however, were uncertain, and underwent many changes before they were fixed. As late as the 17th century the mountainous country south of Dublin offered a retreat to the lawless, and it was not until 1606 that the boundaries of the county received definition in this direction, along with the formation of the county Wicklow. Although so near the seat of government 67,142 acres of profitable land were forfeited in the Rebellion of 1641 and 34,536 acres in the Revolution of 1688. In 1867 the most formidable of the Fenian risings took place near the village of Tallaght, about 7 m. from the city. The rebels, who numbered from 500 to 700, were found wandering at dawn, some by a small force of constabulary who, having in vain called upon them to yield, fired and wounded five of them; but the great bulk of them were overtaken by the troops under Lord Strathnairn, who captured them with ease and marched them into the city. There are numerous antiquities in the county. Rathis or encampments are frequent, and those at Raheny, Coolock, Lucan,

with the large specimen at Shankill or Rathmichael near the Scalp pass may be mentioned. Cromlechs occur in Phoenix Park, Dublin, at Howth, and elsewhere. There are fine round towers at Swords, Lusk and Clondalkin, and there is the stump of one at Rathmichael.

DUBLIN, a city, county of a city, parliamentary borough and seaport, and the metropolis of Ireland, in the province of Leinster. It lies at the head of a bay of the Irish Sea, to which it gives name, about midway on the eastern coast of the island, 334 m. W.N.W. of London by the Holyhead route, and 70 m. W. of Holyhead on the coast of Anglesey, Wales. (For map, see IRELAND.) Its population in 1901 was 290,638.

Site, Streets and Buildings.—Dublin lies on the great central limestone district which stretches across the island from the Irish Sea to the Atlantic Ocean, and occupies both banks of the river Liffey. Its situation is justly admired. The populous shores of the bay are exceedingly picturesque. To the north and west the country is comparatively level, the central plain of Ireland here reaching to the coast, but to the south the foothills of the Wicklow Mountains practically touch the confines of Greater Dublin, affording comprehensive views of the physical position of the city, and forming a background to some of the finest streets. The municipal boundary lies generally a little outside the so-called Circular Road, which may be taken as encircling the city proper, with a few breaks. It bears this name on both the north and south sides of the river. As the city is approached from the bay, the river Liffey, which divides the city from west to east roughly into two equal parts, is seen to be lined with a fine series of quays. At its mouth, on the north side, is the North Wall quay, where the principal steamers lie, and in this vicinity are the docks. At the opposite (western) end of the city, the Phoenix Park may be taken as a convenient landmark. Between this and North Wall the river is crossed by twelve bridges, which, in order from west to east, are these:—Sarah Bridge, the bridge of the North Wall extension railway; King's, commemorating a visit of George IV.; Victoria or Barrack; Queen's; Whitworth, of interest as occupying the site where a bridge has stood since the 12th century; Richmond, Grattan and Wellington; O'Connell, Butt and a swivel bridge carrying a loop railway. Of these O'Connell bridge (formerly known as Carlisle) is the principal, as it connects the chief thoroughfare on the north side, namely Sackville (or O'Connell) Street, with Great Brunswick Street and others on the south. Sackville Street, which gains in appearance from its remarkable breadth, contains the principal hotels, and the post office, with a fine Ionic portico, founded in 1815. At the crossing of Henry Street and Earl Street is the Nelson pillar, a beautiful monument 134 ft. in height, consisting of a fluted Doric column, raised on a massive pedestal, and crowned by a statue of the admiral. At the southern end of the street is Daniel O'Connell's monument, almost completed by John Henry Foley before his death, and erected in 1882. In Rutland Square, at the northern end, is the Rotunda, containing public rooms for meetings, and adjoining it, the Rotunda hospital with its Doric facade.

From the north end of Sackville Street, several large thoroughfares radiate through the northern part of the city, ultimately joining the Circular Road at various points. To the west there are the Broadstone station, Dominion Street, and beyond this the large workhouse, prison, asylum and other district buildings, while the Royal barracks front the river behind Albert Quay. Two other notable buildings face the river on the north bank. Between Whitworth and Richmond bridges stands the "Four Courts" (law courts), on the site of the ancient Dominican monastery of St Saviour. It was erected between 1786 and 1796, and is adjoined by other court buildings, the public record office, containing a vast collection, and the police offices. Below the lowest bridge on the river, and therefore in the neighbourhood of the shipping quarter, is the customs house (1781-1791), considered one of the chief ornaments of the city. It presents four fronts, that facing the river being of Portland stone, in the Doric order, while the rest are of granite. The centre is crowned by a dome, surmounted by a statue of Hope. This building

provides offices for the Local Government Board, Boards of Trade and of Public Works and other bodies.

It is, however, to the south of the river that the most interesting buildings are found. Crossing O'Connell bridge, the short Westmoreland Street strikes into a thoroughfare which traverses the entire city parallel with the river, and is known successively (from west to east) as James, Thomas, High, Castle, Dame, College and Great Brunswick streets. At the end of Westmoreland Street a fine group of buildings is seen—Trinity College on the left and the Bank of Ireland on the right. Barely half a mile westward down Dame Street, rises the Castle, and 300 yds. beyond this again is the cathedral of Christ Church. These, with the second cathedral of St Patrick, are more conveniently described in the inverse order.

The cathedral of Christ Church, or Holy Trinity, the older of the two Protestant cathedrals in the possession of which Dublin is remarkable, was founded by Sigtryg, a Christianized king of the Danes of Dublin, in 1038, but dates its elevation to a deanery and chapter from 1541. It was restored in 1870–1877 by G. E. Street at the charge of Mr. Henry Roe, a merchant of Dublin, who also presented the Synod House. The restoration involved the complete rebuilding of the choir and the south side of the nave, but the model of the ancient building was followed with great care. The crypt embodies remains of the founder's work; the rest is Transitional Norman and Early English in style. Among the monuments is that of Strongbow, the invader of Ireland, to whom the earlier part of the superstructure (1170) is due. Here the tenants of the church lands were accustomed to pay their rents. The monument was injured by the fall of one of the cathedral walls, but was repaired. By its side is a smaller tomb, ascribed to Strongbow's son, whom his father killed for showing cowardice in battle. Synods were occasionally held in this church, and parliaments also, before the Commons' Hall was destroyed in 1566 by an accidental explosion of gunpowder. Here also the pretender Lambert Simnel was crowned.

A short distance south from Christ Church, through the squalid quarter of Nicholas and Patrick streets, stands the other Protestant cathedral dedicated to St Patrick, the foundation of which was an attempt to supersede the older foundation of Christ Church, owing to jealousies, both ecclesiastical and political, arising out of the Anglo-Norman invasion. It was founded about 1190 by John Comyn, archbishop of Dublin; but there was a church dedicated to the same saint before. It was burnt about two hundred years later, but was raised from its ruins with increased splendour. At the Reformation it was deprived of its status as a cathedral, and the building was used for some of the purposes of the courts of justice. Edward VI. contemplated its change into a university, but the project was defeated. In the succeeding reign of Mary, St Patrick's was restored to its primary destination. The installations of the knights of St Patrick, the first of which took place in 1783, were originally held here, and some of their insignia are preserved in the choir. This cathedral contains the monuments of several illustrious persons, amongst which the most celebrated are those of Swift (dean of this cathedral), of Mrs Hester Johnson, immortalized under the name of "Stella"; of Archbishop Marsh; of the first earl of Cork; and of Duke Schomberg, who fell at the battle of the Boyne. The tablet over Schomberg's grave contains what Macaulay called a "furious libel," though it only states that the duke's relatives refused the expense of the tablet. In the cathedral may be seen the chain ball which killed General St Ruth at the battle of Aughrim, and the spurs which he wore. The cathedral was restored by Sir Benjamin Lee Guinness (1864), whom a fine statue by John Henry Foley commemorates, and the work was resumed by his son Lord Iveagh in 1900. Attached to the cathedral is Marsh's library, incorporated in 1707, by a request of Primate Marsh, archbishop of Armagh. It contains a good number of theological works and of manuscripts, and is open to the public; but is deficient in modern publications.

Dublin Castle stands high, and occupies about ten acres of

ground, but excepting St Patrick's Hall, the apartments are small, and the building is of a motley and unimposing appearance, with the exception of the chapel (a Gothic building of the early 19th century) and great tower. The castle was originally built in the first two decades of the 13th century; and there are portions of this period, but nearly the whole is of the 16th century and later. In St Patrick's hall where the knights of St Patrick are invested, are the banners of that order. Opposite the castle is the city hall (1779), in the possession of the corporation, with statues in the central hall of George III., of Grattan (a superb work by Sir Francis Chantry), of Daniel O'Connell, and of Thomas Drummond by John Hogan and several others.

The Bank of Ireland (see ARCHITECTURE, fig. 85) occupies five acres, and was formerly the House of Parliament. There are three fronts; the principal, towards College Green, is a colonnade of the Ionic order, with façade and two projecting wings; it connects with the western portico by a colonnade of the same order, forming the quadrant of a circle. The eastern front, which was the entrance of the House of Lords, is, by their special wish, of the Corinthian order, made conformable with the rest of the building not without difficulty to the architect. The House of Lords contains tapestry dating from 1733, and remains in its original condition, but the octagonal House of Commons was demolished by the bank directors, and replaced with a cash-office. The building was begun in 1729, but the fronts date from the end of the century; the remodelling took place in 1803.

Trinity College, or Dublin University, fronts the street with a Palladian façade (1759), with two good statues by Foley, of Goldsmith and Burke. Above the gateway is a hall called the Regent House. The first quadrangle, Parliament Square, contains the chapel (1798), with a Corinthian portico, the public theatre or examination hall (1787), containing portraits of Queen Elizabeth, Molyneux, Burke, Bishop Berkeley and other celebrities, and the wainscotted dining hall, also containing portraits. A beautiful modern campanile (1853), erected by Lord John George Beresford, archbishop of Armagh and chancellor of the university, occupies the centre of the square. Library Square takes its name from the library, which is one of the four scheduled in the Copyright Act as entitled to receive a copy of every volume published in the United Kingdom. There is a notable collection of early Irish manuscripts, including the magnificently ornamented Book of Kells, containing the gospels. The building was begun in 1712. In this square are the oldest buildings of the foundation, dating in part from the close of the 17th century, and the modern Graduates' Memorial buildings (1904). These contain a theatre, library and reading-room, the rooms of the college societies and others. The schools form a fine modern pile (1856), and other buildings are the provost's house (1760), printing house (1760), museum (1857) and the medical school buildings, in three blocks, one of the best schools in the kingdom. Other buildings of the 20th century include chemical laboratories. The College Park and Fellows' Garden are of considerable beauty. In the former most of the recreations of the students take place; but the college also supports a well-known rowing-club. The college observatory is at Dunsink, about 5 m. north-west of Dublin; it is amply furnished with astronomical instruments. It was endowed by Dr Francis Andrews, provost of Trinity College, was erected in 1785, and in 1791 was placed by statute under the management of the royal astronomer of Ireland, whose official residence is here. The magnetic observatory of Dublin was erected in the years 1837–1838 in the gardens attached to Trinity College, at the expense of the university. A normal climatological station was established in the Fellows' Garden in 1904. The botanic garden is at Ball's Bridge, 1 m. S.E. of the college.

The alternative title of Dublin University or Trinity College, Dublin (commonly abbreviated T.C.D.), is explained by the fact that the university consists of only one college, that of "the Holy and Undivided Trinity." This was founded under charter from Queen Elizabeth in 1591 and is the greatest foundation of its kind in the

country. The corporation consists of a provost, 7 senior fellows, 25 junior fellows and 70 scholars. A vacancy among the fellows is filled up by the provost and a select number of the fellows, after examination comprised in five principal courses, mathematics, experimental science, classics, mental and moral science and Hebrew. Fellowships are held for life. Until the year 1840 the fellows were bound to celibacy, but that restriction was then removed. All except five (medical and law fellows) were bound to take Holy Orders until 1872. The scholars on the foundation (or "of the House") are chosen from among the undergraduates, for merit in classics, mathematics or experimental science. The pecuniary advantages attaching to scholarship (20 Irish, free commons, and rooms at half the charge made to other students) last for four years. Students after an examination are admitted as fellow-commoners, pensioners or sizars. Fellow-commoners, who have decreased in numbers in modern times, pay higher fees than the ordinary undergraduates or pensioners, and have certain advantages of precedence, including the right of dining at the fellows' table. Sizars are awarded on examination to students of limited means, and carry certain relaxations of fees. They were formerly given on the nomination of fellows. Noblemen, noblemen's sons and baronets (*nobilis, filius nobilis, eques*) have the privilege of forming a separate order with peculiar advantages, on the payment of additional charges. The mode of admission to the university is in all cases by examination. Various exhibitions and prizes are awarded both in connexion with the entrance of students and at subsequent stages of the course of instruction, which normally lasts four years. There are three terms in each year—Michaelmas (beginning the Academic year), Hilary and Trinity. The undergraduate is called in his first year a junior freshman, in his second a senior freshman, in his third a junior sophister, and in his fourth a senior sophister. The usual arts and scientific courses are provided, and there are four professional schools—divinity, law, physic and engineering. The undergraduate has certain examinations in each year, and four "commencements" are held every year for the purpose of conferring degrees. Freedom is offered to students who wish to be transferred from Oxford, Cambridge, or certain colonial universities to Trinity College, by the recognition of terms kept in the former institutions as part of the necessary course at Trinity College. In 1903 it was decided to bestow degrees on women, and in 1904 to establish women's scholarships. The funds of the college, arising from lands and the fees of students, are managed solely by the provost and seven senior fellows, who form a board, to which and to the academic council the whole government of the university, both in its executive and its legislative branches, is committed. The council consists of the provost and sixteen members of the senate elected by the fellows, professors, &c.; the senate consists of the chancellor or his deputy and doctors and masters who keep their names on the books. The average number of students on the books is about 1300. By an act passed in 1873, known as Fawcett's Act, all tests were abolished, and the prizes and honours of all grades hitherto reserved for Protestants of the Established Church were thrown open to all. The university returns two members to parliament. (See *Dublin University Calendar*, annual.)

There remain to be mentioned the following buildings in Dublin. The permanent building of the International Exhibition of 1865 adjoins the pleasure ground of St Stephen's Green. This building was occupied by the Royal University of Ireland until its dissolution under the Irish Universities Act 1908, which provided for a new university at Dublin, to which the building was transferred under the act (see IRELAND: *Education*). The new university is called the National University of Ireland. At the same time a new college was founded under the name of University College. The Royal University replaced the Queen's University under the University Act (Ireland) in 1879. No teaching was carried on, but examinations were held and degrees conferred, both on men and on women. On the west side of St Stephen's Green is the Catholic University (1854), which is under the Jesuit Fathers and affiliated to the Royal University. Between Trinity College and St Stephen's Green, a large group of buildings includes the Royal Dublin Society, founded in 1683 to develop agriculture and the useful arts, with a library and gallery of statuary; the Science and Arts Museum, and the National Library, the former with a noteworthy collection of Irish antiquities; the Museum of Natural History, with a splendid collection of Irish fauna; and the National Gallery of Ireland, founded in 1853. Here was once a residence of the duke of Leinster, and the buildings surround the open space of Leinster Lawn. Educational foundations include the Royal College of Physicians, of Surgeons and of Science; the Royal Irish Academy, with an unequalled collection of national antiquities, including manuscripts and a library; and the Royal Hibernian Academy of painting, sculpture and architecture. In 1904 the

formation of a municipally supported gallery of modern art (mainly due to the initiative and generosity of Mr Hugh Lane) was signalized by an exhibition including the pictures intended to constitute the nucleus of the gallery. In 1905 King Edward VII. laid the foundation stone of a college of science on a site in the vicinity of Leinster Lawn. The full scheme for the occupation of the site included, not only the college, but also offices for the Board of Works and the Department of Agriculture. The famous Dublin Horse and Agricultural Shows are held at Ball's Bridge in April, August and December.

The most notable churches apart from the cathedrals are Roman Catholic and principally modern. The lofty church of the Augustinians in Thomas Street; St Mary's, the pro-cathedral, in Marlborough Street, with Grecian ornamentation within, and a Doric portico; St Paul's on Arran Quay, in the Ionic style; and the striking St Francis Xavier in Gardiner Street, also Ionic, are all noteworthy, and the last is one of the finest modern churches in Ireland. Among theatres Dublin has, in the Royal, a handsome building which replaced the old Theatre Royal, burnt down in 1860. Clubs, which are numerous, are chiefly found in the neighbourhood of Sackville Street; and there should further be mentioned the Rotunda, at the corner of Great Britain Street and Sackville Street, a beautiful building of its kind, belonging to the adjacent hospital, and used for concerts and other entertainments, while its gardens are used for agricultural shows.

Suburbs.—To the west of the city lies the Phoenix Park. Here, besides the viceregal demesne and lodge and the magazine, are a zoological garden, a people's garden, the Wellington monument, two barracks, the Hibernian military school, the "Fifteen Acres," a natural amphitheatre (of much greater extent than its name implies) used as a review ground, and a racecourse. The amenities of Phoenix Park were enhanced in 1905 by the purchase for the crown of land extending along the Liffey from Island bridge to Chapelizod, which might otherwise have been built over. To the south lies Kilmainham. Here is the royal hospital for pensioners and maimed soldiers. Close by is Kilmainham prison. To the west the valley of the Liffey affords pleasant scenery, with the well-known grounds called the "Strawberry Beds" on the north bank. In this direction lies Chapelizod, said to take its name from that Iselt whom Tennyson, Matthew Arnold and Wagner made a heroine; beyond which is Lucan connected with the city by tramway. Northward lies Clondalkin, with its round tower, marking the site of the important early see of Cluain Dolcain; Glasnevin, with famous botanical gardens; Finglas, with a ruined church of early foundation, and an Irish cross; and Clontarf, a favoured resort on the bay, with its modern castle and many residences of the wealthy classes in the vicinity. South of the city are Rathmines, a populous suburb, near which, at the "Bloody Fields," English colonists were murdered by the natives in 1209; and Donnybrook, celebrated for its former fair. Rathmines, Monkstown, Clontarf, Dalkey and Killiney, with the neighbourhood of Kingstown and Pembroke, are the most favoured residential districts. Howth, Malahide and Sutton to the north, and Bray to the south, are favoured seaside watering-places outside the radius of actual suburbs.

Communications.—The direct route to Dublin from London and other parts of England is by the Holyhead route, controlled by the London & North Western railway with steamers to the port of Dublin itself, while the company also works in conjunction with the mail steamers of the City of Dublin Steam Packet Company to the outlying port of Kingstown, 7 m. S.E. Passenger steamers, however, also serve Liverpool, Heysham, Bristol, the south coast ports of England and London; Edinburgh and Glasgow, and other ports of Great Britain. The railways leaving Dublin are the following: the Great Northern, with its terminus in Amiens Street, with suburban lines, and a main line running north to Drogheda, Dundalk and Belfast, with ramifications through the northern counties; the Great Southern & Western (Kingsbridge terminus) to Kilkenny, Athlone and Cork; the Midland Great Western (Broadstone terminus), to Cavan, Sligo

and Galway; the Dublin & South-Eastern (Harcourt Street and Westland Row for Kingstown); and there is the North Wall station of the London & North-Western, with the line known as the North Wall extension, connecting with the other main lines. The internal communications of the city are excellent, electric tramways traversing the principal streets, and connecting all the principal suburbs.

Trade.—Dublin was for long stigmatized as lacking, for so large a city, in the proper signs of commercial enterprise. A certain spirit of foolish pride was said to exist which sought to disown trade; and the tendency to be poor and genteel in the civil service, at the bar, in the constabulary, in the army, in professional life, rather than prosperous in business, was one of the most unfortunate and strongly marked characteristics of Dublin society. This was attributable to the lingering yet potent influence of an unhappy past was held by some; while others attributed the weakness to the viceregal office and the effects of a sham court. About the time of the Revolution, the woollen trade flourished in Dublin, and the produce attained great celebrity. The cheapness of labour attracted capitalists, who started extensive factories in that quarter of the town known even now as the Liberties. This quarter was inhabited altogether by workers in wool, and as the city was small, the aristocracy lived close by in noble mansions which are now miserable memorials of past prosperity. About 1700 the English legislature prevailed on William III. to assent to laws which directly crushed the Irish trade. All exportation except to England was peremptorily forbidden, and the woollen manufacture soon decayed. But at the close of the 18th century there were 5000 persons at work in the looms of the Liberties. About 1715 parliament favoured the manufacture of linen, and the Linen Hall was built. The cotton trade was soon afterwards introduced; and silk manufacture was begun by the Huguenots, who had settled in Dublin in considerable numbers after the revocation of the edict of Nantes. Acts favourable to these enterprises were passed, and they flourished apace. But the old jealousy arose in the reign of George I., and in the reign of George III. an act was passed which tended directly to the ruin of the manufacture. The linen shared the same fate. Dublin poplins, however, keep their reputation. However adverse influences may have been combated, Dublin yet produces little for export save whisky and porter, the latter from the famous Guinness brewery and others; but a considerable export trade, principally in agricultural produce, passes through Dublin from the country. The total annual export trade may be valued at about £120,000, while imports exceed in value £3,000,000. To the manufacturing industries of the city there should be added mineral water works, foundries and shipbuilding.

By continual dredging a great depth of water is kept available in the harbour. The Dublin Port and Docks Board, which was created in 1898 and consists of the mayor and six members of the corporation, with other members representing the trading and shipping interests, undertook considerable works of improvement at the beginning of the 20th century. These improvements, *inter alia*, enabled vessels drawing up to 23 ft. to lie alongside the extensive quays which border the Liffey, at low tide. The extensive Alexandra tidal basin, on the north side of the Liffey, admits vessels of similar capacity. The Custom House Works on the north side have about 17 ft. of water. With docks named after them are connected the Royal and Grand Canals, passing respectively to north and south of the city, the one penetrating the great central plain of Ireland on the north, the other following the course of the Liffey, doing the same on the south, and both joining the river Shannon. The docks attached to the canals, and certain other smaller docks, are owned by companies, and tolls are levied on vessels entering these, but not those entering the docks under the Board.

Government.—Dublin was formerly represented by two members in the imperial parliament, but in 1885 the parliamentary borough was divided into the four divisions of College Green, Harbour, St Stephen's Green and St Patrick's, each returning one member. The lord-lieutenant of Ireland occupies

Dublin Castle and the Viceregal Lodge in Phoenix Park. Dublin is thus the seat of the viceregal court. It is also the seat of the Irish courts of law and equity. In connexion with these it may be noted that in 1904 a special court was established for children. On the constitution of Dublin as a county borough in 1898, the positions and duties of its corporation were left practically unaltered. The corporation consists of a lord mayor, 20 aldermen and 60 councillors, representing 20 wards. The income of the body arises from rents on property, customs and taxes. Under an act passed in 1875 the corporation has the right to forward every year three names of persons suitable for the office of high sheriff to the viceroys, one of which shall be selected by him. The corporation has neither control over the police nor any judicial duties, excepting as regards a court of conscience dealing with debts under 40s. (Irish); while the lord mayor holds a court for debts over 40s., and for the settlement of cases between masters and servants. The lord mayor is clerk of the markets and supervises weights and measures and deals with cases of adulteration. Besides the usual duties of local government, and the connexion with the port and docks boards already explained, there should be noticed the connexion of the corporation with such bodies as those controlling the city technical schools, the Royal Irish Academy of Music, and the gallery of modern art. The corporation has shown some concern for the housing of the poor, and an extensive scheme taken up in 1904 included the provision of cottage dwellings in the suburbs, as at Clontarf, besides improvements within the city itself. In 1905 a home on the model of the Rowton Houses in London, provided by Lord Iveagh, was opened in Bride Road. A competent fire-brigade is maintained by the corporation. The city coroner is a corporate officer. The city hall, used as municipal offices, has already been mentioned; the official residence of the lord mayor is the Mansion House, Dawson Street. The Dublin metropolitan police is a force peculiar to the city, the remainder of Ireland being protected civilly by the Royal Irish Constabulary. A large military force is usually maintained in the city of Dublin, which is the headquarters of the military district of Dublin and of the staff of Ireland (*g.s.*). The troops are accommodated in several large barracks in various parts of the city.

Charities.—The number of charitable institutions is large. The hospital and Free School of King Charles I., commonly called the Blue Coat hospital, was founded in 1670. It is devoted to the education and maintenance of the sons of citizens in poor circumstances. Before the Irish Parliament Houses were erected the parliament met in the school building. Among hospitals those of special general interest are the Stevens, the oldest in the city, founded under the will of Dr Richard Stevens in 1720; the Mater Misericordiae (1861), which includes a laboratory and museum, and is managed by the Sisters of Mercy, but relieves sufferers independently of their creed; the Rotunda lying-in hospital (1756); the Royal hospital for incurables, Donnybrook, which was founded in 1744 by the Dublin Musical Society; and the Royal Victoria Eye and Ear hospital, Adelaide Road, which amalgamated (1904) two similar institutions. Lunatics are maintained in St Patrick's hospital, founded in 1745, pursuant to the will of Dean Swift, and conducted by governors appointed under the charter of incorporation. The Richmond lunatic asylum, erected near the House of Industry, and placed under the care of officers appointed by government, receives patients from a district consisting of the counties of Dublin, Louth, Meath and Wicklow, each of these contributing towards its expenses in proportion to the number of patients sent in. Besides these public establishments for the custody of lunatics, there are in the vicinity of Dublin various private asylums. The principal institution for blind men (and also those afflicted by gout) is Simpson's hospital (1780), founded by a merchant of Dublin; while blind women are maintained at the Molyneux asylum (1815). An institution for the maintenance and education of children born deaf and dumb is maintained at Claremont, near Glasnevin (1816). The plan of the Royal hospital, for old and maimed soldiers, was first suggested by the earl of Essex. when lord-lieutenant. and carried into eff

through the repeated applications of the duke of Ormond to Charles II. The site chosen for it was that of the ancient priory of Kilmainham, founded by Strongbow for Knights Templars. The building, completed in 1684, according to a plan of Sir Christopher Wren, is an oblong, three sides of which are dwelling-rooms, connected by covered corridors. The fourth contains the chapel, the dining-hall, and the apartments of the master, who is always the commander of the forces for the time being. The Royal Hibernian military school in Phoenix Park (1765) provides for soldiers' orphan sons. The Drummond Institution, Chapelized, for the orphan daughters of soldiers, was established in 1864 by John Drummond, alderman, who left £20,000 to found the asylum. The Hibernian Marine Society for the maintenance of seamen's sons was established in the city in 1766, but now has buildings at Clontarf. The Roman Catholic Church has charge of a number of special charities, some of them educational and some for the relief of suffering.

History.—The name of Dublin signifies the "Black pool." The early history is mainly legendary. It is recorded that the inhabitants of Leinster were defeated by the people of Dublin in the year 201. Christianity was introduced by St Patrick about 450. In the 9th century the Danes attacked Dublin and took it. The first Norseman who may be reckoned as king was Thorkel I. (832), though the Danes had appeared in the country as early as the close of the previous century. Thorkel established himself strongly at Armagh. In 1014 Brian Boroihme, king of Munster, attacked the enemy and fought the battle of Clontarf, in which he and his son and 11,000 of his followers fell. The Irish, however, won the battle, but the Danes reoccupied the city. Constant struggles with the Irish resulted in intermissions of the Danish supremacy from 1052 to 1072, at various intervals between 1075 and 1118 and from 1124 to 1136. The Danes were finally ousted by the Anglo-Normans in 1171. In 1172 Henry II. landed at Waterford, and came to Dublin and held his court there in a pavilion of wickerwork where the Irish chiefs were entertained with great pomp, and alliances entered into with them. Previous to his departure for England, Henry bestowed the government on Hugh de Lacy, having granted by charter "to his subjects of Bristol his city of Dublin to inhabit, and to hold of him and his heirs for ever, with all the liberties and free customs which his subjects of Bristol then enjoyed at Bristol and through all England." In 1176 Strongbow, earl of Pembroke, and chief leader of the Anglo-Norman forces, died in Dublin of a mortification in one of his feet, and was buried in Christ Church Cathedral, where his monument remains well preserved. A fresh charter was granted in 1207 by King John to the inhabitants of Dublin, who had not yet made their peace with the neighbourhood, but, like the settlers in other towns, were at constant feud with the native Irish; so that two years after the date of this charter, whilst the citizens of Dublin were celebrating Easter at Cullenswood, they were set upon by the Irish of the neighbouring mountains, and 500 of them killed. The scene of slaughter is still called the Bloody Fields, and Easter Monday denominated Black Monday. On each succeeding anniversary of that day, with the prevalent desire of perpetuating a feud, the citizens marched out to Cullenswood with banners displayed—"a terror to the native Irish." In 1216 Magna Carta, a copy of which is to be found in the Red Book of the Exchequer, was granted to the Irish by Henry III. In 1217 the fee farm of the city was granted to the citizens at a rent of 200 marks per annum; and about this period many monastic buildings were founded. In 1227 the same monarch confirmed the charter of John fixing the city boundaries and the jurisdiction of its magistrates.

During the invasion of Ireland by Edward Bruce in 1315 some of the suburbs of Dublin were burnt to prevent them from falling into his hand. The inroad of Bruce had been denounced by the native Irish ecclesiastics, whose sentiments were recorded in a statement addressed to Pope John XXII. Some notion of the defence made against Bruce's invasion may be gained from the fact that the churches were torn down to supply stones for the building of the city walls. Bruce had seized Greencastle on his march; but the natives re-took the town,

and brought to Dublin the governor who had yielded to Bruce. He was starved to death.

Richard II. erected Dublin into a marquise in favour of Robert de Vere, whom he also created duke of Ireland. The same monarch entered Dublin in 1394 with 30,000 bowmen and 4000 cavalry, bringing with him the crown jewels; but after holding a parliament and making much courtly display before the native chieftains, on several of whom he conferred knighthood, he returned to England. Five years later, enriched with the spoils of his uncle, John of Gaunt, Richard returned to Ireland, landing at Waterford, whence he marched through the counties of Kilkenny and Wicklow, and subsequently arrived in Dublin, where he remained a fortnight, sumptuously entertained by the provost, as the chief magistrate of the city was then called, till intelligence of the invasion of his kingdom by Bolingbroke recalled him to England.

In 1534 Lord Thomas Fitzgerald, better known as Silken Thomas (so called because of a fantastic fringe worn in the helmet of his followers), a young man of rash courage and good abilities, son of the Lord Deputy Kildare, believing his father, who was imprisoned in the Tower of London, to have been beheaded, organized a rebellion against the English Government, and marched with his followers from the mansion of the earls of Kildare in Thomas Court, through Dame's Gate to St Mary's Abbey, where, in the council chamber, he proclaimed himself a rebel. On his appearing before the wall with a powerful force, the citizens were induced through fear to give admission to a detachment of his troops to besiege the castle; but, on hearing that he had met with a reverse in another quarter, they suddenly closed their gates and detained his men as prisoners. He then attacked the city itself; but, finding it too strong to be seized by a *coup de main*, he raised the siege on condition of having his captured soldiers exchanged for the children of some of the principal citizens who had fallen into his hands. After much vicissitude of fortune, Lord Thomas and others concerned in this rebellion were executed at Tyburn in 1536.

At the outbreak of civil war in 1641, a conspiracy of the Irish septs, under the direction of Roger Moore, to seize Dublin Castle, was disclosed by one Owen Connolly on the eve of the day on which the attempt was to have been made, and the city was thus preserved for the king's party; but the Irish outside began an indiscriminate extermination of the Protestant population. In 1646 Dublin was besieged, but without success, by the Irish army of 16,000 foot and 1000 horse, under the guidance of the Pope's nuncio Ruiccinelli and others, banded together "to restore and establish in Ireland the exercise of the Roman Catholic religion." The city had been put in an efficient state of defence by the marquis of Ormonde, then lord-lieutenant; but in the following year, to prevent it falling into the hands of the Irish, he surrendered it on conditions to Colonel Jones, commander of the Parliamentary forces. In 1649 Ormonde was totally defeated at the battle of Baginbally, near Old Rathmines, in an attempt to recover possession. The same year Cromwell landed in Dublin, as commander-in-chief under the parliament, with 9000 foot and 4000 horse, and proceeded thence on his career of conquest.

When James II. landed in Ireland in 1689 to assert his right to the British throne, he held a parliament in Dublin, which passed acts of attainder against upwards of 3000 Protestants. The governor of the city, Colonel Luttrell, at the same time issued a proclamation ordering all Protestants not housekeepers, excepting those following some trade, to depart from the city within 24 hours, under pain of death or imprisonment, and in various ways restricting those who were allowed to remain. In the hope of relieving his financial difficulties, the king erected a mint, where money was coined of the "worst kind of old brass, guns and the refuse of metals, melted down together," of the nominal value of £1,568,800, with which his troops were paid, and tradesmen were compelled to receive it under penalty of being hanged in case of refusal. Under these regulations the entire coinage was put into circulation. After his defeat at the battle of the Boyne, James returned to Dublin, but left it again before

daybreak the next day; and William III. advancing by slow marches, on his arrival encamped at Finglas, with upwards of 30,000 men, and the following day proceeded in state to St Patrick's cathedral to return thanks for his victory.

In 1783 a convention of delegates from all the volunteer corps in Ireland assembled in Dublin for the purpose of procuring a reform in parliament; but the House of Commons refused to entertain the proposition, and the convention separated without coming to any practical result. In May 1798 the breaking out of a conspiracy planned by the United Irishmen to seize the city was prevented by the capture of Lord Edward Fitzgerald, son of the duke of Leinster and husband of the celebrated "Pamela." Lord Edward died in prison of the wounds received in the encounter which preceded his capture. In 1803 an insurrection headed by Robert Emmett, a young barrister of much promise, broke out, but was immediately quelled, with the loss of some lives in the tumult, and the death of its leaders on the scaffold. In 1848 William Smith O'Brien, M.P. for Limerick, raised a rebellion in Tipperary, and the lower classes in Dublin were greatly agitated. Owing, however, to timely and judicious disposition of the military and police forces the city was saved from much bloodshed. In 1867 the most serious of modern conspiracies, that known as the Fenian organization, came to light. The reality of it was proved by a ship being found laden with gunpowder in the Liverpool docks, and another with 5000 and 2000 pike-heads in Dublin. The Habeas Corpus Act was suspended at one sitting by both Houses of Parliament and about 960 arrests were made in Dublin in a few hours. Dublin castle was fortified; and the citizens lived in a state of terror for several weeks together. For later history, see IRELAND.

See W. Harris, *History and Antiquities of the City of Dublin* (Dublin, 1766); Sir J. T. Gilbert, *History of the City of Dublin* (Dublin, 1859). The history of the Norsemen in Dublin has been dealt with by a Norwegian writer, L. J. Vogt, *Dublin som Norsk By* (Christiania, 1896).

DÜBNER, JOHANN FRIEDRICH (1802-1867), German classical scholar (naturalized a Frenchman), was born in Hör selgau, near Gotha, on the 20th of December 1802. After studying at the university of Göttingen he returned to Gotha, where from 1827-1832 he held a post (*inspector coenobii*) in connexion with the gymnasium. During this period he made his name known by editions of Justin and Pansius (after Casaubon). In 1832 he was invited by the brothers Didot to Paris, to co-operate in a new edition of H. Etienne's Greek *Thesaurus*. He also contributed largely to the *Bibliotheca Graeca* published by the same firm, a series of Greek classics with Latin translation, critical notes and valuable indexes. One of Dübner's most important works was an edition of Caesar undertaken by command of Napoleon III., which obtained him the cross of the Legion of Honour. His editions are considered to be models of literary and philological criticism, and did much to raise the standard of classical scholarship in France. He violently attacked Burnouf's method of teaching Greek, but without result. Dübner may have gone too far in his zeal for reform, and his opinions may have been too harshly expressed, but time has shown him to be right. The old text-books have been discarded, and a great improvement in classical teaching has taken place in recent years. Dübner died at Montreuil-sous-Bois, near Paris, on the 13th of December 1867.

See F. Godefroy, *Notice sur J. F. Dübner* (1867); Sainte-Beuve, *Discours à la mémoire de Dübner* (1868); article in *Allgemeine deutsche Biographie*.

DUBOIS, FRANÇOIS CLÉMENT THÉODORE (1837-), French musical composer, was born at Rosney (Marne) on the 24th of August 1837. He studied at the Conservatoire under Ambroise Thomas, and won the Grand Prix de Rome in 1862 with his cantata *Atala*. After the customary sojourn in Rome, Dubois returned to Paris and devoted himself to teaching. He was appointed "maitre de Chapelle" at the church of Ste Clotilde, where César Franck was organist, in 1863, and remained at this post for five years, during which time he composed a quantity of sacred music, notably *Les Sept Paroles du Christ* (1867), a work which has become well known in France. In 1868 he became "maitre de Chapelle" at the church of the

Madeleine, and nine years later succeeded Camille Saint-Saëns there as organist. He became professor of harmony at the Conservatoire in 1871, and was appointed professor of composition in succession to Léo Delibes in 1891. At the death of Ambroise Thomas in 1896 he became director of the Conservatoire. Dubois is an extremely prolific composer and has written in a variety of forms. His sacred works include four masses, a requiem, *Les Sept Paroles du Christ*, a large number of motets and pieces for organ. For the theatre he has composed *La Guala de l'Emir*, an opéra comique in one act, played at the Théâtre Lyrique de l'Athénée in 1873; *Le Poin bis*, an opéra comique in one act, given at the Opéra Comique in 1879; *La Favandole*, a ballet in three acts, produced at the Grand Opéra in 1883; *Aben-Hamel*, a four-act opera, heard at the Théâtre Italien in 1884; *Xavière*, a dramatic idyll in three acts, played at the Opéra Comique in 1895. His orchestral works include two concert overtures, the overture to *Friskioff* (1880), several suites, *Marche héroïque de Jeanne d'Arc* (1888), &c. He is also the author of *Le Paradis perdu*, an oratorio which gained for him the prize offered by the city of Paris in 1878; *L'Enlèvement de Proserpine* (1879), a *scène lyrique*; *Désirance* (1887), a cantata; *Hylas* (1890), a *scène lyrique* for soli, chorus and orchestra; *Notre Dame de la mer*, a symphonic poem (1897); and a musical setting of a Latin ode on the baptism of Clovis (1899). In addition, he composed much for the piano and voice.

DUBOIS, GUILLAUME (1656-1723), French cardinal and statesman, was born at Brive, in Limousin, on the 6th of September 1656. He was, according to his enemies, the son of an apothecary, his father being in fact a doctor of medicine of respectable family, who kept a small drug store as part of the necessary outfit of a country practitioner. He was educated at the school of the Brothers of the Christian Doctrine at Brive, where he received the tonsure at the age of thirteen. In 1672, having finished his philosophy course, he was given a scholarship at the college of St Michel at Paris by Jean, marquis de Pompadour, lieutenant-general of the Limousin. The head of the college, the abbé Antoine Faure, who was from the same part of the country as himself, befriended the lad, and continued to do so for many years after he had finished his course, finding him pupils and ultimately obtaining for him the post of tutor to the young duke of Chartres, afterwards the regent duke of Orleans. Astute, ambitious and unrestrained by conscience, Dubois ingratiated himself with his pupil, and, while he gave him formal school lessons, at the same time pandered to his evil passions and encouraged him in their indulgence. He gained the favour of Louis XIV. by bringing about the marriage of his pupil with Mademoiselle de Blois, a natural but legitimated daughter of the king; and for this service he was rewarded with the gift of the abbey of St Just in Picardy. He was present with his pupil at the battle of Steinkirk, and "faced fire," says Marshal Luxembourg, "like a grenadier." Sent to join the French embassy in London, he made himself so active that he was recalled by the request of the ambassador, who feared his intrigues. This, however, tended to raise his credit with the king. When the duke of Orleans became regent (1715) Dubois, who had for some years acted as his secretary, was made councillor of state, and the chief power passed gradually into his hands.

His policy was steadily directed towards maintaining the peace of Utrecht, and this made him the main opponent of the schemes of Cardinal Alberoni for the aggrandizement of Spain. To counteract Alberoni's intrigues, he suggested an alliance with England, and in the face of great difficulties succeeded in negotiating the Triple Alliance (1717). In 1719 he sent an army into Spain, and forced Philip V. to dismiss Alberoni. Otherwise his policy remained that of peace. Dubois's success strengthened him against the bitter opposition of a large section of the court. Political honours did not satisfy him, however. The church offered the richest field for exploitation, and in spite of his dissolute life he impudently prayed the regent to give him the archbishopric of Cambrai, the richest in France. His demand was supported by George I., and the regent yielded.

In one day all the usual orders were conferred on him, and even the great preacher Massillon consented to take part in the ceremonies. His next aim was the cardinalate, and, after long and most profitable negotiations on the part of Pope Clement XI., the red hat was given to him by Innocent XIII. (1721), whose election was largely due to the bribes of Dubois. It is estimated that this cardinalate cost France about eight million francs. In the following year he was named first minister of France (August). He was soon after received at the French Academy; and, to the disgrace of the French clergy, he was named president of their assembly.

When Louis XV. attained his majority in 1723 Dubois remained chief minister. He had accumulated an immense private fortune, possessing in addition to his see the revenues of seven abbeys. He was, however, a prey to the most terrible pains of body and agony of mind. His health was ruined by his debaucheries, and a surgical operation became necessary. This was almost immediately followed by his death, at Versailles, on the 10th of August 1723. His portrait was thus drawn by the duc de St Simon:—"He was a little, pitiful, wizened, herring-gutted man, in a flaxen wig, with a weasel's face, brightened by some intellect. All the vices—perfidy, avarice, debauchery, ambition, flattery—fought within him for the mastery. He was so consummate a liar that, when taken in the fact, he could brazenly deny it. Even his wit and knowledge of the world were spoiled, and his affected gaiety was touched with sadness, by the odour of falsehood which escaped through every pore of his body." This famous picture is certainly biased. Dubois was unscrupulous, but so were his contemporaries, and whatever vices he had, he gave France peace after the disastrous wars of Louis XIV.

In 1789 appeared *Vie privée du Cardinal Dubois*, attributed to one of his secretaries, Mongez; and in 1815 his *Mémoires secrets et correspondance inédite*, edited by L. de Sevelinges. See also A. Chervel, *Saint-Simon et l'abbé Dubois*; L. Wiesener, *Le Régent, l'abbé Dubois et les Anglais* (1891); and memoirs of the time.

DUBOIS, JEAN ANTOINE (1765-1848), French Catholic missionary in India, was ordained in the diocese of Viviers in 1792, and sailed for India in the same year under the direction of the Missions Étrangères. He was at first attached to the Pondicherry mission, and worked in the southern districts of the present Madras Presidency. On the fall of Seringapatam in 1799 he went to Mysore to reorganize the Christian community that had been shattered by Tipu Sultan. Among the benefits which he conferred upon his impoverished flock were the founding of agricultural colonies and the introduction of vaccination as a preventive of smallpox. But his great work was his record of *Hindu Manners, Customs and Ceremonies*. Immediately on his arrival in India he saw that the work of a Christian missionary should be based on a thorough acquaintance with the innermost life and character of the native population. Accordingly he abjured European society, adopted the native style of clothing, and made himself in habit and costume as much like a Hindu as he could. He gained an extraordinary welcome amongst people of all castes and conditions, and is still spoken of in many parts of South India with affection and esteem as "the prince's son, the noblest of Europeans." Although Dubois modestly disclaimed the rank of an author, his collections were not so much drawn from the Hindu sacred books as from his own careful and vivid observations, and it is this, united to a remarkable presence, that makes his work so valuable. It is divided into three parts: (1) a general view of society in India, and especially of the caste system; (2) the four states of Brahmical life; (3) religion—feasts, temples, objects of worship. Not only does the abbé give a shrewd, clear-sighted, candid account of the manners and customs of the Hindus, but he provides a very sound estimate of the British position in India, and makes some eminently just observations on the difficulties of administering the Empire according to Western notions of civilization and progress with the limited resources that are available. Dubois's French MS. was purchased for eight thousand rupees by Lord William Bentinck for the East India Company in 1807; in 1816 an

English translation was published, and of this edition about 1864 a curtailed reprint was issued. The abbé, however, largely recast his work, and of this revised text (now in the India Office) an edition with notes was published in 1807 by H. K. Beauchamp. Dubois left India in January 1823, with a special pension conferred on him by the East India Company, and on reaching Paris was appointed director of the Missions Étrangères, of which he afterwards became superior (1836-1839). He translated into French the famous book of Hindu fables called *Panchatantra*, and also a work called *The Exploits of the Guru Paramarta*. Of more interest were his *Letters on the State of Christianity in India*, in which he asserted his opinion that under existing circumstances there was no human possibility of so overcoming the invincible barrier of Brahmical prejudice as to convert the Hindus as a nation to any sect of Christianity. He acknowledged that low castes and outcasts might be converted in large numbers, but of the higher castes he wrote: "Should the intercourse between individuals of both nations, by becoming more intimate and more friendly, produce a change in the religion and usages of the country, it will not be to turn Christians that they will forsake their own religion, but rather . . . to become mere atheists." He died in 1848.

DUBOIS, PAUL (1829-1905), French sculptor and painter, was born at Nogent-sur-Seine on the 18th of July 1829. He studied law to please his family, and art to please himself, and finally adopted the latter, and placed himself under Toussaint. After studying at the École des Beaux-Arts, Dubois went to Rome. His first contributions to the Paris Salon (1860) were busts of "The Countess de B." and "A Child." For his first statues, "St John the Baptist" and "Narcissus at the Bath" (1863), he was awarded a medal of the second class. The statue of "The Infant St John," which had been modelled in Florence in 1860, was exhibited in Paris in bronze, and was acquired by the Luxembourg. "A Florentine Singer of the Fifteenth Century," one of the most popular statuettes in Europe, was shown in 1865; "The Virgin and Child" appeared in the Paris Universal Exhibition in 1867; "The Birth of Eve" was produced in 1873, and was followed by striking busts of Henner, Dr Parrot, Paul Baudry, Pasteur, Gounod and Bonnat, remarkable alike for life, vivacity, likeness, refinement and subtle handling. The chief work of Paul Dubois was "The Tomb of General Lamoricère" in the cathedral of Nantes, a brilliant masterpiece conceived in the Renaissance spirit, with allegorical figures and groups representing Warlike Courage, Charity, Faith and Meditation, as well as bas-reliefs and enrichments; the two first-named works were separately exhibited in the Salon of 1877. The medallions represent Wisdom, Hope, Justice, Force, Rhetoric, Prudence and Religion. The statue of the "Constable Anne de Montmorency" was executed for Chantilly, and that of "Joan of Arc" (1889) for the town of Reims. The Italian influence which characterized the earlier work of Dubois disappeared as his own individuality became clearly asserted. As a painter he restricted himself mainly to portraiture, "My Children" (1876) being probably his most noteworthy achievement. His drawings and copies after the Old Masters are of peculiar excellence: they include "The Dead Christ" (after Sebastian del Piombo) and "Adam and Eve" (after Raphael). In 1873 Dubois was appointed keeper of the Luxembourg Museum. He succeeded Guillaume as director of the École des Beaux-Arts, 1878, and Perraud as member of the Académie des Beaux-Arts. Twice at the Salon he obtained the medal of honour (1865 and 1876), and once at the Universal Exhibition (1878). He also won numerous other distinctions, and was appointed grand cross of the Legion of Honour. He was made a member of several European orders, and in 1895 was elected an honorary foreign academician of the Royal Academy of London. He died at Paris in 1905.

DUBOIS, PIERRE (c. 1250-c. 1312), French publicist in the reign of Philip the Fair, was the author of a series of political pamphlets embodying original and daring views. He was known to Jean du Tillet in the 16th. and to Pierre Dupuy in the 17th century, but remained practically forgotten until the

middle of the 19th century, when his history was reconstructed from his works. He was a Norman by birth, probably a native of Coutances, where he exercised the functions of royal advocate of the bailliage and procurator of the university. He was educated at the university of Paris, where he heard St Thomas Aquinas and Siger of Brabant. He was, nevertheless, no adherent of the scholastic philosophy, and appears to have been conversant with the works of Roger Bacon. Although he never held any important political office, he must have been in the confidence of the court when, in 1300, he wrote his anonymous *Summaria, brevis et compendiosa doctrina felicitis expeditionis et abbreviationis guerrarum et litium regni Francorum*, which is extant in a unique MS., but is analysed by N. de Wailly in the *Bibliothèque de l'École des Chartes* (2nd series, vol. iii.). In the contest between Philip the Fair and Boniface VIII. Dubois identified himself completely with the secularizing policy of Philip, and poured forth a series of anti-clerical pamphlets, which did not cease even with the death of Boniface. His *Supplication du peuple de France au roy contre le pape Boniface le VIII.*, printed in 1614 in *Acta inter Bonifacium VIII. et Philippum Pulchrum*, dates from 1304, and is a heated indictment of the temporal power. He represented Coutances in the states-general of 1302, but in 1306 he was serving Edward I. as an advocate in Guienne, without apparently abandoning his Norman practice by which he had become a rich man. The most important of his works, his treatise *De recuperatione terrae sanctae*,¹ was written in 1306, and dedicated in its extant form to Edward I., though it is certainly addressed to Philip. Dubois outlines the conditions necessary to a successful crusade—the establishment and enforcement of a state of peace among the Christian nations of the West by a council of the church; the reform of the monastic, and especially of the military, orders; the reduction of their revenues; the instruction of a number of young men and women in oriental languages and the natural sciences with a view to the government of Eastern peoples; and the establishment of Philip of Valois as emperor of the East. The king of France was in fact, when once the pope was deprived of the temporal power, to become the suzerain of the Western nations, and in a later and separate memoir Dubois proposed that he should cause himself to be made emperor by Clement V. His zeal for the crusade was probably subordinate to the desire to secure the wealth of the monastic orders for the royal treasury, and to transfer the ecclesiastical jurisdiction to the crown. His ideas on education, on the celibacy of the clergy, and his schemes for the codification of French law, were far in advance of his time. He was an early and violent "Gallican," and the first of the great French lawyers who occupied themselves with high politics. In 1308 he attended the states-general at Tours. He is generally credited with *Quaedam proposita papae a rege super factis Templariorum*, a draft epistle supposed to be addressed to Clement by Philip. This was followed by other pamphlets in the same tone, in one of which he proposed that a kingdom founded on the property of the Templars in the East should be established on behalf of Philip the Tall.

See an article by E. Renan in *Hist. litt. de la France*, vol. xxvi. pp. 471-536; P. Dupuy *Hist. de la condamnation . . . des Templiers* (Brussels, 1713), and *Hist. du différend entre le pape Boniface VIII et Philippe le Bel* (Paris, 1653); and *Notices et extraits de manuscrits*, vol. xx.

DUBOIS, a borough of Clearfield county, Pennsylvania, U.S.A., 129 m. by rail N.E. of Pittsburgh. Pop. (1890) 6149, (1900) 9375, of whom 1655 were foreign-born; (1910 census) 12,623. It is served by the Pennsylvania, the Buffalo, Rochester & Pittsburgh, and the Buffalo & Susquehanna railways. The borough is built on a small plateau surrounded by hills, on the west slope of the Alleghany Mountains, nearly 1400 ft. above sea-level. Its chief importance is as a coal and lumber centre; among its manufacturing establishments are blast furnaces, iron works, machine shops, railway repair shops, tanneries, planing mills, flour mills, locomotive works and a glass factory. Dubois was first settled in 1872, was named in honour of its founder, John Dubois, and was incorporated in 1881.

¹ Printed in *Collections à servir à l'étude de l'histoire* (1891).

DUBOIS-CRANCÉ, EDMOND LOUIS ALEXIS (1747-1814), French Revolutionist, born at Charleville, was at first a musketeer, then a lieutenant of the *maréchaux*, or guardsmen of the old régime. He embraced liberal ideas, and in 1789 was elected deputy to the states-general by the third estate of Vitry-le-François. At the Constituent Assembly, of which he was named secretary in November 1789, he busied himself mainly with military reforms. He wished to see the old military system, with its caste distinctions and its mercenaries, replaced by an organization of national guards in which all citizens should be admitted. In his report, on the 12th of December 1789, he gave utterance for the first time to the idea of *conscription*, which he opposed to the recruiting system of the old régime. His report was not, however, adopted. He succeeded in securing the Assembly's vote that any slave who touched French soil should become free. After the Constituent, Dubois-Crancé was named *maréchal de camp*, but he refused to be placed under the orders of Lafayette and preferred to serve as a simple grenadier. Elected to the Convention by the department of the Ardennes, he sat among the *Montagnards*, but without following any one leader, either Danton or Robespierre. In the trial of Louis XVI. he voted for death without delay or appeal. On the 21st of February 1793 he was named president of the Convention. Although he was a member of the two committees of general defence which preceded that of public safety, he did not belong to the latter at its creation. But he composed a remarkable report on the army, recommending two measures which contributed largely to its success, the rapid advancement of the lower officers, which opened the way for the most famous generals of the Revolution, and the fusion of the volunteers with the veteran troops. In August 1793 Dubois-Crancé was designated "representative on mission" to the army of the Alps, to direct the siege of Lyons, which had revolted against the republic. Accused of lack of energy, he was replaced by G. Couthon. On his return he easily justified himself, but was excluded from the Jacobin club at the instance of Robespierre, before whom he refused to bend. Consequently he was naturally drawn to participate in the revolution of the 9th of Thermidor of the year II., directed against Robespierre. But he would not join the Royalist reaction which followed, and was one of the committee of five which had to oppose the Royalist insurrection of Vendémiaire (see FRENCH REVOLUTION). It was also during this period that Dubois-Crancé was named a member of the committee of public safety, then much reduced in importance. After the Convention, under the Directory, Dubois-Crancé was a member of the Council of the Five Hundred, and was appointed inspector-general of infantry; then, in 1799, minister of war. Opposed to the *coup d'état* of the 18th of Brumaire, he lived in retirement during the Consulate and the Empire. He died at Rethel on the 29th of June 1814. His portrait stands in the foreground in J. L. David's celebrated sketch of the "Oath of the Tennis Court."

Among the numerous writings of Dubois-Crancé may be noticed his *Observations sur la constitution militaire, ou bases du travail proposé au comité militaire*. See H. F. T. Jung, *Dubois de Crancé. L'armée et la Révolution, 1789-1794* (2 vols., Paris, 1884).

DU BOIS-REYMOND, EMIL (1818-1896), German physiologist; was born in Berlin on the 7th of November 1818. The Prussian capital was the place both of his birth and of his life's work, and he will always be counted among Germany's great scientific men; yet he was not of German blood. His father belonged to Neuchâtel, his mother was of Huguenot descent, and he spoke of himself as "being of pure Celtic blood." Educated first at the French college in Berlin, then at Neuchâtel, whither his father had returned, he entered in 1836 the university of Berlin. He seems to have been uncertain at first as to the bent of his studies, for he sat at the feet of the great ecclesiastical historian August Neander, and dabbled with geology; but eventually he threw himself into the study of medicine, with such zeal and success as to attract the notice of the great teacher of anatomy and physiology, who was then making Berlin famous as a school for the sciences ancillary to medicine. Johannes Müller may be regarded as the central figure in the history of modern physiology,

the physiology of the 19th century. Müller's earlier studies had been distinctly physiological; but his inclination, no less than his position as professor of anatomy as well as of physiology in the university of Berlin, led him later on into wide studies of comparative anatomy, and these, aided by the natural bent of his mind towards problems of general philosophy, gave his views of physiology a breadth and a depth which profoundly influenced the progress of that science in his day. He had, about the time when the young Du Bois-Reymond came to his lectures, published his great *Elements of Physiology*, the dominant note of which may be said to be this:—"Though there appears to be something in the phenomena of living beings which cannot be explained by ordinary mechanical, physical or chemical laws, much may be so explained, and we may without fear push these explanations as far as we can, so long as we keep to the solid ground of observation and experiment." Müller recognized in the Neuchâtel lad a mind fitted to carry on physical researches into the phenomena of living things in a legitimate way. He made him in 1840 his assistant in physiology, and as a starting-point for an inquiry put into his hands the essay which the Italian, Carlo Matteucci, had just published on the electric phenomena of animals. This determined the work of Du Bois-Reymond's life. He chose as the subject of his graduation thesis "Electric Fishes," and so commenced a long series of investigations on animal electricity, by which he enriched science and made for himself a name. The results of these inquiries were made known partly in papers communicated to scientific journals, but also and chiefly in his work *Researches on Animal Electricity*, the first part of which appeared in 1848, the last in 1884.

This great work may be regarded under two aspects. On the one hand, it is a record of the exact determination and approximative analysis of the electric phenomena presented by living beings. Viewed from this standpoint, it represents a remarkable advance of our knowledge. Du Bois-Reymond, beginning with the imperfect observations of Matteucci, built up, it may be said, this branch of science. He did so by inventing or improving methods, by devising new instruments of observation or by adapting old ones. The debt which science owes to him on this score is a large one indeed. On the other hand, the volumes in question contain an exposition of a theory. In them Du Bois-Reymond put forward a general conception by the help of which he strove to explain the phenomena which he had observed. He developed the view that a living tissue, such as muscle, might be regarded as composed of a number of electric molecules, of molecules having certain electric properties, and that the electric behaviour of the muscle as a whole in varying circumstances was the outcome of the behaviour of these native electric molecules. It may perhaps be said that this theory has not stood the test of time so well as have Du Bois-Reymond's other more simple deductions from observed facts. It was early attacked by Ludimar Hermann, who maintained that a living untouched tissue, such as a muscle, is not the subject of electric currents so long as it is at rest, is isoelectric in substance, and therefore need not be supposed to be made up of electric molecules, all the electric phenomena which it manifests being due to internal molecular changes associated with activity or injury. Although most subsequent observers have ranged themselves on Hermann's side, it must nevertheless be admitted that Du Bois-Reymond's theory was of great value if only as a working hypothesis, and that as such it greatly helped in the advance of science.

Du Bois-Reymond's work lay chiefly in the direction of animal electricity, yet he carried his inquiries—such as could be studied by physical methods—into other parts of physiology, more especially into the phenomena of diffusion, though he published little or nothing concerning the results at which he arrived. For many years, too, he exerted a great influence as a teacher. In 1858, upon the death of Johannes Müller, the chair of anatomy and physiology, which that great man had held, was divided into a chair of human and comparative anatomy, which was given to K. B. Reichert (1811–1883), and a chair of physiology, which naturally fell to Du Bois-Reymond. This he held to his death, carrying out his researches for many years under unfavourable

conditions of inadequate accommodation. In 1877, through his influence, the government provided the university with a proper physiological laboratory. In 1851 he was admitted into the Academy of Sciences of Berlin, and in 1867 became its perpetual secretary. For many years he and his friend H. von Helmholtz, who like him had been a pupil of Johannes Müller, were prominent men in the German capital. Acceptable at court, they both used their position and their influence for the advancement of science. Both, from time to time as opportunity offered, stepped out of the narrow limits of the professorial chair and gave the world their thoughts concerning things on which they could not well dwell in the lecture room. Du Bois-Reymond, as has been said, had in his earlier years wandered into fields other than those of physiology and medicine, and in his later years he went back to some of these. His occasional discourses, dealing with general topics and various problems of philosophy, show that to the end he possessed the historic spirit which had led him as a lad to listen to Neander; they are marked not only by a charm of style, but by a breadth of view such as might be expected from Johannes Müller's pupil and friend. He died in the city of his birth and adoption on the 26th of November 1896. (M. F.)

DUBOS, JEAN-BAPTISTE (1670–1742), French author, was born at Beauvais in December 1670. After studying for the church, he renounced theology for the study of public law and politics. He was employed by M. de Torcy, minister of foreign affairs, and by the regent and Cardinal Dubois in several secret missions, in which he acquitted himself with great success. He was rewarded with a pension and several benefices. Having obtained these, he retired from political life, and devoted himself to history and literature. He gained such distinction as an author that in 1720 he was elected a member of the French Academy, of which, in 1723, he was appointed perpetual secretary in the room of M. Dacier. He died at Paris on the 23rd of March 1742, repeating as he expired the well-known remark of an ancient, "Death is a law, not a punishment." His first work was *L'Histoire des quatre Gordiens prouvé et illustré par des médailles* (Paris, 1695, 12mo), which, in spite of its ingenuity, did not succeed in altering the common opinion, which only admits three emperors of this name. About the commencement of the war of 1701, being charged with different negotiations both in Holland and in England, with the design to engage these powers if possible to adopt a pacific line of policy, he, in order to promote the objects of his mission, published a work entitled *Les Intérêts de l'Angleterre mal entendus dans la guerre présente* (Amsterdam, 1703, 12mo). But as this work contained indiscreet disclosures, of which the enemy took advantage, and predictions which were not fulfilled, a wag took occasion to remark that the title ought to be read thus: *Les Intérêts de l'Angleterre mal entendus par l'abbé Dubos*. It is remarkable as containing a distinct prophecy of the revolt of the American colonies from Great Britain. His next work was *L'Histoire de la Ligue de Cambray* (Paris, 1709, 1728 and 1785, 2 vols. 12mo), a full, clear and interesting history, which obtained the commendation of Voltaire. In 1734 he published his *Histoire critique de l'établissement de la monarchie française dans les Gaules* (3 vols. 4to)—a work the object of which was to prove that the Franks had entered Gaul, not as conquerors, but at the request of the nation, which, according to him, had called them in to govern it. But this system, though unfolded with a degree of skill and ability which at first procured it many zealous partisans, was victoriously refuted by Montesquieu at the end of the thirtieth book of the *Esprit des lois*. His *Reflexions critiques sur la poésie et sur la peinture*, published for the first time in 1719 (2 vols. 12mo), but often reprinted in three volumes, constitute one of the works in which the theory of the arts is explained with the utmost sagacity and discrimination. Like his history of the League of Cambray, it was highly praised by Voltaire. The work was rendered more remarkable by the fact that its author had no practical acquaintance with any one of the arts whose principles he discussed. Besides the works above enumerated, a manifesto of Maximilian, elector of Bavaria, against the emperor Leopold, relative to the succession in Spain, has been

attributed to Dubos, chiefly, it appears, from the excellence of the style.

DUBUQUE, a city and the county-seat of Dubuque county, Iowa, U.S.A., on the Mississippi river, opposite the boundary line between Wisconsin and Illinois. Pop. (1890) 30,312; (1900) 36,297; (1905, state census) 41,941 (including 6835 foreign-born, the majority of whom were German and Irish); (1910 U.S. census) 38,494. Dubuque is served by the Illinois Central, the Chicago, Milwaukee & Saint Paul (which has repair shops here), the Chicago, Burlington & Quincy, and the Chicago Great Western railways; it also has a considerable river traffic. The river is spanned here by a railway bridge and two wagon bridges. The business portion of the city lies on the low lands bordering the river; many of the residences are built on the slopes and summits of bluffs commanding extensive and picturesque views. Among the principal buildings are the Carnegie-Stout free public library (which in 1908 had 23,600 volumes, exclusive of the valuable Senator Allison collection of public documents), the public high school, and the house of the Dubuque Club. Dubuque is a Roman Catholic archiepiscopal see, and is the seat of St Joseph's College (1873), a small Roman Catholic institution, of Wartburg Seminary (1854), a small Evangelical Lutheran theological school; of the German Presbyterian Theological School of the Northwest (1852); of St Joseph's Ladies' Academy; and of Bayless Business College. Fifteen miles from Dubuque is a monastery of Trappist monks. Among the city's charitable institutions are the Finley and the Mercy hospitals, a home for the friendless, a rescue home, a House of the Good Shepherd, and an insane asylum. In 1900 Dubuque ranked fourth and in 1905 fifth among the cities of the state as a manufacturing centre, the chief products being those of the planing mills and machine shops, and furniture, sashes and doors, liquors, carriages, wagons, coffins, clothing, boots and shoes, river steam boats, barges, torpedo boats, &c., and the value of the factory product being \$9,279,414 in 1905 and \$9,651,247 in 1900. The city lies in a region of lead and zinc mines, quantities of zinc ore in the form of black-jack being taken from the latter. Dubuque is important as a distributing centre for lumber, hardware, groceries and dry-goods.

As early as 1788 Julien Dubuque (1765-1810), attracted by the lead deposits in the vicinity, which were then being crudely worked by the Sauk and Fox Indians, settled here and carried on the mining industry until his death. In June 1829 miners from Galena, Illinois, attempted to make a settlement here in direct violation of Indian treaties, but were driven away by United States troops under orders from Colonel Zachary Taylor. Immediately after the Black Hawk War, white settlers began coming to the mines. Dubuque was laid out under an act of Congress approved on the 2nd of July 1836, and was incorporated in 1841.

DU CAMP, MAXIME (1822-1894), French writer, the son of a successful surgeon, was born in Paris on the 8th of February 1822. He had a strong taste for travel, which his father's means enabled him to indulge as soon as his college days were over. Between 1844 and 1845, and again, in company with Gustave Flaubert, between 1849 and 1851, he travelled in Europe and the East, and made excellent use of his experiences in books published after his return. In 1851 he was one of the founders of the *Revue de Paris* (suppressed in 1858), and was a frequent contributor to the *Revue des deux mondes*. In 1853 he was made an officer of the Legion of Honour. He served as a volunteer with Garibaldi in 1860, and gave an account of his experiences in his *Expédition des deux Siciles* (1861). In 1870 he was nominated for the senate, but his election was frustrated by the downfall of the Empire. He was elected a member of the French Academy in 1880, mainly, it is said, on account of his history of the Commune, published under the title of *Les Convulsions de Paris* (1878-1880). His writings include among others the *Chants modernes* (1855), *Convictions* (1858); numerous works on travel, *Souvenirs et paysages d'orient* (1848), *Égypte, Nubie, Palestine, Syrie* (1852); works of art criticism, *Les Salons de 1857, 1859, 1861*; novels, *L'Homme au bracelet d'or* (1862), *Une*

Histoire d'amour (1880); literary studies, *Théophile Gautier* (1890). Du Camp was the author of a valuable book on the daily life of Paris, *Paris, ses organes, ses fonctions, sa vie dans la seconde moitié du XIX^e siècle* (1869-1875). He published several works on social questions, one of which, the *Mœurs de mon temps*, was to be kept sealed in the Bibliothèque Nationale until 1910. His *Souvenirs littéraires* (2 vols., 1882-1883) contain much information about contemporary writers, especially Gustave Flaubert, of whom Du Camp was an early and intimate friend. He died on the 9th of February 1894. Du Camp was one of the earliest amateur photographers, and his books of travel were among the first to be illustrated by means of what was then a new art.

DU CANGE, CHARLES DU FRESNE, SIEUR (1610-1688), one of the lay members of the great 17th century group of French critics and scholars who laid the foundations of modern historical criticism, was born at Amiens on the 18th of December 1610. At an early age his father sent him to the Jesuits' college at Amiens, where he greatly distinguished himself. Having completed the usual course at this seminary, he applied himself to the study of law at Orleans, and afterwards went to Paris, where in 1631 he was received as an advocate before the parliament. Meeting with very slight success in his profession, he returned to his native city, and in July 1638 married Catherine Dubois, daughter of a royal official, the treasurer in Amiens; and in 1647 he purchased the office of treasurer from his father-in-law, but its duties did not interfere with the literary and historical work to which he had devoted himself since returning to Amiens. Forced to leave his native city in 1668 in consequence of a plague, he settled in Paris, where he resided until his death on the 23rd of October 1688. In the archives of Paris Du Cange was able to consult charters, diplomas, manuscripts and a multitude of printed documents, which were not to be met with elsewhere. His industry was exemplary and unremitting, and the number of his literary works would be incredible, if the originals, all in his own handwriting, were not still extant. He was distinguished above nearly all the writers of his time by his linguistic acquirements, his accurate and varied knowledge, and his critical sagacity. Of his numerous works the most important are the *Glossarium ad scriptores mediæ et infimæ latinitatis* (Paris, 1678), and the *Glossarium ad scriptores mediæ et infimæ græcilitatis* (Lyons, 1688), which are indispensable aids to the student of the history and literature of the middle ages. To the three original volumes of the Latin *Glossarium*, three supplementary volumes were added by the Benedictines of St Maur (Paris, 1733-1736), and a further addition of four volumes (Paris, 1766), by a Benedictine, Pierre Carpentier (1697-1767). There were other editions, and an abridgment with some corrections was brought out by J. C. Adelung (Halle, 1772-1784). The edition in seven volumes edited by G. A. L. Henschel (Paris, 1840-1850) includes these supplements and also further additions by the editor, and this has been improved and published in ten volumes by Léopold Favre (Niort, 1883-1887). An edition of the Greek *Glossarium* was published at Breslau in 1889.

Du Cange took considerable interest in the history of the later empire, and wrote *Historia Byzantina duplici commentario illustrata* (Paris, 1680), and an introduction to his edition and translation into modern French of Geoffroy de Villehardouin's *Histoire de l'empire de Constantinople sous les empereurs français* (Paris, 1657). He also brought out editions of the Byzantine historians, John Cinnamus and John Zonaras, as *Joannis Cinnami historiarum de rebus gestis a Joanne et Manuele Comnenis* (Paris, 1670) and *Joannis Zoharæ Annales ab exordio mundi ad mortem Alexii Comeni* (Paris, 1686). He edited Jean de Joinville's *Histoire de St Louis, roi de France* (Paris, 1668), and his other works which may be mentioned are *Traité historique du chef de St Jean Baptiste* (Paris, 1666); *Lettre du Sieur N., conseiller du roi* (Paris, 1682); *Cyrolli, Philoxeni, aliorumque veterum glossaria*, and *Mémoire sur le projet d'un nouveau recueil des historiens de France, avec le plan général de ce recueil*, which has been inserted by Jacques Lelong in his *Bibliothèque historique de la*

France (Paris, 1768-1778). His last work, *Chronicon Paschale a mundo condito ad Heraclii imperatoris. annum vigesimumum* (Paris, 1689), was passing through the press when Du Cange died, and consequently it was edited by Etienne Baluze, and published with an *Age* of the author prefixed.

His autograph manuscripts and his large and valuable library passed to his eldest son, Philippe du Fresne, who died unmarried in 1692. They then came to his second son, François du Fresne, who sold the collection, the greater part of the manuscripts being purchased by the abbé du Champs. The abbé handed them over to a bookseller named Mariette, who resold part of them to Baron Hoesendorf. The remaining part was acquired by a member of the family of Hozier, the French genealogists. The French government, however, aware of the importance of all the writings of Du Cange, succeeded, after much trouble, in collecting the greater portion of the manuscripts, which were preserved in the imperial library at Paris. Some of these were subsequently published, and the manuscripts are now found in various libraries. The works of Du Cange published after his death are: an edition of the Byzantine historian, Nicephorus Gregoras (Paris, 1702); *De imperatorum Constantinopolitanorum seu inferioris aevi vel imperii usi vocant numismatibus dissertatio* (Rome, 1755); *Histoire de l'état de la ville d'Amiens et de ses comtes* (Amiens, 1840); and a valuable work *Des principautés d'outre-mer*, published by E. G. Rey as *Les Familles d'outre-mer* (Paris, 1869).

See H. Hardouin, *Essai sur la vie et sur les ouvrages de Ducange* (Amiens, 1849); and L. J. Feugère, in the *Journal de l'Instruction publique* (Paris, 1852).

DUCANGE, VICTOR HENRI JOSEPH BRAHAIN (1783-1833), French novelist and dramatist, was born on the 24th of November 1783 at the Hague, where his father was secretary to the French embassy. Dismissed from the civil service at the Restoration, Victor Ducange became one of the favourite authors of the liberal party, and owed some part of his popularity to the fact that he was fined and imprisoned more than once for his outspokenness. He was six months in prison for an article in his journal *Le Diable rose, ou le petit courrier de Lucifer* (1822); for *Valentine* (1821), in which the royalist excesses in the south of France were pilloried, he was again imprisoned; and after the publication of *Hélène ou l'amour et la guerre* (1823), he took refuge for some time in Belgium. Ducange wrote numerous plays and melodramas, among which the most successful were *Marco Lorico, ou le petit Chouan de 1830* (1836), and *Trente ans, ou la vie d'un joueur* (1827), in which Frédéric Lemaître found one of his best parts. Many of his books were prohibited, ostensibly for their coarseness, but perhaps rather for their political tendencies. He died in Paris on the 15th of October 1833.

DUCAS, DUKAS or DOUKAS, the name of a Byzantine family which supplied several rulers to the Eastern Empire. The family first came into prominence during the 9th century, but was ruined when Constantine Ducas, a son of the general Andronicus Ducas, lost his life in his effort to obtain the imperial crown in 913. Towards the end of the 10th century there appeared another family of Ducas, which was perhaps connected with the earlier family through the female line and was destined to attain to greater fortune. A member of this family became emperor as Constantine X. in 1059, and Constantine's son Michael VII. ruled, nominally in conjunction with his younger brothers, Andronicus and Constantine, from 1071 to 1078. Michael left a son, Constantine, and, says Gibbon, "a daughter of the house of Ducas illustrated the blood, and confirmed the succession, of the Comnenian dynasty." The family was also allied by marriage with other great Byzantine houses, and after losing the imperial dignity its members continued to take an active part in public affairs. In 1204 Alexius Ducas, called Mourzoufle, deposed the emperor Isaac Angelus and his son Alexius, and vainly tried to defend Constantinople against the attacks of the Latin crusaders. Nearly a century and a half later one Michael Ducas took a leading part in the civil war between the emperors John V. Palaeologus and John VI. Cantacuzenus, and Michael's

grandson was the historian Ducas (see below). Many of the petty sovereigns who arose after the destruction of the Eastern Empire sought to gain prestige by adding the famous name of Ducas to their own.

DUCAS (15th cent.), Byzantine historian, flourished under Constantine XIII. (XI.) Dragases, the last emperor of the East, about 1450. The dates of his birth and death are unknown. He was the grandson of Michael Ducas (see above). After the fall of Constantinople, he was employed in various diplomatic missions by Dorino and Domenico Gatteluzzi, princes of Lesbos, where he had taken refuge. He was successful in securing a semi-independence for Lesbos until 1462, when it was taken and annexed to Turkey by Sultan Mahommed II. It is known that Ducas survived this event, but there is no record of his subsequent life. He was the author of a history of the period 1341-1462; his work thus continues that of Gregoras and Cantacuzene, and supplements Phrantzes and Chalcondyles. There is a preliminary chapter of chronology from Adam to John Palaeologus I. Although barbarous in style, the history of Ducas is both judicious and trustworthy, and it is the most valuable source for the closing years of the Greek empire. The account of the capture of Constantinople is of special importance. Ducas was a strong supporter of the union of the Greek and Latin churches, and is very bitter against those who rejected even the idea of appealing to the West for assistance against the Turks.

The history, preserved (without a title) in a single Paris MS., was first edited by I. Bullialdus (Bulliaud) (Paris, 1649); later editions are in the *Bonn Corpus scriptorum Hist. By.*, by I. Bekker (1834) and Migne, *Patrologia Graeca*, civil. The Bonn edition contains a 15th century Italian translation by an unknown author, found by Leopold Ranke in one of the libraries of Venice, and sent by him to Bekker.

DUCASSE, PIERRE EMMANUEL ALBERT, BARON (1813-1893), French historian, was born at Bourges on the 16th of November 1813. In 1849 he became aide-de-camp to Prince Jerome Bonaparte, ex-king of Westphalia, then governor of the Invalides, on whose commission he wrote *Mémoires pour servir à l'histoire de la campagne de 1812 en Russie* (1852). Subsequently he published *Mémoires du roi Joseph* (1853-1855), and, as a sequel, *Histoire des négociations diplomatiques relatives aux traités de Morfontaine, de Lunéville et d'Amiens*, together with the unpublished correspondence of the emperor Napoleon I. with Cardinal Feuch (1855-1856). From papers in the possession of the imperial family he compiled *Mémoires du prince Eugène* (1858-1860) and *Réfutation des mémoires du duc de Raguse* (1857), part of which was inserted by authority at the end of volume ix. of the *Mémoires*. He was attaché to Jerome's son, Prince Napoleon, during the Crimean War, and wrote a *Précis historique des opérations militaires en Orient, de mars 1854 à octobre 1855* (1857), which was completed many years later by a volume entitled *La Crimée et Sébastopol de 1853 à 1856, documents intimes et inédits*, followed by the complete list of the French officers killed or wounded in that war (1892). He was also employed by Prince Napoleon on the *Correspondance* of Napoleon I., and afterwards published certain letters, purposely omitted there, in the *Revue historique*. These documents, subsequently collected in *Les Rois frères de Napoléon* (1883), as well as the *Journal de la reine Catherine de Westphalie* (1893), were edited with little care and are not entirely trustworthy, but their publication threw much light on Napoleon I. and his entourage. His *Souvenirs d'un officier du 2^e Zouaves*, and *Les Dessous du coup d'état* (1891), contain many piquant anecdotes, but at times degenerate into mere tittle-tattle. Ducasse was the author of some slight novels, and from the practice of this form of literature he acquired that levity which appears even in his most serious historical publications.

DUCAT, the name of a coin, generally of gold, and of varying value, formerly in use in many European countries. It was first struck by Roger II. of Sicily as duke of Apulia, and bore an inscription "Sic tibi, Christie, datus, quem tu regis, iste ducatus" (Lord, thou rulest this duchy, to thee be it dedicated); hence, it is said, the name. Between 1280 and 1284 Venice also struck

a gold coin, known first as the ducat, afterwards as the zecchino or sequin, the ducat becoming merely a money of account. The ducat was also current in Holland, Austria, the Netherlands, Spain and Denmark (see NUMISMATICS). A gold coin termed a ducat was current in Hanover during the reigns of George I. and George III. A pattern gold coin was also struck by the English mint in 1887 for a proposed decimal coinage. On the reverse was the inscription "one ducat" within an oak wreath; above "one hundred pence," and below the date between two small roses. There is a gold coin termed a ducat in the Austria-Hungary currency, of the value of nine shillings and fourpence.

DU CHAILLU, PAUL BELLONI (1835-1903), traveller and anthropologist, was born either at Paris or at New Orleans (accounts conflict) on the 31st of July 1835. In his youth he accompanied his father, an African trader in the employment of a Parisian firm, to the west coast of Africa. Here, at a station on the Gabun, the boy received some education from missionaries, and acquired an interest in and knowledge of the country, its natural history, and its natives, which guided him to his subsequent career. In 1852 he exhibited this knowledge in the New York press, and was sent in 1855 by the Academy of Natural Sciences at Philadelphia on an African expedition. From 1855 to 1859 he regularly explored the regions of West Africa in the neighbourhood of the equator, gaining considerable knowledge of the delta of the Ogowé river and the estuary of the Gabun. During his travels he saw numbers of the great anthropoid apes called the gorilla (possibly the great ape described by Carthaginian navigators), then known to scientists only by a few skeletons. A subsequent expedition, from 1863 to 1865, enabled him to confirm the accounts given by the ancients of a pygmy people inhabiting the African forests. Narratives of both expeditions were published, in 1861 and 1867 respectively, under the titles *Explorations and Adventures in Equatorial Africa, with Accounts of the Manners and Customs of the People, and of the Chase of the Gorilla, Crocodile, and other Animals; and A Journey to Ashango-land, and further penetration into Equatorial Africa*. The first work excited much controversy on the score of its veracity, but subsequent investigation proved the correctness of du Chaillu's statements as to the facts of natural history; though possibly some of the adventures he described as happening to himself were reproductions of the hunting stories of natives (see *Proc. Zool. Soc.* vol. i., 1905, p. 66). The map accompanying *Ashango-land* was of unique value, but the explorer's photographs and collections were lost when he was forced to flee from the hostility of the natives. After some years' residence in America, during which he wrote several books for the young founded upon his African adventures, du Chaillu turned his attention to northern Europe, and published in 1881 *The Land of the Midnight Sun*, in 1889 *The Viking Age*, and in 1900 *The Land of the Long Night*. He died at St Petersburg on the 29th of April 1903.

DUCHENNE, GUILLAUME BENJAMIN AMAND (1806-1875), French physician, was born on the 17th of September 1806 at Boulogne, the son of a sea-captain. He was educated at Douai, and then studied medicine in Paris until the year 1831, when he returned to his native town to practise his profession. Two years later he first tried the effect of electro-puncture of the muscles on a patient under his care, and from this time on devoted himself more and more to the medical applications of electricity, thereby laying the foundation of the modern science of electro-therapeutics. In 1842 he removed to Paris for the sake of its wider clinical opportunities, and there he worked until his death over thirty years later. His greatest work, *L'Électrisation localisée* (1855), passed through three editions during his lifetime, though by many his *Physiologie des mouvements* (1867) is considered his masterpiece. He published over fifty volumes containing his researches on muscular and nervous diseases, and on the applications of electricity both for diagnostic purposes and for treatment. His name is especially connected with the first description of locomotor ataxy, progressive muscular atrophy, pseudo-hypertrophic paralysis, glosso-labio laryngeal paralysis and other nervous troubles. He died in Paris on the 17th of September 1875.

For a detailed life see *Archives générales de médecine* (December 1875), and for a complete list of his works the 3rd edition of *L'Électrisation localisée* (1872).

DU CHESNE [Latinized **DUCHENIUS**, **QUERNEUS**, or **QUERCETANUS**], **ANDRÉ** (1584-1640), French geographer and historian, generally styled the father of French history, was born at Ile-Bouchard, in the province of Touraine, in May 1584. He was educated at Loudun and afterwards at Paris. From his earliest years he devoted himself to historical and geographical research, and his first work, *Eregiarum seu selectarum lectionum et antiquitatum liber*, published in his eighteenth year, displayed great erudition. He enjoyed the patronage of Cardinal Richelieu, a native of the same district with himself, through whose influence he was appointed historiographer and geographer to the king. He died in 1640, in consequence of having been run over by a carriage when on his way from Paris to his country house at Verrière. Du Chesne's works were very numerous and varied, and in addition to what he published, he left behind him more than 200 folio volumes of manuscript extracts now preserved in the Bibliothèque impériale (L. Delisle, *Le Cabinet des manuscrits de la bibliothèque impériale*, t. L., 333-334). Several of his larger works were continued by his only son François du Chesne (1616-1693), who succeeded him in the office of historiographer to the king. The principal works of André du Chesne are—*Les Antiquités et recherches de la grandeur et majesté des rois de France* (Paris, 1609), *Les Antiquités et recherches des villes, châteaux, &c., de toute la France* (Paris, 1609), *Histoire d'Angleterre, d'Écosse, et d'Irlande* (Paris, 1614), *Histoire des Papes jusqu'à Paul V* (Paris, 1619), *Histoire des rois, ducs, et comtes de Bourgogne* (1619-1628, 2 vols. fol.), *Historiae Normannorum scriptores antiqui* (1619, fol., now the only source for some of the texts), and his *Historiae Francorum scriptores* (5 vols. fol., 1636-1649). This last was intended to comprise 24 volumes, and to contain all the narrative sources for French history in the middle ages; only two volumes were published by the author, his son François published three more, and the work remained unfinished. Besides these du Chesne published a great number of genealogical histories of illustrious families, of which the best is that of the house of Montmorency. His *Histoire des cardinaux français* (2 vols. fol. 1660-1666) and *Histoire des chanceliers et gardes des sceaux de France* (1630) were published by his son François. André also published a translation of the *Satires* of Juvenal, and editions of the works of Alcuin, Abelard, Alain Chartier and Étienne Pasquier.

DUCHESNE, LOUIS MARIE OLIVIER (1843-), French scholar and ecclesiastic, was born at Saint Servan in Brittany on the 13th of September 1843. Two scientific missions—to Mount Athos in 1874 and to Asia Minor in 1876—appeared at first to incline him towards the study of the ancient history of the Christian churches of the East. Afterwards, however, it was the Western church which absorbed almost his whole attention. In 1877 he received the degree of *docteur ès lettres* with two remarkable theses, a dissertation *De Macario magne*, and an *Étude sur le Liber pontificalis*, in which he explained with unerring critical acumen the origin of that celebrated chronicle, determined the different editions and their interrelation, and stated precisely the value of his evidence. Immediately afterwards he was appointed professor at the Catholic Institute in Paris, and for eight years presented the example and model, then rare in France, of a priest teaching church history according to the rules of scientific criticism. His course, bold even to the point of rashness in the eyes of the traditionalist exegetists, was at length suspended. In November 1885 he was appointed lecturer at the École Pratique des Hautes Études. In 1886 he published volume i. of his learned edition of the *Liber pontificalis* (completed in 1892 by volume ii.), in which he resumed and completed the results he had attained in his French thesis. In 1888 he was elected member of the Académie des Inscriptions et Belles-Lettres, and was afterwards appointed director of the French school of archaeology at Rome. Much light is thrown upon the Christian origins, especially those of France, by his *Origines du culte chrétien, étude sur la liturgie latine avant Charlemagne*

(1889; Eng. trans. by M. L. McClure, *Christian Worship: its Origin and Evolution*, London, 1902, 2nd ed. 1904); *Mémoire sur l'origine des diocèses épiscopaux dans l'ancienne Gaule* (1890), the preliminary sketch of a more detailed work, *Fastes épiscopaux dans l'ancienne Gaule* (vol. i. *Les provinces du sud-est*, 1894, and vol. ii. *L'Aquitaine et les Lyonnaises*, 1899); and *Catalogues épiscopaux de la province de Tours* (1898). When a proposal was set on foot to bring about a reconciliation between the Roman Church and the Christian Churches of the East, the Abbé Duchesne endeavoured to show that the union of those churches was possible under the Roman supremacy, because unity did not necessarily entail uniformity. His *Autonomies ecclésiastiques; églises séparées* (1897), in which he speaks of the origin of the Anglican Church, but treats especially of the origin of the Greek Churches of the East, was received with scant favour in certain narrow circles of the pontifical court. In 1906 he began to publish, under the title of *Histoire ancienne de l'église*, a course of lectures which he had already delivered upon the early ages of the Church, and of which a few manuscript copies were circulated. The second volume appeared in 1908. In these lectures Duchesne touches cleverly upon the most delicate problems, and, without any elaborate display of erudition, presents conclusions of which account must be taken. His incisive style, his fearless and often ruthless criticism, and his wide and penetrating erudition, make him a redoubtable adversary in the field of polemic. The *Bulletin critique*, founded by him, for which he wrote numerous articles, has contributed powerfully to spread the principles of the historical method among the French clergy.

Ducis, Jean François (1733–1816), French dramatist and adapter of Shakespeare, was born at Versailles on the 22nd of August 1733. His father, originally from Savoy, was a linen-draper, at Versailles; and all through life he retained the simple tastes and straightforward independence fostered by his bourgeois education. In 1768 he produced his first tragedy, *Amélie*. The failure of this first attempt was fully compensated by the success of his *Homère* (1769), and *Roméo et Juliette* (1772). *Édipe chez Admète*, imitated partly from Euripides and partly from Sophocles, appeared in 1778, and secured him in the following year the chair in the Academy left vacant by the death of Voltaire. Equally successful was *Le Roi Lear* in 1783. *Macbeth* in 1783 did not take so well, and *Jean sans peur* in 1791 was almost a failure; but *Othello* in 1792, supported by the acting of Talma, obtained immense applause. Its vivid picturing of desert life secured for *Abufas, ou la famille arabe* (1795), an original drama, a flattering reception. On the failure of a similar piece, *Phélor et Vladimir ou la famille de Sibérie* (1801), Ducis ceased to write for the stage; and the rest of his life was spent in quiet retirement at Versailles. He had been named a member of the Council of the Ancients in 1798, but he never discharged the functions of the office; and when Napoleon offered him a post of honour under the empire, he refused. Amiable, religious and bucolic, he had little sympathy with the fierce, sceptical and tragic times in which his lot was cast. "Alas!" he said in the midst of the Revolution, "tragedy is abroad in the streets; if I step outside of my door, I have blood to my very ankles. I have too often seen Atrous in clogs, to venture to bring an Atrous on the stage." Though actuated by honest admiration of the great English dramatist, Ducis is not Shakespearian. His ignorance of the English language left him at the mercy of the translations of Pierre Letourneur (1736–1788) and of Pierre de la Place (1707–1793); and even this modified Shakespeare had still to undergo a process of purification and correction before he could be presented to the fastidious criticism of French taste. That such was the case was not, however, the fault of Ducis; and he did good service in modifying the judgment of his fellow countrymen. He did not pretend to reproduce, but to excerpt and refashion; and consequently the French play sometimes differs from its English namesake in everything almost but the name. The plot is different, the characters are different, the motifs different, and the scenic arrangement different. To *Othello*, for instance, he wrote two endings. In one of them Othello was enlightened in

time and Desdemona escaped her tragic fate. *Le Banquet de Famille*, a poem in four cantos (1771), *Au roi de Sardaigne* (1775), *Discours de réception à l'Académie française* (1779), *Épître à Famille* (1786), and a *Recueil de poésies* (1809), complete the list of Ducis's publications.

An edition of his works in three volumes appeared in 1813; *Œuvres posthumes* were edited by Camperon in 1826; and *Hamlet, Édipe chez Admète, Macbeth and Abufas* are reprinted in vol. ii. of Didot's *Chefs-d'œuvre tragiques*. See Onésime Leroy, *Étude sur la personne et les écrits de Ducis* (1832), based on Ducis's own memoirs preserved in the library at Versailles; Sainte-Beuve, *Causeries de lundi*, t. vi., and *Notre-Dame de la Salette*, t. iv.; Villeman, *Tableau de la litt. au XVIII^e siècle*.

DUCK. (1) (From the verb "to duck," to dive, put the head under water, in reference to the bird's action, cf. Dutch *duiker*, Ger. *Taucher*, diving-bird, *duiken*, *tauchen*, to dip, dive, Dan. *dukaad*, duck, and Ger. *Ente*, duck; various familiar and slang usages are based on analogy with the bird's action), the general English name for a large number of birds forming the greater part of the family *Anatidae* of modern ornithologists. Technically the term duck is restricted to the female, the male being called drake (cognate with the termination of Ger. *Enterich*), and in one species mallard (Fr. *Mallard*).

The *Anatidae* may be at once divided into six more or less well marked subfamilies—(1) the *Cygninae* or swans, (2) the *Anserinae* or geese—which are each very distinct, (3) the *Anatinae* or freshwater-ducks, (4) those commonly called *Fuligininae* or sea-ducks, (5) the *Eristarinae* or spiny-tailed ducks, and (6) the *Merginae* or mergansers.

The *Anatinae* are the typical group, and it is these only that are considered here. We start with the *Anas boschas* of Linnaeus, the common wild duck, which from every point of view is by far the most important species, as it is the most plentiful, the most widely distributed, and the best known—being indeed the origin of all the British domestic breeds. It inhabits the greater part of the northern hemisphere, reaching in winter so far as the Isthmus of Panama in the New World, and in the Old being abundant at the same season in Egypt and north-western India, while in summer it ranges throughout the Fur-Countries, Greenland, Iceland, Lapland and Siberia. Most of those which fill British markets are no doubt bred in more northern climes, but a considerable proportion of them are yet produced in the British Islands, though not in anything like the numbers that used to be supplied before the draining of the great fen-country and other marshy places. The wild duck pairs very early in the year—the period being somewhat delayed by hard weather, and the ceremonies of courtship, which require some little time. Soon after these are performed, the respective couples separate in search of suitable nesting-places, which are generally found, by those that remain with us, about the middle of March. The spot chosen is sometimes near a river or pond, but often very far removed from water, and it may be under a furze-bush, on a dry heath, at the bottom of a thick hedge-row, or even in any convenient hole in a tree. A little dry grass is generally collected, and on it the eggs, from 9 to 11 in number, are laid. So soon as incubation commences the mother begins to divest herself of the down which grows thickly beneath her breast-feathers, and adds it to the nest-furniture, so that the eggs are deeply imbedded in this heat-retaining substance—a portion of which she is always careful to pull, as a coverlet, over her treasures when she quits them for food. She is seldom absent from the nest, however, but once, or at most twice, a day, and then she dares not leave it until her mate, after several circling flights of observation, has assured her she may do so unobserved. Joining him the pair betake themselves to some quiet spot where she may bathe and otherwise refresh herself. Then they return to the nest, and after cautiously reconnoitring the neighbourhood, she loses no time in reseatting herself on her eggs, while he, when she is settled, repairs again to the waters, and passes his day listlessly in the company of his brethren, who have the same duties, hopes and cares. Short and infrequent as are the absences of the duck when incubation begins, they become shorter and more infrequent towards its close, and for the last day or two of the

is necessary to develop the young it is probable that she will not stir from the nest at all. When all the fertile eggs are hatched her next care is to get the brood safely to the water. This, when the distance is great, necessarily demands great caution, and so cunningly is it done that but few persons have encountered the mother and offspring as they make the dangerous journey.¹ If disturbed the young instantly hide as they best can, while the mother quacks loudly, feigns lameness, and flutters off to divert the attention of the intruder from her brood, who lie motionless at her warning notes. Once arrived at the water they are comparatively free from harm, though other perils present themselves from its inmates in the form of pike and other voracious fishes, which seize the ducklings as they disport in quest of insects on the surface or dive beneath it. Throughout the summer the duck continues her care unremittingly, until the young are full grown and feathered; but it is no part of the mallard's duty to look after his offspring, and indeed he speedily becomes incapable of helping them, for towards the end of May he begins to undergo his extraordinary additional moult, loses the power of flight, and does not regain his full plumage till autumn. About harvest-time the young are well able to shift for themselves, and then resort to the corn-fields at evening, where they fatten on the scattered grain. Towards the end of September or beginning of October both old and young unite in large flocks and betake themselves to the larger waters. If long-continued frost prevail, most of the ducks resort to the estuaries and tidal rivers, or even leave these islands almost entirely. Soon after Christmas the return-flight commences, and then begins anew the course of life already described.

For the farmyard varieties, descending from *Anas boschas*, see Poultry. The domestication of the duck is very ancient. Several distinct breeds have been established, of which the most esteemed from an economical point of view are those known as the Rouen and Aylesbury; but perhaps the most remarkable deviation from the normal form is the so-called penguin-duck, in which the bird assumes an upright attitude and its wings are much diminished in size. A remarkable breed also is that often named (though quite fancifully) the "Buenos-Ayres" duck, wherein the whole plumage is of a deep black, beautifully glossed or bronzed. But this saturation, so to speak, of colour only lasts in the individual for a few years, and as the birds grow older they become mottled with white, though as long as their reproductive power lasts they "breed true." The amount of variation in domestic ducks, however, is not comparable to that found among pigeons, no doubt from the absence of the competition which pigeon-fanciers have so long exercised. One of the most curious effects of domestication in the duck, however, is, that whereas the wild mallard is not only strictly monogamous, but, as Waterton believed, a most faithful husband, remaining paired for life, the civilized drake is notoriously polygamous.

Very nearly allied to the common wild duck are a considerable number of species found in various parts of the world in which there is little difference of plumage between the sexes—both being of a dusky hue—such as *Anas obscura*, the commonest river-duck of America, *A. superciliosa* of Australia, *A. poecilorhyncha* of India, *A. melleri* of Madagascar, *A. zanthorhyncha* of South Africa, and some others.

Among the other genera of *Anatinae*, we must content ourselves by saying that both in Europe and in North America there are the groups represented by the shoveller, garganey, gadwall, teal, pintail and widgeon—each of which, according to some systematists, is the type of a distinct genus. Then there is the group *Aix*, with its beautiful representatives the wood-duck (*A. sponsa*) in America and the mandarin-duck (*A. galericulata*) in Eastern Asia. Besides there are the sheldrakes (*Tadorna*), confined to the Old World and remarkably developed in the Australian Region; the musk-duck (*Cairina*) of South America, which is often domesticated and in that condition

¹ When ducks breed in trees, the precise way in which the young get to the ground is still a matter of uncertainty. The mother is supposed to convey them in her bill, and most likely does so, but they are often simply allowed to fall.

will produce hybrids with the common duck; and finally the tree-ducks (*Dendrocygna*), which are almost limited to the tropics. (For duck-shooting, see SHOOTING.) (A. N.)

² (Probably derived from the Dutch *doeck*, a coarse linen material, cf. Ger. *Tuch*, cloth), a plain fabric made originally from tow yarns. The cloth is lighter than canvas or sailcloth, and differs from these in that it is almost invariably single in both warp and weft. The term is also used to indicate the colour obtained at a certain stage in the bleaching of flax yarns; it is a colour between half-white and cream, and this fact may have something to do with the name. Most of the flax ducks (tow yarns) appear in this colour, although quantities are bleached or dyed. Some of the ducks are made from long flax, dyed black, and used for kit-bags, while the dyed tow ducks may be used for inferior purposes. The fabric, in its various qualities and colours, is used for an enormous variety of purposes, including tents, wagon and motor hoods, light sails, clothing, workmen's overalls, bicycle tubes, mail and other bags and pocketings. *Russian duck* is a fine white linen canvas.

DUCKING and CUCKING STOOLS, chairs used for the punishment of scolds, witches and prostitutes in bygone days. The two have been generally confused, but are quite distinct. The earlier, the Cucking-stool¹ or Stool of Repentance, is of very ancient date, and was used by the Saxons, who called it the *Scalding* or *Scolding Stool*. It is mentioned in Domesday Book as in use at Chester, being called *cathedra stercoris*, a name which seems to confirm the first of the derivations suggested in the footnote below. Seated on this stool the woman, her head and feet bare, was publicly exposed at her door or paraded through the streets amidst the jeers of the crowd. The Cucking-stool was used for both sexes, and was specially the punishment for dishonest brewers and bakers. Its use in the case of scolding women declined on the introduction in the middle of the 16th century of the Scold's Bridle (see BRANKS), and it disappears on the introduction a little later of the Ducking-stool. The earliest record of the use of this latter is towards the beginning of the 17th century. It was a strongly made wooden armchair (the surviving specimens are of oak) in which the culprit was seated, an iron band being placed around her so that she should not fall out during her immersion. Usually the chair was fastened to a long wooden beam fixed as a seasaw on the edge of a pond or river. Sometimes, however, the Ducking-stool was not a fixture but was mounted on a pair of wooden wheels so that it could be wheeled through the streets, and at the river-edge was hung by a chain from the end of a beam. In sentencing a woman the magistrates ordered the number of duckings she should have. Yet another type of Ducking-stool was called a tumbrel. It was a chair on two wheels with two long shafts fixed to the axles. This was pushed into the pond and then the shafts released, thus tipping the chair up backwards. Sometimes the punishment proved fatal, the unfortunate woman dying of shock. Ducking-stools were used in England as late as the beginning of the 19th century. The last recorded cases are those of a Mrs Ganble at Plymouth (1808); of Jenny Pipes, "a notorious scold" (1809), and Sarah Leeke (1817), both of Leominster. In the last case the water in the pond was so low that the victim was merely wheeled round the town in the chair.

See W. Andrews, *Old Time Punishments* (Hull, 1890); A. M. Earle, *Curious Punishments of Bygone Days* (Chicago, 1896); W. C. Hazlitt, *Faiths and Folklore* (London, 1905); Llewellyn Jewitt in *The Reliquary*, vols. i. and ii. (1860-1862); *Gentleman's Magazine* for 1732.

DUCKWEED, the common botanical name for species of *Lemna* which form a green coating on fresh-water ponds and ditches. The plants are of extremely simple structure and are the smallest and least differentiated of flowering plants. They consist of a so-called "frond"—a flattened green more or less oval structure which emits branches similar to itself from lateral pockets at or near the base. From the under surface a root with a well-developed sheath grows downwards into the water. The flowers, which are rarely found in Britain, are

² Probably from "cuck," to void excrement; but variously connected with Fr. *coquin*, rascal.

developed in one of the lateral pockets. The inflorescence is a very simple one, consisting of one or two male flowers each comprising a single stamen, and a female flower comprising a flask-shaped pistil. The order Lemnaceae to which they belong

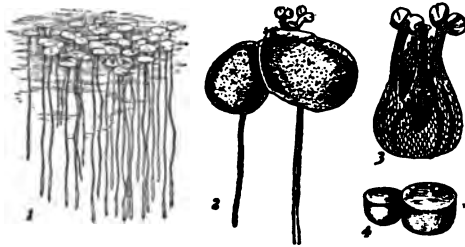

- 1, *Lemna minor* (Lesser Duckweed) nat. size.
 2, Plant in flower.
 3, Inflorescence containing two male flowers each of one stamen, and a female flower, the whole enclosed in a sheath.
 4, *Wolffia arrhiza*. (2, 3, 4 enlarged.)

is regarded as representing a very reduced type nearly allied to the Aroids. It is represented in Britain by four species of *Lemna*, and a still smaller and simpler plant, *Wolffia*, in which the fronds are only one-twentieth of an inch long and have no roots.

DUCKWORTH, SIR JOHN THOMAS (1748-1817), British admiral, was born at Leatherhead, in Surrey, on the 28th of February 1748. He entered the navy in 1759, and obtained his commission as lieutenant in June 1770, when he was appointed to the "Princess Royal," the flagship of Admiral Byron, in which he sailed to the West Indies. While serving on board this vessel he took part in the engagement with the French fleet under Count D'Estaing. In July 1779 he became commander, and was appointed to the "Rover" sloop; in June of the following year he attained the rank of post-captain. Soon afterwards he returned to England in charge of a convoy. The outbreak of the war with France gave him his first opportunity of obtaining marked distinction. Appointed first to the "Orion" and then to the "Queen" in the Channel Fleet, under the command of Lord Howe, he took part in the three days' naval engagement with the Brest fleet, which terminated in a glorious victory on the 1st of June 1794. For his conduct on this occasion he received a gold medal and the thanks of parliament. He next proceeded to the West Indies, where he was stationed for some time at St Domingo. In 1798 he commanded the "Leviathan" in the Mediterranean, and had charge of the naval detachment which, in conjunction with a military force, captured Minorca. Early in 1799 he was raised to the rank of rear-admiral, and sent to the West Indies to succeed Lord Hugh Seymour. During the voyage out he captured a valuable Spanish convoy of eleven merchantmen. In March 1801 he was the naval commander of the combined force which reduced the islands of St Bartholomew and St Martin, a service for which he was rewarded with the order of the Bath and a pension of £1000 a year. Promoted to vice-admiral of the blue, he was appointed in 1804 to the Jamaica station. Two years later, while cruising off Cadiz with Lord Collingwood, he was detached with his squadron to pursue a French fleet that had been sent to the relief of St Domingo. He came up with the enemy on the 6th February 1806, and, after two hours' fighting, inflicted a signal defeat upon them, capturing three of their five vessels and stranding the other two. For this, the most distinguished service of his life, he received the thanks of the Jamaica assembly, with a sword of the value of a thousand guineas, the thanks of the English parliament, and the freedom of the city of London. In 1807 he was again sent to the Mediterranean to watch the movements of the Turks. In command of the "Royal George" he forced the passage of the Dardanelles, but sustained considerable loss in effecting his return, the Turks having strengthened their position while he was being kept in

play by their diplomatists and Napoleon's ambassador General Sebastiani. He held the command of the Newfoundland fleet for four years from 1810, and at the close of that period he was made a baronet. In 1815 he was appointed to the chief command at Plymouth, which he held until his death on the 14th of April 1817. Sir John Duckworth sat in parliament for some time as member for New Romney.

See *Naval Chronicle*, xviii.; Ralle's *Naval Biography*, ii.

DUCLAUX, AGNES MARY F. (1856-), English poet and critic, who first became known in England under her maiden name of Mary F. Robinson, was born at Leamington on the 27th of February 1856. She was educated at University College, London, devoting herself chiefly to the study of Greek literature. Her first volume of poetry, *A Handful of Honeysuckle*, was published in 1879. Her next work was a translation from Euripides, *The Crowned Hippolytus* (1881). Monographs on Emily Brontë (1883) and on Marguerite of Angoulême (1886) followed; and *The New Arcadia and other Poems* (1884) and *An Italian Garden* (1886) contain some of her best verses. Her poems attracted the attention of the orientalist, James Darmesteter (q.v.), then in Peshawar, and he made an admirable translation of them in French. The acquaintance led to their marriage in 1888, and from that time a large part of her work was done in French. Madame Darmesteter translated her husband's *Études anglaises* into English (1896). Her most considerable prose work is the *Life of Ernest Renan* (1897). She also wrote the *End of the Middle Ages* (1888); the volume on *Froissart* (1894) in the *Grands écrivains français; essays on the Brontës, the Brownings and others*, entitled *Grands écrivains d'Outre-Manche* (1901). After Darmesteter's death, she married in 1901 Émile Duclaux, the associate of Pasteur, and director of the Pasteur institute. He died in 1904. She published *Retrospect and other Poems* in 1893, and in 1904 appeared *The Return to Nature, Songs and Symbols*. The qualities of Mary Robinson's work, its conciseness and purity of expression, were only gradually recognized. Her *Collected Poems, Lyrical and Narrative* were published in 1902.

DUCLOS, CHARLES PINOT (1704-1772), French author, was born at Dinan, in Brittany, in 1704. At an early age he was sent to study at Paris. After some time spent in dissipation he began to cultivate the society of the wits of the time, and became a member of the club or association of young men who published their joint efforts in light literature under the titles of *Recueil de ces messieurs, Étrennes de la St-Jean, Œufs de Pâques, &c.* His romance of *Acajou and Zirphile*, composed to suit a series of plates which had been engraved for another work, was one of the fruits of this association, and was produced in consequence of a sort of wager amongst its members. Duclos had previously written two other romances, which were more favourably received—*The Baroness de Luas* (1741), and the *Confessions of the Count de**** (1747). His first serious publication was the *History of Louis XI.*, which is dry and epigrammatical in style, but displays considerable powers of research and impartiality. The reputation of Duclos as an author was confirmed by the publication of his *Considérations sur les mœurs de ce siècle* (1751), a work justly praised by Laharpe, as containing a great deal of sound and ingenious reflection. It was translated into English and German. The *Mémoires pour servir à l'histoire du dix-huitième siècle*, intended by the author as a sort of sequel to the preceding work, are much inferior in style and matter, and are, in reality, little better than a kind of romance. In consequence of his *History of Louis XI.*, he was appointed historiographer of France, when that place became vacant on Voltaire's retirement to Prussia. His *Secret Memoirs of the Reigns of Louis XIV. and Louis XV.* (for which he was able to utilize the *Mémoires* of Saint Simon, suppressed in 1755), were not published until after the Revolution.

Duclos became a member of the Academy of Inscriptions in 1739, and of the French Academy in 1747, being appointed perpetual secretary in 1747. Both academies were indebted to him not only for many valuable contributions, but also for several useful regulations and improvements. As a member of the

Academy of Inscriptions, he composed several memoirs on trial by combat, on the origin and revolutions of the Celtic and French languages, and on scenic representations and the ancient drama. As a member of the French Academy, he assisted in compiling the new edition of the *Dictionary*, which was published in 1762; and he made some just and philosophical remarks on the *Port Royal Grammar*. On several occasions he distinguished himself by vindicating the honour and prerogatives of the societies to which he belonged, and the dignity of the literary character in general. He used to say of himself, "I shall leave behind me a name dear to literary men." The citizens of Dinan, whose interests he always supported with zeal, appointed him mayor of their town in 1744, though he was resident at Paris, and in this capacity he took part in the assembly of the estates of Brittany. Upon the requisition of this body the king granted him letters of nobility. In 1763 he was advised to retire from France for some time, having rendered himself obnoxious to the government by the opinions he had expressed on the dispute between the duc d'Aiguillon and M. de la Chalotais, the friend and countryman of Duclos. Accordingly he set out first for England (1763), then for Italy (1766); and on his return he wrote his *Considerations on Italy*. He died at Paris on the 26th of March 1772. The character of Duclos was singular in its union of impulsiveness and prudence. Rousseau described him very laconically as a man *droit et adroit*. In his manners he displayed a sort of bluntness in society, which frequently rendered him disagreeable; and his caustic wit on many occasions created enemies. To those who knew him, however, he was a pleasant companion. A considerable number of his *bons mots* have been preserved by his biographers.

A complete edition of the works of Duclos, including an unfinished autobiography, was published by Auger (1821). See also Saint-Beuve, *Causeries du lundi*, t. ix.; René Kerviler, *La Bretagne et l'Académie française du XVIII^e siècle* (1889); L. Mandon, *De la valeur historique des mémoires secrets de Duclos* (1872).

DUCOS, PIERRE ROGER (1754-1816), French politician and director, was born at Dax. He was an advocate when elected deputy to the Convention by the department of the Landes. He sat in the "Plain," i.e. in the party which had no opinion of its own, which always leaned to the stronger side. He voted for the death of Louis XVI., without appeal or delay, but played no noticeable part in the Convention. He was a member of the Council of the Five Hundred, over which he presided on the 18th of Fructidor in the year V. (see FRENCH REVOLUTION). At the end of his term he became a judge of the peace, but after the parliamentary *coup d'Etat* of the 30th of Prairial of the year VIII. he was named a member of the executive Directory, thanks to the influence of Barras, who counted on using him as a passive instrument. Duclos accepted the *coup d'Etat* of Bonaparte on the 18th of Brumaire, and was one of the three provisional consuls. He became vice-president of the senate. The Empire heaped favours upon him, but in 1814 he abandoned Napoleon, and voted for his deposition. He sought to gain the favour of the government of the Restoration, but in 1816 was exiled in virtue of the law against the regicides. He died in March 1816 at Ulm, from a carriage accident. In spite of his absolute lack of talent, he attained the highest of positions—an exceptional fact in the history of the French Revolution.

DUCTLESS GLANDS, in anatomy: A certain number of glands in the body, often of great physiological importance, have no ducts (Lat. *ductus*, from *ducere*, to lead, i.e. vessels, tubes or canals for conveying away fluid or other substance); and their products, known as internal secretions, are at once carried away by the veins or lymphatics which drain them. Among these structures are the *spleen*, the *adrenals*, the *thyroid gland*, the *parathyroids*, the *thymus* and the *carotid* and *coxygeal* bodies. In addition to these the lymphatic glands are described in the article on the lymphatic system (*q.v.*), and the pineal and pituitary bodies in the article on the brain (*q.v.*).

THE SPLEEN

The human *spleen* (Gr. *σπλήν*) is an oval, flattened gland, of a dull purple colour, and about 5 in. long by 3 broad, situated in the upper and back part of the left side of the abdominal cavity. If the right hand is passed round the left side of its owner's body, as far as it will reach, it approximately covers the spleen. The long axis of the organ is obliquely placed so that the upper pole is much nearer the vertebral column than the lower pole. For practical purposes the long axis of the left tenth rib corresponds with that of the spleen. There is an external

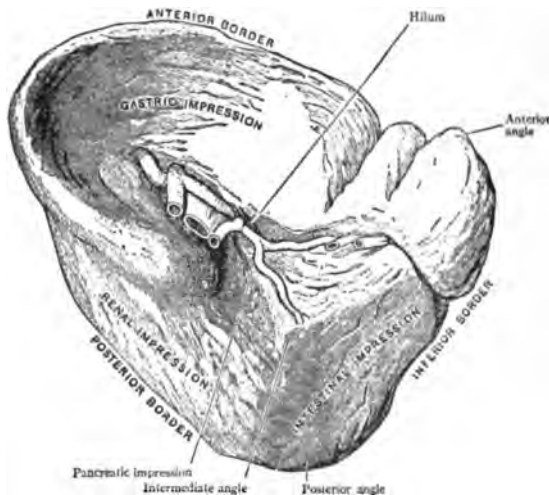

From D. J. Cunningham, Cunningham's Text-book of Anatomy.

FIG. 1.—The Spleen—Visceral Aspect.

or parietal surface and an internal or visceral, the latter of which is again subdivided; these surfaces are limited by ventral and dorsal borders. The external, parietal, or phrenic surface is convex to adapt it to the concavity of the diaphragm, against the posterior part of which it lies; external to the diaphragm is the pleural cavity, and more externally still, the ninth, tenth and eleventh ribs. The internal or visceral surface is divided by a prominent ridge into a gastric or anterior and a renal or posterior surface. Sometimes a triangular impression called the basal surface is formed at the lower part of the visceral surface by the left end of the transverse colon, though at other times no such impression is seen. It is probable that the exact shape of the spleen depends a good deal on the amount of distension of the surrounding hollow viscera at the time of death. (For details of the basal surface see D. J. Cunningham, *Journ. Anat. and Phys.* vol. xxix. p. 501.) The gastric surface is concave and adapts itself to the fundus of the stomach, while just in front of the ridge separating the gastric and renal surfaces is the hilum, where the vessels enter and leave the organ; in front of this the tail of the pancreas usually touches the spleen. The renal surface is as a rule smaller than the gastric and, like it, is concave; it is moulded on to the upper part of the outer border of the left kidney and just reaches the left adrenal body. The anterior or ventral border of the spleen has usually two or more notches in it, though these are often also seen on the dorsal border. The whole spleen is surrounded by peritoneum, which is reflected off on to the stomach as the gastro-splenic omentum, and on to the kidney as the lienorenal ligament; occasionally the lesser sac reaches it near its connexion with the pancreas. Small accessory spleens are fairly often found in the neighbourhood of the spleen, though it is possible that some of these may be haemo-lymph glands (see LYMPHATIC SYSTEM).

Microscopically the spleen has a fibro-elastic coat in which involuntary muscle is found (fig. 2). This coat sends multitudes of fine trabeculae into the interior of the organ, which subdivide it into numbers of minute compartments, in which the red, highly vascular, spleen pulp is contained. This pulp contains small spherical masses of adenoid tissue, forming the Malpighian corpuscles, situated on the terminal branches of the splenic blood-vessels, together with numerous cells, some of which are red blood corpuscles, others lymph corpuscles, others contain pigment granules or fat, while others have in their interior numerous blood corpuscles. The arteries of the spleen in part end in capillaries from which the veins arise, but more frequently they open into lacunae or blood spaces, which give origin to the veins.

Embryology.—The spleen is developed in the dorsal mesogastrum (see COELOM AND SEROUS MEMBRANES) from the mesenchyme, or that portion of the mesoderm, the cells of which lie scattered in a matrix. Large lymphoid cells are early seen among those of the mesenchyme, but whether these migrate from the coelomic epithelium, or are originally mesenchymal is doubtful, though the former seems more probable. The network of the spleen seems certainly to be derived from cells of the mesenchyme which lose their nuclei.

Comparative Anatomy.—The spleen is regarded as the remains of a mass of lymphoid tissue which, in a generalized type of vertebrate, stretched all along the alimentary canal. It is absent as a distinct gland in the Acrania and Cyclostomata. In the fishes it is closely applied to the U-shaped stomach, and in some of the Elasmobranchs, e.g. the basking and porbeagle sharks (*Selache* and *Lamna*), it is divided into small lobules. In Protopterus among the Dipnoi it is enclosed within the walls of the stomach. In the *Anura* (frogs and toads) among the Amphibia it is a spherical mass close to the rectum, and this may be explained by regarding it as derived from a different part of the original mass, already mentioned, to that which persists in other vertebrates. In the Iguana among the reptiles the organ has many notches, and each one corresponds to the point of entrance of a vessel. In Mammals the notches, when they are present, so frequently correspond to the points of entrance of arteries at the hilum that the present writer believes that the former are determined by the latter in many cases (see F. G. Parsons on the Notches of the Spleen, *J. Anat. and Phys.* vol. 35, p. 416; also Charnock Bradley, *Proceedings of R. Soc. Edin.*, vol. 24, pt. 6, p. 521). The Monotremata and Marsupialia have curious Y-shaped spleens. As a rule flesh-eating animals have larger and more notched spleens than vegetable feeders, though among the Cetacea the spleen is relatively very small.

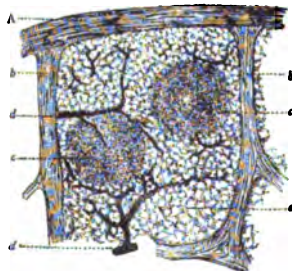

FIG. 2.—Section of the Spleen seen under a low power.

A, Fibrous capsule. B, Blood-vessels. C, Splenic pulp. D, Malpighian corpuscles.

ADRENAL GLANDS

The adrenal glands or suprarenal capsules are two conical bodies, flattened from before backward, resting on the upper poles of the kidneys close to the sides of the vertebral column; each has an anterior and posterior surface and a concave base which is in contact with the kidney. When viewed from in front the right gland is triangular and the left crescentic. On the anterior surface there is a transverse sulcus or hilum from which a large vein emerges. The arteries are less constant in their points of entry, and are derived from three sources, the phrenic, the abdominal aorta and the renal arteries. The glands are entirely retro-peritoneal, though the right one, even on its anterior surface, is very little covered by peritoneum. In a vertical transverse section each gland is seen to consist of two parts, cortical and medullary. The cortical substance is composed of bundles of cells, separated by a stroma, which have a

different appearance in different parts. Most superficially is the zona glomerulosa, then the zona fascicularis, and most deeply the zona reticularis. These names convey a fair idea of the appearance of the bundles. To the naked eye the cortical

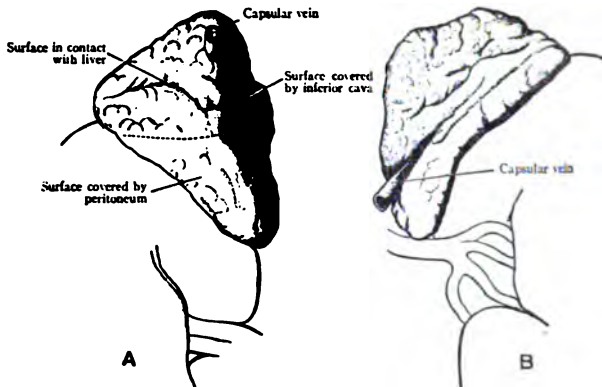

From D. J. Cunningham, Cunningham's *Text-book of Anatomy*.

FIG. 3.—A, Anterior surface of right suprarenal capsule. B, Anterior surface of left suprarenal capsule. The upper and inner parts of each kidney are indicated in outline. On the right capsule the dotted line indicates the upper limit of the peritoneal covering.

part is yellow while the medullary is red. The medullary part consists of small islets of cells, which resemble columnar epithelium lying among venous sinuses; these cells are said to be in close connexion with the sympathetic nerve filaments from the great solar plexus.

Embryology.—The generally accepted opinion at present is that the cortical substance is derived from the coelomic epithelium covering the mesoderm of the upper (cephalic) portion of the Wolfian body, and corresponds to the nephrostomes of mesonephridial tubules (see URINARY SYSTEM), while the medullary part grows out from the sympathetic ganglia and so is probably ectodermal in origin. J. Janosik, however (*Archiv. f. mikrosk. Anat.* bd. xxii, 1883 and *Sitzungsber. d. Wiener Akad.*, 1885), thinks that the cortical part is derived from the germ epithelium covering the upper part of the genital ridge. C. S. Minot (*Human Embryology*, 1897) believes that the original cells which grow in from the sympathetic disappear later, and that the adult medullary cells are derived from the cortical.

In the early human embryo the adrenals are larger than the kidneys, and at birth they are proportionately much larger than in the adult. (For literature see *Development of the Human Body*, J. P. McMurrich, London, 1906; and *Handbuch der Entwicklungslehre*, by O. Hertwig, Jena.)

Comparative Anatomy.—Adrenals are unknown in Amphioxus and the Dipnoi (mud fish). In the Cyclostomata (hags and lampreys) they are said by some to arise in connexion with the cephalic part of the pronephros, though other writers deny their presence at all (see W. E. Collinge and Swale Vincent, *Anat. Anz.* bd. xii, 1896). In the Elasmobranchs and Holocephali the medullary and cortical parts are apparently distinct, the former being represented by a series of organs situated close to the intercostal arteries, while the latter may be either median or paired, and, as they are placed between the kidneys, are often spoken of as interrenals. In the Amphibia the glands are sunk into the surface of the kidney. In reptiles and birds they are long lobulated bodies lying close to the testis or ovary and receiving an adrenal portal vein. In the lower mammals they are not as closely connected with the kidneys as they are in man, and their shape is usually oval or spherical.

THE THYROID GLAND

The thyroid body or gland is a deep red glandular mass consisting of two lobes which lie one on each side of the upper part of the trachea and lower part of the larynx; these are joined across the middle line by the isthmus which lies in front of the second and third rings of the trachea. Occasionally, from the top of the isthmus, a nearly but not quite median pyramidal lobe runs up toward the hyoid bone, while in other cases the isthmus may be absent. The gland is relatively larger in women and

children than in the adult male. It is enclosed in a capsule of cervical fascia and is supplied by the superior and inferior thyroid arteries on each side, though occasionally a median thyroidea ima artery is present. On microscopical examination the gland shows a large number of closed tubular alveoli, lined by columnar epithelial cells, unsupported by a basement membrane, and filled with colloid or jelly-like material. These are supported by fibrous septa growing in from the true capsule, which is distinct from the capsule of cervical fascia. The lymphatic vessels are large and numerous, and have been shown by E. C. Baber (*Phil. Trans.*, 1881) to contain the same colloid material as the alveoli. Accessory thyroids, close to the main gland, are often found.

Embryology.—The median part of the gland is developed from a tube which grows down in the middle line from the junction of the buccal and pharyngeal parts of the tongue (*g.v.*), between the first and second branchial arches. This tube is called the thyro-glossal duct and is entodermal in origin. The development of the hyoid bone obliterates the middle part of the duct, leaving its upper part as the foramen caecum of the tongue, while its lower part bifurcates, and so the asymmetrical arrangement of the pyramidal lobe is accounted for. A. Kanthack (*J. Anat. and Phys.* vol. xxv., 1891) has denied the existence of this duct, but on slender grounds. The lateral parts of the gland are developed from the entoderm of the fourth visceral clefts, and, joining the median part, lose their pharyngeal connexion. Nearly, but not quite, the whole of the lateral lobes probably belong to this part. (For literature and further details see Quain's *Anatomy*, London, 1892, and J. P. McMurrich's *Development of the Human Body*, London, 1906.)

Comparative Anatomy.—The endostyle or hypobranchial groove of Tunicata (sea squirts) and Acrania (Amphioxus) is regarded as the first appearance of the median thyroid; this is a median entodermal groove in the floor of the pharynx, secreting a glairy fluid in which food particles become entangled and so pass into the intestine. In the larval lamprey (Ammocetes) among the Cyclostomata the connexion with the pharynx is present, but in the adult lamprey (Petromyzon), as in all adult vertebrates, this connexion is lost. In the Elasmobranchs the single median thyroid lies close to the mandibular symphysis, but in the bony fish (Teleostei) it is paired. In the mud fish (Dipnoi) there is also an indication of a division into two lobes. In the Amphibia the thyroid forms numerous vesicles close to the anterior end of the pericardium. In Reptilia it lies close to the trachea, and in the Chelonians and Crocodylia it is paired. In birds it is also paired and lies near the origin of the carotid arteries. In Mammalia the lateral lobes make their first appearance. In the lower orders of this class the isthmus is often absent. (For further details and literature see R. Wiedersheim's *Vergleichende Anatomie der Wirbeltiere*, Jena, 1902, and also for literature, Quain's *Anatomy*, London, 1896.)

PARATHYROID GLANDS

These little oval bodies, of considerable physiological importance, are two in number on each side. From their position they are spoken of as postero-superior and antero-inferior; the postero-superior are embedded in the thyroid at the level of the lower border of the cricoid cartilage, while the antero-inferior may be embedded in the lower edge of the lateral lobes of the thyroid or may be found a little distance below in relation to the inferior thyroid veins. They are often very difficult to find, but it is easiest to do so in a perfectly fresh, full-term foetus or young child. Microscopically they consist of solid masses of epithelioid cells with numerous blood-vessels between, while, embedded in their periphery, are often found masses of thymic tissue including the concentric corpuscles of Hassall. They have been regarded as undeveloped portions of thyroid tissue in an embryonic state, but the experiments of Gléy (*Comptes rendus de la Soc. de Biol.* No. 11, 1895) and of W. Edmunds (*Proc. Physiol. Soc.—Journ. Phys.* vol. xviii., 1895) do not confirm this. They are developed from the entoderm of the third and fourth branchial grooves.

Parathyroids have been found in the orders of Primates, Cheiroptera, Carnivora, Ungulata and Rodentia among the Mammalia, and also in Birds. In the other classes of vertebrates little is known of them. The fullest and most recent account of these bodies is that of D. A. Welsh in *Journ. Anat. and Phys.* vol. 32, 1898, pp. 292 and 380.

THE THYMUS GLAND

The thymus gland (Gr. *thymos*, from a fancied resemblance to the corymbs of the Thyme) is a light pink gland, consisting

of two unequal lobes, which lies in the superior and anterior mediastina of the thorax in front of the pericardium and great vessels; it also extends up into the root of the neck to within a short distance of the thyroid gland. It continues to grow until the second year of life, after which it remains stationary until puberty, when it usually degenerates rapidly. The writer has seen it perfectly well developed in a man between 40 and 50, though such cases are rare; probably, however, some patches of its tissue remain all through life. Each lobe is divided into a large number of lobules divided by areolar tissue, and each of these, under the microscope, is seen to consist of a cortical and medullary part. The cortex is composed of lymphoid tissue and resembles the structure of a lymphatic gland (see LYMPHATIC SYSTEM); it is imperfectly divided into a number of follicles. In the medulla the lymphoid cells are fewer, and nests of epithelial cells are found, called the concentric corpuscles of Hassall. The vascular supply is derived from all the vessels in the neighbourhood, the lymphatics are very large and numerous, but the nerves, which come from the sympathetic and vagus, are few and small. H. Watney (*Phil. Trans.*, 1882) has discovered haemoglobin, and apparently developing red blood corpuscles, in the thymus. (For further details see Gray's or Quain's *Anatomy*.)

Embryology.—The thymus is formed from a diverticulum, on each side, from the entoderm lining the third branchial groove, but the connexion with the pharynx is soon lost. The lymphoid cells and concentric corpuscles are probably the derivatives of the original cells lining the diverticulum.

Comparative Anatomy.—The thymus is always a paired gland. In most fishes it rises from the dorsal part of all five branchial clefts; in Lepidosiren (Dipnoi), from all except the first; in Urodele from 3rd, 4th and 5th, and in Anura from the 2nd only (see T. H. Bryce, "Development of Thymus in Lepidosiren," *Journ. Anat. and Phys.* vol. 40, p. 91). In all fishes, including the Dipnoi (mud fish) it is placed dorsally to the gill arches on each side. In the Amphibia it is found close to the articulation of the mandible. In the Reptilia it is situated by the side of the carotid artery; but in young crocodiles it is lobulated and extends all along the neck, as it does in birds, lying close to the side of the oesophagus. In Mammals the Marsupials are remarkable for having a well-developed cervical as well as thoracic thymus (J. Symington, *J. Anat. and Phys.* vol. 32, p. 278). In some of the lower mammals the gland does not disappear as early as it does in man. The thymus of the calf is popularly known as "the chest sweetbread."

CAROTID BODIES

These are two small bodies situated, one on each side, between the origins of the external and internal carotid arteries. Microscopically they are divided into nodules or cell balls by connective tissue, and these closely resemble the structure of the parathyroids, but are without any thymic tissue. The blood-vessels in their interior are extremely large and numerous. The modern view of their development is that they are part of the sympathetic system, and the reaction of their cells to chromium salts bears this out. (See Kohn, *Archiv f. mikr. Anat.* lxx., 1907.)

In the Anura there is a rete or network into which the carotid artery breaks up in the position of the carotid body, and this has an important effect on the course of the circulation. It is probable, however, that this structure has nothing to do with the carotid body of Mammalia.

COCCYGEAL BODY

This is a small median body, about the size of a pea, situated in front of the apex of the coccyx and between the insertions of the levatores ani muscles. It resembles the carotid body in its microscopical structure, but is not so vascular. Concentric corpuscles, like those of the thymus, have been recorded in it. It derives its arteries from the middle sacral and its nerves from the sympathetic. Of its embryology and comparative anatomy little is known, though J. W. Thomson Walker has recently shown that numerous, outlying, minute masses of the same structure lie along the course of the middle sacral artery (*Archiv f. mikroskop. Anat.* Bd. lxiv.). The probability is that, like the carotid body, it is sympathetic in origin. (Quain's *Anatomy* gives excellent illustrations of the histology of this as well as of all the other ductless glands.)

For the literature on and further details concerning the foregoing structures the following works should be consulted: Quain's

Anatomy, vol. 1 (1908, London, Longman & Co.); McMurrich's *Development of the Human Body* (London, Rebman, 1906); Wiedersheim's *Vergleich. Anat. der Wirbeliers* (Jena, 1898). (F. G. P.)

DUDERSTADT, a town of Germany, in the Prussian province of Hanover, situated in a beautiful and fertile valley (formerly called *Goldene Mark*) watered by the Hahle, and on the railway Wulften-Leinefelde. Pop. (1905) 5327. It is an interesting mediæval town with many ancient buildings. Notable are the two Roman Catholic churches, beautiful Gothic edifices of the 14th century, the Protestant church, and the handsome town-hall. Its chief industries are woollen and cotton manufactures, sugar-refining and cigar-making; it has also a trade in singing-birds. Duderstadt was founded by Henry I. (the Fowler) in 929, passed later to the monastery of Quedlinburg, and then to Brunswick. It was a member of the Hanseatic League, and during the Thirty Years' War became a stronghold of the Imperialists. It was taken by Duke William of Weimar in 1632; in 1761 its walls were dismantled, and, after being alternately Prussian and Hanoverian, it passed finally in 1866 with Hanover to Prussia.

DUDLEY, BARONS AND EARLS OF. The holders of these English titles are descended from John de Sutton (c. 1310-1359) of Dudley castle, Staffordshire, who was summoned to parliament as a baron in 1342. Sutton was the son of another John de Sutton, who had inherited Dudley Castle through his marriage with Margaret, sister and heiress of John de Somery (d. 1321); he was called Lord Dudley, or Lord Sutton of Dudley, the latter being doubtless the correct form. However, his descendants, the Suttons, were often called by the name of Dudley; and from John Dudley of Atherington, Sussex, a younger son of John Sutton, the 5th baron, the earls of Warwick and the earl of Leicester of the Dudley family are descended.

John Sutton or Dudley (c. 1400-1487), the 5th baron, was first summoned to parliament in 1440, having been viceroy of Ireland from 1428 to 1430. He served Henry VI. as a diplomatist and also as a soldier, being taken prisoner at the first battle of St Albans in 1455, but this did not prevent him from enjoying the favour of Edward IV. He died on the 30th of September 1487. He was succeeded as 6th baron by his grandson Edward (c. 1459-1532), and one of his sons, William Dudley, was bishop of Durham from 1476 until his death in 1483. His descendant Edward Sutton or Dudley, the 9th baron (1567-1643), had several illegitimate sons. Among them was Dud Dudley (1599-1684), who in 1665 published *Metalum Martis*, describing a process of making iron with "pit-coale, sea-coale, &c." which was put in operation at his father's ironworks at Pensnet, Worcestershire, of which he was manager. His success aroused much opposition on the part of other ironmasters, and his commercial ventures at Himley, at Askew Bridge and at Bristol ended in loss and disaster. During the Civil War he was a colonel in the army of Charles I.

Dying without lawful male issue in June 1643, the 9th baron was succeeded in the barony by his grand-daughter, Frances (1611-1697); she married Humble Ward (c. 1614-1670), the son of a London goldsmith, who was created Baron Ward of Birmingham in 1644. Their son Edward (1631-1701) succeeded both to the barony of Dudley and to that of Ward, but these were separated when his grandson William died unmarried in May 1740. The barony of Dudley passed to a nephew, Ferdinando Dudley Lea, falling into abeyance on his death in October 1757; that of Ward passed to the heir male, John Ward (d. 1774), a descendant of Humble Ward. In 1763 Ward was created Viscount Dudley, and in April 1823 his grandson, John William Ward (1781-1833), became the 4th viscount.

Educated at Oxford, John William Ward entered parliament in 1802, and except for a few months he remained in the House of Commons until he succeeded his father in the peerage. In 1827 he was minister for foreign affairs under Canning and then under Goderich and under Wellington, resigning office in May 1828. As foreign minister he was only a cipher, but he was a man of considerable learning and had some reputation as a writer and a talker. Dudley took an interest in the foundation

of the university of London, and his *Letters* to the bishop of Landaff were published by the bishop (Edward Copleston) in 1840 (new ed. 1841). He was created Viscount Ednam and earl of Dudley in 1827, and when he died unmarried on the 6th of March 1833 these titles became extinct. His barony of Ward, however, passed to a kinsman, William Humble Ward (1781-1835), whose son, William (1817-1885), inheriting much of the dead earl's great wealth, was created Viscount Ednam and earl of Dudley in 1860. The 2nd earl of Dudley in this creation was the latter's son William Humble (b. 1866), who was lord-lieutenant of Ireland from 1902 to 1906, and in 1908 was appointed governor-general of Australia.

See H. S. Graebrock in the *Herald and Genealogist*, vols. ii. v. and vi.; in *Notes and Queries*, 2nd series, vol. xi.; and in vol. ix. of the publications of the William Salt Society (1888).

DUDLEY, EDMUND (c. 1462-1510), minister of Henry VII. of England, was a son of John Dudley of Atherington, Sussex, and a member of the great baronial family of Sutton or Dudley. After studying at Oxford and at Gray's Inn, Dudley came under the notice of Henry VII., and is said to have been made a privy councillor at the early age of twenty-three. In 1492 he helped to negotiate the treaty of Etaples with France and soon became prominent in assisting the king to check the lawlessness of the barons, and at the same time to replenish his own exchequer. He and his colleague Sir Richard Empson (q.v.) are called *fscales judices* by Polydore Vergil, and owing to their extortions they became very unpopular. Dudley, who was speaker of the House of Commons in 1504, in addition to aiding Henry, amassed a great amount of wealth for himself, and possessed large estates in Sussex, Dorset and Lincolnshire. When Henry VII. died in April 1509, he was thrown into prison by order of Henry VIII. and charged with the crime of constructive treason, being found guilty and attainted. After having made a futile attempt to escape from prison, he was executed on the 17th or 18th of August 1510. Dudley's nominal crime was that during the last illness of Henry VII. he had ordered his friends to assemble in arms in case the king died, but the real reason for his death was doubtless the unpopularity caused by his avarice. During his imprisonment he sought to gain the favour of Henry VIII. by writing a treatise in support of absolute monarchy called *The Tree of Commonwealth*. This never reached the king's hands, and was not published until 1859, when it was printed privately in Manchester. Dudley's first wife was Anne, widow of Roger Corbet of Morton, Shropshire, by whom he had a daughter, Elizabeth, who married William, 6th Lord Stourton. By his second wife, Elizabeth, daughter of Edward Grey, Viscount Lisle, he had three sons: John, afterwards duke of Northumberland (q.v.); Andrew (d. 1559), who was made a knight and held various important posts during the reign of Edward VI.; and Jasper.

See Francis Bacon, *History of Henry VII.*, edited by J. R. Lumby (Cambridge, 1881); and J. S. Brewer, *The Reign of Henry VIII.*, edited by J. Gairdner (London, 1884).

DUDLEY, SIR ROBERT (1573-1649), titular duke of Northumberland and earl of Warwick, English explorer, engineer and author, was the son of Robert Dudley, earl of Leicester (q.v.), the favourite of Queen Elizabeth. His mother was Lady Douglas Sheffield, daughter of Thomas, first Baron Howard of Effingham. Leicester, who deserted Lady Douglas Sheffield for Lettice Knollys, widow of the first earl of Essex, denied that they were married. She asserted that they were, at Esher in Surrey, but her marriage with Sir Edward Stafford of Grafton, after her desertion by Leicester, would seem to be a tacit confession that her claim had no foundation. Her son Robert was born in May 1573, was recognized by Leicester, and sent to Christ Church, Oxford, in 1587. He inherited all Leicester's property under the earl's will at his death in 1588, and in the following year the property of Ambrose Dudley, earl of Warwick. In 1594 he made a voyage to the West Indies, and in 1596 he took part in the expedition to Cadiz and was knighted. In 1599 he had married a sister of Thomas Cavendish the circumnavigator. On her death he married Alicia Leigh in 1596, by whom he had four daughters. After the death of Elizabeth he endeavoured

to secure recognition of his legitimacy, and of his right to inherit the titles of his father and uncle. The proceedings were quashed by the Star Chamber. In 1605 he obtained leave to travel abroad, and went to Italy accompanied by the beautiful Miss Elizabeth Southwell, daughter of Sir Robert Southwell of Woodrising, in the dress of a page. When ordered to return home and to provide for his deserted wife and family, he refused, was outlawed, and his property was confiscated. On the continent he avowed himself a Roman Catholic, married Elizabeth Southwell at Lyons, and entered the service of Cosimo II., grand-duke of Tuscany. In the service of the grand-duke he is said to have done some fighting against the Barbary pirates, and he was undoubtedly employed in draining the marshes behind Leghorn, and in the construction of the port. In 1620 the emperor Ferdinand II. gave him a patent recognizing his claim not only to the earldom of Warwick but to the duchy of Northumberland, which had been held by his grandfather, who was executed by Queen Mary Tudor. In Italy Dudley was known as Duca di Nortombria and Conte di Warwick. He died near Florence on the 6th of September 1649, leaving a large family of sons and daughters. His deserted wife, Alicia, was created duchess of Dudley by Charles I. in 1644, and died in 1670, when the title became extinct. Through a daughter who married the Marquis Paleotti, Dudley was the ancestor of the wife of the first duke of Shrewsbury (of the revolution of 1688), and of her brother who was executed at Tyburn for murder on the 17th of March 1718. Dudley was the author of a pamphlet addressed to King James I., showing how the "impertinences of parliament" could be bridled by military force. But his chief claim to memory is the magnificent *Arcano dell mare*, published in Italian at Florence in 1645-1646 in three volumes folio. It is a collection of all the naval knowledge of the age, and is particularly remarkable for a scheme for the construction of a navy in five rates which Dudley designed and described. It was reprinted in Florence in two volumes folio in 1661 without the charts of the first edition.

AUTHORITIES.—G. L. Craik, *Romance of the Peorago* (London, 1848-1850), vol. iii.; Sir N. H. Nicolas, *Report of Proceedings on the Claim to the Barony of L'Isle* (London, 1829); and *The Italian Biography of Sir R. Dudley*, published anonymously, privately and without date or name of place, but known to have been written by Doctor Vaughan Thomas, vicar of Stoneleigh, who died in 1858. (D. H.)

DUDLEY, THOMAS (1576-1653), British colonial governor of Massachusetts, was born in Northampton, England, in 1576, a member of the elder branch of the family to the younger branch of which Robert Dudley, earl of Leicester, belonged. He was the son of a country gentleman of some means and high standing, was captain of an English company in the French expedition of 1597, serving under Henry of Navarre, and eventually became the steward of the earl of Lincoln's estates, which he managed with great success for many years. Having been converted to Puritanism, he became a strict advocate of its strictest tenets. About 1627 he associated himself with other Lincolnshire gentlemen who in 1629 entered into an agreement to settle in New England provided they were allowed to take the charter with them. This proposal the general court of the Plymouth Company agreed to, and in April 1630 Dudley sailed to America in the same ship with John Winthrop, the newly appointed governor, Dudley himself at the last moment being chosen deputy-governor in place of John Humphrey (or Humfrey), the earl of Lincoln's son-in-law, whose departure was delayed. Dudley was for many years the most influential man in the Massachusetts Bay colony, save Winthrop, with whose policy he was more often opposed than in agreement. He was deputy-governor in 1629-1634, in 1637-1640, in 1646-1650 and in 1651-1653, and was governor four times, in 1634, 1640, 1645 and 1650. Soon after his arrival in the colony he settled at Newton (Cambridge), of which he was one of the founders; he was also one of the earliest promoters of the plan for the establishment of Harvard College. Winthrop's decision to make Boston the capital instead of Newton precipitated the first of the many quarrels between the two, Dudley's sterner and harsher Puritanism, being in strong contrast to Winthrop's more tolerant and liberal views. He was an earnest and persistent heresy-hunter—not only the

Antinomians, but even such a good Puritan as John Cotton, against whom he brought charges, feeling the weight of his stern and remorseless hand. His position he himself best expressed in the following brief verse found among his papers:

"Let men of God in courts and churches watch
O'er such as do a Toleration hatch,
Lest that ill egg bring forth a Cockatrice
To poison all with heresy and vice."

He died at Roxbury, Massachusetts, on the 31st of July 1653.

See Augustine Jonea, *Life and Work of Thomas Dudley, the Second Governor of Massachusetts* (Boston, 1899); and *The Life of Mr Thomas Dudley, several times Governor of the Colony of Massachusetts, written as it is supposed by Cotton Mather*, edited by Charles Deane (Cambridge, 1870). Dudley's interesting and valuable "Letter to the Countess of Lincoln," is reprinted in Alexander Young's *Chronicles of the Planters of the Colony of Massachusetts Bay* (Boston, 1846), and in the New Hampshire Historical Society *Collections*, vol. iv. (1834).

His son JOSEPH DUDLEY (1647-1720), colonial governor of Massachusetts, was born in Roxbury, Massachusetts, on the 23rd of September 1647. He graduated at Harvard College in 1665, became a member of the general court, and in 1688 was sent by Massachusetts to London to prevent the threatened revocation of her charter by Charles II. There, with an eye to his personal advancement, he secretly advised the king to annul the charter; this was done, and Dudley, by royal appointment, became president of the provisional council. With the advent of the new governor, Sir Edmund Andros, Dudley became a judge of the superior court and censor of the press. Upon the deposition of Andros, Dudley was imprisoned and sent with him to England, but was soon set free. In 1691-1692 he was chief-justice of New York, presiding over the court that condemned Leisler and Milburn. Returning to England in 1693, he was lieutenant-governor of the Isle of Wight and a member of parliament, and in 1702, after a long intrigue, secured from Queen Anne a commission as governor of Massachusetts, serving until 1715. His administration was marked, particularly in the earlier years, by ceaseless conflict with the general court, from which he demanded a regular fixed salary instead of an annual grant. He was active in raising volunteers for the so-called Queen Anne's War, and in 1707 sent a fruitless expedition against Port Royal. He was accused by the Boston merchants, who petitioned for his removal, of being in league with smugglers and illicit traders, and in 1708 a bitter attack on his administration was published in London, entitled *The Deplorable State of New England by reason of a Covetous and Treacherous Governor and Pusillanimous Counsellors*. His character may be best summed up in the words of one of his successors, Thomas Hutchinson, that "he had as many virtues as can consist with so great a thirst for honour and power." He died at Roxbury on the 2nd of April 1720.

Joseph Dudley's son, PAUL DUDLEY (1675-1751), graduated at Harvard in 1690, studied law at the Temple in London, and became attorney-general of Massachusetts (1702 to 1718). He was associate justice of the superior court of that province from 1718 to 1745, and chief justice from 1745 until his death. He was a member of the Royal Society (London), to whose *Transactions* he contributed several valuable papers on the natural history of New England, and was the founder of the Dudleian lectures on religion at Harvard.

The best extended account of Joseph Dudley's administration is in J. G. Palfrey's *History of New England*, vol. iv. (Boston, 1875).

DUDLEY, a municipal, county and parliamentary borough and market-town of Worcestershire, England, in a portion of that county enclaved in Staffordshire, 8 m. W.N.W. of Birmingham, and 121 N.W. of London by the London & North Western railway. The Great Western railway also serves the town. Pop. (1891) 45,724; (1901) 48,733. Dudley lies on an elevated ridge, in the midst of the district of the midlands known as the Black Country, which is given up to ironworks and coal mines. The "ten-yard" coal, in the neighbourhood, is the thickest seam worked in England. Limestone is extensively quarried, fire-clay is abundant; and iron-founding, brass-founding, engineering works, glass works and brick works are comprised in the industries. Among the principal buildings are the churches of the five parishes into

which the town is divided, the town hall, county court, free libraries, and school of art, grammar school with university and foundation scholarships, technical school, mechanics' institute, Guest hospital (founded by Joseph Guest, a citizen, in 1868), and a dispensary. In the market-place stands a large domed fountain, erected by the earl of Dudley (1867). There is a geological society with a museum, for the neighbourhood of Dudley is full of geological interest, the Silurian limestone abounding in fossils. To the north of the town are extensive remains of an ancient castle, surrounded by beautiful grounds. The hill on which it stands is of limestone, which by quarrying has been hollowed out in extensive chambers and galleries. The view from the castle is remarkable. The whole district is seen to be set with chimneys, pit-buildings and factories; and at night the glare of furnaces reveals the tireless activity of the Black Country. Dudley and its environs are connected by a tramway system, and water communication is afforded by the Dudley canal with Birmingham and with the river Severn.

Included in the parliamentary borough, but in Staffordshire, and 2½ m. by rail S.W. of Dudley, is Brierley Hill, a market-town on the river Stour and the Stourbridge and Birmingham Canals. Its chief buildings are the modern church of St Michael, standing on a hill, the Roman Catholic church of St Mary, by A. W. Pugin, the town hall and free library. Between this and Dudley lie the great ironworks of Roundoak, and the extensive suburb of Netherton in the enclaved portion of Worcestershire. The industries are similar to those of Dudley. Three miles W. of Dudley is Kingswinford, a mining township, with large brick works, giving name to a parliamentary division of Staffordshire. The parliamentary borough of Dudley returns one member. The town itself is governed by a mayor, 10 aldermen and 30 councillors. Area 35.46 acres.

In medieval times the importance of Dudley (*Duddeles*) depended on the castle, which is mentioned in the Domesday Survey. Before the Conquest Earl Eadwine held the manor, which in 1086 belonged to William FitzAnsculf, from whom it passed, probably by marriage, to Fulk Paynel, afterwards to the Somerys, Suttons and Wards, whose descendants (earls of Dudley) now hold it. The first mention of Dudley as a borough occurs in an inquisition taken after the death of Roger de Somery in 1272. This does not give a clear account of the privileges held by the burgesses, but shows that they had probably been freed from some or all of the services required from them as manorial tenants, in return for a fixed rent. In 1865 Dudley was incorporated. Before that time it was governed by a high and low bailiff appointed every year at the court leet of the manor. Roger de Somery evidently held a market by prescription in Dudley before 1261, in which year he came to terms with the dean of Wolverhampton, who had set up a market in Wolverhampton to the disadvantage of Roger's market at Dudley. According to the terms of the agreement the dean might continue his market on condition that Roger and his tenants should be free from toll there. Two fairs, on the 21st of September and the 21st of April, were granted in 1684 to Edward Lord Ward, lord of the manor. Dudley was represented in the parliament of 1295, but not again until the privilege was revived by the Reform Act of 1832. Mines of sea-coal in Dudley are mentioned as early as the reign of Edward I., and by the beginning of the 17th century mining had become an important industry.

DUDO, or **DUDON** (fl. c. 1000), Norman historian, was dean of St Quentin, where he was born about 905. Sent in 986 by Albert I. count of Vermandois, on an errand to Richard I., duke of Normandy, he succeeded in his mission, and, having made a very favourable impression at the Norman court, spent some years in that country. During a second stay in Normandy Dudo wrote his history of the Normans, a task which Duke Richard I. had urged him to undertake. Very little else is known about his life, except that he died before 1043. Written between 1015 and 1030, his *Historia Normannorum*, or *Libri III. de moribus et actis primorum Normanniae ducum*, was dedicated to Adalberon, bishop of Laon. Dudo does not appear to have

consulted any existing documents for his history, but to have obtained his information from oral tradition, much of it being supplied by Raoul, count of Ivry, a half-brother of Duke Richard I. Consequently the *Historia* partakes of the nature of a romance, and on this ground has been regarded as untrustworthy by such competent critics as E. Dümmler and G. Waits. Other authorities, however, e.g. J. Lair and J. Steenstrup, while admitting the existence of a legendary element, regard the book as of considerable value for the history of the Normans. Although Dudo was acquainted with Virgil and other Latin writers, his Latin is affected and obscure. The *Historia*, which is written alternately in prose and in verse of several metres, is divided into four parts, and deals with the history of the Normans from 852 to the death of Duke Richard I. in 996. It glorifies the Normans, and was largely used by William of Jumièges, Wace, Robert of Torigni, William of Poitiers and Hugh of Fleury in compiling their chronicles, and was first published by A. Duchesne in his *Historiae Normannorum scriptores antiqui*, at Paris in 1619. Another edition is in the *Patrologia Latina*, tome cxii. of J. P. Migne (Paris, 1844), but the best is perhaps the one edited by J. Lair (Caen, 1865).

See E. Dümmler, "Zur Kritik Dudos von St Quentin" in the *Forschungen zur deutschen Geschichte*, Bände vi and ix. (Göttingen, 1866); G. Waits, "Über die Quellen zur Geschichte der Begründung der normannischen Herrschaft in Frankreich," in the *Göttinger gel. Anzeigen* (Göttingen, 1866); J. C. H. R. Steenstrup, *Normannerne*, Band i. (Copenhagen 1876); J. Lair, *Étude critique et historique sur Dudo* (Caen, 1865); G. Körner, *Über die Quellen des Roman de Rou* (Leipzig, 1867); W. Wattenbach, *Deutschlands Geschichtsquellen*, Band i. (Berlin, 1904); and A. Molinier, *Les Sources de l'histoire de France*, tome ii. (Paris, 1902).

DUDWEILER, a town of Germany, in the Prussian Rhine province, on the Sulzbach, 4 m. by rail N.E. from Saarbrücken. It has extensive coal mines and ironworks and produces fireproof bricks. Pop. (1905) 16,320.

DUEL (Ital. *duello*, Lat. *duellum*—old form of *bellum*—from *duo*, two), a prearranged encounter between two persons, with deadly weapons, in accordance with conventional rules, with the object of voiding a personal quarrel or of deciding a point of honour. The first recorded instance of the word occurs in Coryate's *Crudities* (1611), but Shakespeare has *duello* in this sense, and uses "duellist" of Tybalt in *Romeo and Juliet*. In its earlier meaning of a judicial combat we find the word latinized in the Statute of Wales (Edw. I., Act 12), "*Placiis de terris in partibus istis non habent terminari per duellum*."

Duels in the modern sense were unknown to the ancient world, and their origin must be sought in the feudal age of Europe. The single combats recorded in Greek and Roman history and legend, of Hector and Achilles, Aeneas and Turnus, the Horatii and Curiatii, were incidents in national wars and have nothing in common with the modern duel. It is, however, noteworthy that in Tacitus (*Germania*, cap. x.) we find the rudiments of the judicial duel (see WAGER, for the wager of battle). Domestic differences, he tells us, were settled by a legalized form of combat between the disputants, and when a war was impending a captive from the hostile tribe was armed and pitted against a national champion, and the issue of the duel was accepted as an omen. The judicial combat was a Teutonic institution, and it was in fact an appeal from human justice to the God of battles, partly a sanction of the current creed that might is right, that the brave not only will win but deserve to win. It was on these grounds that Gundobald justified, against the complaints of a bishop, the famous edict passed at Lyons (A.D. 501) which established the wager of battle as a recognized form of trial. It is God, he argued, who directs the issue of national wars, and in private quarrels we may trust His providence to favour the juster cause. Thus, as Gibbon comments, the absurd and cruel practice of judicial duels, which had been peculiar to some tribes of Germany, was propagated and established in all the monarchies of Europe from Sicily to the Baltic. Yet in its defence it may be urged that it abolished a worse evil, the compurgation by oath which put a premium on perjury, and the ordeal, or judgment of God, when the cause was decided by blind chance, or more often by priestcraft.

Those who are curious to observe the formalities and legal rules of a judicial combat will find them described at length in the 28th book of Montesquieu's *Esprit des lois*. On these regulations he well remarks that, as there are an infinity of wise things conducted in a very foolish manner, so there are some foolish things conducted in a very wise manner. For our present purpose it is sufficient to observe the development of the idea of personal honour from which the modern duel directly sprang. In the ancient laws of the Swedes we find that if any man shall say to another, "You are not a man equal to other men," or "You have not the heart of a man," and the other shall reply, "I am a man as good as you," they shall meet on the highway, and then follow the regulations for the combat. What is this but the modern challenge? By the law of the Lombards if one man call another *arga*, the insulted party might defy the other to mortal combat. What is *arga* but the *dumner Junger* of the German student? Beaumanoir thus describes a legal process under Louis le Débonnaire:—The appellant begins by a declaration before the judge that the appellee is guilty of a certain crime; if the appellee answers that his accuser lies, the judge then ordains the duel. Is not this the modern point of honour, by which to be given the lie is an insult which can only be wiped out by blood?

From Germany the judicial combat rapidly spread to France, where it flourished greatly from the 10th to the 12th century, the period of customary law. By French kings it was welcomed as a limitation of the judicial powers of their half independent vassals. It was a form of trial open to all freemen and in certain cases, as under Louis VI., the privilege was extended to serfs. Even the church resorted to it not infrequently to settle disputes concerning church property. Abbots and priors as territorial lords and high justiciaries had their share in the confiscated goods of the defeated combatant, and Pope Nicholas when applied to in 858 pronounced it "a just and legitimate combat." Yet only three years before the council of Valence had condemned the practice, imposing the severest penance on the victor and refusing the last rites of the church to the vanquished as to a suicide. In 1385 a duel was fought, the result of which was so preposterous that even the most superstitious began to lose faith in the efficacy of such a judgment of God. A certain Jacques Legris was accused by the wife of Jean Carrouge of having introduced himself by night in the guise of her husband whom she was expecting on his return from the Crusades. A duel was ordained by the parlement of Paris, which was fought in the presence of Charles VI. Legris was defeated and hanged on the spot. Not long after, a criminal arrested for some other offence confessed himself to be the author of the outrage. No institution could long survive so open a confutation, and it was annulled by the parlement. Henceforward the duel in France ceases to be an appeal to Heaven, and becomes merely a satisfaction of wounded honour. Under Louis XII. and Francis I. we find the first vestiges of tribunals of honour. The last instance of a duel authorized by the magistrates, and conducted according to the forms of law, was the famous one between François de Vivonne de la Châtaignerie and Guy Chabot de Jarnac. The duel was fought on the 10th of July 1547 in the courtyard of the château of St Germain-en-Laye, in the presence of the king and a large assembly of courtiers. It was memorable in two ways. It enriched the French language with a new phrase; a sly and unforeseen blow, such as that by which de Jarnac worsted La Châtaignerie, has since been called a *coup de Jarnac*. And Henry, grieved at the death of his favourite, swore a solemn oath that he would never again permit a duel to be fought. This led to the first of the many royal edicts against duelling. By a decree of the council of Trent (cap. xix.) a ban was laid on "the detestable use of duels, an invention of the devil to compass the destruction of souls together with a bloody death of the body."

In England, it is now generally agreed, the wager of battle did not exist before the time of the Norman Conquest. Some previous examples have been adduced, but on examination they will be seen to belong rather to the class of single combats between the champions of two opposing armies. One such

instance is worth quoting as a curious illustration of the superstition of the time. It occurs in a rare tract printed in London, 1610, *The Duello, or Single Combat*. "Danish irruptions and the bad aspects of Mars having drenched the common mother earth with her sonnes' blood streames, under the reign of Edmund, a Saxon monarch, *misso in compendium* (so worthy Camden expresseth it) *bello utriusque genibus Jata Edmundo Anglorum et Consulo Danorum regibus commissa fuerunt, qui singulari certamine de summa imperij in hac insula* (that is, the Eight in Gloucestershire) *depuernarunt*." By the laws of William the Conqueror the trial by battle was only compulsory when the opposite parties were both Normans, in other cases it was optional. As the two nations were gradually merged into one, this form of trial spread, and until the reign of Henry II. it was the only mode for determining a suit for the recovery of land. The method of procedure is admirably described by Shakespeare in the opening scene in *Richard II.*, where Henry of Bolingbroke, duke of Hereford, challenges Thomas, duke of Norfolk; in the mock-heroic battle between Horner the Armourer and his man Peter in *Henry VI.*; and by Sir W. Scott in the *Fair Maid of Perth*, where Henry Gow appears before the king as the champion of Magdalen Proudfeute. The judicial duel never took root in England as it did in France. In civil suits it was superseded by the grand assize of Henry II., and in cases of felony by indictment at the prosecution of the crown. One of the latest instances occurred in the reign of Elizabeth, 1571, when the lists were actually prepared and the justices of the common pleas appeared at Tothill Fields as umpires of the combat. Fortunately the petitioner failed to put in an appearance, and was consequently nonsuited (see Spelman, *Glossary*, s.v. "Campus"). As late as 1817 Lord Ellenborough, in the case of *Thornton v. Ashford*, pronounced that "the general law of the land is that there shall be a trial by battle in cases of appeal unless the party brings himself within some of the exceptions." Thornton was accused of murdering Mary Ashford, and claimed his right to challenge the appellant, the brother of the murdered girl, to wager of battle. His suit was allowed, and the challenge being refused, the accused escaped. Next year the law was abolished (59 Geo. III., c. 46).

In sketching the history of the judicial combat we have traced the parentage of the modern duel. Strip the former of its legality, and divest it of its religious sanction, and the latter remains. We are justified, then, in dating the commencement of duelling from the abolition of the wager of battle. To pursue its history we must return to France, the country where it first arose, and the soil on which it has most flourished. The causes which made it indigenous to France are sufficiently explained by the condition of society and the national character. As Buckle has pointed out, duelling is a special development of chivalry, and chivalry is one of the phases of the protective spirit which was predominant in France up to the time of the Revolution. Add to this the keen sense of personal honour, the susceptibility and the pugnacity which distinguish the French race. Montaigne, when touching on this subject in his essays, says, "Put three Frenchmen together on the plains of Libya, and they will not be a month in company without scratching one another's eyes out." The third chapter of d'Audiguer's *Ancien usage des duels* is headed, "Pourquoi les seuls Français se battent en duel." English literature abounds with allusions to this characteristic of the French nation. Lord Herbert of Cherbury, who was ambassador at the court of Louis XIII., says, "There is scarce a Frenchman worth looking on who has not killed his man in a duel." Ben Jonson, in his *Magnetic Lady*, makes Compass, the scholar and soldier, thus describe France, "that garden of humanity":—

"There every gentleman professing arms
Thinks he is bound in honour to embrace
The bearing of a challenge for another,
Without or questioning the cause or asking
Least colour of a reason."

Duels were not common before the 16th century. **HR**

attributes their prevalence to the barbarous custom of wearing swords as a part of domestic dress, a fashion which was not introduced till the latter part of the 15th century. In 1560 the states-general at Orleans supplicated Charles IX. to put a stop to duelling. Hence the famous ordinance of 1566, drawn up by the chancellor de l'Hôpital, which served as the basis of the successive ordinances of the following kings. Under the frivolous and sanguinary reign of Henry III., "who was as eager for excitement as a woman," the rage for duels spread till it became almost an epidemic. In 1602 the combined remonstrances of the church and the magistrates extorted from the king an edict condemning to death whoever should give or accept a challenge or act as second. But public opinion was revolted by such rigour, and the statute remained a dead letter. A duel forms a fit conclusion to the reign. A hair-brained youth named L'Isle Marivaux swore that he would not survive his beloved king, and threw his cartel into the air. It was at once picked up, and Marivaux soon obtained the death he had courted. Henry IV. began his reign by an edict against duels, but he was known in private to favour them; and, when de Crequi asked leave to fight Don Philip of Savoy, he is reported to have said, "Go, and if I were not a king I would be your second." Fontenay-Mareuil says, in his *Mémoires*, that in the eight years between 1601 and 1609, 2000 men of noble birth fell in duels. In 1609 a more effective measure was taken at the instance of Sully by the establishment of a court of honour. The edict decrees that all aggrieved persons shall address themselves to the king, either directly or through the medium of the constables, marshals, &c.; that the king shall decide, whether, if an accommodation could not be effected, permission to fight should be given; that the aggressor, if pronounced in the wrong, shall in any case be suspended from any public office or employment, and be mulcted of one-third of his revenue till he has satisfied the aggrieved party; that any one giving or receiving a challenge shall forfeit all right of reparation and all his offices; that any one who kills his adversary in an unauthorized duel shall suffer death without burial, and his children shall be reduced to villanage; that seconds, if they take part in a duel, shall suffer death, if not, shall be degraded from the profession of arms. This edict has been pronounced by Henri Martin "the wisest decree of the ancient monarchy on a matter which involves so many delicate and profound questions of morals, politics, and religion touching civil rights" (*Histoire de France*, x. 466).

In the succeeding reign the mania for duels revived. Rostand's *Cyrano* is a life-like modern portraiture of French bloods in the first half of the 17th century. De Houssaye tells us that in Paris when friends met the first question was, "Who fought yesterday? who is to fight to-day?" They fought by night and day, by moonlight and by torch-light, in the public streets and squares. A hasty word, a misconceived gesture, a question about the colour of a riband or an encroached letter, such were the commonest pretexts for a duel. The slighter and more frivolous the dispute, the less were they inclined to submit them to the king for adjudication. Often, like gladiators or prize-fighters, they fought for the pure love of fighting. A misunderstanding is cleared up on the ground. "N'importe," cry the principals, "puisque nous sommes ici, battons-nous." Seconds, as Montaigne tells us, are no longer witnesses, but must take part themselves unless they would be thought wanting in affection or courage; and he goes on to complain that men are no longer contented with a single second, "c'était anciennement des duels, ce sont à cette heure rencontres et batailles." There is no more striking instance of Richelieu's firmness and power as a statesman than his conduct in the matter of duelling. In his *Testament politique* he has assigned his reasons for disapproving it as a statesman and ecclesiastic. But this disapproval was turned to active detestation by a private cause. His elder brother, the head of the house, had fallen in a duel stabbed to the heart by an enemy of the cardinal. Already four edicts had been published under Louis XIII. with little or no effect, when in 1626 there was published a new edict condemning to death any one who had killed his adversary in a duel, or had

been found guilty of sending a challenge a second time. Banishment and partial confiscation of goods were awarded for lesser offences. But this edict differed from preceding ones not so much in its severity as in the fact that it was the first which was actually enforced. The cardinal began by imposing the penalties of banishment and fines, but, these proving ineffectual to stay the evil, he determined to make a terrible example. To quote his own words to the king, "Il s'agit de couper la gorge aux duels ou aux édits de votre Majesté." The count de Boutteville, a renommist who had already been engaged in twenty-one affairs of honour, determined out of pure bravado to fight a twenty-second time. The duel took place at midday on the Place Royale. Boutteville was arrested with his second, the count de Chapelles; they were tried by the parlement of Paris, condemned and, in spite of all the influence of the powerful house of Montmorenci, of which de Boutteville was a branch, they were both beheaded on the 21st of June 1627. For a short time the ardour of duellists was cooled. But the lesson soon lost its effect. Only five years later we read in the *Mémoires de France* that two gentlemen who had killed one another in a duel were, by the cardinal's orders, hanged on a gallows, stripped and with their heads downwards, in the sight of all the people. This was a move in the right direction, since, for fashionable vices, ridicule and ignominy is a more drastic remedy than death. It was on this principle that Caraccioli, prince of Melfi, when viceroy of Piedmont, finding that his officers were being decimated by duelling, proclaimed that all duels should be fought on the parapet of the Ponte Vecchio, and if one of the combatants chanced to fall into the river he should on no account be pulled out.

Under the long reign of Louis XIV. many celebrated duels took place, of which the most remarkable were that between the duke of Guise and Count Coligny, the last fought on the Place Royale, and that between the dukes of Beaufort and Nemours, each attended by four friends. Of the ten combatants, Nemours and two others were killed on the spot, and none escaped without some wound. No less than eleven edicts against duelling were issued under le Grand Monarque. That of 1643 established a supreme court of honour composed of the marshals of France; but the most famous was that of 1679, which confirmed the enactments of his predecessors, Henry IV. and Louis XII. At the same time a solemn agreement was entered into by the principal nobility that they would never engage in a duel on any pretence whatever. A medal was struck to commemorate the occasion, and the firmness of the king, in refusing pardon to all offenders, contributed more to restrain this scourge of society than all the efforts of his predecessors.

The subsequent history of duelling in France may be more shortly treated. In the preamble to the edict of 1704 Louis XIV. records his satisfaction at seeing under his reign an almost entire cessation of those fatal combats which by the inveterate force of custom had so long prevailed. Addison (*Spectator*, 99) notes it as one of the most glorious exploits of his reign to have banished the false point of honour. Under the regency of Louis XV. there was a brief revival. The last legislative act for the suppression of duels was passed on the 12th of April 1723. Then came the Revolution, which in abolishing the *ancien régime* fondly trusted that with it would go the duel, one of the privileges and abuses of an aristocratic society. Duplex, in his *Military Law concerning the Duel* (1611), premises that these have no application to lawyers, merchants, financiers or justices. This explains why in the legislation of the National Assembly there is no mention of duels. Camille Desmoulins when challenged shrugged his shoulders and replied to the charge of cowardice that he would prove his courage on other fields than the Bois de Boulogne. The two great Frenchmen whose writings precluded the French Revolution both set their faces against it. Voltaire had indeed, as a young man, in obedience to the dictates of society, once sought satisfaction from a nobleman for a brutal insult, and had reflected on his temerity in the solitude of the Bastille.¹ Henceforward he inveighed against the practice,

¹ Voltaire met the chevalier Rohan-Chabot at the house of the Marquis of Sully. The chevalier, offended by Voltaire's free speech,

not only for its absurdity, but also for its aristocratic exclusiveness. Rousseau had said of duelling, "It is not an institution of honour, but a horrible and barbarous custom, which a courageous man despises and a good man abhors." Napoleon was a sworn foe to it. "Bon duelliste mauvais soldat" is one of his best known sayings; and, when the king of Sweden sent him a challenge, he replied that he would order a fencing-master to attend him as plenipotentiary. After the battle of Waterloo duels such as Lever loves to depict were frequent between disbanded French officers and those of the allies in occupation. The restoration of the Bourbons brought with it a fresh crop of duels. Since then duels have been frequent in France—more frequent, however, in novels than in real life—fought mainly between politicians and journalists, and with rare exceptions bloodless affairs. If fought with pistols, the distance and the weapons chosen render a hit improbable; and, if fought with rapiers, honour is generally satisfied with the first blood drawn. Among Frenchmen famous in politics or letters who have "gone out" may be mentioned Armand Carrel, who fell in an encounter with Emile Girardin; Thiers, who thus atoned for a youthful indiscretion; the elder Dumas; Lamartine; Ste Beuve, who to show at once his sangfroid and his sense of humour, fought under an umbrella; Ledru Rollin; Edmond About; Clément Thomas; Veuillot, the representative of the church militant; Rochefort; and Boulanger, the Bonapartist *Janfaron*, whose discomfiture in a duel with Floquet resulted in a notable loss of popular respect.

Duelling did not begin in England till some hundred years after it had arisen in France. There is no instance of a private duel fought in England before the 16th century, and they are rare before the reign of James I. A very fair notion of the comparative popularity of duelling, and of the feeling with which it was regarded at various periods, might be gathered by examining the part it plays in the novels and lighter literature of the times. The earliest duels we remember in fiction are that in the *Monastery* between Sir Piercie Shafton and Halbert Glendinning, and that in *Kenilworth* between Tressilian and Varney. (That in *Anne of Geierstein* either is an anachronism or must reckon as a wager by battle.) Under James I. we have the encounter between Nigel and Lord Dalgarno. The greater evil of war, as we observed in French history, expels the lesser, and the literature of the Commonwealth is in this respect a blank. With the Restoration there came a reaction against Puritan morality, and a return to the gallantry and loose manners of French society, which is best represented by the theatre of the day. The drama of the Restoration abounds in duels. Passing on to the reign of Queen Anne, we find the subject frequently discussed in the *Tatler* and the *Spectator*, and Addison points in his happiest way the moral to a contemporary duel between Mr Thornhill and Sir Cholmeley Dering. "I come not," says Spinomont to King Pharamond, "I come not to implore your pardon, I come to relate my sorrow, a sorrow too great for human life to support. Know that this morning I have killed in a duel the man whom of all men living I love best." No reader of *Edmond* can forget Thackeray's description of the doubly fatal duel between the duke of Hamilton and Lord Mohun, which is historical, or the no less life-like though fictitious duel between Lord Mohun and Lord Castlewood. The duel between the two brothers in Stevenson's *Master of Ballantrae* is one of the best conceived in fiction. Throughout the reigns of the Georges they are frequent. Richardson expresses his opinion on the subject in six voluminous letters to the *Literary Repository*.

Insolently asked the marquis, "Who is that young man?" "One," replied Voltaire, "who if he does not parade a great name, honours that he bears." The chevalier said nothing at the time, but, seizing his opportunity, inveigled Voltaire into his coach, and had him beaten by six of his footmen. Voltaire set to work to learn fencing, and then sought the chevalier in the theatre, and publicly challenged him. A *bon-mot* at the chevalier's expense was the only satisfaction that the philosopher could obtain. "Monsieur, si quelque affaire d'intérêt ne vous a point fait oublier l'outrage dont j'ai à me plaindre, j'espère que vous m'en rendrez raison." The chevalier was said to employ his capital in petty usury.

Sheridan, like Farquhar in a previous generation, not only dramatised a duel, but fought two himself. Byron thus commemorates the bloodless duel between Tom Moore and Lord Jeffrey:—

"Can none remember that eventful day,
That ever glorious almost fatal fray,
When Little's leadless pistols met the eye,
And Bow Street myrmidons stood laughing by?"

There are no duels in Miss Austen's novels, but in those of Miss Edgeworth, her contemporary, there are three or four. As we approach the 19th century they become rarer in fiction. Thackeray's novels, indeed, abound in duels. "His royal highness the late lamented commander-in-chief" had the greatest respect for Major Macmurdo, as a man who had conducted scores of affairs for his acquaintance with the greatest prudence and skill; and Rawdon Crawley's duelling pistols, "the same which I shot Captain Marker," have become a household word. Dickens, on the other hand, who depicts contemporary English life, and mostly in the middle classes, in all his numerous works has only three; and George Eliot never once refers to a duel. Tennyson, using a poet's privilege, laid the scene of a duel in the year of the Crimean War, but he echoes the spirit of the times when he stigmatizes "the Christless code that must have life for a blow." Browning, who delights in cases of conscience, has given admirably the double moral aspect of the duel in his two lyrics entitled "Before" and "After."

To pass from fiction to fact we will select the most memorable English duels of the last century and a half. Lord Byron killed Mr Chaworth in 1765; Charles James Fox and Mr Adams fought in 1779; duke of York and Colonel Lennox, 1789; William Pitt and George Tierney, 1796; George Canning and Lord Castlereagh, 1809; Mr Christie killed John Scott, editor of the *London Magazine*, 1821; duke of Wellington and earl of Winchelsea, 1829; Mr Roebuck and Mr Black, editor of *Morning Chronicle*, 1835; Lord Alvanley and a son of Daniel O'Connell in the same year; Earl Cardigan wounded Captain Tuckett, was tried by his peers, and acquitted on a legal quibble, 1840.

The year 1808 is memorable in the annals of duelling in England. Major Campbell was sentenced to death and executed for killing Captain Boyd in a duel. In this case it is true that there was a suspicion of foul play; but in the case of Lieutenant Blundell, who was killed in a duel in 1813, though all had been conducted with perfect fairness, the surviving principal and the seconds were all convicted of murder and sentenced to death, and, although the royal pardon was obtained, they were all cashiered. The next important date is the year 1843, when public attention was painfully called to the subject by a duel in which Colonel Fawcett was shot by his brother-in-law, Lieutenant Monro. The survivor, whose career was thereby blasted, had, it was well known, gone out most reluctantly, in obedience to the then prevailing military code. A full account of the steps taken by the prince consort, and of the correspondence which passed between him and the duke of Wellington, will be found in the *Life of the Prince* by Sir Theodore Martin. The duke, unfortunately, was not an unprejudiced counsellor. Not only had he been out himself, but, in writing to Lord Londonderry on the occasion of the duel between the marquess and Ensign Battier in 1824, he had gone so far as to state that he considered the probability of the Hussars having to fight a duel or two a matter of no consequence. In the previous year there had been formed in London the association for the suppression of duelling. It included leading members of both houses of parliament and distinguished officers of both services. The first report, issued in 1844, gives a memorial of the association presented to Queen Victoria through Sir James Graham, and in a debate in the House of Commons (15th of March 1844) Sir H. Hardinge, the secretary of war, announced to the House that Her Majesty had expressed herself desirous of devising some expedient by which the barbarous practice of duelling should be as much as possible discouraged. In the same debate Mr Turner reckoned the number of duels fought during the reign of George III. at 172, of which 91 had been attended with fatal results; yet in only two of these cases

had the punishment of death been inflicted. But though the proposal of the prince consort to establish courts of honour met with no favour, yet it led to an important amendment of the articles of war (April 1844). The 98th article ordains that "every person who shall fight or promote a duel, or take any steps thereto, or who shall not do his best to prevent duel, shall, if an officer, be cashiered, or suffer such other penalty as a general court-martial may award." These articles, with a few verbal changes, were incorporated in the consolidated Army Act of 1879 (section 38), which is still in force.

In the German army duels are still authorized by the military code as a last resort in grave cases. A German officer who is involved in a difficulty with another is bound to *in Germany*, notify the circumstance to a council of honour at the latest as soon as he has either given or received a challenge. A council of honour consists of three officers of different ranks and is instructed, if possible, to bring about a reconciliation. If unsuccessful it must see that the conditions of the duel are not out of proportion to the gravity of the quarrel. Public opinion was greatly roused by a tragic duel fought by two officers of the reserve in 1896; and the German emperor in a cabinet order of 1897, confirmed in 1901, enforced the regulation of the military court of honour, and gave warning that any infringement would be visited with the full penalties of the law. It is, notwithstanding, still the fact that a German officer who is not prepared to accept a challenge and fight, if the opinion of his regiment demands it, must leave the service. The German penal code (*Reichsstrafgesetzbuch*, pars. 101-110) only punishes a duel when it is fought with lethal weapons; and much controversy has raged round the question of the *Mensuren* or students' duels, which, as being conducted with sharpened rapiers, have, despite the precautions taken, in the way of bandaging the vital parts of the body which a cut would reach, to reduce the risk of a fatal issue to a minimum, been declared by the Supreme Court of the Empire to fall under the head of duels, and as such to be punishable.

The *Mensuren* (German students' duels) above referred to are frequently misunderstood. They bear little resemblance, save in form, to the duel *à l'outrance*, and should rather be considered in the light of athletic games, in which the overflow of high animal spirits in young Germany finds its outlet. These combats are indulged in principally by picked representatives of the "corps" (recognized clubs), and according to the position and value of the *Schmisse* (cuts which have landed) points are awarded to either side. Formerly these so-called duels could be openly indulged in at most universities without let or hindrance. Gradually, however, the academic authorities took cognizance of the illegality of the practice, and in many cases inflicted punishment for the offence. Nowadays, owing to the decision of the supreme court reserving to the common law tribunals the power to deal with such cases, the governing bodies at the universities have only a disciplinary control, which is exercised at the various seats of learning in various degrees: in some the practice is silently tolerated, or at most visited by reprimand; in others, again, by relegation or *carcer*—with the result that the students of one university frequently visit another, in order to be able to fight out their battles under less rigorous surveillance.

Any formal discussion of the morality of duelling is, in England at least, happily superfluous. No fashionable vice has been so unanimously condemned both by moralists and *Moderne* *divines*, and in tracing its history we are reminded of the words of Tacitus, "in civitate nostra et vetabitur semper et retinebitur." Some, however, of the problems, moral and social, which it suggests may be shortly noticed. That duelling flourished so long in England the law is, perhaps, as much to blame as society. It was doubtless from the fact that duels were at first a form of legal procedure that English law has refused to take cognizance of private duels. A duel in the eye of the law differs nothing from an ordinary murder. The greatest English legal authorities, from the time of Elizabeth downwards, such as Coke, Bacon and Hale, have all distinctly

affirmed this interpretation of the law. But here as elsewhere the severity of the penalty defeated its own object. The public conscience revolted against a Draconian code which made no distinction between wilful murder and a deadly combat wherein each party consented to his own death or submitted to the risk of it. No jury could be found to convict when conviction involved in the same penalty a Fox or a Pitt and a Turpin or a Brownrigg. Such, however, was the conservatism of English publicists that Bentham was the first to point out clearly this defect of the law, and propose a remedy. In his *Introduction to the Principles of Morals and Legislation*, published in 1789, Bentham discusses the subject with his usual boldness and logical precision. In his exposition of the absurdity of duelling considered as a branch of penal justice, and its inefficiency as a punishment, he only restates in a clearer form the arguments of Paley. So far there is nothing novel in his treatment of the subject. But he soon parts company with the Christian moralist, and proceeds to show that duelling does, however rudely and imperfectly, correct and repress a real social evil. "It entirely effaces a blot which an insult imprints upon the honour. Vulgar moralists, by condemning public opinion upon this point, only confirm the fact." He then points out the true remedy for the evil. It is to extend the same legal protection to offences against honour as to offences against the person. The legal satisfactions which he suggests are some of them extremely grotesque. Thus for an insult to a woman, the man is to be dressed in a woman's clothes, and the retort to be inflicted by the hand of a woman. But the principle indicated is a sound one, that in offences against honour the punishment must be analogous to the injury. Doubtless, if Bentham were now alive, he would allow that the necessity for such a scheme of legislation had in a great measure passed away. That duels have since become extinct is no doubt principally owing to social changes, but it may be in part ascribed to improvements in legal remedies in the sense which Bentham indicated. A notable instance is Lord Campbell's Act of 1843, by which, in the case of a newspaper libel, a public apology coupled with a pecuniary payment is allowed to bar a plea. In the Indian Code there are special enactments concerning duelling, which is punishable not as murder but as homicide.

Suggestions have from time to time been made for the establishment of courts of honour, but the need of such tribunals is doubtful, while the objections to them are obvious. The present tendency of political philosophy is to contract rather than extend the province of law, and any interference with social life is justly resented. Real offences against reputation are sufficiently punished, and the rule of the lawyers, that mere scurrility or opprobrious words, which neither of themselves import nor are attended with any hurtful effects, are not punishable, seems on the whole a wise one. What in a higher rank is looked upon as a gross insult may in a lower rank be regarded as a mere pleasantry or a harmless joke. Among the lower orders offences against honour can hardly be said to exist; the learned professions have each its own tribunal to which its members are amenable; and the highest ranks of society, however imperfect their standard of morality may be, are perfectly competent to enforce that standard by means of social penalties without resorting either to trial by law or trial by battle.

The duel, which in a barbarous age may be excused as "a sort of wild justice," was condemned by Bacon as "a direct affront of law and tending to the dissolution of magistracy." It survived in more civilized times as a class distinction and as an ultimate court of appeal to punish violations of the social code. In a democratic age and under a settled government it is doomed to extinction. The military duels of the European continent, and the so-called American duel, where the lot decides which of the two parties shall end his life, are singular survivals. For real offences against reputation law will provide a sufficient remedy. The learned professions will have each its own tribunal to which its members are amenable. Social stigma is at once a surer and a juster defence against conduct unworthy of a gentleman. Yet

the duel dies hard, and even to-day it is approved or palliated by some notable publicists and professors in France and Germany. M. H. Marion (*La Grande Encyclopédie*), in an article strongly condemnatory of duels, still holds that the wrongdoer is bound to accept a challenge, though he may not take the offensive, and further allows that obligatory duels may be the only way of evoking a sense of honour and of maintaining discipline in the army. Dr Paulsen goes much further, and not only defends the duels of university students (*Messuren*) as an encouragement of physical exercise, a proof of courage and a protest of worth against wealth, but maintains generally that the duel should be retained as an expedient in those exceptional cases when a man cannot bring himself to drag before a law court the outrage done to his personal honour. But in such cases Dr Paulsen would have the courts hold the injured person scathless, whether he be challenger or challenged, and visit the aggressor with condign punishment.

BIBLIOGRAPHY.—Castillo, *Tractatus de duello* (Turin, 1525); J. P. Pigna, *Il Duello* (1554); Muzio Girolamo, *Trattato del duello* (Venice, 1553); Boyssat, *Recherches sur les duels* (Lyons, 1610); J. Savaron, *Traité contre les duels* (Paris, 1610); Brantôme, *Mémoires sur les duels renommés*; F. Bacon, *Charge concerning Duels*, &c. (1614); d'Audiquier, *Le Vray et ancien usage des duels* (Paris, 1617); *His Majesties Edict and severe Censure against private combats* (London, 1618); Cockburn, *History of Duels* (London, 1700); Brillat Savarin, *Essai sur le duel* (1819); Châteauevillard, *Essai sur le duel* (1836); Colombey, *Histoire anecdotique du duel* (Paris); Fourgeroux de Champigneulle, *Histoire des duels anciens et modernes* (2 vols., Paris, 1835-1837); Millingen, *History of Duelling* (London, 1841); L. Sabine, *Notes on Duels* (Boston, 1855); Steinmetz, *Romanes of Duelling* (London, 1868). See also Eugene Cauchy, *Du duel*, &c. (1846), a learned and philosophic treatise by a French lawyer; G. Letainturier-Fradin, *Le Duel à travers les âges* (Paris, 1892); Mackay, *History of Popular Delusions, Duels and Ordeals*; and for a valuable list of authorities, Buckle, *History of Civilization in England*, ii. 137, note 71. For judicial combats see Gibbon, *Decline and Fall*, ch. xxxviii. For courts of honour see *Armed Strength of the German Empire* (1876). For *Messur*, see Paulsen, *The German Universities* (1906), ch. vi. (F. S.)

DUENNA (Span. *duena*, a married lady or mistress, Lat. *domina*), specifically the chief lady-in-waiting upon the queen of Spain. The word is more widely applied, however, to an elderly lady in Spanish and Portuguese households (holding a position midway between a governess and companion) appointed to take charge of the young girls of the family; and "duenna" is thus used in English as a synonym for chaperon (*q.v.*).

DUET (an adaptation of the Ital. *duetto*, from Lat. *duo*, two), a term in music for a composition for two performers, both either vocal or instrumental. The term is not properly applied to a composition for one voice and one instrument, the latter being regarded as an accompaniment, though in the modern evolution of this latter form of composition it often has the same character. Both parts must be of equal importance; if one is subordinated to the other it becomes an accompaniment and the work ceases to be a duet. Instrumental duets are written either for two different instruments, such as Mozart's duets for violin and piano, or for two similar instruments. Duets written for the pianoforte are either for two performers on two separate instruments or for two performers on the same instrument, when they are termed "duets à quatre mains."

DUFÀURE, JULES ARMAND STANISLAS (1798-1881), French statesman, was born at Saujon (Charente-Inférieure) on the 4th of December 1798. He became an advocate at Bordeaux, where he won a great reputation by his oratorical gifts, but soon abandoned law for politics, and in 1834 was elected deputy. In 1839 he became minister of public works in the Soult ministry, and succeeded in freeing railway construction in France from the obstacles which till then had hampered it. Losing office in 1840, Dufaure became one of the leaders of the Opposition, and on the outbreak of the revolution of 1848 he frankly accepted the Republic, and joined the party of moderate republicans. On October 13th he became minister of the interior under G. Cavaignac, but retired on the latter's defeat in the presidential election. During the Second Empire Dufaure abstained from public life, and practised at the Paris bar with such success that he was elected *député* in 1862. In 1863 he succeeded to

Pasquier's seat in the French Academy. In 1871 he became a member of the Assembly, and it was on his motion that Thiers was elected President of the Republic. Dufaure became the minister of justice as chief of the party of the "left-centre," and his tenure of office was distinguished by the passage of the jury-law. In 1873 he fell with Thiers, but in 1875 resumed his former post under L. J. Buffet, whom he succeeded on the 9th of March 1876 as president of the council. In the same year he was elected a life senator. On December the 12th he withdrew from the ministry owing to the attacks of the republicans of the left in the chamber and of the conservatives in the senate. After the check which the conservatives received on the 16th of May he returned to power on the 24th of December 1877. Early in 1879 Dufaure took part in compelling the resignation of Marshal MacMahon, but immediately afterwards (1st February), worn out by opposition, he himself retired. He died in Paris on the 28th of June 1881.

See G. Picot, *M. Dufaure, sa vie et ses discours* (Paris, 1883).

DUFF, ALEXANDER (1806-1878), Scottish missionary in India, was born on the 26th of April 1806; at Auchnahyle in the parish of Moulin, Perthshire. At St. Andrews University he came under the influence of Dr Chalmers. He then accepted an offer made by the foreign mission committee of the general assembly to become their first missionary to India. He was ordained in August 1829, and started at once for India, but was twice shipwrecked before he reached Calcutta in May 1830, and lost all his books and other property. Making Calcutta the base of his operations, he at once identified himself with a policy which had far-reaching results. Up to this time Protestant missions in India had been successful only in reaching low-caste and outcaste peoples, particularly in Tinevely and south Travancore. The Hindu and Mahomedan communities had been practically untouched. Duff saw that, to reach these communities, educational must take the place of evangelizing methods, and he devised the policy of an educational mission. The success of his work had the effect (1) of altering the policy of the government of India in matters of education, (2) of securing the recognition of education as a missionary agency by Christian churches at home, and (3) of securing entrance for Christian ideas into the minds of high-caste Hindus. He first opened an English school in which the Bible was the centre of the school work, and along with it all kinds of secular knowledge were taught from the rudiments upwards to a university standard. The English language was used on the ground that it was destined to be the great instrument of higher education in India, and also as giving the Hindu the key of Western knowledge. The school soon began to expand into a missionary college, and a government minute was adopted on the 7th of March 1835, to the effect that in higher education the object of the British government should be the promotion of European science and literature among the natives of India, and that all funds appropriated for purposes of education would be best employed on English education alone. Duff wrote a pamphlet on the question, entitled "A New Era of the English Language and Literature in India." He returned home in 1834 broken in health, but succeeded in securing the approval of his church for his educational plans, and also in arousing much interest in the work of foreign missions.

In 1840 he returned to India. In the previous year the earl of Auckland, governor-general, had yielded to the "Orientalists" who opposed Duff, and adopted a policy which was a compromise between the two. At the Disruption of 1843 Duff sided with the Free Church, gave up the college buildings, with all their effects, and with unabated courage set to work to provide a new institution. He had the support of Sir James Outram and Sir Henry Lawrence, and the encouragement of seeing a new band of converts, including several young men of high caste. In 1844 Viscount Hardinge opened government appointments to all who had studied in institutions similar to Duff's foundation. In the same year Duff took part in founding the *Calcutta Review*, of which from 1845 to 1849 he was editor. In 1849 he returned home. He was moderator of the Free Church assembly in 1857. He gave evidence before various Indian committees

parliament on matters of education. This led to an important despatch by Viscount Halifax, president of the board of control, to the marquess of Dalhousie, the governor-general, authorizing an educational advance in primary and secondary schools, the provision of technical and scientific teaching, and the establishment of schools for girls.

In 1854 Duff visited the United States, where what is now New York University gave him the degree of LL.D.; he was already D.D. of Aberdeen. In 1856 he returned to India, where the mutiny soon broke out; his descriptive letters were collected in a volume entitled *The Indian Mutiny, its Causes and Results* (1858). Duff gave much thought and time to the university of Calcutta, which owes its examination system and the prominence given to physical sciences to his influence. In 1863 Sir Charles Trevelyan offered him the post of vice-chancellor of the University, but his health compelled him to leave India. As a memorial of his work the Duff Hall was erected in the centre of the educational buildings of Calcutta; and a fund of £11,000 was raised for his disposal, the capital of which was afterwards to be used for invalided missionaries of his own church. In 1864 Duff visited South Africa, and on his return became convener of the foreign missions committee of the Free Church. He raised £10,000 to endow a missionary chair at New College, Edinburgh, and himself became first professor. Among other missionary labours of his later years, he helped the Free Church mission on Lake Nyassa, travelled to Syria to inspect a mission at Lebanon, and assisted Lady Aberdeen and Lord Polwarth to establish the Gordon Memorial Mission in Natal. In 1873 the Free Church was threatened with a schism owing to negotiations for union with the United Presbyterian Church. Duff was called to the chair, and guided the church happily through this crisis. He also took part in forming the alliance of Reformed Churches holding the Presbyterian system. He died on the 12th of February 1878. By his will he devoted his personal property to found a lectureship on foreign missions on the model of the Bampton Lectures.

See his *Life*, by George Smith (2 vols.) (D. M.)

DUFFERIN AND AVA, FREDERICK TEMPLE HAMILTON-TEMPLE-BLACKWOOD, 1st MARQUESS OF (1826-1902), British diplomatist, son of Price Blackwood, 4th Baron Dufferin, was born at Florence, Italy, on the 21st of June 1826. The Irish Blackwoods were of old Scottish stock,¹ tracing their descent back to the 14th century. John Blackwood of Bangor (1591-1663), the ancestor of the Irish line, made a fortune and acquired landed property in county Down, and his great-grandson Robert was created a baronet in 1762. Sir Robert's son, Sir John, married the heiress of the Hamiltons, earls of Clanbrassil and viscounts of Clondeboyne ("clan of yellow Hugh"), and thus brought into the family a large property in the borough of Killyleagh and barony of Dufferin, county Down. Sir John Blackwood (d. 1799) declined a peerage, and so did his heir James at the time of the Union, but the Irish title of Baroness Dufferin was conferred (1800) on Sir John's widow, and James (d. 1836) succeeded as second baron in 1808. His brother Hans (d. 1839) became third baron, and by his marriage with Miss Temple (a descendant of the Temples of Stowe) was the father of Price Blackwood, 4th baron. Among other distinguished members of the family was Admiral Sir Henry Blackwood, Bart. (1770-1832)—a brother of James and Hans—one of Nelson's captains, who commanded the "Euryalus" at Trafalgar. Price Blackwood, too, was in the Navy; his marriage in 1825 with Helen Selina Sheridan, a daughter of Thomas Sheridan, and granddaughter of Richard Brinsley Sheridan, the dramatist and politician, was against his parents' wishes, but his young wife's talents and beauty soon won them over.

Frederick went to Eton (1839-1843) and Christ Church, Oxford (1845-1847), where he took a pass school and was President of the Union. His father died in 1841, and the influence of his mother—one of three unusually accomplished

¹ One branch of the Blackwood family emigrated to France; the head of this line being Adam Blackwood (d. 1613), jurist, poet, a divine, and senator of the presidial court of Poitiers.

sisters, the other two being the duchess of Somerset and Mrs Norton (q.v.)—was very marked on his mental development; she lived till 1867 and is commemorated by the "Helen's Tower" erected by her son in her honour at Clondeboyne (the Irish seat of the Blackwoods) in 1861, and adorned with epigraphical verses written by Tennyson, Browning and others. On leaving Oxford Lord Dufferin busied himself for some little while with the management of his Irish estates. In 1846-1848 he was active in relieving the distress in Ireland due to the famine, and he was always generous and liberal in his relations with his tenants. In 1855 he already advocated compensation for disturbance and for improvements; but while supporting reasonable reform, he demanded justice for the landowners. In later years (1868-1881) he wrote much, in opposition to J. S. Mill, on behalf of Irish landlordism, and when Gladstone adopted Home Rule, Lord Dufferin, who had been attached throughout his career to the Liberal party, regarded the new policy as fatal both to Ireland and to the United Kingdom, though, being then an ambassador, he took no public part in opposing it.

Starting with every personal and social advantage, Lord Dufferin quickly became a favourite both at Court and in London society; and in 1849 he was made a lord-in-waiting. In political life he followed Lord John Russell, and in 1850 was further attached to the party by being created a peer of the United Kingdom as Baron Clondeboyne. In 1855 Lord John Russell took him as attaché on his special mission to the Vienna Conference. Meanwhile Lord Dufferin was enlarging his experience by foreign travel, and in 1856 he went on a yachting-tour to Iceland, which he described with much humour and graphic power in his successful book, *Letters from High Latitudes*; this volume made his reputation as a writer, though his only other purely literary publication was his memorial edition (1894) of his mother's *Poems and Verses*. In 1860 Lord John Russell sent him as British representative on a joint commission of the powers appointed to inquire into the affairs of the Lebanon (Syria), where the massacres of Christian Maronites by the Mussulman Druses had resulted in the landing of a French force and the possibility of a French occupation. Lord Dufferin was associated with French, Russian, Prussian and Turkish colleagues, and his difficult diplomatic position was made none the less delicate by his conscientious endeavour to be just to all parties. Even if he had not satisfied himself that the Mahomedans were by no means wholly to blame, the question of punishment was in any case complicated by the problem of future administration. His own proposal to put the whole Syrian province under a responsible governor, appointed by the sultan for a term of years, with unfettered jurisdiction, was rejected; but at last it was agreed to place a Christian governor, subordinate to the Porte, over the Lebanon district, and to set up local administrative councils. In May 1861 the French forces departed, and Lord Dufferin was thanked for his services by the government.

In 1862 he married Hariot, daughter of Captain A. Rowan Hamilton, of Killyleagh Castle, Down. He held successively the posts of under-secretary for India (1864-1866) and under-secretary for war (1866) in Lord Palmerston's and Earl Russell's ministries; and he was chancellor of the duchy of Lancaster, outside the cabinet, under Mr Gladstone (1868-1872). In 1871 he was created earl of Dufferin.

In 1872 he was appointed governor-general of Canada. There his tact and personal charm and genial hospitality were invaluable. He had already become known as a powerful and graceful orator, and a man of culture and political distinction; and his abilities were brilliantly displayed in dealing with the problems of the newly united provinces of the Canadian Dominion. At a time when a weak or unattractive governor-general might easily have damaged the imperial connexion, he admittedly strengthened and consolidated it. Lord Dufferin left Canada in 1878, and in 1879, rather to the annoyance of his old party leader, he accepted from the conservative prime minister, Lord Beaconsfield, the appointment of ambassador to Russia. At St Petersburg he did useful diplomatic work for a couple of years, and then, in

1881, was transferred to Constantinople as ambassador to Turkey. He was soon involved in the negotiations connected with the situation in Egypt caused by Arabi's revolt and the intervention of Great Britain. It was Lord Dufferin's task to arrange matters at Constantinople, so that no international friction should be created by any inconvenient assertion by the sultan of his position as suzerain, while it was also necessary to avoid offending either the sultan or the other powers by any appearance of ignoring their rights. He was considerably helped by Turkish ineptitude, and by the accomplished fact of British military successes in Egypt, but his own diplomacy was responsible for securing the necessary freedom of action for the British government.

From October 1882 to May 1883 he was himself in Egypt as British commissioner to report on a scheme of reorganization; and his recommendations—drawn up in a somewhat elaborate State paper—formed the basis of the subsequent reforms. In 1884 he was appointed viceroy of India, succeeding Lord Ripon, whose zeal on behalf of the natives had created a good deal of antagonism among the officials and the Anglo-Indian community. Lord Dufferin, though agreeing in the main with Lord Ripon's policy, was excellently fitted for the task of restoring confidence without producing any undesirable reaction, and in domestic affairs his vicerealty was a period of substantial progress, in the reform of the evils of land tenure and in other directions. He was responsible also for initiating stable relations with Afghanistan, and settling the crisis with Russia arising out of the Panjdeh incident (1885), which led to the delimitation of the north-west frontier (1887). The most striking event of his administration was, however, the annexation of Burma, resulting from the Burmese War of 1885; and this procured him, on his resignation, the title of marquess of Dufferin and Ava (1888). His vicerealty was also memorable for Lady Dufferin's work, and the starting of a fund called by her name, for providing better medical treatment for native women. In 1888 he was made ambassador at Rome, and in 1892 he was promoted to be ambassador in Paris, a post which he retained till 1896, when he retired from the public service.

Lord Dufferin was one of the most admired public servants of his time. A man of great natural gifts, he had a special talent for diplomacy, though he has no claim to a place in the first rank of statesmen. He was remarkable for tact and amiability, and had a florid and rather elaborately literary style of oratory, which also characterized his despatches and reports. For purposes of ceremony his courtliness, dignity and charm of manner were invaluable, and both in public and in private life he was a conspicuous "great gentleman." His last years, spent mainly at his Irish home, were clouded by the death of his eldest son, the earl of Ava, at Ladysmith in the Boer War (1900), and by business troubles. He was so ill-advised as to become chairman in 1897 of the "London and Globe Finance Corporation," a financial company which most good judges in the city of London thought to be too much in the hands of its managing director, Mr Whitaker Wright, whose methods had been a good deal criticized. At last there came a complete crash, and an exposure before the liquidator, which ultimately led to Mr Whitaker Wright's trial for fraud in 1904, and his suicide within the precincts of the court on being found guilty. Lord Dufferin did not live to see this final catastrophe. The affairs of the company were still under investigation in bankruptcy when, on the 12th of February 1902, he died. He had been in failing health for two or three years, but, having once become chairman of the "London and Globe," he had insisted upon standing by his colleagues when difficulties arose. Incautious as he had been in accepting the position, no reflections were felt to be possible on Lord Dufferin's personal honour; he was a serious loser by the failure, and he had followed his predecessor in the chairmanship, Lord Loch, in confiding too wholly in the masterful personality of Mr Wright. He was succeeded in the title by his second son Terence (b. 1866).

The official *Life of Lord Dufferin*, by Sir Alfred Lyall, appeared in 1905. There are two Canadian histories of his Canadian adminis-

tration, one by George Stewart (1878), the other by W. Leggo (1878); Lady Dufferin brought out *Our Viceregal Life in India* in 1889, and *My Canadian Journal* in 1891. See also the articles on *INDIA: History*; *CANADA: History*; and *EGYPT: History*. (H. CH.)

DUFF-GORDON, LUCIE (1821-1869), English woman of letters, daughter of John and Sarah Austin (q.v.), was born on the 24th of June 1821. Her chief playfellows as a child were her cousin, Henry Reeve, and John Stuart Mill, who lived next door in Queen Square, London. In 1834 the Austins went to Boulogne, and at table d'hôte Lucie found herself next to Heinrich Heine. The poet and the little girl became fast friends, and years afterwards she contributed to Lord Houghton's *Monographs Personal and Social* a touching account of a renewal of their friendship when Heine lay dying in Paris. Her parents went to Malta in 1836, and Lucie Austin was left in England at school, but her unconventional education made the restrictions of a girls' school exceedingly irksome. She showed her independence of character by joining the English Church, though this step was certain to cause pain to her parents, who were Unitarians, and to many of her friends. She married in 1840 Sir Alexander Duff-Gordon (1811-1872). With her mother's beauty she had inherited her social gifts, and she gathered round her a brilliant circle of friends. George Meredith has analysed and described her extraordinary success as a hostess, and the process by which she reduced too ardent admirers to "happy crust-munching devotees." "In England, in her day," he says, "while health was with her, there was one house where men and women conversed. When that house perforce was closed, a light had gone out in our country." After her father's death, she fell into weak health and was obliged to seek sunnier climes. She went in 1860 to the Cape of Good Hope, and later to Egypt, where she died on the 14th of July 1869. She had translated among other works *Ancient Grecian Mythology* (1839) from the German of Niebuhr; *Mary Schweidler; The Amber Witch* (1844) from the German of Wilhelm Meinhold; and *Stella and Vanessa* (1850) from the French of A. F. L. de Wailly. Her *Letters from the Cape* (1862-1863) appeared in 1865; and in 1865 her *Letters from Egypt*, edited by her mother, attracted much attention. *Last Letters from Egypt* (1875) contained a memoir by her daughter, Mrs Janet Ross. Lady Duff-Gordon won the hearts of her Arab dependents and neighbours. She doctored their sick, taught their children, and sympathized with their sorrows.

The *Letters from Egypt* were not originally published in a complete form. A fuller edition than had before been published, with an introduction by George Meredith, was edited in 1902 by Mrs Janet Ross. See also Mrs Ross's *Three Generations of Englishwomen* (1886).

DUFFTOWN, a municipal and police burgh of Banffshire, Scotland, on the Fiddich, 64 m. W.N.W. of Aberdeen by the Great North of Scotland railway. Pop. (1901) 1223. It dates from 1817 and bears the name of its founder, James Duff, 4th earl of Fife. Although planned in the shape of a cross, with a square and tower in the middle, the arms of the cross are not straight, the constructor holding the ingenious opinion that, in order to prevent little towns from being taken in at a glance, their streets should be crooked. The leading industries are lime-works and distilleries, the water being specially fitted for the making of whisky. The town has considerable repute as a health resort, owing partly to its elevation (737 ft.) and partly to the natural charms of the district. The parish of Mortlach, in which Dufftown is situated, is rich in archaeological and historical associations. What is called the Stone of Mortlach is traditionally believed to have been erected to commemorate the success of Malcolm II. over the Danes in 1010. The three large stones known as "The King's Grave," a hill-fort, and cairns are of interest to the antiquary. The old church of Mortlach, though restored and almost renewed, still contains some lancet windows and a round-headed doorway, besides monuments dating from 1417. A portion of old Balvenie Castle, a ruin, is considered to be of Pictish origin, but most of it is in the Scots Baronial. It has associations with Alexander Stewart, earl of Buchan and lord of Badenoch (1343-1405), son of Robert II., whose ruffianly conduct in Elginshire earned him the designation of the Wolf of

Badenoch, the Comyns, the Douglasses (to whom it gave the title of baron in the 15th century), the Stuarts and the Duffs. The new castle, an uninteresting building, was erected in 1724 by the earl of Fife, and though untenanted is maintained in repair. Two miles to the S.E. of Dufttown is the ruined castle of Auchindown, finely situated on a limestone crag, 200 ft. high, of which three sides are washed by the Fiddich and the fourth was protected by a moat. It dates from the 11th century, and once belonged to the Ogilvies, from whom it passed in 1535 to the Gordons. The Gothic hall with rows of fluted pillars is in fair preservation. Ben Rinnes (2755 ft.) and several other hills of lesser altitude all lie within a few miles of Dufttown. About 4 m. to the N.W. is Craigealachie—Gaelic for "the rock of alarm"—(pop. 454), on the confines of Elginshire. It is situated on the Spey amidst scenery of surpassing loveliness. The slogan of the Grants is "Stand fast Craigealachie!" The place has become an important junction of the Great North of Scotland railway system.

DUFFY, SIR CHARLES GAVAN (1816-1903), Irish and colonial politician, was born in Monaghan, Ireland, on the 12th of April 1816. At an early age he became connected with the press, and was one of the founders (1842) of the *Nation*, a Dublin weekly which was remarkable for its talent, for its seditious tendencies, and for the fire and spirit of its political poetry. In 1844 Duffy was included in the same indictment with O'Connell, and shared his conviction in Dublin and his acquittal by the House of Lords upon a point of law. His ideas, nevertheless, were too revolutionary for O'Connell; a schism took place in 1846, and Duffy united himself to the "Young Ireland" party. He was tried for treason-felony in 1848, but the jury were unable to agree. Duffy continued to agitate in the press and in parliament, to which he was elected in 1852, but his failure to bring about an alliance between Catholics and Protestants upon the land question determined him in 1856 to emigrate to Victoria. There he became in 1857 minister of public works, and after an active political career, in the course of which he was prime minister from 1871 to 1873, when he was knighted, he was elected speaker of the House of Assembly in 1877, being made K.C.M.G. in the same year. In 1880 he resigned and returned to Europe, residing mostly in the south of France. He published *The Ballad Poetry of Ireland* (1845), several works on Irish history, *Conversations with Carlyle* (1892), *Memoirs* (1898), &c. In 1891 he became first president of the Irish Literary Society. He was married three times, his third wife dying in 1889. He died on the 9th of February 1903.

DUFOUR, WILHELM HEINRICH [GUILLAUME HENRI] (1787-1875), Swiss general, was born at Constance of Genevese parents temporarily in exile, on the 15th of September 1787. In 1807 he went to the *École Polytechnique* at Paris, Switzerland being then under French rule, taking the 140th place only in his entrance examination. By two years' close study he so greatly improved his position that he was ranked fifth in the exit examination. Immediately on leaving the school he received a commission in the engineers, and was sent to serve in Corfu, which was blockaded by the English. During the Hundred Days he attained the rank of captain, and was employed in raising fortifications at Grenoble. After the peace that followed Waterloo he resumed his status as a Swiss citizen, and devoted himself to the military service of his native land. From 1819 to 1830 he was chief instructor in the military school of Thun, which had been founded mainly through his instrumentality. Among other distinguished foreign pupils he instructed Louis Napoleon, afterwards emperor of the French. In 1827 he was raised to the rank of colonel, and commanded the Federal army in a series of field manoeuvres. In 1831 he became chief of the staff, and soon afterwards he was appointed quartermaster-general. Two years later the diet commissioned him to superintend the execution of a complete trigonometrical survey of Switzerland. He had already made a cadastral survey of the canton of Geneva, and published a map of the canton on the scale of 1:100,000. The larger work occupied thirty-two years, and was accomplished with complete success. The

map in 25 sheets on the scale of 1:100,000 was published at intervals between 1842 and 1865, and is an admirable specimen of cartography. In recognition of the ability with which Dufour had carried out his task, the Federal Council in 1868 ordered the highest peak of Monte Rosa to be named Dufour Spitze. In 1847 Dufour was made general of the Federal Army, which was employed in reducing the revolted Catholic cantons. The quickness and thoroughness with which he performed the painful task, and the wise moderation with which he treated his vanquished fellow-countrymen, were acknowledged by a gift of 60,000 francs from the diet and various honours from different cities and cantons of the confederation. In politics he belonged to the moderate conservative party, and he consequently lost a good deal of his popularity in 1848. In 1864 he presided over the international conference which framed the Geneva Convention as to the treatment of the wounded in time of war, &c. He died on the 14th of July 1875. His *De la fortification permanente* (1850) is an important and original contribution to the science of fortification, and he was also the author of a *Mémoire sur l'artillerie des anciens et sur celle du moyen âge* (1840), *Mémoire de tactique pour les officiers de toutes armes* (1842), and various other works in military science. His memoir, *La Campagne du Sonderbund* (Paris, 1876), is prefaced by a biographical notice. An equestrian statue of General Dufour was erected after his death at Geneva by national subscription.

DUFRENOY, OURS PIERRE ARMAND PETIT (1792-1857), French geologist and mineralogist, was born at Sevran, in the department of Seine-et-Oise, in France, on the 5th of September 1792. After leaving the Imperial Lyceum, in 1811, he studied till 1813 at the *École Polytechnique*, and then entered the Corps des Mines. He subsequently assisted in the management of the *École des Mines*, of which he was professor of mineralogy and afterwards director. He was also professor of geology at the *École des Ponts et Chaussées*. In conjunction with *Élie de Beaumont* he in 1841 published a great geological map of France, the result of investigations carried on during thirteen years (1823-1836). Five years (1836-1841) were spent in writing the text to accompany the map, the publication of the work with two quarto vols. of text extending from 1841-1848; a third volume was issued in 1873. The two authors had already together published *Voyage métallurgique en Angleterre* (1827, 2nd ed. 1837-1839), *Mémoires pour servir à une description géologique de la France*, in four vols. (1830-1838), and a *Mémoire* on Cantal and Mont-Dore (1833). Other literary productions of Dufrenoy are an account of the iron mines of the eastern Pyrenees (1834), and a treatise on mineralogy (3 vols. and atlas, 1844-1845; 2nd ed., 4 vols. and atlas, 1856-1859), in which the geological relations as well as the physical and chemical properties of minerals were dealt with; he likewise contributed numerous papers to the *Annales des mines* and other scientific publications, one of the most interesting of which is entitled *Des terrains volcaniques des environs de Naples*. Dufrenoy was a member of the Academy of Sciences, a commander of the Legion of Honour, and an inspector-general of mines. He died in Paris on the 20th of March 1857.

DUFRESNY, CHARLES, SIEUR DE LA RIVIÈRE (1648-1721), French dramatist, was born in Paris in 1648. The allegation that his grandfather was an illegitimate son of Henry IV. procured him the liberal patronage of Louis XIV., who gave him the post of *valet de chambre*, and affixed his name to many lucrative privileges. Dufresny's expensive habits neutralized all efforts to enrich him, and as if to furnish a piquant commentary on the proverb that poverty makes us acquainted with strange bedfellows, he married, as his second wife, a washerwoman, in discharge of her bill—a whimsicality which supplied *Le Sage* with an episode in the *Diable boiteux*, and was made the subject of a comedy by J. M. Deschamps (*Charles Rivière Dufresny, ou le mariage imprévu*). He died in Paris on the 6th of October 1724. His plays, destitute for the most part of all higher qualities, abound in sprightly wit and pithy sayings. In the six volumes of his *Théâtre* (Paris, 1731), some of the best are *L'Esprit de contradiction* (1700), *Le Double Veuve* (1701), *La Joueurse* (1709), *La Coquette de village* (1715), *La Réconciliation normande* (1719)

and *Le Mariage fait et rompu* (1721). A volume of *Poésies diverses*, two volumes of *Nouvelles historiques* (1692), and *Les Amusemens sérieux et comiques d'un Siamois* (1705), a work to which Montesquieu was indebted for the idea of his *Lettres persanes*, complete the list of Dufresny's writings. The best edition of his works is that of 1747 (4 vols.). His *Théâtre* was edited (1882) by Georges d'Heylli.

DUGAZON [JEAN HENRI GOURGAUD] (1746-1809), French actor, was born in Marseilles on the 15th of November 1746, the son of the director of military hospitals there. He began his career in the provinces, making his début in 1770 at the Comédie Française, where he aspired to leading comedy rôles. He pleased the public at once and was made *sociétaire* in 1772. Dugazon was an ardent revolutionist, helped the schism which divided the company, and went with Talma and the others to what became the Théâtre de la République. After the closing of this theatre, and the dissolution of the Comédie Française, he took refuge at the Théâtre Feydeau until (1799) he returned to the restored Comédie. He retired in 1807, and died insane at Sandillon in 1809. Dugazon wrote three mediocre comedies of a political character, performed at the Théâtre de la République. He married, in 1776, Louis Rose Lefèvre, but was soon divorced and then married again. The first Madame Dugazon (1755-1821), the daughter of a Berlin dancing master, was a charming actress. Her first appearance on the stage was made at the age of twelve as a dancer. It was as an actress "with songs" that she made her début at the Comédie Italienne in 1774 in Grétry's *Sylvain*. She was at once admitted *pensionnaire* and in 1776 *sociétaire*. Madame Dugazon delighted all Paris, and nightly crowded the Comédie Italienne for more than twenty years. The two kinds of parts with which she was especially identified— young mothers and women past their first youth—are still called "*dugazons*" and "*mères dugazons*." Examples of the first are Jenny in *La Dame blanche* and Berthe de Simiane in *Les Mousquetaires de la reine*; of the second, Marguerite in *Le Prê aux clercs* and the queen in *La Part du diable*.

Dugazon's sister, MARIE ROSE GOURGAUD (1743-1804), was an actress who first played at Stuttgart, where she married Angelo, brother of Gaetano Vestris, the dancer. Under the protection of the dukes of Choiseul and Duras, she was commanded to make her début at the Comédie Française in 1768, where she created important parts in a number of tragedies.

DUGDALE, SIR WILLIAM (1605-1686), English antiquary, was born at Shustoke, near Coleshill, in Warwickshire, on the 12th of September 1605, the son of a country gentleman of an old Lancashire stock; he was educated at Coventry. To please his father, who was old and infirm, he married at seventeen. He lived with his wife's family until his father's death in 1624, when he went to live at Fillongley, near Shustoke, an estate formerly purchased for him by his father. In 1625 he purchased the manor of Blythe, Shustoke, and removed thither in 1626. He had early shown an inclination for antiquarian studies, and in 1635, meeting Sir Symon Archer (1581-1662), himself a learned antiquary, who was then employed in collecting materials for a history of Warwickshire, he accompanied him to London. There he made the acquaintance of Sir Christopher (afterwards Lord) Hatton, comptroller of the household, and Thomas, earl of Arundel, then earl marshal of England. In 1638 Dugdale was created a pursuivant of arms extraordinary by the name of Blanch Lyon, and in 1639 *rouge croix* pursuivant in ordinary. He now had a lodging in the Herald's Office, and spent much of his time in London examining the records in the Tower and the Cottonian and other collections of MSS. In 1641 Sir Christopher Hatton, foreseeing the war and dreading the ruin and spoliation of the Church, commissioned him to make exact drafts of all the monuments in Westminster Abbey and the principal churches in England, including Peterborough, Ely, Norwich, Lincoln, Newark, Beverley, Southwell, Kingston-upon-Hull, York, Selby, Chester, Lichfield, Tamworth and Warwick. In June

1642 he was summoned to attend the king at York. When war broke out Charles deputed him to summon to surrender the castles of Banbury and Warwick, and other strongholds which were being rapidly filled with ammunition and rebels. He went with Charles to Oxford, remaining there till its surrender in 1646. He witnessed the battle of Edgehill, where he made afterwards an exact survey of the field, noting how the armies were drawn up, and where and in what direction the various movements took place, and marking the graves of the slain. In November 1642 he was admitted M.A. of the university, and in 1644 the king created him Chester herald. During his leisure at Oxford he collected material at the Bodleian and college libraries for his books. In 1646 Dugdale returned to London and compounded for his estates, which had been sequestrated, by a payment of £168. After a visit to France in 1648 he continued his antiquarian researches in London, collaborating with Richard Dodsworth in his *Monasticon Anglicanum*, which was published successively in single volumes in 1655, 1664 and 1673. At the Restoration he obtained the office of Norroy king-at-arms, and in 1677 was created garter principal king-at-arms, and was knighted. He died "in his chair" at Blythe Hall on the 10th of February 1686.

Dugdale's most important works are *Antiquities of Warwickshire* (1656); *Monasticon Anglicanum* (1655-1673); *History of St Paul's Cathedral* (1658); and *Baronage of England* (1675-1676). His *Life*, written by himself up to 1678, with his diary and correspondence, and an index to his manuscript collections, was edited by William Hamper, and published in 1827.

DUGONG, one of the two existing generic representatives of the Sirenia, or herbivorous aquatic mammals. Dugongs are distinguished from their cousins the manatis by the presence in the upper jaw of the male of a pair of large tusks, which in the female are arrested in their growth, and remain concealed. There are never more than five molar teeth on each side of either jaw, or twenty in all, and these are flat on the grinding surface. The flippers are unprovided with nails, and the tail is broad, and differs from that of the manati in being crescent-shaped instead of rounded. The bones are hard and firm, and take a polish equal to that of ivory. Dugongs frequent the shallow waters of the tropical seas, extending from the east coast of Africa north of the mouth of the Zambesi, along the shores of the Indian, Malayan and Australian seas, where they may be seen basking on the surface of the water, or browsing on submarine pastures of seaweed, for which the thick obtuse lips and truncated snout pre-eminently fit them. They are gregarious, feeding in large



The Dugong.

numbers in localities where they are not often disturbed. The female produces a single young one at a birth, and is remarkable for the great affection it shows for its offspring, so that when the young dugong is caught there is no difficulty in capturing the mother. Three species—the Indian dugong (*Halicore dugong*), the Red Sea dugong (*H. tabernaculi*) and the Australian dugong (*H. australis*)—are commonly recognized. The first is abundant along the shores of the Indian Ocean, and is captured in large numbers by the Malays, who esteem its flesh a great delicacy; the lean portions, especially of young specimens, are regarded by Europeans as excellent eating. It is generally taken by spearing, the main object of the hunter being to raise the tail out of the water, when the animal becomes perfectly powerless. It seldom attains a length of more than 8 or 10 ft. The Australian dugong is a larger species, attaining sometimes length of 15 ft.; it occurs along the Australian coast fr

Moreton Bay to Cape York, and is highly valued by the natives, who hunt it with spears, and gorge themselves with its flesh, when they are fortunate enough to secure a carcase. Of late years the oil obtained from the blubber of this species has been largely used in Australia as a substitute for cod-liver oil. It does not contain iodine, but is said to possess all the therapeutic qualities of cod-liver oil without its nauseous taste. A full-grown dugong yields from 10 to 12 gallons of oil, and this forms in cold weather a thick mass, and requires to be melted before a fire previous to being used. The flesh of the Australian dugong is easy of digestion, the muscular fibre when fresh resembling beef, and when salted having the flavour of bacon. In the earliest Australian dugong-fishery natives were employed to harpoon these animals, which soon, however, became too wary to allow themselves to be approached near enough for this purpose, and the harpoon was abandoned for the net. The latter is spread at night, and in its meshes dugongs are caught in considerable numbers. (R. L.*)

DUGUAY-TROUIN, RENÉ (1673-1736), French sea captain, belonged to a well-known family of merchants and sea captains of St Malo. He was born at St Malo on the 10th of June 1673. He was originally intended for the church, and studied with that view at Rennes and Caen; but on the breaking out of the war with England and Holland in 1689 he went to sea in a privateer owned by his family. During the first three months his courage was tried by a violent tempest, an imminent shipwreck, the boarding of an English ship, and the threatened destruction of his own vessel by fire. The following year, as a volunteer in a vessel of 28 guns, he was present in a bloody combat with an English fleet of five merchant vessels. The courage he then showed was so remarkable that in 1691, at the age of eighteen, his family gave him a corsair of 14 guns; and having been thrown by a tempest on the coast of Ireland, he burned two English ships in the river Limerick. In 1694 his vessel of 40 guns was captured by the English, and, being taken prisoner, he was confined in the castle of Plymouth. He escaped, according to his own account, by the help of a pretty shopwoman and her lover, a French refugee in the English service. He then obtained command of a vessel of 48 guns, and made a capture of English vessels on the Irish coast. In 1696 he made a brilliant capture of Dutch vessels, and the king hearing an account of the affair gave him a commission as *capitaine de frégate* (commander) in the royal navy. In 1704-1705 he desolated the coasts of England. In 1706 he was raised to the rank of captain of a vessel of the line. In 1707 he was made chevalier of the order of St Louis, and captured off the Lizard the greater part of an English convoy of troops and munitions bound for Portugal. His most glorious action was the capture in 1711 of Rio Janeiro, on which he imposed a heavy contribution. In 1715 he was made *chef d'escadre*, the rank which in the French navy answered to the English commodore, and in 1728 commander of the order of St Louis and *lieutenant général des armées navales*. In 1731 he commanded a squadron for the protection of French commerce in the Levant. He died on the 27th of September 1736.

See his own *Mémoires* (1740); and J. Poulain, *Duguay-Trouin* (1882).

DU GUESCLIN, BERTRAND (c. 1320-1380), constable of France, the most famous French warrior of his age, was born of an ancient but undistinguished family at the castle of La Motte-Broons (Dinan). The date of his birth is doubtful, the authorities varying between 1311 and 1324. The name is spelt in various ways in contemporary records, e.g. Clauquin, Klesquin, Guesquin, Glayaquin, &c. The familiar form is found on his monument at St Denis, and in some legal documents of the time. In his boyhood Bertrand was a dull learner, spending his time in open-air sports and exercises, and could never read or write. He was remarkable for ugliness, and was an object of aversion to his parents. He first made himself a name as a soldier at the tournament held at Rennes in 1338 to celebrate the marriage of Charles of Blois with Jeanne de Penthièvre, at which he unseated the most famous competitors. In the war which followed between Charles of Blois and John de Montfort, for the

possession of the duchy of Brittany, he served his apprenticeship as a soldier (1341). As he was not a great baron with a body of vassals at his command, he put himself at the head of a band of adventurers, and fought on the side of Charles and of France. He distinguished himself by a brilliant action at the siege of Vannes in 1342; and after that he disappears from history for some years.

In 1354, having shortly before been made a knight, he was sent into England with the lords of Brittany to treat for the ransom of Charles of Blois, who had been defeated and captured by the English in 1347. When Rennes and Dinan were attacked by the duke of Lancaster in 1356, Du Guesclin fought continuously against the English, and at this time he engaged in a celebrated duel with Sir Thomas Canterbury. He finally forced his way with provisions and reinforcements into Rennes, which he successfully defended till June 1357, when the siege was raised in pursuance of the truce of Bordeaux. For this service he was rewarded with the lordship of Pontorson. Shortly afterwards he passed into the service of France, and greatly distinguished himself at the siege of Melun (1359), being, however, taken prisoner a little later by Sir Robert Knollys. In 1360, 1361 and 1362 he was continually in the field, being again made prisoner in 1360. In 1364 he married, but was soon again in the field, this time against the king of Navarre. In May 1364 he won an important victory over the Navarrese at Cocherel, and took the famous *Capital de Buch* prisoner. He had previously been made lord of La Roche-Tesson (1361) and chamberlain (1364); he was now made count of Longueville and lieutenant of Normandy. Shortly afterwards, in aiding Charles of Blois, Du Guesclin was taken prisoner by Sir John Chandos at the battle of Auray, in which Charles was killed. The close of the general war, however, had released great numbers of mercenaries (the great companies) from control, and, as they began to play the part of brigands in France, it was necessary to get rid of them. Du Guesclin was ransomed for 100,000 crowns, and was charged to lead them out of France. He marched with them into Spain, supported Henry of Trastámara against Pedro the Cruel, set the former upon the throne of Castile (1366), and was made constable of Castile and count of Trastámara. In the following year he was defeated and captured by the Black Prince, ally of Pedro, at Navarrete, but was soon released for a heavy ransom. Once more he fought for Henry, won the battle of Montiel (1369), reinstated him on the throne, and was created duke of Molina.

In May 1370, at the command of Charles V., who named him constable of France, he returned to France. War had just been declared against England, and Du Guesclin was called to take part in it. For nearly ten years he was engaged in fighting against the English in the south and the west of France, recovering from them the provinces of Poitou, Guienne and Auvergne, and thus powerfully contributing to the establishment of a united France. In 1373, when the duke of Brittany sought English aid against a threatened invasion by Charles V., Du Guesclin was sent at the head of a powerful army to seize the duchy, which he did; and two years later he frustrated the attempt of the duke with an English army to recover it. Finding in 1370 that the king entertained suspicions of his fidelity to him, he resolved to give up his constable's sword and retire to Spain. His resolution was at first proof against remonstrance; but ultimately he received back the sword, and continued in the service of France. In 1380 he was sent into Languedoc to suppress disturbances and brigandage, provoked by the harsh government of the duke of Anjou. His first act was to lay siege to the fortress of Châteauneuf-Randon, but on the eve of its surrender the constable died on the 13th of July 1380. His remains were interred, by order of the king, in the church of St Denis. Du Guesclin lost his first wife in 1371, and married a second in 1373, but he left no legitimate children.

See biography by D. F. Jamison (Charleston, 1863), which was translated into French (1866) by order of Marshal Count Randon, minister of war; also S. Luce, *Histoire de B. du Guesclin* (Paris, 1876).

DUHAMEL, JEAN BAPTISTE (1624-1706), French physicist, was born in 1624 at Vire in Normandy. He studied at Caen and Paris; wrote at eighteen a tract on the *Spherics* of Theodosius of Tripolis; then became an Oratorian priest, and fulfilled with great devotion for ten years (1653-1663) the duties of *curé* at Neuilly-sur-Marne. He was appointed in 1656 almoner to the king, and in 1666 perpetual secretary to the newly founded Academy of Sciences. He died on the 6th of August 1706. He published among other works: *Astronomia physica* (1660) and *De meteoris et fossilibus* (1660), both in dialogue form; *De consensu veteris et novae philosophiae* (1663); *De corporum affectionibus* (1672); *De mente humana* (1673); *Regiae scientiarum Academiae historia, 1666-1696* (1698), new edition brought down to 1700 (1701); *Institutiones biblicae* (1698); followed by annotated editions of the Psalms (1701), of the Book of Wisdom, &c. (1703), and of the entire Bible in 1705.

DUHAMEL DU MONCEAU, HENRI LOUIS (1700-1782), French botanist and engineer, son of Alexandre Duhamel, lord of Denainvilliers, was born at Paris in 1700. Having been requested by the Academy of Sciences to investigate a disease which was destroying the saffron plant in Gâtinais, he discovered the cause in a parasitical fungus which attached itself to the roots, and this achievement gained him admission to the Academy in 1728. From then until his death he busied himself chiefly with making experiments in vegetable physiology. Having learned from Sir Hans Sloane that madder possesses the property of giving colour to the bones, he fed animals successively on food mixed and unmixed with madder; and he found that their bones in general exhibited concentric strata of red and white, whilst the softer parts showed in the meantime signs of having been progressively extended. From a number of experiments he was led to believe himself able to explain the growth of bones, and to demonstrate a parallel between the manner of their growth and that of trees. Along with the naturalist Buffon, he made numerous experiments on the growth and strength of wood, and experimented also on the growth of the mistletoe, on layer planting, on smut in corn, &c. He was probably the first, in 1736, to distinguish clearly between the alkalis, potash and soda. From the year 1740 he made meteorological observations, and kept records of the influence of the weather on agricultural production. For many years he was inspector-general of marine, and applied his scientific acquirements to the improvement of naval construction. He died at Paris on the 13th of August 1782.

His works are nearly ninety in number, and include many technical handbooks. The principal are:—*Traité des arbres et arbrustes qui se cultivent en France en pleine terre; Éléments de l'architecture navale; Traité général des pêches maritimes et fluviales; Éléments d'agriculture; La Physique des arbres; Des Semis et plantations des arbres et de leur culture; De l'exploitation des bois; Traité des arbres fruitiers.*

DÜHRING, EUGEN KARL (1833-1901), German philosopher and political economist, was born on the 12th of January 1833 at Berlin. After a legal education he practised at Berlin as a lawyer till 1859. A weakness of the eyes, ending in total blindness, occasioned his taking up the studies with which his name is now connected. In 1864 he became *docent* of the university of Berlin, but, in consequence of a quarrel with the professoriate, was deprived of his licence to teach in 1874. Among his works are *Kapital und Arbeit* (1865); *Der Wert des Lebens* (1865); *Natürliche Dialektik* (1865); *Kritische Geschichte der Philosophie* (1866); *Kritische Geschichte der allgemeinen Principien der Mechanik* (1872)—one of his most successful works; *Kursus der National- und Sozialökonomie* (1873); *Kursus der Philosophie* (1875), entitled in a later edition *Wirklichkeitsphilosophie; Logik und Wissenschaftstheorie* (1878); *Der Ersatz der Religion durch Volksgemeiner* (1883). He published his autobiography in 1882 under the title *Sache, Leben und Feinde*; the mention of "Feinde" (enemies) is characteristic. Dühring's philosophy claims to be emphatically the philosophy of reality. He is passionate in his denunciation of everything which, like mysticism, tries to veil reality. He is almost Lucretian in his anger against religion which would withdraw the secret of the universe from our direct gaze. His "substitute for religion" is a doctrine

in many points akin to Comte and Feuerbach, the former of whom he resembles in his sentimentalism. Dühring's opinions changed considerably after his first appearance as a writer. His earlier work, *Natürliche Dialektik*, in form and matter not 'the worst of his writings, is entirely in the spirit of the Critical Philosophy. Later, in his movement towards Positivism, he strongly repudiates Kant's separation of phenomenon from noumenon, and affirms that our intellect is capable of grasping the whole reality. This adequacy of thought to things is due to the fact that the universe contains but one reality, *i.e.* matter. It is to matter that we must look for the explanation both of conscious and of physical states. But matter is not, in his system, to be understood with the common meaning, but with a deeper sense as the substratum of all conscious and physical existence; and thus the laws of being are identified with the laws of thought. In this materialistic or quasi-materialistic system Dühring finds room for teleology; the end of Nature, he holds, is the production of a race of conscious beings. From his belief in teleology he is not deterred by the enigma of pain; he is a determined optimist. Pain exists to throw pleasure into conscious relief. In ethics Dühring follows Comte in making sympathy the foundation of morality. In political philosophy he teaches an ethical communism, and attacks the Darwinian principle of struggle for existence. It economics he is best known by his vindication of the American writer H. C. Carey, who attracts him both by his theory of value, which suggests an ultimate harmony of the interests of capitalist and labourer, and also by his doctrine of "national" political economy, which advocates protection on the ground that the morals and culture of a people are promoted by having its whole system of industry complete within its own borders. His patriotism is fervent, but narrow and exclusive. He idolized Frederick the Great, and denounced Jews, Greeks, and the cosmopolitan Goethe. Dühring's clear, incisive writing is disfigured by arrogance and ill-temper, failings which may be extenuated on the ground of his physical affliction. He died in 1901.

See H. Druskowitz, *Eugen Dühring* (Heidelberg, 1888); E. Döll, *Eugen Dühring* (Leipzig, 1892); F. Engels, *Eugen D.'s Umwälzung der Wissenschaft* (3rd ed., Stuttgart, 1894); H. Vaihinger, *Harmlose, Dühring und Lange* (1876). (H. Sr.)

DUIGENAN, PATRICK (1735-1816), Irish lawyer and politician, was the son of a Leitrim Roman Catholic farmer named O'Duibhgeannain. Through the tuition of the local Protestant clergyman, who was interested in the boy, he got a scholarship in 1756 at Trinity College, Dublin, and subsequently became a fellow. He was called to the Irish bar in 1767 and obtained a rich practice. He is remembered, however, mainly as a politician, on account of his opposition to Grattan, his support of the Union, and his violent antagonism to Catholic emancipation. He was elected member for Armagh in the first united parliament, and was a well-known character at Westminster till he died on the 11th of April 1816.

DUIKER (diver), or **DUIKERBOX**, the Dutch name of a small S. African antelope, scientifically known as *Cephalophus grimmii*; the popular name alluding to its habit of diving into and threading its way through thick bush. Scientifically the name is extended to include all the members of the African genus *Cephalophus*, which, together with the Indian chousingha, or four-horned antelope (*Tetraceros*), constitutes the subfamily *Cephalophinae*. Duikers are animals of small or medium size, usually frequenting thick forest. The horns, usually present in both sexes, are small and straight, situated far back on the forehead; and between them rises the crest-like tuft of hair from which the genus takes its scientific name. The common or true duiker (*C. grimmii*) is found in bush-country from the Cape to the Zambesi and Nyassaland, and ranges northward on the west coast to Angola. The banded duiker (*C. dorcas*) from West Africa is golden brown with black transverse bands on the back and loins. *C. rivicollis*, of West Africa, is the largest species, and approaches a donkey in size. (See ANTELOPE.) (R. L.)

DUILIUS (or **DUELLIUS**), **GAIUS**, Roman general during the first Carthaginian War and commander in the first Roman naval

victory. In 260 B.C., when consul in command of the land forces in Sicily, he was appointed to supersede his colleague Cn. Cornelius Scipio Asina, commander of the fleet, who had been captured in the harbour of Lipara. Recognizing that the only chance of victory lay in fighting under conditions as similar as possible to those of a land engagement, he invented a system of grappling irons (*corni*) and boarding bridges, and gained a brilliant victory over the Carthaginian fleet off Mylae on the north coast of Sicily. He was accorded a triumph and the distinction of being accompanied, when walking in the streets during the evening, by a torchbearer and a flute-player. A memorial column (*columna rostrata*), adorned with the beaks of the captured ships, was set up in honour of his victory. The inscription upon it (see LATIN LANGUAGE, section 3, "The Language as Recorded") has been preserved in a restored form in pseudo-archaic language, ascribed to the reign of Claudius.

See *Corpus Inscriptionum Latinarum*, i. No. 195; Polybius i. 22; Diod. Sic. xvii. 44; Frontinus, *Strat.* ii. 3; Florus ii. 2; Cicero, *De senectute*, 13; Silius Italicus vi. 667; and PUNIC WARS.

DUISBURG, a town of Germany in the kingdom of Prussia, 15 m. by rail N. from Düsseldorf, between the Rhine and the Ruhr, with which rivers it communicates by a canal. It is an important railway centre. Pop. (1885) 47,519; (1900) 92,729; (1905), including many outlying townships then recently incorporated, 191,551. It has six Roman Catholic and six Protestant churches, among the latter the fine Gothic Salvator-kirche, of the 15th century. It is well furnished with schools, which include a school of machinery. Of modern erections, the concert hall, the law courts and a memorial fountain to the cartographer Gerhard Kremer (Mercator) are worthy of mention. There are important foundries, rolling mills for copper, steel and brass plates, chemical works, saw-milling, shipbuilding, tobacco, cotton, sugar, soap and other manufactures.

Duisburg was known to the Romans as *Castrum Dentonius*, and mentioned under the Frankish kings as *Dispargum*. In the 12th century it attained the rank of an imperial free town, but on being mortgaged in 1290 to Cleves it lost its privileges. At the beginning of the 17th century it was transferred to Brandenburg, and during the Thirty Years' War was alternately occupied by the Spaniards and the Dutch. In 1655 the elector Frederick William of Brandenburg founded here a Protestant university, which flourished until 1802.

DUK-DUK, a secret society of New Britain or New Pomerania, Bismarck Archipelago, in the South Pacific. The society has religious and political as well as social objects. It represents a rough sort of law and order through its presiding spirit Duk-Duk, a mysterious figure dressed in leaves to its waist, with a helmet like a gigantic candle-extinguisher made of network. Upon this figure women and children are forbidden to look. Women, who are entitled in New Britain to their own earnings and work harder than men, are the special victims of Duk-Duk, who levies blackmail upon them if they are about during its visits. These are generally timed to coincide with the hours at which the women are out in the fields and therefore cannot help seeing the figure. Justice is executed, fines extorted, taboos, feasts, taxes and all tribal matters are arranged by the Duk-Duk members, who wear hideous masks or chalk their faces. In carrying out punishments they are allowed to burn houses and even kill people. Only males can belong to Duk-Duk, the entrance fees of which vary from 50 to 100 fathoms of *dewarra* (small cowrie shells strung on strips of cane). The society has its secret signs and ritual, and festivals at which the presence of a stranger would mean his death. Duk-Duk only appears with the full moon. The society is now much discredited and is fast dying out.

See "Duk-Duk and other Customs or Forms of Expression of the Melanesian's Intellectual Life," by Graf von Pfeil (*Journ. of Anthropol. Inst.* vol. 27, p. 181).

DUKE (corresponding to Fr. *duc*, Ital. *duca*, Ger. *Herzog*), the title of one of the highest orders of the European nobility, and of some minor sovereign princes. The word "duke," which is derived from the Lat. *dux*, a leader, or general, through the

Fr. *duc* (O. Fr. *ducc*, *ducs*, *dux*), originally signified a leader, and more especially a military chief, and in this latter sense was the equivalent of the A.S. *heretaga* (*here*, an army, and *taem*, from *togen*, to draw; Ger. *siehen*, *soh*; Goth. *siukan*; Lat. *ducere*) and the old Ger. *herisog*. In this general sense the word survived in English literature until the 17th century, but is now obsolete.

The origin of modern dukes is twofold. The *dux* first appears in the Roman empire under the emperor Hadrian, and by the time of the Gordians has already a recognized place in the official hierarchy. He was the general appointed to the command of a particular expedition and his functions were purely military. In the 4th century, after the separation of the civil and military administrations, there was a duke in command of the troops quartered in each of the frontier provinces of the empire, e.g. the *dux Britanniarum*. The number of dukes continually increased, and in the 6th and 7th centuries there were *duces* at Rome, Naples, Rimini, Venice and Perugia. Gradually, too, they became charged with civil as well as military functions, and even exercised considerable authority in ecclesiastical administration. Under the Byzantine emperors they were the representatives in all causes of the central power. The Roman title of duke was less dignified than that of count (*comes*, companion) which implied an honourable personal relation to the emperor (see COUNT). Both titles were borrowed by the Merovingian kings for the administrative machinery of the Frank empire, and under them the functions of the duke remained substantially unaltered. He was a great civil and military official, charged to watch, in the interests of the crown, over groups of several *comitatus*, or countships, especially in the border provinces. The sphere of the dukes was never rigidly fixed, and their commission was sometimes permanent, sometimes temporary. Under the Carolingians the functions of the dukes remained substantially the same; but with the decay of the royal power in the 10th century, both dukes and counts gained in local authority; the number of dukes became for the time fixed, and finally title and office were made hereditary, the relation to the crown being reduced to that of more or less shadowy vassalage. (See FEUDALISM.)

Side by side with these purely official dukedoms, however, there had continued to exist, or had sprung up, either independently or in more or less of subjection to the Frank rulers, national dukedoms, such as those of the Alemanni, the Aquitanians, and, later, of the Bavarians and Thuringians. These were developed from the early Teutonic custom by which the *herisog* was elected by the nation as leader for a particular campaign, as in the case of the *heretagus* who had led the first Saxon invaders into Britain. Tacitus says of the ancient Germans *reges ex nobilitate, duces ex virtute sumunt*; i.e. they elected their dukes for their warlike prowess only, and as purely military chiefs, whereas their kings were chosen from a royal family of divine descent. Sometimes the dukes so chosen succeeded in making their power permanent without taking the style of king. To this national category belong, besides the great German dukedoms, the dukes of Normandy, and the Lombard dukes of Spoleto and Benevento, who traced their origin, not to an administrative office, but to the leadership of Teutonic war bands. With the development of the feudal system the distinction between the official and the national dukedoms was more and more obliterated. By the 13th and 14th centuries the title had become purely territorial, and implied no necessary overlordship over counts and other nobles, who existed side by side with the dukes as tenants-in-chief of the crown. From this time the significance of the ducal title varies widely in different countries. Whenever the crown got the better of the feudal spirit of independence, as in France or Naples, it sank from being a sovereign title to a mere social distinction, implying no political power, and not necessarily any territorial influence. In northern Italy and in Germany, on the other hand, where the crown had proved too weak to combat the forces of disruption, it came ultimately to imply independent sovereignty.

The abolition of the Holy Empire in 1806 removed even the shadow of vassalage from the German reigning dukes, who retain

their sovereign status under the new empire. Only one, however, the grand duke of Luxemburg, is now both sovereign and independent. Besides the sovereign dukes in Germany there are certain "mediatized" ducal houses, e.g. that of Ratibor, which share with the dispossessed families of the Italian sovereign duchies certain royal privileges, notably that of equality of blood (*Ebenbürtigkeit*). In Italy, where titles of nobility give no precedence at court, that of duke (*duca*) has lost nearly all even of its social significance owing to lavish creations by the popes and minor sovereigns, and to the fact that the title often passes by purchase with a particular estate. Political significance it has none. Some great Italian nobles are dukes, notably the heads of the great Roman ducal families, but not all Italian dukes are great nobles.

In France the title duke at one time implied vast territorial power, as with the dukes of Burgundy, Normandy, Aquitaine and Brittany, who asserted a practical independence against the crown, though it was not till the 12th century that the title duke was definitely regarded as superior to others. At first (in the 10th and 11th centuries) it had no defined significance, and even a baron of the higher nobility called himself in charters duke, count or even marquis, indifferently. In any case the strengthening of the royal power gradually sapped the significance of the title, until on the eve of the Revolution it implied no more than high rank and probably territorial wealth.

There were, under the *ancien régime*, three classes of dukes in France: (1) dukes who were peers (see PEERAGE) and had a seat in the parlement of Paris; (2) hereditary dukes who were not peers; (3) "brevet" dukes, created for life only. The French duke ranks in Spain with the "grandee" (*g.ª*), and vice versa. In republican France the already existing titles are officially recognized, but they are now no more than the badges of distinguished ancestry. Besides the descendants of the feudal aristocracy, there are in France certain ducal families dating from Napoleon I.'s creation of 1806 (e.g. ducs d'Albufera, de Montebello, de Feltre), from Louis Philippe (duc d'Isly, and duc d'Audiffert-Pasquier), and from Napoleon III. (Malakoff, Magenta, Morny).

In England the title of duke was unknown till the 14th century, though in Saxon times the title ealdorman, afterwards exchanged for "earl," was sometimes rendered in Latin as *dux*,¹ and the English kings till John's time styled themselves dukes of Normandy, and dukes of Aquitaine even later. In 1337 King Edward III. erected the county of Cornwall into a duchy for his son Edward the Black Prince, who was thus the first English duke. The second was Henry, earl of Lancaster, Derby, Lincoln and Leicester, who was created duke of Lancaster in 1351. In Scotland the title of duke was first bestowed in 1398 by Robert III. on his eldest son David, who was made duke of Rothesay, and on his brother, who became duke of Albany.

British dukes rank next to princes and princesses of the blood royal, the two archbishops of Canterbury and York, the lord Chancellor, &c., but beyond this precedence they have no special privileges which are not shared by peers of lower rank (see PEERAGE). Though their full style as proclaimed by the herald is "most high, potent and noble prince," and they are included in the *Almanach de Gotha*, they are not recognized as the equals in blood of the crowned or mediatized dukes of the continent, and the daughter of an English duke marrying a foreign royal prince can only take his title by courtesy, or where, under the "house-laws" of certain families, a family council sanctions the match. The eldest son of an English duke takes as a rule by courtesy the second title of his father, and ranks, with or without the title, as a marquess. The other sons and daughters bear the titles "Lord" and "Lady" before their Christian names, also by courtesy. A duke in the British peerage, if not royal, is addressed as "Your Grace" and is styled "the Most Noble." (See ARCHDUKE, GRAND DUKE, and, for the ducal coronet, CROWN AND CORONET.) (W. A. P.)

¹ So *Ego Haroldus dux*, *Ego Tostinus dux*, in a charter of Edward the Confessor (1060), *Hist. MSS. Comm.* 12th rep. app. pt. ix. p. 581.

DUKE OF EXETER'S DAUGHTER, a nickname applied to a 15th-century instrument of torture resembling the rack (*g.ª*). Blackstone says (*Commentaries*, ii. sec. 326): "The trial by rack is utterly unknown to the law of England, though once when the dukes of Exeter and Suffolk, and other ministers of Henry VI., had laid a design to introduce the civil (*i. e.* Roman) law into the kingdom as the rule of government, for a beginning thereof they erected a rack for torture, which was called in derision the duke of Exeter's daughter, and still remains in the Tower of London, where it was used as an engine of state, not of law, more than once in Queen Elizabeth's reign. But when, upon the assassination of Villiers, duke of Buckingham, by Felton, it was proposed in the privy council to put the assassin to the rack, in order to discover his accomplices, the judges being consulted, declared unanimously that no such proceeding was allowable by the laws of England."

DUKER, CARL ANDREAS (1670-1752), German classical scholar and jurist, was born at Unna in Westphalia. He studied at the university of Franeker under Jacob Perizonius. In 1700 he was appointed teacher of history and eloquence at the Herborn gymnasium, in 1704 vice-principal of the school at the Hague, and in 1716 he succeeded (with Drakenborch as colleague) to the professorship formerly held by Peter Burmann at Utrecht. After eighteen years' tenure he resigned his post, and lived in retirement at Ysselstein and Vianen. His health finally broke down under excessive study, and he died, almost blind, at the house of a relative in Meiderich near Duisburg, on the 5th of November 1752. His chief classical works were editions of Florus (1722) and Thucydides (1731, considered his best). He brought out the 2nd edition of Perizonius's *Origines Babylonicae et Aegyptiacae* (1736) and his commentary on Pomponius Mela (1736-1737). Duker was also an authority on ancient law, and published *Opuscula varia de latinitate veterum jurisconsultorum* (1711), and a revision of the *Leges Atticae* of S. Petit (1741).

See C. Saxe, *Onomasticon literarium*, vi. 267; articles in *Allgemeine deutsche Biographie* and in Ersch and Gruber's *Allgemeine Encyclopädie*.

DUKERIES, THE, a name given to a district in the N.W. of Nottinghamshire, England; included within the ancient Sherwood Forest (*g.ª*). The name is taken from the existence of several adjacent demesnes of noblemen, and the character of the Forest is to some extent preserved here. On the north is the Sheffield-Retford branch of the Great Central railway, serving the town of Worksop, connecting at Retford with the Great Northern railway, while on the south the Great Central railway serves the small market town of Ollerton, and connects with the Great Northern at Dukeries Junction. The following demesnes are comprised in the district. Worksop Manor formerly belonged to the dukes of Norfolk. Welbeck Abbey is the seat of the dukes of Portland, to whom it came from the Cavendish family (dukes of Newcastle); the mansion is mainly classic in style, dating from the early 17th century, but with many subsequent additions; the fifth duke of Portland (d. 1879) built the curious series of subterranean corridors and chambers beneath the grounds. Clumber House, the seat of the dukes of Newcastle, is beautifully placed above a lake in a fine park. Thoresby House is the seat of the earls Manvers, to whom it came on the extinction of the dukedom of Kingston; part of this demesne is a splendid tract of wild woodland.

DUKES, LEOPOLD (1810-1891), Hungarian critic of Jewish literature. He spent about twenty years in England, and from his researches in the Bodleian library and the British Museum (which contain two of the most valuable Hebrew libraries in the world) Dukes was able to complete the work of Zunz (*g.ª*). The most popular work of Dukes was his *Rabbinische Blumenlese* (1844), in which he collected the rabbinic proverbs and illustrated them from the gnomic literatures of other peoples. Dukes made many contributions to philology, but his best work was connected with the medieval Hebrew poetry, especially Ibn Gabirol. (I. A.)

DUKINFIELD, a municipal borough of Cheshire, England, within the parliamentary borough of Stalybridge, 6 m. E. of

Manchester. Pop. (1901) 18,929. It lies in the densely populated district in the north-east of the county, between Stalybridge and Ashton-under-Lyne, and is served by the London & North Western and Great Central railways. There are extensive collieries, and the other industries include cotton manufactures, calico-printing, hat-making, iron-founding, engineering and the manufacture of firebricks and tiles. A portion remains of the old timbered Dukinfield Hall, in the chapel of which Samuel Eaton (d. 1665) taught the first congregational church in the north of England. The chapel, much enlarged, is still used by this denomination. The borough, incorporated in 1899, is under a mayor, 6 aldermen and 18 councillors. Area, 1405 acres.

DULCIGNO (Servian, *Ulcin*, Turk. *Olgun*), a seaport of Montenegro, on the Adriatic Sea, 8 m. W. of the Albanian frontier. Pop. (1900) about 5000. Shut in by hills and forests, and built partly on a promontory overlooking its bay, partly along the shore, Dulcigno is the prettiest of Montenegrin towns. Its narrow crooked lanes, however, with its bazaars, mosques, minarets and veiled women, give to its picturesqueness a decidedly Turkish air. The old quarter, on the promontory, is walled, and has a mediæval castle, once of great strength. Turks form the bulk of the inhabitants, although their numbers decreased steadily after 1880, when the population numbered about 8000. Albanians and Italians are fairly numerous. Dulcigno has a Roman Catholic cathedral and an ancient Latin church. The Austrian Lloyd steamers call at intervals, and some shipbuilding and fishing are carried on; but the harbour lacks shelter and is liable to deposits of silt.

To the Romans, who captured it in 167 B.C., Dulcigno was known as *Ulcinium* or *Olcinium*; in the middle ages it was a noted haunt of pirates; in the 17th century it was the residence of Sabbatai Zebi (d. 1676), a Jew who declared himself to be the Messiah but afterwards embraced Islam. In 1718 Dulcigno was the scene of a great Venetian defeat. It belonged to the Turks until 1880, when its cession, according to the terms of the treaty of Berlin (1878), was enforced by the "Dulcigno demonstration," in which the fleets of Great Britain, France, Germany, Austria and Russia took part.

DULCIMER (Fr. *lympanon*; Ger. *Hackbrett*, *Cymbal*; Ital. *cembalo*, *timpanon* or *salterio tedesco*), the prototype of the pianoforte, an instrument consisting of a horizontal sound-chest over which are stretched a varying number of wire strings set in vibration by strokes of little sticks or hammers. The dulcimer differed from the psalterium or psaltery chiefly in the manner of playing, the latter having the strings plucked by means of fingers or plectrum. The shape of the dulcimer is a trapeze or truncated triangle, having the bass strings stretched parallel with the base, which measures from 3 to 4 ft.; the strings decrease gradually in length; the shortest measuring from about 18 to 24 in. at the truncated apex. The sound-board has one or two rose sound-holes; the strings are attached on one side to hitch pins and at the other to the larger tuning pins firmly fixed in the wrest plank. The strings of fine brass or iron wire are in groups of two to five unisons to each note; the vibrating lengths of the strings are determined by means of two bridges. The dulcimer is placed upon a table in front of the performer, who strikes the strings with a little hammer mounted on a metal rod and covered on one side with hard and on the other with soft leather for forte and piano effects. The compass, now chromatic throughout, varies according to the size of the instrument; the large cymbalom of the Hungarian gipsies has a range of four chromatic octaves, 

The origin of the dulcimer is remote, and must be sought in the East. In the bas-reliefs from Kuyunjik, now in the British Museum, are to be seen musicians playing on dulcimers of ten strings with long sticks curved at the ends, and damping the strings with their hands. This is the *psantrir* of the days of Nebuchadrezzar, translated "psaltery" in Dan. iii. 5, &c., and rendered "psalterion" in the Septuagint, a confusion which

has given rise to many misconceptions.¹ In the Septuagint no less than four different instruments are rendered *psalterion* (from Gr. ψάλλω, pluck, pull), i.e. *ugab*, *mebel*, *psantrir* and *toph*, two stringed, one wind and one percussion. The use of the word in Greek for a musical instrument is not recorded before the 4th century B.C. The modern *santir* of the Persians, almost identical with the German hackbrett, has a compass from

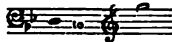

according to Fétiis.² The Persians place

its origin in the highest antiquity. Carl Engel³ gives an illustration said to be taken from a very old painting.⁴

The dulcimer was extensively used during the middle ages in England, France, Italy, Germany, Holland and Spain, and although it had a distinctive name in each country, it was everywhere regarded as a kind of psalterium. The importance of the method of setting the strings in vibration by means of hammers, and its bearing on the acoustics of the instrument, were recognized only when the invention of the pianoforte had become a matter of history. It was then perceived that the psalterium in which the strings were plucked, and the dulcimer in which they were struck, when provided with keyboards, gave rise to two distinct families of instruments, differing essentially in tone quality, in technique and in capabilities: the evolution of the psalterium stopped at the harpsichord, that of the dulcimer gave us the pianoforte. The dulcimer is described and illustrated by Mersenne,⁵ who calls it *psalterion*; it has thirteen courses of pairs of unisons or octaves; the first strings were of brass wire, the others of steel. The curved stick was allowed to fall gently on to the strings and to rebound many times, which, Mersenne remarks, produces an effect similar to the trembling or tremolo of other instruments. Praetorius⁶ figures a hackbrett having a body in the shape of a truncated triangle, with a bridge placed between two rose sound-holes, and played by means of two sticks. Another kind of hackbrett⁷ (a psaltery), which was played with the fingers, was known to Praetorius. The pantaleon, a double dulcimer, named after the inventor, Pantaleon Hebenstreit of Eisleben, a violinist, had two sound-boards, 185 strings, one scale of overspun catgut, the other of wire. Hebenstreit travelled to Paris with his monster dulcimer in 1705 and played before Louis XIV., who baptized it *Pantaleon*. Quantz⁸ and Quirin of Blankenburg⁹ both gave descriptions of the instrument. (K. S.)

DÜLKEN, a town of Germany, in the Prussian Rhine Province, 11 m. by rail S.W. from Crefeld. Pop. 10,000. It has a (Roman Catholic) Gothic parish church. There are manufactures of linen, cotton, silk and velvet, &c., ironworks and foundries.

DULONG, PIERRE LOUIS (1785-1838), French chemist and physicist, was born at Rouen on the 12th (or 13th) of February 1785. He began as a doctor in one of the poorest districts of Paris, but soon abandoned medicine for scientific research. After acting as assistant to Berthollet, he became successively professor of chemistry at the faculty of sciences and the normal and veterinary schools at Alfort, and then (1820) professor of physics at the École Polytechnique, of which he was appointed director in 1830. He died in Paris on the 18th (or 19th) of July 1838. His earliest work was chemical in character. In 1811 he discovered chloride of nitrogen; during his experiments serious explosions occurred twice, and he lost one eye, besides sustaining severe injuries to his hand. He also investigated the oxygen compounds of phosphorus and nitrogen, and was

¹ The names of the musical instruments in those verses of the Book of Daniel have formed the basis of a controversy as to the authenticity of the book.

² *Histoire de la musique* (Paris, 1869), vol. ii. p. 131.

³ *Musical of the most Ancient Nations* (London, 1864), pp. 42-3.

⁴ *Hommaire de Hell, Voyage en Perse*, p. lxxi.

⁵ *L'Harmonie universelle* (Paris, 1636), livre iii. p. 174.

⁶ *Syntagma musicum* (Wolfenbüttel, 1618), pl. 18 (3).

⁷ Pl. 36 (1).

⁸ "Herrn Joh. Joachim Quantzens Lebenslauf von ihm selbst entworfen," in Fr. W. Marpurgs *Hists. kritische Beyträge*, Bd. i. p. 207 (1754-1755).

⁹ *Elementa musica*, chap. xxvii.

one of the first to hold the hydrogen theory of acids. In 1815, in conjunction with Alexis Thérèse Petit (1791-1820), the professor of physics at the École Polytechnique, he made careful comparisons between the mercury and the air thermometer. The first published research (1816) dealt with the dilatation of solids, liquids and gases and with the exact measurement of temperature, and it was followed by another in 1818 on the measurement of temperature and the communication of heat, which was crowned by the French Academy. In a third, "On some important points in the theory of heat" (1819), they stated that the specific heats of thirteen solid elements which they had investigated were nearly proportional to their atomic weights—a fact otherwise expressed in the "law of Dulong and Petit" that the atoms of simple substances have equal capacities for heat. Subsequent papers by Dulong were concerned with "New determinations of the proportions of water and the density of certain elastic fluids" (1820, with Berzelius); the property possessed by certain metals of facilitating the combination of gases (1823 with Thénard); the refracting powers of gases (1826); and the specific heats of gases (1829). In 1830 he published a research, undertaken with Arago for the academy of sciences, on the elastic force of steam at high temperatures. For the purposes of this determination he set up a continuous column of mercury, constructed with 13 sections of glass tube each 2 metres long and 5 mm. in diameter, in the tower of the old church of St Genevieve in the Collège Henri IV. The apparatus was first used to investigate the variation in the volume of air with pressure, and the conclusion was that up to twenty-seven atmospheres, the highest pressure attained in the experiments, Boyle's law holds good. In regard to steam, the old tower was so shaky that it was considered unwise to risk the effects of an explosion, and therefore the mercury column was removed bodily to a court in the observatory. The original intention was to push the experiments to a pressure equivalent to thirty atmospheres, but owing to the signs of failure exhibited by the boiler the limit actually reached was twenty-four atmospheres, at which pressure the thermometers indicated a temperature of about 224°C. In his last paper, published posthumously in 1838, Dulong gave an account of experiments made to determine the heat developed in the combination of various simple and compound bodies, together with a description of the calorimeter he employed.

DULSE (Lr. and Gael. *duileasg*), in botany, *Rhodomyenia palmata*, one of the red seaweeds, consisting of flat solitary or tufted purplish-red fronds, fan-shaped in general outline and divided into numerous segments, which are often again and again divided in a forked manner. It varies very much in size and degree of branching, ranging from 5 or 6 to 12 or more inches long. It grows on rocks, shell-fish or larger seaweeds, and is used by the poor in Scotland and Ireland as a relish with their food. It is commonly dried and eaten raw, the flavour being brought out by long chewing. In the Mediterranean it is used cooked in ragouts and made dishes.

See W. H. Harvey, *Phycologica Britannica*, vol. ii. plates 217, 218.

DULUTH, a city and the county-seat of St. Louis county, Minnesota, U.S.A., at the W. end of Lake Superior, at the mouth of the St. Louis river, about 150 m. N.E. of Minneapolis and St. Paul. Pop. (1880) 3483; (1890) 33,115; (1900) 52,969, of whom 20,983 were foreign-born and 357 were negroes; (1910 census) 78,466. Of the 20,983 foreign-born in 1900, 5099 were English-Canadians, 5047 Swedes, 2655 Norwegians, 1685 Germans, and 1285 French-Canadians. Duluth is served by the Duluth and Iron Range, the Duluth, Missabe & Northern, the Duluth, South Shore & Atlantic, the Chicago & North-Western (the North-Western line), the Great Northern, and the Northern Pacific railways. Situated attractively on the side and along the base of a high bluff rising 600 ft. above the lake level, Duluth lies at the W. end of Superior Bay (here called Duluth Harbour), directly opposite the city of Superior, Wisconsin. A narrow strip of land known as Minnesota Point, 7 m. in length and extending toward Wisconsin Point, which projects from the Wisconsin shore, separates the bay from the lake and forms

with St. Louis Bay one of the finest natural harbours in the world. The natural entrance to the harbour is the narrow channel between the two points, but there is also a ship-canal across Minnesota Point, spanned by a curious aerial bridge 400 ft. long and 186 ft. above the water.

The unusually favourable position for lake transportation, and the extensive tributary region in the N.W., with ample rail connexions, make Duluth-Superior one of the greatest commercial ports in the country. The two cities constitute the largest coal-distributing centre in the N.W., and have some of the largest coal-docks in the world. Upwards of twenty grain elevators, with a net capacity of nearly 35,000,000 bushels, which receive enormous quantities of grain from the Red River Valley, Manitoba, and the Dakotas, either for home manufacture or for transshipment to the East, are among the noteworthy sights of the place; and extensive ore-docks are required for handling the enormous and steadily increasing shipments of iron ore from the rich Vermilion and Mesabi iron ranges first opened about 1890. In 1907 more than 29,000,000 tons of iron ore were shipped from this port. Duluth is also an important hay market. There are flour and lumber mills, foundries and machine shops, wooden ware, cooperage, sash, door and blind, lath and shingle factories, and shipyards. In 1909 great mills of the Minnesota Steel Co. were begun here. In 1905 the factory product of Duluth was valued at \$10,139,009, an increase of 29.8% over that of 1900. The St. Louis river furnishes one of the finest water-powers in the United States.

The commanding heights upon which the principal residential section of the city is built render it at once attractive in appearance and healthful; there is a fine system of parks and boulevards, the chief of the former being Lester, Fairmount, Portland, Cascade, Lincoln and Chester. The popular Boulevard drive at the back of Duluth commands excellent views of city and lake. Among the principal buildings are the court house, the Masonic temple, chamber of commerce, board of trade, Lyceum theatre, Federal, Providence, Lonsdale, Torrey, Alworth, Sellwood and Wolvin buildings, St. Mary's hospital, St. Luke's hospital and Spalding Hotel. There is a public (Carnegie) library with 50,000 volumes in 1908. The building of the central high school (classical), one of the finest in the United States, erected at a cost of about \$500,000, has a square clock tower 230 ft. high, and an auditorium seating 2000. The city also has a technical high school, and in addition to the regular high school courses there are departments of business, manual training and domestic science. At Duluth also is a state normal school, erected in 1902. The federal government maintains here a life-saving station on Minnesota Point, and an extensive fish hatchery.

The first Europeans to visit the site of Duluth were probably French *coureurs-des-bois*, possibly the adventurous Radisson and Groseilliers. The first visitor certainly known to have been here was Daniel Greysolon, Sieur Du Lhut (d. 1709), a French trader and explorer, who about 1678 skirted Lake Superior and built a stockaded trading-post at the mouth of Pigeon river on the N. shore. From him the place received its name. A trading-post was established near the present city, at Fond du Lac, about 1752, and this eventually became a dépôt of Astor's American Fur Company. There was no permanent settlement at Duluth proper, however, until 1853, and in 1860 there were only 80 inhabitants. Incorporated in 1870, in which year railway connexion with the South was established, its growth was slow for some years, the increase for the decade 1870-1880 being very slight (from 3131 to 3483); but the extension of railways into the north-western wheat region, the opening up of Lake Superior to commerce, and finally the development of the Vermilion and Mesabi iron ranges, brought on a period of almost unparalleled growth, marked by the remarkable increase in population of more than 850% between 1880 and 1890; between 1890 and 1900 the increase was 60%.

See J. R. Carey, *History of Duluth and Northern Minnesota* (Duluth, 1898); Leggett and Chipman, *Duluth and its Environs* (Duluth, 1895); and J. D. Ensign, *History of St. Louis County* (Duluth, 1900).

DULWICH, a district in the metropolitan borough of Camberwell, London, England. The manor, which had belonged to the

Cluniac monks of Bermondsey, passed through various hands to Edward Alleyn (q.v.) in 1606. His foundation of the College of God's Gift, commonly called Dulwich College, was opened with great state on the 13th of September 1619, in the presence of Lord Chancellor Bacon, Lord Arundell, Inigo Jones and other distinguished men. According to the letters patent the almspeople and scholars were to be chosen in equal proportions from the parishes of St Giles (Camberwell), St Botolph without Bishopsgate, and St Saviour's (Southwark), and "that part of the parish of St Giles without Cripplegate which is in the county of Middlesex." By a series of statutes signed in 1626, a few days before his death, Alleyn ordained that his school should be for the instruction of 80 boys consisting of three distinct classes:—(1) the twelve poor scholars; (2) children of inhabitants of Dulwich, who were to be taught freely; and (3) "towne or foreign schollers," who were "to pay such allowance as the master and wardens shall appoint." The almspeople consisted of six "poor brethren" and six "poor sisters," and the teaching and governing staff of a master and a warden, who were always to be of the founder's surname, and four fellows, all "graduates and divines," among whom were apportioned the ministerial work of the chapel, the instruction of the boys; and the supervision of the almspeople. That it was the founder's intention to establish a great public school upon the model of Westminster and St Paul's, with provision for university training, is shown by the statutes; but for more than two centuries the educational benefits of God's Gift College were restricted to the twelve poor scholars. Successive actions at law resulted in the ruling that it was not within the competence of the founder to divert any portion of the revenues of his foundation to the use of others than the members thereof, as specified in the letters patent. In 1842, however, some effort was made towards the realization of Alleyn's schemes, and in 1858 the foundation was entirely reconstituted by act of parliament. It comprises two schools, the "Upper" and the "Lower," now called respectively Dulwich College and Alleyn's school. In the Upper school, now one of the important English "public schools," there are classical, modern, science and engineering sides. The Lower school is devoted to middle-class education. The buildings of the Upper school, by Charles Barry, contain a fine hall. The college possesses a splendid picture gallery, bequeathed by Sir P. F. Bourgeois, R.A., in 1811, with a separate endowment. The pictures include some exquisite Murillos and choice specimens of the Dutch school. The surplus income of the gallery fund is devoted to instruction in drawing and design in the two schools.

See W. H. Blanch, *Dulwich College and Edward Alleyn* (London, 1877); R. Hovenden, *The History of Dulwich College, with a short biography of its founder* (London, 1873).

DUMAGUETE, the capital town of the province of Negros Oriental, island of Negros, Philippine Islands, on Tañón Strait. Pop. (1903) 14,894. The town of Sibulan (pop. in 1903, 8413) was annexed to Dumaguete in 1903, after the census had been taken. Dumaguete lies in the midst of a fertile agricultural district. The inhabitants are chiefly natives, but the shops are kept by Chinese merchants. The public buildings, which include an interesting watch-tower and belfry, are large, substantial and well cared for.

DUMANJUG, a town of the province of Cebú, island of Cebú, Philippine Islands, on the W. coast, at the mouth of the Dumanjug river, about 40 m. S.W. of the town of Cebú. Pop. (1903) 22,203. In 1903, after the census had been taken, the adjacent town of Ronda (pop. 9662) was annexed to Dumanjug. Dumanjug is in communication with the town of Sibonga, on the opposite shore of one of the few passes through the mountains of the interior. Indian corn and sugar-cane are grown successfully in the neighbouring country, and the town has an important coast trade.

DU MARSAIS, CÉSAR CHESNEAU, SIEUR (1676–1756), French philologist, was born at Marseilles on the 17th of July 1766. He was educated in his native town by the Fathers of the Oratory, into whose congregation he entered; but he left it at the age of twenty-five and went to Paris, where he married

and was admitted an advocate (1703). He was tutor to the sons successively of the président de Maisons, of John Law, the projector, and of the marquis de Bauffremont. He then opened a boarding school in the faubourg St Victor, which scarcely afforded him the means of subsistence. He made contributions of great value on philological and philosophical subjects to the *Encyclopédie*, and after vain attempts to secure a competence from the court he was insured against want by the generosity of a private patron. He died in Paris on the 11th of June 1756. The researches of Du Marsais are distinguished by considerable individuality. He held sensible views on education and elaborated a system of teaching Latin, which, although open to grave criticism, was a useful protest against current methods of teaching. His best works are his *Principes de grammaire* and his *Des tropes, ou des differents sens dans lesquels on peut prendre un mot* (1730).

An edition of his works (7 vols.) was collected by Duchosal and Millon, and was published with an eulogy on Du Marsais by D'Alembert at Paris in 1797.

DUMAS, ALEXANDRE [ALEXANDRE DAVY DE LA PAILLETERIE] (1802–1870), French novelist and dramatist, was born at Villers-Cotterets (Aisne) on the 24th of July 1802. His father, the French general, Thomas Alexandre Dumas (1762–1806)—also known as Alexandre Davy de la Pailleterie—was born in Saint Domingo, the natural son of Antoine Alexandre Davy, marquis de la Pailleterie, by a negress, Marie Cessette Dumas, who died in 1772. In 1780 he accompanied the marquis to France, and there the father made a mésalliance which drove the son into enlisting in a dragoon regiment. Thomas Alexandre Dumas was still a private at the outbreak of the revolution, but he rose rapidly and became general of division in 1793. He was general-in-chief of the army of the western Pyrenees, and was transferred later to commands in the Alps and in La Vendée. Among his many exploits was the defeat of the Austrians at the bridge of Clausen on the 22nd of April 1797, where he commanded Joubert's cavalry. He lost Napoleon's favour by plain speaking in the Egyptian campaign, and presently returned to France to spend the rest of his days in retirement at Villers Cotterets, where he had married in 1792 Marie Elisabeth Labouret.

The novelist, who was the offspring of this union, was not four years old when General Dumas died, leaving his family with no further resource than 30 acres of land. Mme Dumas tried to obtain help from Napoleon, but in vain, and lived with her parents in narrow circumstances. Alexandre received the rudiments of education from a priest, and entered the office of a local solicitor. His chief friend was Adolphe de Leuven, the son of an exiled Swedish nobleman implicated in the assassination of Gustavus III. of Sweden, and the two collaborated in various vaudevilles and other pieces which never saw the footlights. Leuven returned to Paris, and Dumas was sent to the office of a solicitor at Crépy. When in 1823 Dumas contrived to visit his friend in Paris, he was received to his great delight by Talma. He returned home only to break with his employer, and to arrange to seek his fortune in Paris, where he sought help without success from his father's old friends. An introduction to the deputy of his department, General Foy, procured for him; however, a place as clerk in the service of the duke of Orleans at a salary of 1200 francs. He set to work to rectify his lack of education and to collaborate with Leuven in the production of vaudevilles and melodramas. Madame Dumas presently joined her son in Paris, where she died in 1838.

Soon after his arrival in Paris Dumas had entered on a liaison with a dressmaker, Marie Catherine Labay, and their son, the famous Alexandre Dumas fils (see below), was born in 1824. Dumas acknowledged his son in 1831, and obtained the custody of him after a lawsuit with the mother.

The first piece by Dumas and Leuven to see the footlights was *La Chasse à l'amour* (Ambigu-Comique, 22nd of Sept. 1825), and in this they had help from other writers. Dumas had a share in another vaudeville, *La Noce et l'enterrement* (Porte Saint-Martin, 21st of Nov. 1826). It was under the influence of the Shakespeare plays produced in Paris by Charles Kemble, Harriet

Smithson (afterwards Mme Berlioz) and an English company that the romantic drama of *Christine* was written. The subject was suggested by a bas-relief of the murder of Monaldeschi exhibited at the Salon of 1827. The piece was accepted by Baron Taylor and the members of the Comédie Française with the stipulation that it should be subject to revision by another dramatist because of its innovating tendencies. But the production of the piece was deferred. Meanwhile Dumas had met with the story of the ill-fated Saint-Mégrin and the duchess of Guise in Anquetil's history, and had written, in prose, *Henri III. et sa cour*, which was immediately accepted by the Comédie Française and produced on the 11th of February 1829. It was the first great triumph of the romantic drama. The brilliant stagecraft of the piece and its admirable historical setting delighted an audience accustomed to the decadent classical tragedy, and brought him the friendship of Hugo¹ and Vigny. His literary efforts had met with marked disapproval from his official superiors, and he had been compelled to resign his clerkship before the production of *Henri III.* The duke of Orleans had, however, been present at the performance, and appointed him assistant-librarian at the Palais Royal. *Christine* was now recast as a romantic trilogy in verse in five acts with a prologue and epilogue, with the sub-title of *Stockholm, Fontainebleau, Rome*, and was successfully produced by Harel at the Odéon in March 1830.

The revolution of 1830 temporarily diverted Dumas from letters. The account of his exploits should be read in his *Mémoires*, where, though the incidents are true in the main, they lose nothing in the telling. During the fighting in Paris he attracted the attention of La Fayette, who sent him to Soissons to secure powder. With the help of some inhabitants he compelled the governor to hand over the magazine, and on his return to Paris was sent by La Fayette on a mission to raise a national guard in La Vendée. The advice he gave to Louis-Philippe on this subject was ill-received, and after giving offence by further indiscretions he finally alienated himself from the Orleans government by being implicated in the disturbances which attended the funeral of General Lamarque in June 1832, and he received a hint that his absence from France was desirable. A tour in Switzerland undertaken on this account furnished material for the first of a long series of amusing books of travel. Dumas remained, however, on friendly and even affectionate terms with the young duke of Orleans until his death in 1842.

Meanwhile he had produced *Napoléon Bonaparte* (Odéon, 10th of Jan. 1831), his unwillingness to make a hero of the man who had slighted his father having been overcome by Harel, who put him under lock and key until the piece was finished. His next play, *Antony*, had a real importance in the history of the romantic theatre. It was put in rehearsal by Mlle Mars, but so unsatisfactorily that Dumas transferred it to Bocage and Mme Dorval, who played it magnificently at the Porte Saint-Martin theatre on the 3rd of May 1831. The Byronic hero Antony was a portrait of himself in his relations with Mme Mélanie Waldor, the wife of an officer, and daughter of the journalist M. G. T. de Villenave, except of course in the extravagantly melodramatic *dénouement*, when Antony, to save his mistress's honour, kills her and exclaims, "Elle me résistait, je l'ai assassinée." He produced more than twenty more plays alone or in collaboration before 1845, exclusive of dramatizations from his novels. *Richard Darlington* (Porte Saint-Martin, 10th of Dec. 1831), the first idea of which was drawn from Sir Walter Scott's *Chronicles of the Canongate*, owed part of its great success to the admirable acting of Frédéric Lemaitre. *La Tour de Nesle* (Porte Saint-Martin, 29th of May 1832), announced as by MM. X X X and Gaillardet, was the occasion of a duel and a law-suit with the original author, Frédéric Gaillardet, whose MS. had been revised, first by Jules Janin and then by Dumas. In rapidity of movement, and in the terror it inspired, the piece surpassed *Henri III.* and *Antony*.

A lighter drama, *Mademoiselle de Belle-Isle* (Théâtre Français, and of April 1839), still remains in the repertory.

In 1840 Dumas married Ida Ferrier, an actress whom he had imposed on the theatres that took his pieces. The amiable relations which had subsisted between them for eight years were disturbed by the marriage, which is said to have been undertaken in consequence of a strong hint from the duke of Orleans, and Mme Dumas lived in Italy separated from her husband.

As a novelist Dumas began by writing short stories, but his happy collaboration with Auguste Maquet,² which began in 1839, led to the admirable series of historical novels in which he proposed to reconstruct the whole course of French history. In 1844 he produced, with Maquet's help, that most famous of "cloak and sword" romances, *Les Trois Mousquetaires* (8 vols.), the material for which was discovered in the *Mémoires de M. d'Artagnan* (Cologne, 1701-1702) of Courtlès de Sandras. The adventures of d'Artagnan and the three musketeers, the gigantic Porthos, the clever Aramis, and the melancholy Athos, who unite to defend the honour of Anne of Austria against Richelieu and the machinations of "Milady," are brought down to the murder of Buckingham in 1629. Their admirers were gratified by two sequels, *Vingt ans après* (10 vols., 1845) and *Dix ans plus tard, ou le vicomte de Bragelonne* (26 pts., 1848-1850), which opens in 1660, showing us a mature d'Artagnan, a respectable captain of musketeers, and contains the magnificent account of the heroic death of Porthos. The three musketeers are as famous in England as in France. Thackeray could read about Athos from sunrise to sunset with the utmost contentment of mind, and R. L. Stevenson and Andrew Lang have paid tribute to the band in *Memories and Portraits* and *Letters to Dead Authors*. Before 1844 was out Dumas had completed a second great romance in 12 volumes, *Le Comte de Monte-Cristo*, in which he had help from Fiorentino as well as from Maquet. The idea of the intrigue was suggested by Peuchet's *Police dévoilée*, and the stress laid on the earlier incidents, Dantès, Danglars and the Château d'If, is said to have been an afterthought. Almost as famous as these two romances is the set of Valois novels of which Henri IV. is the central figure, beginning with *La Reine Margot* (6 vols., 1845), which contains the history of the struggle between Catherine of Medicis and Henry of Navarre; the history of the reign of Henry III. is told in *La Dame de Monsoreau* (8 vols., 1846), generally known in English as *Chicot the Jester*, from its principal character; and in *Les Quarante-cinq* (10 vols., 1847-1848), in which Diane de Monsoreau avenges herself on the duke of Anjou for the death of her former lover, Bussy d'Amboise.

Much has been written about the exact share which Dumas had in the novels which bear his name. The Dumas-Maquet series is undoubtedly the best, but Maquet alone never accomplished anything to approach them in value. The MSS. of the novels still exist in Dumas's handwriting, and the best of them bear the unmistakable stamp of his unrivalled skill as a narrator. The chief key to his enormous output is to be found in his untiring industry and amazing fertility of invention, not in the system of wholesale collaboration which was exposed with much exaggeration by Quérard in his *Supercheries littéraires* and by "Eugène de Mirecourt" (C. B. J. Jacquot) in his misleading *Fabrique de romans, maison Alexandre Dumas et c^o* (1845). His assistants, in fact, supplied him with outlines of romances on plans drawn up by himself, and he then rewrote the whole thing. That this method was never abused it would be impossible to say; *Les Deux Diane*, for instance, a prelude to the Valois novels, is said to have been written entirely by Paul Maurice, although Dumas's name appears on the title-page.

The latter part of Dumas's life is a record of excessive toil to meet prodigal expenditure and accumulated debts. His disasters began with the building of a house in the Renaissance style, with a Gothic pavilion and an "English" park, at Saint Germain-

¹ His friendship with Victor Hugo was interrupted in 1833-1834 by the articles contributed to the *Journal des débats* by a friend and protégé of the poet, Granier de Cassagnac, who brought against Dumas charges of wholesale plagiarism from other dramatists.

² The details of this collaboration were brought to light in a suit brought against Dumas by Maquet with regard to his share in the profits. See the *Gazette des tribunaux* (January 21, 22, 28, and February 4, 1858).

en-Laye. This place, called Monte-Cristo, was governed by a crowd of hangers-on of both sexes, who absorbed Dumas's large earnings and left him penniless. Dumas also founded the Théâtre Historique chiefly for the performance of his own works. The enterprise was under the patronage of the duc de Montpensier, and was under the management of Hippolyte Hostein, who had been the secretary of the Comédie Française. The theatre was opened in February 1847 with a dramatic version of *La Reine Margot*. Meanwhile Dumas had been the guest of the duc de Montpensier at Madrid, and made a quasi-official tour to Algeria and Tunis in a government vessel, which caused much comment in the press. Dumas had never changed his republican opinions. He greeted the revolution of 1848 with delight, and was even a candidate for electoral honours in the department of the Yonne. But the change was fatal to his theatrical enterprise, for the failure of which in 1850 he was made financially responsible. His son, Alexandre Dumas, was at that time living with his mother Mlle Labay, who was eventually reconciled with the elder Dumas. Father and son, though always on affectionate terms when they met, were too different in their ideas to see much of one another. After the *coup d'état* of 1851 Dumas crossed the frontier to Brussels, and two years of rapid production, and the economy of his secretary, Noël Parfait, restored something like order to his affairs. On his return to Paris in the end of 1853 he established a daily paper, *Le Mouquetaire*, for the criticism of art and letters. It was chiefly written by Dumas, whose *Mémoires* first appeared in it, and survived until 1857, when it was succeeded by a weekly paper, the *Monte-Cristo* (1857-1860). In 1858 Dumas travelled through Russia to the Caucasus, and in 1860 he joined Garibaldi in Sicily. After an expedition to Marseilles in search of arms for the insurgents, he returned to Naples, where Garibaldi nominated him keeper of the museums. After four years' residence in Naples he returned to Paris, and after the war of '66 he visited the battlefields and produced his story of *La Terreur prussienne*. But his powers were beginning to fail, and in spite of the 1200 volumes which he told Napoleon he had written, he was at the mercy of his creditors, and of the succession of theatrical ladies who tyrannized over him and feared nothing except the occasional visits of Dumas *filis*. He was finally rescued from these by his daughter, Mme Petel, who came to live with him in 1868; and two years later, on the 5th of December 1870, he died in his son's house at Puys, near Dieppe.

Dumas was never an actual candidate for academic honours, but he had more than once taken steps to investigate his chances of success. A statue of him was erected on the Place Malesherbes, Paris, in 1883, and the figure of d'Artagnan finds a place on the pedestal.

Auguste Maquet was Dumas's chief collaborator. Others were Paul Lacroix (the bibliophile "P. L. Jacob"), Paul Bocage, J. P. Mallefille and P. A. Fiorentino. The novels of Dumas may be conveniently arranged in a historical sequence. The Valois novels and the musqueteers series brought French history down to 1672. Contributions to later history are:—*La Dame de voluplé* (2 vols., 1864), being the memoirs of Mme de Luynes, and its sequel *Les Deux Reines* (2 vols., 1864); *La Tulipe noire* (3 vols., 1850), giving the history of the brothers de Witt; *Le Chevalier d'Harmental* (4 vols., 1853), and *Une Fille du régent* (4 vols., 1845), the story of two plots against the regent, the duke of Orleans; two books on Mme du Defand, *Mémoires d'une aveugle* (8 vols., 1856-1857) and *Les Confessions de la marquise* (8 vols., 1857), both of doubtful authorship; *Olympe de Clèves* (9 vols., 1852), the story of an actress and a young Jesuit novice in the reign of Louis XV., one of his most popular novels; five books on the beginning of the Revolution down to the execution of Marie Antoinette: the *Mémoires d'un médecin*, including *Joseph Balsamo* (19 pts., 1846-1848), in which J. J. Rousseau, Mme du Barry and the dauphiness Marie Antoinette figure, with its sequels; *Le Collier de la reine* (9 vols., 1849-1850), in which Balsamo appears under the alias of Cagliostro; *Angé Pitou* (8 vols., 1852), known in English as "The Taking of the Bastille"; *La Comtesse de Charny* (19 vols., 1853-1855), describing the attempts to save

the monarchy and the flight to Varennes; and *Le Chevalier de maison rouge* (6 vols., 1846), which opens in 1793 with the hero's attempt to save the queen. Among the numerous novels dealing with the later revolutionary period are:—*Les Blancs et les bleus* (3 vols., 1868) and *Les Compagnons de Jéhu* (7 vols., 1857). *Les Louves de Machecoul* (10 vols., 1859) deals with the rising in 1832 in La Vendée. Other famous stories are:—*Les Frères corses* (2 vols., 1845); *La Femme au collier de velours* (2 vols., 1851); *Les Mohicans de Paris* (19 vols., 1854-1855), detective stories with which may be classed the series of *Crimes célèbres* (8 vols., 1839-1841), which are, however, of doubtful authorship; *La San Félice* (9 vols., 1864-1865), in which Lady Hamilton played a prominent part, with its sequels *Emma Lyonna* and *Sous-sensés d'une favorite*. Of his numerous historical works other than fiction the most important is his *Louis XIV et son siècle* (4 vols., 1845). *Mes Mémoires* (20 vols., 1852-1854; Eng. trans. of selections by A. F. Davidson, 2 vols., 1891) is an account of his father and of his own life down to 1832. There are collective editions of his plays (6 vols., 1834-1836, and 15 vols., 1863-1874), but of the 91 pieces for which he was wholly or partially responsible, 24 do not appear in these collections.

The complete works of Dumas were issued by Michel Lévy frères in 277 volumes (1860-1884). The more important novels have been frequently translated into English. There is a long list of writings on his life and his works both in English and French. The more important French authorities are: his own memoirs, already cited; C. Glinel, *Alexandre Dumas et son œuvre* (Reims, 1884); H. Parigot, *Dumas père* (Grands écrivains français series, 1902), and *Le Dramatiste Alexandre Dumas* (1899); H. Blaze de Bury, *Alexandre Dumas* (1885); Philibert Audebrand, *Alexandre Dumas à la maison d'or* (1898); G. Ferry, *Dernières années d'Alexandre Dumas* (1885); and L. H. Lecomte, *Alexandre Dumas* (1904). Of the English lives of Dumas perhaps the best is that by Arthur F. Davidson, *Alexandre Dumas Père, his Life and Works* (1902), which contains an extensive bibliography. See also lives by P. Fitzgerald (2 vols., 1871) and H. A. Spurr (1902), and essays by Andrew Lang (*Letters to Dead Authors*), Brander Matthews (*French Dramatists*), R. L. Stevenson (*Memoirs and Portraits*). (M. Br.)

DUMAS, ALEXANDRE ["DUMAS FILS"] (1824-1895), French dramatist and novelist, was born in Paris on the 27th of July 1824, the natural son of Alexandre Dumas (see above) and the dressmaker Marie Labay. His father at that date was still a humble clerk and not much more than a boy. "Happily," writes the son, "my mother was a good woman, and worked hard to bring me up"; while of his father he says, "by a most lucky chance he happened to be well-natured," and "as soon as his first successes as a dramatist" enabled him to do so, "recognized me and gave me his name." Nevertheless, the lad's earlier school-life was made bitter by his illegitimacy. The cruel taunts and malevolence of his companions rankled through life (see preface to *La Femme de Claude* and *L'Affaire Clémenceau*), and left indelible marks on his character and thoughts. Nor was his paternity, however distinguished, without peril. Alexandre the younger and elder saw life together very thoroughly, and Paris can have had few mysteries for them. Suddenly the son, who had been led to regard his prodigal father's resources as inexhaustible, was rudely undeceived. Coffers were empty, and he had accumulated debts to the amount of two thousand pounds.

Thereupon he pulled himself together. To a son of Dumas the use of the pen came naturally. Like most clever young writers—and report speaks of him as specially brilliant at that time—he opened with a book of verse, *Péchés de jeunesse* (1847). It was succeeded in 1848 by a novel, *La Dame aux camélias*, a sort of reflection of the world in which he had been living. The book had considerable success, and was followed, in fairly quick succession, by *Le Roman d'une femme* (1848) and *Diane de Lys* (1851). All this, however, did not deliver him from the load of debt, which, as he tells us, remained odious. In 1849 he dramatized *La Dame aux camélias*, but for various reasons, the rigour of the censorship being the most important, it was not till the 2nd of February 1852, and then only by the intervention of Napoleon's all-powerful minister, Morny, that the play could be produced at the Vaudeville. It succeeded then, and has held the stage ever since, less perhaps from inherent superiority to

other plays which have foundered than to the great opportunities it affords to any actress of genius.

Thenceforward Dumas's career was that of a brilliant and prosperous dramatist. *Diane de Lys* (1853), *Le Demi-Monde* (1855), *La Question d'argent* (1857), *Le Fils naturel* (1858), *Le Père prodigue* (1859) followed rapidly. Debts became a thing of the past, and Dumas a wealthy man. The didactic habit was always strong upon him. "Alexandre loves preaching overmuch," wrote his father; and in most of his plays he assumes the attitude of a rigid and uncompromising moralist commissioned to impart to a heedless world lessons of deep import. The lessons themselves are mostly concerned with the "eternal feminine," by which Dumas was haunted, and differ in ethical value. Thus in *Les Idées de Madame Aubray* (1867) he inculcates the duty of the seducer to marry the woman he has seduced; but in *La Femme de Claude* (1873) he argues the right of the husband to take the law into his own hand and kill the wife who is unfaithful and worthless—a thesis again defended in his novel, *L'Affaire Clémenceau*, and in his pamphlet, *L'Homme-femme*; while in *Diane de Lys* he had taught that the betrayed husband was entitled to kill—not in a duel, but summarily—the man who had taken his honour; and in *L'Évangère* (1876) the bad husband is the victim. Nor did he preach only in his plays. He preached in voluminous introductions, and pamphlets not a few. And when, in 1870 and 1872, France was going through bitter hours of humiliation, he called her to repentance and amendment in a *Nouvelle Lettre de Junius* and two *Lettres sur les choses du jour*.

As a moralist Dumas *filis* took himself very seriously indeed. As a dramatist, didacticism apart, he had great gifts. He knew his business thoroughly, possessed the art of situation, interest, crisis—could create characters that were real and alive. His dialogue also is admirable, the repartee rapier-like, the wit most keen. He was singularly happy, too, in his dramatic interpreters. The cast of *L'Évangère*, for instance, comprised Sarah Bernhardt, Sophie Croizette, Madeleine Brohan, in the female characters; and Coquelin, Got, Mounet-Sully and Fêbre in the male characters; and Aimée Desclée, whom he discovered, gave her genius to the creation of the parts of the heroine in *Une Visite de noces*, the *Princesse Georges* and *La Femme de Claude*. His wit has been mentioned. He possessed it in abundance, of a singularly trenchant kind. It shows itself less in his novels, which, however, do not contain his best work; but in his introductions, whether to his own books or those of his friends, and what may be called his "occasional" writings, there is an admirable brightness. At work of this kind he showed the highest literary skill. His style is that of the best French traditions. Towards his father Dumas acted a kind of brother's part, and while keeping strangely free from his literary influence, both loved and admired him. The father never belonged to the French Academy. The son was elected into that august assembly on the 30th of January 1874. He died on the 27th of November 1895.

See also Jules Claretie, *A. Dumas filis* (1883); Paul Bourget, *Notewares Essais de psychologie contemporaine* (1885); "La Comédie de mœurs," by René Doumic, in *L. Petit de Julleville's Histoire de la langue et de la littérature française*, viii. pp. 82 et seq.; R. Doumic, *Portraits et écrivains* (1892); Emile Zola, *Documents littéraires, études et portraits* (1881). (F. T. M.)

DUMAS, GUILLAUME MATHIEU, COUNT (1753–1837), French general, was born at Montpellier, of a noble family, on the 23rd of November 1753. He joined the army in 1773, and entered upon active service in 1780, as aide-de-camp to Rochambeau in the American War. He had a share in all the principal engagements that occurred during a period of nearly two years. On the conclusion of peace in 1783 he returned to France as a major. He was engaged from 1784 to 1786 in exploring the archipelago and the coasts of Turkey. He was present at the siege of Amsterdam in 1787, where he co-operated with the Dutch against the Prussians. At the Revolution he acted with Lafayette and the constitutional liberal party. He was entrusted by the Assembly with the command of the escort which conducted Louis XVI. to Paris from Varennes. In 1791

as a *maréchal de camp* he was appointed to a command at Metz, where he rendered important service in improving the discipline of the troops. Chosen a member of the Legislative Assembly in the same year by the department of Seine-et-Oise, he was in the following year elected president of the Assembly. When the extreme republicans gained the ascendancy, however, he judged it prudent to make his escape to England. Returning after a brief interval, under the apprehension that his father-in-law would be held responsible for his absence, he arrived in Paris in the midst of the Reign of Terror, and had to flee to Switzerland. Soon after his return to France he was elected a member of the Council of Ancients. After the 18th Fructidor (1797) Dumas, being proscribed as a monarchist, made his escape to Holstein, where he wrote the first part of his *Précis des événements militaires* (published anonymously at Hamburg, 1800).

Recalled to his native country when Bonaparte became First Consul, he was entrusted with the organization of the "Army of Reserve" at Dijon. In 1801 he was nominated a councillor of state. He did good service at Austerlitz, and went in 1806 to Naples, where he became minister of war to Joseph Bonaparte. On the transfer of Joseph to the throne of Spain, Dumas rejoined the French army, with which he served in Spain during the campaign of 1808, and in Germany during that of 1809. After the battle of Wagram, Dumas was employed in negotiating the armistice. In 1810 he became grand officer of the Legion of Honour and a count of the empire. In the Russian campaign of 1812 he held the post of intendant-general of the army, which involved the charge of the administrative department. The privations he suffered in the retreat from Moscow brought on a dangerous illness. Resuming, on his recovery, his duties as intendant-general, he took part in the battles of 1813, and was made prisoner after the capitulation of Dresden. On the accession of Louis XVIII., Dumas rendered his new sovereign important services in connexion with the administration of the army. When Napoleon returned from Elba, Dumas at first kept himself in retirement, but he was persuaded by Joseph Bonaparte to present himself to the emperor, who employed him in organizing the National Guard. Obligated to retire when Louis XVIII. was restored, he devoted his leisure to the continuation of his *Précis des événements militaires*, of which nineteen volumes, embracing the history of the war from 1798 to the peace of 1807, appeared between 1817 and 1826. A growing weakness of sight, ending in blindness, prevented him from carrying the work further, but he translated Napier's *Peninsular War* as a sort of continuation to it. In 1818 Dumas was restored to favour and admitted a member of the council of state, from which, however, he was excluded in 1822. After the revolution of 1830, in which he took an active part, Dumas was created a peer of France, and re-entered the council of state. He died at Paris on the 16th of October 1837.

Besides the *Précis des événements militaires*, which forms a valuable source for the history of the period, Dumas wrote *Souvenirs du lieutenant-général Comte Mathieu Dumas* (published posthumously by his son, Paris, 1839).

DUMAS, JEAN BAPTISTE ANDRÉ (1800–1884), French chemist, was born at Alais (Gard) on the 15th of July 1800. Disappointed in his early hope of entering the navy, he became apprentice to an apothecary in his native town; but seeing little prospect of advancement in that calling, he soon moved to Geneva (in 1816). There he attended the lectures of such men as M. A. Pictet in physics, C. G. de la Rive in chemistry, and A. P. de Candolle in botany, and before he had reached his majority he was engaged with Pierre Prévost in original work on problems of physiological chemistry, and even of embryology. In 1823, acting on the advice of A. von Humboldt, he left Geneva for Paris, which he made his home for the rest of his life. There he gained the acquaintance of many of the foremost scientific men of the day, and quickly made a name for himself both as a teacher and an investigator, attaining within ten years the honour of membership of the Academy of Sciences. When approaching his fiftieth year he entered political life, and became a member of the National Legislative Assembly. He acted as minister

of agriculture and commerce for a few months in 1850-1851, and subsequently became a senator, president of the municipal council of Paris, and master of the French mint; but his official career came to a sudden end with the fall of the Second Empire. He died at Cannes on the 11th of April 1884. Dumas is one of the most prominent figures in the chemical history of the middle part of the 19th century. He was one of the first to criticize the electro-chemical doctrines of J. J. Berzelius, which at the time his work began were widely accepted as the true theory of the constitution of compound bodies, and opposed a unitary view to the dualistic conception of the Swedish chemist. In a paper on the atomic theory, published so early as 1826, he anticipated to a remarkable extent some ideas which are frequently supposed to belong to a later period; and the continuation of these studies led him to the ideas about substitution ("metalepsis") which were developed about 1839 into the theory ("Older Type Theory") that in organic chemistry there are certain types which remain unchanged even when their hydrogen is replaced by an equivalent quantity of a haloid element. Many of his well-known researches were carried out in support of these views, one of the most important being that on the action of chlorine on acetic acid to form trichloroacetic acid—a derivative of essentially the same character as the acetic acid itself. In the 1826 paper he described his famous method for ascertaining vapour densities, and the redeterminations which he undertook by its aid of the atomic weights of carbon and oxygen proved the forerunners of a long series which included some thirty of the elements, the results being mostly published in 1838-1860. He also devised a method of great value in the quantitative analysis of organic substances for the estimation of nitrogen, while the classification of organic compounds into homologous series was advanced as one consequence of his researches into the acids generated by the oxidation of the alcohols. Dumas was a prolific writer, and his numerous books, essays, memorial addresses, &c., show him to have been gifted with a clear and graceful style. His earliest large work was a treatise on applied chemistry in eight volumes, the first of which was published in 1828 and the last twenty years afterwards. In the *Essai de statique chimique des êtres organisés* (1841), written jointly with J. B. J. D. Boussingault (1802-1887), he treated the chemistry of life, both plant and animal; this book brought him into conflict with Liebig, who conceived that some of his prior work had been appropriated without due acknowledgment. In 1824, in conjunction with J. V. Apdounin and A. T. Brongniart, he founded the *Annales des sciences naturelles*, and from 1840 he was one of the editors of the *Annales de chimie et de physique*. As a teacher Dumas was much sought after for his lectures at the Sorbonne and other institutions both on pure and applied science; and he was one of the first men in France to realize the importance of experimental laboratory teaching.

DU MAURIER, GEORGE LOUIS PALMELLA BUSSON (1834-1896), British artist and writer, was born in Paris. His father, a naturalized British subject, was the son of *émigrés* who had left France during the Reign of Terror and settled in London. In *Peter Ibbetson*, the first of the three books which won George Du Maurier late in life a reputation as novelist almost as great as he had enjoyed as artist and humorist for more than a generation, the author tells in the form of fiction the story of his singularly happy childhood. He was brought to London, indeed, when three or four years old, and spent in Devonshire Terrace and elsewhere two colourless years; but vague memories of this period were suddenly exchanged one beautiful day in June—"the first day of his conscious existence"—for the charming realities of a French garden and "an old yellow house with green shutters and mansard roofs of slate." Here, at Passy, with his "gay and jovial father" and his young English mother, the boy spent "seven years of sweet priceless home-life—seven times four changing seasons of simple genial pre-Imperial Frenchness." The second chapter of Du Maurier's life had for scene a Paris school, very much in the style of that "Institution F. Brossard" which he describes, at once so vividly and so sympathetically, in *The Martian*; and like "Barty Josselin's"

schoolfellow and biographer, he left it (in 1851) to study chemistry at University College, London, actually setting up as an analytical chemist afterwards in Bucklersbury. But this was clearly not to be his *métier*, and the year 1856 found him once more in Paris, in the Quartier Latin this time, in the core of that art-world of which in *Trilby*, forty years later, he was to produce with pen and pencil so idealistic and fascinating a picture. Then, like "Barty Josselin" himself, he spent some years in Belgium and the Netherlands, experiencing at Antwerp in 1857, when he was working in the studio of van Ierius, the one great misfortune of his life—the gradual loss of sight in his left eye, accompanied by alarming symptoms in his right. It was a period of tragic anxiety, for it seemed possible that the right eye might also become affected; but this did not happen, and the dismal cloud was soon to show its silver lining, for, about Christmas-time 1858, there came to the forlorn invalid a copy of *Punch's Almanac*, and with it the dawn of a new era in his career.

There can be little doubt that the study of this *Almanac*, and especially of Leech's drawings in it, fired him with the ambition of making his name as a graphic humorist; and it was not long after his return to London in 1860 that he sent in his first contribution (very much in Leech's manner) to *Punch*. Mark Lemon, then editor, appreciated his talent, and on Leech's death in 1865 appointed him his successor, counselling him with wise discrimination not to try to be "too funny," but "to undertake the light and graceful business" and be the "romantic tenor" in Mr Punch's little company, while Keene, as Du Maurier puts it, "with his magnificent highly-trained basso, sang the comic songs." These respective rôles the two artists continued to play until the end, seldom trespassing on each other's province; the "comic songs" finding their inspiration principally in the life of the homely middle and lower middle classes, while the "light and graceful business" enacted itself almost exclusively in "good Society." To a great extent, also, Du Maurier had to leave outdoor life to Keene, his weak sight making it difficult for him to study and sketch in the open air and sunshine, thus cutting him off, as he records regretfully, from "so much that is so popular, delightful and exhilarating in English country life"—hunting and shooting and fishing and the like. He contrived, however, to give due attention to milder forms of outdoor recreation, and turned to good account his familiarity with Hampstead Heath and Rotten Row, and his holidays with his family at Whitby and Scarborough, Boulogne and Dieppe.

Of Du Maurier's life during the thirty-six years of his connexion with *Punch* there is not, apart from his work as an artist, much to record. In the early 'sixties he lived at 85 Newman Street in lodgings, which he shared with his friend Lionel Henley, afterwards R.B.A., working hard at his *Punch* sketches and his more serious contributions to *Once a Week* and the *Cornhill Magazine*. After his marriage with Miss Emma Wightwick in 1862 he took a spacious and pleasant house near Hampstead Heath, in surroundings made familiar in his drawings. Shortly before he died he moved to a house in Oxford Square. About 1866 he struck out a new line in his admirable illustrations to Jerrold's *Story of a Feather*. In 1869 he realized a long-cherished aspiration, the illustrating of Thackeray's *Esmond*, and in 1879 he drew twelve additional vignettes for it, in the same year providing several illustrations for the *Ballads*. From time to time he sent pretty and graceful pictures to the exhibitions of the Royal Society of Painters in Water-Colour, to which he was elected in 1881. In 1885 the first exhibition of his works at the Fine Art Society took place. Thus occupied in the practice of his art, spending his leisure in social intercourse with his many friends and at home with his growing family, hearing all the new singers and musicians, seeing all the new plays, he lived the happiest of lives. He died somewhat suddenly on the 8th of October 1896, and was buried in the Hampstead parish churchyard. He left a family of two sons—the elder, Major Guy Du Maurier (b. 1865), a soldier who became more widely known in 1909 as author of the military play *An Englishman's Home*, and the younger, Gerald, a well-known actor—and three daughters.

It is impossible, in considering Du Maurier's work, to avoid comparing it with that of Leech and Keene, the more so that in his little book on *Social Pictorial Satire* he himself has set forth or suggested the points both of resemblance and of difference. Like Keene, though Keene's marvellous technique was his despair, Du Maurier was a much more finished draughtsman than John Leech, but in other respects he had less in common with the younger than with the older humorist. He shows himself, in the best sense, a man of feeling in all his work. He is clearly himself in love with "his pretty woman," as he calls her—every pen-stroke in his presentation of her is a caress. How affectionate, too, are his renderings of his fond young mothers and their big, handsome, simple-minded husbands; his comely children and neat nurserymaids; even his dogs—his elongated dachshunds and magnificent St Bernards! And how he scorns the snobs and philistines—Sir Gorgius Midas and Sir Pompey Bedell, Grigsby and Cadby, Soapley and Toadson! How merciless is his ridicule of the aesthetes of the 'eighties—Maudle and Postlethwaite and Mrs Cimabue Brown! Even to Mrs Ponsoyby de Tomkyns, his most conspicuous creation, his satire is scarcely tempered, despite her prettiness. He shows up unsparringly all her unscrupulous little ways, all her cynical, cunning little wiles. Like Leech, he revelled in the lighter aspects of life—the humours of the nursery, the drawing-room, the club, the gaieties of the country house and the seaside—without being blind to the tragic and dramatic. Just as Leech could rise to the height of the famous cartoon "General Février turned Traitor," so it was Du Maurier who inspired Tenniel in that impressive drawing on the eve of the Franco-German War, in which the shade of the great Napoleon is seen warning back the infatuated emperor from his ill-omened enterprise. In his tender drawings in *Once a Week*, also, and in his occasional excursions into the grotesque in *Punch*, such as his picture of "Old Nickotin stealing away the brains of his devotees," he has given ample proof of his faculty for moving and impressive art. The technique of Du Maurier's work in the 'eighties and the 'nineties, though to the average man it seems a marvel of finish and dexterity, is considered by artists a falling off from what was displayed in some of his earlier *Punch* drawings, and especially in his contributions to the *Cornhill Magazine* and *Once a Week*. His later work is undoubtedly more mannered, more "finicking," less simple, less broadly effective. But it is to his fellow-craftsmen only and to experts that this is noticeable.

A quaint tribute has been paid to the literary talent shown in Du Maurier's inscriptions to his drawings by Mr F. Anstey (Guthrie), author of *Vice Versa*, and Du Maurier's colleague on the staff of *Punch*. "In these lines of letterpress," says Mr Anstey, "he has brought the art of précis-writing to perfection." They are indeed singularly concise and to the point. It is the more curious, therefore, to note that in his novels, and even in his critical essays, Du Maurier reveals very different qualities: the précis-writer has become an *improvisatore*, pouring out his stories and ideas in full flood, his style changing with every mood—by turn humorous, eloquent, tender, gay, sometimes merely "skittish," sometimes quite solemn, but never for long; sometimes, again, breaking into graceful and haunting verse. He writes with apparent artlessness; but, in his novels at least, on closer examination, it is found that he has in fact exerted all his ingenuity to give them—what such flagrantly untrue tales most require—verisimilitude. It is hard to say which of the three stories is the more impossible: that of Trilby, the tone-deaf artist's model who becomes a *prima donna*, that of Barty Josselin and his guardian angel from Mars, or that of the dream-existence of Peter Ibbetson and the duchess of Towers. They are all equally preposterous, and yet plausible. The drawings are cunningly made to serve the purpose of evidence, circumstantial and direct. These books cannot be criticized by the ordinary canons of the art of fiction. They are a *genre* by themselves, a blend of unfettered day-dream and rose-coloured reminiscence. For the dramatic version of *Trilby* by Mr Paul Potter Du Maurier would accept no credit. The play was produced in 1895 by

Herbert Beerbohm Tree, at the Haymarket, with immense popular success.

Some striking examples of Du Maurier's work for *Once a Week* and the *Cornhill Magazine* are included in Gleeson White's *English Illustrators of the Sixties*. The following is a list of the chief works which he illustrated: Foxe's *Book of Martyrs* (1865); Mrs. Gaskell's *Wives and Daughters* (1866); Jerrold's *Story of a Feather* (1867); Owen Meredith's *Lucile* (1868); *The Book of Drawing-room Plays*, by H. Dalton (1868); *Sooner or Later*, by C. A. G. Brooke (1868); Thackeray's *Ermond* (1869 and 1870), and *Ballads* (1870); *Misunderstood*, by Florence Montgomery (1874); *Round about the Islands*, by C. W. Scott (1874); *Hurluck Chaze*, by G. E. Sargent (1876); *Songs of many Seasons*, by J. Browne (in collaboration) (1876); *Pegasus Re-saddled*, by H. C. Pennell (1877); *Ingoldsby Legends* (in collaboration), by R. Barham (1877); *Prudence*, by L. C. Lillie (1882); *As in a Looking-glass*, by F. C. Phillips (1889); *Luke Ashleigh*, by A. Elwes (1891); and his own three novels, which appeared serially in *Harper's Magazine*: *Peter Ibbetson* (1892); *Trilby* (1894); *The Martian* (1897), and published after his death. In 1897 also there was published, under the title *English Society*, with an introduction by W. D. Howells, a collection of full-page drawings which he had contributed regularly to *Harper's Magazine*.

Some of his *Punch* drawings have been reproduced also in *The Collections of Mr Punch* (1880); *Society Pictures from Punch* (1890); *A Legend of Camelot* (1890). To his *Social Pictorial Satire* (1890) reference has been made. He contributed two essays upon book illustration to the *Magazine of Art* (1890). See also the *Magazine of Art* for 1892, for an article upon his work by W. Delaplaine Scull, with illustrations. Other volumes containing information about his life and work are: *The History of Punch*, by M. H. Spielmann; *In Bohemia with Du Maurier*, by Felix Moschella; Henry James's "Du Maurier and London Society," *Century Magazine* (1883); and "Du Maurier," *Harper's Magazine* (September, 1897, June, 1899). See also Ruskin's *Art of England*, Lecture 5, Pennell's *Pen-Drawing and Pen-Draughtsmen*, and Muther's *Modern Painting*, vol. ii. (F. W. W.)

DUMBARTON, a royal, municipal and police burgh, seaport, and county town of Dumbartonshire, Scotland, situated on the river Leven, near its confluence with the Clyde, 15½ m. W. by N. of Glasgow by the North British and Caledonian railways. Pop. (1891) 17,625; (1901) 19,985. The Alcluith ("hill of the Clyde") of the Britons, and Dunbarton ("fort of the Britons") of the Celts, it was the capital of the district of Strathclyde. Here, too, the Romans had a naval station which they called Theodosia. Although thus a place of great antiquity, the history of the town practically centres in that of the successive fortresses on the Rock of Dumbarton, a twin-peaked mount, 240 ft. high and a mile in circumference at the base. The fortress was often besieged and sometimes taken, the Picts seizing it in 736 and the Northmen in 870, but the most effectual surprise of all was that accomplished, in the interests of the young King James VI., by Thomas Crawford of Jordanhill on March 31, 1571. The castle was held by Queen Mary's adherents, and as it gave them free communication with France, its capture was deemed essential. Crawford decided to climb the highest point, concluding that, owing to its imagined security, it would be carelessly guarded. Favoured with a dark and foggy night the party of 150 men and a guide reached the first ledge of rock undiscovered. In scaling the second precipice one of the men was seized with an epileptic fit on the ladder. Crawford bound him to the ladder and then turned it over and was thus enabled to ascend to the summit. At this moment the alarm was given, but the sentinel and the sleepy soldiers were slain and the cannon turned on the garrison. Further resistance being useless, the castle was surrendered. During the governorship of Sir John Menteith, William Wallace was in 1305 imprisoned within its walls before he was removed to London. The higher of the two peaks is known as Wallace's seat, a tower, perhaps the one in which he was incarcerated, being named after him. On the portcullis gateway may still be seen rudely carved heads of Wallace and his betrayer, the latter with his finger in his mouth. Queen Mary, when a child, resided in the castle for a short time. It is an ugly barrack-like structure defended by a few obsolete guns, although by the Union Treaty it is one of the four fortresses that must be maintained. The rock itself is basalt, with a tendency to columnar formation, and some parts of it have a magnetic quality.

The town arms are the elephant and castle, with the motto *Fortitudo et Fidelity*. Dumbarton was of old the capital of the

earldom of Lennox, but was given up by Earl Maldwyn to Alexander II., by whom it was made a royal burgh in 1221 and declared to be free from all imposts and burgh taxes. Later sovereigns gave it other privileges, and the whole were finally confirmed by a charter of James VI. It had the right to levy customs and dues on all vessels on the Clyde between Loch Long and the Kelvin. "Offers dues" on foreign ships entering the Clyde were also exacted. In 1700 these rights were transferred to Glasgow by contract, but were afterwards vested in a special trust created by successive acts of parliament.

Most of the town lies on the left bank of the Leven, which almost converts the land here into a peninsula, but there is communication with the suburb of Bridgend on the right bank by a five-arched stone bridge, 300 ft. long. The public buildings include the Burgh Hall, the academy (with a graceful steeple), the county buildings, the Denny Memorial, a Literary and a Mechanics' institute, Masonic hall, two cottage hospitals, a fever hospital, a public library and the combination poorhouse. There are two public parks—Broad Meadow (20 acres), part of ground reclaimed in 1850, and Leven Grove (32 acres), presented to the corporation in 1885 by Peter Denny and John McMillan, two shipbuilders who helped lay the foundation of the town's present prosperity. The old parish kirkyard was closed in 1856, but a fine cemetery was constructed in its place outside the town. Dumbarton is controlled by a provost and a council. With Port-Glasgow, Renfrew, Rutherglen and Kilmarnock it unites in returning one member to parliament. The principal industry is shipbuilding. The old staple trade of the making of crown glass, begun in 1777, lapsed some 70 years afterwards when the glass duty was abolished. There are several great engineering works, besides iron and brass foundries, saw-mills, rope-yards and sail-making works. There are quays, docks and a harbour at the mouth of the Leven, and a pier for river steamers runs out from the Castle rock. The first steam navigation company was established in Dumbarton in 1815, when the "Duke of Wellington" (built in the town) plied between Dumbarton and Glasgow. But it was not till 1844, consequent on the use of iron for vessels, that shipbuilding became the leading industry.

DUMBARTONSHIRE, a western county of Scotland, bounded N. by Perthshire, E. by Stirlingshire, S.E. by Lanarkshire, S. by the Clyde and its estuary, and W. by Loch Long and Argyllshire. There is also a detached portion, comprising the parish of Kirkintilloch and part of that of Cumbernauld enclosed between the shires of Stirling and Lanark. This formerly formed part of Stirlingshire, but was annexed in the 14th century when the earl of Wigtown, to whom it belonged, became heritable sheriff of Dumbartonshire. Dumbartonshire has an area of 170,762 acres or 267 sq. m. The north-west and west are mountainous, the chief summits being Ben Vorlich (3092 ft.), Ben Vane (3004), Doune Hill (2409), Beinn Chaorach (2338), Beinn a Mhanaich (2328), Beinn Eich (2302), Cruach annt Suthain (2244), Ben Roach (2168), Beinn Tharsuinn (2149), Beinn Dubh (2018), Balnock (2092) and Tullich Hill (2075). In the south are the Kilpatrick Hills, their highest points being Duncomb and Fynloch (each 1313 ft.). The Clyde, the Kelvin and the Leven are the only rivers of importance. The Leven flows out of Loch Lomond at Balloch and joins the Clyde at Dumbarton after a serpentine course of about 7 m. Most of the other streams are among the mountains, whence they find their way to Loch Lomond, the principal being the Inveruglas, Douglas, Luss, Finlas and Fruin. Nearly all afford good sport to the angler. Of the inland lakes by far the largest and most magnificent is Loch Lomond (q.v.). The boundary between the shires of Dumbarton and Stirling follows an imaginary line through the lake from the mouth of Endrick Water to a point opposite the isle of Vow, giving about two-thirds of the loch to the former county. Loch Sloy on the side of Ben Vorlich is a long, narrow lake, 812 ft. above the sea amid wild scenery. From its name the Macfarlanes took their slogan or war-cry. The shores of the Gareloch, a salt-water inlet 6½ m. long and 1 m. wide, are studded with houses of those whose business lies in Glasgow. Garelochhead has grown into a favourite summer

resort; Clynder is famed for its honey. The more important salt-water inlet, Loch Long, is 17 m. in length and varies in width from 2 m. at its mouth to about ½ a mile in its upper reach. It is the dumping-place for the dredgers which are constantly at work preserving the tide-way of the Clyde from Dumbarton to the Broomielaw—its use for this purpose being a standing grievance to anglers. The scenery on both shores is very beautiful. Only a mile separates Garelochhead from Loch Long, and at Arrochar the distance from Tarbet on Loch Lomond is barely 1½ m. Nearly all the glens are situated in the Highland part of the shire, the principal being Glen Sloy, Glen Douglas, Glen Luss and Glen Fruin. The last is memorable as the scene of the bloody conflict in 1603 between the Macgregors and the Colquhouns, in which the latter were almost exterminated. It was this savage encounter that led to the proscription of the Macgregors, including the famous Rob Roy.

Geology.—Like the other counties along the eastern border of the Highlands, Dumbartonshire is divided geologically into two areas, the boundary between the two being defined by a line extending from Rosedhu on Loch Lomond south-west by Row and Rosneath to Kilcreggan. The mountainous region lying to the north of this line is composed of rocks belonging to the metamorphic series of the Eastern Highlands and representing several of the groups met with in the adjoining counties of Perth and Argyll. Immediately to the north of the Highland border the Aberfoyle slates and grits appear, repeated by isoclinal folds trending north-east and south-west and dipping towards the north-west. These are followed by a great development of the Ben Ledi grits and schists—the representatives of the Beinn Bheula grits and albite schists of Argyllshire, which, by means of rapid plication, spread over the high grounds northwards to beyond the head of Loch Lomond. Along the line of section between Luss and Arduil important evidence is obtained of the gradual increase of metamorphism as we proceed northwards from the Highland border. The original clastic characters of the strata are obscured and the rocks between Arrochar and Inverarnan in Glen Falloch merge into quartz-biotite gneisses and albite schists. In the extreme north between Arduil and the head of Glen Fyne in Argyllshire there is a large development of plutonic rocks piercing the Highland schists and producing marked contact metamorphism. These range from acid to ultrabasic types and include granite, augite-diorite, picrite and serpentine. On the hills-slopes to the west of Arduil and Inverarnan the diorite appears, while farther west, between the watershed and Glen Fyne, there is a large mass of granite. Boulders of plutonic rocks from this area have been widely distributed by the ice during the glacial period. Immediately to the south of the Highland border line there is a belt of Upper Old Red Sandstone strata which stretches from the shores of Loch Lomond westwards by Helensburgh and Rosneath Castle to Kilcreggan. These sandstones and conglomerates are succeeded by the sandstones, shales, clays and cementstones at the base of the Carboniferous formation which occupy a narrow strip between Loch Lomond and Gareloch and are cut off by a fault along their south-east margin. East of this dislocation there is a belt of Lower Old Red Sandstone strata extending from the mouth of the Endrick Water south-westward by Balloch to the shore of the Clyde west of Cardross, which is bounded on either side by the upper division of that system. Still farther east beyond Dumbarton the Upper Old Red Sandstone is again surmounted by the representatives of the Cementstone group, which are followed by the lavas, tuffs and agglomerates of the Kirkpatrick Hills, intercalated in the Calciferous Sandstone series. Here the terraced features of the volcanic plateau, produced by the denudation of the successive flows is well displayed. Eastwards by Kilpatrick and Bearsden to the margin of the county near Maryhill the rocks of Calciferous Sandstone age are followed in normal order by the Carboniferous Limestone series; the Hurlet Limestone and Hurlet Coal of the lower limestone group being prominently developed. In the detached portion of the county between Kirkintilloch and Cumbernauld there is an important coalfield embracing the seams in the middle or coal-bearing group of the Carboniferous Limestone series. In this county there are several striking examples of the east and west dolerite dykes which are probably of late Carboniferous age. These traverse the Highland schists between Loch Long and Loch Lomond, the Old Red Sandstone area between Alexandria and the Blane Valley, and the Carboniferous tract near Cumbernauld. The ice which radiated from the Dumbartonshire Highlands moved south-east and east towards the central plain of Carboniferous rocks. Hence the boulder clay of the lowland districts is abundantly charged with boulders of schistose grit, slate, gneiss and granite derived from areas lying far to the north-west. Along the shores of the Clyde the broad terraced features indicate the limits of successive raised beaches.

Climate and Agriculture.—There is excessive rainfall in the Highlands, averaging 53 in. at Helensburgh up to nearly 70 in. in the north. The temperature, with an average for the year

of 47° F., varies from 38° in January to 58° in July, but in the valleys the heat in midsummer is often oppressive. The prevailing winds are from the west and south-west, but easterly winds are frequent in the spring. Frosts are seldom severe, and, except on the mountains, snow never lies long. The arable lands extend chiefly along the Clyde and the Leven, and are composed of rich black loam, gravelly soil and clay. From the proximity to Glasgow and other large towns the farmers have the double advantage of good manure and a ready market for all kinds of stock and produce, and under this stimulus high farming and dairying on a considerable scale prosper. Black-faced sheep and Highland cattle are pastured on the hilly lands and Cheviots and Ayrshires on the low grounds. Oats and wheat are the principal cereals, but barley and potatoes in abundance, and turnips and beans are also grown.

Other Industries.—Turkey-red dyeing has long been the distinctive industry of the county. The water of the Leven being not only constant but also singularly soft and pure, dyers and bleachers have constructed works at many places in the Vale of Leven. Bleaching has been carried on since the early part of the 18th century, and cotton-printing at Levenfield dates from 1768. The establishments at Alexandria, Bonhill, Jamestown, Renton and other towns for all the processes connected with the bleaching, dyeing and printing of cottons, calicoes and other cloths, besides yarns, are conducted on the largest scale. At Milton the first power-loom mill was erected. The engineering works and shipbuilding yards at Clydebank are famous, and at Dumbarton there are others almost equally busy. The extensive Singer sewing-machine works are at Kilbowie, and the Clyde Trust barge-building shops are at Dalmuir. There are distilleries and breweries at Duntocher, Bowling, Dumbarton, Milngavie (pronounced *Milgwy*) and other towns. In fact the Vale of Leven and the riverside towns east of Dumbarton form a veritable hive of industry. In the detached portion, Kirkintilloch and Cumbernauld are seats of great activity in the mining of coal and ironstone, and there are besides chemical works and saw-mills in the former town. There is some fishing at Helensburgh and along the Gareloch.

The populous districts of the county are served almost wholly by the North British railway. From Helensburgh to Inverarnan the Highland railway runs through scenery of the most diversified and romantic character. The Caledonian railway has access to Balloch from Glasgow, and its system also traverses the detached portion. Portions of the Forth and Clyde Canal, which connects with the Clyde at Bowling, and was opened for traffic in 1775, pass through the shire. There is regular steamer communication between Glasgow and the towns and villages on the coast, and on Loch Lomond steamers call at several points between Balloch and Ardlui.

Population and Government.—The population of Dumbartonshire in 1891 was 98,014 and in 1901 113,865, of whom 3101 spoke both Gaelic and English and 14 Gaelic only. The principal towns, with populations in 1901, are—Alexandria (8007), Bonhill (3333), Clydebank (21,591), Jamestown (19,985), Duntocher (2122), Helensburgh (8554), Dumbarton (2080), Kirkintilloch (11,681), Milngavie (3481), New Kilpatrick or Bearsden (2705) and Renton (5067). The county returns one member to parliament. Dumbarton, the county town, is the only royal burgh, and belongs to the Kilmarnock group of parliamentary burghs. The municipal and police burghs are Clydebank, Cove and Kilmcraggan, Dumbarton, Helensburgh, Kirkintilloch and Milngavie. Dumbartonshire forms a sheriffdom with the counties of Stirling and Clackmannan, and there is a resident sheriff-substitute at Dumbarton, who sits also at Kirkintilloch. The shire is under school-board jurisdiction, but there are several voluntary schools, besides St Peter's Roman Catholic College in New Kilpatrick. Science, art and technical classes are subsidized out of the whole of the county "residue" and, if necessary, out of part of the burgh "residue" also. Agricultural lectures and the travelling expenses and fees of county students at Glasgow Technical College are also paid for from the same source.

History.—The country is rich in antiquities connected with

the aborigines and also with the Romans. The Caledonians and Picts have left their traces in rude forts and tumuli, but of greater interest are remains in several places of the wall of Antoninus, built from the Forth to the Clyde, and running along the north of the detached portion of the shire and through the south-eastern corner of the county to Kilpatrick. Other Roman relics have been found at Duntocher, Cumbernauld and elsewhere. The shire forms part of the old Scottish territory of Lennox (*Levenachs*, "fields of the Leven"), which embraced the Vale of the Leven and the basin of Loch Lomond, or all modern Dumbartonshire, most of Stirling and parts of the shires of Renfrew and Perth. It gave the title of the earldom created in 1174 by William the Lion and of the dukedom conferred by Charles II. on his natural son, Charles, duke of Richmond and Lennox. In 1702 the Lennox estates were sold to the marquis of Montrose. The captive Wallace was conveyed in chains to Dumbarton Castle, whence he was taken to his death in London. Robert Bruce is said to have mustered his forces at Dullatur prior to the battle of Bannockburn, and died at Cardross Castle in 1329. The Covenanters in their flight from the bloody field of Kilsyth, where in 1645 Montrose had defeated them with great slaughter, made their way through the southern districts. When the Forth and Clyde Canal was being excavated swords, pistols, and other weapons dropped by the fugitives were found at Dullatur, together with skeletons of men and horses. In the Highland country the clans of Macgregor and Macfarlane made their home in the fastnesses, whence they descended in raids upon the cattle, the goods and sometimes the persons of their Lowland neighbours.

See J. Irving, *History of Dumbartonshire* (Dumbarton, 1860); *Book of Dumbartonshire* (Edinburgh, 1879); Sir W. Fraser, *Chiefs of Colquhoun* (Edinburgh, 1869); *The Lennox* (Edinburgh, 1874); D. Macleod, *Castle and Town of Dumbarton* (Dumbarton, 1877); *Dumbarton* (Dumbarton, 1884); *Dumbarton: Ancient and Modern* (Glasgow, 1893); *Ancient Records of Dumbarton* (Dumbarton, 1896); J. Glen, *History of Dumbarton* (Dumbarton, 1876).

DUMB WAITER, a small oblong or circular table to hold reserve plates, knives and forks, and other necessaries for a meal. This piece of furniture originated in England towards the end of the 18th century, and some exceedingly elegant examples were designed by Sheraton and his school. They were usually circular, with three diminishing tiers, sometimes surrounded by a continuous or interrupted pierced gallery in wood or brass. The smaller varieties are now much used in England for the display of small silver objects in drawing-rooms.

DUM-DUM, a town and cantonment in British India at the head of an administrative subdivision in the district of the Twenty-four Parganas, in the presidency division of Bengal, with a station on the Eastern Bengal railway, 4½ m. N.E. of Calcutta. It was the headquarters of the Bengal artillery from 1783 to 1853, when they were transferred to Meerut as a more central station; and its possession of a cannon foundry and a percussion-cap factory procured for it the name of the Woolwich of India. The barracks—still occupied by small detachments—are brick-built and commodious; and among the other buildings are St Stephen's Protestant church, a Roman Catholic chapel, a European and native hospital, a large bazaar and an English school. The population in 1901 of North Dum-Dum was 9916, and of South Dum-Dum 10,904. It was at Dum-Dum that the treaty of 1757 was signed by which the nawab of Bengal ratified the privileges of the English, allowed Calcutta to be fortified, and bestowed freedom of trade. On the 7th of December 1908 a serious explosion occurred by accident at the Dum-Dum arsenal, resulting in death or serious injury to about 50 native workmen.

At the Dum-Dum foundry the hollow-nosed "Dum-Dum" (Mark IV.) bullets were manufactured, the supposed use of which by the British during the Boer War caused considerable comment in 1899. Their peculiarity consisted in their expanding on

¹ The term "dumb," strictly meaning mute or destitute of speech (see *DRAF AND DUMB*), is applied in this and other analogous cases (e.g. dumb-bell, dumb-barge) as connoting the absence of some normal capacity in the term with which it is associated.

impact and thus creating an ugly wound, and they had been adopted in Indian frontier fighting owing to the failure of the usual type of bullets to stop the rushes of fanatical tribesmen. They were not, in fact, used during the Boer War. Other and improvised forms of expanding bullet were used in India and the Sudan, the commonest methods of securing expansion being to file down the point until the lead core was exposed and to make longitudinal slits in the nickel envelope. All these forms of bullet have come to be described colloquially, and even in diplomatic correspondence, as "dum-dum bullets," and their alleged use by Russian troops in the Russo-Japanese War of 1904-1905 formed the subject of a protest on the part of the Japanese government. The proposals made at the second Hague Conference to forbid the use of these bullets by international agreement were agreed to by all the powers except Great Britain and the United States.

DUMESNIL, MARIE FRANÇOISE (1713-1803), French actress, whose real name was Marchand, was born in Paris on the 2nd of January 1713. She began her stage career in the provinces, whence she was summoned in 1737 to make her *début* at the Comédie Française as Clytemnestre in *Iphigénie en Tauride*. She at once came into the front rank, playing Cléopâtre, Phèdre, Athalie and Hermione with great effect, and when she created *Mérope* (1743) Voltaire says that she kept the audience in tears for three successive acts. She retired from the stage in 1776, but lived until the 20th of February 1803. Her rival, Clairon, having spoken ill of her, she authorized the publication of a *Mémoire de Marie Françoise Dumesnil, en réponse aux mémoires d'Hippolyte Clairon* (1800).

DUMFRIES (Gaelic, "the fort in the cope"), a royal and parliamentary burgh and capital of the county, Dumfriesshire, Scotland. It lies on the left bank of the Nith, about 8 m. from the Solway Firth and 81 m. S.E. of Glasgow by the Glasgow & South-Western railway. Pop. (1891) 16,675; (1901) 17,079. Dumfries is beautifully situated and is one of the handsomest county towns in Scotland. The churches and chapels of the Presbyterian and other communions are, many of them, fine buildings. St Michael's (1746), a stately pile, was the church which Robert Burns attended, and in its churchyard he was buried, his remains being transferred in 1815 to the magnificent mausoleum erected in the south-east corner, where also lie his wife, Jean Armour, and several members of his family. The Gothic church of Greyfriars (1866-1867) occupies the site partly of a Franciscan monastery and partly of the old castle of the town. On the site of St Mary's (1837-1839), also Gothic, stood the small chapel raised by Christiana, sister of Robert Bruce, to the memory of her husband, Sir Christopher Seton, who had been executed on the spot by Edward I. St Andrew's (1811-1813), in the Romanesque style, is a Roman Catholic church, which also serves as the pro-cathedral of the diocese of Galloway.

Besides numerous schools, there is an admirably equipped Academy. The old infirmary building is now occupied by St Joseph's College, a commercial academy of the Marist Brotherhood, in connexion with which there is a novitiate for the training of members of the order for missionary service at home or abroad. In the middle of the market-place stands the old town hall, with red tower and cupola, known from its situation as the Mid Steeple, built by Tobias Bachup of Alloa (1708). The new town hall and post-office are near the uppermost bridge. The county buildings, in Buccleuch Street, are an imposing example of the Scots Baronial style. To Mr Andrew Carnegie and Mr and Mrs M'Kie of Moat House was due the free library. The charitable institutions include Moorhead's hospital (1753) for reduced householders; the Dumfriesshire and Galloway royal infirmary, dating from 1778, but now housed in a fine edifice in the northern Italian style; the Crichton royal institution for the insane, founded by Dr James Crichton of Friars Carse, and supplemented in 1848 by the Southern Counties asylum; the new infirmary, a handsome building; the contagious diseases hospital, the industrial home for orphan and destitute girls and a nurses' home. The Theatre Royal, reconstructed in 1876, dates

from 1787. Burns composed several prologues and epilogues for some of its actors and actresses. Among other public buildings are the assembly rooms, St George's hall, the volunteer drill hall, and the Crichton Institution chapel, completed at a cost of £30,000. The corporation owns the water supply, public baths and wash-houses and the gasworks. In front of Greyfriars church stands a marble statue of Burns, unveiled in 1882, and there is also a monument to Charles, third duke of Queensberry. The Nith is crossed by three bridges and the railway viaduct. The bridge, which is used for vehicular traffic, dates from 1790-1794. Devorgilla's bridge, below it, built of stone in 1280, originally consisted of nine arches (now reduced to three), and is reserved in spite of its massive appearance for foot passengers only, as is also the suspension bridge opened in 1875.

Dumfries, Annan, Kirkcudbright, Lochmaben and Sanquhar—the "Five Carlins" of Burns's Election Ballads—combine to return one member to Parliament. As a parliamentary burgh Dumfries includes Maxwelltown, on the opposite side of the river, which otherwise belongs to Kirkcudbrightshire.

The leading industries comprise manufactures of tweeds, hosiery, clogs, baskets and leather, besides the timber trade, nursery gardening and the making of machinery and iron implements. Dumfries markets for cattle and sheep, held weekly, and for horses, held five times annually, have always ranked with the best, and there is also a weekly market for pork during the five months beginning with November. The sea-borne trade is small compared with what it was before the railway came.

Although Dumfries was the site of a camp of the Selgovia Britons, nothing is known of its history until long after the withdrawal of the Romans. William the Lion (d. 1214) made it a royal burgh, but the oldest existing charter was granted by Robert II. in 1395. The town became embroiled in the struggles that ended in the independence of Scotland. It favoured the claims to the throne, first of John Balliol—whose mother Devorgilla, daughter of Alan, lord of Galloway, had done much to promote its prosperity by building the stone bridge over the Nith—and then of the Red Comyn, as against those of Robert Bruce, who drew his support from Annandale. When Edward I. besieged Carlaverock Castle in 1300 he lodged in the Franciscan monastery, which, six years later (10th of February 1306), was the scene of the murder of Comyn (see ROBERT THE BRUCE). From this time to nearly the close of the 16th century the burgh was exposed to frequent raids, both from freebooters on the English side and from partisans of the turbulent chiefs—Douglases, Maxwells, Johnstones. The Scottish sovereigns, however, did not wholly neglect Dumfries. James IV., James V., Mary and her son each visited it. James VI. was royally entertained on the 3rd of August 1617, and afterwards presented the seven incorporated trades with a silver gun to encourage the craftsmen in the practice of musketry. The competition for this cannon-shaped tube, now preserved in the old town hall, took place annually—with a great festival every seven years—until 1831. John Mayne (1759-1836), a native of Dumfries, commemorated the gathering in an excellent humorous poem called "The Siller Gun." Though in sympathy with the Covenanters, the town was the scene of few incidents comparable to those which took place in the northern parts of the shire. The Union with England was so unpopular that not only did the provost vote against the measure in the Scottish parliament, but the articles were burned (20th of November 1706) at the Market Cross by a body of Cameronians, amidst the approving cheers of the inhabitants. In both 1715 and 1745 Dumfries remained apathetic. Prince Charles Edward indeed occupied the town, holding his court in a building afterwards known as the Commercial Hotel, levying £2000 tribute money and requisitioning 1000 pairs of shoes for his Highlanders, by way of punishing its contumacy. But, in a false alarm, the Jacobites suddenly retreated, and a few years later the town was reimbursed by the State for the Pretender's extortions. The most interesting event in the history of Dumfries is its connexion with Burns, for the poet resided here from December 1791 till his death on the 21st of July 1796. The house in which he died is still standing.

The picturesque ruins of Carliaverock Castle—the "Ellan-gowan" of *Guy Mannering*—are 8 m. to the south. Above the entrance are the arms of the Maxwells, earls of Nithsdale, to whose descendant, the duchess of Norfolk, it belongs. The castle, which is in an excellent state of preservation, is built of red sandstone, on the site of a fortress supposed to have been erected in the 6th century, of which nothing now remains. In plan it is a triangle, protected by a double moat, and has round towers at the angles. Part of the present structure is believed to date from 1220 and once sheltered William Wallace. It withstood Edward I.'s siege in 1300 for two days, although garrisoned by only sixty men. In the troublous times that followed it often changed hands. In 1570 it fell into disrepair, but was restored, and in 1641 was besieged for the last time by the Covenanters.

A mile and a half to the north-west of Dumfries lies Lincluden Abbey, "an old ruin," says Burns, "in a sweet situation at the confluence of the Cluden and the Nith." Originally the abbey was a convent, founded in the 12th century, but converted two centuries later into a collegiate church by Archibald, earl of Douglas. The remains of the choir and south transept disclose rich work of the Decorated style.

DUMFRIESHIRE, a border county of Scotland, bounded S. by the Solway Firth, S.E. by Cumberland, E. by Roxburghshire, N. by the shires of Lanark, Peebles and Selkirk, and W. by Ayrshire and Kirkcudbrightshire. Its area is 686,302 acres or 1072 sq. m. The coast line measures 21 m. The county slopes very gradually from the mountainous districts in the north down to the sea, lofty hills alternating in parts with stretches of tableland or rich fertile holms. At various points within a few miles of the Solway are tracts of moss land, like Craigs Moss, Lochar Moss and Longbridge Moor in the west, and Nutberry Moss in the east, all once under water, but now largely reclaimed. The principal mountains occur near the northern boundaries, the highest being White Coomb (2695 ft.), Hart Fell (2651), Saddle Yoke (2412), Swatte Fell (2389), Lowther Hills (2377), Queensberry (2285), which gives his secondary title to the duke of Buccleuch and the title of marquis to a branch of the house of Douglas, and Ettrick Pen (2269). The three longest rivers are the Nith, the Annan and the Esk, the basins of which form the great dales by which the county is cleft from north to south—Nithsdale, Annandale and Eskdale. From the point where it enters Dumfriesshire, 16 m. from its source near Enoch Hill in Ayrshire, the course of the Nith is mainly south-easterly till it enters the Solway, a few miles below Dumfries. Its total length is 65 m., and its chief affluents are, on the right, the Kello, Euchan, Scar, Cluden and Cargen, and, on the left, the Crawick, Carron and Campie. The Annan rises near the Devil's Beef Tub, a remarkable chasm in the far north, and after flowing about 40 m., mainly in a southerly course, it enters the Solway at Barnkirk headland. It receives, on the right, the Kinnel (reinforced by the Ae), and, on the left, the Moffat, the Dryfe and the Milk. From the confluence of the White Esk (rising near Ettrick Pen) and the Black Esk (rising near Jock's Shoulder, 1754 ft.) the Esk flows in a gradually south-easterly direction till it crosses the Border, whence it sweeps to the S.W. through the extreme north-western territory of Cumberland and falls into the Solway. Of its total course of 42 m., 12 belong to the White Esk, 20 are of the Esk proper on Scottish soil and 10 are of the stream in its English course. On the right the Wauchope is the chief affluent, and on the left it receives the Megget, Ewes, Tarras and Line—the last being an English tributary. Other rivers are the Lochar (18 m.), the Kirtle (17) and the Sark (12), all flowing into the Solway. For one mile of its course the Esk, and for 7 m. of its course the Sark, form the boundaries between Dumfriesshire and Cumberland. Loch Skene in the north (1750 ft. above the sea), the group of lochs around Lochmaben, and Loch Urr in the west, only part of which belongs to Dumfriesshire, are the principal lakes. There are few glens so named in the shire, but the passes of Dalveen, Enterkin and Menock, leading up from Nithsdale to the Lowther and other hills, yield to few glens in Scotland in the wild grandeur of their scenery. For part of the way Enterkin Pass runs

between mountains rising sheer from the burn to a height of nearly 2000 ft. Loch Skene finds an outlet in Tail Burn, the water of which at a short distance from the lake leaps from a height of 200 ft. in a fine waterfall, known as the Grey Mare's Tail. A much smaller but picturesque fall of the same name, also known as Crichope Linn, occurs on the Crichope near Thornhill. Mineral waters are found at Moffat, Hartfell Spa, some three miles farther north, Closeburn and Brown on the Solway.

Geology.—The greater portion of the county of Dumfries belongs to the Silurian tableland of the south of Scotland which contains representatives of all the divisions of that system from the Arenig to the Ludlow rocks. By far the largest area is occupied by strata of Tarannon and Llandovery age which cover a belt of country from 20 to 25 m. across from Drumlanrig Castle in the north to Torthrowald in the south. Consisting of massive grits, sometimes conglomeratic, greywacks, flags and shales, these beds are repeated by innumerable folds frequently inverted, striking N.E. and S.W. and usually dipping towards the N.W. In the midst of this belt there are lenticular bands of older strata of Arenig, Llandoilo, Caradoc and Llandovery age composed of fine sediments such as cherts, black and grey shales, white clays and flags, which come to the surface along anticlinal folds and yield abundant graptolites characteristic of these divisions. These black shale bands are typically developed in Moffatdale; indeed the three typical sections chosen by Professor Lapworth to illustrate his three great groups—(1) the Glenkiln shales (Lower Llandoilo), (2) the Hartfell shales (Caradoc), (3) Birkhill shales (Upper Llandoilo)—occur respectively in the Glenkiln Burn north of Kirkmichael, on Hartfell and in Dobbs Linn near St Mary's Loch in the basin of the river Annan. In the extreme N.W. of the county between Drumlanrig Castle and Dalveen Pass in the S. and the Spango and Kello Waters on the N., there is a broad development of Arenig, Llandoilo and Caradoc strata, represented by Radiolarian cherts, black shales, grits, conglomerates, greywacks and shales which rise from underneath the central Tarannon belt and are repeated by innumerable folds. In the cores of the arches of Arenig cherts there are diabase lavas, tuffs and agglomerates which are typically represented on Bail Hill E. of Kirkcubbin. Along the southern margin of the Tarannon belt, the Wenlock and Ludlow rocks follow in normal order, the boundary between the two being defined by a line extending from the head of the Ewes Water in Eskdale, S.W. by Lockertie to Mouswald. These consist of greywacks, flags and shales with bands of dark graptolite shales, the finer sediments being often well cleaved. They are likewise repeated by inverted folds, the axial planes being usually inclined to the S.E. The Silurian tableland in the N.W. of the county is pierced by intrusive igneous rocks in the form of dikes and bosses, which are regarded as of Lower Old Red Sandstone age. Of these, the granite mass of Spango Water, N.E. of Kirkcubbin, is an excellent example. Along the N.W. margin of the county, on the N. side of the fault bounding the Silurian tableland, the Lower Old Red Sandstone occurs, where it consists of sandstones and conglomerates associated with contemporaneous volcanic rocks. The Upper Old Red Sandstone forms a narrow strip on the south side of the Silurian tableland, resting unconformably on the Silurian rocks and passing upwards into the Carboniferous formation. It stretches from the county boundary E. of the Ewes Water, S.W. by Langholm to Birrenswark. Along this line these Upper Red sandstones and shales are overlaid by a thin zone of volcanic rocks which point to contemporaneous volcanic action in this region at the beginning of the Carboniferous period. Some of the vents from which these igneous materials may have been discharged are found along the watershed between Liddesdale and Teviotdale in Roxburghshire. The strata of Carboniferous age are found in three areas: (1) between Sanquhar and Kirkcubbin, (2) at Closeburn near Thornhill, (3) in the district between Liddesdale and Ruthwell. In the first two instances (Sanquhar and Thornhill) the Carboniferous sediments lie in hollows worn out of the old Silurian tableland. In the Sanquhar basin the strata belong to the Coal Measures, and include several valuable coal-seams which are probably the southern prolongations of the members of this division in Ayrshire. At the S.E. limit of the Sanquhar Coalfield there are patches of the Carboniferous Limestone series, but towards the N. these are overlapped by the Coal Measures which thus rest directly on the Silurian platform. At Closeburn and Barjarg there are beds of marine limestone, associated with sandstones and shales which probably represent marine bands in the Carboniferous Limestone series. The most important development of Carboniferous strata occurs between Liddesdale and Ruthwell. In the valleys of the Liddel and the Esk the following zones are represented, which are given in ascending order: (1) The Whita Sandstone, (2) the Cementstone group, (3) the Fell Sandstones, (4) the Glencartholm volcanic group, (5) Marine limestone group with Coal-seams, (6) Millstone Grit, (7) Rowanburn coal group, (8) Byreburn coal group, (9) Red Sandstones of Canobie yielding plants characteristic of the Upper Coal Measures. The coal-seams of the Rowanburn field have been chiefly wrought, and in view of their exhaustion bores have been sunk to prove the coals

beneath the red sandstone of upper Carboniferous age. From a palaeontological point of view the Glencartholm volcanic zone is of special interest, as the calcareous shale associated with the tuffs has yielded a large number of new species of fishes, decapod crustaceans, phylloids and scorpions. The Triassic rocks rest unconformably on all older formations within the county. In the tract along the Solway Firth they repose on the folded and eroded edges of the Carboniferous strata, and when traced westwards to the Dumfries basin they rest directly on the Silurian platform. They occur in five areas, (1) between Annan and the mouth of the Esk, (2) the Dumfries basin, (3) the Thornhill basin, (4) at Lochmaben and Corncockle Moor, (5) at Moffat. The strata consist of breccias, false-bedded sandstones and marls, the sandstones being extensively quarried for building purposes. In the sandstones of Corncockle Moor reptilian footprints have been obtained. In the Thornhill basin there is a thin zone of volcanic rocks at the base of this series which are evidently on the horizon of the lavas beneath the Mauchline sandstones in Ayrshire. In the Sanquhar basin there are small outliers of lavas probably of this age and several vents filled with agglomerate from which these igneous materials in the Thornhill basin may have been derived. There are several striking examples of basalt dikes of Tertiary age, one having been traced from the Lead Hills south-east by Moffat, across Eskdalemuir to the English border.

Climate and Industries.—The climate is mild, with a mean yearly temperature of 48° F. (January, 38.5°; July, 59.5°), and the average annual rainfall is 53 ins. Towards the middle of the 18th century farmers began to raise stock for the south, and a hundred years later 20,000 head of heavy cattle were sent annually to the English markets. The Galloways, which were the breed in vogue at first, have been to a large extent replaced by shorthorns and Ayrshire dairy cattle. Sheep breeding, of later origin, has attained to remarkable dimensions, the walks in the higher hilly country being given over to Cheviots, and the richer pasture of the low-lying farms being reserved for half-bred lambs, a cross of Cheviots and Leicesters or other long-wooled rams. Pig-feeding, once important, has declined before the imports of bacon from foreign countries. Horse-breeding is pursued on a considerable scale. Grain crops, of which oats are the principal, show a downward tendency. Arable farms range from 100 acres to 300 acres, and pastoral from 300 to 3000 acres.

In general the manufactures are only of local importance and mostly confined to Dumfries and a few of the larger towns. Langholm is famous for its tweeds; breweries and distilleries are found at Annan, Sanquhar and elsewhere; some shipping is carried on at Annan and Dumfries; and the salmon fisheries of the Nith and Annan and the Solway Firth are of value.

Communications.—The Glasgow & South-Western railway from Glasgow to Carlisle runs through Nithsdale, practically following the course of the river, and lower Annandale to the Border. The Caledonian railway runs through Annandale, throwing off at Beattock a small branch to Moffat, at Lockerbie a cross-country line to Dumfries, and at Kirtlebridge a line that ultimately crosses the Solway to Bowness. From Dumfries westwards there is communication with Castle Douglas, Kirkcudbright, Newton Stewart, Stranraer and Portpatrick. The North British railway sends a short line to Langholm from Riddings Junction in Cumberland, giving access to Carlisle and, by the Waverley route, to Edinburgh. There is also coach service between various points, as from Dumfries to New Abbey and Dalbeattie, and from Langholm to Eskdalemuir.

Population and Government.—The population in 1891 was 74,245, and in 1901, 72,571, when there were 176 persons who spoke Gaelic and English. The chief towns are Annan (pop. in 1901, 4300), Dumfries (14,444), Langholm (3142), Lockerbie (2358) and Moffat (2153). The county returns one member to parliament. Dumfries, the county town, Annan, Lochmaben and Sanquhar are royal burghs; Dumfries forms a sheriffdom with the shires of Kirkcudbright and Wigton, and there is a resident sheriff-substitute at Dumfries, who sits also at Annan, Langholm and Lockerbie. The shire is under school-board jurisdiction, and some of the public schools earn grants for higher education. The county council and most of the borough councils give the bulk of the "residue" grant to the county committee on secondary education, which is thus enabled,

besides assisting building schemes, to subsidize high schools, to provide bursaries and apparatus, and to carry on science and technical classes, embracing agriculture, dairying (at Kilmarnock Dairy school) and practical chemistry. There are academies at Dumfries, Annan, Moffat and other centres.

History.—The British tribe which inhabited this part of Scotland was called by the Romans Selgovae. They have left many signs of their presence, such as hill forts in the north, stone circles (as in Dunscore and Eskdalemuir), camps (Dryfesdaie), tumuli and cairns (Closeburn), and sculptured stones (Dornock). The country around Moffat especially is rich in remains. At Holywood, near Dumfries, there stand the relic of the grove of sacred oaks from which the place derived its name, and a stone circle known locally as the Twelve Apostles. In the parish church of Ruthwell (pron. Rivvel: the "rood, or cross, well") is preserved an ancient cross which tells in Runic characters the story of the Crucifixion. There are traces of the Roman roads which ran by Dalveen Pass into Clydesdale and up the Annan to Tweeddale, and at Birrens is one of the best-preserved examples of a Roman camp. Roman altars, urns and coins are found in many places. Upon the withdrawal of the Romans, the Selgovae were conquered by Scots from Ireland, who, however, fused with the natives. The Saxon conquest of Dumfriesshire does not seem to have been thorough, the people of Nithsdale and elsewhere maintaining their Celtic institutions up to the time of David I.

As a Border county Dumfriesshire was the scene of stirring deeds at various epochs, especially in the days of Robert Bruce. Edward I. besieged Carlaverock Castle, and the factions of Bruce (who was lord of Annandale), John Comyn and John Baliol were at constant feud. The Border clans, as haughty and hot-headed as the Gaels farther north, were always at strife. There is record of a bloody fight in Dryfesdaie in 1593, when the Johnstones slew 700 Maxwells, and, overtaking the fugitives at Lockerbie, there massacred most of the remnant. These factions embroiled the dalesmen until the 18th century. The highlands of the shire afforded retreat to the persecuted Covenanters, who, at Sanquhar, published in 1680 their declaration against the king, anticipating the principles of the "glorious Revolution" by several years. Prince Charles Edward's ambition left the shire comparatively untouched, for the Jacobite sentiment made little appeal to the people.

Dumfriesshire is inseparably connected with the name of Robert Burns, who farmed at Ellisland on the Nith for three years, and spent the last five years of his life at Dumfries. Thomas Carlyle was born at Ecclefechan, in a house still standing, and was buried beside his parents in the kirkyard of the old Secession church (now the United Free). His farm of Craigenputtock was left to Edinburgh University in order to found the John Welsh bursaries in classics and mathematics.

See W. M'Dowall, *History of the Burgh of Dumfries* (Edinburgh, 1887); Sir Herbert Maxwell, *Dumfries and Galloway* (Edinburgh and London, 1897); J. Macdonald and J. Barbour, *Burns and his Antiquities* (Dumfries, 1897); Sir William Fraser, *The Book of Carlaverock* (Edinburgh, 1873); *The Douglas Book* (Edinburgh, 1885); *The Annandale Book* (Edinburgh, 1894); G. Neilson, *Annandale under the Bruces* (Annan, 1887); C. T. Ramage, *Dumlanrig Castle and the Douglases* (Dumfries, 1876).

DÜMICHEN, JOHANNES (1833-1894), German Egyptologist, was born near Grossglogau. He studied philology and theology in Berlin and Breslau. Subsequently he became a pupil of Lepsius and Brugsch, and devoted himself to the study of Egyptian inscriptions. He travelled widely in Egypt, and published his results in a number of important books. In 1872 he was chosen professor of Egyptology at Strassburg. The value of his work consists not only in the stores of material which he collected, but also in the success with which he dealt with many of the problems raised by the inscriptions.

Among his works are *Bauwerkunde des Tempels von Dendera* (1865); *Geographische Inschriften altägyptischer Denkmäler* (4 vols., 1865-1885); *Altägyptische Kalenderschriften* (1866); *Altägypt. Tempelschriften* (2 vols., 1867); *Historische Inschriften altägypt. Denkmäler* (2 vols., 1867-1869); *Baugeschichte und Beschreibung des Denderatempels* (Strassburg, 1877); *Die Oasen der libyischen*

Wäste (1878); *Die halendrischen Opferfesten von Medinet-Habu* (1881); *Gesch. des alten Aegypten* (1878-1883); *Der Grabpalast des Patamenap in der thebanischen Nekropolis* (1884-1894).

DÜMMLER, ERNST LUDWIG (1830-1902), German historian, the son of Ferdinand Dümmler (1777-1846), a Berlin bookseller, was born in Berlin, on the 2nd of January 1830. He studied at Bonn under J. W. Löbell (1786-1863), under L. von Ranke and W. Wattenbach, and his doctor's dissertation, *De Arnulfo Francorum rege* (Berlin, 1852), was a notable essay. He entered the faculty at Halle in 1855, and started an historical *Seminar*. In 1858 he became professor extraordinary, in 1866 full professor. In 1875 he became a member of the revised committee directing the *Monumenta Germaniæ historica*, himself undertaking the direction of the section *Antiquitates*, and in 1888 became president of the central board in Berlin. This was an official recognition of Dümmler's leading position among German historians. In addition to numerous critical works and editions of texts, he published *Pilgrim von Passau und das Erzbistum Lorch* (1854), *Über die älteren Slaven in Dalmatien* (1856), *Das Formelbuch des Bischofs Salomo III. von Konstanz* (1857) and *Anselm der Peripatetiker* (1872). But his great work was the *Geschichte des ostfränkischen Reiches* (Berlin, 1862-1865, in 2 vols.; 2nd ed. 1887-1888, in 3 vols.). In conjunction with Wattenbach he completed the *Monumenta Alcuiniana* (Berlin, 1873), which had been begun by Philipp Jaffé, and with R. Köpke he wrote *Kaiser Otto der Grosse* (Leipzig, 1876). He edited the first and second volumes of the *Poetæ latini ævi Carolini* for the *Monumenta Germaniæ historica* (Berlin, 1881-1884). Dümmler died in Berlin on the 11th of September 1902.

His son, Ferdinand (1859-1896), who won some reputation as an archaeologist and philologist, was professor at the university of Basel from 1890 until his death on the 15th of November 1896.

DUMONT, the name of a family of prominent French artists. François Dumont (1688-1726), a sculptor, best known for his figures in the church of Saint Sulpice, Paris, was the brother of the painter Jacques Dumont, known as "le Romain" (1701-1781), whose chief success was gained with a great allegorical composition for the Paris *hôtel-de-ville* in 1761. François's son Edme (1720-1775), the latter's son Jacques Edme (1761-1844), and the last-named's son Augustin Alexander (1801-1884) were also famous sculptors.

See G. Vattier, *Une Famille d'artistes* (1890).

DUMONT, ANDRÉ HUBERT (1809-1857), Belgian geologist, was born at Liège on the 15th of February 1809. His first work was a masterly *Mémoire* on the geology of the province of Liège published in 1832. A few years later he became professor of mineralogy and geology and afterwards rector in the university of Liège. His attention was now given to the mineralogical and stratigraphical characters of the geological formations in Belgium—and the names given by him to many subdivisions of Cretaceous and Tertiary ages have been adopted. His *Mémoire sur les terrains ardennais et rhénan de l'Ardenne, du Brabant et du Condras* (1847-1848) is notable for the care with which the mineral characters of the strata were described, but the palæontological characters were insufficiently considered, and neither the terms "Silurian" nor "Devonian" were adopted. During twenty years he laboured at the preparation of a geological map of Belgium (1849). He spared no pains to make his work as complete as possible, examining on foot almost every area of importance in the country. Journeying to the more southern parts of Europe, he investigated the shores of the Bosphorus, the mountains of Spain and other tracts, and gradually gathered materials for a geological map of Europe: a work of high merit which was "one of the first serious attempts to establish on a larger scale the geological correlation of the various countries of Europe." The Geological Society of London awarded him in 1840 the Wollaston medal. He died at Liège on the 28th of February 1857.

See *Mémoir* by Major-General J. E. Portlock in *Address to Geol. Soc.* (London, 1858).

¹ Not to be confounded with his contemporary Jean Joseph Dumons (1687-1779), sometimes called Dumont, best known for his designs for the Aubusson tapestries.

DUMONT, FRANÇOIS (1751-1831), French miniature painter was born at Lunéville (Meurthe), and was left an orphan when quite young, with five brothers and sisters to support. He was for a while a student under Jean Girardet, and then, on the advice of a Lunéville Academician, Madame Coster, set up a studio for himself. In 1784 he journeyed to Rome, returning after four years' careful study, and in 1788 was accepted as an Academician and granted an apartment in the Louvre. He married the daughter of Antoine Vestier, the miniature painter, and had two sons, Aristide and Bias, both of whom became painters. He was one of the three greatest miniature painters of France, painting portraits of Louis XVI. and Marie Antoinette, Louis XVIII. and Charles X., and of almost all the important persons of his day. His own portrait was engraved both by Audouin and by Tardieu. He resided the greater part of his life in Paris, and there he died. A younger brother, known as Tony Dumont, was also a miniature painter, a pupil of his brother, a frequent exhibitor and the recipient of a medal from the Academy in 1810. Each artist signed with the surname only, and there is some controversy concerning the attribution to each artist of his own work. Tony was an expert violinist and delighted in painting portraits of persons who were playing upon the violin. Many of Dumont's finest paintings came into the collection of Mr J. Pierpont Morgan, but others are in the Louvre, presented by the heir of Bias Dumont. The work of both painters is distinguished by breadth, precision and a charming scheme of colouring, and the unfinished works of the elder brother are amongst some of the most beautiful miniatures ever produced.

See *The History of Portrait Miniatures*, by G. C. Williamson (London, 1904); also the privately printed *Catalogue of the Collection of Miniatures of Mr J. Pierpont Morgan*, vol. iv. (G. C. W.)

DUMONT, JEAN (d. 1726), French publicist, was born in France in the 17th century, the precise date being unknown. He followed the profession of arms; but, not obtaining promotion so rapidly as he expected, he quitted the service and travelled through different parts of Europe. He stopped in Holland with the intention of publishing an account of his travels. But in the interval, at the request of his bookseller, he wrote and published several pamphlets, which were eagerly sought after, owing to the unceremonious manner in which he treated the ministry of France. This freedom having deprived him of all hope of employment in his own country, he thought of forming a permanent establishment in that where he resided, and accordingly commenced a course of lectures on public law. The project succeeded far beyond his expectations; and some useful compilations which he published about the same period made him favourably known in other countries. The emperor appointed him his historiographer, and some time afterwards conferred on him the title of baron de Carlsroon. He died at Vienna in 1726, at an advanced age.

The following is a list of his publications—(1) *Voyages en France, en Italie, en Allemagne, à Malte, et en Turquie* (Hague, 1699, 4 vols. 12mo); (2) *Mémoires politiques pour servir à la parfaite intelligence de l'histoire de la Paix de Ryswick* (Hague, 1699, 4 vols. 12mo); (3) *Recherches modestes des causes de la présente guerre, en ce qui concerne les Provinces Unies* (1713, 12mo); (4) *Récueil de traités d'alliance, de paix, et de commerce entre les rois, princes, et états, depuis la Paix de Munster* (Amsterdam, 1710, 2 vols. 12mo); (5) *Soupirs de l'Europe à la vue du projet de paix contenu dans la harangue de la reine de la Grande-Bretagne* (1712, 12mo); (6) *Corps universel diplomatique du droit des gens, contenant un recueil des traités de paix, d'alliance, &c., faits en Europe, depuis Charlemagne jusqu'à présent* (Amsterdam, 1626, and following years, 8 vols. fol., continued after Dumont's death by J. Rousselet); and (7) *Batailles gagnées par le Prince Eugène de Savoie* (Hague, 1723). Dumont was also the author of *Lectures historiques contenant ce qui se passe de plus important en Europe* (12mo). This periodical, which was commenced in 1692, two volumes appearing annually. Dumont conducted till 1710, from which time it was continued by Basnage and others until 1728. The earlier volumes are much prized.

DUMONT, PIERRE ÉTIENNE LOUIS (1759-1829), French political writer, was born on the 18th of July 1759 at Geneva, of which his family had been citizens of good repute from the days of Calvin. He was educated for the ministry at the college of Geneva, and in 1781 was chosen one of the pastors of the city. The political troubles which disturbed Geneva in 1782, however

suddenly turned the course of his life. He belonged to the liberals or democrats, and the triumph of the aristocratic party, through the interference of the courts of France and Sardinia, made residence in his native town impossible, though he was not among the number of the proscribed. He therefore went to join his mother and sisters at St Petersburg. In this he was probably influenced in part by the example of his townsman Pierre Lefort, the first tutor, minister, and general of the tsar. At St Petersburg he was for eighteen months pastor of the French church. In 1785 he removed to London, Lord Shelburne, then a minister of state, having invited him to undertake the education of his sons. It was at the house of Lord Shelburne, now 1st marquess of Lansdowne, where he was treated as a friend or rather member of the family, that he became acquainted with many illustrious men, amongst others Fox, Sheridan, Lord Holland and Sir Samuel Romilly. With the last of these he formed a close and enduring friendship, which had an important influence on his life and pursuits.

In 1788 Dumont visited Paris with Romilly. During a stay of two months in that city he had almost daily intercourse with Mirabeau, and a certain affinity of talents and pursuits led to an intimacy between two persons diametrically opposed to each other in habits and in character. On his return from Paris Dumont made the acquaintance of Jeremy Bentham. Filled with admiration for the genius of Bentham, Dumont made it one of the chief objects of his life to recast and edit the writings of the great English jurist in a form suitable for the ordinary reading public. This literary relationship was, according to Dumont's own account, one of a somewhat peculiar character. All the fundamental ideas and most of the illustrative material were supplied in the manuscripts of Bentham; Dumont's task was chiefly to abridge by striking out repeated matter, to supply lacunae, to secure uniformity of style, and to improve the French. The following works of Bentham were published under his editorship: *Traité de législation civile et pénale* (1802), *Théorie des peines et des récompenses* (1811), *Tactique des assemblées législatives* (1815), *Traité des preuves judiciaires* (1823) and *De l'organisation judiciaire et de la codification* (1828).

In the summer of 1789 Dumont went to Paris. The object of the journey was to obtain through Necker, who had just returned to office, an unrestricted restoration of Genevese liberty, by cancelling the treaty of guarantee between France and Switzerland, which prevented the republic from enacting new laws without the consent of the parties to this treaty. The proceedings and negotiations to which this mission gave rise necessarily brought Dumont into connexion with most of the leading men in the Constituent Assembly, and made him an interested spectator, sometimes even a participator, indirectly, in the events of the French Revolution. The same cause also led him to renew his acquaintance with Mirabeau, whom he found occupied with his duties as a deputy, and with the composition of his journal, the *Courier de Provence*. For a time Dumont took an active and very efficient part in the conduct of this journal, supplying it with reports as well as original articles, and also furnishing Mirabeau with speeches to be delivered or rather read in the assembly, as related in his highly instructive and interesting posthumous work entitled *Souvenirs sur Mirabeau* (1832). In fact his friend George Wilson used to relate that one day, when they were dining together at a *table d'hôte* at Versailles, he saw Dumont engaged in writing the most celebrated paragraph of Mirabeau's address to the king for the removal of the troops. He also reported such of Mirabeau's speeches as he did not write, embellishing them from his own stores, which were inexhaustible. But this co-operation soon came to an end; for, being attacked in pamphlets as one of Mirabeau's writers, he felt hurt at the notoriety thus given to his name in connexion with a man occupying Mirabeau's peculiar position, and returned to England in 1791.

In 1801 he travelled over various parts of Europe with Lord Henry Petty, afterwards 3rd marquess of Lansdowne, and on his return settled down to the editorship of the works of Bentham already mentioned. In 1814 the restoration of Geneva to in-

dependence induced Dumont to return to his native place, and he soon became the leader of the supreme council. He devoted particular attention to the judicial and penal systems of his native state, and many improvements on both are due to him. He died at Milan when on an autumn tour on the 29th of September 1829.

DUMONT D'URVILLE, JULES SÉBASTIEN CÉSAR (1790-1842), French navigator, was born at Condé-sur-Noireau, in Normandy, on the 23rd of May 1790. The death of his father, who before the revolution had held a judicial post in Condé, devolved the care of his education on his mother and his maternal uncle, the Abbé de Croizilles. Failing to pass the entrance examination for the Ecole Polytechnique, he went to sea in 1807 as a *novice* on board the "Aquilon." During the next twelve years he gradually rose in the service, and added a knowledge of botany, entomology, English, German, Spanish, Italian and even Hebrew and Greek to the professional branches of his studies. In 1820, while engaged in a hydrographic survey of the Mediterranean, he was fortunate enough to recognize the Venus of Milo (Melos) in a Greek statue recently unearthed, and to secure its preservation by the report he presented to the French ambassador at Constantinople. A wider field for his energies was furnished in 1822 by the circumnavigating expedition of the "Coquille" under the command of his friend Duperrey; and on its return in 1825 his services were rewarded by promotion to the rank of *capitaine de frégate*, and he was entrusted with the control of a similar enterprise, with the especial purpose of discovering traces of the lost explorer La Pérouse, in which he was successful. The "Astrolabe," as he renamed the "Coquille," left Toulon on the 25th of April 1826, and returned to Marseilles on the 25th of March 1829, having traversed the South Atlantic, coasted the Australian continent from King George's Sound to Port Jackson, charted various parts of New Zealand, and visited the Fiji Islands, the Loyalty Islands, New Caledonia, New Guinea, Amboyna, Van Diemen's Land, the Caroline Islands, Celebes and Mauritius. Promotion to the rank of *capitaine de vaisseau* was bestowed on the commander in August 1829; and in August of the following year he was charged with the delicate task of conveying the exiled king Charles X. to England. His proposal to undertake a voyage of discovery to the south polar regions was discouraged by Arago and others, who criticized the work of the previous expedition in no measured terms; but at last, in 1837, all difficulties were surmounted, and on the 7th of September he set sail from Toulon with the "Astrolabe" and its convoy "La Zélée." On the 15th of January 1838 they sighted the Antarctic ice, and soon after their progress southward was blocked by a continuous bank, which they vainly coasted for 300 m. to the east. Returning westward they visited the South Orkney Islands and part of the New Shetlands, and discovered Joinville Island and Louis Philippe Land, but were compelled by scurvy to seek succour at Talcahuano in Chile. Thence they proceeded across the Pacific and through the Asiatic archipelago, visiting among others the Fiji and the Pelew Islands, coasting New Guinea, and circumnavigating Borneo. In 1840, leaving their sick at Hobart Town, Tasmania, they returned to the Antarctic region, and on the 21st of the month were rewarded by the discovery of Adélie Land, which D'Urville named after his wife, in 140° E. The 6th of November found them at Toulon. D'Urville was at once appointed *contre-amiral*, and in 1841 he received the gold medal of the Société de Géographie. On the 8th of May 1842 he was killed, with his wife and son, in a railway accident near Meudon.

His principal works are—*Enumeratio plantarum quas in insulis Archipelagi aut littoribus Ponti Euxini*, &c. (1822); *Voyage de la corvette "Astrolabe," 1826-1829* (Paris, 1830-1835), and *Voyage au pôle sud et dans l'Océanie, 1837-1840* (Paris, 1841-1854), in each of which his scientific colleagues had a share; *Voyages autour du monde; résumé général des voyages de Magellan*, &c. (Paris, 1833 and 1844). An island (also called Kairu) of the north coast of New Guinea, and a cape on the same coast, bear the name of D'Urville.

DUMORTIERITE, a mineral described in 1881 by M. F. Gonard, who named it after Eugène Dumortier, a palaeontologist of Lyons, France. It is essentially a basic aluminium borosilicate, belonging to the orthorhombic system; it occurs usually in fibrous forms, of smalt-blue, greenish-blue, lavender or almost black colour, and exhibits strong pleochroism. According to W. T. Schaller (*Amer. Journ. Sci.*, 1905 (iv.), 19, p. 211) a purple colour may be due to the presence of titanium. Analyses of some specimens point to the formula $(\text{SiO}_3)_2\text{Al}(\text{AlO})_2(\text{BO})_2\text{H}$, which, written in this form, explains the analogy with andalusite and the alteration into muscovite. Dumortierite occurs in gneiss at Chaponost, near Lyons, and at a few other European localities; it is found also in the United States, being known from near New York City, from Riverside and San Diego counties, California, and from Yuma county, Arizona. The last-named locality yields the mineral in some quantity in the form of dense fibres embedded in quartz, to which it imparts a blue colour. The mineral aggregate is polished as an ornamental stone, rather resembling lapis-lazuli.

DUMOULIN, CHARLES [MOLINAUS] (1500-1566), French jurist, was born in Paris in 1500. He began practice as an advocate before the parlement of Paris. Dumoulin turned Calvinist, and when the persecution of the Protestants began he went to Germany, where for a long time he taught law at Strassburg, Besançon and elsewhere. He returned to France in 1557. Dumoulin had, in 1552, written *Commentaire sur l'édit du roi Henri II sur les petites dates*, which was condemned by the Sorbonne, but his *Conseil sur le fait du concile de Trente* created a still greater stir, and aroused against him both the Catholics and the Calvinists. He was imprisoned by order of the parlement until 1564. It was as a jurist that Dumoulin gained his great reputation, being regarded by his contemporaries as the "prince of jurisconsults." His remarkable erudition and breadth of view had a considerable effect on the subsequent development of French law. He was a bitter enemy of feudalism, which he attacked in his *De feudis* (Paris, 1539). Other important works were his commentaries on the customs of Paris (Paris, 1539, 1554; Frankfurt, 1575; Lausanne, 1576), valuable as the only commentary on those in force in 1510, and the *Extrication labyrinthi dividui et individui*, a treatise on the law of surety.

• A collected edition of Dumoulin's works was published in Paris in 1681 (5 vols.).

DUMOURIEZ, CHARLES FRANÇOIS (1739-1823), French general, was born at Cambrai in 1739. His father was a commissary of the royal army, and educated his son most carefully in various branches of learning. The boy continued his studies at the college of Louis-le-Grand, and in 1757 began his military career as a volunteer in the campaign of Rossbach. He received a commission for good conduct in action, and served in the later German campaigns of the Seven Years' War with distinction; but at the peace he was retired as a captain, with a small pension and the cross of St Louis. Dumouriez then visited Italy and Corsica, Spain and Portugal, and his memorials to the duc de Choiseul on Corsican affairs led to his re-employment on the staff of the French expeditionary corps sent to the island, for which he gained the rank of lieutenant-colonel. After this he became a member of the *Secret du roi*, the secret service under Louis XV., where his fertility of diplomatic resource had full scope. In 1770 he was sent on a mission into Poland, where in addition to his political business he organized a Polish militia. The fall of Choiseul brought about his recall, and somewhat later he was imprisoned in the Bastille, where he spent six months, occupying himself with literary pursuits. He was then removed to Caen, where he was detained until the accession of Louis XVI.

Upon his release in 1774 he married his cousin Mlle de Broissy, but he was neglectful and unfaithful, and in 1780 the pair separated, the wife taking refuge in a convent. Meanwhile Dumouriez had devoted his attention to the internal state of his own country, and amongst the very numerous memorials which he sent in to the government was one on the defence of Normandy and its ports, which procured him in 1778 the post

of commandant of Cherbourg, which he administered with much success for ten years. He became *maréchal de camp* in 1788; but his ambition was not satisfied, and at the outbreak of the Revolution, seeing the opportunity for carving out a career, he went to Paris, where he joined the Jacobin Club. The death of Mirabeau, to whose fortunes he had attached himself, was a great blow to him; but, promoted to the rank of lieutenant-general and commandant of Nantes, his opportunity came after the flight to Varennes, when he attracted attention by offering to march to the assistance of the Assembly. He now attached himself to the Girondist party, and on the 15th of March 1792 was appointed minister of foreign affairs. He was mainly responsible for the declaration of war against Austria (April 20), and the invasion of the Low Countries was planned by him. On the dismissal of Roland, Clavière and Servan (June 13), he took the latter's post of minister of war, but resigned it two days later on account of the king's refusal to come to terms with the Assembly, and went to join the army of Marshal Lütkner. After the *émée* of August 10 and Lafayette's flight he was appointed to the command of the "Army of the Centre," and at the same moment the Coalition assumed the offensive. Dumouriez acted promptly. His subordinate Kellermann repulsed the Prussians at Valmy (September 20, 1792), and he himself severely defeated the Austrians at Jemappes (November 6). Returning to Paris, he was received with a popular ovation; but he was out of sympathy with the extremists in power, his old-fashioned methodical method of conducting war exposed him to the criticism of the ardent Jacobins, and a defeat would mean the end of his career. Defeat coming to him at Neerwinden in January 1793, he ventured all on a desperate stroke. Arresting the commissaries of the Convention sent to inquire into his conduct, he handed them over to the enemy, and then attempted to persuade his troops to march on Paris and overthrow the revolutionary government. The attempt failed, and Dumouriez, with the duc de Chartres (afterwards King Louis Philippe) and his brother the duc de Montpensier, fled into the Austrian camp.

He now wandered from country to country, occupied in ceaseless intrigues with Louis XVIII., or for setting up an Orleanist monarchy, until in 1804 he settled in England, where the government conferred on him a pension of £1200 a year. He became a valuable adviser to the War Office in connection with the struggle with Napoleon, though the extent to which this went was only known in public many years later. In 1814 and 1815 he endeavoured to procure from Louis XVIII. the bâton of a marshal of France, but was refused. He died at Turville Park, near Henley-on-Thames, on the 14th of March 1823. His memoirs were published at Hamburg in 1794. An enlarged edition, *La Vie et les mémoires du Général Dumouriez*, appeared at Paris in 1823. Dumouriez was also the author of a large number of political pamphlets.

See A. von Boguslawski, *Das Leben des Generals Dumouriez* (Berlin, 1878-1879); *Revue des deux mondes* (15th July, 1st and 15th August, 1884); H. Welschinger, *Le Roman de Dumouriez* (1890); A. Chuquet, *La Première Invasion, Valmy, La Retraite de Brunsvich, Jemappes, La Trahison de Dumouriez* (Paris, 1886-1891); A. Sorel, *L'Europe et la Révolution française* (1888-1892); J. Holland Rose and A. M. Broadley, *Dumouriez and the Defence of England* (1908); E. Daudet, *La Conjuración de Pichegru et les complots royalistes du midi et du Est, 1795-1797* (Paris, 1901).

DUMP. (1) (Of obscure origin; corresponding in form and possibly connected with the word, are the Mid. Dutch *domp*, mist or haze, and the Ger. *dämpf*, dull or dazed), a state of wonder, perplexity or melancholy. The word thus occurs particularly in the plural, in such phrases as "doleful dumps." It was also formerly used for a tune, especially one of a mournful kind, a dirge. (2) (Connected with "dumpy," but appearing later than that word, and also of obscure origin), something short and thick, and hence used of many objects such as a lead counter or medal, of a coin formerly used in Australia, formed by punching a circular piece out of a Spanish dollar, and of a short thick bolt used in shipbuilding. (3) (Probably of Nors origin, cf. Nor. *dæmpa*, and Dan. *dumpe*, meaning "to fall suddenly, with a bump"), to throw down in a heap, and her

particularly applied to the depositing of any large quantity of material, to the shooting of rubbish, or tilting a load from a cart. It is thus used of the method of disposal of the masses of gravel, &c., disintegrated by water in the hydraulic method of gold mining. A "dump" or "dumping-ground" is thus the place where such waste material is deposited. The use of the term "dumping" in the economics of international trade has come into prominence in the tariff reform controversy in the United Kingdom. It is sometimes used loosely of the importing of foreign goods at prices below those ruling in the importing country; but strictly the term is applied to the importing, at a price below the cost of production, of the surplus of manufactures of a foreign country over and above what has been disposed of in its home market. The ability to sell such a surplus in a foreign market below the cost of production depends on the prices of the home market being artificially sustained at a sufficiently high level by a monopoly or by a tariff or by bounties. An essential factor in the operation of "dumping" is the lessening of the whole cost of production by manufacture on a large scale.

DUNASH, the name of two Jewish scholars of the 10th century.

1. **DUNASH BEN LABRAÏ**, grammarian and poet, belonged to the brilliant circle attracted to Cordova by Hasdai, and took a large share in promoting the Jewish "Golden Age" under the Moors in Andalusia. Dunash not only helped in the foundation of a school of scientific philology, but adapted Arabian metres to Hebrew verse, and thereby gave an impulse to the neo-Hebraic poetry, which reached its highest level in Spain.

2. **DUNASH IBN TAMIM** was, like the preceding, a leader in the critical study of language among Arabic-speaking Jews. Professor Bacher says of him: "In the history of Hebrew philology, Ibn Tamim ranks as one of the first representatives of the systematic comparison of Hebrew and Arabic." The philological researches of the 10th century were closely associated with the Spanish-Moorish culture of the period. (I. A.)

DUNBAR, GEORGE (1774-1851), English classical scholar and lexicographer, was born at Coldingham in Berwickshire. In early life he followed the humble profession of gardening, but, having been permanently injured by an accident, devoted himself to the study of the classics. When about thirty years of age, he settled in Edinburgh, where he obtained a tutorship in the family of Lord Provost Fettes. In 1807 he succeeded Andrew Dalzel as professor of Greek in the university. Dunbar held his appointment till his death on the 6th of December 1851. Although a man of great energy and industry, Dunbar did not produce anything of permanent value. He deserves mention, however, for his Greek-English and English-Greek lexicon (1840), on the compilation of which he spent eight years. Although now superseded, it was the best work of its kind that had appeared in England.

The little that is known of Dunbar's life will be found in the *Caledonian Mercury* (8th of December 1851).

DUNBAR, PAUL LAURENCE (1872-1906), American author, of negro descent, was born in Dayton, Ohio, on the 27th of June 1872. He graduated (1891) from the Dayton high school, had a varied experience as elevator boy, mechanic and journalist, and in 1897-1898 held a position on the staff of the Library of Congress, resigning in December 1898 to devote himself to literary work. He died of consumption at his home in Dayton on the 8th of February 1906. His poetry was brought to the attention of American readers by William Dean Howells, who wrote an appreciative introduction to his *Lyrics of Lowly Life* (1896). Subsequently Dunbar published eleven other volumes of verse, three novels and five collections of short stories. Some of his short stories and sketches, especially those dealing with the American negro, are charming; they are far superior to his novels, which deal with scenes in which the author is not so much at home. His most enduring work, however, is his poetry. Some of this is in literary English, but the best is in the dialect of his people. In it he has preserved much of their very temperament and outlook on life, usually with truth and freshness of feeling, united with a happy choice of language and much

lyrical grace and sweetness, and often with rare humour and pathos. These poems of the soil are a distinct contribution to American literature, and entitle the author to be called pre-eminently the poet of his race in America.

See *Life and Works of Paul Lawrence Dunbar* (Naperville, Ill., 1907), with a biography by L. K. Wiggins.

DUNBAR, WILLIAM (c. 1460-c. 1520), Scottish poet, was probably a native of East Lothian. This is assumed from a satirical reference in the *Flying of Dunbar and Kennedy*, where, too, it is hinted that he was a member of the noble house of Dunbar. His name appears in 1477 in the Register of the Faculty of Arts at St Andrews, among the Determinants or Bachelors of Arts, and in 1479 among the masters of the university. Thereafter he joined the order of Observantine Franciscans, at St Andrews or Edinburgh, and proceeded to France as a wandering friar. He spent a few years in Picardy, and was still abroad when, in 1491, Bothwell's mission to secure a bride for the young James IV. reached the French court. There is no direct evidence that he accompanied Blackadder, archbishop of Glasgow, on a similar embassy to Spain in 1495. On the other hand, we know that he proceeded with that prelate to England on his more successful mission in 1501. Dunbar had meanwhile (about 1500) returned to Scotland, and had become a priest at court, and a royal pensioner. His literary life begins with his attachment to James's household. All that is known of him from this date to his death about 1520 is derived from the poems or from entries in the royal registers of payments of pension and grants of livery. He is spoken of as the Rhymer of Scotland in the accounts of the English privy council dealing with the visit of the mission for the hand of Margaret Tudor, rather because he wrote a poem in praise of London, than because, as has been stated, he held the post of laureate at the Scottish court. In 1511 he accompanied the queen to Aberdeen and commemorated her visit in *versé*. Other pieces such as the *Orisoun* ("Quhen the Gouverneur past in France"), apropos of the setting out of the regent Albany, are of historical interest, but they tell us little more than that Dunbar was alive. The date of his death is uncertain. He is named in *Lyndsay's Testament and Complaynt of the Papyngo* (1530) with poets then dead, and the reference precedes that to Douglas who had died in 1522. He certainly survived his royal patron. We may not be far out in saying that he died about 1520.

Dunbar's reputation among his immediate successors was considerable. By later criticism, stimulated in some measure by Scott's eulogy that he is "unrivalled by any which Scotland has produced," he has held the highest place among the northern makars. The praise, though it has been at times exaggerated, is on the whole just, certainly in respect of variety of work and mastery of form. He belongs, with James I., Henryson and Douglas, to the Scots Chaucerian school. In his allegorical poems reminiscences of the master's style and literary habit are most frequent. Yet, even there, his discipleship shows certain limitations. His wilder humour and greater heat of blood give him opportunities in which the Chaucerian tradition is not helpful, or even possible. His restlessness leads us at times to a comparison with Skelton, not in respect of any parallelism of idea or literary craftsmanship, but in his experimental zeal in turning the diction and tuning the rhythms of the chaotic English which only Chaucer's genius had reduced to order. The comparison must not, however, be pushed too far. Skelton's work carries with it the interest of attempt and failure. Dunbar's command of the medium was more certain. So that while we admire the variety of his work, we also admire the competence of his effort.

One hundred and one poems have been ascribed to Dunbar. Of these at least ninety are generally accepted as his: of the eleven attributed to him it would be hard to say that they should not be considered authentic. Most doubt has clung to his verse tale *The Freiris of Berwick*.

Dunbar's chief allegorical poems are *The Goldyn Targe* and *The Thrissil and the Rois*. The motif of the former is the poet's futile endeavour, in a dream, to ward off the arrows of Dame

Beautee by Reason's "scheld of gold." When wounded and made prisoner, he discovers the true beauty of the lady: when she leaves him, he is handed over to Heaviness. The noise of the ship's guns, as the company sails off, wakes the poet to the real pleasures of a May morning. Dunbar works on the same theme in a shorter poem, known as *Beauty and the Prisoner*. *The Tharissil and the Rois* is a prothalamium in honour of James IV. and Margaret Tudor, in which the heraldic allegory is based on the familiar beast-parliament.

The greater part of Dunbar's work is occasional—personal and social satire, complaints (in the style familiar in the minor verse of Chaucer's English successors), orisons and pieces of a humorous character. The last type shows Dunbar at his best, and points the difference between him and Chaucer. The best specimen of this work, of which the outstanding characteristics are sheer whimsicality and topsy-turvy humour, is *The Ballad of the Kynd Killok*. This strain runs throughout many of the occasional poems, and is not wanting in odd passages in Dunbar's contemporaries; and it has the additional interest of showing a direct historical relationship with the work of later Scottish poets, and chiefly with that of Robert Burns. Dunbar's satire is never the gentle funning of Chaucer: more often it becomes invective. Examples of this type are *The Satire on Edinburgh*, *The General Satire*, the *Epitaph on Donald Owne*, and the powerful vision of *The Dance of the Sevin Deidlie Synnis*. In the *Flying of Dunbar and Kennedie*, an outstanding specimen of a favourite northern form, analogous to the continental *estrif*, or *lensone*, he and his rival reach a height of scurrility which is certainly without parallel in English literature. This poem has the additional interest of showing the racial antipathy between the "Inglis"-speaking inhabitants of the Lothians and the "Scots" or Gaelic-speaking folk of the west country.

There is little in Dunbar which may be called lyrical, and little of the dramatic. His *Interlud of the Droichis* [*Dwarf's part of the Play*], one of the pieces attributed to him, is supposed to be a fragment of a dramatic composition. It is more interesting as evidence of his turn for whimsicality, already referred to, and may for that reason be safely ascribed to his pen. If further selection be made from the large body of miscellaneous poems, the comic poem on the physician Andro Kennedy may stand out as one of the best contributions to medieval Goliardic literature; *The Two Mariis Women and the Wedo*, as one of the richest and most effective *pastiches* in the older alliterative style, then used by the Scottish Chaucerians for burlesque purposes; *Dome is a battell on the Dragon Blak*, for religious feeling expressed in melodious verse; and the well-known *Lament for the Makaris*. The main value of the last is historical, but it too shows Dunbar's mastery of form, even when dealing with lists of poetic predecessors.

The chief authorities for the text of Dunbar's poems are:—(a) the Aulcan MS. (c. 1515); (b) the Chepman and Myllar Prints (1508) preserved in the Advocates' library, Edinburgh; (c) Bannatyne MS. (1568) in the same; (d) the Maitland Folio MS. (c. 1570-1590) in the Pepysian library, Magdalene College, Cambridge. Some of the poems appear in the Makculloch MS. (before 1500) in the library of the university of Edinburgh; in MS. Cotton Vitellius A. xvi., appendix to Royal MSS. No. 58, and Arundel 285, in the British Museum; in the Reidpath MS. in the university library of Cambridge; and in the Aberdeen Register of Sasines. The first complete edition was published by David Laing (2 vols., Edinburgh, 1834) with a supplement (Edinburgh, 1865). This has been superseded by the Scottish Text Society's edition (ed. John Small, Aeneas J. G. Mackay and Walter Gregor, 3 vols., Edinburgh, 1893), and by Dr Schipper's 1 vol. edition (Vienna: Kais. Akad. der Wissenschaften, 1894). The editions by James Paterson (Edinburgh, 1860) and H. B. Baildon (Cambridge, 1907) are of minor value. Selections have been frequently reprinted since Ramsay's *Ever-Green* (1724) and Hailes's *Ancient Scottish Poems* (1817). For critical accounts see Irving's *History of Scottish Poetry*, Henderson's *Vernacular Poetry of Scotland*, Gregory Smith's *Transition Period*, J. H. Millar's *Literary History of Scotland*, and the *Cambridge History of English Literature*, vol. ii. (1908). Professor Schipper's *William Dunbar, sein Leben und seine Gedichte* (with German translations of several of the poems), appeared at Berlin in 1884. (G. G. S.)

DUNBAR (Gaelic, "the fort on the point"), a royal, municipal and police burgh, and seaport of Haddingtonshire, Scotland. Pop. (1901) 3581. It is situated on the southern shore of the

entrance to the Firth of Forth, 2½ m. E. by N. of Edinburgh by the North British railway. Dunbar is said to have the smallest rainfall in Scotland and is a favourite summer resort. The ruins of the castle, and the remains of the Grey Friars' monastery, founded in 1218, at the west end of the town, and Dunbar House in High Street, formerly a mansion of the Lauderdales, but now used as barracks, are of historic interest. The parish church, a fine structure in red sandstone, the massive tower of which, 107 ft. high, is a landmark for sailors, dates only from 1819, but occupies the site of what was probably the first collegiate church in Scotland, and contains the large marble monument to Sir George Home, created earl of Dunbar and March by James VI. in 1605. Among other public buildings are the town hall, assembly rooms, St Catherine's hall, the Mechanics' institute and library.

There are two harbours, difficult of access owing to the number of reefs and sunken rocks. Towards the coast of building the eastern or older harbour Cromwell contributed £300. The western or Victoria harbour is a refuge for vessels between Leith Roads and the Tyne. On the advent of steam the shipping declined, and even the herring fishery, which fostered a large curing trade, has lost much of its prosperity. The industries are chiefly those of agricultural-implement making, rope-making, brewing and distilling, but a considerable business is done in the export of potatoes. Dunbar used to form one of the Haddington district group of parliamentary burghs, but its constituency was merged in that of the county in 1885.

About 4 m. S.W. is the village of Biel, where, according to some authorities, William Dunbar the poet was born. One mile to the S.E. of the town is Broxmouth Park (or Brocksmouth House), the first position of the English left wing in the battle of 1650, now belonging to the duke of Roxburghe.

The site of Dunbar is so commanding that a castle was built on the cliffs at least as early as 856. In 1070 Malcolm Canmore gave it to Cospatrick, earl of Northumberland, ancestor of the earls of Dunbar and March. The fortress was an important bulwark against English invasion, and the town—which was created a royal burgh by David II.—grew up under its protection. The castle was taken by Edward I., who defeated Baliol in the neighbourhood in 1296, and it afforded shelter to Edward II. after Bannockburn. In 1336 it was besieged by the English under William, Lord Montacute, afterwards 1st earl of Salisbury, but was successfully defended by Black Agnes of Dunbar, countess of March, a member of the Murray family. Joanna Beaufort, widow of James I., chose it for her residence, and in 1479, after his daring escape from Edinburgh Castle, the duke of Albany concealed himself within its walls, until he contrived to sail for France. In 1567 Mary made Bothwell keeper of the castle, and sought its shelter herself after the murder of Rizzio and again after her flight from Borthwick Castle. When she surrendered at Carberry Hill the stronghold fell into the hands of the regent Moray, by whom it was dismantled in 1568, but its ruins are still a picturesque object on the hill above the harbour.

THE BATTLE OF DUNBAR was fought on the 3rd (13th) of September 1650 between the English army under Oliver Cromwell and the Scots under David Leslie, afterwards Lord Newark. It took place about 3 m. S.E. of the centre of the town, where between the hills and the sea coast there is a plain about 1 m. wide, through the middle of which the main road from Dunbar to Berwick runs. The plain and the road are crossed at right angles by the course of the Brocksburn, or Spott Burn, which at first separated the hostile armies. Rising from the right bank of the Brock is Doon Hill (650 ft.), which overlooks the lower course of the stream and indeed the whole field. For the events preceding the battle, see GREAT REBELLION.

Cromwell, after a war of manœuvre near Edinburgh, had been compelled by want of supplies to withdraw to Dunbar; Leslie pursued and took up a position on Doon Hill, commanding the English line of retreat on Berwick. The situation was more than difficult for Cromwell. Some officers were for withdrawing by sea, but the general chose to hold his ground, though his army was enfeebled by sickness and would have to fight on unfavourable terrain against odds of two to one. Leslie, however, who

was himself in difficulties on his post among the bare hills, and was perhaps subjected to pressure from civil authorities, descended from the heights on the 2nd of September and began to edge towards his right, in order first to confront, and afterwards to surround, his opponent. The cavalry of his left wing stood fast, west of Doon Hill, as a pivot of manoeuvre, the northern face of Doon (where the ground rises from the burn at an average slope of fifteen degrees and is even steeper near the summit) he left unoccupied. The centre of infantry stood on the forward slope of the long spur which runs east from Doon, and beyond them, practically on the plain, was the bulk of the Scottish cavalry. In the evening Cromwell drew up his army, under 11,000 effective men, along the ravine, and issued orders to attack the Scots at dawn of the 3rd (13th). The left of the Scots was ineffective, as was a part of their centre of foot on the upper part of the hillside, and the English commander proposed to deal with the remainder. Before dawn the English advanced troops crossed the ravine, attacked Doon, and pinned Leslie's left; under cover of this the

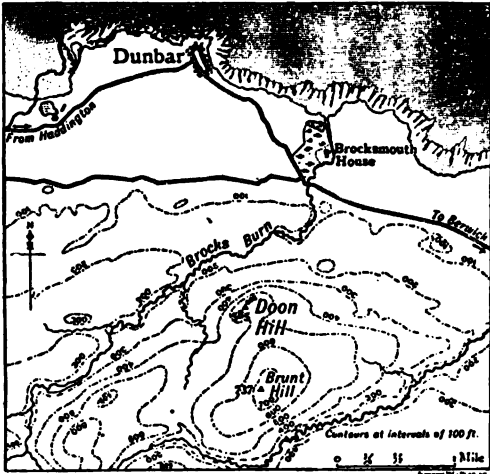

whole army began its manoeuvre. The artillery was posted on the Dunbar side of the burn, directly opposite and north of Doon, the infantry and cavalry crossed where they could, and formed up gradually in a line south of and roughly parallel to the Berwick road, the extreme left of horse and foot, acting as a reserve, crossed at Brocksmouth House on the outer flank. The Scots were surprised in their bivouacs, but quickly formed up, and at first repulsed both the horse and the foot. But ere long Cromwell himself arrived with his reserve, and the whole English line advanced again. The fresh impulse enabled it to break the Scottish cavalry and repulse the foot, and Leslie's line of battle was gradually rolled up from right to left. In the words of an English officer, "The sun appearing upon the sea, I heard Nol say, 'Now let God arise, and let His enemies be scattered,' and following us as we slowly marched I heard him say, 'I profess they run.'" Driven into the broken ground, and penned between Doon Hill and the ravine, the Scots were indeed helpless. "They routed one another after we had done their work on their right wing," says the same officer. Ten thousand men, including almost the whole of the Scottish foot, surrendered, and their killed numbered three thousand. Few of the English were killed. "I do not believe," wrote Cromwell, "that we have lost twenty men."

The account of the battle of Dunbar here followed is that of C. H. Firth, for which see his *Cromwell*, pp. 281 ff. and references there given. For other accounts see Carlyle, *Cromwell's Letters and Speeches*, letter cxi.; Hoening, *Cromwell*; Baldock, *Cromwell as a Soldier*; and Gardiner, *Hist. of the Commonwealth and Protectorate*, vol. I.

DUNBLANE, a police burgh of Perthshire, Scotland, on the left bank of Allan Water, a tributary of the Forth, 5 m. N. by W of Stirling by the Caledonian railway. Pop. (1901) 2516. It is a place of great antiquity, with narrow streets and old-fashioned houses. The leading industry is the manufacture of woollens. The cathedral is situated by the side of the river, and was one of the few ecclesiastical edifices that escaped injury at the hands of the Reformers. The first church is alleged to have been erected by Blane, a saint of the 7th century, but the cathedral as founded by David I. in 1141, and almost entirely rebuilt about 1240 by Bishop Clemens. Excepting the tower, which is Early Norman and was probably incorporated from the earlier structure, the building is of the Early Pointed style. It consists of a nave (130 ft. long, 58 ft. wide, 50 ft. high), aisles, choir (80 ft. long by 30 ft. wide), chapter-house and tower. Ruskin considered that there was "nothing so perfect in its simplicity" as the west window, the design of which resembles a leaf. After the decline of episcopacy the building was neglected for a long period, but the choir, which contains some carved oak stalls of the 16th century, was restored in 1873, and the nave roofed and restored in 1892-1895, under the direction of Sir Rowand Anderson, the architect. From the time of the Reformation the choir had been used as the parish church, but since its restoration the whole cathedral has been devoted to this purpose. The new oak roof is emblazoned with the arms of the Scottish and later British monarchs, and of the old earls of Strathearn. Several members of the families of Strathearn and Strathallan were buried in the cathedral, and three stones of blue marble in the floor of the choir are supposed to mark the graves of Lady Margaret Drummond (b. 1472), mistress of James IV., and her two sisters, daughters of Lord Drummond, who were mysteriously poisoned in 1501. An ancient Celtic cross, 6½ ft. high, stands in the north-western corner of the nave. Robert Leighton was the greatest of the bishops of Dunblane, and held the see from 1661 to 1670. The library of 1500 volumes which he bequeathed to the clergy of the diocese is housed in a building with an outside stair, standing near the cathedral, and the Bishop's Walk by the river also perpetuates his memory. Of the bishop's palace only a few ruins remain. The battlefield of Sheriffmuir is about 2½ m. E. of the town. A mile and a half S. of Dunblane is the estate of Keir which belonged to Sir William Stirling-Marcell, the historian and art critic. The duke of Leeds derives the title of one of his viscounties from Dunblane.

DUNCAN, the name of two Scottish kings.

DUNCAN I. (d. 1040) was a son of Crinan or Croban, lay abbot of Dunkeld, and became king of the Scots in succession to his maternal grandfather, Malcolm II., in 1034, having previously as *rex Cumbroborum* ruled in Strathclyde. His accession was "the first example of inheritance of the Scottish throne in the direct line." Duncan is chiefly known through his connexion with Macbeth, which has been immortalized by Shakespeare. The feud between these two princes originated probably in a dispute over the succession to the throne; its details, however, are obscure, and the only fact which can be ascertained with any certainty is that Duncan was slain by Macbeth in 1040. Two of Duncan's sons, Malcolm III. Canmore and Donald V. Bane, were afterwards kings of the Scots.

DUNCAN II. (d. 1094) was a son of Malcolm III. and therefore a grandson of Duncan I. For a time he lived as a hostage in England and became king of the Scots after driving out his uncle, Donald Bane, in 1093, an enterprise in which he was helped by some English and Normans. He was killed in the following year.

See W. F. Skene, *Celtic Scotland* (1876-1880), and A. Lang, *History of Scotland*, vol. I. (1900).

DUNCAN, ADAM DUNCAN, 1st Viscount (1731-1804), British naval commander, was born on the 1st of July 1731, at Lundie, in Forfarshire, Scotland. After receiving the rudiments of his education at Dundee, he was in 1746 placed under Captain Haldane, of the "Shoreham" frigate, and in 1749 he became a midshipman in the "Centurion." In 1755 he was appointed second lieutenant of the "Norwich," but on the arrival of that ship in America, whither, with the rest of Keppel's

squadron, it had convoyed General Braddock's forces, he was transferred to the "Centurion." Once again in England, he was promoted to be second lieutenant of the "Torbay," and after three years on the home station he assisted in the attack on the French settlement of Goree, on the African coast, in which he was slightly wounded. He returned to England as first lieutenant of the "Torbay"; and in 1759 was made a commander, and in 1761 a post-captain. His vessel, the "Valiant" (74), was Commodore Keppel's flag-ship in the expedition against Belle-Île en Mer in that year, and also in 1762, when it took an important part in the capture of Havana. In 1778, on the recommencement of war with France, Captain Duncan was appointed to the "Suffolk" (74), whence before the close of the year he removed to the "Monarch" (74), one of the Channel Fleet. On the 16th of January 1780, in an action off Cape St Vincent, between a Spanish squadron under Don Juan de Langara and the British fleet under Sir George Rodney, Captain Duncan in the "Monarch" was the first to engage the enemy; and in 1782, as captain of the "Blenheim" (90), he took part in Lord Howe's relief of Gibraltar. From the rank of rear-admiral of the blue, received in 1780, he was gradually promoted until, in 1799, he became admiral of the white. In February 1795 he hoisted his flag as commander-in-chief of the North Sea fleet, appointed to harass the Batavian navy. Towards the end of May 1797, though, in consequence of the widespread mutiny in the British fleet, he had been left with only the "Adamant" (50), besides his own ship the "Venerable" (74). Admiral Duncan proceeded to his usual station off the Texel, where lay at anchor the Dutch squadron of fifteen sail of the line, under the command of Vice-Admiral de Winter. From time to time he caused signals to be made, as if to the main body of a fleet in the offing, a stratagem which probably was the cause of his freedom from molestation until, in the middle of June, reinforcements arrived from England. On the 3rd of October the admiral put into Yarmouth Roads to refit and victual his ships, but, receiving information early on the 9th that the enemy was at sea, he immediately hoisted the signal for giving him chase. On the morning of the 11th de Winter's fleet, consisting of 4 seventy-fours, 7 sixty-fours, 4 fifty-gun ships, 2 forty-four-gun frigates, and 2 of thirty-two guns, besides smaller vessels, was sighted lying about 9 m. from shore, between the villages of Egmont and Camperdown. The British fleet numbered 7 seventy-fours, 7 sixty-fours, 2 fifties, 2 frigates, with a sloop and several cutters, and was slightly superior in force to that of the Dutch. Shortly after mid-day the British ships, without waiting to form in order, broke through the Dutch line, and an engagement commenced which, after heavy loss on both sides, resulted in the taking by the British of eleven of the enemy's vessels. When the action ceased the ships were in nine fathoms water, within 5 m. of a lee shore, and there was every sign of an approaching gale. So battered were the prizes that it was found impossible to fit them for future service, and one of them, the "Delft," sank on her way to England. In recognition of this victory, Admiral Duncan was, on the 21st of October, created Viscount Duncan of Camperdown and baron of Lundie, with an annual pension of £3000 to himself and the two next heirs to his title. The earldom of Camperdown was created for his son Robert (1785-1859) in 1831, and is still in the possession of his descendants. In 1800 Lord Duncan withdrew from naval service. He died on the 4th of August 1804.

See Charnock, *Biog. Nav.* (1794-1796); Collins, *Peerage of England*, p. 378 (1812); W. James, *Naval History of Great Britain* (1822); Yonge, *History of the British Navy*, vol. i. (1863); Earl of Camperdown, *Admiral Duncan* (1898), vol. xvi. of the Navy Record Soc. Publications, contains the logs of the ships engaged in the battle of Camperdown.

DUNCAN, PETER MARTIN (1824-1891), English palaeontologist, was born on the 20th of April 1824 at Twickenham, and was educated partly at the local grammar school and partly in Switzerland. Having entered the medical department of King's College, London, in 1842, he obtained the degree of M.B. (Lond.) in 1846, and then acted for a short time as assistant to a doctor

at Rochester. Subsequently he practised at Colchester (1848-1860), and during this period he served for a year as mayor of the city. Returning to London in 1860 he practised for a few years at Blackheath, and then gave his time entirely to scientific research, first in botany, and later in geology and palaeontology. His attention was directed especially to fossil corals, and in 1863 he contributed to the Geological Society of London the first of a series of papers on the fossil corals of the West Indian Islands in which he not only described the species, but discussed their bearings on the physical geography of the Tertiary period. Corals from various parts of the world and from different geological formations were subsequently dealt with by Duncan, and he came to be regarded as a leading authority on these fossils. He prepared also for the Palaeontographical Society (1866-1872) an important work on British fossil corals, as a supplement to the monograph by Henri Milne-Edwards and Jules Haime. He was elected F.R.S. in 1868. In 1870 he was chosen professor of geology at King's College. He was president of the Geological Society (1876-1877), and in 1881 was awarded the Wollaston medal. In addition to papers on fossil corals, he dealt with some of the living forms, also with the Echinoides and other groups, recent and fossil. He edited the six volumes of Cassell's *Natural History* (1877, &c.). He died at Gunnersbury on the 28th of May 1891.

DUNCAN, THOMAS (1807-1845), Scottish portrait and historical painter, was born at Kinclaven, in Perthshire. He was educated at the Perth Academy, and began the study of the law, but abandoned it for art. Beginning under the instruction of Sir William Allan, he early attained distinction as a delineator of the human figure; and his first pictures established his fame so completely, that at a very early age he was appointed professor of colouring, and afterwards of drawing, in the Trustees' Academy of Edinburgh. In 1840 he painted one of his finest pictures, "Prince Charles Edward and the Highlanders entering Edinburgh after the Battle of Prestonpans," which secured his election as an associate of the Royal Academy in 1843. In the same year he produced his picture of "Charles Edward asleep after Culloden, protected by Flora MacDonald," which, like many other of his works, has been often engraved. In 1844 appeared his "Cupid" and his "Martyrdom of John Brown of Priesthill." His last work was a portrait of himself, now in the National Gallery in Edinburgh. He particularly excelled in his portraits of ladies and children. He died in Edinburgh on the 25th of May 1845.

DUNCE, a slow or stupid person, one incapable of learning. The word is derived from the name of the great schoolman, John Duns Scotus, whose works on logic, theology and philosophy were accepted text-books in the universities from the 14th century. "Duns" or "Dunsman" was a name early applied by their opponents to the followers of Duns Scotus, the Scotists, and hence was equivalent to one devoted to sophistical distinctions and subtleties. When, in the 16th century, the Scotists obstinately opposed the "new learning," the term "duns" or "dunce" became, in the mouths of the humanists and reformers, a term of abuse, a synonym for one incapable of scholarship, a dull blockhead.

DUNCKER, MAXIMILIAN WOLFGANG (1811-1886), German historian and politician, eldest son of the publisher Karl Duncker, was born at Berlin on the 15th of October 1811. He studied at the universities of Bonn and Berlin till 1834, was then accused of participation in the students' societies, which the government was endeavouring to suppress, and was condemned to six years' imprisonment, afterwards reduced to six months. He had already begun his labours as a historian, but after serving his sentence in 1837, found himself debarred till 1839 from completing his course at Halle, where in 1842 he obtained a professorship. Elected to the National Assembly at Frankfurt in 1848, he joined the Right Centre party, and was chosen reporter of the projected constitution. He sat in the Erfurt assembly in 1850, and in the second Prussian chamber from 1849 to 1852. During the crisis in Schleswig and Holstein in 1850 he endeavoured in person to aid the duchies in their struggles. An outspoken opponent of the

policy of Manteuffel, he was refused promotion by the Prussian government, and in 1857 accepted the professorship of history at Tübingen. In 1859, however, he was recalled to Berlin as assistant in the ministry of state in the Auerswald cabinet, and in 1861 was appointed councillor to the crown prince. In 1867 he became director of the Prussian archives, with which it was his task to incorporate those of Hanover, Hesse and Nassau. He retired on the 1st of January 1875, and died at Ansbach on the 21st of July 1886. Duncker's eminent position among German historians rests mainly on his *Geschichte des Alterthums* (1st ed., 1852-1857); 5th ed. in 9 vols., 1878-1886; English translation by Evelyn Abbott, 1877-1882). He edited, with J. G. Droysen, *Preussische Staatschriften, Politische Correspondenz Friedrichs des Grossen, and Urkunden und Actenstücke zur Geschichte des Kurfürsten Friedrich Wilhelm von Brandenburg*. To the period of his political activity belong *Zur Geschichte der deutschen Reichsversammlung in Frankfurt* (1849); *Heinrich von Gagern* (1850), in the series of *Männer der Gegenwart*; and the anonymous *Vier Monate auswärtiger Politik* (1851). His other works include *Origines Germanicæ* (1840); the lectures *Die Krisis der Reformation* (1845) and *Feudalität und Aristokratie* (1858); *Aus der Zeit Friedrichs des Grossen und Friedrich Wilhelms III. Abhandlungen zur preussischen Geschichte* (1876); followed after his death by *Abhandlungen aus der griechischen Geschichte und Abhandlungen aus der neueren Geschichte* (1887).

DUNCKLEY, HENRY (1823-1896), English journalist, was born at Warwick on the 24th of December 1823. Educated at the Baptist college at Accrington, Lancashire, and at Glasgow University, he became in 1848 minister of the Baptist church at Salford, Lancashire. Here he closely investigated the educational needs of the working-classes, embodying the results of his inquiries in an essay, *The Glory and the Shame of Britain* (1851), which gained a prize offered by the Religious Tract Society. In 1852 he won the Anti-Corn-law League's prize with an essay on the results of the free-trade policy, published in 1854 under the title *The Charter of the Nations*. In 1855 he abandoned the ministry to edit the *Manchester Examiner and Times*, a prominent Liberal newspaper, in charge of which he remained till 1889. For twenty years he wrote, over the signature "Verax," weekly letters to the *Manchester papers*; those on *The Crown and the Cabinet* (1877) and *The Crown and the Constitution* (1878) evoked so much enthusiasm that a public subscription was set on foot to present the writer with a handsome testimonial for his public services. In 1878 Dunckley, who had often declined to stand for parliament, was elected a member of the Reform Club in recognition of his services to the Liberal party, and in 1883 he was made an LL.D. by Glasgow University. He died at Manchester on the 29th of June 1896.

DUNCOMBE, SIR CHARLES (c. 1648-1711), English politician, was a London apprentice, who became a goldsmith and a banker; he amassed great wealth in his calling and was chosen an alderman of the city of London in 1683. Duncombe's parliamentary career began in 1685, when he was elected member of parliament for Hedon, and he was afterwards one of the representatives of Yarmouth in the Isle of Wight and of Downton in Wiltshire. He was made receiver of the customs, and upon the flight of James II. from England in 1688 refused to forward to him the sum of £1500 as requested; accordingly his name alone was excepted from the pardon issued by the exiled king in 1692. A strong Tory, Duncombe held for a short time the office of receiver of the excise, and in this capacity he profited slightly by a transaction over some exchequer bills which had been falsely endorsed. Consequently he was imprisoned by the House of Commons, and expelled from parliament; and having been released by order of the House of Lords, where his friends were more powerful, he was again imprisoned by the Commons. Tried before the court of king's bench he was found "not guilty" on two occasions and the matter was allowed to drop. Duncombe made three unsuccessful attempts to enter parliament as member for the city of London, and then represented Downton a second time from 1702 until his death. In 1699 he was knighted, and in 1709 he served as lord mayor of London. Upon retiring from business

in 1695 Duncombe caused some stir by giving the representatives of the duke of Buckingham a high price for an estate at Helmsley in Yorkshire, where he built a magnificent house.

He died at his residence at Teddington on the 9th of April 1711, and much of his great wealth passed to his sister, Ursula, wife of Thomas Browne, who took the name of Duncombe. Ursula's great-grandson, Charles Duncombe (1764-1841), was created Baron Feversham in 1826, and in 1868 his grandson, William Ernest, the 3rd baron (b. 1829), was made earl of Feversham. Sir Charles Duncombe's nephew, Anthony Duncombe (c. 1695-1763), who was made a baron in 1747, left an only daughter, Anne (1757-1829), who married Jacob Pleydell-Bouverie, 2nd earl of Radnor, by whom she was the ancestress of the succeeding earls of Radnor.

A celebrated member of the Duncombe family was THOMAS SLINGSBY DUNCOMBE (1796-1861), a Radical politician, who was member of parliament for Hertford from 1826 to 1832 and for Finsbury from 1834 until his death. Duncombe defended Lord Durham's administration of Canada; he sought to obtain the release of John Frost and other Chartist, whose immense petition he presented to parliament in 1842; and he interested himself in the affairs of Charles II., the deposed duke of Brunswick. He showed a practical sympathy with Mazzini, whose letters had been opened by order of the English government, by urging for an inquiry into this occurrence; and also with Kossuth. He died at Lancing on the 13th of November 1861.

See *Life and Correspondence of T. S. Duncombe*, edited by T. H. Duncombe (1868).

DUNDALK, a seaport of Co. Louth, Ireland, in the north parliamentary division, on the Castletown river near its mouth in Dundalk Bay. Pop. of urban district (1901), 13,076. It is an important junction on the Great Northern railway, by the main line of which it is 54 m. N. from Dublin. The company has its works here, and a line diverges to the north-west of Ireland. Dundalk is connected with the port of Greenore (for Holyhead) by a line owned by the London & North-Western railway company of England. The parish church is an old and spacious edifice with a curious wooden steeple covered with copper; and the Roman Catholic chapel is a handsome building in the style of King's College chapel, Cambridge. There are ruins of a Franciscan priory, with a lofty tower. Adjacent to the town are several fine parks and demesnes. Until 1885 a member was returned to parliament. A brisk trade, chiefly in agricultural and dairy produce, is carried on, and the town contains some manufactories. Distilling and brewing are the principal industrial works, and there are besides a flax and jute-spinning mill, salt works, &c. The port is the seat of a considerable trade, mainly in agricultural produce and live stock. It is also the centre of a fishery district and of salmon fisheries. Dundalk was a borough by prescription, and received charters from Edward III. and successive monarchs. Edward Bruce, having invaded Ireland from Scotland in 1315, proceeded south from his landing-place in Antrim, ravaging as he came, to Dundalk, which he stormed, and proclaimed himself king here. In this neighbourhood, too, he was defeated and killed by the English under Sir John de Bermingham in 1318, and at Faughart near Dundalk, near the ruined church of St. Bridget, he is buried.

DUNDEE, JOHN GRAHAM OF CLAVERHOUSE, Viscount (c. 1649-1689), Scottish soldier, was the elder son of Sir William Graham and Lady Madeline Carnegie. Of his youth little record has been kept; but in the year 1665 he became a student at the university of St. Andrews. His education was upon the whole good, as appears from the varied and valuable correspondence of his later years. Young Graham was destined for a military career; and after about four years he proceeded abroad as a volunteer in the service of France. In 1673 or 1674 he went to Holland, and obtained a cornetcy, and he was soon raised to the rank of captain, as a reward for having saved the life of the prince of Orange at the battle of Seneff. A few years later, being disappointed in his hopes of obtaining a regiment, Graham resigned his commission. In the beginning of 1677 he returned to England, bearing, it is said, letters of strong recommendation

from the prince to Charles II. and the duke of York. In 1678 he became a lieutenant, and soon afterwards captain of a troop, in the regiment commanded by his relative the marquis of Montrose. The task before him was the suppression of the Covenanters' rebellion. To this he brought, over and above the feelings of romantic loyalty and the cavalier spirit, which in his case was free from its usual defects, a hatred of the Covenanters which was based largely on his hero-worship of the great Montrose. Further, his uncompromising disposition and unmistakable capacity at once marked him out as a leader upon whom the government could rely. But the difficulties of his task, the open or secret hostility of the whole people, and the nature and extent of the country he was required to watch, were too great for the leader of a small body of cavalry, and in spite of his vigorous and energetic action, Graham accomplished but little. He entered, however, upon his occupation with zest, and interpreted consistently the orders he received. There is evidence, also, that his efforts were appreciated at headquarters in his appointment, jointly with the laird of Earlsbarr, his subaltern, to the office of sheriff-depute of Dumfries and Annandale in March 1679, with powers—specially narrated in his commission—“separation,” conventicles, “disorderly baptisms and marriages,” and the like.

For some years thereafter the position of Graham was in the highest degree difficult and delicate. In the midst of enemies, and in virtue of the most erroneous but direct orders of his government, he combined the functions of soldier, spy, prosecutor and judge. Shortly after the murder of Archbishop Sharp (1679), he was summoned to increased activity. There were reports of rebels gathering near Glasgow, and Graham went in pursuit. On the 1st of June, the Covenanters being in a well-protected position upon the marshy ground of Drumclog, Graham advanced to the attack. Hindered by the ground, he had to wait till the impatience of his adversaries induced them to commence an impetuous attack. The charge of the Covenanters routed the royal cavalry, who turned and fled; Graham himself having a narrow escape. This was the only regular engagement he had with the Covenanters. The enthusiasm raised by this victory was the beginning of a serious and open rebellion.

On the 22nd of June Graham was present at the battle of Bothwell Bridge, at the head of his own troop. Immediately thereafter he was commissioned to search the south-western shires for those who had taken part in the insurrection. In this duty he seems to have been engaged till the early part of 1680, when he disappears for a time from the record of these stringent measures. The wide powers given to him by his commission were most sparingly used, and the gravest accusation made against him in reference to this period is that he was a robber.

He was, in any case, an advocate of rigorous measures, and his own systematic and calculated terrorism, directed principally against the ringleaders, proved far more efficacious than the irregular and haphazard brutalities of other commanders. During these months he was despatched to London, along with Lord Linlithgow, to influence the mind of Charles II. against the indulgent method adopted by Monmouth with the extreme Covenanting party. The king seems to have been fascinated by his loyal supporter, and from that moment Graham was destined to rise in rank and honours. Early in 1680 he obtained a royal grant of the barony of the outlawed Macdougall of Freuch, and the grant was after some delay confirmed by subsequent orders upon the exchequer in Scotland. In April 1680 it appears that his roving commission had been withdrawn by the privy council. He is thus free from all concern with the severe measures which followed the Sanquhar Declaration of the 22nd of June 1680.

The turbulence occasioned by the passing of the Test Act of 1681 required to be quelled by a strong hand; and in the beginning of the following year Graham was again commissioned to act in the disaffected districts. In the end of January he was appointed to the sheriffships of Wigtown, Dumfries, Kirkcudbright and Annandale. He retained his commission in the army—the pernicious combination of his offices being thus repeated. He appears further to have had powers of life and

death in virtue of a commission of justiciary granted to him about the same time. These powers he exercised strictly and in conformity with the tenor of his orders, which were not more severe than he himself desired. He quartered on the rebels, rifled their houses, and, to use his own words, “endeavoured to destroy them by eating up their provisions.” The effect of his policy, if we believe his own writ, is not overstated as

“Death, desolation, ruin and decay.”

The result of a bitter quarrel between Graham and Sir John Dalrymple, who, with many others of the gentry, was far from active in the execution of the government's orders, confirmed his prestige. Graham was acquitted by the privy council of the charges of exaction and oppression preferred against him, and Sir John condemned to fine and imprisonment for interference with his proceedings. In December 1682 Graham was appointed colonel of a new regiment raised in Scotland. He had still greater honours in view. In January 1683 the case of the earl of Lauderdale, late Maitland of Hatton, was debated in the House of Lords. Maitland was proprietor of the lands and lordship of Dundee and Dudhope, and the decree of the Lords against him was in March 1683 issued for the sum of £72,000. Graham succeeded in having part of the property of the defaulter transferred to him by royal grant, and in May he was nominated to the privy council of Scotland.

Shortly afterwards Claverhouse was appointed to be present at the sittings of the Circuit Court of Justiciary in Stirling, Glasgow, Dumfries and Jedburgh, recently instituted for the imposition of the test and the punishment of rebels. Several were sentenced to death. During the rest of the year he attended the meetings of council, in which he displayed the spirit of an obedient soldier rather than that of a statesman capable of independent views. There is, however, one record of his direct and efficacious interference. He declared decisively against the proposal to let loose the Highland marauders upon the south of Scotland.

In June 1684 he was again at his old employment—the inspection of the southern shires; and in August he was commissioned as second in command of the forces in Ayr and Clydesdale to search out the rebels. By this time he was in possession of Dudhope, and on the 10th of June he married Lady Jean, daughter of William, Lord Cochrane. As constable of Dundee he recommended the remission of extreme punishment in the case of many petty offences. He issued from his retirement to take part in a commission of lieutenantancy which perambulated the southern districts as a criminal court; and in the end of the year he was again in the same region on the occasion of disturbances in the town of Kirkcudbright.

Shortly after the death of Charles II. (February 1685) Graham incurred a temporary disgrace by his deposition from the office of privy councillor; but in May he was reinstated, although his commission of justiciary, which had expired, was not renewed.

In May 1685 he was ordered with his cavalry to guard the borders, and to scour the south-west in search of rebels. By act of privy council, a certificate was required by all persons over sixteen years of age to free them from the hazard of attack from government officials. Without that they were at once liable to be called upon oath to abjure the declaration of Renwick, which was alleged to be treasonable. While on this mission he pursued and overtook two men, one of whom, John Brown, called the “Christian carrier,” having refused the abjuration oath, was shot dead. The order was within the authorized powers of Graham.

In 1686 he was promoted to the rank of major-general, and had added to his position of constable the dignity of provost of Dundee. In 1688 he was second in command to General Douglas in the army which had been ordered to England to aid the falling dynasty of the Stuarts.

His influence with James II. was great and of long standing, and amid the hurry of events in this critical time he was created Viscount Dundee on the 12th of November 1688. Throughout the vexed journeyings of the king, Dundee is found accompanying or following him, endeavouring in vain to prompt him to ma-

his stand in England, and fight rather than flee from the invader. At last James announced his resolve to go to France, promising that he would send Dundee a commission to command the troops in Scotland.

Dundee returned to Scotland in anticipation of the meeting of the convention, and at once exerted himself to confirm the waning resolution of the duke of Gordon with regard to holding Edinburgh Castle for the king. The convention proving hostile (March 16th, 1688), he conceived the idea of forming another convention at Stirling to sit in the name of James II., but the hesitancy of his associates rendered the design futile, and it was given up. Previous to this, on the 18th of March, he had left Edinburgh at the head of a company of fifty dragoons, who were strongly attached to his person. He was not long gone ere the news was brought to the alarmed convention that he had been seen clambering up the castle rock and holding conference with the duke of Gordon. In excitement and confusion order after order was despatched in reference to the fugitive. Dundee retired to Dudhope. On the 30th of March he was publicly denounced as a traitor, and in the latter half of April attempts were made to secure him at Dudhope, and at his residence in Glen Ogilvy. But the secrecy and speed of his movements outwitted his pursuers, and he retreated to the north.

In the few years which had elapsed since 1678 he had risen, despite the opposition of his superiors in rank, from the post of captain and the social status of a small Scottish laird to positions as a soldier and statesman and the favourite of his sovereigns, of the greatest dignity, influence and wealth. In this period he had, justly or unjustly, earned the reputation of being a cruel and ruthless oppressor. When the ruling dynasty changed, and he had himself become an outlaw and a rebel, he supported the cause of his exiled monarch with such skill and valour that his name and death are recorded as heroic.

In the Highlands his diplomatic skill was used with effect amongst the chieftains. General Hugh Mackay was now in the field against him, and a Highland chase began. The campaign resembled those of Montrose forty years earlier. The regular troops were at a great disadvantage in the wild Highland country, and Dundee, like Montrose, invariably anticipated his enemy. But, as usual, the army of the clans required the most careful management. After the first few weeks of operations, Dundee's army melted away, and Mackay, unable to follow his opponent, retired also.

Throughout the whole of the campaign Dundee was indefatigable in his exertions with the Highland chiefs and his communications with his exiled king. To the day of his death he believed that formidable succour for his cause was about to arrive from Ireland and France. He justly considered himself at the head of the Stewart interest in Scotland, and his despatches form a record of the little incidents of the campaign, strangely combined with a revelation of the designs of the statesman. It mattered little to him that on the 24th of July a price of £20,000 had been placed upon his head. The clans had begun to reassemble; he was now in command of a considerable force, and in July both sides took the field again. A contest for the castle of Blair forced on the decision. Mackay, in his march towards that place, entered the pass of Killiecrankie, the battleground selected by Dundee and his officers. Here, on the 17th-27th of July 1689, was fought the battle of Killiecrankie (*q.v.*). The Highlanders were completely victorious, but their leader, in the act of encouraging his men, was pierced beneath the breastplate by a bullet of the enemy, and fell dying from his horse. Dundee asked "How goes the day?" of a soldier, who replied, "Well for King James, but I am sorry for your lordship." The dying general replied, "If it goes well for him, it matters the less for me." Dundee was conveyed to the castle of Blair, where he died on the night of the battle. Within an hour or two of his death he wrote a short account of the engagement to King James. The battle, disastrous as it was to the government forces, was in reality the end of the insurrection, for the controlling and commanding genius of the rebellion was no more. The

death of Dundee, in the mist and the confusion of a cavalry charge, formed the subject of numerous legends, the best known of which is the long prevalent tradition that he was invulnerable to all bullets and was killed by a silver button from his own coat.

See Mark Napier, *Memorials and Letters of Graham of Claverhouse* (1859-1862); Bannatyne Club, *Letters of the Viscount Dundee* (1836); C. S. Terry, *John Graham of Claverhouse, Viscount Dundee*; and authorities quoted in *Dict. Nat. Biogr.*, s.v. "Graham of Claverhouse."

DUNDEE, a royal, municipal and police burgh, county of a city, and seaport of Forfarshire, Scotland. Pop. (1891) 153,587; (1901) 161,173. It lies on the north shore of the Firth of Tay, 59½ m. N. by E. of Edinburgh by the North British railway via the Forth and Tay bridges. The Caledonian railway finds access to the city by way of Perth, which is distant about 22 m. W. by S. The general disposition of the town is from east to west, with a frontage on the water of 4 m. The area northwards that has already been built over varies in depth from half a mile to nearly 2½ m. (from Esplanade Station to King's Cross). The city rises gradually from the river to Dundee Law and Balgay Hill. Since the estuary to the E. of Tay bridge is 1½ m. wide, and the commodious docks—in immediate contact with the river at all stages of the tide—are within 12 m. of the sea, the position of the city eminently adapts it to be the emporium of a vast trade by land and sea. But its prosperity is due in a far greater measure to its manufactures of jute and linen—of which it is the chief seat in the United Kingdom—than to its shipping.

Public Buildings.—The town-hall, built in 1734 from the designs of Robert Adam, stands in High Street. It is surmounted by a steeple 140 ft. high, carrying a good peal of bells, and beneath it is a piazza. The old Town Cross, a shaft 15 ft. high, bearing a unicorn with the date of 1586, once stood in High Street also, but was re-erected within the enclosure on the S.W. of Town Churches (see below). Albert Square, with statues of Robert Burns, George Kinloch, the first member for Dundee in the Reform Parliament (both by Sir John Steel), and James Carmichael (1776-1853), inventor of the fan-blade (by John Hutchinson, R.S.A.), contains several good buildings, among them the Royal Exchange in Flemish Pointed (erected in 1853-1856), the Eastern Club-house, and the Albert Institute, founded in memory of the prince consort. The last, built mainly from designs by Sir Gilbert Scott, is one of the most important edifices in the city, since it embraces the art gallery, free library, reference library, museum and several halls. On the north side of the building is the seated figure, in bronze, of Queen Victoria, on a polished red granite pedestal containing bas-reliefs of episodes in Her Majesty's life, the work of Harry Bates, A.R.A. The custom house, near the docks, is in Classical style and dates from 1843. The Sheriff Court buildings and Police Chambers, a structure of Grecian design, with a bold portico, was erected in 1864-1865. The halls used for great public meetings are the Volunteer Drill Hall in Parker Square, and Kinnaird Hall in Bank Street. Of the newer streets, Commercial, Reform, Whitehall, Bank and Lindsay contain many buildings of good design and the principal shops. In Bank Street are the offices of the *Dundee Advertiser*, the leading newspaper in the north-east of Scotland; and in Lindsay Street the headquarters of the *Dundee Courier*. In Dock Street stands the Royal Arch, an effective structure, erected to commemorate the visit of Queen Victoria in 1844. Among places of amusement are the Theatre Royal, the People's Palace theatre, the Music Hall, the Circus and the Gymnasium. The cattle market and slaughter-houses, both on an extensive scale, are in the east end of the city, not far from Camperdown Dock. Dudhope Castle, once the seat of the Scrymgeours, hereditary constables of the burgh—one of whom (Sir Alexander) was a companion-in-arms of Wallace,—was granted by James II. to John Graham of Claverhouse. On his death it reverted to the crown, and at a later date was converted into barracks. When the new barracks at Dudhope Park were occupied, the Castle was transformed into an industrial museum. Though Dundee was once a walled town, the only relic of its walls is the East Port, the preservation of which was due to the tradition that George

Wharft preached from the top of it during the plague of 1544.

Churches.—Of the many churches and chapels the most interesting is Town Churches—St Mary's, St Paul's and St Clement's, the three under one roof—surmounted by the noble square tower, 156 ft. high, called the Old Steeple, once the belfry of the church which was erected on this spot by David, earl of Huntingdon, as a thank-offering for his escape from shipwreck on the shoals at the mouth of the Tay (1293). The church perished, but the bell-tower remained and was restored in 1871-1873 by Sir Gilbert Scott. The fine Roman Catholic pro-cathedral of St Andrew's is in Early English style, and St Paul's Episcopal church, in Decorated Gothic style, with a spire 211 ft. high, from designs by Sir Gilbert Scott, was due to the zeal of Bishop Forbes (1817-1875), who transferred the headquarters of the see of Brechin to Dundee. It occupies the site of the old castle. Memorial churches commemorate the work of Robert Murray McChyne (1813-1843) and of George Gillilan (1813-1878), long ministers in Dundee. John Glas (1695-1773), founder of the Glasites (g.v.), ministered here from 1730 to 1733.

Cemeteries.—The ancient burying-ground in the centre of the city is called the Howf. It has long been closed, but contains several interesting monuments and epitaphs. Not far from it the New Cemetery was laid out in West Bell Street; to the east of Baxter Park lies the Eastern Cemetery; and the Western Cemetery was constructed in Perth Road. The most beautifully situated of all the burying-grounds, however, is the Western Necropolis, which occupies the western portion of the hill of Balgay. A bridge over the ravine connects it with Balgay Park.

Public Parks and Open Spaces.—On the N. of the city rises Dundee Law (571 ft.), the property of the Corporation, a prominent landmark, on the summit of which are traces of an old vitrified fort. The surrounding park covers 18 acres. Near the eastern boundary of the city lies Baxter Park, of 37 acres, presented to the town by Sir David Baxter (1793-1872), a leading manufacturer, and his sisters. It was laid out by Sir Joseph Paxton, and contains a statue of Sir David by Sir John Steell, erected by public subscription. In the west the finely wooded hill of Balgay was acquired in 1869 and 36 acres of the area were converted into a park. Immediately adjoining it on the north is Lochee Park, of 25 acres, given to the city in 1891 by Messrs Cox Brothers of Camperdown Works. In the extreme north lies the park of Fair Muir, of 12 acres, which was secured in 1890, and nearer to the heart of the town is Dudhope or Barrack Park, purchased in 1893. Near the north end of the Tay bridge is Magdalen Green, an old common of 17 acres, and along the shore of the estuary there runs for a distance of 2½ m. from Magdalen Point to beyond Craig Pier a promenade called the Esplanade.

Education.—University College in Nethergate, founded in 1880 by Miss Baxter of Balgavies (d. 1884) and Dr John Boyd Baxter, was opened in 1883, and united to the university of St Andrews in 1890. The affiliation was cancelled in 1895 owing to divergence of view in the governing body, but this was overcome and the college finally incorporated in 1897. The staff consists of a principal, professors and lecturers, and the curriculum, which may be taken by students of both sexes, is especially concerned with medicine and natural and applied science. The endowments exceed £250,000. Adjoining the buildings is the Technical Institute, built and endowed by Sir David Baxter and opened in 1888. In connexion with the high school, a building in the Doric style, dating from 1833, there is a museum which was endowed in 1880 by Mr William Harris. Morgan hospital, a structure in the Scots Baronial style, situated immediately to the north of Baxter Park, was founded in 1868 by John Morgan, a native of Dundee, for the board and education of a hundred boys, sons of indigent tradesmen, but was acquired by the school board and transformed into a secondary school. Besides a high school for girls and Roman Catholic and Episcopalian schools, there are numerous efficient and thoroughly equipped board schools.

Charitable Institutions.—One of the most conspicuous buildings in the city, occupying a prominent position in the centre, is the

Royal Infirmary, a fine structure in the Tudor style. On the southern face of Balgay Hill stands the Royal Victoria hospital for incurables, opened in 1889. In addition to the maternity hospital and nurses' home, there are several institutions devoted to special afflictions and diseases—among them the Blind and the Deaf and Dumb institutions, the Royal asylum, the fever hospital at King's Cross, and, in the parish of Mains—beyond the municipal boundary—the Baldovan asylum for imbeciles, founded in 1854 by Sir John Ogilvy and said to be the earliest of its kind in Scotland, besides the smallpox and cholera hospital. The large Dundee hospital adjoins the poorhouse, and an epidemic hospital has been built in the Fair Muir district. One of the convalescent homes is situated at Broughty Ferry. Among other institutions are the Royal Orphan and the Wellburn Charitable institutions, the rescue home for females, the sailors' home and Lady Jane Ogilvy's orphanage in Mains.

Trade.—Hector Boece, in his *History and Croniklis of Scotland*, thus quaintly writes of the manufactures of Dundee in the opening of the 16th century—"Dunde, the toum quhair we wer born; quhair mony virtewus and lauborius pepill ar in, making of claitth." Jute is, *par excellence*, the industry of the city. Enormous quantities of the raw material—estimated at 300,000 tons a year—are imported directly from India in a fleet solely devoted to this trade, and many of the factories in Bengal are owned by Dundee merchants. Fabrics in jute range from the roughest sacking to carpets of almost Oriental beauty. Another staple industry is the linen manufacture, which is also one of the oldest, although it was not till the introduction of steam power that headway was made. Bell Mill, erected in 1806, was the first work of any importance, and the first power-loom factory dates from 1836. Now factories and mills are to be counted by the score, and the jute, hemp and flax manufactures alone employ about 50,000 hands, while the value of the combined annual output exceeds £6,000,000. Some of the works are planned on a colossal scale, and many of the buildings in respect of design and equipment are among the finest and most complete in the world. In the thriving quarter of Lochee are situated the Camperdown Linen Works, covering an immense area and employing more than 5000 hands. The chimney-stalk (282 ft. high), in the style of an Italian campanile, built of parti-coloured bricks with stone cornices, is a conspicuous feature. The chief textile products are drills, ducks, canvas (for which the British navy is the largest customer), ropes, sheetings, sackings and carpets. Dundee is also celebrated for its confectionery and preserves, especially marmalade. Among other prominent industries are bleaching and dyeing, engineering, shipbuilding, tanning, the making of boots and shoes and other goods in leather, foundries, breweries, corn and flour mills, and the construction of motor-cars.

Shipping.—By reason of its excellent docking facilities Dundee can cope with a shipping trade of the largest proportions. On the front wharves and harbour works extend for 2 m., and the docks cover an area of 3½ acres, made up thus—Earl Grey Dock, 5½ acres; King William IV. Dock, 6½ acres; Tidal Harbour, 4½ acres; Victoria Dock, 10½ acres; Camperdown Dock, 8½ acres. There are, besides, graving docks, the Ferry harbour and timber ponds. The warehouses are capacious and the ample quays equipped with steam cranes and other modern appliances. In 1898 there entered and cleared 2914 vessels of 1,390,331 tons; in 1904 the numbers were 2428 vessels of 1,227,429 tons. At the close of 1904 the registered shipping of the port was 131 vessels of 109,885 tons. Dundee is the seat of the Arctic fishery, once an important and lucrative business, but now shrunk to the most meagre dimensions in consequence of the increasing scarcity of whales and seals. There is regular communication by steamer with London, Hull, Newcastle, Liverpool and Leith, besides Rotterdam, Hamburg and other continental ports. Of the local excursions the two hours' run to Perth is the favourite summer trip.

Local Government.—Dundee returns two members to parliament. The city council consists of the lord provost, bailies and councillors. The corporation owns the gas and water supplies

(the latter drawn from the loch of Lintrathen, 18 m. to the N.W.) and the electric tramcars.

History.—There appears to be some doubt as to the origin of the name of Dundee. It is extravagant to trace it to the Latin *Donum Dei*, "the gift of God," as some have done, or the Celtic *Dun Dhiá*, "the hill of God." More probably it is the Gaelic *Dun Taw*, "the fort of the Tay," of which the Latin *Taodunum* is a transliteration—the derivation pointing to the fact of a Pictish settlement on the site. The earliest authentic mention of the city is in a deed of gift by David, earl of Huntingdon, younger brother of William the Lion, dated about 1200, in which it is designated as "Dunde." Shortly afterwards it was erected into a royal burgh by William the Lion. When Edward I. visited it, however, as he did twice (in 1296 and 1303) with hostile intent, he is said to have removed its charter. Consequently Robert Bruce and successive kings confirmed its privileges and rights, and Charles I. finally granted it its great charter. Dundee played a prominent part in the War of Scottish Independence. Here Wallace finished his education, and here he slew young Selby, son of the English constable, in 1291, for which deed he was outlawed. In that year the town fell into the hands of the English, and it was whilst engaged in besieging the castle in 1297 that Wallace withdrew to fight the battle of Stirling Bridge. In their incursion into Scotland under John of Gaunt the English captured and partially destroyed the town in 1385, but retreated to meet a counter-invasion of their own country. The English seized it again for a brief space during one of the 1st earl of Hertford's devastating raids in the reign of Edward VI. Dundee bore such a prominent part in propagating the Reformed doctrines that it was styled "the Scottish Geneva." It saw more trouble at the time of the Civil War, for the marquis of Montrose sacked it in 1645, and then gave a considerable portion of it to the flames. Charles II. spent a few days in the castle after his crowning at Scone (January 25, 1651). In the same year General Monk demanded the submission of the town to Cromwell, and on its refusal captured it after an obstinate resistance and visited it with condign punishment. More than one-sixth of the inhabitants and garrison, including its governor Lumsden, were put to the sword, and no fewer than 60 vessels were seized and filled with plunder; but the ships, says Gumble in his *Life of Monk*, "were cast away within sight of the town and that great wealth perished." In 1684 John Graham of Claverhouse—whose family derived its name from the lands of Claverhouse in the parish of Mains immediately to the north of the town—became constable, and in 1688 provost. In the same year James II. created him Viscount Dundee. Thenceforward the annals of the town cease to touch national history, save at very rare intervals. The greatest local disaster of modern times was the destruction of the first Tay bridge (see TAY).

Many interesting old documents have been preserved in the Town House, such as certain characteristic despatches from Edward I. and Edward II., the original charter of Robert Bruce, dated 1327, a papal order from Leo X., and a letter from Queen Mary, dated 1564, providing for extra-mural interments. It may be mentioned that to describe Claverhouse himself as "bonnie Dundee" is a modern invention, the old song from which Sir Walter Scott borrowed a hint for his refrain referring solely to the town.

Since the middle and particularly during the last quarter of the 19th century many of the more unsightly districts have been demolished. In the process several picturesque but insanitary buildings, narrow winding streets and unsavoury closes disappeared, along with a few structures of more or less historic interest, like the castle, the mint and numerous convents. The wholesale clearances, however, improved both the public health and the appearance of the city, some of the new thoroughfares vieing with the finest business streets of the largest commercial centres in the United Kingdom. Queen Victoria granted a charter to Dundee, dated the 25th of January 1889, erecting it to the status of a city, and since 1892 its chief magistrate has been styled lord provost.

Among men more or less eminent who were born in Dundee may

be named Hector Boece (1465-1536), the historian; George Dempster of Dunnichen (1732-1818), the agriculturist, a former owner of Skibo; Thomas Dick (1774-1857), the author of *The Christian Philosopher*; Admiral Lord Duncan (1731-1804); Viscount Dundee (1643-1689); James Halyburton (1518-1580), the Scottish Reformer, who was provost of the town for thirty-three years; Sir James Ivory (1765-1842), the mathematician, who bequeathed his science library to the town, and his nephew Lord Ivory (1792-1866), the judge; Sir George Mackenzie (1636-1691), the celebrated lawyer; Sir Alexander Scrymgeour (d. 1310), Wallace's standard-bearer, and many of the Scrymgeours, his successors, who were constables of the town; James (1495-1553), John (1500-1556) and Robert Wedderburn (1510-1557), the poets, who were all concerned in the authorship or collection of the book of *Gude and Godlie Ballatis* published in 1578; Sir John Wedderburn (1599-1679), the physician; and Sir Peter Wedderburn (1616-1679), the judge. Many well-known persons lived for longer or shorter periods in the town. James Chalmers (1782-1853), the inventor of the adhesive postage stamp (1834), was a bookseller in Castle Street. George Constable of Wallace Craigie, the prototype of Jonathan Oldbuck in Sir Walter Scott's *Antiquary*, had a residence in the east end of Seagate, the house standing until about 1820. Thomas Hood's father was a native and the poet spent part of his youth in the town, his first literary effort appearing in the *Dundee Advertiser* about 1816. James Bowman Lindsay (1799-1862), electrician and philologist, carried on his experiments for many years in Dundee, where he died. Robert Nicoll (1814-1837), the poet, kept a circulating library in Castle Street; and William Thom (1798-1848), the writer of *The Rymes of a Handloom Weaver*, was buried in the Western Cemetery.

Suburbs.—Close to the municipal boundaries on the N.W. lies Benvie, where John Playfair (1748-1819), the mathematician, was born, and which has a mineral well that once enjoyed considerable repute. Camperdown House, the seat of the earl of Camperdown, a fine building of Greek design, standing in beautiful grounds, is situated in the parish. Fowls, 5 m. N.W., is remarkable for its church, which dates from the 13th century, but has even been assigned to the 12th. It contains a carved ambry and rood-screen (with a curious representation of the Crucifixion), decorated font, crocketed door canopy and several pictures. The ruined castle adjoining the church ultimately became a dwelling for labourers. The Dell of Balruddery is rich in geological and botanical specimens. Lundie, 3 m. farther out in the same direction, contains several lakelets, and its kirkyard is the burial-place of the earls of Camperdown. Tealing, 4 m. N. of Dundee, was the scene of the ministry of John Glas before he was deposed for heresy.

AUTHORITIES.—David Barrie, *The City of Dundee Illustrated* (Dundee, 1890); Alexander Maxwell, *Old Dundee* (Dundee, 1891); A. C. Lamb, *Dundee: its Quaint and Historic Buildings* (Dundee, 1895); A. H. Millar, *Roll of Eminent Burgesses of Dundee* (Dundee, 1887).

DUNDERLANDSDAL, a valley of northern Norway, in Nordland amt (county), draining south-westward from the neighbouring glaciers to the Ranenfjord (lat. 66° 20' N.). There are deposits of iron ore, the working of which was undertaken in 1902 by the Dunderland Iron Ore Company, water-power being provided by the strong Dunderland river. There are also pyrites mines. At the mouth of the river is Mo, a considerable trading village. The valley is remarkable for several stalactite caverns in the limestone, some of the tributary streams flowing for considerable distances underground. From Mo a fine road crosses the mountains to the head-lake of the great Ume river, draining to the Baltic, and from the head of Dunderlandsdal a sequestered bridle-path runs to Saltal on the Skjerstadfjord, with a branch through the magnificent Junkersdal.

DUNDONALD, THOMAS COCHRANE, 10TH EARL OF (1775-1860), British admiral, was born at Annsfield in Lanarkshire on the 14th of December 1775. He came of an old Scottish family, the first earl having been Sir William Cochrane (d. 1686), a soldier who was created Baron Cochrane in 1647 and earl of

Dundonald in 1669. He was the son of Archibald Cochrane, 9th Earl (1749-1831), who is remembered as a most ingenious, but also most unfortunate, scientific speculator and inventor, who was before his time in suggesting and attempting new processes of alkali manufacture, and various other uses of applied science. The family was greatly impoverished owing to his losses over these schemes, but still possessed a good deal of interest. By the help of friends Thomas was provided with a commission in an infantry regiment, and at the same time put on the books of a man-of-war by his uncle, Captain A. F. I. Cochrane (1758-1832), while still a boy. He finally chose the navy, and went to sea in his uncle's ship, the "Hind," in 1793. He could already count nearly five years' nominal service, an example of those naval abuses which he was to denounce (and to profit by) during a large part of his career. His promotion was rapid: He became a lieutenant in 1796. While in that rank he was led by his self-assertive temper into a quarrel with his superior, Lieutenant Philip Beaver (1766-1813), for which he was sent before a court-martial. A warning to avoid flippancy in future was, however, the worst that happened to him.

In 1800 he was appointed to the command of the "Speedy" brig, a small vessel in which he gained a great and deserved reputation as a daring and skilful officer. His capture of the Spanish frigate "El Gamo" (32) on the 6th of May 1801 was indeed a feat of unparalleled audacity. His promotion to post rank followed on the 8th of August. Though he was apt to represent himself as disliked and neglected by the admiralty, and was frequently insolent towards his superiors, he was, as a matter of fact, pretty constantly employed, and he more than justified his appointments by his activity and success as captain of the "Pallas" (32) and "Impérieuse" (38) on the ocean and in the Mediterranean. Unfortunately for himself he secured his return to parliament as member for Honiton in 1806 and for Westminster in 1807. In the House of Commons he soon made his mark as a radical, and as a denouncer of naval abuses. But his views did not prevent him from profiting to the utmost by one very bad abuse, for he did his utmost to secure the retention of his frigate in port, in order that he might be able to attend parliament. In spite of his radical opinions he made a furious attack on the admiralty for the new prize money regulations which diminished the shares of the captains to the advantage of the men. In April 1809 he was engaged in the attack on the French squadron in the Basque Roads, which was very ill conducted by Lord Gambier. The conduct of Lord Cochrane, as he was called till the death of his father, was brilliant and was rewarded by the order of the Bath, but his aggressive temper led him into making attacks on the admiral which necessitated a court-martial on Gambier. The admiral was acquitted, and Cochrane naturally fell into disfavour with the admiralty. He was not employed again till 1813, when he was named to the command of the "Tonnant," which was ordered for service as flagship on the coast of America. In the interval he was restlessly active in parliament in denouncing naval abuses, and was also, most disastrously for himself, led into speculations on the Stock Exchange, by which he was brought at the beginning of 1814 into pressing danger of total ruin.

At this moment a notorious fraud was perpetrated on the Stock Exchange by an uncle of his and by other persons with whom he habitually acted in his speculations. Lord Cochrane was brought to trial with the others before Lord Ellenborough on the 8th of June 1814 and all were condemned. He was sentenced to an hour in the pillory, which was remitted, and to fine and imprisonment, which were enforced. He continued to assert his innocence, and to protest that he had been unjustly condemned, but he was expelled from parliament and the order of the Bath. He was, however, almost immediately re-elected member for Westminster, but he had to serve his term (one year) of imprisonment, and, after escaping and being recaptured, he regained his liberty in 1815 on payment of the fine of £1000 to which he had been sentenced.

In 1817 he accepted the invitation of the Chileans, who were

then in revolt against Spain, to take command of their naval forces, and remaining in their service until 1822 contributed largely to their success. His capture of the Spanish frigate "Esmeralda" (40) in the harbour of Callao, on the 5th of November 1820, was an achievement of signal daring. In 1823 he transferred his services to Brazil, where he helped the emperor Dom Pedro I. to shake off the yoke of Portugal; but by the end of 1825 he had fallen out with the Brazilians, and he returned to Europe. His activity was next devoted to the aid of the Greeks, then at the end of their struggle with the Turks, but he found no opportunity for distinguishing himself, and in 1828 he returned home. His efforts were now steadily directed to securing his restoration to the navy, and in this he succeeded in 1832; but though he was granted a "free pardon" he failed to obtain the new trial for which he was anxious, or to secure the arrears of pay he claimed.¹ He was restored to his place in the order of the Bath in 1847. In 1848 he was appointed to the command of the North American and West India station, which he retained till 1851. At various periods of his life he occupied himself with scientific invention. He took out patents for lamps to burn oil of tar, for the propulsion of ships at sea, for facilitating excavation, mining and sinking, for rotary steam-engines and for other purposes; and so early as 1843 he was an advocate of the employment of steam and the screw propeller in warships. During the Crimean War he revived his "secret war plan" for the total destruction of an enemy's fleet, and offered to conduct in person an attack on Sevastopol and destroy it in a few hours without loss to the attacking force. This plan, the details of which have never been divulged, he had proposed so far back as 1811, and the committee which was then appointed to consider it reported on it as effective but inhuman. Lord Dundonald died in London on the 30th of October 1860, and was buried in Westminster Abbey. No one ever excelled him in daring and resource as a naval officer, but he suffered from serious defects of character, and even those who think him guileless of the charge on which he was convicted in 1814 must feel that he had his own imprudence and want of self-command to thank for many of his misfortunes.

He was succeeded in the title by his son Thomas as 11th earl (d. 1885), and the latter by his son Douglas (b. 1852) as 12th earl, a distinguished cavalry officer who became a lieutenant-general in 1907.

The 10th earl's *Autobiography of a Seaman* (2 vols., 1860-1861), the main source for his *Life* (1869, by his son and heir), is written with spirit, but it was composed at the end of his career when his memory was failing, and was chiefly executed by others. He also wrote *Notes on the Mineralogy, Government and Condition of the British West India Islands* (1851) and a *Narrative of Services in the Liberation of Chili, Peru and Brazil* (1858). The whole story of his trial and of the Stock Exchange fraud for which he was condemned has been examined by Mr. J. B. Atlay in *The Trial of Lord Cochrane before Lord Ellenborough* (1897).

DUNEDIN, a city of New Zealand, capital of the provincial district of Otago, and the seat of a bishop, in Taieri county. Pop. (1906) 36,070; including suburbs, 56,020. It lies 15 m. from the open sea, at the head of Otago harbour, a narrow inlet (averaging 2 m. in width) on the south-eastern coast of South Island. The situation was chosen on the consideration of this harbour alone, for the actual site offered many difficulties, steep forest-clad hills rising close to the sea, and rendering reclamation necessary. The hills give the town a beautiful appearance, as the forest was allowed to remain closely embracing it, being preserved in the public ground named the Town Belt. The principal thoroughfare is comprised in Prince's Street and George Street, running straight from S.W. to N.E., and passing through the Octagon, which is surrounded by several of the principal buildings. From these streets others strike at right angles down to the harbour, while others again lead obliquely up towards the Belt, beyond which are extensive suburbs. There are several handsome commercial and banking houses.

¹ In 1878, as the result of the report of a select committee of the House of Commons appointed in 1877, a grant of £5000 was made to the then Lord Cochrane "in respect of the distinguished services of his grandfather, the late earl of Dundonald."

The town hall, Athenaeum and museum are noteworthy buildings, the last having a fine biological collection. The university, founded in 1869, built mainly of basalt, has schools of arts, medicine, chemistry and mineralogy. It is in reality a university college, for though it was originally intended to have the power of conferring degrees, it was subsequently affiliated to the New Zealand University. The churches are numerous and some are particularly handsome; such as the First church, which overlooks the harbour, and is so named from its standing on the site of the church of the original settlers; St Paul's, Knox church and the Roman Catholic cathedral of St Joseph. Finally, one of the most striking buildings in the city is the high school (1885) with its commanding tower. The white Oamaru stone is commonly used in these buildings. The primary and secondary schools of the town are excellent, and there is a small training college for state teachers. Besides the Belt there are several parks and reserves, including botanical and acclimatization gardens, the so-called Ocean Beach, and two race-courses.

Dunedin is connected by rail with Christchurch northward and Invercargill southward, with numerous branches. Electric tramways serve the principal thoroughfares and suburbs. The most important internal industries are in wool and frozen meat. The harbour is accessible, owing to extensive dredging, to vessels drawing 19 ft., at high tide; and Dunedin is the headquarters of the coasting services of the Union Steamship Co. Port Chalmers, however (9 m. N.E. by rail) though incapacitated by its site from growing into a large town, is more readily accessible for shipping, and has extensive piers and a graving dock. Dunedin is governed by a mayor and corporation, and most of its numerous suburbs are separate municipalities.

The colony of Otago (from a native word meaning ochre, which was found here and highly prized by the Maoris as a pigment for the body when preparing for battle) was founded as the chief town of the Otago settlement by settlers sent out under the auspices of the lay association of the Free Church of Scotland in 1848. The discovery of large quantities of gold in Otago in 1861 and the following years brought prosperity, a great "rush" of diggers setting in from Australia. Gold-dredging, in the hands of rich companies, remains a primary source of wealth in the district.

DUNES,¹ or **DUNKIRK DUNES**, **BATTLE OF**, was fought near Dunkirk on the 24th of May (3rd of June) 1658, between the French and English army under the command of Marshal Turenne and the Spanish army under Don Juan of Austria and the prince of Condé. The severest part of the fighting was borne by the English contingents on either side. Six thousand English infantry under General Lockhart were sent by Cromwell to join the army of Turenne, and several Royalist corps under the command of the duke of York (afterwards James II.) served in the Spanish forces. The object of the Spaniards was to relieve Dunkirk, which Turenne was besieging, and the complete victory of the French and English caused the speedy surrender of the fortress.

DUNFERMLINE, ALEXANDER SETON, 1ST EARL OF (c. 1555-1622), was the fourth son of George, 5th Lord Seton, and younger brother of Robert, 1st earl of Winton. He was sent as a boy to Rome, where he studied at the Jesuits' College with a view to becoming a priest. He turned, however, to the study of law, and after some years' residence in France was called to the bar about 1577. He was suspected of Romanist leanings by the officials of the Scottish kirk, and was temporarily deprived of the priory of Pluscardine, which had been granted to him by his god-mother, Queen Mary. In 1583 he accompanied his father, Lord Seton, on an embassy to Henry III. of France. His promotion was now rapid: he was made extraordinary lord of session in 1586 as prior of Pluscardine, ordinary lord of session in 1588 as lord Urquhart, judge in 1593, lord president of the court session in 1598, Baron Fyvie in 1597 and chancellor in 1604. In 1595 he was one of the commission formed by James VI. to control the royal finance. The eight commissioners were known from their number as the Octavians, and were

¹ For the word "dune" see DOWN.

relieved of their functions about two years later. Urquhart's continued influence was, however, assured, in spite of the animosity of the kirk, by his appointment as lord provost of Edinburgh of nine successive years. He showed considerable independence in his relations with James VI., and dissuaded him from his intention of forming a standing army in readiness to enforce his claims to the English crown. He was entrusted with the care of Prince Charles, afterwards Charles I., after the king's departure for England, and arranged the details of the union between Scotland and England. He became chancellor of Scotland in 1604, and on the 4th of March 1605 he was created earl of Dunfermline. He died at Pinkie House, near Musselburgh, on the 16th of June 1622.

His son **CHARLES**, 2nd earl of Dunfermline (c. 1608-1672), was the offspring of his third marriage with Margaret Hay, sister of John, 1st earl of Tweeddale. He signed the National Covenant and was one of the leaders of the Presbyterian party, but as one of the "Engagers" of 1648 he was prevented from holding any public office, and after the execution of Charles I. he joined Charles II. on the continent. He was made privy councillor at the Restoration, extraordinary lord of session and lord of the articles in 1667, and in 1671 lord privy seal. He died in May 1672. The earldom was then held successively by his sons Alexander (d. 1675) and James; but at the latter's death, at St Germain on the 26th of December 1694, the title became extinct.

See G. Seton, *Memoir of Alex. Seton, first Earl of Dunfermline* (1882); and Sir Robert Douglas, *Scotts Peerage*, vol. ii. (1906, edited by Sir J. B. Paul).

DUNFERMLINE, JAMES ABERCROMBY, 1ST BARON (1776-1858), third son of General Sir Ralph Abercromby, was born on the 7th of November 1776. He was called to the bar at Lincoln's Inn in 1801, and became a commissioner in bankruptcy, and subsequently steward for the estates of the 5th duke of Devonshire. In 1807 he was chosen member of parliament for the borough of Midhurst, and in 1812 was returned for Calne by the influence of the 3rd marquess of Lansdowne. He attached himself to the Whigs, but his chief interest was reserved for Scottish questions, and on two occasions he sought to change the method of electing representatives to parliament for the city of Edinburgh. When the Whigs under George Canning came into power in 1827, Abercromby was made judge-advocate-general, and became chief baron of the exchequer of Scotland in 1830, when he resigned his seat in parliament. This office was abolished in 1832, and Abercromby received a pension of £2000 a year, and was sent as member for Edinburgh to the reformed parliament. After being an unsuccessful candidate for the office of speaker he joined the cabinet of Earl Grey in 1834 as master of the mint. Again a candidate for the speakership in the new parliament of 1835, Abercromby was elected to this office after an exceptionally long contest by a majority of ten votes. As speaker he was not very successful in quelling disorder, but he introduced several important reforms in the management of private bills. Resigning his office in May 1839 he was created Baron Dunfermline of Dunfermline, and granted a pension of £4000 a year. He continued his interest in the affairs of Edinburgh, and was one of the founders of the United Industrial school. He died at Colinton House, Midlothian, on the 17th of April 1858, and was succeeded in the title by his only son, Ralph. His wife was Marianne, daughter of Egerton Leigh of West Hall, High Leigh, Cheshire. He wrote a life of his father, Sir Ralph Abercromby, which was published after his death (Edinburgh, 1861).

See Spencer Walpole, *History of England* (London, 1890); *Gravelle Memoirs*, edited by H. Reeve (London, 1896); Lord Cockburn's *Journal* (Edinburgh, 1874).

DUNFERMLINE (Gaelic, "the fort on the crooked linn"), a royal, municipal and police burgh of Fifeshire, Scotland. Pop. (1891) 22,157; (1901) 25,250. It is situated on high ground 3 m. from the shore of the Firth of Forth, with two stations on the North British railway—Lower Dunfermline 1½ m., and Upper Dunfermline 1¼ m. N.W. of Edinburgh, via the Forth Bridge. The town is intersected from north to south by Pittencrief Glen,

a deep, picturesque and tortuous ravine, from which the town derives its name and at the bottom of which flows Lyne Burn.

The history of Dunfermline goes back to a remote period, for the early Celtic monks known as Culdees had an establishment here; but its fame and prosperity date from the marriage of Malcolm Canmore and his queen Margaret, which was solemnized in the town in 1070. The king then lived in a tower on a mound surrounded on three sides by the glen. A fragment of this castle still exists in Pittencrieff Park, a little west of the later palace. Under the influence of Queen Margaret in 1075 the foundations were laid of the Benedictine priory, which was raised to the rank of an abbey by David I. Robert Bruce gave the town its charter in 1322, though in his *Fife: Pictorial and Historical* (ii. 223), A. H. Millar contends that till the confirming charter of James VI. (1588) all burghal privileges were granted by the abbots.

In the 18th century Dunfermline impressed Daniel Defoe as the most prosperous of "full perfection of decay," but it is now one of the most prosperous towns in Scotland. Its staple industry is the manufacture of table linen. The weaving of damask was introduced in 1718 by James Blake, who had learned the secret of the process in the workshops at Drumsheugh near Edinburgh, to which he gained admittance by feigning idiocy; and since that date the linen trade has advanced by leaps and bounds, much of the success being due to the beautiful designs produced by the manufacturers. Among other industries that have largely contributed to the welfare of the town are dyeing and bleaching, brass and iron founding, tanning, machine-making, brewing and distilling, milling, rope-making and the making of soap and candles, while the collieries in the immediate vicinity are numerous and flourishing.

The town is well supplied with public buildings. Besides the New Abbey church, the United Free church in Queen Anne Street founded by Ralph Erskine, and the Gillespie church, named after Thomas Gillespie (1708-1774), another leader of the Secession movement, possess some historical importance. Erskine is commemorated by a statue in front of his church and a sarcophagus over his grave in the abbey churchyard; Gillespie by a marble tablet on the wall above his resting-place within the abbey. The Corporation buildings, a blend of the Scots Baronial and French Gothic styles, contain busts of several Scottish sovereigns a statue of Robert Burns, and Sir Noel Paton's painting of the "Spirit of Religion." Other structures are the County buildings, the Public, St Margaret's, Music and Carnegie halls, the last in the Tudor style, Carnegie public baths, high school (founded in 1560), school of science and art, and two hospitals. Several distinguished men have been associated with Dunfermline. Robert Henryson (1430-1506), the poet, was long one of its schoolmasters. John Row (1568-1646), the Church historian, held the living of Carnock, 3 m. to the E., and David Ferguson (d. 1598) who made the first collection of Scottish proverbs (not published till 1641), was parish minister; Robert Gillilan (1798-1850), the poet, and Sir Joseph Noel Paton (1821-1901), painter and poet—whose father was a designer of patterns for the damask trade—were all born here. Andrew Carnegie (b. 1837), however, is in a sense the most celebrated of all her sons, as he is certainly her greatest benefactor. He gave to his birthplace the free library and public baths, and, in 1903, the estate of Pittencrieff Park and Glen, rich in historical associations as well as natural charm, together with bonds yielding £25,000 a year, in trust for the maintenance of the park, the support of a theatre for the production of plays of the highest merit, the periodical exhibitions of works of art and science, the promotion of horticulture among the working classes and the encouragement of technical education in the district. The town is governed by a provost, bailies and council, and, with Stirling, Culross, Inverkeithing and Queensferry (the Stirling group), combines in returning a member to parliament.

Dunfermline Abbey is one of the most important remains in Scotland. Excepting Iona it has received more of Caledonia's royal dead than any other place in the kingdom. Within its precincts were buried Queen Margaret and Malcolm Canmore; their sons Edgar and Alexander I., with his queen; David I. and

his two queens; Malcolm IV.; Alexander III., with his first wife and their sons David and Alexander; Robert Bruce, with his queen Elizabeth and their daughter Matilda; and Annabella Drummond, wife of Robert III. and mother of James I. Bruce's heart rests in Melrose, but his bones lie in Dunfermline Abbey, where (after the discovery of the skeleton in 1878) they were reinterred with fitting pomp below the pulpit of the New church. In 1891 the pulpit was moved back and a monumental brass inserted in the floor to indicate the royal vault. The tomb of St Margaret and Malcolm, within the ruined walls of the Lady chapel, was restored and enclosed by command of Queen Victoria. During the winter of 1303 the court of Edward I. was held in the abbey, and on his departure next year most of the buildings were burned. When the Reformers attacked the abbey church in March 1560, they spared the nave, which served as the parish church till the 19th century, and now forms the vestibule of the New church. This edifice, in the Perpendicular style, opened for public worship in 1821, occupies the site of the ancient chancel and transepts, though differing in style and proportions from the original structure. The old building was a fine example of simple and massive Norman, as the nave testifies, and has a beautiful doorway in its west front. Another rich Norman doorway was exposed in the south wall in 1903, when masons were cutting a site for the memorial to the soldiers who had fallen in the South African War. A new site was found for this monument in order that the ancient and beautiful entrance might be preserved. The venerable structure is maintained by the commissioners of woods and forests, and private munificence has provided several stained-glass windows. Of the monastery there still remains the south wall of the refectory, with a fine window. The palace, a favourite residence of many of the kings, occupying a picturesque position near the ravine, was of considerable size, judging from the south-west wall, which is all that is left of it. Here James IV., James V. and James VI. spent much of their time, and within its walls were born three of James VI.'s children—Charles I., Robert and Elizabeth. After Charles I. was crowned he paid a short visit to his birthplace, but the last royal tenant of the palace was Charles II., who occupied it just before the battle of Pitreavie (20th of July 1650), which took place 3 m. to the south-west, and here also he signed the National League and Covenant.

See A. H. Millar's *Fife: Pictorial and Historical* (2 vols. 1895); and Sheriff Eneas Mackay's *History of Fife and Kinross* (1896).

DUNGANNON, a market town of Co. Tyrone, Ireland, in the east parliamentary division, on an acclivity 8 m. W. of the south-western shore of Lough Neagh. Pop. of urban district (1901) 3694. It is 103 m. N.N.W. from Dublin by the Great Northern railway, and a branch line runs thence to Cookstown. The only public buildings of note are the parish church, with an octagonal spire, and a royal school founded in 1614 and settled in new buildings at the end of the 18th century; it is now managed by the county Protestant Board of Education. Linens, muslin and coarse earthenware are manufactured, tanning is prosecuted, and there is trade in corn and timber. The early history of the place is identified with the once powerful family of the O'Neills, whose chief residence was here, and a large rath or earthwork north of the town was the scene of the inauguration of their chiefs, but of the castle and abbey founded by this family there are no remains. In Dungannon the independence of the Irish parliament (to which the town returned two members) was proclaimed in 1782. The town was formerly corporate, and was a parliamentary borough returning one member to the Imperial parliament until 1885.

DUNGARPUR, a native state of India, in the Rajputana agency, in the extreme south of Rajputana. A large portion is hilly, and inhabited by Bhils. Its area is 1447 sq. m. In 1901 the total population was 100,103, showing an increase of 2% in the decade. The revenue is £15,100, and the tribute £276. An annual fair is held at Banesar. Kherwara is the headquarters of the Mewar Bhil corps.

The chiefs of Dungarpur, who bear the title of maharawal, are descended from Mahup, eldest son of Karan Singh, chief of Mewar in the 12th century, and claim the honours of the elder line

of Mewar. Mahup, disinherited by his father, took refuge with his mother's family, the Chauhans of Bagar, and made himself master of that country at the expense of the Bhil chiefs. The town of Dungarpur (pop. 6094 in 1901), the capital of the state, was founded towards the end of the 14th century by his descendant Rawal Bir Singh, who named it after Dugaria, an independent Bhil chieftain whom he had caused to be assassinated. After the death of Rawal Udai Singh of Bagar at the battle of Khanua in 1527, his territories were divided into the states of Dugarpur and Banswara, the name of Bagar being still often applied to the tract covered by these states. Dugarpur fell under the sway of the Moguls and Marhattas in turn, and was taken under British protection by treaty in 1818.

DUNGARVAN, a market town and seaport of Co. Waterford, Ireland, in the west parliamentary division, 28½ m. W.S.W. from Waterford by the Waterford and Malloy branch of the Great Southern & Western railway. Pop. of urban district (1901) 4850. It is situated on the south coast, on the Bay of Dugarvan, at the mouth of the Colligan, which divides the town into two parts, connected by a bridge of a single arch. The eastern suburb is called Abbeyside, where the remains of an ancient keep, erected by the M'Graths, still exist, together with portions of an Augustinian friary, founded by the same family in the 14th century and incorporated with a Roman Catholic chapel. In the main portion of the town a part of the keep of a castle of King John remains. Brewing is carried on, and there are woollen mills. The exports consist chiefly of agricultural produce. Dugarvan was incorporated in the 15th century, was represented by two members in the Irish parliament until the Union, and returned a member to the Imperial parliament until 1885. It was fortified with walls by John when the castle was built. A story is told that Cromwell spared the town from bombardment owing to the wit of a woman who drank his health at the town-gate.

DUNGENESS, a promontory of the south coast of England, in the south of Kent, near the town of Lydd. It is a low-lying broad bank of shingle, forming the seaward apex of the great level of the Romney Marshes. Its seaward accretion is estimated at 6 ft. annually. Its formation is characteristic, consisting of a series of ridges forming a succession of curves from a common centre. It is unique, however, among the great promontories of the south coast of England, the accretion of gravel banks falling into deep water contrasting with the cliff-bound headlands of the North Foreland, Beachy Head and the Lizard, and with the low eroded Selsey Bill, off which the sea is shallow. A lighthouse (50° 55' N., 0° 58' E.) stands on the ness, which has been the scene of many shipwrecks, and has been lighted since the time of James I. There are also here Lloyds' signalling station, coast-guard stations, and the terminus of a branch of the South-Eastern & Chatham railway.

The name Dungeness has also been applied elsewhere; thus the point on the north side of the eastern entrance to Magellan Strait is so called, and there is a town of Dungeness near a promontory on the coast of Washington, U.S.A. (Strait of Juan de Fuca).

DUNGEON, the prison in a castle keep, so called because the Norman name for the latter is donjon (*q.v.*), and the dungeons or prisons (*q.v.*) are generally in its lowest storey. (See **KEEP**.)

DUNKELD, a town of Perthshire, Scotland, on the left bank of the Tay, 15½ m. N.W. of Perth by the Highland railway. Pop. (1901) 586. The river is crossed by a bridge of seven arches which was designed by Thomas Telford in 1805 and opened in 1808. The town lies in the midst of luxuriant trees, and the noble sweep of the Tay, the effectively situated bridge, the magnificent grounds of Dunkeld House, and the protecting mountains combine to give it a very romantic appearance. The town hall is the principal modern building, and the fountain erected in Market Square to the memory of the 6th duke of Atholl (d. 1864) occupies the site of the old cross.

As early as 720—some authorities fix the date a hundred and fifty years before—the Culdees possessed a monastery at Dunkeld, which was converted into a cathedral by David I. in 1127. This structure stood until the Reformation, when it

was unroofed and suffered to fall into ruin. The building consists of the nave (120 ft. long, 60 ft. wide, 40 ft. high), aisles (12 ft. wide), choir, chapter-house and tower. The nave is the most beautiful portion. The Pointed arches rest upon piers, possibly Norman, and above them, below the Decorated clerestory windows, is a series of semicircular arches with flambouyant tracery, a remarkable feature. The choir, founded by Bishop William Sinclair (d. 1337), has been repaired, and serves as the parish church, a blue marble slab in the floor marking the bishop's grave. The chapter-house, adjoining the choir, was built by Bishop Thomas Lauder (1395-1481) in 1460, and the vault beneath is the burial-place of the Atholl Murrays. Lauder began the tower, completed in 1501. In the porch of the church is the most interesting of the extant old tombs, namely, the recumbent effigy of Alexander Stewart, the Wolf of Badenoch (1343-1405; the inscription refers his death to 1394, but this is said to be an error). The most famous of the Bishops was Gavin Douglas (1474-1522), translator of the *Aeneid*. One of the most heroic exploits in the annals of warfare is associated with the cathedral. Shortly after the battle of Killiecrankie (1688), the Cameronian regiment, enrolled in the same year (afterwards the 26th Foot), was despatched to hold Dunkeld prior to another invasion of the Highlands. It was under the command of Colonel William Cleland (b. 1661), a poet of some merit. On the 26th of August a force of 5000 Highlanders suddenly appearing, Cleland posted his men in the church and behind the wall of the earl's mansion. Still flushed with their victory under Dunsinane and animated by bitterest hatred of their Whiggamore foes, the Highlanders assaulted the position of the Covenanters, who were 1200 strong, with the most desperate valour. Sustained by their enthusiasm, however, the recruits displayed equal courage, and at the end of four hours' stubborn fighting, their defence was still intact. Fearing lest victory, even if won, might be purchased too dearly, the Highlanders gradually withdrew. While leading a sortie Cleland was shot dead, and was buried in the churchyard.

Adjoining the cathedral is Dunkeld House, a seat of the duke of Atholl, the grounds of which are estimated to contain 50 a. of walks and 30 m. of drives. On the lawn near the cathedral stand two of the earliest larches grown in Great Britain, having been introduced from Tirol by the 2nd duke in 1738. The duke planted several square miles of the estate with this tree, of which he had made a special study.

A mile south of Dunkeld, on the left bank of the Tay, is the village of Birnam (pop. 380), where Sir John Everett Millais the painter, made his summer residence. It lies at the foot of Birnam Hill (1324 ft.), once covered with a royal forest, and has been partly replaced by plantations. The oak and sycamore in front of Birnam House, the famed twin trees of Birnam, are believed to be more than 1000 years old, and to be the remains of the wood of Birnam which Shakespeare immortalized in *Macbeth*. The Pass of Birnam, where the river narrows, was the path usually taken by the Highlanders in their forays. In the vicinity are the castles of Murtherly, one a modern mansion in the Elizabethan style, erected about 1838 from designs by James Gillespie Graham (1777-1855), and the other the old castle, which was occasionally used as a hunting-lodge by the Scottish kings.

At Little Dunkeld, almost opposite to Dunkeld, the Tay joins the Tay, after a run of 11 m. from its source in L. Freuchie. It is celebrated for its falls about 2 m. from the mouth. The upper fall is known as the Rumbling Bridge from the fact that the stream pours with a rumbling noise through a very narrow gorge in which a huge fallen rock has become wedged, forming a rude bridge or arch. Inver, near the mouth of the Tay, was the birthplace of the two famous fiddlers, Niel Gow (1727-1807) and his son Nathaniel (1766-1831).

DUNKIRK (Fr. *Dunkerque*), a seaport of northern France, capital of an arrondissement in the department of Nord, on the Straits of Dover, 53 m. N.W. of Lille on the Northern railway. Pop. (1906) 35,767. Dunkirk is situated in the low but fertile district of the Wateringues. It lies, amidst a network of canals

immediately to the west and south of its port, which disputes with Bordeaux the rank of third in importance in France. The populous suburbs of Rosendaël and St Pol-sur-Mer lie respectively to the east and west of the town; to the north-east is the bathing resort of Malo-les-Bains. The streets of Dunkirk are wide and well paved, the chief of them converging to the square named after Jean Bart (born at Dunkirk in 1651), whose statue by David d'Angers stands at its centre. Close to the Place Jean Bart rises the belfry (290 ft. high) which contains a fine peal of bells and also serves as a signalling tower. It was once the western tower of the church of St Eloi, from which it is now separated by a street. St Eloi, erected about 1560 in the Gothic style, was deprived of its first two bays in the 18th century; the present façade dates from 1889. The chapel of Notre-Dame des Dunes possesses a small image, which is the object of a well-known pilgrimage. The chief civil buildings are a large Chamber of Commerce, including the customs and port services, and a fine modern town hall. Dunkirk is the seat of a sub-prefect; its public institutions include tribunals of first instance and of commerce, a board of trade-arbitrators, in exchange, a branch of the Bank of France and a communal college; and it has a school of drawing, architecture and music, a library and a rich museum of paintings. Dunkirk forms with Bergues, Bourbourg and Gravelines a group of fortresses enclosed by inundations and canals. A chain of forts to the eastward is designed to facilitate the deployment of an army, concentrated within the fortified region, towards the Belgian frontier.

The harbour of Dunkirk (see DOCK) is approached by a fine natural roadstead entered on the east and west, and protected in the north by sand-banks. From the roadstead, entrance is by a channel into the outer harbour, which communicates with even floating basins about 115 acres in area and is accessible to the largest vessels. The port is provided with four dry docks and a gridiron, and its quays exceed 5 m. in length. Its commerce is much facilitated by the system of canals which bring it into communication with Belgium, the coal-basins of Nord and Pas-de-Calais, the rich agricultural regions of Flanders and Artois, and the industrial towns of Lille, Armentières, Roubaix, Tourcoing, Valenciennes, &c. The roadstead is indicated by lightships and the entrance channel to the port by a lighthouse which, at an altitude of 193 ft., is visible at a distance of 19 m.

Dunkirk annually despatches a fleet to the Icelandic cod-fisheries, and takes part in the herring and other fisheries. It exports great quantities of wool from the Argentine and Australia, and is in regular communication with New York, London and the chief ports of the United Kingdom, Brazil and the far East. Besides wool, leading imports are jute, cotton, flax, timber, petroleum, coal, pitch, wine, cereals, oil-seeds and oil-cake, nitrate of soda and other chemical products, and metals. The principal exports are sugar, coal, cereals, wool, forage, cement, chalk, phosphates, iron and steel, tools and metal-goods, thread and vegetables. The average annual value of the imports for the years 1901-1905 was £23,926,000 (£22,287,000 for 1896-1900), of exports £6,360,000 (£4,481,000 for 1896-1900). The industries include the spinning of jute, flax, hemp and cotton, iron-founding, rewing, and the manufacture of machinery, fishing-nets, sail-cloth, sacks, casks, and soap. There are also saw- and flour-mills, petroleum refineries and oil-works. Ship-building is carried on, and the preparation of fish and cod-liver oil occupies many hands.

Dunkirk is said to have originated in a chapel founded by St Eloi in the 7th century, round which a small village speedily sprang up. In the 10th century it was fortified by Baldwin III., count of Flanders; together with that province it passed successively to Burgundy, Austria and Spain. In the 15th, 16th and 17th centuries its possession was disputed by French and Spaniards. In 1658 Turenne's victory of the Dunes (q.v.) gave it into the hands of the French and it was ceded to England. After the Restoration, Charles II., being in money difficulties, sold it to the French king Louis XIV., who fortified it. By the arms of the peace of Utrecht (1713) the fortifications were demolished and its harbour filled up, a sacrifice demanded by England owing to the damage inflicted on her shipping by Jean

Bart and other corsairs of the port. In 1793 it was besieged by the English under Frederick Augustus, duke of York, who was compelled to retire after the defeat of Hondschoote.

See A. de St Leger, *La Flandre maritime et Dunkerque* (Paris, 1900).

DUNKIRK, a city and a port of entry of Chautauqua county, New York, U.S.A., on the S. shore of Lake Erie, 40 m. S.W. of Buffalo. Pop. (1890) 9416; (1900) 11,616, of whom 3338 were foreign-born; (1910 census) 17,221. The city is served by the Pennsylvania, the Erie, the Lake Shore & Michigan Southern, the New York, Chicago & St Louis, and the Dunkirk, Allegheny Valley & Pittsburg railways, by the electric line of the Buffalo & Lake Erie Tractor Co., and by several lines of freight and passenger steamships. Dunkirk is attractively situated high above the lake, and has several parks, including Point Gratiot and Washington; in the city are the Dunkirk free library, the Brooks Memorial hospital (1891), and St Mary's academy. The city lies in an agricultural and grape-growing region, and has a fine harbour and an extensive lake trade; the manufactures include locomotives, radiators, lumber, springs, shirts, axes, wagons, steel, silk gloves and concrete blocks. The value of factory products increased from \$5,225,996 in 1900 to \$9,909,260 in 1905, or 89.6%. Large numbers of food-fish are caught in the lake. The municipality owns and operates the water works and the electric lighting plant. Dunkirk was first settled about 1805. It was incorporated as a village in 1837, and was chartered as a city in 1880.

DUNLOP, JOHN COLIN (1785-1842), Scottish man of letters, was born on the 30th of December 1785. In 1816 he became sheriff of Renfrewshire, and retained this office until his death at Edinburgh, on the 26th of January (according to others, in February) 1842. The work by which he is best known, and which will always hold an honourable place in English literature, is his *History of Fiction* (1814; new edition, 1888, with notes by H. Wilson, in Bohn's "Standard Library"). In spite of the somewhat contemptuous notices in *Blackwood's Magazine* (September 1824) and the *Quarterly Review* (July 1815), it may be pronounced the best book on the subject in English. F. Liebrecht, by whom it was translated into German (1851) with valuable notes, describes it as the only work of its kind. Dunlop was also the author of *A History of Roman Literature* (1823-1828), and of *Memoirs of Spain during the Reigns of Philip IV. and Charles II.* (1834).

DUNMORE, a borough of Lackawanna county, Pennsylvania, U.S.A., adjoining Scranton on the N.E. and about 20 m. N.E. of Wilkesbarre. Pop. (1890) 8315; (1900) 12,583, of whom 3103 were foreign-born; (1910 census) 17,615. It is served by the Erie, the Delaware, Lackawanna & Western, and the Lackawanna & Wyoming Valley (electric) railways. Its chief industry is the mining of anthracite coal; the principal establishments are railway repair shops, which in 1905 gave employment to 48.9% of all wage-earners engaged in manufacturing. Among the borough's manufactures are stoves and furnaces, malt liquors and silk. Dunmore is the seat of the state oral school for the deaf. The town was first settled in 1783 and was incorporated in 1862. Its growth was accelerated by the establishment here, in 1863, of the shops of the railway from Pittston to Hawley built in 1849-1850 by the Pennsylvania Coal Company. Dunmore became a station of the Scranton post office in 1902.

DUNMOW (properly GREAT DUNMOW), a market town in the Epping (W.) parliamentary division of Essex, England, on the river Chelmer, 40 m. N.E. by N. from London on a branch of the Great Eastern railway. Pop. (1901) 2704. The church of St Mary is Decorated and Perpendicular. The town was corporate from the 16th century until 1886. Roman remains have been discovered. Two miles E. is the village of LITTLE DUNMOW, formerly the seat of a priory, remarkable for the custom of presenting a sitch of bacon to any couple who could give proof that they had spent the first year of married life in perfect harmony, and had never at any moment wished they had married. In place of the monastic judicature a jury of six bachelors and six maidens appear in the 16th century. A

rhyming oath, quoted by Fuller, was taken. The institution of this strange matrimonial prize—which had its parallel at Whichanore (or Wichnor) in Staffordshire, at St Moleine in Brittany, and apparently also at Vienna—appears to date from the reign of John. The first instance of its award recorded is in 1445, and there are a few others. But there are references which suggest its previous award in *Piers Plowman* and Chaucer. The Chaucerian couplet conveys the idea of an award to a patient husband, without reference to the wife. A revival of the custom was effected in 1855 by Harrison Ainsworth, author of the novel *The Fitch of Bacon*, but the scene of the ceremony was transferred to the town hall of Great Dunmow. It has since been maintained in altered form. (For details see Chambers's *Book of Days*, ii. 748-751; and W. Andrews, *History of the Dunmow Fitch of Bacon Customs*, 1877.) Close to Little Dunmow is Felsted (q.v.) or Felstead; and Easton Lodge (with a railway station), the seat of the earl of Warwick, is in the vicinity.

DUNNE, FINLEY PETER (1867-), American journalist and humorist, was born, of Irish descent, in Chicago, Illinois, on the 10th of July 1867. After a public school education he became a newspaper reporter (1885); he was city editor of the *Chicago Times* (1891-1892), a member of the editorial staff of the *Chicago Evening Post* and of the *Chicago Times-Herald* (1892-1897), and editor of the *Chicago Journal* (1897-1900). In 1900 he removed to New York city. Although for several years he had been contributing humorous sketches in Irish brogue to the daily papers, he did not come into prominence until he wrote for the *Chicago Journal* a series of satirical observations and reflections attributed to an honest Irish-American, Martin Dooley, the shrewd philosopher of Archey Road, on social and political topics of the day. These were widely copied by the press of America and England. The first published collection, *Mr Dooley in Peace and in War* (1898), was followed by several others, similar in subject-matter and method, including *Mr Dooley in the Hearts of his Countrymen* (1899), *Mr Dooley's Philosophy* (1900), *Mr Dooley's Opinions* (1901), *Observations by Mr Dooley* (1902), and *Dissertations by Mr Dooley* (1906). These books made their author widely known as the creator of a delightfully original character, and as a humorist of shrewd insight. In 1906 he became associate editor of the *American Magazine*.

DUNNOTAR CASTLE, a ruined stronghold, on the east coast of Kincardineshire, Scotland, about 2 m. S. of Stonehaven. It stands on a rock 160 ft. high, with a summit area of 4 acres, and surrounded on three sides by the sea. It is accessible from the land by a winding path leading across a deep chasm, to the outer gate in a wall of enormous thickness. It is supposed that a fortress stood here since perhaps the 7th century, but the existing castle dates from 1392, when it was begun by Sir William Keith (d. 1407), great marshal of Scotland. The keep and chapel are believed to be the oldest structures, most of the other buildings being two centuries later. It was the residence of the earls marischal and was regarded as impregnable. Here the seventh earl entertained Charles II. before the battle of Worcester. When Cromwell became Protector, the Scottish regalia were lodged in the castle for greater security, and, in 1651, when the Commonwealth soldiers laid successful siege to it, they were saved by a woman's wit. Mrs Granger, wife of the minister of Kinneff, a parish about 6 m. to the S., was allowed to visit the wife of the governor, Ogilvy of Barras, and when she rode out she was spinning lint on a distaff. The crown was concealed in her lap, and the distaff consisted of the sword and sceptre. The regalia were hidden beneath the flagstones in the parish church, whence they were recovered at the Restoration. In 1685 the castle was converted into a Covenanters' prison, no fewer than 167 being confined in a dungeon, called therefrom the Whigs' Vault. On the attainder of George, tenth and last marischal, for his share in the earl of Mar's rising in 1715 the castle was dismantled (1720).

DUNOIS, JEAN, COUNT OF (1403-1468), commonly called the "Bastard of Orleans," a celebrated French commander, was the natural son of the duke of Orleans (brother of Charles VI.) and Mariette d'Enguien, Madame de Canny. He was brought

up in the house of the duke, and in the company of his legitimate sons, and it appears that he was present at the battle of Beaugé in 1421 and Vermeuil in 1424. His earliest feat of arms was the surprise and rout in 1427 of the English, who were besieging Montargis—the first successful blow against the English power in France following a long series of French defeats. In 1428 he defended Orleans with the greatest spirit, and enabled the place to hold out until the arrival of Joan of Arc, when he shared with her the honour of defeating the enemy there in 1429. He then accompanied Joan to Reims and shared in the victory of Patay. After her death he raised the siege of Chartres and of Lagny (1432) and engaged in a series of successful campaigns which ended in his triumphal entry into Paris on the 13th of April 1436. He continued to carry on the war against the English, and gradually drove them to the northward, though his work was to some extent interrupted by the civil disorders of the time, in which he played a conspicuous part. Finally in 1450 he completed the reconquest of northern France, and in 1451 he attacked them in Guenne, taking among other towns Bordeaux, which the English had held for three hundred years, and Bayonne. After the expulsion of the English he was constantly engaged in the highest diplomatic and military missions. In 1465 he joined the league of revolted princes, but, assuming the function of negotiator, he was after a time reinstated in his offices. Dunois was thenceforward in the greatest favour with the court. He died on the 24th of November 1468.

DUNOON, a police and municipal burgh of Argyllshire, Scotland, on the western shore of the Firth of Clyde, opposite to Gourock. Pop. (1901) 6779. Including Kilm and Hunter's Quay, it presents a practically continuous front of seaside villas. The mildness of its climate and the beauty of its situation have made it one of the most prosperous watering-places on the west coast. The principal buildings are the parish church, well-placed on a hill overlooking the pier, convalescent homes, Cottage and Victoria fever hospitals, and the town house. On a conical hill above the pier stand the remains of Dunoon Castle, the hereditary keepership of which was conferred by Robert Bruce on the family of Sir Colin Campbell of Loch Awe, an ancestor of the duke of Argyll. It was visited by Queen Mary in 1561, and in 1643 was the scene of the massacre of the Lamonts by the Campbells. The grounds have been laid out as a recreation garden. Near the hill stands the modern castle. Facing the pier a statue was erected in 1898 of Mary Campbell, Burns's "Highland Mary," who was a native of Dunoon. The town itself is of modern growth, having been a mere fishing village at the beginning of the 19th century. There is frequent communication daily by steamer with the railway piers at Craignedoran and Gourock, and Glasgow merchants are thus enabled to reside here all the year round. Hunter's Quay is the yachting headquarters, the Royal Clyde Yacht Club's house adjoining the pier. Kilmun, on the northern shore of Holy Loch, a portion of the parish of Dunoon and Kilmun, contains the ruins of a Collegiate chapel founded in 1442 by Sir Duncan Campbell of Loch Awe and used as the burial-ground of the Argyll family.

DUNROBIN CASTLE, a seat of the duke of Sutherland, picturesquely situated on the north-eastern shore of Dornoch Firth, Sutherlandshire, Scotland, about 2 m. N.E. of Golspie, with a private station on the Highland railway. The name is said to have originally meant the fort of Raffu, the "law-man," or crown agent for the district in 1222, but it was renamed out of compliment to Robert (or Robin), 6th earl of Sutherland, who died in 1389. The ancient portion, dating from the end of the 13th century, was a square structure with towers at the corners, but in 1856 there was added a wing, a main north-eastern tower, and front, with numerous bartizan turrets, and dormer windows in the roof. The stately entrance porch recalls that of Windsor Castle, and the interior is designed and decorated on a sumptuous scale. In April 1746 George Mackenzie, the 3rd earl of Cromarty, thinking that Prince Charles Edward had prevailed at Culloden, seized the castle in his interests, but the Sutherland militia surrounded the building and captured the earl in an apartment which was afterwards called the Cromarty room. The beautiful

gardens contain a wealth of trees, which grow with remarkable luxuriance for the latitude of 58° N. The 3rd duke of Sutherland erected a museum in the grounds in which are many specimens of the antiquities of the shire, such as querns, stone tools and weapons, silver brooches and the like, found in brochs and elsewhere. There is a graceful waterfall in Dunrobin glen, through which flows Golspie Burn, near the left bank of which are remains of Pictish towers. About 1 m. N.W. of Golspie rises Ben Bhragie (1256 ft.), crowned by a colossal statue of the 1st duke of Sutherland, by Chantry.

DUNS, a police burgh and county town of Berwickshire, Scotland. Pop. (1901) 2206. It is situated 44 m. E.S.E. of Edinburgh by road, with a station on the branch line of the North British railway from Reston to St Boswells. The principal buildings are the town-hall, county buildings, corn exchange, mechanics' institute and the public library. There is a woollen mill, and stock sales are held at frequent intervals. The alternative spelling of Dunse seems to have been in vogue from 1740 till 1882. It was on Duns Law (700 ft.) that the Covenanters, under Alexander Leslie, were encamped in 1639, and the Covenanters' Stone on the top of the hill has been enclosed to preserve it from relic-hunters. Duns castle, adjoining the town on the W., includes the Tower erected by Thomas Randolph, earl of Moray (d. 1332), and about 3 m. S.W. is the village of Polwarth.

DUNSNANE, a peak of the Sidlaw Hills, in the parish of Collace, Perthshire, Scotland, 8 m. N.E. of Perth. It is 1012 ft. high, and commands a fine view of the Carse of Gowrie and the valley of the Tay. Its chief claim to mention, however, is due to its association with Birnam Wood (about 12 m. N.W.) in two well-known passages in Shakespeare's *Macbeth*. An old fort on the summit, of which faint traces are still discernible, is traditionally called Macbeth's Castle.

DUNS SCOTUS, JOHN (1265 or 1275-1308), one of the foremost of the schoolmen. His birthplace has been variously given as Duns in Berwickshire, Dunum (Down) in Ulster, and Dunstane in Northumberland, but there is not sufficient evidence to settle the question. He joined the Franciscan order in early life, and studied at Merton College, Oxford, of which he is said to have been a fellow. He became remarkably proficient in all branches of learning, but especially in mathematics. When his master, William Varron, removed to Paris in 1301, Duns Scotus was appointed to succeed him as professor of philosophy, and his lectures attracted an immense number of students. Probably in 1304 he went to Paris, in 1307 he received his doctor's degree from the university, and in the same year was appointed regent of the theological school. His connexion with the university was made memorable by his defence of the doctrine of the Immaculate Conception, in which he displayed such dialectical ingenuity as to win for himself the title *Doctor Subtilis*. The doctrine long continued to be one of the main subjects in dispute between the Scottists and the Thomists, or, what is almost the same thing, between the Franciscans and the Dominicans. The university of Paris was so impressed by his arguments, that in 1387 it formally condemned the Thomist doctrine, and a century afterwards required all who received the doctor's degree to bind themselves by an oath to defend the doctrine of the Immaculate Conception. In 1308 Duns Scotus was sent by the general of his order to Cologne, with the twofold object of engaging in a controversy with the Beghards and of assisting in the foundation of a university; according to some, his removal was due to jealousy. He was received with enthusiasm by the inhabitants but died suddenly (it was said, of apoplexy) on the 8th of November in the same year. There was also a tradition that he had been buried alive.

His philosophical position was determined, or at least very greatly influenced, by the antagonism between the Dominicans and the Franciscans. Further, while the genius of Aquinas was constructive, that of Duns Scotus was destructive; Aquinas was a philosopher, Duns a critic. The latter has been said to stand to the former in the relation of Kant to Leibnitz. In the matter of Universals, Duns was more of a realist and less of an eclectic than

Aquinas. Theologically, the Thomistic system approximates to pantheism, while that of Scotus inclines distinctly to Pelagianism. The doctrine of the Immaculate Conception was the great subject in dispute between the two parties; it was strenuously opposed by Aquinas, and supported by Duns Scotus, although not without reserve. There were, however, differences of a wider and deeper kind. In opposition to Aquinas, who maintained that reason and revelation were two independent sources of knowledge, Duns Scotus held that there was no true knowledge of anything knowable apart from theology as based upon revelation. In conformity with this principle he denied that the existence of God was capable of being proved, or that the nature of God was capable of being comprehended. He therefore rejected as worthless the ontological proof offered by Aquinas. Another chief point of difference with Aquinas was in regard to the freedom of the will, which Duns Scotus maintained absolutely. He reconciled free-will and necessity by representing the divine decree not as temporarily antecedent, but as immediately related to the action of the created will. He maintained, in opposition to Aquinas, that the will was independent of the understanding, that only will could affect will. From this difference as to the nature of free-will followed by necessary consequence a difference with the Thomists as to the operation of divine grace. In ethics the distinction he drew between natural and theological virtues is common to him with the rest of the schoolmen. (Cf. AQUINAS.) Duns Scotus strongly upheld the authority of the church, making it the ultimate authority on which that of Scripture depends. (See also SCOLASTICISM.)

The most important of his works consisted of questions and commentaries on the writings of Aristotle, and on the *Sentences* of Lombard, the so-called *Opus Oxoniense* or *Anglicanum*. Complete works, edited by Luke Wadding (13 vols., Lyons, 1639) and at Paris (26 vols., 1891-1895). There is an edition of his *De modis significandi* or *Grammatica speculativa*, the first attempt to investigate the general laws of language, by F. M. Fernández García (Quaracchi, Florence, 1902).

On Duns Scotus generally, see life by Wadding in vol. i. of the works (full, however, of legendary absurdities); J. Müller, *Biographisches über Duns Scotus* (progr., Cologne, 1881); W. J. Townsend, *The Great Schoolmen* (1881); K. Werner, *Die Scholastik des späteren Mittelalters*, i. (1881); J. M. Rigg, in *Dictionary of National Biography*. On his theology: C. Frassen, *Scotus Academicus* (1744, new edition, 1900); Hieronymus de Montefortino (Jerome de Fortius), *Scoti summa theologica* (1728-1738, new edition, 1900); L. P. O. Baumgarten-Crusius, *De theologia Scoti* (1826); R. Seeberg, *Die Theologie des J. Duns Scotus* (1900), and in Herzog-Hauck, *Realencyclopädie für protestantische Theologie* (1898), with bibliographies; F. Morin, *Dictionnaire de philosophie et de théologie scolastiques* [= J. P. Migne, *Troisième encyclopédie théologique*, xxi., xxxii., 1857]; C. R. Hagenbach, *History of Doctrines* (Eng. tr., ii., 1880). On his philosophy: E. Pluzanski, *Essai sur la philosophie de Duns Scot* (1887); A. Schmid, *Die Thomistische und Scotistische Gewissheitslehre* (1859); M. Schneid, *Die Körperlehre des J. Duns Scotus—its relation to Thomism and Atomism* (1879); P. Mingès, "Est Duns Scotus Indeterminist?" in *Beiträge zur Geschichte der Philosophie des Mittelalters*, Bd. v. Heft 4 (1905); W. Kahl, *Die Lehre vom Primat des Willens bei Augustinus, Duns Scotus, und Descartes* (1886).

DUNSTABLE, a municipal borough and market town in the southern parliamentary division of Bedfordshire, England, 37 m. N.W. of London, on branches of the Great Northern and London & North-Western railways. Pop. (1901) 5157. It lies at an elevation of about 500 ft. on the bleak northward slope of the Chiltern Hills. The church of St Peter and St Paul is a fine fragment of the church of the Augustinian priory founded by Henry I. in 1131. The building was cruciform, but only the west front and part of the nave remain. The front has a large late Norman portal of four orders, with rich Early English arcading above; the nave arcade is ornate Norman. The original triforium is transformed into a clerestory, the original clerestory being lost. The north-west tower has a Perpendicular upper portion, but the south-west tower is destroyed. The church contains various monuments of the 18th century. Foundations of a palace of Henry I. are traceable near the church. The main part of the town extends for a mile along the broad straight Roman road, Watling Street; the high road from Luton to Tring, which crosses it in the centre of the town, representing the ancient Icknield Way. The chief industry is straw hat

manufacture; there are also printing, stationery and engineering works. The borough is under a mayor, 4 aldermen, and 12 councillors. Area, 453 acres.

There may have been a Romano-British village on this site on the Watling Street. Dunstable (*Dunastaple*, *Domestaple*) first appears as a royal borough in the reign of Henry I., who, according to tradition, on account of the deprivations of robbers, cleared the forest where Watling Street and the Icknield Way met, and encouraged his subjects to settle there by various grants of privileges. He endowed the priory by charter with the lordship of the manor and borough, which it retained till its dissolution in 1536-1537. The Dunstable Annals deal exhaustively with the history of the monastery and town in the 13th century. In 1219 the prior secured the right of holding a court there for all crown pleas and of sitting beside the justices itinerant, and this led to serious collision between the monks and burgesses. The body of Queen Eleanor rested here for a night on its journey to Westminster, and a cross, of which there is now no trace, was subsequently erected in the market-place. At Dunstable Cranmer held the court which, in 1533, declared Catherine of Aragon's marriage invalid. At the dissolution a plan was set on foot for the creation of a new bishopric from the spoils of the religious houses, which was to include Bedfordshire and Buckinghamshire with Dunstable as cathedral city. The scheme was never realized, though plans for the cathedral were actually drawn up.

From the earliest time Dunstable has been an agricultural town. The Annals abound with references to the prices and comparative abundance or scarcity of the two staple products, wool and corn. The straw hat manufacture has flourished since the 18th century. Henry I. granted a market held twice a week, and a three days' fair on the feast of St Peter ad Vincula. John made a further grant of a three days' fair from the 10th of May. A market is still held weekly, also fairs in May and August correspond to these grants. Dunstable had also a gild merchant and was affiliated to London. In 1864 the town was made a municipal borough by royal charter.

DUNSTAFFNAGE, a ruined castle of Argyllshire, Scotland, 3 m. N.N.E. of Oban. It is situated on a platform of conglomerate rock forming a promontory at the south-west of the entrance to Loch Etive and is surrounded on three sides by the sea. It dates from the 13th century, occupying the site of the earlier stronghold in which was kept the Stone of Destiny prior to its removal to Scoon (q.v.) in 843. The castle is a quadrangular structure of great strength, with rounded towers at three of the angles, and has a circumference of about 400 ft. The walls are 60 ft. high and 10 ft. thick, affording a safe promenade, which commands a splendid view. Brass cannon recovered from wrecked vessels of the Spanish Armada are mounted on the walls. In 1308 Robert Bruce captured the fortress from the original owners, the MacDougalls, and gave it to the Campbells. It was garrisoned at the period of the Jacobite rebellions of 1715 and 1745, fell into decay early in the 19th century, and is now the property of the crown, the duke of Argyll being hereditary keeper. The adjoining chapel, in a very ruinous state, was the burial-place of the Campbells of Dunstaffnage.

There are other interesting places on Loch Etive, an arm of the sea, measuring 19½ m. in length and from ¼ m. to fully 1 m. in width. Near the mouth, where the lake narrows to a strait, are the rapids which Ossian called the Falls of Lora, the ebbing and flowing tides, as they rush over the rocky bar, creating a roaring noise audible at a considerable distance. In the parish of Ardhattan, on the north shore, stands the beautiful ruin of St Modan's Priory, founded in the 13th century for Cistercian monks of the order of Vallis Caulium. It is said that Robert Bruce held within its walls the last parliament in which the Gaelic language was used. On the coast of Loch Nell, or Ardmucknish Bay, is the vitrified fort of Beregonium, not to be confounded with Rerigonium (sometimes miscalled Berigonium) on Loch Ryan in Wigtonshire—a town of the Novantae Picts, identified with Innermessan. The confusion has arisen through a textual error in an early edition of Ptolemy's *Geography*.

DUNSTAN, SAINT (924 or 925-988),¹ English archbishop, entered the household of King Æthelstan when still quite a boy. Here he soon excited the dislike of his young companions, who procured his banishment from the court. He now took refuge with his kinsman Alphege, bishop of Winchester, whose persuasion, seconded by a serious illness, induced him to become a monk. Æthelstan's successor, Edmund, recalled him to the court and made him one of his counsellors. Through the machinations of enemies he was again expelled from the royal presence; but shortly afterwards Edmund revoked the sentence and made him abbot of Glastonbury. His successor Edred showed him greater favour still. On the accession of Edwig, however, in 955, Dunstan's fortunes underwent a temporary eclipse. Having offended the influential Ælfgifu, he was outlawed and compelled to flee to Flanders. But in 957 the Mercians and Northumbrians revolted and chose Edgar as their king. The new king at once recalled Dunstan, who was made a bishop. At first apparently he was without a see; but that of Worcester falling vacant, he was appointed to fill it. In 959 he received the bishopric of London as well. In the same year Edwig died and Edgar became sole king, Dunstan shared his triumph, and was appointed archbishop of Canterbury. On Edgar's death in 975 the archbishop's influence secured the crown for his elder son Edward. But with the accession of Æthelred in 979 Dunstan's public career came to an end. He retired to Canterbury, and died on the 19th of May 988.

Dunstan is of more importance as a lay than as an ecclesiastical statesman. The great church movement of his time—the reformation of English monasticism on Benedictine lines—found in him a sympathizer, but in no sense an active participant. But as a secular statesman he occupies a high place. He guided the state successfully during the nine years' reign of the invalid Edred. Through that of Edgar, he was the king's chief minister and most trusted adviser; and to him a great share in its glories must be assigned.

See *Memorials of St Dunstan*, edited by W. Stubbs (London, 1874); *Anglo-Saxon Chronicle*, edited by C. Plummer (Oxford, 1892-1899).

DUNSTER, a market town in the Western parliamentary division of Somersetshire, England, 1½ m. from the shore of the Bristol Channel, on the Minehead branch of the Great Western railway. Pop. (1901) 1182. Its streets, sloping sharply, contain many old houses. On an eminence stands the ancient castle, entered by a gateway of the 13th century. There are portions of later date, but still ancient, in the main building, but it has been considerably modernized as a residence. The church of St George has Norman portions, but the building is in the main Perpendicular. The fine tower in this style is characteristic of this part of England. There are traces of monastic buildings near the church, for it belonged to a Benedictine house of early Norman foundation. The church is cruciform and the altar stands beneath the eastern lantern arch, a fine rood screen separating off the choir, which was devoted to monastic use, while the nave was kept for the parishioners, in consequence of a dispute between the vicar and the monastery in 1490. The Yarn Market, a picturesque octagonal building with deep sloping roof, in the main street, dates from c. 1600, and is a memorial of Dunster's former important manufacture of cloth.

There were British, Roman and Saxon settlements at Dunster (*Torre Duneslorre*, *Dunester*), fortified against the piracies of the Irish Northmen. The Saxon fort of Alaric was replaced by a Norman castle built by William de Mohun, first lord of Dunster, who founded the priory of St George. Before 1183, Dunster had become a meane borough, owned by the de Mohuns until the 14th century when it passed to the Luttrells, the present owners. Reginald de Mohun granted the first charter between 1245 and 1247, which diminished fines and tolls, limited the lord's "mercy," and provided that the burgesses should not against their will

¹ The date of Dunstan's birth here given is that given in the Anglo-Saxon chronicle and hitherto accepted. In an appendix to the *Bosworth Psalter*, edited by Mr Edmund Bishop and Albert Gasquet (1908), Mr Leslie A. St L. Tolk gives reason to believe that the date must be set back at least as early as 910.

be made bailiffs or farmers of the seaport. John de Mohun granted other charters in 1301 and 1307. Dunster was only represented in parliament in conjunction with Minehead, one of its tithings being part of that borough. Representation began in 1562, and was lost in 1832. Feudal in origin, Dunster's later importance was commercial, and the port had a considerable wool, corn and cattle trade with Ireland. During the middle ages the Friday market and fair in Whit week, granted by the first charter, were centres for the sale of yarn and cloth called "Dunsters," made in the town. The market day is still Friday. The manufacture of cloth had disappeared, the harbour is silted up, and there is no special local industry.

See Sir H. C. Maxwell Lyte, *Dunster and its Lords* (1882); *Victoria County History, Somerset*, vol. ii.

DUNTOCHER (Gaelic, "The Fort of ill hap"), a town on Dalmuir Burn, Dumbartonshire, Scotland, 9 m. from Glasgow. Pop. (1901) 2122. The district contains coal, limestone and ironstone, but there is not much mining. Many of the inhabitants are employed at the Singer factory in Kilbowie and at the Clyde Trust yards in Dalmuir. There are considerable Roman remains in the neighbourhood. Antoninus' Wall passed immediately to the south; the burn is crossed by a bridge alleged to be of Roman origin (which at least is doubtful); subterranean remains indicate a Roman structure; a Roman camp has been traced, and the vicinity has yielded a number of altars, urns, vases, coins and tablets, which are now in the custody of Glasgow University.

DUNTON, JOHN (1659-1733), English bookseller and author, was born at Graffham, in Huntingdonshire, on the 4th of May 1659. His father, grandfather and great-grandfather had all been clergymen. At the age of fifteen he was apprenticed to Thomas Parkhurst, bookseller, at the sign of the Bible and Three Crowns, Cheapside, London. Dunton ran away at once, but was soon brought back, and began to "love books." During the struggle which led to the Révolution, Dunton was the treasurer of the Whig apprentices. He became a bookseller at the sign of the Raven, near the Royal Exchange, and married Elizabeth Annesley, whose sister married Samuel Wesley. His wife managed his business, so that he was left free in a great measure to follow his own eccentric devices. In 1686, probably because he was concerned in the Monmouth rising, he visited New England, where he stayed eight months selling books and observing with interest the new country and its inhabitants. Dunton had become security for his brother's debts, and to escape the creditors he made a short excursion to Holland. On his return to England, he opened a new shop in the Poultry in the hope of better times. Here he published weekly the *Athenian Mercury* which professed to answer all questions on history, philosophy, love, marriage and things in general. His wife died in 1697, and he married a second time; but a quarrel about property led to a separation; and being incapable of managing his own affairs, he spent the last years of his life in great poverty. He died in 1733. He wrote a great many books and a number of political squibs on the Whig side, but only his *Life and Errors of John Dunton* (1705), on account of its naïveté, its pictures of bygone times, and of the literary history of the period, is remembered. His letters from New England were published in America in 1867.

DÜNTZER, JOHANN HEINRICH JOSEPH (1813-1901), German philologist and historian of literature, was born at Cologne on the 12th of July 1813. After studying philology and especially ancient classics and Sanskrit at Bonn and Berlin (1830-1835), he took the degree of doctor of philosophy and established himself in 1837 at Bonn as *Privat docent* for classical literature. He had already, in his *Goethes Faust in seiner Einheit und Ganzheit* (1836) and *Goethe als Dramatiker* (1837), advocated a new critical method in interpreting the German classics, which he wished to see treated like the ancient classics. He subsequently turned his attention almost exclusively to the poets of the German classical period, notably Goethe and Schiller. Düntzer's method met with much opposition and he consequently failed to obtain the professorship he coveted. In 1846 he accepted the post of librarian at the Roman Catholic

gymnasium in Cologne, where he died on the 16th of December 1901. Düntzer was a painstaking and accurate critic, but lacking in inspiration and finer literary taste; consequently his work as a biographer and commentator has, to a great extent, been superseded and discredited.

Among his philological writings may be mentioned *Die Lehre von der lateinischen Wortbildung* (1836); *Die Deklination der indogermanischen Sprachen* (1839); *Homer und der epische Kyklos* (1839); *Die homerischen Bewörter des Götter- und Menschengeschlechts* (1859). Of his works on the German classical poets, especially Goethe, Schiller and Herder, the following are particularly worthy of note, *Erläuterungen zu den deutschen Klassikern* (1853-1892); *Goethes Prometheus und Pandora* (1850); *Goethes Faust* (2 vols., 1850-1851; 2nd ed. 1857); *Goethes Götz und Egmont* (1854); *Aus Goethes Freundeskreise* (1868); *Abhandlungen zu Goethes Leben und Werken* (2 vols., 1885); *Goethes Tagebücher der sechs ersten weimarschen Jahre* (1889); *Goethes Leben* (1880; 2nd ed. 1883; Engl. transl. by T. Lyster, London, 1884); *Schillers Leben* (1881); *Schiller und Goethe; Übersicht und Erläuterung zum Briefwechsel zwischen Schiller und Goethe* (1859); *Herders Reise nach Italien* (1859); *Aus Herders Nachlass* (3 vols., 1856-1857), and further, *Charlotte von Stein* (1874).

DUNWICH, a village in the Eye parliamentary division of Suffolk, England, on the coast between Southwold and Aldeburgh, 5 m. S.S.W. of Southwold. Pop. (1901) 157. This was in Anglo-Saxon days the most important commercial centre and port of East Anglia. It was probably a Romano-British site. The period of its highest dignity was the Saxon era, when it was called *Dommoceaster* and *Dunwyk*. Early in the 7th century, when Sigebert became king of East Anglia, Dunwich was chosen his capital and became the nursery of Christianity in Eastern Britain. A bishopric was founded (according to Bede in 630, while the Anglo-Saxon chronicle gives 635), the name of the first bishop being Felix. Sigebert's reign was notable for his foundation of a school modelled on those he had seen in France; it was probably at Dunwich, but formed the nucleus of what afterwards became the university of Cambridge. By the middle of the 11th century (*scmp.* Edward the Confessor) Dunwich was declining, as it had already suffered from an evil which later caused its total ruin, namely the inroads of the sea on the unstable coast. At the Norman Conquest the manor was granted to Robert Malet; but the history of the place remains blank until the reign of Henry II., when it re-emerged into prosperity. In 1173 the sight of its strength caused Robert earl of Leicester to despair of besieging it. The town received a charter from King John. In the reign of Edward I. it is recorded to have possessed 36 ships and "barks," trading to the North Seas, Iceland and elsewhere, with 24 fishing boats, besides maintaining 11 ships of war. But early in the reign of Edward III. the attacks of the sea began to make headway again. In 1347 over 400 houses were destroyed. In 1570, after a terrible storm, appeal was made to Elizabeth, who parsimoniously granted money obtained by the sale of lead and other materials from certain neighbouring churches. But the doomed town was gradually engulfed, and now the only outward evidence of the old wealthy port is the ruined fragment of the church of All Saints, overhanging a low cliff, which, as it crumbles, exposes the coffins and bones in the former churchyard, the greater part of which has disappeared. A small white flower growing wild among the ruins is called the Dunwich Rose, and is traditionally said to have been planted and cultivated by monks. Many relics have been discovered by excavation, and even from beneath the waves. Until 1832 Dunwich returned a members to parliament.

DUOVIRI, less correctly **DUUMVIRI** (from Lat. *duo* two, and *vir*, man), in ancient Rome, the official style of two joint magistrates. Such pairs of magistrates were appointed at various periods of Roman history both in Rome itself and in the colonies and municipia. (1) *Duumviri iuri dicundo*, municipal magistrates, whose chief duties were concerned with the administration of justice. Sometimes there were four of these magistrates (*Quatuorviri*). (2) *Duumviri quinquennales*, also municipal officers, not to be confused with the above, who were elected every fifth year for one year to exercise the function of the censorship which was in abeyance for the intervening four years. (3) *Duumviri sacrorum*, officers who originally had

charge of the Sibylline books; they were afterwards increased to ten (*decemviri sacris faciundis*), and in Sulla's time to fifteen (*quindecimviri*). (4) *Duumviri aedi locandae*, originally officers specially appointed to supervise the erection of a temple. There were also *duumviri aedi dedicandae*. (5) *Duumviri navales*, extraordinary officers appointed *ad hoc* for the equipping of a fleet. Originally chosen by consuls or dictators, they were elected by the people after 311 B.C. (Livy ix. 30; xl. 18; xli. 1). (6) *Duumviri perduellionis*, the earliest criminal court for trying offences against the state (see TREASON: *Roman Law*). (7) *Duumviri visis extra urbem purgandis*, subordinate officers under the aediles, whose duty it was to look after those streets of Rome which were outside the city walls. Apparently in 20 B.C., certainly by 12 B.C., their duties were transferred to the *Curatores vicinarum*. From at least as early as 45 B.C. (cf. the *Lex Italia Municipalis*) the streets of the city were superintended by *Quattuorviri visis in urbe purgandis*, [later called *Quattuorviri vicinarum purgandarum*.

See Fiebigler and Liebenan in Pauly-Wissowa, *Realencyc.* v. pt. 2.

DUPANLOUP, FÉLIX ANTOINE PHILIBERT (1802-1878), French ecclesiastic, was born at St Félix in Savoy on the 3rd of January 1802. In his earliest years he was confided to the care of his brother, a priest in the diocese of Chambéry. In 1810 he was sent to a *pensionnat ecclésiastique* at Paris. Thence he went to the seminary of St Nicolas de Chardonnel in 1813, and was transferred to the seminary of St Sulpice at Paris in 1820. In 1825 he was ordained priest, and was appointed vicar of the Madeleine at Paris. For a time he was tutor to the Orleans princes. He became the founder of the celebrated academy at St Hyacinthe, and received a letter from Gregory XVI. eulogizing his work there, and calling him *Apostolus juventutis*. His imposing height, his noble features, his brilliant eloquence, as well as his renown for zeal and charity, made him a prominent figure in French life for many years. Crowds of persons attended his addresses, on whom his energy, command of language, powerful voice and impassioned gestures made a profound impression. When made bishop of Orleans in 1849, he pronounced a fervid panegyric on Joan of Arc, which attracted attention in England as well as France. Before this he had been sent by Archbishop Afre to Rome, and had been appointed Roman prelate and protonotary apostolic. For thirty years he remained a notable figure in France, doing his utmost to arouse his countrymen from religious indifference. In ecclesiastical policy his views were moderate; thus he opposed the definition of the dogma of papal infallibility both before and during the Vatican council, but was among the first to accept the dogma when decreed. He was a distinguished educationist who fought for the retention of the Latin classics in the schools and instituted the celebrated catechetical method of St Sulpice. Among his publications are *De l'éducation* (1850), *De la haute éducation intellectuelle* (3 vols., 1866), *Œuvres choisies* (1861, 4 vols.); *Histoire de Jésus* (1872), a counterblast to Renan's *Vie de Jésus*. He died on the 11th of October 1878.

See LIFE by F. Lagrange (Eng. tr. by Lady Herbert, London, 1885).

DUPERRON, JACQUES DAVY (1556-1618), French cardinal, was born at St Lô, in Normandy, on the 15th of November 1556. His father was a physician, who on embracing the doctrines of the Reformation became a Protestant minister, and to escape persecution settled at Bern, in Switzerland. Here Jacques Davy received his education, being taught Latin and mathematics by his father, and learning Greek and Hebrew and the philosophy then in vogue. Returning to Normandy he was presented to the king by Jacques de Matignon; after he had abjured Protestantism, being again presented by Philip Desportes, abbot of Tiron, as a young man without equal for knowledge and talent, he was appointed reader to the king. He was commanded to preach before the king at the convent of Vincennes, when the success of his sermon on the love of God, and of a funeral oration on the poet Ronsard, induced him to take orders. On the death of Mary queen of Scots he was chosen to pronounce her eulogy. On the death of Henry III., after having supported for some time the cardinal de Bourbon, the head of the league against the

king, Duperron became a faithful servant of Henry IV., and in 1591 was created by him bishop of Evreux. He instructed Henry in the Catholic religion; and in 1594 was sent to Rome, where with Cardinal d'Osat (1536-1604) he obtained Henry's absolution. On his return to his diocese, his zeal and eloquence were largely instrumental in withstanding the progress of Calvinism, and among others he converted Henry Sponde, who became bishop of Pamiers, and the Swiss general Sancy. At the conference at Fontainebleau in 1600 he argued with much eloquence and ingenuity against Du Plessis Mornay (1549-1623). In 1604 he was sent to Rome as *chargé d'affaires de France*; when Clement VIII. died, he largely contributed by his eloquence to the election of Leo XI. to the papal throne, and, on the death of Leo twenty-four days after, to the election of Paul V. While still at Rome he was made a cardinal, and in 1606 became archbishop of Sens. After the death of Henry IV. he took an active part in the states-general of 1614, when he vigorously upheld the ultramontane doctrines against the Third Estate. He died in Paris on the 6th of September 1618.

See *Les Diverses Œuvres de l'illustissime cardinal Duperron* (Paris, 1622); Pierre Férét, *Le Cardinal Duperron* (Paris, 1877).

DUPIN, ANDRÉ MARIE JEAN JACQUES (1783-1865), commonly called Dupin the Elder, French advocate, president of the chamber of deputies and of the Legislative Assembly, was born at Varsy, in Nièvre, on the 1st of February 1783. He was educated by his father, who was a lawyer of eminence, and at an early age he became principal clerk of an attorney at Paris. On the establishment of the *Académie de Législation* he entered it as pupil from Nièvre. In 1800 he was made advocate, and in 1802, when the schools of law were opened, he received successively the degrees of licentiate and doctor from the new faculty. He was in 1810 an unsuccessful candidate for the chair of law at Paris, and in 1811 he also failed to obtain the office of advocate-general at the court of cassation. About this time he was added to the commission charged with the classification of the laws of the empire, and, after the interruption caused by the events of 1814 and 1815, was charged with the sole care of that great work. When he entered the chamber of deputies in 1815 he at once took an active part in the debates as a member of the Liberal Opposition, and strenuously opposed the election of the son of Napoleon as emperor after his father's abdication. At the election after the second restoration Dupin was not re-elected. He defended with great intrepidity the principal political victims of the reaction, among others, in conjunction with Nicolas Berryer, Marshal Ney; and in October 1815 boldly published a tractate entitled *Libre Défense des accusés*. In 1827 he was again elected a member of the chamber of deputies and in 1830 he voted the address of the 221, and on the 28th of February he was in the streets exhorting the citizens to resistance. At the end of 1832 he became president of the chamber, which office he held successively for eight years. On Louis Philippe's abdication in 1848 Dupin introduced the young count of Paris into the chamber, and proposed him as king with the duchess of Orleans as regent. This attempt failed, but Dupin submitted to circumstances, and, retaining the office of *procureur-général*, his first act was to decide that justice should henceforth be rendered to the "name of the French people." In 1849 he was elected a member of the Assembly, and became president of the principal committee—that on legislation. After the *coup d'état* of the 2nd of December 1851 he still retained his office of *procureur-général*, and did not resign it until effect was given to the decrees confiscating the property of the house of Orleans. In 1857 he was offered his old office by the emperor, and accepted it, explaining his acceptance in a discourse, a sentence of which may be employed to describe his whole political career. "I have always," he said, "belonged to France and never to parties." He died on the 8th of November 1865. Among Dupin's works, which are numerous, may be mentioned *Principia Juris Civilis*, 5 vols. (1806); *Mémoires et Discours de 1806 au 1^{er} janvier 1830*, in 20 vols.; and *Mémoires ou souvenirs du barreau*, in 4 vols. (1855-1857).

His brother, FRANÇOIS PIERRE CHARLES DUPIN (1784-1873),

wrote several geometrical works, treating of descriptive geometry after the manner of Monge, and of the theory of curves.

DU PIN, LOUIS ELLIES (1657-1719), French ecclesiastical historian, came of a noble family of Normandy, and was born at Paris on the 17th of June 1657. When ten years old he entered the college of Harcourt, where he graduated M.A. in 1672. He afterwards became a pupil of the Sorbonne, and received the degree of B.D. in 1680 and that of D.D. in 1684. About this time he conceived the idea of his *Bibliothèque universelle de tous les auteurs ecclésiastiques*, the first volume of which appeared in 1686. The liberty with which he there treated the doctrines of the Fathers aroused ecclesiastical prejudice, and the archbishop of Paris condemned the work. Although Du Pin consented to a retraction, the book was suppressed in 1693; he was, however, allowed again to continue it on changing its title by substituting *nouvelle* for *universelle*. He was subsequently exiled to Châtelerauloup as a Jansenist, but the sentence of banishment was repealed on a new retraction. In 1718 he entered into a correspondence with William Wake, archbishop of Canterbury, with a view to a union of the English and Gallican churches; being suspected of projecting a change in the dogmas of the church, his papers were seized in February 1719, but nothing incriminating was found. The same zeal for union induced him, during the residence of Peter the Great in France, and at that monarch's request, to draw up a plan for uniting the Greek and Roman churches. He died at Paris on the 6th of June 1719.

Du Pin was a voluminous author. Besides his great work (Paris, 1686-1704, 58 vols. 8vo; Amsterdam, 19 vols. 4to; in the last of which he gives much autobiographical information), mention may be made of *Bibliothèque universelle des historiens* (2 vols., 1707); *L'Histoire de l'Église en abrégé* (1712); and *L'Histoire profane depuis le commencement du monde jusqu'à présent* (4 vols., 1712).

DUPLEIX, JOSEPH FRANÇOIS (1697-1763), governor-general of the French establishment in India, the great rival of Clive (q.v.), was born at Landrecies, France, on the 1st of January 1697. His father, François Duplex, a wealthy farmer-general, wished to bring him up as a merchant, and, in order to distract him from his taste for science, sent him on a voyage to India in 1715 on one of the French East India Company's vessels. He made several voyages to America and India, and in 1720 was named a member of the superior council at Pondicherry. He displayed great business aptitude, and, in addition to his official duties, made large ventures on his own account, and acquired a fortune. In 1730 he was made superintendent of French affairs in Chandernagore, the town prospering under his energetic administration and growing into great importance. His reputation procured him in 1742 the appointment of governor-general of all French establishments in India. His ambition now was to acquire for France vast territories in India; and for this purpose he entered into relations with the native princes, and adopted a style of oriental splendour in his dress and surroundings. The British took the alarm. But the danger to their settlements and power was partly averted by the bitter mutual jealousy which existed between Duplex and La Bourdonnais, French governor of the isle of Bourbon. When Madras capitulated to the French in 1764, Duplex opposed the restoration of the town to the British, thus violating the treaty signed by La Bourdonnais. He then sent an expedition against Fort St David (1747), which was defeated on its march by the nabab of Arcot, the ally of the British. Duplex succeeded in gaining over the nabab, and again attempted the capture of Fort St David, but unsuccessfully. A midnight attack on Cuddalore was repulsed with great loss. In 1748 Pondicherry was besieged by the British; but in the course of the operations news arrived of the peace concluded between the French and the British at Aix-la-Chapelle. Duplex next entered into negotiations which had for their object the subjugation of southern India, and he sent a large body of troops to the aid of two claimants of the sovereignty of the Carnatic and the Deccan. The British were engaged on the side of their rivals. After temporary successes the scheme failed. Duplex was a great organizer, but did not

possess the genius for command in the field that was shown by Clive. The conflicts between the French and the British in India continued till 1754, when the French government, anxious to make peace, sent out to India a special commissioner with orders to supersede Duplex and, if necessary, to arrest him. These orders were carried out with needless harshness, what survived of Duplex's work was ruined at a blow, and he himself was compelled to embark for France on the 12th of October 1754. He had spent his private fortune in the prosecution of his public policy; the company refused to acknowledge the obligation; and the government would do nothing for a man whom they persisted in regarding as an ambitious and greedy adventurer. The greatest of French colonial governors died in obscurity and went on the 10th of November 1763. In 1741 he had married Jeanne Albert, widow of one of the councillors of the company, a woman of strong character and intellect, known to the Hindus as Joanna Begum, who proved of great use to her husband in his negotiations with the native princes. She died in 1756, and two years later he married again.

See Tibulle Hamont, *Duplex, d'après sa correspondance inédite* (Paris, 1881); H. Castonnet, *Duplex, ses expéditions et ses projets* (Paris, 1888) and *La Chute de Duplex* (Angers, 1888); C. B. Malletson, *Duplex* (Rulers of India series, 1890); and E. Guérin, *Duplex* (1908).

DUPONT, PIERRE (1821-1870), French song-writer, the son of a blacksmith, was born at Lyons on the 23rd of April 1821. His parents both died before he was five years old, and he was brought up in the country by his godfather, a village priest. He was educated at the seminary of L'Argentière, and was afterwards apprenticed to a notary at Lyons. In 1839 he found his way to Paris, and some of his poems were inserted in the *Gazette de France* and the *Quotidien*. Two years later he was saved from the conscription and enabled to publish his first volume—*Les Deux Anges*—through the exertions of a kinsman of Pierre Lebrun. In 1842 he received a prize from the Academy, and worked for some time on the official dictionary. Gounod's appreciation of his peasant song, *J'ai deux grands bœufs dans mon étable* (1846), settled his vocation as a song-writer. He had no theoretical knowledge of music, but he composed both the words and the melodies of his songs, the two processes being generally simultaneous. He himself remained so innocent of musical knowledge that he had to engage Ernest Reyer to write down his airs. He sang his own songs, as they were composed, at the workmen's concerts in the Salle de la Fraternité du Faubourg Saint-Denis; the public performance of his famous *Le Pain* was forbidden; *Le Chant des ouvriers* was even more popular; and in 1851 he paid the penalty of having become the poet laureate of the socialistic aspirations of the time by being condemned to seven years of exile from France. The sentence was cancelled, and the poet withdrew for a time from participation in politics. He died at Lyons, where his later years were spent, on the 24th of July 1870. His songs have appeared in various forms—*Chants et chansons* (3 vols., with music, 1852-1854), *Chants et poésies* (7th edition, 1862), &c. Among the best-known are *Le Braccioni*, *Le Tisserand*, *La Vache blanche*, *La Chanson du blé*, but many others might be mentioned of equal spontaneity and charm. His later works have not the same merit.

See also Sainte-Beuve, *Causeries du lundi*, iv.; Ch. Baudelaire, *Notice sur P. Dupont* (1849); Déchaut, *Biographie de Pierre Dupont* (1871); and Ch. Lenient, *Poésie patriotique en France* (1889), ii. 352 et seq.

DUPONT DE L'ÉTANG, PIERRE ANTOINE, COUNT (1765-1840), French general, first saw active service as a member of Maillebois' legion in Holland, and in 1791 was on the staff of the Army of the North under Dillon. He distinguished himself at Valmy, and in the fighting around Menin in 1793 he forced an Austrian regiment to surrender. Promoted general of brigade for this feat, he soon received further advancement from Carnot, who recognized his abilities. In 1797 he became general of division. The rise of Napoleon, whom he warmly supported in the *coup d'état* of 18th Brumaire, brought him further opportunities. In the campaign of 1800 he was chief of the staff to Berthier the nominal commander of the "Army of Reserve of the Alp

which won the battle of Marengo. After the battle he sustained a brilliant combat, against greatly superior forces, at Pozzolo. In the campaign on the Danube in 1805, as the leader of one of Ney's divisions, he earned further distinction, especially at the action of Albeck-Haslach, in which he prevented the escape of the Austrians from Ulm, and so contributed most effectively to the isolation and subsequent capture of Mack and his whole army (see NAPOLEONIC CAMPAIGNS). At Friedland he won further fame. With a record such as but few Napoleon's divisional commanders possessed, he entered Spain in 1808 at the head of a corps. After the occupation of Madrid, Dupont, newly created count by Napoleon, was sent to subdue Andalusia. After a few initial successes he had to retire on the passes of the Sierra Morena. Pursued and cut off by the Spanish army under Castaños, his corps was defeated and he felt himself constrained to capitulate (Baylen, 19th-23rd July; see PENINSULAR WAR). The disgrace which fell upon the general was not entirely merited. His troops were for the most part raw levies, and ill-luck contributed materially to the catastrophe, but, after his return to France, Dupont was sent before a court-martial, deprived of his rank and title, and imprisoned from 1812 to 1814. Released only by the fall of Napoleon, he was employed by Louis XVIII. in a military command, which he lost on the return of Napoleon. But the Second Restoration saw him restored to the army, and appointed a member of the *conseil privé* of Louis XVIII. From 1815 to 1830 he was deputy for the Charente. He lived in retirement from 1832 till his death in 1840. Amongst the writings Dupont left are some poems, including *L'Art de la guerre* (1838), and verse translations from Horace (1836), and the following military works: *Opinion sur le nouveau mode de recrutement* (1818), *Lettres sur l'Espagne en 1808* (1823), *Lettre sur la campagne d'Autriche* (1826). At the time of his death he was on the point of publishing his memoirs.

See Lieut.-Col. Titeux, *Le Général Dupont: une erreur historique* (Paris, 1903).

DUPONT DE L'EURE, JACQUES CHARLES (1767-1855), French lawyer and statesman, was born at Neubourg (Eure), in Normandy, on the 27th of February 1767. In 1789 he was an advocate at the parlement of Normandy. During the republic and the empire he filled successively judicial offices at Louviers, Rouen and Evreux. He had adopted the principles of the Revolution, and in 1798 he commenced his political life as a member of the Council of Five Hundred. In 1813 he became a member of the Corps Législatif. During the Hundred Days he was vice-president of the chamber of deputies, and when the allied armies entered Paris he drew up the declaration in which the chamber asserted the necessity of maintaining the principles of government that had been established at the Revolution. He was chosen one of the commissioners to negotiate with the allied sovereigns. From 1817 till 1849 he was uninterruptedly a member of the chamber of deputies, and he acted consistently with the liberal opposition, of which at more than one crisis he was the virtual leader. For a few months in 1830 he held office as minister of justice, but, finding himself out of harmony with his colleagues, he resigned before the close of the year and resumed his place in the opposition. At the revolution of 1848 Dupont de l'Eure was made president of the provisional assembly as being its oldest member. In the following year, having failed to secure his re-election to the chamber, he retired into private life. He died in 1855. The consistent firmness with which he adhered to the cause of constitutional liberalism during the many changes of his times gained him the highest respect of his countrymen, by whom he was styled the Aristides of the French tribune.

DU PONT DE NEMOURS, PIERRE SAMUEL (1739-1817), French political economist and statesman, was born at Paris on the 14th of September 1739. He studied for the medical profession, but did not enter upon practice, his attention having been early directed to economic questions through his friendship with François Quesnay, Turgot and other leaders of the school known as the Economists. To this school he rendered valuable service by several pamphlets on financial questions, and numerous

articles representing and advocating its views in a popular style in the *Journal de l'agriculture, du commerce, et des finances*, and the *Éphémérides du citoyen*, of which he was successively editor. In 1772 he accepted the office of secretary of the council of public instruction from Stanislas Poniatowski, king of Poland. Two years later he was recalled to France by the advent of his friend Turgot to power. After assisting the minister in his wisely-conceived but unavailing schemes of reform during the brief period of his tenure of office, Du Pont shared his dismissal and retired to Gâtinais, in the neighbourhood of Nemours, where he employed himself in agricultural improvements. During his leisure he wrote a translation of Ariosto (1781), and *Mémoires sur la vie de Turgot* (1782). He was drawn from his retirement by C. G. de Vergennes, minister of foreign affairs, who employed him in 1782 in negotiating, with the English commissioner Dr James Hutton, for recognition of the independence of the United States (1782), and in preparing a treaty of commerce with Great Britain (1786). Under Calonne he became councillor of state, and was appointed commissary-general of commerce.

During the Revolution period he advocated constitutional monarchy, and was returned as deputy by the Third Estate of the *bailliage* of Nemours to the states-general, and then to the Constituent Assembly, of which he was elected president on the 26th of October 1790. But his conservative opinions rendered him more and more unpopular, and after the 10th of August 1792, when he took the side of the king, he was forced to lie concealed for some weeks in the observatory of the Mazarin College, from which he contrived to escape to the country. During the time that elapsed before he was discovered and arrested he wrote his *Philosophie de l'univers*. Imprisoned in La Force (1794), he was one of those who had the good fortune to escape the guillotine till the death of Robespierre set them free. As a member of the Council of Five Hundred, Du Pont carried out his policy of resistance to the Jacobins, and made himself prominent as a member of the reactionary party. After the republican triumph on the 18th Fructidor (4th of September) 1797 his house was sacked by the mob, and he himself only escaped transportation to Cayenne through the influence of M. J. Chénier. In 1799 he found it advisable for his comfort, if not for his safety, to emigrate with his family to the United States. Jefferson's high opinion of Du Pont was shown in using him in 1802 to convey to Bonaparte unofficially a threat against the French occupation of Louisiana; and also, earlier, in requesting him to prepare a scheme of national education, which was published in 1800 under the title *Sur l'éducation nationale dans les États-Unis d'Amérique*. Though the scheme was not carried out in the United States, several of its features have been adopted in the existing French code. On his return to France in 1802 he declined to accept any office under Napoleon, devoted himself almost exclusively to literary pursuits, and was elected to the *Institut*. On the downfall of Napoleon in 1814 Du Pont became secretary to the provisional government, and on the restoration he was made a councillor of state. The return of the emperor in 1815 determined him to quit France, and he spent the close of his life with his younger son, Eleuthère Irénée (1771-1834), who had established a powder manufactory in Delaware. He died at Eleutherian Mills near Wilmington, Delaware, on the 6th of August 1817.

His family continued to conduct the powder-mills, which brought them considerable wealth. The business was subsequently converted into the E. I. Du Pont de Nemours Powder Company. His grandson, Admiral Samuel Francis Du Pont (1803-1865), played a conspicuous part as a U.S. naval officer in the American Civil War. His great-grandson, Henry Algernon Du Pont (b. 1838), president of the Wilmington & Northern railway, was a soldier in the Civil War, and afterwards a United States senator.

Du Pont's most important works, besides those mentioned above, were his *De l'origine et des progrès d'une science nouvelle* (London and Paris, 1767); *Physiocrate, ou constitution naturelle du gouvernement le plus avantageux au genre humain* (Paris, 1768); and his *Observations sur les effets de la liberté du commerce des grains* (1760). They are gathered together in vol. II. of the *Collection des économistes*

(1846). See notices of his life (1818) by Silvestre and Baron de Gerando; also Schelle, *Du Pont-de Nemours et l'école physiocratique* (1888).

DUPORT, ADRIEN (1759-1798), French politician, was born in Paris. He became an influential advocate in the parlement, becoming prominent in opposition to the ministers Calonne and Loménie de Brienne. Elected in 1789 to the states-general by the noblesse of Paris, he soon revealed a remarkable eloquence. A learned jurist, he contributed during the Constituent Assembly to the organization of the judiciary of France. His report of the 20th of March 1790 is especially notable. In it he advocated trial by jury; but he was unable to obtain the jury system in civil cases. Duport had formed with Barnave and Alexandre de Lameth a group known as the "triumvirate," which was popular at first. But after the flight of the king to Varennes, Duport sought to defend him; as member of the commission charged to question the king, he tried to excuse him, and on the 14th of July 1791 he opposed the formal accusation. He was thus led to separate himself from the Jacobins and to join the Feuillant party. After the Constituent Assembly he became president of the criminal tribunal of Paris, but was arrested during the insurrection of the 10th of August 1792. He escaped, thanks probably to the complicity of Danton, returned to France after the 9th of Thermidor of the year II., left it in exile again after the republican *coup d'état* of the 18th of Fructidor of the year V., and died at Appenzell in Switzerland in 1798.

See F. A. Aulard, *Les Orateurs de la Constituante* (2nd ed., Paris, 1905, 8vo).

DUPORT, JAMES (1606-1679), English classical scholar, was born at Cambridge. His father, John Duport, who was descended from an old Norman family (the Du Ports of Caen, who settled in Leicestershire during the reign of Henry IV.), was master of Jesus College. The son was educated at Westminster and at Trinity College, where he became fellow and subsequently vicemaster. In 1639 he was appointed regius professor of Greek, in 1664 dean of Peterborough, and in 1668 master of Magdalene College. He died at Peterborough on the 17th of July 1679. Throughout the troublous times of the Civil War, in spite of the loss of his clerical offices and eventually of his professorship, Duport quietly continued his lectures. He is best known by his *Homeri gnomologia* (1660), a collection of all the aphorisms, maxims and remarkable opinions in the *Iliad* and *Odyssey*, illustrated by quotations from the Bible and classical literature. His other published works chiefly consist of translations (from the Bible and Prayer Book into Greek) and short original poems, collected under the title of *Horae subscribæ* or *Stramata*. They include congratulatory odes (inscribed to the king); funeral odes; *carmina comitalia* (trijros verses on different theses maintained in the schools, remarkable for their philosophical and metaphysical knowledge); sacred epigrams; and three books of miscellaneous poems (*Synæce*). The character of Duport's work is not such as to appeal to modern scholars, but he deserves the credit of having done much to keep alive the study of classical literature in his day.

The chief authority for the life of Duport is J. H. Monk's "Memoir" (1825); see also Sandys, *Hist. Class. Schol.* (1908), ii. 349.

DÜPPEL, a village of Germany, in the Prussian province of Schleswig-Holstein, opposite the town of Sonderburg (on the island of Alsen). (Pop. 600.) The position of Düppel, forming as it does a bridge-head for the defenders of the island of Alsen, played a conspicuous part in the wars between Denmark and the Germans. On the 28th of May 1848 the German federal troops were there defeated by the Danes under General Hedemann, and a second battle was fought on the 6th of June 1848. On the 13th of April 1849 an indecisive battle was fought between the federal troops under von Prittwitz and the Danes under von Bülow. The most important event in the military history of Düppel was, however, the siege by the Prussians of the Danish position in 1864. The flanks of the defenders' line rested upon the Alsen Sund and the sea, and it was strengthened by ten redoubts. A second line of trenches with lunettes at intervals was constructed behind the front attacked, and a small réduit opposite Sonderburg to cover the bridges between Alsen and the

mainland. The Prussian siege corps was commanded by Prince Frederick Charles (headquarters, Düppel village), and after three weeks' skirmishing a regular siege was begun, the batteries being opened on the 15th of March. The first parallel was completed fifteen days later, the front of attack being redoubts II. to VI., forming the centre of the Danish entrenchments on the road Düppel-Sonderburg. The siege was pushed rapidly from the first parallel and the assault delivered on the 18th of April, against the redoubts I. to VI., each redoubt being attacked by a separate column. The whole line was carried after a brief but severe conflict, and the Prussians had penetrated to and captured the réduit opposite Sonderburg by 2 P.M. The loss of the Danes, half of whose forces were not engaged, included 1800 killed and wounded and 3400 prisoners. This operation was followed by the daring passage of the Alsen Sund, effected by the Prussians in boats almost under the guns of the Danish warships, and resulting in the capture of the whole island of Alsen (June 29th, 1864). After being still further strengthened and linked with similar defences at Sonderburg, the Düppel entrenchments were abandoned in 1881 in favour of landward fortifications around Kiel.

See R. Neumann, *Über den Angriff der Düppeler Schanzen in der Zeit vom 15. März bis 18. April 1864* (Berlin, 1865); and *Der deutsch-dänische Krieg 1864*, published by the Prussian General Staff (Berlin, 1887).

DU PRAT, ANTOINE (1463-1535), chancellor of France and cardinal, was born at Issoire on the 17th of January 1463. He began life as a lawyer, and rose rapidly in the legal hierarchy owing to the influence of his cousin Antoine Bohier, cardinal archbishop of Bourges. The first office which he held was that of lieutenant-general in the *bailliage* of Montferrand; in 1507 he became first president of the parlement of Paris. Louise of Savoy had employed him as her adviser in her affairs, and had made him tutor to her son. When Francis I. ascended the throne he made Du Prat chancellor of France, in which capacity he played an important part in the government. It was he who negotiated with Leo X. concerning the abolition of the Pragmatic Sanction and the establishment of a concordat. After the meeting of the Field of the Cloth of Gold (1520) he was engaged in unsuccessful negotiations with Wolsey. During the regency of Louise of Savoy he, together with Florimond Robertet, was at the head of affairs. He took an active part in the suit brought by Louise of Savoy against the Constable de Bourbon, and in 1532 completed the work of uniting Brittany to France. After the death of his wife in 1507 Du Prat had taken orders; he received the bishoprics of Valence, Die, Meaux and Albi, and the archbishopric of Sens (1525); in 1527 he became cardinal, and in 1530 papal legate. He was a determined adversary of the Reformation. He died on the 9th of July 1535.

See the marquis Du Prat, *Vie d'Antoine Du Prat* (Paris, 1857).

DUPRÉ, JULES (1812-1889), French painter, was one of the chief members of the Barbizon group of romantic landscape painters. If Corot stands for the lyric and Rousseau for the epic aspect of the poetry of nature, Dupré is the exponent of her tragic and dramatic aspects. He was the son of a porcelain manufacturer, and started his career in his father's works, whence he went to his uncle's china factory at Sèvres. After studying for some time under Diébold, a painter of clock faces, he had to pass through a short period of privation, until he attracted the attention of a wealthy patron, who came to his studio and bought all the studies on the walls at the price demanded by the artist—20 francs apiece. Dupré exhibited first at the Salon in 1831, and three years later was awarded a second-class medal. In the same year he came to England, where he was deeply impressed by the genius of Constable. From him he learnt how to express movement in nature; and the district of Southampton and Plymouth, with its wide, unbroken expanses of water, sky and ground, gave him good opportunities for studying the tempestuous motion of storm-clouds and the movement of foliage driven by the wind. He received the cross of the Legion of Honour in 1848. Dupré's colour is sonorous and resonant; the subjects for which he showed marked preference are dramatic

sunset effects and stormy skies and seas. Late in life he changed his style and gained appreciably in largeness of handling and arrived at greater simplicity in his colour harmonies. Among his chief works are the "Morning" and "Evening" at the Louvre, and the early "Crossing the Bridge" in the Wallace Collection.

DUPUIS, CHARLES FRANÇOIS (1742-1809), French scientific writer and politician, was born of poor parents at Trye-Château, between Gisors and Chaumont, on the 26th of October 1742. His father, who was a teacher, instructed him in mathematics and land-surveying. While he was engaged in measuring a tower by a geometrical method, the duc de la Rochefoucauld met him and was so taken by the lad's intelligence that he gave him a bursary in the college of Harcourt. Dupuis made such rapid progress that, at the age of twenty-four, he was appointed professor of rhetoric at the college of Lisieux, where he had previously passed as a licentiate of theology. In his hours of leisure he studied law, and in 1770 he abandoned the clerical career and became an advocate. Two university discourses which he delivered in Latin were printed, and laid the foundation of his literary fame. His chief attention, however, was devoted to mathematics, the object of his early studies; and for some years he attended the astronomical lectures of Lalande, with whom he formed an intimate friendship. In 1778 he constructed a telegraph on the principle suggested by Guillaume Amontons (*q.v.*), and employed it in keeping up a correspondence with his friend Jean Fortin in the neighbouring village of Bagneux, until the Revolution made it necessary to destroy his machine to avoid suspicion. About the same time Dupuis formed his theory as to the origin of the Greek months. He endeavoured to account for the want of any resemblance between the groups of stars and the names by which they are known, by supposing that the zodiac was, for the people who invented it, a sort of calendar at once astronomical and rural, and that the figures chosen for the constellations were such as would naturally suggest the agricultural operations of the season. It seemed only necessary, therefore, to discover the clime and the period in which the constellation of Capricorn must have arisen with the sun on the day of the summer solstice, and the vernal equinox must have occurred under Libra. It appeared to Dupuis that this clime was Upper Egypt, and that the perfect correspondence between the signs and their significations had existed in that country at a period of between fifteen and sixteen thousand years before the present time; that it had existed only there; and that this harmony had been disturbed by the effect of the precession of the equinoxes. He therefore ascribed the invention of the signs of the zodiac to the people who then inhabited Upper Egypt or Ethiopia. This was the basis on which Dupuis established his mythological system, and endeavoured to explain fabulous history and the whole system of the theogony and theology of the ancients. Dupuis published several detached parts of his system in the *Journal des savants* for 1777 and 1781. These he afterwards collected and published, first in Lalande's *Astronomy*, and then in a separate volume in 4to, 1781, under the title of *Mémoire sur l'origine des constellations et sur l'explication de la fable par l'astronomie*. The theory propounded in this memoir was refuted by J. S. Bailly in his *Histoire de l'Astronomie*, but, at the same time, with a just acknowledgment of the erudition and ingenuity exhibited by the author.

Condorcet proposed Dupuis to Frederick the Great of Prussia as a fit person to succeed Thiébauld in the professorship of literature at Berlin; and Dupuis had accepted the invitation, when the death of the king cancelled the engagement. The chair of humanity in the College of France having at the same time become vacant, it was conferred on Dupuis; and in 1788 he became a member of the Academy of Inscriptions. He now resigned his professorship at Lisieux, and was appointed by the administrators of the department of Paris one of the four commissioners of public instruction. At the outbreak of the Revolutionary troubles Dupuis sought safety at Evreux; and, having been chosen a member of the National Convention by the department of Seine-et-Oise, he distinguished himself by his moderation. In the third year of the republic he was elected secretary to the Assembly, and in the fourth he was chosen a

member of the Council of Five Hundred. After Bonaparte's *coup d'état* of the 18th Brumaire he was elected by the department of Seine-et-Oise a member of the Legislative Body, of which he became the president. He was proposed as a candidate for the senate, but resolved to abandon politics, devoting himself during the rest of his life to his favourite studies.

In 1795 he published the work by which he is best known, entitled *Origine de tous les cultes, ou la religion universelle* (3 vols. 4to, with an atlas, or 12 vols. 12mo). This work, of which an edition revised by P. R. Auguis was published in 1822 (10th ed., 1835-1836), became the subject of much bitter controversy, and the theory it propounded as to the origin of mythology in Upper Egypt led to the expedition organized by Napoleon for the exploration of that country. In 1798 Dupuis published an abridgment of his work in one volume 8vo, which met with no better success than the original. Another abridgment of the same work, executed upon a much more methodical plan, was published by M. de Tracy. The other works of Dupuis consist of two memoirs on the Pelagii, inserted in the *Memoirs of the Institut*; a memoir "On the Zodiac of Tentyra," published in the *Revue philosophique* for May 1806; and a *Mémoire explicatif du zodiaque chronologique et mythologique*, published the same year, in one volume 4to. He died on the 29th of September 1809.

DUPUY, CHARLES ALEXANDRE (1851-), French statesman, was born at Le Puy on the 5th of November 1851, his father being a local official. After being a professor of philosophy in the provinces, he was appointed a school inspector, and thus obtained a practical acquaintance with the needs of French education. In 1885 he was elected to the chamber as an Opportunist Republican. After acting as "reporter" of the budget for public instruction, he became minister for the department, in M. Ribot's cabinet, in 1892. In April 1893 he formed a ministry himself, taking as his office that of minister of the interior, but resigned at the end of November, and on 5th December was elected president of the chamber. During his first week of office an anarchist, Vaillant, who had managed to gain admission to the chamber, threw a bomb at the president, and M. Dupuy's collected bearing, and his historic words: "Messieurs, la séance continue," gained him much credit. In May 1894 he again became premier and minister of the interior; and he was by President Carnot's side when the latter was stabbed to death at Lyons in June. He then became a candidate for the presidency, but was defeated, and his cabinet remained in office till January 1895; it was under it that Captain Dreyfus was arrested and condemned (23rd of December 1894). The progress of *l'affaire* then cast its shadow upon M. Dupuy, along with other French "ministres," but in November 1898, after M. Brisson had at last remitted the case to the judgment of the court of cassation, he formed a cabinet of Republican concentration. In view of the apparent likelihood that the judges of the criminal division of the court of cassation—who formed the ordinary tribunal for such an appeal—would decide in favour of Dreyfus, it was thought that M. Dupuy's new cabinet would be strong enough to reconcile public opinion to such a result; but, to the surprise of outside observers, it was no sooner discovered how the judges were likely to decide than M. Dupuy proposed a law in the chamber transferring the decision to a full court of all the divisions of the court of cassation. This arbitrary act, though adopted by the chamber, was at once construed as a fresh attempt to maintain the judgment of the first court-martial; but in the interval President Faure (an anti-Dreyfusard) died, and the accession of M. Loubet doubtless had some effect in quieting public feeling. At all events, the whole court of cassation decided that there must be a new court-martial, and M. Dupuy at once resigned (June 1899). In June 1900 he was elected senator for the Haute Saône.

DUPUY, PIERRE (1582-1651), French scholar, otherwise known as PUTEANUS, was born at Agen (Lot-et-Garonne) on the 27th of November 1582. In 1615 he was commissioned by Mathieu Molé, first president of the parlement of Paris, to draw up an inventory of the documents which constituted what at that time was known as the *Trésor des chartes*. This work

occupied eleven years. His MS. inventory is preserved in the original and in copy in the Bibliothèque Nationale, and transcriptions are in the national archives in Paris, at the record office in London, and elsewhere. Dupuy's classification is still regarded with respect, but the inventory has been partially replaced by the publication of the *Layettes du trésor* (four volumes, coming down to 1270; 1863-1902). Dupuy also published, with his brother Jacques, and their friend Nicolas Rigault, the *History of Aug. de Thou* (1620, 1626). The two brothers then bought from Rigault the post of keeper of the king's library, and drew up a catalogue of the library (Nos. 9352-9354 and 10366-10367 of the Latin collection in the Bibliothèque Nationale). In the course of this work, Dupuy became acquainted with and copied an enormous mass of unpublished documents, which furnished him with the material for some excellent works: *Traité des droits et des libertés de l'église gallicane, avec les preuves* (1630), *Histoire de l'ordre militaire des Templiers* (1654), *Histoire générale du schisme qui a été dans l'église depuis 1378 jusqu'à 1428* (1654), and *Histoire du différend entre le pape Boniface VIII et le roi Philippe le Bel* (1655). These works, especially the last, are important contributions to the history of the relations of church and state in the middle ages. They were written from the Gallican standpoint, i.e. in favour of the rights of the crown in temporal and political matters, and this explains the delay in their publication until after Dupuy's death. He wrote also *Traité des régences et des majorités des rois de France* (1655) and *Recueil des droits du roi* (1658). Dupuy's papers, preserved in the Bibliothèque Nationale, were inventoried by Léon Dorez (*Catalogue de la collection Dupuy*, 1899). See also L. Delisle's *Le Cabinet des manuscrits de la bibliothèque impériale*. Dupuy died in Paris on the 14th of December 1651.

DUPUY DE LÔME, STANISLAS CHARLES HENRI LAURENT (1816-1885), French naval architect, the son of a retired naval officer, was born at Ploemeur, near Lorient, on the 15th of October 1816. He entered the École Polytechnique in 1835, and in 1842 was sent to England to study and report on iron ship-building. Acting on his report, which was published in 1844, the government built their first iron vessels under his supervision. He planned and built the steam line-of-battle ship "Napoleon" (1848-1852), and devised the method of altering sailing ships of the line into steamers, which was afterwards extensively practised in both France and England. He also showed the practicability of armouring the sides of a ship, and the frigate "Gloire" gave a very clear demonstration of his views. It was the beginning of the great change in the construction of ships of war which has been going on ever since. In 1857 Dupuy de Lôme was appointed "chef de la direction du matériel," at Paris; and in 1861, "inspecteur général du matériel de la marine." In 1866 he was elected a member of the Academy of Sciences. At the beginning of the Franco-German War he was appointed a member of the committee of defence, and during the siege of Paris occupied himself with planning a steerable balloon, for carrying out which he was given a credit of 40,000 fr.; but the balloon was not ready till a few days before the capitulation. The experiments that were afterwards made with it did not prove entirely satisfactory. In 1875 he was busy over a scheme for embarking a railway train at Calais, and exhibited plans of the improved harbour and models of the "bateaux porte-trains" to the Academy of Sciences in July. In 1877 he was elected a senator for life. He received the cross of the Legion of Honour in 1845, was made a commander in 1858, and grand officer in December 1863. He died at Paris on the 1st of February 1885.

DUPUYTREN, GUILLAUME, BARON (1777-1835), French anatomist and surgeon, was born on the 6th of October 1777 at Pierre Buffère (Haute Vienne). He studied medicine in Paris at the newly established École de Médecine, and was appointed by competition prosecutor when only eighteen years of age. His early studies were directed chiefly to morbid anatomy. In 1803 he was appointed assistant-surgeon at the Hôtel-Dieu, and in 1811 professor of operative surgery in succession to R. B. Sabatier (1732-1811). In 1815 he was appointed to the chair of clinical

surgery, and became head surgeon at the Hôtel-Dieu. Dupuytren's energy and industry were alike remarkable. He visited the Hôtel-Dieu morning and evening, performing at each time several operations, lectured to vast throngs of students, gave advice to his outdoor patients, and fulfilled the duties consequent upon one of the largest practices of modern times. By his indefatigable activity he amassed a fortune of £300,000, the bulk of which he bequeathed to his daughter, with the deduction of considerable sums for the endowment of the anatomical chair in the École de Médecine, and the establishment of a benevolent institution for distressed medical men. The most important of Dupuytren's writings is his *Treatise on Artificial Anus*, in which he applied the principles laid down by John Hunter. In his operations he was remarkable for his skill and dexterity, and for his great readiness of resource. He died in Paris on the 8th of February 1835.

DUQUE DE ESTRADA, DIEGO (1580-?), Spanish memoir writer, soldier and adventurer, son of Juan Duque de Estrada, also a soldier of rank, was born at Toledo on the 15th of August 1580. Having been left an orphan when very young, he was educated by a cousin. While still young he was betrothed to his cousin's daughter. One night he found an intruder in the house, a gentleman with whom he was acquainted, and in a fit of jealousy killed both him and the young lady. The prevailing code of honour was considered a sufficient justification for Duque de Estrada's violence, but the law looked upon the act as a vulgar assassination, and he had to flee. After leading a vagabond life in the south of Spain, he was arrested at Ecija, was brought to Toledo, and was there put to the torture with extreme ferocity, in order to extort a general confession as to his life during the past months. He had the strength not to yield to pain, and was finally able to escape from prison, partly by the help of a nun in a religious house which faced the prison, and partly by the intervention of friends. He made his way to Naples, where he entered the service of the duke of Osuna (q.v.), at that time viceroy. Duque de Estrada saw a good deal of fighting both with the Turks and the Venetians; but he is mainly interesting because he was employed by the viceroy in the conspiracy against Venice. He was one of the disguised Spanish soldiers who were sent into the town to destroy the arsenal, and who were warned in time that the conspiracy had been betrayed, and therefore escaped. After the fall of his patron, Duque de Estrada resumed his vagabond life, served under Bethlen Gabor in Transylvania, and in the Thirty Years' War. In 1633 he entered the order of San Juan de Dios, and died at some time after 1637 in Sardinia, where he is known to have taken part in the defence of the island against an attack by the French. He left a book of memoirs, entitled *Comentarios de el desengañado de sí Mismo prueba de todos estados, y eleccion del Mejor de ellos*—The Commentaries of one who knew his own little worth, the touchstone of all the state of man, and the choice of the best." They were written at different times, and part has been lost. The style is incorrect, and it would be unsafe to trust them in every detail, but they are amazingly vivid, and contain a wonderful picture of the moral and intellectual state of a large part of Spanish society at the time.

The memoirs have been reprinted by Don Pascual de Gayangos in the *Memorial histórico español*, vol. xii. (Madrid, 1860).

DUQUESNE, ABRAHAM, MARQUIS (1610-1688), French naval officer, was born at Dieppe in 1610. Born in a stirring seaport, the son of a distinguished naval officer, he naturally adopted the profession of a sailor. He spent his youth in the merchant service, and obtained his first distinction in naval warfare by the capture of the island of Lerins from the Spaniards in May 1637. About the same time his father was killed in an engagement with the Spaniards, and the news raised his hatred of the national enemy to the pitch of a personal and bitter animosity. For the next five years he sought every opportunity of inflicting defeat and humiliation on the Spanish navy, and he distinguished himself by his bravery in the engagement at Guetaria (1638), the expedition to Corunna (1639), and in battles at Tarragona (1641), Barcelona (1643), and the Cabo de Gata.

The French navy being left unemployed during the minority of Louis XIV., Duquesne obtained leave to offer his services to the king of Sweden, who gave him a commission as vice-admiral in 1643. In this capacity he defeated the Danish fleet near Gothenburg and thus raised the siege of the city. The Danes returned to the struggle with increased forces under the command of King Christian in person, but they were again defeated—their admiral being killed and his ship taken. Peace having been concluded between Sweden and Denmark in 1645, Duquesne returned to France. The revolt at Bordeaux, supported as it was by material aid from Spain, gave him the opportunity of at once serving his country and gratifying his long-cherished hatred of the Spaniards. In 1650 he fitted out at his own expense a squadron with which he blockaded the mouth of the Gironde, and compelled the city to surrender. For this service he was promoted in rank, and received a gift of the castle and isle of Indre, near Nantes. Peace with Spain was concluded in 1659, and for some years afterwards Duquesne was occupied in endeavours to suppress piracy in the Mediterranean. On the revolt of Messina from Spain, he was sent to support the insurgents, and had to encounter the united fleets of Spain and Holland under the command of the celebrated Admiral de Ruyter. After several battles, in which the advantage was generally on the side of the French, a decisive engagement took place near Catania, on the 20th of April 1676, when the Dutch fleet was totally routed and de Ruyter mortally wounded. The greater part of the defeated fleet was afterwards burned in the harbour of Palermo, where it had taken refuge, and the French thus secured the undisputed command of the Mediterranean. For this important service Duquesne received a letter of thanks from Louis XIV., together with the title of marquis and the estate of Bouchet. His last achievements were the bombardment of Algiers (1682–1683), in order to effect the deliverance of the Christian captives, and the bombardment of Genoa in 1684. He retired from service in 1684, on the ground of age and ill-health. It is probable also that he foresaw the revocation of the edict of Nantes, which took place in the following year. He died in Paris on the 2nd of February 1688.

See Jal, *Abraham Duquesne, et la marine de son temps* (1873).

DUQUESNE, a borough of Allegheny county, Pennsylvania, U.S.A., on the Monongahela river, about 12 m. S.E. of Pittsburg. Pop. (1900) 9036, of whom 3451 were foreign-born; (1910 census) 15,727. It is served by the Pennsylvania railway. Its most prominent buildings are the Carnegie free library and club (opened in 1904 and containing 17,500 volumes in 1908), and the city hall. A short distance N. of the borough limits Kenneywood Park, with a large auditorium and pavilion, is an attractive resort. By far the most important industry of the borough is the manufacture of steel. The value of the borough's factory products increased from \$20,333,476 in 1900 to \$28,494,303 in 1905, or 40.1%. The municipality owns and operates its water-works. Duquesne was settled in 1885 and was incorporated in 1891.

DURAMEN (a rare Latin word, meaning hardness, from *durus*, hard), a botanical term for the inner, harder wood of a tree, the heart-wood.

DURAN, a Jewish Provençal family of rabbis and scholars, of whom the following are the most important.

1. **PROZAT DURAN**, called also **ERHONI**. He was in 1391 compelled to profess Christianity, but remained devoted to Judaism. His chief works were grammatical and philosophical. In the former realm his most important contribution was the *Ma'aseh 'Ephod* (completed in 1403); in the latter, his commentary to the *Guide of the Perplexed* by Maimonides (q.v.).

2. **SIMON BEN ZEMAH DURAN** (1361–1441), rabbi of Algiers. He was one of the first of the medieval rabbis to be a salaried official of the synagogue. Before the 14th century the rabbinical post had been almost invariably honorary, and filled by men who derived their income from a profession, especially medicine. Duran wrote a systematic work on theology, *Magen 'Aboth*, but is chiefly famous for his numerous *Responso* (known as *Tashbas*) published in three vols. in 1738–1739. These *Responso*,

"Answers to questions sent from many lands," give valuable information as to social and religious conditions in the earlier part of the 15th century. (I. A.)

DURÁN, AGUSTÍN (1789–1862), Spanish scholar, was born in 1789 at Madrid, where his father was court physician. He was sent to the seminary at Vergara, whence he returned learned in the traditions of Spanish romance. In 1817 he began the study of philosophy and law at the university of Seville, and in due course was admitted to the bar at Valladolid. From 1821 to 1823 he held a post in the education department at Madrid, but in the latter year he was suspended on account of his political opinions. In 1834 he became secretary of the board for the censorship of the press, and shortly afterwards obtained a post in the national library at Madrid. The revolution of 1840 led to his dismissal; but he was reinstated in 1843, and in 1854 was appointed chief librarian. Next year, however, he retired to devote himself to his literary work. In 1828, shortly after his first discharge from office, he published anonymously his *Discurso sobre el influjo que ha tenido la crítica moderna en la decadencia del teatro antiguo*; this treatise greatly influenced the younger dramatists of the day. He next endeavoured to interest his fellow-countrymen in their ancient, neglected ballads, and in the forgotten dramas of the 17th century. Five volumes of a *Romancero general* appeared from 1828 to 1832 (republished, with considerable additions, in 2 vols. 1849–1851), and *Tales española* (1834), a reprint of old Spanish comedies. Durán's *Romancero general* is the fullest collection of the kind and is therefore unlikely to be superseded, though the texts are inferior to those edited by Menéndez y Pelayo.

DURANCE (anc. *Druentia*), one of the principal rivers descending from the French slope of the Alps towards the Mediterranean. Its total length from its source to its junction with the Rhone (of which it is one of the principal affluents), a little below Avignon, is 217½ m. For the greater part of its course it flows in a south-westerly direction, but near Pertuis gradually bends N.W. and thenceforth preserves this direction. It passes through the departments of Hautes-Alpes, of Basses-Alpes, and between those of Vaucluse and Bouches-du-Rhône. It is commonly said to take its origin in some small lakes a little south of the summit plateau of the Mont Genève Pass. But really this stream is surpassed both in volume and length of course by two others which it joins beneath Briançon—the Clairet, flowing in from the north, through the smiling Névache glen, at the head of which, not far from the foot of the Mont Thabor (10,440 ft.), it rises in some small lakes, on the east side of the Col des Rochilles; and the Guisane (flowing in from the north-west and rising near the Col du Lautaret, 6808 ft.). The united stream soon receives its first affluent, the Cerveyrette (left), and, after having passed through some fine deep-cut gorges, the Gyronde (right). It then runs through a stony plain, where it frequently overflows and causes great damage, this being indeed the main characteristic of the Durance throughout its course. At the foot of the fortress of Mont Dauphin it receives (left) the Guil, which flows through the Queyras valley from near the foot of Monte Viso. Some way beyond it passes beneath Embrun, the first important town on its banks. It soon becomes the boundary for a while between the departments of the Hautes-Alpes and of the Basses-Alpes, and receives successively the considerable Ubaye river, flowing from near the foot of Monte Viso past Barcelonnette (left), and then the small stream of the Luye (right), on which, a few miles above, is Gap. It enters the Basses-Alpes shortly before reaching Sisteron, where it is joined (right) by the wild torrent of the Buëch, flowing from the desolate region of the Dévoluy, and receives the Bléone (left) (on which Digne, the capital of the department, is situated) and the Assé (left), before quitting the department of the Basses-Alpes just as it is reinforced (left) by the Verdon, flowing from the lower summits of the Maritime Alps past Castellane. After passing through some narrow gorges near Sisteron the bed of the river becomes wide, and spreads desolation around, the frequent overflows being kept within bounds by numerous dykes and embankments. These features are especially marked when the

river, after leaving the Basses-Alpes, soon bends N.W. and, always serving as the boundary between the departments of Vaucluse (N.) and of the Bouches-du-Rhône (S.), passes Cavaillon before it effects its junction with the Rhône. The drainage area of the Durance is about 5166 sq. m., while the height it descends is 6550 ft., if reckoned from the lakes on the Mont Genève, or 7850 ft. if we take those at the head of the Névache valley as the true source of the river.

(W. A. B. C.)

DURAND, ASHER BROWN (1796-1886), American painter and engraver, was born at South Orange, New Jersey, on the 21st of August 1796. He worked with his father, a watch-maker; was apprenticed in 1812 to an engraver named Peter Maverick; and his first work, the head of an old beggar after Waldo, attracted the attention of the artist Trumbull. Durand established his reputation by his engraving of Trumbull's "Declaration of Independence." After 1835, however, he devoted himself chiefly to portrait painting. He painted several of the presidents of the United States and many other men of political and social prominence. In 1840 he visited Europe, where he studied the work of the old masters; after his return he devoted himself almost entirely to landscape. He died at South Orange on the 17th of September 1886. He had been one of the founders of the National Academy of Design in 1826, and was its president in 1845-1861. Durand may be called the father of the Hudson River School. Although there was something hard and unsympathetic about his landscapes, and unnecessary details and trivialities were over-prominent, he was a well-trained craftsman, and his work is marked by sincerity.

DURAND, GUILLAUME (GUILLELMUS DURANDUS), also known as DURANTI or DURANTIS, from the Italian form of *Durandi filius*, as he sometimes signed himself (c. 1230-1296), French canonist and liturgical writer, and bishop of Mende, was born at Puimisson, near Beziers, of a noble family of Languedoc. He studied law at Bologna, especially with Bernardus of Parma, and about 1264 was teaching canon law with success at Modena. Clement IV., his fellow-countryman, called him to the pontifical court as a chaplain and auditor of the palace, and in 1274 he accompanied Clement's successor Gregory X. to the council of Lyons, the constitutions of which he drew up, along with some other prelates. As spiritual and temporal legate of the patrimony of St Peter, he received in 1278, in the name of the pope, the homage of Bologna and of the other cities of Romagna. Martin IV. made him vicar spiritual in 1281, then governor of Romagna and of the March of Ancona (1283). In the midst of the struggles between Gueifs and Ghibellines, Durandus successfully defended the papal territories, both by diplomacy and by arms. Honorius IV. retained him in his offices, and although elected bishop of Mende in 1286, he remained in Italy until 1291. In 1295 he refused the archbishopric of Ravenna, offered him by Boniface VIII., but accepted the task of pacifying again his former provinces of Romagna and the March of Ancona. In 1296 he withdrew to Rome, where he died on the 1st of November.

Durandus' principal work is the *Speculum judiciale*, which was drawn up in 1271, and revised in 1286 and 1291. It is a general explanation of civil, criminal and canonical procedure, and also includes a survey of the subject of contracts. It is a remarkable synthesis of Roman and ecclesiastical law, distinguished by its clarity, its method, and especially its practical sense, in a field in which it was pioneer, and its repute was as great and lasting in the courts as in the schools. It won for Durandus the name of "The Speculator." It was commented upon by Giovanni Andrea (in 1346), and by Baldus, and in 1306 Cardinal Béranger drew up an alphabetical table of its contents (*Inventorium*). There are many manuscripts of the *Speculum*, and several editions, of which the most usual is that of Turin in 1578 in 2 volumes, containing all additions and tables. This edition was reproduced at Frankfurt in 1612 and 1668. The next important work of Durandus is the *Rationales divinarum officiorum*, a liturgical treatise written in Italy before 1286, on the origin and symbolic sense of the Christian ritual. It presents a picture of the liturgy of the 13th century in the West, studied in its various forms, its traditional sources, and its relation to

the church buildings and furniture. With Martène's *De antiquis Ecclesiarum ritibus* it is the main authority on Western liturgies. It has run through various editions, from its first publication in 1459 to the last edition at Naples, 1866. The other important works of Durandus comprise a *Reperitorium juris canonici* (*Breviarium aureum*), a collection of citations from canonists on questions of controversy—often published along with the *Speculum*; a *Commentarius in sacrosanctum Lugdunense concilium* (ed. Fano, 1569), of especial value owing to the share of Durandus in the elaboration of the constitutions of this council (1274), and inserted by Boniface VIII. in the *Sextus*.

A nephew of "The Speculator," also named GUILLAUME DURAND (d. 1330), and also a canonist, was rector of the university of Toulouse and succeeded his uncle as bishop of Mende. He wrote in 1311, in connexion with the council of Vienne, *De modo celebrandi concilii et corruptelis in Ecclesia reformandis*. It attacks the abuses of the Church with extreme sincerity and vigour.

On the elder Durand see V. Leclerc in *Histoire littéraire de la France*, vol. xx. pp. 411-497 (1842); Schulte, *Geschichte der Quellen des canonischen Rechts* (1877); E. Male, *L'Art religieux au XIII^e siècle en France* (1898). On the nephew see B. Hauréau, in *Journal des savants* (1892), 64.

DURAND, GUILLAUME (d. 1334), French scholastic theologian, known also by the Latin form of his name as DURANDUS of St Pourçain (*de Sancto Porciano*), and as *Doctor Resolutissimus*, was born at St Pourçain-sur-Sioule in the Bourbonnois. He entered the Dominican order at Clermont, and in 1313 was made a doctor in Paris, where he taught till Pope John XXII. called him to Avignon as master of the sacred palace, i.e. theological adviser and preacher to the pope. He subsequently became bishop of Limoux (1317), of Le Puy (1318) and of Meaux (1326). He composed a commentary on the Sentences of Peter Lombard, in which, breaking with the realism of St Thomas Aquinas, he anticipated the *terminism* of William of Occam, and gave up the attempt to show that dogmas can be demonstrated by reason. In the question of the beatific vision, arising out of opinions promulgated by John XXII. (q.v.), he sided with Thomas Walleis, Armand de Bellovisu and the doctors of the faculty of theology in Paris against the pope, and composed his *De statu animarum post separationem a corpore*. Mention should also be made of his *De origine jurisdictionum quibus populus regitur, sive de jurisdictione ecclesiastica et de legibus*.

See B. Hauréau, *Histoire de la philosophie scolastique* (2nd ed., Paris, 1872); C. Werner, *Die Scholastik des späteren Mittelalters*, vol. ii. (Vienna, 1883); H. S. Denifle, in *Archiv f. Literatur und Kirchengeschichte*, ii. (1886); U. Chevalier, *Rép. des sources hist. du moyen âge*, s.v. Durand de St Pourçain.

DURANDO, GIACOMO (1807-1894), Italian general and statesman, was born at Mondovì in Piedmont. He was implicated in the revolutionary movements of 1831 and 1832, after which he was obliged to take refuge abroad. He served in the Belgian army, taking part in the war of 1832, and fought in Portugal in 1833. The following year he entered the service of Spain, when he fought in various campaigns, and was promoted colonel in 1838. After a short stay in France he returned to Italy and identified himself with the Liberal movement; he became an active journalist, and founded a newspaper called *L'Opinione* in 1847. In 1848 he was one of those who asked King Charles Albert for the constitution. On the outbreak of the war with Austria he took command of the Lombard volunteers as major-general, and in the campaign of 1849 he was aide-de-camp to the king. He was elected member of the first Piedmontese parliament and was a strenuous supporter of Cavour; during the Crimean campaign he took General La Marmora's place as war minister. In 1855 he was nominated senator, lieutenant-general in 1856, ambassador at Constantinople in 1859, and minister for foreign affairs in the Rattazzi cabinet two years later. He was president of the senate from 1884 to 1887, after which year he retired from the army. He died in 1894.

His brother, GIOVANNI DURANDO (1804-1869), was in early life driven into exile on account of his Liberal opinions. He served in the armies of Belgium, Portugal and Spain, distinguishing

himself in many engagements. Returning to Italy on the outbreak of the revolution of 1848, he was appointed commander of a division of the pontifical forces, and fought against the Austrians in Venetia until the fall of Vicenza, when he returned to Piedmont as major-general. In the campaign of 1849 he commanded the first Piedmontese division; he subsequently served in the Crimea, in the war of 1859, and in that of 1866 as commander of the I. Army Corps. In 1867 he was appointed president of the supreme military and naval tribunal.

DURANGO, a state of northern Mexico, bounded N. by Chihuahua, E. and S.E. by Coahuila, S. by Zacatecas and the territory of Tepic, and W. by Sinaloa. Pop. (1895) 292,549; (1900) 370,294. Area 38,009 sq. m. Durango is a continuation southward of the high, semi-arid plateau of Chihuahua, with the Sierra Madre extending along its western side. The Bolsón de Mapimí covers its N.E. angle, and in the S. there are peculiar volcanic hills, covering about 1000 sq. m. and known as La Breña. The Bolsón de Mapimí, previous to the building of the Mexican Central railway across it, had been considered an uninhabitable desert, but irrigation experiments have demonstrated that its soil is highly fertile and well adapted to the production of cotton and fruit. The rainfall is very light in the eastern part of the state, a succession of years sometimes passing without any precipitation whatever, but in the W. it is sufficient to produce good pasturage and considerable areas of forest. There are no rivers of any magnitude in the state. The largest is the Rio Nazas, which flows eastward into the lakes of the Mapimí depression, and the Mezquital, which flows S.W. through the sierras to the Pacific coast. The climate is generally dry and healthful. Cotton is produced to a limited extent, especially where irrigation is employed, and wheat, Indian corn, tobacco, sugar-cane and grapes are also grown. In the elevated valleys of the sierras stock-raising is successful. The principal industry of Durango, however, is mining, and some of the richest and best known mines of Mexico are found in the state. Besides silver, which has been extensively mined since the first arrival of the Spanish under Francisco de Ibarra (1554-1562), gold, copper, iron, cinnabar, tin, coal and rubies are found. The famous Cerro del Mercado, 2 m. from the city of Durango, is a hill composed in great part of remarkably pure iron ore, and is estimated to contain 300,000,000 tons of that metal. Near it are iron and steel works. The principal mining districts of Durango include San Dimas (on the western slope of the main sierra), Guarisamey, Buenavista, Gavilanes, Guanaceví, Mapimí, El Oro and Indé. In the first-named is the celebrated Candelaria mine, where the ores (largely argentite) assay between \$70 and \$140 a ton, the aggregate output being estimated as over \$100,000,000 before the close of the 19th century. With the exception of silver, the mineral resources of the state have been but slightly developed because of difficult and expensive transportation. The Mexican Central railway crosses the eastern side of the state, and the Mexican International crosses N.E. to S.W. through the state capital on its way to the port of Mazatlán. The history of Durango is similar to that of Chihuahua, the state originally forming part of the province of Nueva Viscaya. The capital is Durango, and among the principal towns are Guanaceví (pop. 6859), El Oro, Nombre de Dios (the first Spanish settlement in the state), San Juan de Guadalupe, San Dimas and Villa Lerdo. These are comparatively small mining towns. Mapimí lies 130 m. N.N.E. of Durango and gives its name to the great arid depression situated still farther north.

DURANGO, sometimes called **CIUDAD DE VICTORIA**, a city of Mexico, capital of the state of Durango, 574 m. N.W. of the federal capital, in lat. 24° 25' N., long. 105° 55' W. Pop. (1900) 31,092. Durango is served by the Mexican International railway. The city stands in the picturesque Guadiana valley formed by easterly spurs of the Sierra Madre, about 6850 ft. above the sea. It has a mild, healthy climate, and is surrounded by a district of considerable fertility. Durango is an important mining and commercial centre, and was for a time one of the most influential towns of northern Mexico. It is the seat of a bishop, and has a handsome cathedral, ten parish churches, a national institute

or college, an episcopal seminary, government buildings, a public library, hospital, penitentiary and bull-ring. The city is provided with urban and suburban tramways, electric light, telephone service and an abundant water-supply, and there are thermal springs in its vicinity. Its manufacturing establishments include reduction works, cotton and woollen mills, glass works, iron foundries, tanneries, flour mills, sugar refineries and tobacco factories. Durango was founded in 1563 by Alonso Pacheco under the direction of Governor Francisco de Ibarra, who named it after a city of his native province in Spain. It was known, however, as Guadiana for a century thereafter, and its first bishops were given that title. It was the capital of Ibarra's new province of Nueva Viscaya, which included Durango and Chihuahua, and continued as such down to their separation in 1823.

DURANI, or **DURRANI**, the dominant race of Afghans, to which the ruling family at Kabul belongs. The Duranis number 100,000 fighting men, and have two branches, the Zirak and the Panjpai. To the former section belong the Popalzai, Alikozai, Barakzai and Achakzai; and to the latter the Nurzai, Alizai, Isakzai, Khokani and Maku tribes. The Saddozai clan of the Popalzai Duranis furnished the first independent shahs of the Durani dynasty (A.D. 1747), the Barakzais furnishing the amirs. The line of the shahs was overthrown in the third generation (A.D. 1834), after a protracted period of anarchy and dissension, which broke out on the death in A.D. 1773 of Ahmad Shah Durani, the founder of Afghan national independence.

Bar Durani is a name sometimes applied to the independent Pathan tribes who inhabit the hill districts south of the Hindu Kush, parts of the Indus valley, the Salt Range, and the range of Suliman, which were first conceded to them by Ahmad Shah. Bar Durani includes the Yusufzai, Utman Khel, Tarkanis, Mohmands, Afridis, Orakzais and Shinwaris, as well as the Pathan tribes of the plains of Peshawar and those of Bangash and Khattak, although the derivation of some of these tribes from the true Durani stock is doubtful.

DURANTE, **FRANCESCO** (1684-1755), Italian composer, was born at Frattamaggiore, in the kingdom of Naples, on the 15th of March 1684. At an early age he entered the Conservatorio dei poveri di Gesù Cristo, at Naples, where he received lessons from Gaetano Greco; later he became a pupil of Alessandro Scarlatti at the Conservatorio di Sant' Onofrio. He is also supposed to have studied under Pasquini and Pitoni in Rome, but no documentary proof of this statement can be given. He is said to have succeeded Scarlatti in 1725 at Sant' Onofrio, and to have remained there until 1742, when he succeeded Porpora as head of the Conservatorio di Santa Maria di Loreto, also at Naples. This post he held for thirteen years, till his death on the 13th of August 1755 at Naples. He was married three times. His fame as a teacher was all but unrivalled, and Jommelli, Paisiello, Pergolesi, Piccini and Vinci were amongst his pupils. A complete collection of Durante's works, consisting all but exclusively of sacred compositions, was presented by Selvaggi, a Neapolitan lover of art, to the Paris library. A catalogue of it may be found in Fétis's *Biographie universelle*. The imperial library of Vienna also preserves a valuable collection of Durante's manuscripts. Two requiems, several masses (one of which, a most original work, is the *Pastoral Mass* for four voices) and the *Lamentations* of the prophet Jeremiah are amongst his most important settings. The fact that Durante never composed for the stage brought him a somewhat exaggerated reputation as a composer of sacred music. Although certainly one of the best church composers of his style and period, he is far inferior to Leo, and seems to have been the founder of the sentimental school of Italian church music. Leo and Scarlatti at their best have a solidity and dignity entirely wanting in Durante, and Alessandro Scarlatti at his worst is frivolous rather than sentimental. This type of music is characteristic of Durante as a man; intellectually uncultured, but sincerely devout. As a teacher he insisted on the strict observance of rules for which he either would not or could not give a reason, differing thus from Alessandro Scarlatti, whose first care was to develop his pupils' talents according to

their own individualities, regarding all rules as subservient to his exquisite sense of musical beauty. Haase rightly protested against Durante's being described as the greatest harmonist of Italy, a title which could be claimed only by Alessandro Scarlatti.

(E. J. D.)

DURÃO, JOSÉ DE SANTA RITA (1720-1784), Brazilian poet, was born near Marianna, in the province of Minas Geraes, in 1720, and died in Lisbon in 1784. He studied at Coimbra, in Portugal, graduated as a doctor of divinity, became a member of the Augustinian order of friars, and obtained a great reputation as a preacher. Having irritated the minister Pombal by his defence of the Jesuits, he retired from Portugal in 1759; and, after being imprisoned in Spain as a spy, found his way to Italy in 1763, where he became acquainted with Alfieri, Pindemonte, Casti and other literary men of the time. On his return to Portugal he delivered the opening address at the university of Coimbra for the year 1777; but soon after retired to the cloisters of a Gratián convent. At the time of his death he taught in the little college belonging to that order in Lisbon. His epic in ten cantos, entitled *Caramuru, poema épico do descobrimento da Bahia*, appeared in Lisbon in 1781, but proved at first a total failure. Its value has gradually been recognized, and it now ranks as one of the best poems in Brazilian literature—remarkable especially for its fine descriptions of scenery and native life in South America. The historic institute of Rio de Janeiro offered a prize to the author of the best essay on the legend of Caramuru; and the successful competitor published a new edition of Durão's poem. There is a French translation which appeared in Paris in 1829.

See Adolfo de Varnhagen, *Épicos Brasileiros* (1845); Pereira da Silva, *Os Varões Ilustres do Brasil* (1858); Woll, *Le Brésil littéraire* (Berlin, 1863); Sotero dos Reis, *Curso de literatura Portuguesa e Brasileira*, vol. iv. (Maranhão, 1868); José Verissimo, *Estados de literatura Brasileira, segunda serie* (Rio, 1901).

DURAZZO (anc. *Epidamnus* and *Dyrrachium*; Albanian, *Durrësi*; Turkish and Slavonic, *Drach*), a seaport and capital of the sanjak of Durazzo, in the vilayet of Iannina, Albania, Turkey. Pop. (1900) about 5000. Durazzo is about 50 m. S. of Scutari, on the Bay of Durazzo, an inlet of the Adriatic Sea. It is the seat of a Roman Catholic archbishop and a Greek metropolitan, but in every respect has greatly declined from its former prosperity. The walls are dilapidated; plane-trees grow on the gigantic ruins of its old Byzantine citadel; and its harbour, once equally commodious and safe, is gradually becoming silted up. The only features worthy of notice are the quay, with its rows of cannon, and the bridge, 750 ft. long, which leads across the marshes stretching along the coast. The chief exports are olive oil—largely manufactured in the district—wheat, oats, barley, pottery and skins.

Epidamnus was founded by a joint colony of Corcyreans and Corinthians towards the close of the 7th century B.C., and from its admirable position and the fertility of the surrounding country soon rose into very considerable importance. The dissolution of its original oligarchical government by the democratic opposition, the consequent quarrel between Corcyra and the oligarchical city of Corinth, and the intervention of Athens on behalf of Corcyra, are usually included among the contributory causes of the Peloponnesian War (431-404 B.C.). In 312 B.C., *Epidamnus* was seized by the Illyrian king Glaucias, and shortly afterwards it passed into the power of the Romans. As the name *Epidamnus* sounded to Roman ears like an evil omen, as though it were derived from the Latin *damnum*, "loss" or "harm," the alternative name of *Dyrrachium*, which the city possibly received from the rugged nature of the adjoining sea-coast, came into general use. Thenceforward *Epidamnus* rose rapidly in importance. It was a favourite point of debarkation for the Roman armies; the great military road known as the *Via Egnatia* led from Dyrrachium to Thessalonica (Salonica); and another highway passed southwards to Butthrotum and Ambracia. Broad swamps rendered the city almost impregnable, and in 48 B.C. it became famous as the place where Pompey made his last successful resistance to Caesar. After the battle of Actium in 31 B.C., Augustus made over Dyrrachium to a

colony of his veterans; it became a *civitas libera* and a great commercial emporium (for coins see Maier, *Numis. Zeitschr.*, 1908). The summit of its prosperity was reached about the end of the 4th century, when it was made the capital of Epirus Nova. Its bishopric, created about A.D. 58, was raised to an archbishopric in 449. In 481 the city was besieged by Theodoric, the king of the East Goths; and in the 10th and 11th centuries it frequently had to defend itself against the Bulgarians. In 1082 it was stormed by the Norman Robert Guiscard, who in the previous year had defeated the Greeks under their emperor Alexius; and in 1185 it fell into the hands of King William of Sicily. Surrendered to Venice in 1202, it afterwards broke loose from the republic and in 1268 passed into the possession of Charles of Anjou. In 1273 it was laid in ruins by an earthquake, but it soon recovered from the disaster, and became an independent duchy under John, the grandson of Charles (1294-1304), and afterwards under Philip of Otranto. In 1333 it was annexed to Achaea, in 1336 to Servia, and in 1394 to Venice. The Turks obtained possession in 1501.

D'URBAN, SIR BENJAMIN (1777-1849), British general and colonial administrator, was born in 1777, and entered the British army in 1793. Promoted lieutenant and captain in 1794 he took part in that year in operations in Holland and Westphalia. In 1795 he served under Sir Ralph Abercromby in San Domingo. He went on half-pay in 1800, joining the Royal Military College, where he remained until 1805, when he went to Hanover with the force under Lord Cathcart. Returning to England he filled various staff offices, and in November 1807 went to Dublin as assistant-quartermaster-general, being transferred successively to Limerick and the Curragh. He joined the army in the Peninsula in 1808, and his marked abilities as a staff officer led to his selection by General (afterwards Viscount) Beresford as quartermaster-general in the reorganization of the Portuguese army. He served throughout the Peninsular War without once going on leave and took part in nine pitched battles and sieges, Busaco, Albuera, Badajoz, Salamanca, Vittoria, the Pyrenees, the Nivelle, the Nive and Toulouse. He was promoted major-general in the Portuguese army and colonel in the British army in 1813, and made a K.C.B. in 1815. He remained in Portugal until 1816, when he was summoned home to take up the posts of colonel of the royal staff corps and deputy quartermaster-general at the Horse Guards. In 1819 he became major-general and in 1837 lieutenant-general. From 1829 he was colonel of the 51st Foot.

Sir Benjamin began his career as colonial administrator in 1820 when he was made governor of Antigua. In 1824 he was transferred to Demerara and Essequibo, then in a disturbed condition owing to a rising among the slaves consequent on the emancipation movement in Great Britain. D'Urban's rule proved successful, and in 1831 he carried out the amalgamation of Berbice with the other counties, the whole forming the colony of British Guiana, of which D'Urban was first governor. The ability with which he had for nine years governed a community of which the white element was largely of Dutch origin led to his appointment as governor of Cape Colony. He assumed office in January 1834, and the four years during which he held that post were of great importance in the history of South Africa. They witnessed the abolition of slavery, the establishment of a legislative council and municipal councils in Cape Colony, the first great Kaffir war and the beginning of the Great Trek. The firmness and justice of his administration won the cordial support of the British and Dutch colonists. The greater part of 1835 was occupied in repelling an unprovoked invasion of the eastern borders of the colony by Xosa Kaffirs. To protect the inhabitants of the eastern province Sir Benjamin extended the boundary of the colony to the Kei river and erected military posts in the district, allowing the Xosa to remain under British supervision. Since his appointment to the Cape there had been a change of ministry in England, and Lord Glenelg had become secretary for the Colonies in the second Melbourne administration. Prejudiced against any extension of British authority a lending a ready ear to a small but influential party in So

Africa, Glenelg adopted the view that the Kaffirs had been the victims of systematic injustice. In a momentous despatch dated the 26th of December 1835 he set forth his views and instructed Sir Benjamin D'Urban to give up the newly annexed territory. At the same time Sir Andries Stockensrom, Bart. (1792-1864), was appointed lieutenant-governor for the eastern provinces of the colony to carry out the policy of the home government, in which the Kaffir chiefs were treated as being on terms of full equality with Europeans. D'Urban in vain warned Glenelg of the disastrous consequences of his decision, the beginning of the long course of vacillation which wrought great harm to South Africa. One result of the new policy was to recreate a state of insecurity, bordering on anarchy, in the eastern province, and this condition was one of the causes of the Great Trek of the Dutch farmers which began in 1836. In various despatches D'Urban justified his position, characterizing the Trek as due to "insecurity of life and property occasioned by the recent measures, inadequate compensation for the loss of the slaves, and despair of obtaining recompense for the ruinous losses by the Kaffir invasion." (See further SOUTH AFRICA: *History*, and CAPE COLONY: *History*.) But Glenelg was not to be convinced by any argument, however cogent, and in a despatch dated the 1st of May 1837 he informed Sir Benjamin that he had been relieved of office. D'Urban, however, remained governor until the arrival of his successor, Sir George Napier, in January 1838.

During his governorship Sir Benjamin endeavoured to help the British settlers at Port Natal, who in 1835 named their town D'Urban (now written Durban) in his honour, but his suggestion that the district should be occupied as a British possession was vetoed by Lord Glenelg. Though no longer in office D'Urban remained in South Africa until April 1846. In 1840 he was made a G.C.B., and in 1842 declined a high military appointment in India offered him by Sir Robert Peel. In January 1847 he took up the command of the troops in Canada, and was still in command at the time of his death at Montreal on the 25th of May 1849.

DURBAN, the principal seaport and largest city of Natal, South Africa, the harbour being known as Port Natal, in 29° 53' 48" S. 31° 42' 49" E. It is 6810 m. from London via Madeira and 7785 via Suez, 823 m. by water E.N.E. from Cape Town and 483 m. by rail S.S.E. of Johannesburg. Pop. (1904) 67,842, of whom 31,302 were whites, 15,631 Asiatics (chiefly British Indians), 18,929 natives and 1980 of mixed race. From its situation and the character of its buildings Durban is one of the finest cities in South Africa. The climate is generally hot and humid, but not unhealthy. Although nearly half the citizens are British, the large number of Indians engaged in every kind of work gives to Durban an oriental aspect possessed by no other town in South Africa. The town is built on the E. side of a bay (Durban Bay or Bay of Natal), the entrance to which is marked on the west by a bold cliff, the Bluff, whose summit is 105 ft. above the sea, and on the east by a low sandy spit called the Point. The city extends from the Point along the side of the bay and also for some distance along the coast of the Indian Ocean, and stretches inland to a range of low hills called the Berea.

The chief streets, Smith, West and Pine, are in the lower town, parallel to one another and to the bay. They contain the principal public buildings, warehouses and shops, the Berea being a residential quarter. Of the three streets mentioned, West Street, the central thoroughfare, is the busiest. In its centre are the public gardens, in which is a handsome block of buildings in the Renaissance style, built in 1906-1908 at a cost of over £300,000, containing the town hall, municipal offices, public library, museum and art gallery. The art gallery holds many pictures of the modern British school. Opposite the municipal buildings are the post and telegraph offices, a fine edifice (built 1881-1885) with a clock tower 164 ft. high. The post office formerly served as town hall. In Pine Street is the Central railway station and the spacious Market House. Among the churches St Cyprian's (Anglican), in Smith Street, has a hand-

some chancel. The Roman Catholic cathedral is a fine building in the Gothic style. The town possesses several parks, one, the Victoria Park, facing the Indian Ocean. This part of the town is laid out with pleasure grounds and esplanades. The botanic gardens, in the upper town, contain a very fine collection of flowering shrubs and semi-tropical trees. Above the gardens is the observatory. There is a fine statue of Queen Victoria by Hamo Thornycroft, R.A., in the public gardens, and a memorial to Vasco da Gama at the Point. There is an extensive system of electric trams. Another favourite means of conveyance is by rickshaw, the runners being Zulus. The town is governed by a municipality which owns the water and electric lighting supplies and the tramway system. The sanitary services are excellent. The main water-supply is the Umhlaas river, which enters the ocean 10 m. S. of the port. The municipal valuation, which is based on capital value, was £9,494,400 in 1909, the rate, including water, being 2½d. in the £.

The entrance to the harbour was obstructed by a formidable sand bar, but as the result of dredging operations there is now a minimum depth of water at the opening of the channel into the bay of over 30 ft., with a maximum depth of over 33 ft. The width of the passage between the Bluff and the Point is 450 ft. From the foot of the Bluff a breakwater extends over 2000 ft. into the sea, and parallel to it, starting from the Point, is a pier. The harbour is landlocked, and covers 7½ sq. m. Much of this area is shoal water, but the accommodation available was largely increased by the removal during 1904-1908 of 24,000,000 tons of sand. The port has over 3 m. of wharfage. It possesses a floating dock capable of lifting a vessel of 8500 tons, a floating workshop, a patent slip for small craft, hydraulic cranes, &c. The minimum depth alongside the quays at low water is 23 ft., increased at places to over 30 ft. The principal wharves, where passengers, mails and general merchandise are landed, are along the Point. On the opposite side at the foot of the Bluff land has been reclaimed and extensive accommodation provided for ships coaling. At Congella at the N.E. end of the harbour some 65 acres of land were reclaimed during 1905-1906, and wharves built for the handling of heavy and bulky goods such as timber and corrugated iron. Here also are situated warehouses and railway works. The port is defended by batteries armed with modern heavy guns. The trade of the port is almost coextensive with the foreign trade of Natal.

History.—The early history of Durban is closely identified with that of the colony of Natal. The first permanent settlement by white men in the bay was made by Englishmen in 1824, when Lieutenant F. G. Farewell, R. N., and about ten companions went thither from Cape Town in the brig "Salisbury," from which circumstance the island in the bay gets its name. In 1835 a township was laid out and the colonists gave it the name of D'Urban, in honour of Sir Benjamin D'Urban, then governor of Cape Colony. At this time a mission church was built on the heights overlooking the bay by Captain Allen Gardner, R. N., who named the hill Berea in gratitude for support received from the settlers, whom he found "more noble than those of" Zululand—Dingaan having refused to allow the captain to start a mission among his people. From December 1838 to December 1850 a small British military force was stationed at the port. On its recall the little settlement was taken possession of by Dutch emigrants from the Cape, who had defeated the Zulu king Dingaan, and who the year before at the upper end of the bay had formed an encampment, *Kangela* (look-out), the present Congella. The Dutch claimed independence, and on the block-house at Durban hoisted the flag of the "Republic of Natalia." In 1842, however, a British military force reoccupied Durban, and on the 15th of July of that year a treaty was signed in which the Dutch recognized British sovereignty (see further NATAL: *History*). From that date Durban, though not the seat of government, became the principal town in Natal. In 1850 there were 500 white inhabitants, and in 1853 the town was granted municipal government. The first mayor was Mr George Cato (c. 1810-1893), one of the earliest settlers in Natal. In 1860 a railway from the Point to the town, the first railway in South Africa, was opened. The

discovery of the gold-mines on the Rand greatly increased the importance of the port, and renewed efforts were made to remove the bar which obstructed the entrance to the bay. The Harbour Board, which was formed in 1881 and ceased to exist in 1893, effected, under the guidance of Mr Harry Escombe, enormous improvements in the port—on which the prosperity of Durban is dependent. But it was not until 1904 that the fairway was deepened sufficiently to allow mail steamers of the largest class to enter the harbour. The growth of the port as illustrated by customs receipts is shown in the increase from £250,000 in 1880 to £981,000 in 1904. In 1846 the customs revenue was returned at £3510.

See *Durban: Fifty Years' Municipal History*, compiled for the corporation by W. F. M. Henderson, Asst. Town Clerk (Durban, 1904); G. Russell, *History of Old Durban* [to 1860] (Durban, 1899).

DURBAR, a term in India for a court or levee, from the Persian *darbar*. A *darbar* may be either a council for administering affairs of state, or a purely ceremonial gathering. In the former sense the native rulers of India in the past, like the amir of Afghanistan to-day, received visitors and conducted business in *darbar*. A *darbar* is the executive council of a native state. In the latter sense the word has come to be applied to great ceremonial gatherings like Lord Lytton's *darbar* for the proclamation of the queen empress in India in 1877, or the Delhi *darbar* of 1903.

DÜREN, a town of Germany, in the Prussian Rhine province, on the right bank of the Roer, 10 m. E. from Aix-la-Chapelle on the main line of railway to Cologne. Pop. (1905) 29,270. It has two Protestant and six Roman Catholic churches, among the latter the Gothic St Annakirche, said to contain a portion of the head of the saint, to the shrine of which frequent pilgrimages are made. There are several high-grade schools, monuments to the emperor William I., Bismarck and Moltke, and, in the town-hall, a collection of antiquities. It is the seat of considerable manufactures, notably cloth, paper, flax-spinning, carpet, artificial wool, sugar, iron wares and needles.

Düren derives its name, not, as was at one time believed, from the *Marcodurum* of the Ubii, mentioned in Tacitus, but from the *Dura* or *Duria*, assemblies held by the Carolingians in the 8th century. It received civic rights early in the 13th century. Hypothecated by the emperor Frederick II. to Count William of Jülich, it became incorporated with the duchy of that name, and with it passed to Prussia in 1816.

DURENE (1·2·4·5 tetramethyl benzene) $C_6H_2(CH_3)_4$, a hydrocarbon which has been recognized as a constituent of coal-tar. It may be prepared by the action of methyl iodide on bromseudocumene or 4·6 dibrom metaxylene, in the presence of sodium; or by the action of methyl chloride on toluene, in the presence of anhydrous aluminium chloride. It crystallizes in plates, having a camphor-like smell, melting at 79·80° C. and boiling at 189·101° C. It is easily soluble in alcohol, ether and benzene, and sublimes slowly at ordinary temperature. On oxidation with chromic acid mixture, it is completely decomposed into carbon dioxide and acetic acid; nitric acid oxidizes it to durylic and cumidic acids [$C_6H_2(CH_3)_2(COOH)_2$].

DÜRER, ALBRECHT (1471–1528), German painter, draughtsman and engraver, was born at Nuremberg on the 21st of May 1471. His family was not of Nuremberg descent, but came from the village of Eyta in Hungary. The name, however, is German, and the family device—an open door—points to an original form Thürer, meaning a maker of doors or carpenter. Albrecht Dürer the elder was a goldsmith by trade, and settled soon after the middle of the 15th century in Nuremberg. He served as assistant under a master-goldsmith of the city, Hieronymus Holper, and in 1468 married his master's daughter Barbara, the bridegroom being forty and the bride fifteen years of age. They had eighteen children, of whom Albrecht was the second. The elder Dürer was an esteemed craftsman and pious citizen, sometimes, as was natural, straitened in means by the pressure of his numerous progeny. His famous son writes with reverence and affection of both parents, and has left a touching narrative of their death-bed hours. He painted the portrait of his father twice, first in 1490, next in 1497. The former of these is in the

Uffizi at Florence; of the latter, four versions exist, that in the National Gallery (formerly in the Ashburton-Northampton collections) having the best claim to originality.

The young Albrecht was his father's favourite son. "My father," he writes, "took special delight in me. Seeing that I was industrious in working and learning, he put me to school; and when I had learned to read and write, he took me home from school and taught me the goldsmith's trade." By and by the boy found himself drawn by preference from goldsmith's work to painting; his father, after some hesitation on the score of the time already spent in learning the former trade, gave way and apprenticed him for three years, at the age of fifteen and a half, to the principal painter of the town, Michael Wolgemut. Wolgemut furnishes a complete type of the German painter of that age. At the head of a large shop with many assistants, his business was to turn out, generally for a small price, devotional pieces commissioned by mercantile corporations or private persons to decorate their chapels in the churches—the preference being usually for scenes of the Passion, or for tortures and martyrdoms of the saints. In such work the painters of Upper Germany at this time, working in the spirit of the late Gothic style just before the dawn of the Renaissance, show considerable technical attainments, with a love of quaint costumes and rich draperies crumpled in complicated angular folds, some feeling for romance in landscape backgrounds, none at all for clearness or balance in composition, and in the attitudes and expressions of their overcrowded figures a degree of grotesqueness and exaggeration amounting often to undesigned caricature. There were also produced in the workshop of Wolgemut, as in that of other artist-craftsmen of his town, a great number of woodcuts for book illustration. We cannot with certainty identify any of these as being by the 'prentice hand of the young Dürer. Authentic drawings done by him in boyhood, however, exist, including one in silver-point of his own likeness at the age of thirteen in the Albertina at Vienna, and others of two or three years later in the print room at Berlin, at the British Museum and at Bremen.

In the school of Wolgemut Dürer learned much, by his own account, but suffered not a little from the roughness of his companions. At the end of his apprenticeship in 1490 he entered upon the usual course of travels—the *Wanderjahre*—of a German youth. Their direction we cannot retrace with certainty. There had been no one at Nuremberg skilled enough in the art of metal-engraving to teach it him to much purpose, and it had at one time been his father's intention to apprentice him to Martin Schongauer of Colmar, the most refined and accomplished German painter-engraver of his time. But after travelling two years in various parts of Germany, where we are unable to follow him, the young Dürer arrived at Colmar in 1492, only to find that Schongauer had died the previous year. He was received kindly by three brothers of the deceased master established there, and afterwards, still in 1492, by a fourth brother at Basel. Under them he evidently had some practice both in metal-engraving and in furnishing designs for the woodcutter. There is in the museum at Basel a wood-block of St Jerome executed by him and elaborately signed on the back with his name. This was used in an edition of Jerome's letters printed in the same city in the same year, 1492. Some critics also maintain that his hand is to be recognized in several series of small blocks done about the same date or somewhat later for Bergmann and other printers of Basel, some of them being illustrations to Terence (which were never printed), some to the romance of the *Ritter vom Turm*, and some to the *Narrenschiff* of Sebastian Brandt. But the prevailing opinion is against this conjecture, and sees in these designs the work not of a strenuous student and searcher such as Dürer was, but of a ripper and more facile hand working in a spirit of settled routine. Whether the young Dürer's stay at Basel was long or short, or whether, as has been supposed, he travelled from there into the Low Countries, it is certain that in the early part of 1494 he was working at Strassburg, and returned to his home at Nuremberg immediately after Whitsuntide in that year. O' works certainly executed by him during his years of travel there are extant, besides the Basel wood-block, only a much-injure

portrait of himself, very finely dressed and in the first bloom of his admirable manly beauty, dated 1493 and originally painted on vellum but since transferred to canvas (this is the portrait of the Felix Goldschmid collection); a miniature painting on vellum at Vienna (a small figure of the Child-Christ); and some half a dozen drawings, of which the most important are the characteristic pen portrait of himself at Erlangen, with a Holy Family on the reverse much in the manner of Schongauer; another Holy Family in nearly the same style at Berlin; a study from the female nude in the Bonnat collection; a man and woman on horseback in Berlin; a man on horseback, and an executioner about to behead a young man, at the British Museum, &c. These drawings all show Dürer intent above all things on the sternly accurate delineation of ungeneralized individual forms by means of strongly accented outline and shadings curved, somewhat like the shadings of Martin Schongauer's engravings, so as to follow their modellings and roundness.

Within a few weeks of his return (July 7th, 1494) Dürer was married, according to an arrangement apparently made between the parents during his absence, to Agnes Frey, the daughter of a well-to-do merchant of the city. By the autumn of the same year, probably feeling the incompleteness of the artistic training that could be obtained north of the Alps, he must have taken advantage of some opportunity, we know not what, to make an excursion of some months to Italy, leaving his lately married wife at Nuremberg. The evidences of this travel (which are really incontestable, though a small minority of critics still decline to admit them) consist of (1) some fine drawings, three of them dated 1494 and others undated, but plainly of the same time, in which Dürer has copied, or rather boldly translated into his own Gothic and German style, two famous engravings by Mantegna, a number of the "Tarocchi" prints of single figures which pass erroneously under that master's name, and one by yet another minor master of the North-Italian school; with another drawing dated 1495 and plainly copied from a lost original by Antonio Pollaiuolo, and yet another of an infant Christ copied in 1495 from Lorenzo di Credi, from whom also Dürer took a motive for the composition of one of his earliest Madonnas; (2) several landscape drawings done in the passes of Tirol and the Trentino, which technically will not fit in with any other period of his work, and furnish a clear record of his having crossed the Alps about this date; (3) two or three drawings of the costumes of Venetian courtesans, which he could not have made anywhere but in Venice itself, and one of which is used in his great woodcut Apocalypse series of 1498; (4) a general preoccupation which he shows for some years from this date with the problems of the female nude, treated in a manner for which Italy only could have set him the example; and (5) the clear implication contained in a letter written from Venice in 1506 that he had been there already eleven years before; when things, he says, pleased him much which at the time of writing please him no more. Some time in 1495 Dürer must have returned from this first Italian journey to his home in Nuremberg, where he seems to have lived, without further change or removal, in the active practice of his art for the next ten years.

The hour when Dürer, the typical artist of the German nation, attained maturity was one of the most pregnant in the history of his race. It was the crisis, in northern Europe, of the transition between the middle ages and our own. The awakening of Germany at the Renaissance was not, like the awakening of Italy a generation or two earlier, a movement almost exclusively intellectual. It was indeed from Italy that the races of the north caught the impulse of intellectual freedom, the spirit of science and curiosity, the eager retrospect towards the classic past; but joined with these in Germany was a moral impulse which was her own, a craving after truth and right, a rebellion against spiritual tyranny and corruption—the Renaissance was big in the north, as it was not in the south, with a Reformation to come. The art of printing had been invented in good time to help and hasten the new movement of men's minds. Nor was it by the diffusion of written ideas only that the new art supplied

the means of popular enlightenment. Along with word-printing, or indeed in advance of it, there had sprung into use another kind of printing, picture-printing, or what is commonly called engraving. Just as books were the means of multiplying, cheapening and disseminating ideas, so engravings on copper or wood were the means of multiplying, cheapening and disseminating images which gave vividness to the ideas, or served, for those ignorant of letters, in their stead. Technically one of these arts, that of line-engraving on copper, sprang from the craft of the goldsmith and metal-chaser; while that of wood-engraving sprang from the craft of the printers of pattern-blocks and playing cards. The engraver on metal habitually cut his own designs, and between the arts of the goldsmith and the painter there had always been a close alliance; both being habitually exercised by persons of the same family and sometimes by one and the same person; so that there was no lack of hands ready-trained for the new craft which required of the man who practised it that he should design like a painter and cut metal like a goldsmith. Designs intended to be cut on wood, on the other hand, were usually drawn by the artist on the block and handed over for cutting to a class of workmen—*Formschneider* or *Briefmaler*—especially devoted to that industry. Both kinds of engraving soon came to be in great demand. Independently of the illustration of written or printed books, for which purpose woodcuts were almost exclusively used, separate engravings or sets of engravings in both kinds were produced, the more finely wrought and more expensive, appealing especially to the more educated classes, on copper, the bolder, simpler and cheaper on wood; and both kinds found a ready sale at all the markets, fairs and church festivals of the land. Subjects of popular devotion predominated. Figures of the Virgin and Child, of the apostles and evangelists, the fathers of the Church, the saints and martyrs, with illustrations of sacred history and the Apocalypse, were supplied in endless repetition to satisfy the cravings of a pious and simple-minded people. But to these were quickly added subjects of allegory, of classical learning, of witchcraft and superstition and of daily life; scenes of the parlour and the cloister, of the shop, the field, the market and the camp; and lastly portraits of famous men, with scenes of court life and princely pageant and ceremony. Thus the new art became a mirror of almost all the life and thoughts of the age. The genius of Albrecht Dürer cannot be rightly estimated without taking into account the position which the arts of engraving on metal and on wood thus held in the culture of this time. He was indeed professionally and in the first place a painter; but throughout his career a great, and on the whole the most successful, part of his industry was devoted to drawing on the block for the woodcutter or engraving with his own hand on copper. The town of Nuremberg in Franconia, in the age of Dürer's early manhood, was a favourable home for the growth and exercise of his powers. Of the free imperial cities of central Germany, none had a greater historic fame or a more settled and patriotic government. None was more the favourite of the emperors, nor the seat of a more active and flourishing commerce. Nuremberg was the chief mart for the merchandise that came to central Europe from the east through Venice and over the passes of Tirol. She held not only a close commercial intercourse, but also a close intellectual intercourse, with Italy. Without being so forward as the rival city of Augsburg to embrace the architectural fashions of the Italian renaissance—continuing, indeed, to be profoundly imbued with the old and homely German burgher spirit, and to wear, in a degree which time has not very much impaired even yet, the quaintness of the old German civic aspect—she had imported before the close of the 15th century a fair share of the new learning of Italy, and numbered among her citizens distinguished humanists like Hartmann Schedel, Sebald Schreier, Willibald Pirckheimer and Conrad Celtes. From associates like these Dürer could imbibe the spirit of Renaissance culture and research; but the external aspects and artistic traditions which surrounded him were purely Gothic, and he had to work out for himself the style and vernacular language fit to express what was in him. During the first seven

or eight years of his settled life in his native city from 1495, he betrays a conflict of artistic tendencies as well as no small sense of spiritual strain and strife. His finest work in this period was that which he provided for the woodcutter. After some half-dozen miscellaneous single prints—"Samson and the Lion," the "Annunciation," the "Ten Thousand Martyrs," the "Knight and Men-at-arms," the "Men's Bath," &c.—he undertook and by 1498 completed his famous series of sixteen great designs for the Apocalypse. The northern mind had long dwelt with eagerness on these phantasmagoric mysteries of things to come, and among the earliest block-books printed in Germany is an edition of the Apocalypse with rude figures. Founding himself to some extent on the traditional motives, Dürer conceived and carried out a set of designs in which the qualities of the German late Gothic style, its rugged strength and restless vehemence, its love of gnarled forms, writhing actions and agitated lines, are fused by the fire of the young master's spirit into vital combination with something of the majestic power and classic severity which he had seen and admired in the works of Mantegna. Of a little later date, and of almost as fine a quality, are the first seven of a large series of woodcuts known as the Great Passion; and a little later again (probably after 1500), a series of eleven subjects of the Holy Family and of saints singly or in groups; then, towards 1504-1505, come the first seventeen of a set illustrating the life of the Virgin: neither these nor the Great Passion were published till several years later.

In copper-engraving Dürer was at the same time diligently training himself to develop the methods practised by Martin Schongauer and earlier masters into one suitable for his own self-expression. He attempted no subjects at all commensurate with those of his great woodcuts, but contented himself for the most part with Madonnas, single figures of scripture or of the saints, some nude mythologies of a kind wholly new in northern art and founded upon the impressions received in Italy, and groups, sometimes bordering on the satirical, of humble folk and peasants. In the earliest of the Madonnas, the "Virgin with the Dragon-fly" (1495-1496), Dürer has thrown something of his own rugged energy into a design of the traditional Schongauer type. In examples of a few years later, like the "Virgin with the Monkey," the design of Mother and Child clearly betrays the influence of Italy and specifically of Lorenzo di Credi. The subjects of the "Prodigal Son" and "St Jerome in the Wilderness" he on the other hand treats in an almost purely northern spirit. In the nudes of the next four or five years, which included a "St Sebastian," the so-called "Four Witches" (1497), the "Dream" or "Temptation," the "Rape of Amytome," and the "Jealousy" or "Great Hercules," Venetian, Paduan and Florentine memories are found, in the treatment of the human form, competing somewhat uncomfortably with his own inherited Gothic and northern instincts. In these early engravings the highly-wrought landscape backgrounds, whenever they occur, are generally the most satisfying feature. This feature reaches a climax of beauty and elaboration in the large print of "St Eustace and the Stag," while the figures and animals remain still somewhat cramped and immature. In the first three or four years of the 16th century, we find Dürer in his graver-work still contending with the problems of the nude, but now with added power, though by methods which in different subjects contrast curiously with one another. Thus the "Nemesis," belonging probably to 1503, is a marvelously wrought piece of quite unflinching realism in the rendering of a common type of mature, muscular, unshapely German womanhood. The conception and attributes of the figure are taken, as has lately been recognized, from a description in the "Manto" of Politian: the goddess, to whose shoulders are appended a pair of huge wings, stands like Fortune on a revolving ball, holding the emblems of the cup and bridle, and below her feet is spread a rich landscape of hill and valley. In the "Adam and Eve" of the next year, we find Dürer treating the human form in an entirely opposite manner; constructing it, that is, on principles of abstract geometrical proportion. The Venetian painter-

etcher, Jacopo de Barbari, whom Dürer had already, it would seem, met in Venice in 1494-1495, and by the example of whose engravings he had already been much influenced, came to settle for a while in Nuremberg in 1500. He was conversant to some extent with the new sciences of perspective, anatomy and proportion, which had been making their way for years past in Italy, and from him it is likely that Dürer received the impulse to similar studies and speculations. At any rate a whole series of extant drawings enables us to trace the German gradually working out his own ideas of a canon of human proportion in the composition of his famous engraving of "Adam and Eve" (1504); which at first, as a drawing in the British Museum proves, had been intended to be an Apollo and Diana conceived on lines somewhat similar to one of Barbari's. The drama of the subject has in this instance not interested him at all, but only the forms and designs of the figures, the realization of the quality of flesh surfaces by the subtlest use of the graving-tool known to him, and the rendering, by methods of which he had become the greatest of all masters, of the richness and intricacy of the forest background. Two or three other technical masterpieces of the engraver's art, the "Coat-of-Arms with the Skull," the "Nativity," with its exquisite background of ruined buildings, the "Little Horse" and the "Great Horse," both of 1505, complete the list of the master's chief productions in this kind before he started in the last-named year for a second visit to Italy.

The pictures of this earlier Nuremberg period are not many in number and not very admirable. Dürer's powers of hand and eye are already extraordinary and in their way almost unparalleled, but they are often applied to the too insistent, too glittering, too emphatic rendering of particular details and individual forms, without due regard to subordination or the harmony of the whole. Among the earliest seem to be two examples of a method practised in Italy especially by the school of Mantegna, but almost without precedent in Germany, that of tempera-painting on linen. One of these is the portrait of Frederick the Wise of Saxony, formerly in the Hamilton collection and now at Berlin; the second, much disfigured by restoration, is the Dresden altarpiece with a Madonna and Child in the middle and St Anthony and Sebastian in the wings. A mythology reminiscent of Italy is the "Hercules and the Stymphalian Birds" in the Germanic Museum at Nuremberg, founded directly upon the "Hercules and Centaur Nessus" of Pollaiuolo, now at New Haven, Connecticut, U.S.A. Of portraits, besides that of his father already mentioned as done in 1497, there is his own of 1498 at Madrid. Two totally dissimilar portraits of young women, both existing in duplicate examples (one pair at Augsburg and Frankfurt, the other pair in the collections of M. Hengel in Paris and Baron Speck von Sternburg at Lützenschema, for each of which has been claimed the name Fürlegerin, that is, a member of the Fürleger family at Nuremberg), belong to nearly the same time. Other panel portraits of the period are three small ones of members of the Tucher family at Weimar and Cassel, and the striking, restlessly elaborated half-length of Oswald Krell at Munich. In some devotional pictures of the time Dürer seems to have been much helped by pupils, as in the two different compositions of the Maries weeping over the body of Christ preserved respectively at Munich and Nuremberg. In an altarpiece at Ober St Veit and in the scattered wings of the Jabach altarpiece severally preserved at Munich, Frankfurt and Cologne, the workmanship seems to be exclusively that of journeymen working from his drawings. The period is closed, so far as paintings are concerned, by two examples of far higher value than those above named, that is to say the Paumgartner altarpiece at Munich, with its romantically attractive composition of the Nativity with angels and donors in the central panel, and the fine armed figures of St George and St Eustace (lately freed from the over-paintings which disfigured them) on the wings; and the happily conceived and harmoniously finished "Adoration of the Magi" in the Uffizi at Florence.

In the autumn of 1505 Dürer journeyed for a second time to Venice, and stayed there until the spring of 1507. The occasion of this journey has been erroneously stated by Vasari. Dürer's

engravings, both on copper and wood, had by this time attained great popularity both north and south of the Alps, and had begun to be copied by various hands, among others by the celebrated Marcantonio of Bologna, then in his youth. According to Vasari, Marcantonio, in copying Dürer's series of the Little Passion on wood, had imitated the original monogram, and Dürer, indignant at this fraud, set out for Italy in order to protect his rights, and having lodged a complaint against Marcantonio before the signory of Venice, carried his point so far that Marcantonio was forbidden in future to add the monogram of Dürer to copies taken after his works. This account will not bear examination. Chronological and other proofs show that if such a suit was fought at all, it must have been in connexion with another set of Dürer's woodcuts, the first seventeen of the Life of the Virgin. Dürer himself, a number of whose familiar letters written from Venice to his friend Pirkheimer at Nuremberg are preserved, makes no mention of anything of the kind. Nevertheless some such grievance may possibly have been among the causes which determined his journey. Other causes, of which we have explicit record, were an outbreak of sickness at Nuremberg; Dürer's desire, which in fact was realized, of finding a good market for the proceeds of his art; and the prospect, also realized, of a commission for an important picture from the German community settled at Venice, who had lately caused an exchange and warehouse—the *Fondaco de' Tedeschi*—to be built on the Grand Canal, and who were now desirous to dedicate a picture in the church of St Bartholomew. The picture painted by Dürer on this commission was the "Adoration of the Virgin," better known as the "Feast of Rose Garlands"; it was subsequently acquired by the emperor Rudolf II., and carried as a thing beyond price upon men's shoulders to Vienna; it now exists in a greatly injured state in the monastery of Strahow at Prague. It shows the pope and emperor, with a lute-playing angel between them, kneeling to right and left of the enthroned Virgin and Child, who crown them with rose garlands, with a multitude of other kneeling saints disposed with free symmetry in the background, and farther in the background portraits of the donor and the painter, and a flutter of wreath-carrying cherubs in the air. Of all Dürer's works, it is the one in which he most deliberately rivalled the combined splendour and playfulness of certain phases of Italian art. The Venetian painters assured him, he says, that they had never seen finer colours. They were doubtless too courteous to add that fine colours do not make fine colouring. Even in its present ruined state, it is apparent that in spite of the masterly treatment of particular passages, such as the robe of the pope, Dürer still lacked a true sense of harmony and tone-relations, and that the effect of his work must have been restless and garish beside that of a master like the aged Bellini. That veteran showed the German visitor the most generous courtesy, and Dürer still speaks of him as the best in painting ("*der best im gemell*") in spite of his advanced years. A similar festal intention in design and colouring, with similar mastery in passages and even less sense of harmonious relations in the whole, is apparent in a second important picture painted by Dürer at Venice, "The Virgin and Child with the Goldfinch," formerly in the collection of Lord Lothian and now at Berlin. A "Christ disputing with the Doctors" of the same period, in the Barberini Gallery at Rome, is recorded to have cost the painter only five days' labour, and is an unsatisfying and ill-composed congeries of heads and hands, both of such strenuous character and individuality as here and there to pass into caricature. The most satisfying of Dürer's paintings done in Venice are the admirable portrait of a young man at Hampton Court (the same sitter reappears in the "Feast of Rose Garlands"), and two small pieces, one the head of a brown Italian girl modelled and painted with real breadth and simplicity, formerly in the collection of Mr Reginald Cholmondeley and now at Berlin, and the small and very striking little "Christ Crucified" with the figure relieved against the night sky, which is preserved in the Dresden Gallery and has served as model and inspiration to numberless later treatments of the theme. An interesting, rather fantastic, portrait of a blonde girl wearing a wide cap,

now in the Berlin museum, is dated 1507 and may have been done in the early months of that year at Venice. It is possible, though not certain, that to this date also belongs the famous portrait of himself at Munich bearing a false signature and date, 1500; in this it has been lately shown that the artist modified his own lineaments according to a preconceived scheme of facial proportion, so that it must be taken as an ideal rather than a literal presentment of himself to posterity as he appeared in the flower of his early middle age. From Venice Dürer kept up a continuous correspondence, which has been published, with his bosom friend Pirkheimer at Nuremberg. He tells of the high position he holds among the Venetians; of the jealousy shown him by some of the meaner sort of native artists; of the honour and wealth in which he might live if he would consent to abandon home for Italy; of the northern winter, and how he knows that after his return it will set him shivering for the south. Yet he resisted all seductions and was in Nuremberg again before the summer of 1507. First, it seems, he had made an excursion to Bologna, having intended to take Mantua on the way, in order to do homage to the old age of that Italian master, Andrea Mantegna, from whose work he had himself in youth learned the most. But the death of Mantegna prevented his purpose.

From the spring of 1507 until the summer of 1500, Dürer was again a settled resident in his native town. Except the brilliant existences of Raphael at Rome and of Rubens at Antwerp and Madrid, the annals of art present the spectacle of few more honoured or more fortunate careers. His reputation had spread all over Europe. From Flanders to Rome his distinction was acknowledged, and artists of less invention, among them some of the foremost on both sides of the Alps, were not ashamed to borrow from his work this or that striking combination or expressive type. He was on terms of friendship or friendly communication with all the first masters of the age, and Raphael held himself honoured in exchanging drawings with Dürer. In his own country, all orders of men, from the emperor Maximilian down, delighted to honour him; and he was the familiar companion of chosen spirits among the statesmen, humanists, and reformers of the new age. The burgher life of even Nuremberg, the noblest German city, seems narrow, quaint and harsh beside the grace and opulence and poetical surroundings of Italian life in the same and the preceding generation. The great cities of Flanders also, with their world-wide commerce and long-established eminence in the arts, presented aspects of more splendid civic pomp and luxury. But among its native surroundings the career of Dürer stands out with an aspect of ideal elevation and decorum which is its own. His temper and life seem to have been remarkably free from all that was jarring, jealous and fretful; unless, indeed, we are to accept as true the account of his wife's character which represents her as having been no fit mate for him, but an incorrigible shrew and skinflint. The name of Agnes Dürer was for centuries used to point a moral, and among the unworthy wives of great men the wife of Dürer became almost as notorious as the wife of Socrates. The source of the traditions to her discredit is to be found in a letter written a few years after Dürer's death by his life-long intimate, Willibald Pirkheimer, who accuses her of having plagued her husband to death by her meanness, made him overwork himself for money's sake, and given his latter days no peace. No doubt there must have been some kind of foundation for Pirkheimer's charges; and it is to be noted that neither in Dürer's early correspondence with this intimate friend, nor anywhere in his journals, does he use any expressions of tenderness or affection for his wife, only speaking of her as his housemate and of her helping in the sale of his prints, &c. That he took her with him on his journey to the Netherlands shows at any rate that there can have been no acute estrangement. And it is fair to remember in her defence that Pirkheimer when he denounced her was old, gouty and peevish, and that the immediate occasion of his outbreak against his friend's widow was a fit of anger because she had not let him have a pair of antlers—a household ornament much prized in those days—to which he fancied himself entitled out of the property left by

Dürer. We have evidence that after her husband's death Agnes Dürer behaved with generosity to his brothers.

The thirteen or fourteen years of Dürer's life between his return from Venice and his journey to the Netherlands (spring 1507-midsummer 1520) can best be divided according to the classes of work with which, during successive divisions of the period, he was principally occupied. The first five years, 1507-1511, are pre-eminently the painting years of his life. In them, working with infinite preliminary pains, as a vast number of extant drawings and studies testify, he produced what have been accounted his four capital works in painting, besides several others of minor importance. The first is the "Adam and Eve" dated 1507, in which both attitudes and proportions are as carefully calculated, though on a somewhat different scheme, as in the engraving of 1504. Two versions of the picture exist, one in Florence at the Pitti palace, the other, which is generally allowed to be the original, at Madrid. To 1508 belongs the life-sized "Virgin with the Iris," a piece remarkable for the fine romantic invention of its background, but plainly showing the hand of an assistant, perhaps Hans Baldung, in its execution: the best version is in the Cook collection at Richmond, an inferior one in the Rudolphinum at Prague. In 1508 Dürer returned to a subject which he had already treated in an early woodcut, the "Massacre of the Ten Thousand Martyrs of Nicomedia." The picture, painted for the elector Frederick of Saxony, is now in the Imperial Gallery at Vienna; the overcrowded canvas (into which Dürer has again introduced his own portrait as a spectator alongside of the elector) is full of striking and animated detail, but fails to make any great impression on the whole, and does not do justice to the improved sense of breadth and balance in design, of clearness and dignity in composition, which the master had undoubtedly brought back with him from his second visit to Italy. In 1509 followed the "Assumption of the Virgin" with the Apostles gathered about her tomb, a rich altarpiece with figures of saints and portraits of the donor and his wife in the folding wings, executed for Jacob Heller, a merchant of Frankfurt, in 1509. This altarpiece was afterwards replaced at Frankfurt (all except the portraits of the donors, which remained behind) by a copy, while the original was transported to Munich, where it perished by fire in 1674. The copy, together with the many careful and highly finished preparatory studies for the heads, limbs and draperies which have been preserved, shows that this must have been the one of Dürer's pictures in which he best combined the broader vision and simpler habits of design which had impressed him in the works of Italian art with his own inherited and ingrained love of unflinchingly grasped fact and rugged, accentuated character. In 1511 was completed another famous painting, multitudinous in the number of its figures though of very moderate dimensions, the "Adoration of the Trinity by all the Saints," a subject commissioned for a chapel dedicated to All Saints in an almshouse for decayed tradesmen at Nuremberg, and now at the Imperial Gallery at Vienna. Nothing can exceed the fulness and variety of invention, or the searching force and precision of detail in this picture; nor does it leave so much to desire as several of the master's other paintings in point of colour-harmony and pleasurable general effect.

In the meantime Dürer had added a few to the number of his line-engravings and had completed the two woodcut series of the Great Passion, begun about 1498-1499, and the Life of the Virgin. The new subjects compared with the old show some falling off in dramatic stress and intensity of expression, but on the other hand a marked gain in largeness of design and clearness of composition. In 1511 these two works were brought out for the first time, and the Apocalypse series in a second edition; and for the next three years, 1511-1514, engraving both on wood and copper, but especially the latter, took the first place among Dürer's activities. Besides such fine single woodcuts as the "Mass of St Gregory," the "St Christopher," the "St Jerome," and two Holy Families of 1511, Dürer published in the same year the most numerous and popularly conceived of all his woodcut series, that known from the dimensions of its thirty-seven subjects as the "Little Passion" on wood; and in the next year, 1512, a set of fifteen small

copper-engravings on the same theme, the "Little Passion" on copper. Both of these must represent the labour of several preceding years: one or two of the "Little Passion" plates, dating back as far as 1507, prove that this series at least had been as long as five years in his mind. In thus repeating over and over on wood and copper nearly the same incidents of the Passion, or again in rehandling them in yet another medium, as in the highly finished series of drawings known as the "Green Passion" in the Albertina at Vienna, Dürer shows an inexhaustible variety of dramatic and graphic invention, and is never betrayed into repeating an identical action or motive.

In 1513 and 1514 appeared the three most famous of Dürer's works in copper-engraving, "The Knight and Death" (or simply "The Knight," as he himself calls it, 1513), the "Melancholia" and the "St Jerome in his Study" (both 1514). These are the masterpieces of the greatest mind which ever expressed itself in this form of art. Like other masterpieces, they suggest much more than they clearly express, and endless meanings have been, rightly or wrongly, read into them by posterity. Taken together as a group, they have been supposed to be three out of an uncompleted series designed to illustrate the four "temperaments" and complexions of men. Again, more reasonably, they have been taken as types severally of the moral, the intellectual and the theological virtues. The idea at the bottom of the "Knight and Death" seems to be a combination of the Christian knight of Erasmus's *Enchiridion militis Christiani* with the type, traditional in medieval imagery, of the pilgrim on his way through the world. The imaginative force of the presentation, coming from a man of Dürer's powers, is intense; but what consciously occupied him most may well have been the problem how to draw accurately the proportions and action of a horse in motion. This problem he here solves for the first time, with the help of an Italian example: at least his design so closely repeats that of Leonardo da Vinci's famous and early destroyed equestrian statue of Francesco Sforza that we must certainly suppose him to have seen either the model itself or such a drawing of it as is still preserved by Leonardo's own hand. The face of the rider seems to recall that of the statue of Bartolommeo Colleoni at Venice; for the armour Dürer had recourse to an old drawing of his own, signed and dated in 1498. The "Melancholia," numbered "1," as though intended to be the first of a series, with its brooding winged genius sitting dejectedly amidst a litter of scientific instruments and symbols, is hard to interpret in detail, but impossible not to recognize in general terms as an embodiment of the spirit of intellectual research (the student's "temperament" was supposed to be one with the melancholic), resting sadly from its labours in a mood of lassitude and defeat. Comparatively cheerful beside these two is the remaining subject of the student saint reading in his chamber, with his dog and domestic lion resting near him, and a marvellous play of varied surface and chequered light on the floor and ceiling of his apartment and on all the objects which it contains. Besides these three masterpieces of line-engraving, the same years, 1512-1515, found Dürer occupied with his most important experiments in etching, both in dry-point ("The Holy Family and Saints" and the "St Jerome in the Wilderness") and with the acid bath. At the same time he was more taken up than ever, as is proved by the contents of a sketch-book at Dresden, with mathematical and anatomical studies on the proportions and structure of the human frame. A quite different kind of study, that of the postures of wrestlers in action, is illustrated by a little-known series of drawings, still of the same period, at Vienna. Almost the only well-authenticated painting of the time is a "Virgin and Child" in the Imperial Museum at Vienna. The portraits of the emperors Charles the Great and Sigismund (1512), in their present state at any rate, can hardly be recognized as being by the master's hand. An interval of five years separates the Vienna "Madonna" from the two fine heads of the apostles Philip and James in the Uffizi at Florence, the pair of boys' heads painted in tempera on linen in the Bibliothèque Nationale at Paris, the "Madonna with the Pink" at Augsburg, and the portrait of Wolgemut at Munich, all of 1516. Among

engravings of the same time are three Madonnas, the apostles Thomas and Paul, a bagpiper and two peasants dancing, and three or four experiments in etching on plates of iron and zinc. In wood-engraving his energies were almost entirely given to bearing a part—which modern research has proved to have been not nearly so large as was traditionally supposed—in the great decorative schemes commanded by the Emperor Max in his own honour, and devised and carried out by a whole corps of men of letters and artists: namely, the Triumphal Gate and the Triumphal March or Procession. A third and smaller commemorative design, the Triumphal Car, originally designed to form part of the second but in the end issued separately, was entirely Dürer's own work. A far more successful and attractive effort of his genius in the same service is to be found in the marginal decorations done by him in pen for the emperor's prayer-book. This unequalled treasure of German art and invention has in later times been broken up, the part executed by Dürer being preserved at Munich, the later sheets, which were decorated by other hands, having been transported to Besançon. Dürer's designs, drawn with the pen in pale lilac, pink and green, show an inexhaustible richness of invention and an airy freedom and playfulness of hand beyond what could be surmised from the sternness of those studies which he made direct from life and nature. They range from subjects of the homeliest and most mirthful realism to others serious and devout, and from literal or almost literal transcripts of natural form to the most whimsically abstract combinations of linear pattern and tendril and flourish.

All these undertakings for his imperial friend and patron were stopped by the emperor's death in 1519. A portrait-drawing by the master done at Augsburg a few months previously, one of his finest works, served him as the basis both of a commemorative picture and a woodcut. Other paintings of this and the succeeding year we may seek for in vain; but in line engravings we have four more Madonnas, two St Christophers, one or two more peasant subjects, the well-known St Anthony with the view of Nuremberg in the background, and the smaller of the two portraits of the Cardinal-Elector of Mainz; and in wood-engraving several fine heraldic pieces, including the arms of Nuremberg.

In the summer of 1520 the desire of Dürer to secure from Maximilian's successors a continuance of the patronage and privileges granted during his lifetime, together with an outbreak of sickness in Nuremberg, gave occasion to the master's fourth and last journey from home. Together with his wife and her maid he set out in July for the Netherlands in order to be present at the coronation of the young emperor Charles V., and if possible to conciliate the good graces of the all-powerful regent Margaret. In the latter part of his aim Dürer was but partially successful. His diary of his travels enables us to follow his movements almost day by day. He journeyed by the Rhine, Cologne, and thence by road to Antwerp, where he was handsomely received, and lived in whatever society was most distinguished, including that of Erasmus of Rotterdam. Besides his written notes, interesting traces of his travels exist in the shape of the scattered leaves of a sketch-book filled with delicate drawings in silver-point, chiefly views of places and studies of portrait and costume. Several of his finest portrait-drawings in chalk or charcoal, including those of his brother artists Lucas Van Leyden and Bernard Van Orley, as well as one of two fine portrait paintings of men, belong to the period of this journey. So does a magnificent drawing of a head of a nonagenarian with a flowing beard who sat to him at Antwerp, together with a picture from the same head in the character of St Jerome; the drawing is now at Vienna, the picture at Lisbon. Dürer's interest and curiosity, both artistic and personal, were evidently stimulated by his travels in the highest degree. Besides going to Aachen for the coronation, he made excursions down the Rhine from Cologne to Nijmegen, and back overland by 's Hertogenbosch; to Brussels; to Bruges and Ghent; and to Zealand with the object of seeing a natural curiosity, a whale reported ashore. The vivid account of this last expedition given in his diary contrasts

with the usual dry entries of interviews and disbursements. A still more striking contrast is the passionate outburst of sympathy and indignation with which, in the same diary, he comments on the supposed kidnapping of Luther by foul play on his return from the diet of Worms. Without being one of those who in his city took an avowed part against the old ecclesiastical system, and probably without seeing clearly within the religious ferment of the time was tending—without, that is, being properly speaking a Reformer—Dürer in his art and his thoughts was the incarnation of those qualities of the German character and conscience which resulted in the Reformation; and, personally, with the fathers of the Reformation he lived in the warmest sympathy.

On the 12th of July 1521 Dürer reached home again. Drawings of this and the immediately following years prove that on his return his mind was full of schemes for religious pictures. For a great group of the Madonna surrounded with saints there are extant two varying sketches of the whole composition and a number of finished studies for individual heads and figures. Less abundant, but still sufficient to prove the artist's intention, are the preliminary studies to a picture of the Crucifixion. There exist also fine drawings for a "Lamentation over the body of Christ," an "Adoration of the Kings," and a "March to Calvary"; of the last-named composition, besides the beautiful and elaborate pen-and-ink drawing at Florence, three still more highly-wrought versions in green monochrome exist; whether any of them are certainly by the artist's own hand is matter of debate. But no religious paintings on the grand scale, corresponding to these drawings of 1521-1524, were ever carried out; perhaps partly because of the declining state of the artist's health, but more because of the degree to which he allowed his time and thoughts to be absorbed in the preparation of his theoretical works on geometry and perspective, proportion and fortification. Like Leonardo, but with much less than Leonardo's genius for scientific speculation and divination, Dürer was a confirmed reasoner and theorist on the laws of nature and natural appearances. He himself attached great importance to his studies in this kind; his learned friends expected him to give their results to the world; which accordingly, though having little natural gift or felicity in verbal expression, he laboured strenuously to do. The consequence was that in the last and ripest years of his life he produced as an artist comparatively little. In painting there is the famous portrait of Hieronymus Holtzschuher at Berlin, in which the personality and general aspect of the sitter assert themselves with surprising power. This and the Antwerp head of Jerome are perhaps the most striking examples of Dürer's power of forcing into subordination to a general impression such a multiplicity of insistent detail as would have smothered any weaker conception than his. No other hand could have ventured to render the hair and beard of a sitter, as it was the habit of this inveterate linearist to do, not by indication of masses, but by means of an infinity of single lines swept, with a miraculous certainty and fineness of touch, in the richest and most intricate of decorative curves. To the same period belong a pleasing but somewhat weak "Madonna and Child" at Florence; and finally, still in the same year 1526, the two famous panels at Munich embodying the only one of the great religious conceptions of the master's later years which he lived to finish. These are the two pairs of saints, St John with St Peter in front and St Paul with St Mark in the background. The John and Paul are conceived and executed really in the great style, with a commanding nobility and force alike in the character of the heads, the attitudes, and the sweep of draperies; they represent the highest achievement of early German art in painting. In copper-engraving Dürer's work during the same years was confined entirely to portraits, those of the cardinal-electors of Mainz ("The Great Cardinal"), Frederick the Wise, elector of Saxony, Willibald Pirckheimer, Melanchthon and Erasmus. To the tale of his woodcuts, besides a few illustrations to his book on measurements (that is, geometry and perspective), and on fortification, he only added one Holy Family and one portrait, that of his friend Eoban Hesse. Of his theoretical books, he only succeeded

in getting two finished and produced during his lifetime, that on geometry and perspective or measurement, to use his own title—which was published at Nuremberg in 1525, and that on fortification, published in 1527; the work on human proportions was brought out shortly after his death in 1528. His labours, whether artistic or theoretic, had for some time been carried on in the face of failing health. In the canals of the Low Countries he had caught a fever, of which he never shook off the effects. We have the evidence of this in his own written words, as well as in a sketch which he drew to indicate the seat of his suffering to some physician with whom he was in correspondence, and again in the record of his physical aspect which is preserved by a portrait engraved on wood just after his death, from a drawing made no doubt not long before: in this portrait we see his shoulders already bent, the features somewhat gaunt, the old pride of the abundant locks shorn away. The end came on the night of the 6th of April 1528, so suddenly that there was no time to call his dearest friends to his bedside. He was buried in a vault which belonged to his wife's family, but was afterwards disturbed, in the cemetery of St John at Nuremberg. An appropriate *Requiescat* is contained in the words of Luther, in a letter written to their common friend Eoban Hesse:—"As for Dürer, assuredly affection bids us mourn for one who was the best of men, yet you may well hold him happy that he has made so good an end, and that Christ has taken him from the midst of this time of trouble and from greater troubles in store, lest he, that deserved to behold nothing but the best, should be compelled to behold the worst. Therefore may he rest in peace with his fathers. Amen."

The principal extant paintings of Dürer, with the places where they are to be found, have been mentioned above. Of his drawings, which for students are the most vitally interesting part of his works, the richest collections are in the Albertina at Vienna, the Berlin Museum and the British Museum. The Louvre also possesses some good examples, and many others are dispersed in various public collections, as in the Musée Bonnat at Bayonne, at Munich, Hamburg, Bremen, Frankfurt, Dresden, Basel, Milan, Florence and Oxford, as well as in private hands all over Europe.

The principal editions of Dürer's theoretical writings are these—

Geometry and Perspective.—*Underweysung der Messung mit dem Zirckel und Richtscheit, in Linien, Ebenen und gansen Corporen* (Nuremberg, 1525, 1533, 1538). A Latin translation of the same, with a long title (Paris, Weichel, 1532) and another ed. in 1535. Again in Latin, with the title *Institutionum geometricarum libri quatuor* (Arnhem, 1602).

Fortification.—*Eiliche Underricht zu Befestigung der Stett, Schloss und Flechen* (Nuremberg, 1527), and other editions in 1530, 1538 and 1603 (Arnhem). A Latin translation, with the title *De arvis, arcibus, castellisque mansuetis ac condendis* (Paris, Weichel, 1535). See the article FORTIFICATION.

Human Proportion.—*Hierinnen sind begriffen vier Bücher von menschlicher Proportion* (Nuremberg, 1528, and Arnhem, 1603). Latin translation: *De symetria partium in rectis figuris humanorum corporum libri in latinum conversi, de variate figurarum, &c. libri ii.* (Nuremberg, 1528, 1532 and 1534); (Paris, 1535, 1537, 1557). French translation (Paris, 1557, Arnhem, 1613, 1614). Italian translation (Venice, 1591, 1594); Portuguese translation (1599); Dutch translation (Arnhem, 1622, 1662).

The private literary remains of Dürer, his diary, letters, &c., were first published, partially in Von Murr's *Journal zur Kunstgeschichte* (Nuremberg, 1782-1787); afterwards in Campe's *Reliquien von A. Dürer* (Nuremberg, 1827); again, edited by Thausing, in the *Quellenschriften für Kunstgeschichte und Kunsttechnik* (Vienna, 1872), but most completely in Lange and Fuhse's *Dürers schriftlicher Nachlass* (Halle, 1893); W. M. Conway's *Literary Remains of A. Dürer* (London, 1889) contains extensive transcripts from the MSS. in the British Museum.

The principal remaining literature of the subject will be found in the following books and treatises—Johann Neudörfer, *Schreib- und Rechenmeister zu Nürnberg, Nachrichten über Künstler und Werkleuten daselbst* (Nuremberg, 1547); republished in the *Vienna Quellenschrift* (1875); C. Scheurl, *Vita Antonii Kressen* (1515, reprinted in the collection of Pirkerheimer's works, Frankfurt, 1610); Wimpfeling, *Epitome rerum Germanicarum*, ch. 68 (Strassburg, 1565); Joachim von Sandrart, *Deutsche Academie* (Nuremberg, 1675); Doppelmayr, *Historische Nachricht von den nürnbergischen Mathematikern und Künstlern* (Nuremberg, 1730); C. G. von Murr, *Journal zur Kunstgeschichte*, as above; Adam Bartsch, *Le Peintre-Graveur*,

vol. vii. (Vienna, 1808); J. P. Passavant, *Le Peintre-Graveur*, vol. iii. (Leipzig, 1822); J. F. Roth, *Leben Albrecht Dürers* (Leipzig, 1791); Heller, *Das Leben und die Werke Albrecht Dürers*, vol. ii. (Bamberg, 1827-1831); B. Hausmann, *Dürers Kupferstiche, Radirungen, Holzschnitte und Zeichnungen* (Hanover, 1861); R. von Retzbach, *Dürers Kupferstiche und Holzschnitte* (Munich, 1876); M. Thausing, *Dürer, Geschichte seines Lebens und seiner Kunst* (Leipzig, 1876, 2nd ed., 1884). English translation (from the 1st ed. by F. A. Eaton, London, 1882); W. Schmidt in *Dohme's Kunst und Künstler des Mittelalters und der Neuzeit* (Leipzig, 1877); *Œuvre de Albert Dürer reproduit et publié par Amand-Durand, texte par Georges Duplessis* (Paris, 1877); C. Ephrussi, *A. Dürer et ses dessins* (Paris, 1882); F. Lippmann, *Zeichnungen von A. Dürer in Nachbildungen* (5 vols. Berlin, 1883-1905); A. Springer, *Albrecht Dürer* (Berlin, 1892); D. Burckhardt, *Dürers Aufenthalt in Basel, 1492-1494* (Munich, 1892); G. von Terey, *A. Dürers venezianischer Aufenthalt, 1494-1495* (Strassburg, 1892); S. R. Koehler, *A Chronological Catalogue of the Engravings, Dry Points and Etchings of A. Dürer* (New York, 1894); L. Cust, *A. Dürer, a Study of his Life and Works* (London, 1897); Dürer Society's Publications (10 vols., 1898-1907), edited by C. Dodgson and S. M. Peartree; H. Knackfuss, *Dürer* (Bielefeld and Leipzig, 6th ed., 1899); English translation, 1900; B. Haendcke, *Die Chronologie der Landschaften A. Dürers* (Strassburg, 1899); M. Zucker, *Albrecht Dürer* (Halle, 1899-1900); L. Justi, *Konstruirte Figuren und Köpfe unter den Werken Albrecht Dürers* (Leipzig, 1902); A. Pelzer, *A. Dürer und Friedrich II. von der Pfalz* (Strassburg, 1905); H. Wölfflin, *Die Kunst A. Dürers* (Munich, 1905); W. Weisbach, *Der junge Dürer* (Leipzig, 1906); V. Scherer, *A. Dürer (Klassiker der Kunst, iv.)*, (2nd ed., Stuttgart, 1906).

Apart from books, a large and important amount of the literature on Dürer is contained in articles scattered through the leading art periodicals of Germany, such as the *Jahrbücher* of the Berlin and Vienna museums, *Repertorium für Kunstwissenschaft*, *Zeitschrift für bildende Kunst*, &c. A comprehensive survey of this literature is afforded by Prof. H. W. Singer's *Versuch einer Dürer-Bibliographie* (Strassburg, 1903); articles published more recently will be found completely enumerated in A. Jelinek's *Internationale Bibliographie der Kunstwissenschaft* (Berlin). (S. C.)

DURESS (through Fr. from Lat. *duritia*, harshness, severity, *durus*, hard), in law, constraint or compulsion. *Duress* may be of two kinds. It may consist in personal restraint or actual violence or imprisonment; or it may be by threats (*per minas*), as where a person is compelled to an act by threats of immediate death or grievous bodily harm. *Duress*, in certain cases, may be pleaded as a defence of an act which would otherwise be a crime, but the extent to which the plea of *duress* can be urged is unascertained. At common law a contract entered into under *duress* is voidable at the option of one of the parties. See COERCION, CONTRACT.

D'URFEY, THOMAS (1653-1723), better known as Tom d'Urfey, English song-writer and dramatist, belonged to a Huguenot family settled at Exeter, where he was born in 1653. Honoré d'Urfé, the author of *Astrée*, was his uncle. His first play, *The Siege of Memphis, or the Ambitious Queen*, a bombastic rhymed tragedy, was produced at the Theatre Royal in 1676. He was much more successful with his comedies, which had brisk, complicated plots carried out in lively dialogue. He had a light touch for fitting words on current topics to popular airs; moreover, many of his songs were set to music by his friends Dr John Blow, Henry Purcell and Thomas Farmer. Many of these songs were introduced into his plays. Addison in the *Guardian* (No. 67) relates that he remembered to have seen Charles II. leaning on Tom d'Urfey's shoulder and humming a song with him. Even William III. liked to hear him sing his songs, and as a strong Tory he was sure of the favour of Princess Anne, who is said to have given Tom fifty guineas for a song on the Electress Sophia, the next heir in succession to the crown. "The crown's far too weighty, for shoulders of eighty," said d'Urfey, with an indirect compliment to the princess, "So Providence kept her away,—poor old Dowager Sophy." Pope, in an amusing letter to Henry Cromwell (*Works*, ed. Elwin and Courthope, vi. 91) describes him as "the only poet of tolerable reputation in this country." In spite of the success of his numerous comedies he was poor in his old age. But his gaiety and invincible good humour had made him friends in the craft, and by the influence of Addison his *Fond Husband, or The Plotting Sisters* was revived for d'Urfey's benefit at Drury Lane on the 15th of June 1713. This performance, for which Pope wrote a prologue full of rather faint praise, seems to have eased the

poet's difficulties. He died on the 26th of February 1723, and was buried in St James's Church, Piccadilly.

Collections of his songs with the music appeared during his lifetime, the most complete being the 1719-1720 edition (6 vols.) of *Wit and Mirth; or Pills to Purge Melancholy*. The best known of the twenty-nine pieces of his which actually found their way to the stage were *Love for Money; or The Boarding School* (Theatre Royal, 1691), *The Marriage-Hater Match'd* (1692), and *The Comical History of Don Quixote*, in three parts (1694, 1694 and 1696), which earned the especial censure of Jeremy Collier. In his burlesque opera, *Wonders in the Sun; or the Kingdom of the Birds* (1706, music by G. B. Draghi), the actors were dressed as parrots, crows, &c.

DURFORT, a village of south-western France, formerly in the province of Guénone, now in the department of Tarn-et-Garonne, 18 m. N.W. of Montauban by road. It was at one time the seat of a feudal lordship which gave its name to a family distinguished in French and English history. Though earlier lords are known, the pedigree of the family is only clearly traceable to Arnaud de Durfort (*f.* 1305), who acquired the fief of Duras by his marriage with a niece of Pope Clement V. His descendant, Gaillard de Durfort, having embraced the side of the king of England, went to London in 1453, and was made governor of Calais and a knight of the Garter.

The greatness of the family dates, however, from the 17th century. Guy Aldonce (1605-1665), marquis de Duras and comte de Rozan, had, by his wife Elizabeth de la Tour d'Auvergne, sister of Marshal Turenne, six sons, three of whom played a distinguished part. The eldest, Jacques Henri (1625-1704), was governor of Franche Comté in 1674 and was created a marshal of France for his share in the conquest of that province (1675). The second, Guy Aldonce (1630-1702), comte de Lorges and duc de Quintin (known as the duc de Lorges), became a marshal of France in 1676, commanded the army in Germany from 1690 to 1695, and captured Heidelberg in 1693. The sixth son, Louis (1640?-1709), marquis de Blanquefort, came to England in the suite of James, duke of York, in 1663, and was naturalized in the same year. On the 10th of January 1672-1673 he was raised to the English peerage as Baron Duras of Holdenby, his title being derived from an estate in Northamptonshire bought from the duke of York, and in 1676 he married Mary, daughter and elder co-heiress of Sir George Sondes, created in that year Baron Throwley, Viscount Sondes and earl of Feversham. On the death of his father-in-law (16th of April 1677), Duras succeeded to his titles under a special remainder. He was appointed by Charles II. successively to the command of the third and second troops of Horse Guards, was sent abroad on several important diplomatic missions, and became master of the horse (1679) and lord chamberlain to the queen (1680). In 1682 he was appointed a lord of the bed-chamber, and was present at the king's deathbed reconciliation with the Roman Church. Under James II. Feversham became a member of the privy council, and in 1685 was given the chief command against the rebels under Monmouth (*q.v.*), in which he mainly distinguished himself by his cruelty to the vanquished. He was rewarded with a knighthood of the Garter and the colonelcy of the first troop of Life Guards, and in 1686 he was appointed to the command of the army assembled by King James on Blackheath to overawe the people. On James's flight, Feversham succeeded in making his peace with William, on the intercession of the queen dowager, at whose instance he received the mastership of the Royal Hospital of St Catherine near the Tower (1698). He died without issue on the 8th of April 1709. [See G. E. C. (ockayne), *Complete Peerage*, and art. in *Dict. Nat. Biog.*]

Jean Baptiste (1684-1770), duc de Duras, son of Jacques Henri, was also a marshal of France. In 1733 he resigned the dukedom of Duras to his son, Emmanuel Félicité, himself receiving the brevet title of duc de Durfort. Emmanuel Félicité (1715-1789), duc de Duras, took part in all the wars of Louis XV. and was made a marshal of France in 1775. His grandson, Amédée Bretagne Malo (1771-1838), duc de Duras, is mainly known as the husband of Claire Louise Rose Bonne de Coëtnempren de Kersaint (1778-1828), daughter of Armand Guy Simon de Coëtnempren Kersaint (*q.v.*), who, as duchesse de Duras, presided

over a once celebrated salon and wrote several novels once widely read.

The family of Durfort is represented in France now by the branch of Durfort-Civrac, dating from the 16th century. Jean Laurent (1746-1826), marquis de Civrac, married his cousin, the daughter of the duc de Lorges; his son, Guy Emeric Anne (1767-1837), duc de Civrac, became afterwards duc de Lorges. Henri, marquis de Durfort-Civrac (1812-1884), was a well-known politician, and was several times elected vice-president of the chamber of deputies.

DURGA, or **DEVI** (Sanskrit for inaccessible), in Hindu mythology, the wife of Siva (*q.v.*) and daughter of Himavat (the Himalayas). She has many names and many characters. As Durga (so named from having slain the demon Durga) she is warlike and ferocious, and to her in this form are offered bloody sacrifices, and such ceremonies as the Durgapuja and Chhurrak-puga are held in her honour (see KALI). The chief festival in Bengal—sometimes termed the Christmas of Bengal—celebrates the goddess's birth in the sixth Hindu month (parts of September and October). Durga is pictured, in spite of her fierce nature, with a gentle face. She has ten arms, holding each a weapon, while her attendant lions and giants are grouped on each side.

DURHAM, JOHN GEORGE LAMBTON, 1ST EARL OF (1702-1840), English statesman, son of William Henry Lambton of Lambton Castle, Durham, was born in London on the 12th of April 1702. His mother was Anne Barbara Villiers, daughter of the 4th earl of Jersey. Lambton was only five years old when by his father's death at Pisa (1707) he succeeded to large estates in the north of England which had been in the uninterrupted possession of his family since the 12th century. In 1805 he went to Eton, and in 1809 obtained a commission in the 10th Hussars. In 1812, while still a minor, he made a runaway match with Henrietta, natural daughter of Lord Cholmondeley, whom he married at Gretna Green, and who died in 1815. In 1813 he was elected to the House of Commons as member for the county of Durham. Whig principles of a pronounced type were traditional in Lambton's family. His grandfather, General John Lambton, had refused a peerage in 1793 out of loyalty to Fox, and his father was not only one of Pitt's keenest opponents, but was chairman of "The Friends of the People" and author of that society's address to the nation in 1792. Lambton adhered to this tradition, and soon developed opinions of an extremely Radical type, which he fearlessly put forward in parliament and in the country with marked ability. His maiden speech in the House of Commons was directed against the foreign policy of Lord Liverpool's government, who had sanctioned, and helped to enforce, the annexation of Norway by Sweden. In 1815 he vehemently opposed the corn tax, and in general began to take a prominent part in opposition to the Tories. In 1816 he made the acquaintance of Lafayette in Paris, and narrowly escaped arrest for alleged complicity in his escape. In 1817 he began to speak on every opportunity in favour of parliamentary reform.

His political position was strengthened by his marriage in December 1816 to Louisa Elizabeth, eldest daughter of Lord Grey, and as early as 1818 he was taken into the political confidence of his father-in-law and other leaders of the Whigs in matters touching the leadership and policy of the party. But from the first Lambton belonged to the avowedly Radical wing of the party, with whose aims Grey had little sympathy; and when he gave notice of a resolution in 1819 in favour of shortening the duration of parliaments, and of a wide extension of the franchise, he found himself discountenanced by old Whigs like Grey, Holland and Fitzwilliam. Having warmly espoused the cause of Queen Caroline, Lambton ably seconded Lord Tavistock's resolution in February 1821 censuring the government for their conduct towards the queen; and in April he made his first great speech in the House of Commons on parliamentary reform, when he proposed a scheme for the extension of the suffrage to all holders of property, the division of the country into electoral districts and the disfranchisement of rotten boroughs. He was now one of the recognized leaders of

the advanced Liberals, forming a connecting link between the aristocratic Whig leaders and the irresponsible and often violent politicians of the great towns. His opposition to those members of his party who in 1825 were prepared for compromise on the question of Catholic emancipation led to his first conflict with Brougham, with whom he had been on terms of close friendship. While supporting the candidature of his brother-in-law, Lord Howick, for Northumberland in the elections of 1826, Lambton fought a duel with T. W. Beaumont, the Tory candidate, but without bloodshed on either side. Unlike his father-in-law, Lambton supported the ministry of Canning, though he had some grounds for personal grievance against the new prime minister, and after Canning's death that of Lord Goderich. On the advice of the latter Lambton was raised to the peerage in 1828 with the title of Baron Durham. Owing to his Liberal principles Lord Durham was on terms of friendship with the duke of Sussex, and also with Prince Leopold of Saxe-Coburg, who sought his advice in the difficult crisis in 1829 when he was offered the throne of Greece, and who, after he became king of the Belgians as Leopold I., continued to correspond with Durham as a trusted confidant; the same confidential relations also existed between Durham and Leopold's sister, the duchess of Kent, and her daughter, afterwards Queen Victoria.

In November 1830 when Grey became prime minister in succession to the duke of Wellington, Lord Durham entered the cabinet as lord privy seal. Parliamentary reform was in the forefront of the new government's policy, and with this question no statesman except Lord Grey himself was more closely identified than Durham. To ardent reformers in the country the presence in the cabinet of "Radical Jack," the name by which Lambton had been popularly known in the north of England, was a pledge that thorough-going reform would not be shirked by the Whigs, now in office for the first time for twenty years. And it was to his son-in-law that Lord Grey confided the task of preparing a scheme to serve as the basis of the proposed legislation. Full justice has not generally been done to the leading part played by Lord Durham in preparing the great Reform Act. He was the chief author of the proposals which, after being defeated in 1831, became law with little alteration in 1832. He was chairman of the famous committee of four, which met at his house in Cleveland Row and drew up the scheme submitted by the government to parliament. His colleagues, who were appointed rather as his assistants than as his equals, were Lord John Russell, Sir James Graham and Lord Duncannon; and it was Durham who selected Lord John Russell, not then in the cabinet, to introduce the bill in the House of Commons; a selection that was hotly opposed by Brougham, whose later vindictive animosity against Durham is to be traced to his having been passed over in the selection of the committee of four. Durham was present with Grey at an audience of the king which led to the sudden dissolution of parliament in March 1831; and when the deadlock between the two Houses occurred over the second Reform Bill, he was the most eager in pressing on the prime minister the necessity for a creation of peers to overcome the resistance of the house of Lords.

After the passing of the Reform Act, Durham, whose health was bad and who had suffered the loss of two of his children, accepted a special and difficult diplomatic mission to Russia, which he carried out with much tact and ability, though without accomplishing its main purpose. On his return he resigned office in March 1833, ostensibly for reasons of health, but in reality owing to his disagreement with the government's Irish policy as conducted by Lord Stanley; in the same month he was created earl of Durham and Viscount Lambton. His advanced opinions, in the assertion of which he was too little disposed to consider the convictions of others, gradually alienated the more moderate of his late colleagues, such as Melbourne and Palmerston, and even Lord Grey often found his son-in-law intractable and self-assertive; but the growing hostility of the treacherous Brougham was mainly due to Durham's undoubted popularity in the country, where he was regarded by many,

including J. S. Mill, as Grey's probable successor in the leadership of the Liberal party. Durham was at this time courted by the youthful Disraeli, who, when Melbourne became prime minister in succession to Grey in 1834, declared that the Whigs could not exist as a party without Lord Durham. Brougham's animosity became undisguised at the great banquet given to Lord Grey at Edinburgh in September 1834, where he made a venomous attack on Durham, repeated shortly afterwards at Salisbury, and anonymously in the *Edinburgh Review*. On the other hand the strength of Durham's position in the country was shown on the occasion of his visit to Glasgow in October to receive the freedom of the city, when a concourse of more than a hundred thousand persons assembled to hear him speak at Glasgow Green, and where he replied to Brougham's attacks at a great banquet held in his honour. Brougham had over-reached himself; and although Durham was no favourite with William IV. the king's disgust with the lord chancellor was one of the principal reasons for his summary dismissal of the Whig ministry in 1834. When Melbourne returned to power after Peel's short administration, Durham's radicalism and impatient temper excluded him from the cabinet; and again in 1837, on his return from an appointment as ambassador extraordinary in St Petersburg (1835-1837), when there was some idea of his joining the ministry, Lord John Russell wrote: "Everybody, after the experience we have had, must doubt whether there can be peace or harmony in a cabinet of which Lord Durham is a member."

In July 1837 he resisted the entreaty of Lord Melbourne that he should undertake the government of Canada, where the condition of affairs had become alarming; but a few months later, giving way to the urgent insistence of the prime minister who promised him "the firmest and most unflinching support" of the government, he accepted the post of governor-general and lord high commissioner, with the almost dictatorial powers conferred on him by an act passed in February 1838, by which the constitution of Lower Canada was suspended for two years. Having secured the services of Charles Buller (*q.v.*) as first secretary, and having with more doubtful wisdom appointed Thomas Turton and Edward Gibbon Wakefield (*q.v.*) to be his unofficial assistants, Durham arrived at Quebec on the 28th of May 1838. Papineau's rebellion had been quelled, but the French Canadians were sullen, the attitude of the United States equivocal, and the general situation dangerous, especially in the Lower Province where government was practically in abeyance. Durham at once issued a conciliatory proclamation. His next step was to dismiss the executive council of his predecessor and to appoint a new one consisting of men uncommitted to any existing faction, a step much criticized at home but generally commended on the spot. On the 28th of June, the day of Queen Victoria's coronation, he issued a proclamation of amnesty, from the benefit of which eight persons only of those who had taken part in the rebellion were excepted; while an accompanying ordinance provided for the transference of these eight excepted persons from Montreal to Bermuda, where they were to be imprisoned without trial. Papineau and fifteen other fugitives were forbidden on pain of death to return to Canada. In a letter of congratulation to the queen, Durham took credit for the clemency of his policy towards the rebels, and it was defended on the same ground by Charles Buller and by public opinion in the colony.

In England, however, as soon as these proceedings became known, Brougham seized the opportunity for venting his malice against both Durham and the ministry. He had already raised objections to the appointment of Turton and Wakefield; he now attacked the ordinance in the House of Lords, challenging the legality of the clause transporting prisoners to Bermuda, where Durham had no jurisdiction. Melbourne and his colleagues, with the honourable exception of Lord John Russell, made little effort to defend the public servant to whom they had promised "the most unflinching support"; and, although both the prime minister and the colonial secretary were first fully informed of the governor-general's proceedings had hastened to assure him of their "entire approval," three weeks later, cowed by Brougham's

malignant invective, they disallowed the ordinance, and carried an Act of Indemnity the terms of which were insulting to Durham. The latter immediately resigned; but before returning to England he put himself in the wrong by issuing a proclamation in which he not only justified his own conduct in detail, but made public complaint of his grievances against the ministers of the Crown, a step that alienated much sympathy which his unjust treatment by the government would otherwise have called forth, though it was defended by men like Charles Buller and J. S. Mill. The usual official honours given to a returning plenipotentiary were not accorded to Durham on his arrival at Plymouth on the 30th of November 1838, but the populace received him with acclamation. He immediately set about preparing his memorable "Report on the Affairs of British North America," which was laid before parliament on the 31st of January 1839. This report, one of the greatest state papers in the English language, laid down the principles, then unrecognized, which have guided British colonial policy ever since. It was not written or composed by Charles Buller, as Brougham was the first to suggest, and the credit for the statesmanship it exhibits is Lord Durham's alone, though he warmly acknowledged the assistance he had derived from Buller, Wakefield and others in preparing the materials on which it was based. With regard to the future government of British North America, Durham had at first inclined towards a federation of all the colonies on that continent, and this aim, afterwards achieved, remained in his eyes an ideal to be striven for; but as a more immediately practical policy he advised the legislative union of Upper and Lower Canada, his avowed aim being to organize a single state in which the British inhabitants would be in a majority. He further urged the creation of an executive council responsible to the colonial legislature; he advised state-aided emigration on the broadest possible scale, and the formation of an intercolonial railway for the development of the whole country. Meantime Durham, who almost alone among the statesmen of his time saw the importance of imperial expansion, interested himself in the emigration schemes of Gibbon Wakefield (q.v.); he became chairman of the New Zealand Company, and was thus concerned in the enterprise which forestalled France in asserting sovereignty over the islands of New Zealand in September 1839. His health, however, had long been failing, and he died at Cowes on the 28th of July 1840, just five days after the royal assent had been given to the bill giving effect to his project for uniting Upper and Lower Canada.

Lord Durham filled a larger place in the eyes of his contemporaries than many statesmen who have been better remembered. He was in his lifetime regarded as a great popular leader; and his accession to supreme political power was for some years considered probable by many; his opinions were, however, too extreme to command the confidence of any considerable party in parliament before 1840. That Brougham hated him and Melbourne feared him, is a tribute to his abilities; and in the first Reform Act, of which he was the chief author, and in the famous *Report* on the principles of colonial policy, he left an indelible mark on English history. His personal defects of character did much to mar the success of a career, which, it must be remembered, terminated at the age of forty-eight. He was impatient, hot-tempered, hypersensitive to criticism, vain and prone to take offence at fancied slights; but he was also generous and unvindictive, and while personally ambitious his care for the public interest was genuine and untiring.

By his first wife Durham had three daughters; by his second, who was a lady of the bedchamber to Queen Victoria but resigned on her husband's return from Canada, he had two sons and three daughters. The eldest son, Charles William, the "Master Lambton" of Sir Thomas Lawrence's celebrated picture, died in 1831; the second, George Frederick d'Arcy (1828-1879), succeeded his father as 2nd earl of Durham. The latter's son, John George Lambton (b. 1855), became 3rd earl in 1879.

See Stuart J. Reid, *Life and Letters of the First Earl of Durham* (2 vols., London, 1906); *The Grenville Memoirs*, parts i. and ii. (London, 1874-1887); Richard, duke of Buckingham and Chandos, *Memoirs of the Courts and Cabinets of William IV. and Victoria* (2 vols., London, 1861); William Harris, *History of the Radical*

Party in Parliament (London, 1885); Harriet Martineau, *History of the Thirty Years' Peace* (4 vols., London, 1877); William Kingford, *History of Canada*, vol. x. (10 vols., Toronto, 1887-1898); H. E. Egerton, *Short History of British Colonial Policy* (London, 1897). (R. J. M.)

DURHAM, a northern county of England, bounded N. by Northumberland, E. by the North Sea, S. by Yorkshire, and W. by Westmorland and Cumberland. Its area is 1014.6 sq. m. It is wholly on the eastern slope, the western angle being occupied by spurs of the Pennine chain, exceeding 2300 ft. in height at some points on the Cumberland border. West of a line from Barnard Castle by Wolsingham to the neighbourhood of Consett the whole of the land, excepting narrow valleys, lies at elevations exceeding 1000 ft. This area represents roughly one quarter of the total. The principal rivers rising in these hills are the Derwent, tributary to the Tyne, forming part of the county boundary with Northumberland, the Wear and the Tees, which forms almost the whole of the boundary with Westmorland and Yorkshire. The dales traversed by these rivers in their upper parts, though sufficiently strongly contrasted with the dark, barren moors surrounding them, yet partake of somewhat the same wild character. Lower down, however, are beautiful and fertile valleys, the main rivers flowing between steep, well-wooded banks; while the lesser streams of the coastal district have carved out dens or ravines on the steep flanks of which vegetation is luxuriant. Castle Eden Dene, 7 m. N.W. of Hartlepool, is famous for its beautiful trees and wild flowers. The coastward slope is fairly steep in the northern half of the county, but it is steady, and the coast itself has no striking scenic features, save where the action of the waves upon the magnesian limestone has separated great masses, leaving towering fragments standing, and fretting the face of the rock with caverns and arches. The cluster of rocks named the Black Halls, 6 m. N.W. of Hartlepool, best exhibits these features. Other natural phenomena include the Linnirk caves near Stanhope in Weardale in which numerous fossils and bones, with evidence of habitation by man, have been discovered; and the Hell Kettles, S. of Darlington, near the junction of the Tees and the Skerne, four cavities filled with water, reputed to be unfathomable, and measuring from 80 to 120 ft. in diameter. The water is sulphurous.

Except in the moorlands of the west only a few scraps of the county have been left in their natural state; but these portions are of great interest to the student of natural history. The ballast-hills at Shields, Jarrow and Hartlepool, formed by the discharge of material from ships arriving in ballast from foreign countries, are overgrown with aliens, many of which are elsewhere unknown in this country. Nearly fifty different species have been found. Stockton was almost the last retreat in England of the native black rat. Of the former abundance of deer, wild ox and boar every peat bog testifies by its remains; the boar appears to have existed in the reign of Henry VIII., and records of red deer in the county may be traced down to the middle of the 18th century.

Geology.—The uplift of the Pennine hills causes nearly all the stratified rocks of Durham to dip towards the east or south-east. Thus the oldest rocks are to be found in the west, while in passing eastward younger rocks are continually met. In the hilly district of Weardale and Teesdale the Carboniferous Limestone series prevails; this is a succession of thick beds of limestone with intervening sandstones and shales. Some of the calcareous beds are highly fossiliferous; those at Frosterley near Stanhope are full of the remains of corals and the stone is polished as a marble. Much of the higher ground in the west is capped by Millstone Grit, as at Muggleswick and Walsingham commons. The outcrop of this formation broadens eastward until it is covered by the Durham coalfield which occupies the centre of the county from Newcastle and South Shields to Barnard Castle. The Coal Measures are about 2000 ft. thick and contain upwards of 100 seams of coal, including many of great importance—the Brockwell coal, Low Main coal and High Main coal are some of the well-known seams. Fireclays of great value are obtained from beneath many of the coal seams. Apart from the coals, the Coal Measures are made up of beds of sandstone and shale, the former called "post" and the latter "plate" by the local miners. Permian magnesian limestone succeeds the Coal Measures on the east, it reaches from the Tees to South Shields in a broad tract and occupies the coast between that town and Hartlepool. Remarkable concretionary forms are found in the Fulwell quarries simulating honeycomb and coral structures. The

stone is quarried at Marsden for the manufacture of Epsom salts; it is also used for lime-making and building. Fish remains are not uncommon in it. The sandstones and marls seen between the magnesian limestone and the Coal Measures at South Shields, Newbottle and several miles farther south are usually classed as Permian, but they may possibly prove to belong to the lower series. In the south-east corner of the county, by Darlington, Stockton and Seaton Carew, the low ground is made of Triassic rocks, red marls and sandstones with beds of gypsum and rock salt. Coal Measures undoubtedly underlie the Permian and Triassic strata. Normal faults traverse the district, mostly from east to west. Great dykes and sills of basalt lie in the Tees valley above Middleton and one, the Great Whin Sill, may be followed in an easterly direction for over 120 m. The Cockfield dyke and Little Whin Sill are similar intrusions of basalt. Lead mines have been extensively worked in the limestone districts of Weardale and Teesdale; the limestone itself is quarried on a large scale for fluxing in the ironworks. Glacial deposits obscure the older rocks over much of the county, they contain travelled stones from the Pennines and Cheviots. Submerged forests appear off the coast at West Hartlepool and other points. A small patch of Silurian occurs near Cronkley on the Tees; here slate pencils were formerly made.

Agriculture.—Near the river Tees, and in some places bordering on the other rivers, the soil is loam or a rich clay. At a farther distance from these rivers it is of inferior quality, with patches of gravel interspersed. The hills east of the line from Barnard Castle to Consett are covered with a dry loam, the fertility of which varies with its depth. West of the line the summits and flanks of the hills are in great part waste moorland. Only some two-thirds of the total area of the county are under cultivation, and nearly two-thirds of this are in permanent pasture. There are also nearly 60,000 acres of hill-pasture. Of the diminished area under corn crops oats occupy more than one-half, and barley much exceeds wheat. Nearly two-thirds of the average under green crops are occupied by turnips, as many cattle are raised and have a long-standing reputation. The cows are especially good yielders of milk. The sheep are also highly esteemed, particularly the Teesdale breed. Those of Weardale are small, but their mutton is finely flavoured.

Mining.—The mountain limestone contains veins of lead ore and zinc ore. The beds of coal in the Coal Measures have long been a source of enormous wealth. The mines are among the most extensive and productive in the kingdom. At Sunderland the coal trade furnishes employment for hundreds of vessels, independently of the "keels" or lighters which convey the coal from the termini of the railways and tramways to the ships. The seams worked extend horizontally for many miles, and are from 20 to 100 fathoms beneath the surface. The Frosterley marble has been quarried for many centuries near Stanhope for decorative purposes, in Durham cathedral and elsewhere taking the place of Purbeck marble, while in modern houses it is used chiefly for chimney-pieces. Ironstone is worked in the neighbourhood of Whickham and elsewhere. Excellent slate is quarried at several places. The neighbourhood of Wolsingham abounds in fine millstones. The Newcastle grindstones are procured at Gateshead Fell; and firestone for building ovens, furnaces and the like is obtained in various parts of Durham, and exported in considerable quantity.

Other Industries.—The manufacturing industries are extensive, and all are founded upon the presence of coal, of which, moreover, large quantities are exported. The industrial and mining districts may be taken to lie almost wholly east of a line from Darlington through Bishop Auckland to Consett. Textile industries are not carried on to any great extent, but a large number of hands are employed in the manufacture of machines, appliances, conveyances, tools, &c. Of this manufacture the branch of ship-building stands first; the yards on the Tyne are second only to those on the Clyde, and the industry is prosecuted also at Sunderland, the Hartlepoons and Stockton-on-Tees. The founding and conversion of metal stands next in importance; and other industries include the manufacture of paper, chemicals (chiefly on the Tyne), glass and bottles and earthenware (at Gateshead and Sunderland). The output of limestone is greater than that of any other county in the United Kingdom. As regards iron, the presence of the coal and the proximity of the Cleveland iron district of North Yorkshire enable the county to produce over

one million tons of pig-iron annually, though the output of iron from within the county itself is inconsiderable. There is a large production of salt from brine. The sea fisheries of Sunderland and Hartlepool are valuable.

Communications.—Railway communication is provided entirely by the North Eastern company. The main line runs northward through Darlington, Durham and Gateshead, and there are a large number of branches through the mining and industrial districts, while the company also owns some of the docks. From Stockton to Darlington ran the railway engineered by George Stephenson and opened in 1825. The chief ports of Durham are Jarrow and South Shields on the Tyne, Sunderland at the mouth of the Wear, Seaham Harbour, Hartlepool East and West and Stockton-on-Tees.

Administration and Population.—Durham is one of the Counties Palatine, the others being Lancashire and Cheshire. The area of the ancient county is 649,352 acres, and that of the administrative county 649,244 acres. There were formerly three outlying portions of the county, known as North Durham (including Northamshire and Islandshire), Bedlingtonshire and Crayke. These were attached to the county as having formed parcels of the ancient "patrimony of St Cuthbert," of which the land between Tyne and Tees was the chief portion. The population in 1891 was 1,016,454 and in 1901 1,187,361. The birth-rate is much above, the death-rate also above, but the percentage of illegitimacy considerably below the average. The county is divided into 4 wards. The following are municipal boroughs: Darlington (pop. 44,511), Durham, city (14,679), Gateshead, county borough (109,888), Hartlepool (22,723), Jarrow (34,295), South Shields, county borough (97,263), Stockton-on-Tees (51,478), Sunderland, county borough (146,077), West Hartlepool (62,627). The other urban districts may be distributed so as to indicate roughly the most populous and industrial districts:

1. In the Tyne district (where Gateshead, Jarrow and South Shields are the chief centres)—Blaydon (19,623), Felling (22,467), Hebburn (20,901), Ryton (8452), Whickham (12,852).
2. North-western district—Annfield Plain (12,481), Benfield-side (7457), Consett (6094), Leadgate (4657), Tanfield (8276), Stanley (13,554).
3. Durham and Bishop Auckland district (continuation south of the preceding)—Bishop Auckland (11,969), Brandon and Byshotles (15,573), Crook (11,471), Shildon and East Thicky (11,759), Spennymoor (16,665), Tow Law (4371), Willington (7887).
4. Durham and Sunderland district (N.E. of preceding)—Hetton (13,673), Houghton-le-Spring (7858), Seaham Harbour (10,163), Southwick-on-Wear (12,643). The township of Chester-le-Street (11,753) is also in this district.

The only other urban districts are Barnard Castle (4421) in Teesdale and Stanhope (1964) in Weardale. Durham is in the north-eastern circuit, and assizes are held at Durham. It has one court of quarter sessions and is divided into 16 petty sessional divisions. All the boroughs have separate commissions of the peace. The ancient county, which is in the diocese of Durham, excepting part of one parish in that of York, contains 243 ecclesiastical parishes wholly or in part. There are 288 civil parishes. The county is divided into eight parliamentary divisions, each returning one member—Jarrow, Chester-le-Street, Houghton-le-Spring, Mid, North-west, Barnard Castle, Bishop Auckland, South-east. It also includes the parliamentary borough of Sunderland, returning two members, and the boroughs of Darlington, Durham, Gateshead, Hartlepool, South Shields and Stockton-on-Tees, returning one member each. Among educational establishments there may be mentioned the university and the grammar school in the city of Durham, and the Roman Catholic college of Ushaw near Durham.

History.—After the death of Ida in the 6th century the kingdom of Northumbria was divided into the two states of Bernicia and Deira, separated from each other by the Tees, the latter including the district afterwards known as Durham. The post-conquest palatinate arose by a process of slow growth from the grant of land made by Egrith to St Cuthbert on 1

election to the see of Lindisfarne in 684. On the transference of the see to Chester-le-Street in the 9th century, Guthred the Dane endowed it with the whole district between the Tyne and the Wear, stretching west as far as Watling Street, a grant confirmed by Alfred; and when in 995 the see was finally established at Durham, the endowment was again largely enriched by various donations. Durham continued, however, to form part of the earldom of Northumbria, and not until after the purchase of the earldom by Bishop Walcher in 1075 did the bishops begin to exercise regal rights in their territory. The term *palatinate* is applied to the bishop in 1293, and from the 13th century onwards the bishops frequently claim such rights in their lands as the king enjoys in his kingdom. At the time of the Conquest the bishop's possessions included nearly all the district between the Tees and the Tyne, except Sadberge, and also the outlying districts of Bedlingtonshire, Northamshire, Islandshire and Crayke, together with Hexhamshire, the city of Carlisle, and part of Teviotdale. Henry I. deprived the bishopric of the last three, but in compensation made over to it the villis of Burdon, Aycliffe and Carlton, hitherto included in the earldom of Northumberland. The wapentake of Sadberge also formed part of the earldom of Northumberland; it was purchased for the see by Bishop Pudsey in 1189, but continued an independent franchise, with a separate sheriff, coroner and court of pleas. In the 14th century Sadberge was included in Stockton ward and was itself divided into two wards. The division into the four wards of Chester-le-Street, Darlington, Easington and Stockton existed in the 13th century, each ward having its own coroner and a three-weekly court corresponding to the hundred court. The diocese was divided into the archdeaconries of Durham and Northumberland. The former is mentioned in 1072, and in 1291 included the deaneries of Chester-le-Street, Auckland, Lanchester and Darlington.

Until the 15th century the most important administrative officer in the palatinate was the steward. Other officers were the sheriff, the coroners, the chamberlain and the chancellor. The palatine exchequer was organized in the 12th century. The palatine assembly represented the whole county, and dealt chiefly with fiscal questions. The bishop's council, consisting of the clergy, the sheriff and the barons, regulated the judicial affairs, and later produced the Chancery and the courts of Admiralty and Marshals. The priority of Durham ranked first among the bishop's barons. He had his own court, and almost exclusive jurisdiction over his men. The *quo warranto* proceedings of 1293 exhibit twelve lords enjoying more or less extensive franchises under the bishop. The repeated efforts of the crown to check the powers of the palatinate bishops culminated in 1536 in the Act of Resumption, which deprived the bishop of the power to pardon offences against the law or to appoint judicial officers; indictments and legal processes were in future to run in the name of the king, and offences to be described as against the peace of the king, not against that of the bishop. In 1596 restrictions were imposed on the powers of the chancery, and in 1646 the palatinate was formally abolished. It was revived, however, after the Restoration, and continued with much the same power until the act of 1836, which provided that the palatine jurisdiction should in future be vested in the crown. There were ten palatinate barons in the 12th century, the most important being the Hiltons of Hilton Castle, the Bulmers of Brancepeth, the Conyers of Sockburne, the Hansards of Evenwood, and the Lumleys of Lumley Castle. The Nevilles owned large estates in the county; Raby Castle, their principal seat, was built by John de Neville in 1377. Owing to its isolated position the palatinate took little part or interest in any of the great rebellions of the Norman and Plantagenet period. During the Wars of the Roses Henry VI. passed through Durham, and the novelty of a royal visit procured him an enthusiastic reception. On the outbreak of the Great Rebellion Durham inclined to support the cause of the parliament, and in 1640 the high sheriff of the palatinate guaranteed to supply the Scottish army with provisions during their stay in the county. In 1642 the earl of Newcastle formed western counties into an association for the king's service, but

in 1644 the palatinate was again overrun by the Scottish army, and after the battle of Marston Moor fell entirely into the hands of the parliament.

Durham has never possessed any manufactures of importance, and the economic history of the county centres round the growth of the mining industry, which employed almost the whole of the non-agricultural population. Stephen possessed a mine in Durham which he granted to Bishop Pudsey, and in the same century colliers are mentioned at Coundon, Bishopwearmouth and Sedgfield. Cockfield Fell was one of the earliest Landsale collieries in Durham. Edward III. issued an order allowing coal dug at Newcastle to be taken across the Tyne, and Richard II. granted to the inhabitants of Durham licence to export the produce of the mines, without paying dues to the corporation of Newcastle. Among other early industries lead-mining was carried on in the western part of the county, and mustard was extensively cultivated. Gateshead had a considerable tanning trade and shipbuilding was carried on at Jarrow.

In 1614 a bill was introduced in parliament for securing representation to the county and city of Durham and the borough of Barnard Castle. The movement was strongly opposed by the bishop, as an infringement of his palatinate rights, and the county was first summoned to return members to parliament in 1654. After the Restoration the county and city returned two members each. By the Reform Act of 1832 the county returned two members for two divisions, and the boroughs of Gateshead, South Shields and Sunderland acquired representation. The boroughs of Darlington, Stockton and Hartlepool returned one member each from 1868 until the Redistribution Act of 1885.

Antiquities.—To the Anglo-Saxon period are to be referred portions of the churches of Monk Wearmouth (Sunderland), Jarrow, Escomb near Bishop Auckland, and numerous sculptured crosses, two of which are *in situ* at Aycliffe. The best remains of the Norman period are to be found in Durham cathedral and in the castle, also in some few parish churches, as at Pitlington and Norton near Stockton. Of the Early English period are the eastern portion of the cathedral, the fine churches of Darlington, Hartlepool, and St Andrew, Auckland, Sedgfield, and portions of a few other churches. The Decorated and Perpendicular periods are very scantily represented, on account, as is supposed, of the incessant wars between England and Scotland in the 14th and 15th centuries. The principal monastic remains, besides those surrounding Durham cathedral, are those of its subordinate house or "cell," Finchale Priory, beautifully situated by the Wear. The most interesting castles are those of Durham, Raby, Brancepeth and Barnard. There are ruins of castlelets or peel-towers at Dalden, Ludworth and Langley Dale. The hospitals of Sherburn, Greatham and Keyper, founded by early bishops of Durham, retain but few ancient features.

See W. Hutchinson, *History and Antiquities of the County Palatine of Durham* (3 vols., Newcastle, 1785-1794); R. Surtees, *History and Antiquities of the County Palatine of Durham* (4 vols., London, 1816-1840); B. Bartlet, *The Bishoprick Garland, Collection of Legends, Songs, Ballads . . . of Durham* (London, 1834); J. Raine, *History and Antiquities of North Durham* (London, 1852); Perry and Herman, *Illustrations of the Medieval Antiquities of the County of Durham* (Oxford, 1867); G. T. Lapsley, *The County Palatines of Durham* (New York, &c., 1900); *Victoria County History, Durham*. See also the Surtees Society's Publications, and *Transactions of the Architectural Society of Durham and Northumberland*.

DURHAM, a city and municipal and parliamentary borough, and the county town of Durham, England, 256 m. N. by W. from London, on the North Eastern railway. Pop. (1901) 14,670. The nucleus of the site is a narrow, bold peninsula formed by a bend of the river Wear, on which stand the cathedral and the castle. The city, however, extends both E. and W. of this.

The position of the cathedral of St Cuthbert, its west end rising immediately from the steep wooded bank of the river, is surpassed in beauty by no other English cathedral. Its foundation arose from the fact that here, after wandering far over the north of England, the monks of Lindisfarne rested with the body of St Cuthbert, which they had removed from its tomb in fear of Danish invaders. This was in 995. Soon afterwards a church was built by Bishop Ealdhume,

and the sea was removed hither from Lindisfarne. The peninsula was called Dunholme (Hill Island), which in Norman times was softened to Duresme, whence Durham. It is said that the monks of Lindisfarne, knowing the name of the place where they should find retreat, but ignorant of its situation, were guided hither by a woman searching for her cow, and the bas-relief of a cow on the north wall of the church commemorates this incident. In 1093 Ealdhune's church was rebuilt by Bishop Carilef, who changed the early establishment of married priests into a Benedictine abbey. The grand Norman building in which his designs were carried out remains with numerous additions. The stone-vaulting is particularly noteworthy. The choir contains the earliest work, but Carilef's eastern apses made way for the exquisite chapel of the Nine Altars, with its rose windows and beautiful carving, of late Early English workmanship. The nave is massive Norman, with round pillars ornamented with surface-carving of various patterns. The western towers are Norman with an Early English superstructure. The famous Galilee chapel, of the finest late Norman work, projects from the west end. The central tower is a lofty and graceful Perpendicular structure. Other details especially worthy of notice are the altar screen of c. 1380, and the curious semi-classical font-cover of the 17th century. There is a fine sanctuary-knocker on the north door. The cloisters are of the early part of the 15th century. The chapter-house is a modern restoration of the original Norman structure, a very fine example, which was destroyed by James Wyatt c. 1796, in the course of restoration of which much was ill-judged. The cathedral library, formerly the dormitory and refectories of the abbey, contains a number of curious and interesting printed books and MSS., and the portable altar, vestments and other relics found in St Cuthbert's grave. The Galilee contains the supposed remains of the Venerable Bede. The total length of the cathedral within is 496½ ft., the greatest height within (except the lantern) 74½ ft., and the height of the central tower 218 ft. The diocese of Durham covers the whole county excepting a small fragment, and also very small parts of Northumberland and Yorkshire.

The naturally strong position selected for the resting-place of St Cuthbert's remains was possibly artificially fortified also,

but it was not until 1072 that William the Conqueror caused the erection of a castle to the north of the cathedral across the neck of the peninsula. Of this there remain a beautiful crypt-chapel, and a few details incorporated in later work. Other interesting portions are the Norman gallery, with its fine arcade, Bishop Hatfield's hall of c. 1350, a reconstruction of the previous Norman one by Bishop Pusey, and the Black Staircase of fine woodwork of the 17th century. The keep is a modern reconstruction. The castle, with the exception of some apartments used by the judges of assize, is appropriated to the uses of Durham University. On the peninsula are also the churches of St Mary le Bow in the North Bailey and St Mary the Less, the one a 17th-century building on a very ancient site, possibly that on which the first church rose over St Cuthbert's remains; the other possessing slight traces of Norman work, but almost completely modernized. Of other churches in Durham, the site of St Oswald is apparently pre-Norman, and the building contains Norman work of Bishop Pusey, also some fine early 15th-century woodwork. St Margaret's and St Giles' churches show work of the same period, and the second of these has earlier portions.

Several of the streets of Durham preserve an appearance of antiquity. Three of the bridges crossing the Wear are old, that of Framwellgate having been built in the 13th century and rebuilt in the 15th. In the neighbourhood of the city certain sites are of interest as adding detail to its history. To the south on Maiden Hill there is an encampment, occupied, if not constructed, by the Romans. Immediately W. of Durham is Neville's Cross, of which little remains. The battle of Neville's Cross was fought in 1346, resulting in the defeat of the invading Scots by the English under Lord Neville and Henry Percy. The Scots had encamped at Beaufort or Bearpark, where a few ruins mark the site of the county residence of the priors of

Durham, which had suffered from previous invaders. On the Wear below Durham is the priory of Finchale (1196), of which there are considerable remains of Early English date and later, but in the main Decorated. The valley of the Wear in the neighbourhood of Durham is well wooded and picturesque, but there are numerous collieries on the uplands above it, and the beauty of the county is marred.

Among educational establishments in Durham the university stands first. The earliest connexion of the ecclesiastical foundation at Durham with an actual educational foundation was made by Prior Richard de Hoton (1200-1308), who erected a hall in Oxford for students from Durham, who had previously enjoyed no such provision. In 1380 Bishop Hatfield refounded this hall as Durham College, which became Trinity College (see OXFORD) on a new foundation (1555) when the possessions of the abbey of Durham had been surrendered in 1540, after which Durham College survived as a secular foundation only for a few years. Henry VIII. had the unfulfilled intention of founding a college in Durham, and a similar attempt failed in the time of the Commonwealth. In 1831 the scheme for a college was projected by the chapter; an act of 1832 specified the foundation as a university, and in Michaelmas 1833 its doors were opened. The first warden, and a prime mover in the scheme of foundation, was Archdeacon Charles Thorp (d. 1862). In 1837 the university received its charter from William IV. The dean and chapter of the cathedral are governors, and the bishop of Durham is visitor, but the active management is in the hands of the warden, senate and convocation. The system and life of the university are broadly similar to those of the greater universities of Oxford and Cambridge. Proctorial administration is carried on by two proctors annually nominated by the warden. Among the various residential divisions of the university may be mentioned Bishop Hatfield's Hall (1846), which, through its endowment, by means of such methods of economy as provision for all meals in common, permits men of limited means to become students. The degree for bachelor of arts is awarded after two public examinations, and may be taken in two years, with a total of six months' residence in each year. Special examinations are provided for candidates who seek honours, and those who obtain honours are admissible, after a certain period, to the mastership of arts without further examination, but in other cases further examination must have been taken, or an essay presented as a qualification for this degree. A theological course is provided for bachelors of the university, those who have passed a similar course elsewhere, or non-graduates aged nineteen who have passed a certain standard of examination. Instruction in civil engineering and mining was established as early as 1837, but was subsequently given up; and in 1871 the university and the North of England Institute of Mining and Mechanical Engineers co-operated to found the college of physical science at Newcastle-upon-Tyne, which provides such instruction and was incorporated with the university in 1874. The college of medicine at Newcastle has been in connexion with Durham University since 1852, and the professors there are professors of the university. In 1895 degrees for women were established, and in 1889 a hostel was opened for the accommodation of women, who may take any course of instruction except the theological. In 1889 musical degrees were instituted, and a professorship was founded in 1897. Among other subjects may be mentioned the granting of degrees in hygiene, and of diplomas in public health and education (see J. T. Fowler, *Durham University*, uniform with series of College Histories; London, 1904).

The grammar school was refounded by Henry VIII. out of the monastic school. It is a flourishing institution on the lines of the public schools, and has "king's scholarships" tenable in the school, and scholarships and exhibitions tenable at the universities. There are also a diocesan training college for schoolmasters and mistresses, and a high school for girls; and 4 m. W. of the city is the great Roman Catholic College of St Cuthbert, Ushaw, the representative of the old college at Douai. Here are preserved the magnificent natural history collections of Charles

Waterton. Other buildings worthy of notice in Durham are the town-hall, a 16th-century building reconstructed in 1851, the police station, and the guildhall, the shire hall and county buildings, and the county hospital. There are ironworks and manufactures of hosiery, carpets and mustard in the city. The parliamentary borough returns one member. The corporation consists of a mayor, 6 aldermen and 18 councillors. Area, 1070 acres.

History of the City.—The foundation of the city followed on that of the church by the monks of Lindisfarne at the close of the 10th century. The history of the city is closely associated with that of the palatinate of Durham. The bishop of Durham among other privileges claimed a mint in the city, which, according to Boldon Book, rendered ten marks yearly until its value was reduced by that established by Henry II. at Newcastle, and it was temporarily abolished by the same king. The earliest charter, dated 1179 or 1180, is a grant of exemption from toll merchet and heriot made by Bishop Hugh Pudsey and confirmed by Pope Alexander. Before that time, however, the monks had a little borough at Elvet, which is divided from Durham by the Wear and afterwards became part of the city. In 1183 the city was at farm and rendered sixty marks. It was at first governed by a bailiff appointed by the bishop, but in 1565 Bishop Pilkington ordained that the government should consist, in addition to the bailiff, of one alderman and twelve assistants, the latter to continue in office for life, and the former to be chosen every year from among their number. This form of government was replaced in 1602, under the charter of Bishop Matthew, by that of a mayor, 12 aldermen and 24 burgesses, the aldermen and burgesses forming a common council and electing a mayor every year from among the aldermen. This was confirmed by James I., but in 1684 the corporation were obliged to resign their charters to Bishop Crew, who granted them a new one, probably reserving to himself a right of veto on the election of the mayor and aldermen. At the time of the Revolution, however, Bishop Matthew's charter was revived, and continued to be the governing charter of the city until 1770, when, owing to dissensions as to the election of the common council, the number of aldermen was reduced to four and the charter became void. No mayor or aldermen were elected for ten years, but in 1780 Bishop Egerton, on the petition of the burgesses, granted them a new charter, which was practically a confirmation of that of 1602, and remained in force until the Municipal Reform Act of 1835. Being within the county palatine, the city of Durham sent no members to parliament, until, after several attempts beginning in 1614, it was enabled by an act of 1673 to return two members, which it continued to do until 1885, when by the Redistribution of Seats Act the number was reduced to one.

The corporation of Durham claim their fair and market rights under Bishop Pudsey's charter of 1179, confirmed in 1565, as a weekly market on Saturday and three yearly fairs on the feasts of St Cuthbert in September and March and on Whit Monday, each continuing for two days. In 1610 the bishop of Durham brought a suit in chancery against the burgesses and recovered from them the markets and fairs, which he afterwards leased to the corporation for a rent of £20 yearly until they were purchased from the Ecclesiastical Commissioners in 1860. Durham has never been noted for any particular trade; and the attempts to introduce the manufacture of cloth and wool in the 17th and 18th centuries were failures. The manufacture of carpets was begun in 1814.

DURHAM, a city and the county-seat of Durham county, North Carolina, U.S.A., in a township of the same name, 25 m. N.W. of Raleigh. Pop. (1900) 6679, of whom 2241 were negroes; (1910) 18,241; of the township (1900) 19,055; (1910) 27,606. Adjacent to the city and also in the township are East Durham and West Durham (both unincorporated), which industrially are virtually part of the city. Durham is served by the Southern, the Seaboard Air Line, the Norfolk & Western, and the Durham & Southern railways, the last a short line connecting at Apex and Dunn, N.C., respectively with the main line of the Seaboard and the Atlantic Coast Line railways. Durham is nearly surrounded by hills. Its streets are shaded by elms. The city

is the seat of Trinity College (Methodist Episcopal, South), opened in 1851 as a normal college, growing out of an academy called Union Institute, which was established in the north-western part of Randolph county in 1838 and was incorporated in 1841. In 1852 the college was empowered to grant degrees; in 1856 it became the property of the North Carolina Conference of the Methodist Episcopal Church, South; in 1859 it received its present name; and in 1892 it was removed to a park near Durham, included in 1901 in the corporate limits of the city. A new charter was adopted in 1903, and a law school was organized in 1904. The college has received many gifts from the Duke family of Durham. In 1908 its endowment and property were valued at about \$1,198,400, and the number of its students was 288. Although not officially connected with the college, the *South Atlantic Quarterly*, founded by a patriotic society of the college and published at Durham since 1902, is controlled and edited by members of the college faculty. The *North Carolina Journal of Education* and the *Papers of the Trinity College Historical Society* also are edited by members of the college faculty. The Trinity Park school is preparatory for the college. Near the city are Waits hospital (for whites) and Lincoln hospital (for negroes). Durham's chief economic interest is in the manufacture of granulated smoking tobacco, for which it became noted after the Civil War. In the city are two large factories and store houses of the American Tobacco Company. The tobacco industry was founded by W. T. Blackwell (1839-1904) and Washington Duke (1820-1905). The city also manufactures cigars, cigarettes, snuff, a fertilizer having tobacco dust as the base, cotton goods, lumber, window sashes, blinds, drugs and hosiery. Durham has a large trade with the surrounding region. The town of Durham was incorporated in 1860, and became the county-seat of the newly-erected county in 1881, and in 1899 was chartered as a city. Its growth is due to the tobacco and cotton industries. In the Bennett house, at Durham Station, near the city, General J. E. Johnston surrendered on the 26th of April 1865 the Confederate army under his command to General W. T. Sherman.

DURIAN (Malay, *duri*, a thorn), the fruit of *Durio sibeethinus*, a tree of the natural order Bombaceae, which attains a height of 70 or 80 ft., has oblong, tapering leaves, rounded at the base, and yellowish-green flowers, and bears a general resemblance to the elm. The durio is cultivated in Sumatra, Java, Celebes and the Moluccas, and northwards as far as Mindanao in the Philippines; also in the Malay Peninsula, in Tenasserim, on the Bay of Bengal, to 14° N. lat., and in Siam to the 13th and 14th parallels. The fruit is spherical, and 6 to 8 in. in diameter, approaching the size of a large coco-nut; it has a hard external husk or shell, and is completely armed with strong pyramidal tubercles, meeting one another at the base, and terminating in sharp thorny points; these sometimes inflict severe injuries on persons upon whom the fruit may chance to fall when ripe. On dividing the fruit at the joints of the carpels, where the spines arch a little, it is found to contain five oval cells, each filled with a cream-coloured, glutinous, smooth pulp, in which are embedded from one to five seeds about the size of chestnuts. The pulp and the seeds, which latter are eaten roasted, are the edible parts of the fruit. With regard to the taste of the pulp, A. R. Wallace remarks, "A rich butter-like custard, highly flavoured with almonds, gives the best idea of it, but intermingled with it come wafts of flavour that call to mind cream-cheese, onion-sauce, brown sherry and other incongruities; . . . it is neither acid, nor sweet, nor juicy, yet one feels the want of none of these qualities, for it is perfect as it is." The fruit, especially when not fresh from the tree, has, notwithstanding, a most offensive smell, which has been compared to that of rotten onions or of putrid animal matter. The Dyaks of the Sarawak river in Borneo esteem the durian above all other fruit, eat it unripe both cooked and raw, and salt the pulp for use as a relish with rice.

See Linschoten, *Discours of Voyages*, bk. i. chap. 57. p. 102. fol. (London, 1598); Bickmore, *Travels in the East Indian Archipelago*, p. 91 (1868); Wallace, *The Malay Archipelago* (3rd ed. 1872).

DURIS, of Samos, Greek historian, according to his own account a descendant of Alcibiades, was born about 340 B.C. He must have been born and passed his early years in exile, since from 352 to 324 Samos was occupied by Athenian cleruchs, who had expelled the original inhabitants. He was a pupil of Theophrastus of Eresus, whom he met at Athens. When quite young, he obtained a prize for boxing at the Olympic games; a statue by Hippias was set up in commemoration of his victory (Pausanias vi. 13. 5). He was for some time despot of his native island. Duris was the author of a comprehensive historical work (*ἱστορία*) on Hellenico-Macedonian history, from the battle of Leuctra (371) down to the death of Lysimachus (281), which was largely used by Diodorus Siculus. Other works by him included a life of Agathocles of Syracuse, the annals (*ἄποτα*) of Samos chronologically arranged according to the lists of the priests of Hera, and a number of treatises on literary and artistic subjects. Ancient authorities do not appear to have held a very high opinion of his merits as a historian. Plutarch (*Pericles*, 28) expresses doubt as to his trustworthiness. Dionysius of Halicarnassus (*De compos. verborum*, 4) speaks disparagingly of his style, and Photius (*cod.* 176) regards the arrangement of his work as altogether faulty. Cicero (*ad Att.* vi. 1) accords him qualified praise as an industrious writer.

Fragments in C. W. Müller, *Frag. Hist. Græc.* ii. 446, where the passage of Pausanias referred to above and the date of Duris's victory at Olympia are discussed.

DÜRKHEIM, a town of Germany, in the Bavarian Palatinate, near the foot of the Hardt Mountains, and at the entrance of the valley of the Isenach, 15 m. N.W. of Spire on the railway Monshiem-Neustadt. Pop. 6300. It possesses two Evangelical churches and one Roman Catholic, a town hall occupying the site of the castle of the princes of Leiningen-Hartenburg, an antiquarian and a scientific society, a public library and a high school. It is well known as a health resort, for the grape cure and for the baths of the brine springs of Philippaballe, in the neighbourhood, which not only supply the bathing establishment, but produce considerable quantities of marketable salt. There is a brisk trade in wine and oil; tobacco, glass and paper are manufactured.

As a dependency of the Benedictine abbey of Limburg, which was built and endowed by Conrad II., Dürkheim or Thurnigheim came into the possession of the counts of Leiningen, who in the 14th century made it the seat of a fortress, and enclosed it with wall and ditch. In the three following centuries it had its full share of the military vicissitudes of the Palatinate; but it was rebuilt after the French invasion of 1689, and greatly fostered by its counts in the beginning of next century. In 1794 its new castle was sacked by the French, and in 1849 it was the scene of a contest between the Prussians and the insurrectionists. The ruins of the Benedictine abbey of Limburg lie about 1 m. S.W. of the town; and in the neighbourhood rises the Kastanienberg, with the ancient rude stone fortification of the Heidenmauer or Heathen's Wall.

DURLACH, a town of Germany, in the grand-duchy of Baden, 2½ m. by rail from Karlsruhe, with which it is connected by a canal and an avenue of poplars, on the left bank of the Pfalz, at the foot of the vineyard-covered Thurberg, which is crowned by a watch-tower and to the summit of which a funicular railway ascends. Pop. (1905) 6207. It possesses a castle erected in 1565 and now used as barracks, an ancient town hall, a church with an excellent organ, a high-grade school, an orphan asylum, and in the market-place a statue of the margrave Charles II. It has manufactures of sewing-machines, brushes, chemicals, tobacco, beer, vinegar and chicory; and considerable trade in market produce.

Durlach was bestowed by the emperor Frederick II. on the margrave Hermann V. of Zähringen as an allodial possession, but afterwards came into the hands of Rudolf of Habsburg. It was chosen as his residence by the margrave Charles II. in 1565, and retained this distinction till the foundation of Karlsruhe in 1715, though it was almost totally destroyed by the French in 1688. In 1846 it was the seat of a congress of the Liberal

party of the Baden parliament; and in 1849 it was the scene of an encounter between the Prussians and the insurgents. Reichenbach the mechanician, and E. L. Posselt (1765-1804) the historian, were natives of the town.

See Fecht, *Geschichte der Stadt Durlach* (Heidelberg, 1869).

DUROC, **GÉRAUD CHRISTOPHE MICHEL**, duc de Friuli (1772-1813), French general, was born at Pont à Mousson (Meurthe et Moselle) on the 25th of October 1772. The son of an officer, he was educated at the military schools of his native town and of Châlons. He was gazetted second lieutenant (artillery) in the 4th regiment in 1793, and advanced steadily in the service. Captain Duroc became aide-de-camp to Napoleon in 1796, and distinguished himself at Isonzo, Brenta and Gradisca in the Italian campaigns of 1796-97. He served in Egypt, and was seriously wounded at Aboukir. His devotion to Napoleon was rewarded by complete confidence. He became first aide-de-camp (1798), general of brigade (1800), and governor of the Tuileries. After the battle of Marengo he was sent on missions to Vienna, St Petersburg, Stockholm and Copenhagen. As grand marshal of the Tuileries he was responsible for the measures taken to secure Napoleon's personal safety whether in France or on his campaigns, and he directed the minutest details of the imperial household. After Austerlitz, where he commanded the grenadiers in the absence of General Oudinot, he was employed in a series of important negotiations with Frederick William of Prussia, with the elector of Saxony (December 1806), in the incorporation of certain states in the Confederation of the Rhine, and in the conclusion of the armistice of Znaim (July 1808). In 1808 he was created duke of Friuli, and after the Russian campaign he became senator (1813). He was in attendance on Napoleon at the battle of Bautzen (20th-21st May 1813) in Saxony, when he was mortally wounded, and died in a farmhouse near the battlefield on the 23rd of May. Napoleon bought the farm and erected a monument to his memory. Duroc was buried in the Invalides.

The chief source for Duroc's biography is the *Moniteur* (31st of May 1797, 24th of October 1798, 30th of May 1813, &c.).

DUROCHER, **JOSEPH MARIE ELISABETH** (1817-1858), French geologist, was born at Rennes on the 31st of May 1817. Educated at the École Polytechnique and École des Mines in Paris, he qualified as a mining engineer. Early in his career he travelled in the northern parts of Europe to study the metalliferous deposits, and he contributed the articles on geology, mineralogy, metallurgy and chemistry to Paul Gaimard's *Voyages de la Commission scientifique du nord, en Scandinavie, en Laponie, au Spitzberg et aux Féroé, pendant les années 1838-1840*. In 1844 he became professor of geology and mineralogy at Rennes. His attention was now largely directed to the study of the artificial production of minerals, to the metamorphism of rocks, and to the genesis of igneous rocks. In 1857 he published his famous *Essai de pétrologie comparée*, in which he expressed the view that the igneous rocks have been derived from two magmas which coexist beneath the solid crust, and are respectively acid and basic. He died at Rennes on the 3rd of December 1858.

DURRA (also written *dourah*, *dhura*, &c.; Arabic for a pearl, hence a grain of corn), a cereal grass, *Sorghum vulgare*, extensively cultivated in tropical and semi-tropical countries, where the grain, made into bread, forms an important article of diet. In non-Arabic-speaking countries it is known by other names, such as Indian or African millet, pearl millet, Guinea corn and Kaffir corn. In India it is called jowari, jowaree, jawari, &c. (Hindi, *jowārī*).

DURUY, **JEAN VICTOR** (1811-1894), French historian and statesman, was born in Paris on the 11th of September 1811. The son of a workman at the factory of the Gobelins, he was at first intended for his father's trade, but succeeded in passing brilliantly through the École Normale Supérieure, where he studied under Michelet, whom he accompanied as secretary in his travels through France, supplying for him at the École Normale in 1836, when only twenty-four. Ill-health forced him to resign, and poverty drove him to undertake that extensive series of school textbooks which first brought him into public notice.

He devoted himself with ardour to secondary school education, holding his chair in the Collège Henri IV. at Paris for over a quarter of a century. Already known as a historian by his *Histoire des Romains et des peuples soumis à leur domination* (2 vols., 1843-1844), he was chosen by Napoleon III. to assist him in his life of Julius Caesar, and his abilities being thus brought under the emperor's notice, he was in 1863 appointed minister of education. In this position he displayed incessant activity, and a desire for broad and liberal reform which aroused the bitter hostility of the clerical party. Among his measures may be cited his organization of higher education ("enseignement spécial"), his foundation of the "conférences publiques," which have now become universal throughout France, and of a course of secondary education for girls by lay teachers, and his introduction of modern history and modern languages into the curriculum both of the *lycées* and of the colleges. He greatly improved the state of primary education in France, and proposed to make it compulsory and gratuitous, but was not supported in this project by the emperor. In the new cabinet that followed the elections of 1869, Duruy was replaced by Louis Olivier Bourbeau, and was made a senator. After the fall of the Empire he took no part in politics, except for an unsuccessful candidature for the senate in 1876. From 1881 to 1886 he served as a member of the Conseil Supérieur de l'Instruction Publique. In 1884 he was elected to the Academy in succession to Mignet. He died in Paris on the 25th of November 1894.

As a historian Duruy aimed in his earlier works at a graphic and picturesque narrative which should make his subject popular. His fame, however, rests mainly on the revised edition of his Roman history, which appeared in a greatly enlarged form in 7 vols. under the title of *Histoire des Romains depuis les temps les plus reculés jusqu'à la mort de Théodose* (1879-1885), a really great work; a magnificent illustrated edition was published from 1879 to 1885 (English translation by W. J. Clarke, in 6 vols., 1883-1886). His *Histoire des Grecs*, similarly illustrated, appeared in 3 vols. from 1886 to 1891 (English translation in 4 vols., 1892). He was the editor, from its commencement in 1846, of the *Histoire universelle, publiée par une société de professeurs et de savants*, for which he himself wrote a "Histoire sainte d'après la Bible," "Histoire grecque," "Histoire romaine," "Histoire du moyen âge," "Histoire des temps modernes," and "Abrégé de l'histoire de France." His other works include *Atlas historique de la France accompagné d'un volume de texte* (1849); *Histoire de France de 1453 à 1815* (1856), of which an expanded and illustrated edition appeared as *Histoire de France depuis l'invasion des barbares dans la Gaule romaine jusqu'à nos jours* (1892); *Histoire populaire de la France* (1862-1863); *Histoire populaire contemporaine de la France* (1864-1866); *Casseries de voyage* (1864); and *Introduction générale à l'histoire de France* (1865).

A memoir by Ernest Lavisse appeared in 1895 under the title of *Un Ministre: Victor Duruy*. See also the notice by Jules Simon (1895), and *Portraits et souvenirs* by S. Monod (1897).

DU RYER, PIERRE (1606-1658), French dramatist, was born in Paris in 1606. His earlier comedies are in the loose style of Alexandre Hardy, but after the production of the *Cid* (1636) he copied the manner of Corneille, and produced his masterpiece *Scévole*, probably in 1644 (the date generally given is 1646). *Alcione* (1638) was so popular that the abbé d'Aubignac knew it by heart, and Queen Christina is said to have had it read to her three times in one day. Du Ryer was a prolific dramatist. Among his other works may be mentioned *Saül* (printed 1642), and a comedy, *Les Vendanges de Suresnes* (1635 or 1636). He died in Paris on the 6th of November 1658.

DUSE, ELEANORA (1859-), Italian actress, was born at Vigevano of a family of actors, and made her first stage appearance at a very early age. The hardships incident to touring with travelling companies unfavourably affected her health, but by 1885 she was recognized at home as Italy's greatest actress, and this verdict was confirmed by that of all the leading cities of Europe and America. In 1893 she made her first appearances in New York and in London. For some years she was closely

associated with the romanticist Gabriele d'Annunzio, and several of his plays, notably *La Città morta* (1898) and *Francesca da Rimini* (1901), provided her with important parts. But some of her great successes during the 'eighties and early 'nineties—the days of her chief triumphs—were in Italian versions of such plays as *La Dame aux camélias*, in which Sarah Bernhardt was already famous; and Madame Duse's reputation as an actress was founded less on her "creations" than on her magnificent individuality. In contrast to the great French actress she avoided all "make-up"; her art depended on intense naturalness rather than stage effect, sympathetic force and poignant intellectuality rather than the theatrical emotionalism of the French tradition. Her dramatic genius gave a new reading to the parts, and during these years the admirers of the two leading actresses of Europe practically constituted two rival schools of appreciation. Ill-health kept Madame Duse off the stage for some time; but though, after 1900, it was no longer possible for her to avoid "make-up," her rank among the great actresses of history remained indisputable.

See also a biography by L. Rasi (1901); A. Symons, *Studies in Seven Arts* (1906).

DUSSEK, JOHANN LUDWIG (1761-1812), Bohemian pianist and composer, was born at Czaslau, in Bohemia, on the 9th of February 1761. His father, Johann Joseph Dussek, a musician of high reputation, was organist and choir-master in the collegiate church of Czaslau, and several other members of the family were distinguished as organists. Under the careful instruction of his father he made such rapid progress that he appeared in public as a pianist at the age of six. A year or two later he was placed as a choir boy at the convent of Iglau, and he obtained his first instruction in counterpoint from Spenar, the choir-master. When his voice broke he entered on a course of general study, first at the Jesuits' college, and then at the university of Prague, where he took his bachelor's degree in philosophy. During his curriculum of two and a half years he had paid unremitting attention to the practice and study of his art, and had received further instruction in composition from a Benedictine monk. In 1779 he was for a short time organist in the church of St Rombaut at Mechlín. At the close of his engagement he proceeded to Holland, where he attained great distinction as a pianist, and was employed by the stadtholder as musical instructor to his family. While at the Hague he published his first works, several sonatas and concertos for the piano. He had already composed at the age of thirteen a solemn mass and several small oratorios. In 1783 he visited Hamburg, and placed himself under the instruction of Philip Emmanuel Bach. After spending two years in Lithuania in the service of Prince Radziwill, he went in 1786 to Paris, where he remained, with the exception of a short period spent at Milan, until the outbreak of the Revolution, enjoying the special patronage of Marie Antoinette and great popularity with the public. In Milan he appeared not only as a pianist but also as a player of the harmonica, an instrument which was much sought after on account of its novelty in those days. Towards the close of 1789 he removed to London, where on the 2nd of March 1790 he appeared at Salomon's concerts, and he married a daughter of Dominico Corri, herself a clever harpist and pianist. Unfortunately he was tempted by the large sale of his numerous compositions to open a music-publishing warehouse in partnership with Montague Corri, a relative of his wife. The result was injurious to his fame and disastrous to his fortune. Writing solely for the sake of sale, he composed many pieces that were quite unworthy of his genius; and, as he was entirely destitute of business capacity, bankruptcy was inevitable. In 1800 he was obliged to flee to Hamburg to escape the claims of his creditors. Some years later he was attached in the capacity of musician to the household of Prince Louis Ferdinand of Prussia, with whom he formed an intimate friendship. On the death of his patron in 1806 he passed into the service of the prince of Isenburg as court musician. In 1809 he went to Paris to fill a similar situation in the household of Prince Talleyrand, which he held until his death on the 20th of March 1812.

Dusek had an important influence on the development of pianoforte music. As a performer he was distinguished by the purity of his tone, the combined power and delicacy of his touch, and the facility of his execution. His sonatas, known as *The Invocation*, *The Farewell* and *The Harmonic Elegy*, though not equally sustained throughout, contain movements that have scarcely been surpassed for solemnity and beauty of idea.

See also Alexander W. Thayer's articles in Dwight's *Journal of Music* (Boston, 1861).

DÜSSELDORF, a town of Germany, in the Prussian Rhine province, on the right bank of the Rhine, 24 m. by rail N. by W. from Cologne. Pop. (1885) 115,190; (1895) 175,985; (1905) 252,630. Düsseldorf is one of the handsomest cities of western Germany. Its situation on the great mid-European waterway and as the junction of several main lines of railway has largely favoured its rapid growth and industrial development. It is the principal banking centre of the Westphalian coal and iron trade, and the favourite residence of the leading merchants of the lower Rhine.

The city consists of five main portions—the Altstadt, the original town with narrow, irregular streets; the Karlstadt, dating from 1787 and so called after the electoral prince Charles Theodore; the Neustadt, laid out between 1690 and 1716; and the Friedrichstadt and the Königstadt, of recent formation. In addition, the former villages of Pempelfort, Oberbilk, Unterbilk, Flingern and Derendorf have been incorporated and form the outer suburbs of the town proper. On the south side the town has been completely metamorphosed by the removal of the Köln-Mindner and Bergisch-Maerisch stations to a central station lying to the east. The site thus gained was converted into new boulevards, while the railway to Neuss and Aix-la-Chapelle was diverted through the suburb of Bilk and thence across the Rhine by an iron bridge. A road bridge (completed 1898, 2087 ft. long), replacing the old bridge of boats, carries the electric tram-line to Crefeld. The town, with the exception of the Altstadt, is regularly built, but within its area are numerous open grounds and public squares, which prevent the regularity of its plan degenerating into monotony; the market-place, with the colossal bronze statue of the elector John William, the parade, the Allee Strasse, the Königs Allee, and the Königs Platz may be specially mentioned. Of the thirty-seven churches, of which twenty-six are Roman Catholic, the most noticeable are:—St Andrew's, formerly the Jesuit and court church, with frescoes by J. Hübner (1806–1882), E. Deger (1809–1885), and H. Mücke (1806–1891); and the embalmed bodies of several Rhenish electors; St Lambert's, with a tower 180 ft. high and containing a monument to Duke William (d. 1592); Maximilians, with frescoes by J. A. N. Settegast (1813–1890); the Romanesque St Martin's, and the new Gothic church of St Mary. Besides the old ducal palace, laid in ruins by the French in 1794, but restored in 1846, the secular buildings comprise the government offices, the post-office in Italian style, the town hall on the market square, the law courts, the municipal music hall, the municipal theatre, the assembly hall of the Rhenish provincial diet, an Italian Renaissance edifice erected in 1879, the academy of art (1881; in pure Renaissance), the industrial art museum (1896), the historical museum, and the industrial art school. The town also possesses a library of 50,000 volumes, several high-grade schools, and is the seat of a great number of commercial and intellectual associations; but to nothing is it more indebted for its celebrity than to the Academy of Painting. This famous institution, originally founded by the elector Charles Theodore in 1767, was re-organized by King Frederick William III. in 1822, and has since attained a high degree of prosperity as a centre of artistic culture. From 1822 till 1826 it was under the direction of Cornelius, a native of the town, from 1826 to 1859 under Schadow, and from 1859 to 1864 under E. Bendemann (1811–1889). From Bendemann's resignation it continued in the hands of a body of curators till 1873, when Hermann Wislicenus (1825–1899) of Weimar was chosen director. The noble collection of paintings which formerly adorned the Düsseldorf gallery was removed to Munich in 1805, and has not since been restored; but there

is no lack of artistic treasures in the town. The academy possesses 14,000 original drawings and sketches by the great masters, 24,000 engravings, and 248 water-colour copies of Italian originals; the municipal gallery contains valuable specimens of the local school; and the same is the case with the Schulte collection. The principal names are Cornelius, Lessing, the brothers Andreas and Oswald Achenbach, A. Baur (b. 1835), A. Tidemand (1814–1876), and L. Knaus (b. 1820). An annual exhibition is held under the auspices of the Art Union; and the members of the Artists' Society, or *Malakasten*, as they are called, have annual festivals and masquerades.

The town is embellished with many handsome monuments—notably a bronze statue of Cornelius, by A. Donndorf (b. 1835), an equestrian statue of the emperor William I. (1896), and a large bronze group in front of the assembly hall of the diet, representing the river Rhine and its chief tributaries. In the suburb of Bilk there are the Florigarten and Volksgarten, the astronomical observatory and the harbour. Extensive quays afford accommodation for vessels of deep draught, and the trade with the Dutch cities and with London has been thereby greatly enhanced. Within recent years Düsseldorf has made remarkable progress as an industrial centre. The first place is occupied by the iron industries, embracing foundries, furnaces, engineering and machine shops, &c. Next come cotton spinning and weaving, calico printing, yarn-spinning, dyeing and similar textile branches, besides a variety of other industries.

A little to the north of the town lies the village of Düsseldorf, with Count von der Recke-Volmerstein's establishment for homeless children in the former Trappist monastery, and in the suburb of Pempelfort is the *Jägerhof*, the residence at one time of Prince Frederick of Prussia, and afterwards of the prince of Hohenzollern-Sigmaringen.

Düsseldorf, as the form of the name—the village on the Düsseldorf—clearly indicates, was long a place of small consideration. In 1288 it was raised to the rank of a town by Count Adolf of Berg; from his successors it obtained various privileges, and in 1385 was chosen as their residence. After it had suffered greatly in the Thirty Years' War and the War of the Spanish Succession, it recovered its prosperity under the patronage of the electoral prince John William of the Palatinate, who dwelt in the castle for many years before his death in 1716. In 1795 the town, after a violent bombardment, was surrendered to the French; and after the peace of Lunéville it was deprived of its fortifications. In 1805 it became the capital of the Napoleonic duchy of Berg; and in 1815 it passed with the duchy into Prussian possession. Among its celebrities are Johann Georg and Friedrich Heinrich Jacobi, Heinrich Heine, Varnhagen von Ense, Peter von Cornelius, Wilhelm Camphausen and Heinrich von Sybel.

See H. Ferber, *Historische Wanderung durch die alte Stadt Düsseldorf* (Düsseldorf, 1899–1890); Brandt, *Studien zur Wirtschafts- und Verwaltungsgeschichte der Stadt Düsseldorf* (Düsseldorf, 1902); and local *Guide* by Bone.

DÜSSERAH, or **DASARA**, a Hindu new-moon festival (sometimes called Maha-navami), held in October, and specially connected with ancestral worship. In the native states, such as Mysore, the rajas give public entertainments lasting for ten days, and especially invite European officials to the festivities, which include horse-racing, athletic contests, and banquets.

See J. A. Dubois, *Hindu Manners, Customs and Ceremonies*, p. 577.

DUST, earth or other matter reduced to fine dry and powdery particles; the word is Teutonic and appears in such various forms as the Dutch *dust*, Danish *dyst*, for the dust of flour or meal, and in the older forms *dunst*; the modern German *Dunst*, vapour, probably preserves the original form and meaning, that of something which can be blown about by the wind.

Atmospheric Dust.—The presence of dust in the atmosphere has probably been known from the earliest ages, as prehistoric man must have had plenty of opportunities of noticing it lighting up the paths of sunbeams that penetrated his dark caves, yet it is only of recent years that it has become the subject of scientific observation. Formerly it was considered as simply matter in the wrong place, the presence of which had to be tolerated, but there

was supposed to serve no useful purpose in nature. It was not till the year 1880 that atmospheric dust came under scientific investigation, when it soon became evident that it played a most important part in nature, and that instead of being a nuisance to be got rid of, it added much to the comforts and pleasures of life.

The atmosphere is composed of a number of gases which have a nearly constant proportion to each other, and of varying proportions of water vapour. This vapour, constantly rising from land and sea, mixes with the gases in the atmosphere and so long as it remains vapour is invisible, but when it becomes cooled by the actual processes in nature the vapour tends to condense to the liquid condition and form cloud particles. Before 1880 it had always been assumed that when this condensation took place, the vapour molecules simply combined with each other to form the little globules of water, but J. Aitken showed that vapour molecules in the atmosphere do not combine with each other, that before condensation can take place there must be some solid or liquid nucleus on which the vapour molecules can combine, and that the dust in the atmosphere forms the nuclei on which the water-vapour molecules condense. Every cloud particle being grown round a dust nucleus thus has a dust particle in it. The presence of dust in the atmosphere allows the condensation of the vapour to take place whenever the air is cooled to the saturation point, and if there were no dust present the condensation would not take place till the air was cooled far below that point, and become highly supersaturated; and when it did take place the condensation would be violent and result in heavy rain-drops without the formation of what we know as cloud. This might be in some ways an advantage, but living in such supersaturated air would have many disadvantages. The supersaturated air having no dust to condense on would condense on our clothes, the inside and outside walls of our dwellings, and on every solid and liquid surface with which it came in contact.

Many of the dust particles in the atmosphere which form the nuclei of condensation are extremely minute, so small as to be beyond the powers of the microscope, and at first sight it might appear to be impossible to get any reliable information as to their numbers. But Aitken, having shown that water vapour must have a nucleus to condense on, saw that this placed in our hands the means of counting the dust particles in our atmosphere, and in 1888 showed how it could be done. As water vapour in the air condenses on the dust particles present and forms cloud particles, he showed that all that would be necessary would be to cause the dust particles to become centres of condensation, when they would be so increased in size as to come within the range of an ordinary magnifying lens, and that by counting the cloud particles it would be possible to determine the number of dust particles. To carry out this idea the air under examination was placed in an air-tight receiver and saturated with water vapour. It was then expanded by an air-pump, and in this way cooled and condensation produced. The cloud particles so formed were allowed to fall on a micrometer and their number counted by the aid of an ordinary short-focussed lens. Certain precautions are necessary in carrying out this process. There must not be more than 500 particles per cubic centimetre of air, or all the particles will not form nuclei, and will not therefore be thrown down as cloud particles. When the number in the air tested exceeds that figure, the dusty air must be mixed with such a quantity of dustless air as will reduce the number below 500 per c.c., and the correct number in the air tested is obtained by allowing for the proportion of dustless air to dusty air, and for the expansion necessary for cooling.

Thousands of tests of the atmospheric dust have been made with this instrument at many places over the world, and in no part of it has dustless air been found; indeed it is very rare to find air with less than 100 particles per c.c., whilst in most country places the numbers rise to thousands, and in cities such as London and Paris the number may be as high as 100,000 to 150,000 per c.c.

The sources of dust particles in the atmosphere are numerous. In nature volcanoes supply a large quantity, and the meteoric matter constantly falling towards the earth and becoming dissipated by the intense heat produced by the friction of the atmosphere keep up a constant supply. Large quantities of dust are also raised from the surface of the earth by strong winds, from dusty roads and dry soil, and there is good reason for supposing that large quantities of sand are carried from the deserts by the wind and transported great distances, the sand, for instance, from the desert of Africa being carried to Europe. It is, however, to artificial causes that most of the dust is due. The burning of coal is the principal source of these, not only when the coal is burned with the production of smoke, but also when smokeless, and even when the coal is first converted into gas and burned in the most perfect forms of combustion. It results from this that while in the air over the uninhabited parts of the earth and over the ocean the number of particles is small, being principally produced by natural causes or carried from distant lands, they are much more numerous in inhabited areas, especially in those where much coal is burned. It is evident that if there were not some purifying process in nature there would be a tendency for the dust particles to increase in numbers, because though some dust particles may fall out of the air, many of them are so small they have but little tendency to settle, but by becoming centres of cloud particles they are carried downwards to the earth, and, further, these when showering down as rain tend to wash the others out of the atmosphere. We may therefore look on all uninhabited areas of the earth as purifying areas, and their purifying power seems to depend partly on their extent, but principally on their rainfall. The following table illustrates the purifying effect of some of these areas obtained from the results of hundreds of observations. The areas referred to are: (1) Mediterranean Sea, the observations being made on the south coast of France on the air blowing inshore; (2) the Alps, the observations being made on the Rigi Kulm; (3) the Highlands of Scotland, the observations being made at various places; and (4) the Atlantic Ocean, the observations being made on the west coast of Scotland, when the wind blew from the ocean.

	Mediterranean.	Alps.	Highlands.	Atlantic.
Mean of lowest	891	381	141	72
Mean of number	1611	892	552	338

These numbers are all low for atmospheric dust, much lower than in air from inhabited areas. On the Rigi Kulm, for instance, the number was sometimes over 10,000 per c.c. when the wind was from inhabited areas and the sun causing ascending currents; and at the same place as the Atlantic air was tested the numbers went up to over 5000 per c.c. when the wind blew from the inhabited areas of Scotland, though the distance to the nearest was over 60 m.

E. D. Fridlander¹ made many observations on the dust of the atmosphere with the same instrument as employed by Aitken. In crossing the Atlantic he got no low numbers, always over 2000 per c.c., but in the Gulf of St Lawrence he got a reading as low as 280 per c.c. In crossing the Pacific the lowest obtained was 245, in the Indian Ocean 243, in the Arabian Sea 280, in the Red Sea 383, and in the Mediterranean 875 per c.c. He has also made observations in Switzerland. The lowest number obtained by him was in the air at the top of the Bieshorn, 13,600 ft. above sea-level, where the number was as low as 157 per c.c. Professor G. Melander² of Helsingfors studied the dust in the atmosphere. His observations were made in Switzerland, Biskra in the Sahara, Finland, the borders of Russia, and in Norway; but in none of these places were low numbers observed. The minimum numbers were over 300 per c.c., while maximum numbers in some cases went high.

Aitken when observing on the Rigi Kulm noticed during some

¹ "Atmospheric Dust Observations from various parts of the World," *Quart. Journ. Roy. Met. Soc.* (July 1896).

² *La Condensation de la vapeur d'eau dans l'atmosphère* (Helsingfors, 1897).

conditions of weather that there was a daily variation in the number of particles, a maximum near the hottest part of the day and a minimum in the morning, and attributed the rise in the numbers to the impure air of the valleys rising on the sun-heated slopes of the mountain or driven up by the wind. A. Rankin, at the Ben Nevis observatory, also observed this daily variation, and his observations also indicate a yearly variation at that station, the numbers being highest in March, April and May. This may possibly be due to small rainfall in these months, but more probably to the fact that south-easterly winds blow more frequently during these months on Ben Nevis than at any other season, and these winds bring the impure air from the more densely inhabited parts of the country.

Without atmospheric dust not only would we not have the glorious cloud scenery we at present enjoy, but we should have no haze in the atmosphere, none of the atmospheric effects that delight the artist. The white haze, the blue haze, the tender sunset glows of red, orange and yellow, would all be absent, and the moment the sun dipped below the horizon the earth would be in darkness; no twilight, no after-glows, such as those given some years ago by the volcanic dust from Krakatoa; none of the poetry of eventide. Why, it may be asked, is this? Simply because all these are due to matter suspended in the air, to dust. Water has no such effects as long as it is a vapour, and if it condensed without the presence of dust, the particles would be far too few to give any appreciable effect and too heavy to remain in suspension.

Turning now to the investigations on this point, Aitken has shown that there is no evidence to indicate that water vapour has any hazing effect, and shows that the haze is entirely due to dust, the density of the haze increasing with the increase in the number of dust particles in the air, and also with the *relative* humidity; but the humidity does not act as vapour, but by condensing on the dust and increasing the size of the particles, as it is not the amount of vapour present but the degree of saturation that affects the result; the more saturated the air, the more vapour is condensed on the particles, they so become larger and their hazing effect increased.

The relation of haze or transparency of the air to the number of dust particles was observed on five visits to the Rigi Kulm. The visibility of Hochgerrach, a mountain 70 m. distant from the Rigi, was used for estimating the amount of haze when the air was clear. During the visits this mountain was visible thirteen times, and it was never seen except when the number of particles was low. On eight occasions the mountain was only one-half to one-fifth hazed, and on these days the number of particles was as low as from 326 to 850 per c.c. It was seen five times when the number was from 950 to 2000 per c.c., but the mountain on these occasions was only just visible, and it was never seen when the number was a little over 2000 per c.c.

It has been pointed out that the relative humidity has an effect on the dust by increasing the size of the particles and so increasing the haze. It was therefore necessary in working out the dust and haze observations made at the different places to arrange all the observations in tables according to the wet-bulb depressions at the time. All the observations taken when the wet-bulb depression was between 2° and 4° were put in one table, all those when it was between 4° and 7° in another, and all those when it was over 7° in a third. It should be here noted that when the dust particles were counted and the wet and dry bulb observations taken, an estimate of the amount of haze was also made. This was done by estimating the amount of haze on a mountain at a known distance. Suppose the mountain to be 25 m. distant, and at the time to be one-half hazed, then the limit of visibility of the mountain under the conditions would be 50 m., and that was taken as the number representing the transparency of the atmosphere at the time. In the tables above referred to along with the number of particles was entered the limit of visibility at the time; when this was done it was at once

seen that as the number of particles increased the limit of visibility decreased, as will be seen from the following short table of the Rigi Kulm observations when the wet-bulb depression was between 2° and 4°

Date.	Lowest Number.	Highest Number.	Mean Number.	Limit of Visibility in Miles.	C.
19th May 1891	428	690	559	150	83,850
22nd May 1889	434	850	642	100	64,200
16th May 1893	1225	2600	1912	40	77,480
					Mean 75,176.

When the number of particles is multiplied by the limit of visibility in the tables a fairly constant number C. is obtained; see preceding table. All the observations taken at the different places were treated in a similar manner and the means of all the observations at the different humidities were obtained, and the following table gives the mean values of C. at the different wet-bulb depressions of all the observations made at the different places.

Wet-bulb depression .	2° to 4°	4° to 7°	7° and over
Mean values of C. .	76,058	105,545	141,148

From the above table it will be seen that as the dryness of the air increased it required a larger number of particles to produce a complete haze, nearly double the number being required when the wet-bulb depression was over 7° than when it was only from 2° to 4°. To find the number of particles required to produce a complete haze, that is, to render a mountain just invisible, all that is necessary is to multiply the above constant C. by 160,930, the number of centimetres in a mile, when this is done with the observations made in the West Highlands we get the numbers given in the following table:—

Wet-bulb depression.	Number of Particles to produce a complete haze.
2° to 4°	12,500,000,000
4° to 7°	17,100,000,000
7° to 10°	22,600,000,000

The above table gives the number of particles of atmospheric dust in a column of air having a section of one centimetre square, at the different humidities, required to produce a complete haze, that is, to make a distant object invisible, and is of course quite independent of the length of the column.

In making these dust and transparency observations three things were noted: 1st, the number of particles; 2nd, the humidity; and 3rd, the limit of visibility. From the results above given, it is evident that if we now know any two of these we can calculate the third. Suppose we know the limit of visibility and the humidity, then the number of particles can be calculated by the aid of the above tables.

To show the hazing effects of dust it is not, however, necessary to use a dust counter. Aitken for some years made observations on the haze in the air at Falkirk by simply noting the direction of the wind, the wet-bulb depression at the time, and the transparency of the air. Falkirk is favourably situated for such observations owing to the peculiar distribution of the population surrounding it. The whole area from west, north-west to north, is very thinly populated, while in all other directions it is densely populated. It was found that the air from the thinly inhabited parts, that is, the north-west quadrant, was nine times clearer than the air from other directions with the same wet-bulb depression, and that the density of the haze was directly proportional to the density of the population of the area from which the wind blew. These observations also showed that the transparency of the air increases with the dryness, being 3.7 times clearer when the wet-bulb depression is 8° than when it is only 2°, and that the air coming from the densely inhabited parts is about 10 times more hazed than if there were no inhabitants in the country. (J. A.)

DUTCH EAST INDIA COMPANY, THE (*Oostindische Vereenigde Maatschappij*), a body founded by a charter from the Netherlands states-general on the 20th of March 1602. It had a double purpose: first to regulate and protect the already considerable trade carried on by the Dutch in the Indian Ocean, and then to help in prosecuting the long war of independence against Spain and Portugal. Before the union between Portugal and Spain in 1580-81, the Dutch had been the chief carriers of eastern produce from Lisbon to northern Europe. When they were shut out from the Portuguese trade by the Spanish king they were driven to sail to the East in order to make good their loss. Unsuccessful attempts were made to find a route to the East by the north of Europe and Asia, which would have been free from interference from the Spaniards and Portuguese. It was only when these failed that the Dutch decided to intrude on the already well-known route by the Cape of Good Hope, and to fight their way to the Spice Islands of the Malay Archipelago. A first expedition, commanded by Cornelius Houtman, a merchant long resident at Lisbon, sailed on the 2nd of April 1595. It was provided with an itinerary or book of sailing instructions drawn up by Jan Huyghen van Linschoten,¹ a Dutchman who had visited Goa. The voyage was marked by many disasters and losses, but the survivors who reached the Texel on their return on the 20th of August 1597 brought back some valuable cargo, and a treaty made with the sultan of Bantam in Java.

These results were sufficient to encourage a great outburst of commercial adventure. Companies described as "Van Ferne"—that is, of the distant seas—were formed, and by 1602 from sixty to seventy Dutch vessels had sailed to Hindustan and the Indian Archipelago. On those distant seas the traders could neither be controlled nor protected by their native government. They fought among themselves as well as with the natives and the Portuguese, and their competition sent up prices in the eastern markets and brought them down at home. Largely at the suggestion of Jan van Oldenbarnevelt, and in full accordance with the economic principles of the time, the states-general decided to combine the existing separate companies into one united Dutch East India Company, which could discharge the functions of a government in those remote seas, prosecute the war with Spain and Portugal, and regulate the trade. A capital estimated variously at a little above and a little under 6,500,000 florins, was raised by national subscription in shares of 3000 florins. The independence of the states which constituted the United Netherlands was recognized by the creation of local boards at Amsterdam, in Zealand, at Delft and Rotterdam, Hoorn and Enkhuizen. The boards directed the trade of their own districts, and were responsible to one another, but not for one another as towards the public. A general directorate of 60 members was chosen by the local boards. Amsterdam was represented by 20 directors, Zealand by 12, Delft and Rotterdam by 14, and Hoorn and Enkhuizen also by 14. The real governing authority was the "Collegium," or board of control of 17 members, of whom 16 were chosen from the general directorate in proportion to the share which each local branch had contributed to the capital or joint stock. Amsterdam, which subscribed a half, had eight representatives; Zealand, which found a quarter, had four; Delft and Rotterdam, Hoorn and Enkhuizen had two respectively, since each of the pairs had subscribed an eighth. The seventeenth member was nominated in succession by the other members of the United Netherlands. A committee

¹ Linschoten was born at Haarlem in or about 1563. He started his travels at the age of sixteen and, after some years in Spain, went with the Portuguese East India fleet to Goa, where he arrived in September 1583, returning in 1589. In 1594 and 1595 he took part in the Dutch Arctic voyages, and in 1598 settled at Enkhuizen, where he died on the 8th of February 1611. His *Navigatio ac itinerarium* (1595-1596) is a compilation based partly on his own experiences, partly on those of other travellers with whom he came in contact. It was translated into English and German in 1598; two Latin versions appeared in 1599 and a French translation in 1610. The famous English version was reprinted for the Hakluyt Society in 1885. Large selections, with an Introduction, are published in C. Raymond Beazley's *Voyages and Travels*, vol. ii. (English Garner, London, 1903).

of ten was established at the Hague to transact the business of the company with the states-general. The "collegium" of seventeen nominated the governors-general who were appointed after 1608. The charter, which was granted for twenty-one years, conferred great powers on the company. It was endowed with a monopoly of the trade with the East Indies, was allowed to import free from all custom dues, though required to pay 3% on exports, and charged with a rent to the states. It was authorized to maintain armed forces by sea and land, to erect forts and plant colonies, to make war or peace, to arrange treaties in the name of the stadtholder, since eastern potentates could not be expected to understand what was meant by the states-general, and to coin money. It had full administrative, judicial and legislative authority over the whole of the sphere of operations, which extended from the west of the Straits of Magellan westward to the Cape of Good Hope.

The history of the Dutch East India Company from its formation in 1602 until its dissolution in 1798 is filled, until the close of the 17th century, with wars and diplomatic relations. Its headquarters were early fixed at Batavia in Java. But it extended its operations far and wide. It had to deal diplomatically with China and Japan; to conquer its footing in the Malay Archipelago and in Ceylon; to engage in rivalry with Portuguese and English; to establish posts and factories at the Cape, in the Persian Gulf, on the coasts of Malabar and Coromandel and in Bengal. Only the main dates of its progress can be mentioned here. By 1619 it had founded its capital in Batavia in Java on the ruins of the native town of Jacatra. It expelled the Portuguese from Ceylon between 1638 and 1658, and from Malacca in 1641. Its establishment at the Cape of Good Hope, which was its only colony in the strict sense, began in 1652. A treaty with the native princes established its power in Sumatra in 1667. The flourishing age of the company dates from 1605 and lasted till the closing years of the century. When at the summit of its prosperity in 1669 it possessed 150 trading ships, 40 ships of war, 10,000 soldiers, and paid a dividend of 40%. In the last years of the 17th century its fortunes began to decline. Its decadence was due to a variety of causes. The rigid monopoly it enforced wherever it had the power provoked the anger of rivals. When Pieter Both, the first governor-general, was sent out in 1608, his instructions from the Board of Control were to see that Holland had the entire monopoly of the trade with the East Indies, and that no other nation had any share whatever. The pursuit of this policy led the company into violent hostility with the English, who were also opening a trade with the East. Between 1613 and 1632 the Dutch drove the English from the Spice Islands and the Malay Archipelago almost entirely. The English were reduced to a precarious footing at Bantam in Java. One incident of this conflict, the torture and judicial murder of the English factors at Amboyna in 1623, caused bitter hostility in England. The success of the company in the Malay Archipelago was counterbalanced by losses elsewhere. It had in all eight governments: Amboyna, Banda, Ternate, Macassar, Malacca, Ceylon, Cape of Good Hope and Java. Commissioners were placed in charge of its factories or trading posts in Bengal, on the Coromandel coast, at Surat, and at Gambroon (or Bunder Abbas) in the Persian Gulf, and in Siam. Its trade was divided into the "grand trade" between Europe and the East, which was conducted in convoys sailing from and returning to Amsterdam; and the "Indies to Indies" or coasting trade between its possessions and native ports.

The rivalry and the hostilities of French and English gradually drove the Dutch from the mainland of Asia and from Ceylon. The company suffered severely in the War of American Independence. But it extended and strengthened its hold on the great islands of the Malay Archipelago. The increase of its political and military burdens destroyed its profits. In the early 18th century it was already embarrassed, and was bankrupt when it was dissolved in 1798, though its credit remained unshaken, largely, if its enemies are to be believed, because it concealed the truth and published false accounts. In the later stages of its history its revenue was no longer derived from trade,

but from forced contributions levied on its subjects. At home, the directors, who were accused of nepotism and corruption, became unpopular at an early date. The company was subject to increasing demands and ever more severe regulation on the successive renewals of its charters at intervals of twenty-one years. The immediate causes of its destruction were the conquest of Holland by the French revolutionary armies, the fall of the government of the stadtholder, and the establishment of the Batavian Republic in 1798.

AUTHORITIES.—The great original work on the history of the Dutch East India Company is the monumental *Beschryving van oost en nieuw oost Indiën* (Dordrecht and Amsterdam, 1724), by François Valentyn, in 8 vols., folio, profusely illustrated. Two modern works of the highest value are: J. K. J. de Jonge, *De Ophoest van het Nederlandsch Geslacht in oost Indiën* (The Hague and Amsterdam, 1862-1888), in 13 vols.; J. J. Meinsma, *Geschiedenis van de Nederlandsche oost-Indische Bezittingen* (3 vols., Delft and the Hague, 1872-1875). See also John Crawford, *History of the Indian Archipelago* (Edinburgh, 1820); Clive Day, *The Dutch in Java* (New York, 1904); Sir W. W. Hunter, *A History of British India* (London, 1899); and Pierre Bonassieux, *Les Grandes Compagnies de commerce* (Paris, 1892).

DUTCH LANGUAGE. When the Romans reached the territory now forming the kingdom of Holland, they found a number of tribes south of the Rhine, who—though here and there mixed with Germans—belonged to a non-Germanic race, and who, closely related to the Belgian tribes, spoke a language belonging to the Celtic group. Possibly they were also situated on the more elevated grounds north of the Rhine, at least vestiges of them may still be traced. We do not know anything about their being mixed with or subdued by the intruding German tribes. We can only guess it.

At that time the fertile delta of the Rhine was already occupied by German tribes who in language and national customs must have stood in some relation to the tribes living along the Rhine in Germany, later called Franks. The consonantal system of their language was in accordance with the other Low-German dialects, which is proved by the remains we have in the glosses of the *Lex Salica*, for the greater part handed down in a bad condition. These tribes, whom we shall take together under the name of Low-Franks—the Romans called them Batavi, Caninefates, Chamavi, &c.—were spread over Gelderland, Overysel, part of Utrecht and South Holland, and the south-western part of North Holland. When in the sixth century allied tribes from the present north Germany, who named themselves Saxons after one of those tribes living alongside the Elbe, conquered the territory occupied by the Franks a great many retreated from the eastern parts, and then the Franks, who already in the time of the Romans had begun to invade into the territory of the Belgian tribes, continued their wars of conquest in a southward direction and subdued all the land south of the branch of the Rhine that is called the "Waal." Since that time the Frankish dialect came there, and the Celtic-speaking population of the south suffered its language to be entirely supplanted by that of the conquerors. Hence in the formerly Celtic-speaking parts of Brabant and Limburg we find but Frankish dialects, somewhat corresponding with those of part of Gelderland, Utrecht and Holland. The deviation that is perceptible concerns less the use of words than the way of laying the stress.

In part of Gelderland, east of the Ysel, and in Overysel, the older Frankish dialect (of the Salian Franks) was given up and the language of the victorious Saxons was assumed, perhaps here and there strongly mixed with the older language. The language which is spoken there, and farther to the north through Drenthe as far as in some parts of Groningen, is called Saxon. Indeed, these dialects correspond in a great many respects with the language of the Old-Saxon poem *Heliland* (q.v.) and with the North-German dialects—from the latter they deviate considerably in some respects. The chief point of conformity is the formation of the plural of the verb: *wi loopt, wi gât, Heliland: wi klopad, wi gangad*, which are *wi loopen, wêi gaan* in the Frankish dialects. In the vocal system, too, there are peculiar differences.

In the north of Holland there lived, and still lives alongside the

coast, a tribe with which Caesar did not come in contact. The Frisians were spread over a large distance along the shore as far as the mouth of the Elbe, and in the west at least as far as the country north of Haarlem. In the time of the Romans they cannot have extended their power farther southward. Later, however, this seems to have been the case. Maerlant and Melis Stoke (13th century) tell us that time was when their power extended even over part of Flanders. About the year 339 they were repelled as far as the mouth of the Meuse, and ever afterwards the Franks, led by their counts, pushed their dominion back farther and farther to the north, as far as the country north of Alkmaar. After all, a great many Frisian peculiarities may be perceived in the language of the country people of the parts which were once in their power.

To begin with the south: in Zealand the population has quite given up the former probably non-Germanic language, Frisian influence is still perceptible in many words and expressions, but for all that the language has lost the Frisian character and assumed the nature of the neighbouring Frankish dialects in the present Belgium and Brabant. If it was then influenced by the south, later it was influenced rather by the language of Holland. Farther to the north Frisian elements may be perceived in Holland at the seashore and also in many respects still in North Holland. The real Frisian tongue has only been preserved in the province of Friesland, where intrusion of the dialect spoken in Holland is already perceptible since the 13th century. With the Frisian tongue this formed a new dialect in the towns, the "Stadfrisch," whereas the country people in the villages and the peasants have preserved the old Frisian tongue as "Boerenfrisch."

The more eastward dialects of Frisian in Groningen, the eastern part of Friesland (*Stellingawerf*) and West-Drenthe were first strongly mixed with Saxon; at the same time we find a strong mixture of Frisian and Saxo-Frankish east of the Zuider Zee. Later the Saxon dialect of the town of Groningen, once the capital of East-Drenthe, became prominent over the whole province.

In all parts, however, the language of Holland, mixed with and changed by the living speech, is getting more and more influence, issuing from the towns and large villages.

This influence over the whole country began at the opening of the 17th century, and, in connexion with the prevalent written language, gradually produced a colloquial language, deviating from the written language as well as from the native idioms of the country, though assuming elements from both. In this colloquial speech the idiom of Holland forms the basis, whereas the written language formed itself on quite different principles.

If we compare the colloquial speech and the native idiom with the written language, we find remarkable differences, which are caused by the origin of the Dutch written language.

The first to write in any of the idioms of the Dutch language, if we leave apart the old version of the psalms in East Low Frisian, was an inhabitant of the neighbourhood of Maastricht, Henrik van Veldeke, who wrote a Servatius legend and an *Aeneid*; the latter we only know by a Mid High German copy. This dialect deviates from the western dialects and has likeness to the Middle-Frankish. His work had no influence whatever on the written language.

In the west of Belgium, in the districts of Antwerp, East and West Flanders and Brabant, great prosperity and strong development of commerce caused a vivid intellectual life. No wonder we find there the first writings in the West-Low-Frankish native idiom. This language spread over the neighbouring districts. At least in 1254 we find the same language used in the statute (i.e. privilege) of Middelburg.

In those parts a great deal was written in poetry and prose, and the writings in this language are known under the name of Middle-Dutch literature.

If originally the south took the lead in all departments, later the north gradually surpasses the south, and elements from the northern native idiom begin to intrude into the written language.

North of the Meuse and the Rhine little was written as yet in the 13th century. Not until about 1300 does literary life begin to develop here (Melis Stoke's *Rijmchronijk*), and these writings

were written in the language of the south with slight deviations here and there. Chancery and clergy had taken a written language to the north, deviating considerably from the native idiom in vogue there, which belonged to the Friso-Frankish idioms. So this written language gradually spread over the west of the Netherlands and Belgium. The east of the Netherlands agreed in its chancery style more with the districts of Low Germany.

There was a great difference between the written language and the dialect spoken on the banks of the Y. This becomes quite conspicuous if we compare what Roemer Vischer, Coster, Bredero borrow from their native idiom with the language of Huygens or Cats, in the latter of which the southern elements predominate, mixed with the dialects of Zeeland and Holland. Vondel, too, in his first period was influenced by the idiom of Brabant. Only after 1625 does he get on more familiar terms with the Amsterdam dialect. In the various editions of his poems it may be seen how not only loan-words, but also words belonging to the southern idiom, are gradually replaced by other words, belonging to the vocabulary of North Holland, and still to be heard.

The written language passed from the south to the north, and, considerably changed at Amsterdam, was also assumed in the other provinces in the 17th century, after the Union of Utrecht. In the north, in Groningen and Friesland, the official writings and laws were still noted down in a Frisian or Saxo-Frisian idiom as late as the 15th and 16th centuries. When the contact with Holland grew stronger, and the government officials ever and again came in contact with Holland, chancery, too, gradually assumed the Holland idiom. The same took place in the eastern provinces.

This, however, did not yet make the written language popular, which did not happen before the population of the Dutch provinces got its *Statenbybel*, the well-known authorized version of the Bible, made at Dordrecht between 1626 and 1637.

By the frequent use of this so-called *Statenvertaling* the language of Holland obtained its vogue in all provinces on the point of religion, and many expressions, borrowed from that Bible, were preserved in the native idiom.

By the remarkable vicissitudes of these parts from the earliest time up to the moment when Holland became an independent kingdom, during which alternately German elements under the Bavarian counts and French influences under the Burgundian princes were predominant, and also later in the 16th and 17th centuries, elements from these languages were mixed with the language in common use. Moreover, various words passed from the eastern languages into Dutch by the colonial and commercial connexions, while at the same time many words were borrowed from Latin, the language of the learned people, especially in the 16th century, and from French, under the influence of the poetic clubs of the 17th and 18th centuries. In the time of the rhetoricians, in the 16th century, and of Coornbert, as well as in the days of Bredero, Hooft and Vondel, we repeatedly find opposition against these foreign words, often successful, so that in 1650 Vondel could say: "*Onze spraak is sedert weinige jaren herwaart van bastaard-woorden en onduitsch allengs geschuimt.*"¹ Some people, e.g. Hooft, went even so far as to make very clumsy versions of Latin and French bastard words, handed down of old.

Under the influence of the club "*Nil Volentibus Arduum*" and the predominant literary clubs of the 18th century, people became inclined towards expressing their thoughts as much as possible in pure Dutch. Therefore a large number of rules were given, with respect to prose as well as to poetry, in consequence of which the written language grew very stiff in choice of words and forms, and remains so till the latter half of the 19th century. The obtusion of the French language during the reign of Napoleon had no effect. But the subsequent union of Holland and Belgium strengthened the French element, especially in the higher ranks of society. King William I. had tried to make Dutch more popular in Belgium by a general teaching of the

¹ i.e. "Within a few years our language has been gradually skimmed of bastard words and non-Dutch elements."

Dutch language. When north and south were separated, the French became predominant in the south. Only in the Flemish provinces of Belgium the people tried to preserve the native idiom and to do away with French words. These endeavours, called "*De Vlaamsche beweging*," begun by F. v. Willems, Heremans and others in the south, were supported in the north by Professor de Vries at Leiden. In order to get a pure Dutch language, the idea of composing a general Dutch dictionary was introduced. M. de Vries and his partner L. te Winkel, however, did not begin this task before having given a new formulation of the rules for spelling. These rules, deviating in many respects from the spelling then in vogue, introduced by Siegenbeek in 1806, have been predominant up to the present moment. Since 1801 Dr R. A. Kollwijn and Dr F. Buitentrust Hettema have been engaged in trying to bring about a simplification in the spelling. As this simplification is not generally considered efficient, their principles are not yet generally adopted; see for instance C. H. den Hertog, *Waarom onaanemelyk?* (Groningen, 1893).

Excepting Belgium (Flanders, Antwerp, Brabant) the Dutch language is heard outside Holland in Dutch East India and in the West Indies. In East India pure Dutch has been preserved, though some Javanese and Malay bastard words may have slipped in by the habit of speaking to the population in the Malay tongue or in the native idiom. Hence no Indo-Dutch was formed there. This is different in the West Indies, where a great number of negro words and English words as well as English syntactical constructions have slipped in.

In the 17th century a number of Dutchmen, for the greater part from Holland and Zeeland, under Jan van Riebeeck, had settled in South Africa, in Cape Town, where the Dutch navigation called into being a Dutch port. In course of time they were joined there by French emigrants (most of them Huguenots who left their country about 1688 and joined with other Huguenots from Holland in assuming the Dutch language), perhaps also by Portuguese and by Malay people, who, together with the English who settled there and after 1820 became numerous in Cape Colony, mixed some peculiarities of their language with the Dutch idioms. Thus in the first half of the 18th century the language arose which is now called the South African Dutch. Since 1880 the present Dutch language has become more frequently used in official writings, though with certain adaptations agreeably to the native idiom.

In order to offer an example of the Middle-Dutch language beside the present language, we give here a single strophe from Maerlaet's *Wapene Marlyn*, with a metrical translation in modern Dutch from the pen of Nikolaas Beets (1880).

God, diet al bi redene doet,
Gaf dit wandel ertsche goet
Der menscheit gemene,
Dattere made was gevoot,
Ende geoliet, ende gecooet,
Ende leven soude rene.
Nu es gericheit so verwoet,
Dat die sette sines moet
Om al te hebbene alleen.
Hiervome stortmen menschenbloet,
Hiervome stichtmen metter spoot
Borge ende hoghe steen
Mengen te wene.

God, die het al met wijsheid doet,
Gaf dit vergaanklijk aardche goet
Der menschen in 't gemene,
Op dat zij moeten sijn gevoot,
Het lijf geoliet, geoucht de woot
En leven rein van arene.
Maar sijn nu hae de beboecht woet
Dat iedereen in arene moet
't Al hebben wi alleen!
Hiervom vergiet men menschenbloet
En boewt met machinaem spoot
Burchtlosten, swaar van steen,
Tot smart van menscheit.

A Survey of the Sounds used in Dutch.—The Consonants. As regards the consonants, Dutch in the main does not differ from the other Low German languages. The explosive *g* and the *th* are wanting. Instead of the former there is a *g* with "fricative" pronunciation, and as in High German the *th* has passed over into *z*.

The final consonants in Middle Dutch are sharpened, and the sharp sounds are graphically represented; in Modern Dutch, on the other hand, the historical development of the language being more distinctly kept in view, and the agreement observed with the inflexional forms, the soft consonant is written more frequently than it is sounded; thus we have Middle Dutch *dack*, Modern Dutch *dag*, in analogy with the plural *dagen*.

The gutturals are *g*, *k*, *ch* and *h*.

G is the soft spirant, not used in English. In Middle Dutch this letter was also indicated by *gh*. *K* was pronounced like English *k*. In Middle Dutch *c* was sometimes used instead of *k*; now this is no longer done.

Ch (pronounced as German *ch* without the *i*-sound, not as English *ch*) loses its sound when combined with *s* to *sch* at the end of a syllable, for instance, *pleesch*, but the *s*-sound is not purely dental as in *dans*. As an initial consonant *sch* is nearly pronounced as *sz*

(*schip*, English ship); only in Frisian and Saxon dialects the old consonant *sk* in *schip*, *schok* is retained.

H has the same pronunciation as in English. The dentals are *d* and *t*. The *d* is formed by placing the point of the tongue against the upper teeth. At the end of a word *d* is sharpened into *t*, but written *d*, for instance, *goed*, pronounced *gud*. In the idiom of the east of the Netherlands final *d* is preserved. When between two vowels after *oe* (Eng. *l* in *do*), *h*, or *si*, *d* is not pronounced, though it is written. After it has been left out, a *j*-sound has developed between the two vowels, so, for instance, *goede* became first *goe:z* and then *goe:zj*. Thus it is pronounced, though it is still spelled *goede*. After *ou* *d* disappeared and *ou* became *ow*, for instance *koude* > *kow*.

T has the same pronunciation as in English. In some dialects final *t* is dropped, for instance, *heef* for *heeft*, *in* for *niel*.

S has the pronunciation of English *s* in sound, *s* that of English *z* in hazel; only in *sessig* and *zeventig* *s* has the pronunciation of *s*.

The labials are *b*, *f*, *v*, *p*. At the beginning and in the body of a word *b* has the same sound as in English. At the end of a word, when shortened from *bb*, followed by a vowel, it became *β* in the pronunciation, so older *krabb* became *krabβ*, *krab* (the present spelling), which is now pronounced *krap*.

F has the same pronunciation as English *f*. In many cases older initial *f* passed into *v*, hence most words which have *f* in English have initial *v* in Dutch, for instance *vader*, *vet*, *vechten*.

This *v*, initial and between vowels, has the pronunciation of English *v* in lover. Dutch *β* is the same as English *β*, also the liquids and nasals.

The *w* in Dutch is mostly labiodental; in the eastern parts before vowels bilabial pronunciation is heard.

Vowels.—*A* has in open syllables the sound of English *a* in father, in closed syllables that of English *a* in ass, but more open; when there is a clear sound in closed syllables the spelling is *aa* (*jaar*), in open syllables *a* (*maaken*), pronounced as *a* in ask; in *bad*, *nat*, *a* = *d*. An original short *a* and a long *a* in open syllables are even in Middle Dutch pronounced alike, and may be rhymed with each other (*dagen*, *lagen*, a rhyme which was not permitted in Middle High German). In the Saxon dialects *ā* was expressed by *ao*, *ā* or *ā* in the Friso-Saxon districts passes into *ā* before *r*, as *jēr* (*jaar*). Middle Dutch preserved *a* in several words where in Modern Dutch it passes into *e* before *r* (*arg*, *erg*; *sarc*, *serk*; *warf*, *werf*); in others, as *waard*, *staart*, *swaard*, the Middle Dutch had *e* and *a* (*erde*, *steri*, *sweert*, *sloot*, *stort*; Modern Dutch *sward*, *staart*). In foreign words, likewise, *e* before *r* has become *a*; *poars*, *poers*; *lantaarn*, *lantierne* (in the dialects *e* is still frequently retained).

E. The sound of the *e* derived from *a* does not differ from that of an original *e*, or of an *e* derived from *i*, as they appear in open syllables (*steden*, *seen*, pronounced as *a* in English name). If the *e* derived from *a* or *i* or the original *e* occurs in closed syllables, it has a short sound, as in English men, end, Modern Dutch *sem*. The *e* in closed syllables with a full sound (as English *a*; Sweet, *e*) is spelled *ee*: *neel*, *wieck* (*e* from *ō*), *boek*. The sharp, clear *e* is indicated by the same letters in both open and closed syllables: *eer*, *sweeuw*, *see*.

In some dialects this *ee* is pronounced like English *ee*, not only in the present dialects, but also in the 17th century.

The pronunciation of *ei* (from *ai*, or *eg*; as English *ai*, *ei*, *ē*) is that of English *i*, for instance, Dutch *ei*: *aglich*, *egg*, is pronounced like English *i*.

I is pronounced short (somewhat like *i* of English pit), for instance in *pij*, *bieden*, *sikkel*; it has a clear sound in *fabrikan*, though it has no stress.

Ie is pronounced like English *ee* in sec, but somewhat shorter: *so*, *fabriek*, *fabrieken*, *Pieter*; also in *bieden*, *stierf*, &c. For original long *i*, Middle Dutch *ii* and *ij*, afterwards *y*, was used. This vowel, though still written *y*, is pronounced like English *i* in *i*, like; so in *syje* (English siskin), *lyhem*, &c.

The letter *o* represents three sounds:—(1) the short sharp *o* and (2) the short soft *o*, the former like the *o* in English not and French *soldat* (Dutch *doed*, *behefs*, *tocht*, *kof*), the latter like the English *o* in don, the French *o* in *dallon* (Dutch *dof*, *plaffen*, *ochtend*, *wol*), and (3) the full, clear *o* as in English note, French *note* (Dutch *kolen*, *slozen*, *verlozen*). The sharp clear *oo*, in *stroom*, *dood*, has almost the same sound as the full *o*, in some dialects (among others the Saxon) it is pronounced as *o* with a glide *o*, in others (Flemish and Hollandsch) somewhat like *ou*. In Middle Dutch, the lengthening of the vowels was frequently indicated by *e* (before *r* sometimes by *i*, as in *oir*); hence *oe* for *o*, *oe* for *o*. Where *oe* occurs in the modern language, it has the sound of *o* (pronounced like the *u* in High German, and answering to the Gothic *ō*), which in Middle Dutch was frequently represented by *ou*. *oe* is pronounced *ou* (as; Sweet, p. 6) in West Flemish and the Groningen dialects. Before labials and gutturals *oe* in Middle Dutch was expressed by *ue* and *oe* (*houc*, *souken*, and also *guet*, but usually *goet*, *soeken*, *boec*). The Saxon dialects still preserve an *o* sound which agrees with the Dutch *oe* (*bbk*, *mdder*); in two words—*romer* (*roemer*, however, is also used) and *spook*—*o* has passed from these dialects into Dutch. As the *u* (Old German *ū*), which in the Dutch tongue has passed into *ui* except before *r* and *w*, retains the *ū*-sound in the Saxon districts, some words have come into Dutch from these dialects, being written with *oe* from the

similar sound of *oe* (from *ū*) in Dutch and *ū* in Saxon (*swoet*, *boer*, *soezen*), by the side of which are Frankish words *swuit*, *swizen*, &c.). In the language of the people *oe* before *m* is often pronounced as *ō*, for instance *bloem* and *blom*.

Eu is not a diphthong, but the modification (*Umlaut*) of the clear *ō*; it has the same sound as German *ö* in *schön*; so in *vleugel*, *leugen*, *keuken*.

U before a double consonant or before a consonant in monosyllables has about the same pronunciation as in English stuff, rug; so in *kunnen*, *swurken*, *put*. When used in open syllables it has the same sound as in French *nature*.

In the 16th and 17th centuries, Middle Dutch *ū* passed over through *oi* into *ui* by the influence of the Holland dialect. In the Saxon districts *ū* kept the old pronunciation, but only in the language of the peasants. The common language has everywhere *ui*, pronounced nearly as German *eu*, English *oy*; so in *dutsend*, *swil*, *busen*, &c.

Ou and *au* in *wrouw* and *blauw* are nearly pronounced in the same way, very much like English *ow* in crowd.

AUTHORITIES.—For a full survey of a history of the Dutch language the reader is referred to Jan te Winkel, "Geschiede der nederländischen Sprache," *Grundriss der germ. Philologie*, 2, p. 704 (Strassburg, K. Grübner). Here an elaborate account may be found on p. 704 of the different works on the grammar and phonology of the various periods of the Dutch language. For explanation and history of words of the current language see the *Woordenboek der Nederlandsche Taal*, by De Vries and Te Winkel, continued by A. Kluyver, A. Beets, for a time by J. W. Muller and De Vries, who left at their nomination as professors at Utrecht and Ghent. The Middle Dutch language may be known from the *Middelnederlandsch Woordenboek*, first by E. Verwys and J. Verdam, after the death of Verwys by Verdam alone. For the dialects the different grammars and glossaries issued at Martinus Nyhoff (The Hague) and Kemink & Son (Utrecht) are of great importance. The Flemish dialect may be found in De Bo, *Westvlaamsch Idioticon*; other Belgian dialects are recorded in the publications of the *Vlaamsche Academie* (Ghent). Phonetic explanations are given in Roorda's or in ten Bruggenete's *Phonetic Works*, and a survey of the pronunciation in Branco van Dantzig's *Dutch Pronunciation* and Dykstra's *Dutch Grammar*.

(J. H. G.)

DUTCH LITERATURE. The languages now known as Dutch and Flemish did not begin to take distinct shape till about the end of the 11th century. From a few existing fragments—two incantations from the 8th century, a version of the Psalms from the 9th century, and several charters—a supposed Old Dutch language has been recognized; but Dutch literature actually commences in the 13th century, as Middle Dutch, the creation of the first national movement in Brabant, Flanders, Holland and Zealand.

From the wreck of Frankish anarchy no genuine folk-tales of Dutch antiquity have come down to us, and scarcely any echoes of German myth. On the other hand, the sagas of Charlemagne and Arthur appear immediately in Middle Dutch forms. These were evidently introduced by wandering minstrels and jongleurs, and translated

William
the
Minstrel.

to gratify the curiosity of the noble women. It is rarely that the name of such a translator has reached us, but we happen to know that the fragments we possess of the French romance of *William of Orange* were written in Dutch by a certain Klaas van Haarlem, between 1191 and 1217. The *Chanson de Roland* was translated about the same time, and considerably later *Parthenopeus de Blois*. The Flemish minstrel Diederick van Assenede completed his version of *Floris et Blanchefleur* about 1250. The Arthurian legends appear to have been brought to Flanders by some Flemish colonists in Wales, on their return to their mother-country. About 1250 a Brabantine minstrel translated Walter Map's *Lancelot du lac* at the command of his liege, Lodewijk van Velthem. The *Gauvain* was translated by Penninc and Vostaert before 1260, while the first original Dutch writer, the famous Jakob van Maerlant, occupied himself about 1260 with several romances dealing with Merlin and the Holy Grail. The earliest existing fragments of the epic of *Reynard the Fox* were written in Latin by Flemish priests, and about 1250 the first part of a very important version in Dutch was made by Willem the Minstrel, of whom it is unfortunate that we know no more save that he was the translator of a lost romance, *Madoc*. In his existing work the author follows Pierre de Saint-Cloud, but not slavishly; and he is the first really admirable writer that we meet with in Dutch literature. The second part was added by another hand at the end of the 14th century.

It is not necessary to dwell at any length on the monkish legends and the hymns to the Virgin Mary which were abundantly produced during the 13th century, and which, though destitute of all literary merit, were of use as exercises in the infancy of the language. The first lyrical writer of Holland was John I., duke of Brabant, who practised the *minnelied* with success, but whose songs are only known to us through a Swabian version of a few of them. In 1544 the earliest collection of Dutch folk-songs saw the light, and in this volume one or two romances of the 14th century are preserved, of which *Het Daghet in den Oosten* is the best known. Almost the earliest fragment of Dutch popular poetry, but of later time, is an historical ballad describing the murder of Count Floris V. in 1206. A very curious collection of mystical medieval hymns by Sister Hadewych, a nun of Brabant, was first printed in 1875 by Heremans and Ledeganck.

Hitherto, as we have seen, the Middle Dutch language had placed itself at the service of the aristocratic and monastic orders, flattering the traditions of chivalry and of religion, but scarcely finding anything to say to the bulk of the population. With the close of the 13th century a change came over the face of Dutch literature. The Flemish towns began to prosper and to assert their commercial supremacy over the North Sea. Under such mild rulers as William II. and Floris V., Dort, Amsterdam, and other cities contrived to win such privileges as amounted almost to political independence, and with this liberty there arose a new sort of literary expression. The founder and creator of this original Dutch literature was Jacob van Maerlant

(*q.v.*). His *Naturen Bloeme*, written about 1263, forms an epoch in Dutch literature; it is a collection of moral and satirical addresses to all classes of society. With his *Rijmbijbel* (Rhyming Bible) he foreshadowed the courage and free-thought of the Reformation. It was not until 1284 that he began his masterpiece, *De Spieghel Historiel* (The Mirror of History), at the command of Count Floris V. Of his disciples, the most considerable in South Holland was Jan van Boendale

(1280-1365), known as Jan de Klerk. He was born in Brabant, and became clerk to the justices at Utrecht in 1310. He was entrusted with various important missions. His works are historical and moral in character. In him the last trace of the old chivalric and romantic element has disappeared. He completed his famous rhyme chronicle, the *Brabantische Yeesen*, in 1350; it contains the history of Brabant down to that date, and was brought down to 1440 by an anonymous later writer. For English readers it is disappointing that Boendale's other great historical work (*Van den derden Ede-waert, coninc van Ingelant . . .*, ed. J. F. Willems, Ghent, 1840), an account of Edward III. and his expedition to Flanders in 1338, has survived only in some fragments. The remainder of Boendale's works are didactic poems, pursuing still further the moral thread first taken up by Maerlant, and founded on medieval scholastic literature. In Ypres the school of Maerlant was represented by Jan de Weert, a surgeon, who died in 1362, and

who was the author of two remarkable works of moral satire and exhortation, the *Nieuwe Doctrinael of Spieghel der Sonden*, and a *Disputacie van Rogier end van Janne*. In the beginning of the 13th century Gieljens van Molhem wrote a Dutch version of part of the *Miserere* of the Picard poet who concealed his identity under the name of the recluse of Moiliens. The poem consisted of meditations on the origin and destiny of man, and on the sins of pride, envy, &c. The translation, completed later by an author calling himself Heinrec, was critically edited (Groningen, 1893) by P. Leendertz. In North Holland a greater talent than that of Weert or of Boendale was exhibited

by Melis Stoke, a monk of Egmond, who wrote the history of the state of Holland to the year 1305; this work, the *Rijmchronik*, was printed in 1591, and edited in 1885 for the Utrecht Historical Society; and for its exactitude and minute detail it has proved of inestimable service to later historians.

With the middle of the 14th century the chivalric spirit came once more into fashion. A certain revival of the forms of feudal

life made its appearance under William III. and his successors. Knightly romances came once more into vogue, but the new-born didactic poetry contended vigorously against the supremacy of what was lyrical and epical. It will be seen that from the very first the literary spirit in Holland began to assert itself in a homely and utilitarian spirit. Jan van Heelu, a Brabanter, was the author of an epic poem¹ on the battle of Woeronc (1288), dedicated to Princess Margaret of England, and to him has been attributed the still finer romance of the *War of Grimbergen*.² Still more thoroughly aristocratic in feeling was Hein van Aken, a priest of Louvain, who lived about 1255-1330, and who combined to a very curious extent the romantic and didactic elements. As early as 1280 he had completed his translation³ of the *Roman de la rose*, which he must have commenced in the lifetime of Jean de Meung. More remarkable than any of his translated works, however, is his original romance, completed in 1318, *Heinric on Margriete van Limborch*,⁴ upon which he was at work for twenty-seven years. During the Bavarian period (1349-1433) very little original writing of much value was produced in Holland. Buedewijn van der Loren wrote one excellent piece on the Maid of Ghent, in 1389. Augustjinken van Dordt was a peripatetic minstrel of North Holland, who composed for the sheriff Aelbrecht and for the count of Blois from 1350 to 1370. Such of his verses as have been handed down to us are allegorical and moral. Willem van Hildegaersberch (1350-1408) was another northern poet, of a more strictly political cast. Many of his writings exist still unpublished, and are very rough in style and wanting in form. Towards the end of the 14th century an erotic poet of considerable power arose in the person of the lord of Waddinxveen and Hubrechtsambacht, Dirk Potter van der Loo (c. 1365-1428), who was secretary at the court of the counts of Holland. During an embassy in Rome (1411-1412) this eminent diplomatist made himself acquainted with the writings of Boccaccio, and commenced a vast poem on the course of love, *Der Minnen Loop*,⁵ which is a wonderful mixture of classical and Biblical instances of amorous adventures set in a framework of didactic philosophy. In Dirk Potter the last traces of the chivalric element died out of Dutch literature, and left poetry entirely in the hands of the school of Maerlant. Many early songs, with some of later date, are preserved in a *Liedekens-Boeck* printed by Jan Roulans (Antwerp, 1544). The unique copy in the Wollenbüttel library was edited by Hoffmann von Fallersleben in *Horae Belgicae* (vol. xi., 1855).

It is now time to consider the growth of prose literature in the Low Countries. The oldest pieces of Dutch prose now in existence are charters of the towns of Flanders and Zealand, dated 1209, 1251 and 1254. A prose translation of the Old Testament was made about 1300, and there exists a *Life of Jesus* about the same date. Of the mystical preachers whose religious writings have reached us, the Brussels friar, Jan van Ruysbroec (1294-1381), is the most important. But the most interesting relics of medieval Dutch prose, as far as the formation of the language is concerned, are the popular romances in which the romantic stories of the *trouvères* and minstrels were translated for the benefit of the unlettered public into simple language. As in most European nations, the religious drama takes a prominent place in every survey of medieval literature in Holland. Unfortunately the text of all the earliest mysteries, the language of which would have an extraordinary interest for us, has been lost. We possess records of dramas having been played at various places—*Our Lord's Resurrection*, at the Hague, in 1400; *Our Lady the Virgin*, at Arnheim, in 1452; and *The Three Kings*, at Delft, in 1498. The earliest existing fragment, however, is part of a *Limburg-Maastricht Passover Play*⁶ of about 1360. The latest Dutch miracle play was the *Mystery of the*

¹ Edited by J. F. Willems (Brussels, 1836).

² Edited by C. P. Serrure and Ph. Blommaert (Ghent, 1852-1854).

³ Edited by Dr E. Verwilt (Leiden, 1868).

⁴ Edited by L. P. C. v. den Bergh (Leiden, 1846-1847).

⁵ Edited by P. Leendertz (Leiden, 1845-1847).

⁶ Edited by Dr Jul. Zacher in *Haupt's Zeitschrift für deutsches Altertum*, vol. ii. (Leipzig, 1842).

Holy Sacrament, composed by a certain Smeken, at Breda, and performed on St John's day, 1500. This play was printed in 1867. With these purely theological dramas there were acted mundane farces, performed outside the churches by semi-religious companies; these curious moralities were known as "Ablespelen" and "Sotterniecn." In these pieces we discover the first traces of that genius for low comedy which was afterwards to take perfect form in the dramas of Brederô and the paintings of Teniers.

The theatrical companies just alluded to, "Gesellen van den Spele," formed the germ out of which developed the famous "Chambers of Rhetoric" which united within themselves all the literary movements that occupied the Low Countries during the 15th and 16th centuries.

The poets of Holland had already discovered in late mediæval times the value of guilds in promoting the arts and industrial handicrafts. The term "colleges de rhétorique" is supposed to have been introduced about 1440 to the courtiers of the Burgundian dynasty, but the institutions themselves existed long before. These literary guilds lasted till the end of the 16th century, and during the greater part of that time preserved a completely mediæval character, even when the influences of the Renaissance and the Reformation obliged them to modify in some degree their outward forms. They were in almost all cases absolutely middle-class in tone, and opposed to aristocratic ideas and tendencies in thought. Of these remarkable bodies the earliest were almost entirely engaged in preparing mysteries and miracle-plays for the populace. Each chamber, and in process of time every town in the Low Countries, possessed one, and took as its title some fanciful or heraldic sign. At Diest "The Eyes of Christ," dated from 1302, and an earlier one, the "Lily," is mentioned. "The Alpha and Omega," at Ypres, was founded about 1398; that of the "Violet," at Antwerp, followed in 1400; the "Book," at Brussels, in 1401; the "Berberry," at Courtrai, in 1427; the "Holy Ghost," at Bruges, in 1428; the "Floweret Jesse," at Middelburg, in 1430; the "Oak Tree," at Vlaardingen, in 1433; and the "Marigold," at Gouda, in 1437. The most celebrated of all the chambers, that of the "Eglantine" at Amsterdam, with its motto *In Liefde Bloeyende* (Blossoming in Love), was not instituted until 1496. Among the most influential chambers not above mentioned should be included the "Fountain" at Dort, the "Corn Flower" at the Hague, the "White Columbine" at Leiden, the "Blue Columbine" at Rotterdam, the "Red Rose" at Schiedam, the "Thistle" at Zierikzee, "Jesus with the Balsam" at Ghent, and the "Garland of Mary" at Brussels. And not in these important places only, but in almost every little town, the rhetoricians exerted their influence, mainly in what we may call a social direction. Their wealth was in most cases considerable, and it very soon became evident that no festival or procession could take place in a town unless the "Kamer" patronized it. Towards the end of the 15th century the Ghent chamber of "Jesus with the Balsam" began to exercise a sovereign power over the other Flemish chambers, which was emulated later on in Holland by the "Eglantine" at Amsterdam. But this official recognition proved of no consequence in literature, and it was not in Ghent, but in Antwerp, that intellectual life first began to stir. In Holland the burghers only formed the chambers, while in Flanders the representatives of the noble families were honorary members, and assisted with their money at the arrangement of ecclesiastical or political pageants. Their pompous *landjuweelen*, or tournaments of rhetoric, at which rich prizes were contended for, were the great occasions upon which the members of the chambers distinguished themselves. Between 1426 and 1620 at least 66 of these festivals were held. There was a specially splendid *landjuweel* at Antwerp in 1496, in which 28 chambers took part, but the gayest of all was that celebrated at Antwerp on the 3rd of August 1561. To this the "Book" at Brussels sent 340 members, all on horseback, and clad in crimson mantles. The town of Antwerp gave a ton of gold to be given in prizes, which were shared among 1893

¹ See Schotel, *Geschiedenis der Rederijvers in Nederland* (1862-1864, Amsterdam).

rhetoricians. This was the zenith of the splendour of the "Kamers van Rhetorica," and after this time they soon fell into disfavour. We can trace the progress of literary composition under the chambers, although none of their official productions has descended to us. Their dramatic pieces were certainly of a didactic cast, with a strong farcical flavour, and continued the tradition of Maerlant and his school. They very rarely dealt with historical or even Biblical personages, but entirely with allegorical and moral abstractions, until the age of humanism introduced upon the stage the names without much of the spirit of mythology. Of the pure farces of the rhetorical chambers we can speak with still more confidence, for some of them have come down to us, and among the authors famed for their skill in this sort of writing are named Cornelis Everaert of Bruges and Laurens Janssen of Haarlem. The material of these farces is extremely raw, consisting of rough jests at the expense of priests and foolish husbands, silly old men and their light wives. Laurens Janssen is also deserving of remembrance for a satire against the clergy, written in 1583. The chambers also encouraged the composition of songs, but with very little success; they produced no lyrical genius more considerable than Mattheus de Casteleyn (1488-1550), the founder of the Flemish chamber of "Pax Vobiscum" at Oudenarde, and author of *De Conste van Rhetorijcken* (Ghent, 1573), a personage whose influence as a fashioner of language would have been more healthy if his astounding metrical feats and harlequin *tours de force* had not been performed in a dialect debased with all the worst bastard phrases of the Burgundian period.

In the middle of the 16th century a group of rhetoricians in Brabant and Flanders attempted to put a little new life into the stereotyped forms of the preceding age by introducing *Houwaert*, in original composition the new-found branches of Latin and Greek poetry. The leader of these men was Jean Baptista Houwaert² (1533-1599), a personage of considerable political influence in his generation. Houwaert held the title of "Counsellor and Master in Ordinary of the Exchequer to the Duke of Brabant"; he played a prominent part in the revolution of the Low Countries against Spain; and when the prince of Orange entered Brussels victoriously (Sept. 23rd, 1577), Houwaert met him in pomp at the head of the two chambers of rhetoric—the "Book" and the "Garland of Mary." He did not remain faithful to his convictions, for he composed in 1593 a poem in honour of the cardinal-archduke Ernest of Austria, the governor of the Spanish Netherlands. He considered himself a devout disciple of Mattheus de Casteleyn, but his great characteristic was his unbounded love of classical and mythological fancy. His didactic poems are composed in a wonderfully roccoco style, and swarm with misplaced Latinities. In his bastard Burgundian tongue he boasted of having "poëtijck geïnventeert ende rhetorijckelijck ghecompoert" for the Brussels chamber such dramas as *Aeneas and Dido*, *Mars and Venus*, *Narcissus and Echo*, or *Leander and Hero*—named together the *Commerce of Amorosity* (1583). But of all his writings, *Pegasides Pleyn* (Antwerp, 1582-1583), or the *Palace of Maidens*, is the most remarkable; this is a didactic poem in sixteen books, dedicated to a discussion of the variety of earthly love. Houwaert's contemporaries nicknamed him "the Homer of Brabant"; later criticism has preferred to see in him an important link in that chain of homely didactic Dutch which ends in Cats. His writings are composed in a Burgundian so base that they hardly belong to Flemish literature at all. Into the same miserable dialect Cornelis van Ghistele of Antwerp translated, between 1555 and 1583, parts of Terence, Virgil, Horace, and Ovid, while the painter Karel van Mander (1547-1600) put a French version of the *Iliad* and of the *Eclouges* of Virgil into an equally ill-fitting Flemish dress. In no country of Europe did the humanism of the 16th century at first affect the national literature so slightly or to so little purpose.

The stir and revival of intellectual life that arrived with the Reformation found its first expression in the composition of

² For Houwaert, see a study by K. F. Stallaert in the *Nederlandsch Museum* (1885).

Psalms. The earliest printed collection appeared at Antwerp in 1540, under the title of *Souter-Liedekens*, and was dedicated to a Dutch nobleman, Willem van Zuylen van Nieuvelt, by whose name it is usually known. This collection, however, was made before the Reformation in Holland really set in. For the Protestant congregations

Jan Utenhove printed a volume of Psalms in London in 1566; Lucas de Heere (1534-1595), and immediately after him, with much greater success, Petrus Datheen (1531-1590), translated the hymns of Clément Marot. For printing this last volume, in 1567, Herman Schinkel of Delft was burned to death in 1568. Datheen was not a rhetorician, but a person of humble origin, who wrote in the vulgar tongue, and his hymns spread far and wide among the people. Until 1773 they were in constant use in the state church of Holland. But the great events of the period of reformation are not marked by psalms only in Dutch literature. Two collections of hymns and lyrical pieces, printed in 1562 and 1569, perpetuate the fervour and despair of the martyrs of the Mennonite Church. Similar utterances of the persecuted Protestants were published at Haarlem and Lecuwarden, at Ghent and at Bruges. Very different in tone were the battle-songs of liberty and triumph sung a generation later by the victorious Reformers, the "Geuzen" or "Gueux" (*q.v.*). The famous song-book of 1588, the

Battle-songs.

Geusen Liedren Boeckken, was full of ardent and heroic sentiment, expressed often in marvellously brilliant phrases. In this collection appeared for the first time such classical snatches of Dutch song as the Ballad of Heiligerlee, the Ballad of Egmond and Horn, and the song of the Storm of Leiden. The political ballads, with their ridicule of the Spanish leaders, form a section of the *Boeckken* which has proved of inestimable value to historians. All these lyrics, however, whether of victory or of martyrdom, are still very rough in form and language.

The first writer who used the Dutch tongue with grace and precision of style was a woman and a professed opponent of Lutheranism and reformed thought. Modern Dutch literature practically begins with Anna Bijns (*c.* 1494-1575). Against the crowd of rhetoricians and psalm-makers of the early part of the 16th century she stands out in relief as the one poet of real genius. The language, oscillating before her time between French and German, formless, corrupt and invertebrate, took shape and comeliness, which none of the male pedants could give it, from the impassioned hands of a woman. Anna Bijns, who is believed to have been born at Antwerp in 1494, was a schoolmistress at that city in her middle life, and in old age she still "instructed youth in the Catholic religion." She died on the 10th of April 1575. Hendrik Peppinck, a Franciscan, who edited her third volume of poems when she was an old woman in 1567, speaks of her as "a maiden small of descent, but great of understanding, and godly of life." Her first known volume bears the date 1528, and displays her as already deeply versed in the mysteries of religion. We gather from all this that she was a lay nun, and she certainly occupied a position of great honour and influence at Antwerp. She was named "the Sappho of Brabant" and the "Princess of all Rhetoricians." She bent the powerful weapon of her verse against the faith and character of Luther. In her volume of 1528 the Lutherans are scarcely mentioned; in that of 1538 every page is occupied with invectives against them; while the third volume of 1567 is the voice of one from whom her age has passed. All the poems of Anna Bijns which we possess are called *refereinen* or refrains.¹ Her mastery over verse-form was extremely remarkable, and these refrains are really modified chants-royal. The writings of Anna Bijns offer many points of interest to the philologist. In her the period of Middle Dutch closes, and the modern Dutch begins. In a few grammatical peculiarities—such as the formation of the genitive by some verbs which now govern the accusative, and the use of *gh* before the infinitive—her language still belongs to Middle Dutch; but these exceptions are rare, and she really initiated

that modern speech which Filips van Marnix adopted and made classical in the next generation.

In Filips van Marnix, lord of St Aldegonde (1538-1598), a much greater personage came forward in the ranks of liberty and reform. He was born at Brussels in 1538, and began life as a disciple of Calvin and Beza in the schools of Geneva.

It was as a defender of the Dutch iconoclasts that he first appeared in print, with his tract on *The Images thrown down in Holland in August 1566*. He soon became one of the leading spirits in the war of Dutch independence, the intimate friend of the prince of Orange, and the author of the glorious *Wilhelmuslied*. It was in the autumn of 1568 that Marnix composed this, the national hymn of Dutch liberty and Protestantism. In 1569 he completed a no less important and celebrated prose work, the *Biencorff* or Beehive of the Romish Church. In this satire he was inspired in a great measure by Rabelais, of whom he was an intelligent disciple. It is written in prose that may be said to mark an epoch in the language and literature of Holland. Overwhelmed with the press of public business, Marnix wrote little more until in 1580 he published his *Psalms of David newly translated out of the Hebrew Tongue*. He occupied the last years of his life in preparing a Dutch version of the Bible, translated direct from the original. At his death only Genesis was found completely revised; but in 1619 the synod of Dort placed the unfinished work in the hands of four divines, who completed it.

In Dirck Volckertsen Coornhert² (1522-1590) Holland for the first time produced a writer at once eager to compose in his native tongue and to employ the weapons of humanism. Coornhert was a typical burgher of North Holland, equally interested in the progress of national emancipation and in the development of national literature. He was a native of Amsterdam, but he did not take part in the labours of the old chamber of the Eglantine, but quite early in life proceeded to Haarlem, and was notary, secretary and finally pensionary of the town. In 1566 he was imprisoned for his support of the Reformers, and in 1572 he became secretary to the states of Holland. He practised the art of etching, and spent all his spare time in the pursuit of classical learning. He was nearly forty years of age before he made any practical use of his attainments. In 1561 he printed his translation of the *De officiis* of Cicero, and in 1562 of the *De beneficiis* of Seneca. In these volumes he opposed with no less zeal than Marnix had done the bastard forms still employed in prose by the rhetoricians of Flanders and Brabant. During the next decade he occupied himself chiefly with plays and poems, conceived and expressed with far less freedom than his prose, and more in the approved conventional fashion of the rhetoricians; he collected his poems in 1575. The next ten years he occupied in polemical writing, from the evangelical point of view, against the Calvinists. In 1585 he translated Boethius, and then gave his full attention to his original masterpiece, the *Zedekunst* (1586), or Art of Ethics, a philosophical treatise in prose, in which he studied to adapt the Dutch tongue to the grace and simplicity of Montaigne's French. His humanism unites the Bible, Plutarch and Marcus Aurelius in one grand system of ethics, and is expressed in a style remarkable for brightness and purity. He died at Gouda on the 20th of October 1590; his works, in three enormous folio volumes, were first collected in 1630.

Towards the end of the period of transition, Amsterdam became the centre of all literary enterprise in Holland. In 1585 two of the most important chambers of rhetoric in Flanders, the "White Lavender" and the "Fig Tree," took flight from the south, and settled themselves in Amsterdam by the side of the "Eglantine." The last-named institution had already observed the new tendency of the age, and was prepared to encourage intellectual reform of every kind, and its influence spread through Holland and Zealand. In Flanders, meanwhile, crushed under the yoke of Parma, literature and native thought absolutely expired. From this time forward, and until the emancipation of the

¹ For Coornhert see also J. ten Brink, *D. V. Coornhert en zijns wettewerk* (Amsterdam, 1860).

¹ Ed. Dr W. L. van Helten (1875).

southern provinces, the domain of our inquiry is confined to the district north of the Scheidst.

In the chamber of the Egplantine at Amsterdam two men took a very prominent place, more by their intelligence and modern spirit than by their original genius. Hendrick

Spiegel. Laurensen Spiegel (1540-1612) was a humanist of a type more advanced and less polemical than Coornhert. He wrote a charming poem in praise of dancing; but his chief contributions to literature were his *Tweespraak van de nederdysche letterkunst*, a philological exhortation, in the manner of Joachim du Bellay's famous tract, urging the Dutch nation to purify and enrich its tongue at the fountains of antiquity, and a didactic epic, entitled *Herfpijghel* (1614),¹ which has been greatly praised, but which is now much more antiquated in style and more difficult to enjoy than Coornhert's prose of a similar tendency. That Spiegel was a Catholic prevented him perhaps from exercising as much public influence as he exercised privately among his younger friends. The same may be said of the man who, in 1614, first collected Spiegel's writings, and published them in a volume with his own verses. Roemer Pietersen

*Visscher*² (1547-1620) proceeded a step further than Spiegel in the cultivation of polite letters. He was deeply tinged with a spirit of classical learning that was much more genuine and nearer to the true antique than any that had previously been known in Holland. His own disciples called him the Dutch Martial, but he was at best little more than an amateur in poetry, although an amateur whose function it was to perceive and encourage the genius of professional writers. Roemer Visscher stands at the threshold of the new Renaissance literature, himself practising the faded arts of the rhetoricians, but pointing by his counsel and his conversation to the naturalism of the great period.

It was in the salon at Amsterdam which the beautiful daughters of Roemer Visscher formed around their father and themselves that the new school began to take form. The republic of the United Provinces, with Amsterdam at its head, had suddenly risen to the first rank among the nations of Europe, and it was under the influence of so much new emotion and brilliant ambition that the country no less suddenly asserted itself in a great school of painting and poetry. The intellect of the whole Low Countries was concentrated in Holland and Zealand, while the six great universities, Leiden, Groningen, Utrecht, Amsterdam, Harderwijk and Franeker, were enriched by a flock of learned exiles from Flanders and Brabant. It had occurred, however, to Roemer Visscher only that the path of literary honour lay, not along the utilitarian road cut out by Maerlant and Boendale, but in the study of beauty and antiquity. In this he was curiously aided by the school of ripe and enthusiastic scholars who began to flourish at Leiden, such as Drusius, Vossius and Hugo Grotius, who themselves wrote little in Dutch, but who chastened the style of the rising generation by insisting on a pure and liberal Latinity. Out of that generation arose the greatest names in the literature of Holland—Vondel, Hooft, Cats, Huygens—in whose hands the language, so long left barbarous and neglected, took at once its highest finish and melody. By the side of this serious and aesthetic growth there is to be noticed a quickening of the broad and farcical humour which had been characteristic of the Dutch nation from its commencement. For fifty years, and these the most glorious in the annals of Holland, these two streams of influence, one towards beauty and melody, the other towards lively comedy, ran side by side, often in the same channel, and producing a rich harvest of great works. It was in the house of the daughters of Roemer Visscher that the tragedies of Vondel and the comedies of Bredero, the farces of Coster and the odes of Huygens, alike found their first admirers and their best critics.

Of the famous daughters of Roemer, two cultivated literature with marked success. Anna (1584-1651) was the author of

a descriptive and didactic poem, *De Roemster van den Aemstel* (The Glory of the Aemstel), and of various miscellaneous writings; Tesselshade (1594-1649) wrote some lyrics which still place her at the head of the female poets of Holland, and she translated the great poem of Tasso. They were women of universal accomplishment, graceful manners and singular beauty; and their company attracted to the house of Roemer Visscher all the most gifted youths of the time, several of whom were suitors, but in vain, for the hand of Anna or of Tesselshade.

Of this Amsterdam school, the first to emerge into public notice was Pieter Cornelissen Hooft (1581-1647). His *Achilles* and *Polyxena* (1598) displayed a precocious ease in the use of rhetorical artifices of style. In his pastoral drama of *Granida* (1605) he proved himself a pupil of Guarini. In tragedy he produced *Baeto* and *Geraad van Velsen*; in history he published in 1626 his *Life of Henry the Great*, while from 1628 to 1642 he was engaged upon his master-work, the *History of Holland*. Hooft desired to be a severe purist in style, and to a great extent he succeeded, but, like most of the writers of his age, he permitted himself too many Latinisms. In his poetry, especially in the lyrical and pastoral verse of his youth, he is full of Italian reminiscences both of style and matter; in his noble prose work he has set himself to be a disciple of Tacitus. Motley has spoken of Hooft as one of the greatest historians, not merely of Holland, but of Europe. His influence in purifying the language of his country, and in enlarging its sphere of experience, can hardly be overrated.

Very different from the long and prosperous career of Hooft was the brief, painful life of the greatest comic dramatist that Holland has produced. Gerbrand Adriaanssen Bredero³ (1585-1618), the son of an Amsterdam shoemaker, was born on the 16th of March 1585. He knew no Latin; he had no taste for humanism; he was a simple growth of the rich humour of the people. He entered the workshop of the painter Francisco Baedens, but accomplished little in art. His life was embittered by a hopeless love for Tesselshade, to whom he dedicated his dramas, and whose beauty he celebrated in a whole cycle of love songs. His ideas on the subject of drama were at first a mere development of the medieval "Abelspejen." The "Oude Kammer," one of the chambers of rhetoric, furnished an opening for his dramatic powers. He commenced by dramatizing the romance of *Roderick and Alphonsus*, in 1611, and *Griane* in 1612, but in the latter year he struck out a new and more characteristic path in his *Farce of the Cow*. From this time until his death he continued to pour out comedies, farces and romantic dramas, in all of which he displayed a coarse, rough genius not unlike that of Ben Jonson, whose immediate contemporary he was. His last and best piece was *Serolimo, the Spanish Brabantier*, a satire upon the exiles from the south who filled the halls of the Amsterdam chambers of rhetoric with their pompous speeches and preposterous Burgundian phraseology. The piece was based on a Dutch version (Delft, 1600) of an early Spanish picaresque romance, *La Vida de Lazarillo de Tormes* (Burgos, 1554). Bredero was closely allied in genius to the dramatists of the Shakespearian age, but he founded no school, and stands almost as a solitary figure in the literature of Holland. He died on the 23rd of August 1618. Theodore Rodenburg (d. 1644), ridiculed by Bredero for his pretentiousness, had a wider knowledge of contemporary foreign literature than the other dramatists. He adapted some of the dramas of Lope de Vega, which he had witnessed at Madrid, into Dutch, and in 1618 he adapted Cyril Tourneur's *Revenger's Tragedy*.

The only individual at all clearly connected with Bredero in talent was Dr Samuel Coster,⁴ who was born at Amsterdam on the 16th of September 1579. He studied medicine at Leiden, and practised at Amsterdam. He is chiefly remembered for

¹ See J. ten Brink, *G. A. Bredero* (Utrecht, 1899; 3rd ed. 1887-1888); also J. H. W. Unger, *Bredero, eine Bibliographie* (1884). His works were edited (3 vols., 1885-1890) by J. ten Brink and others.

² See R. A. Kollwijn's edition of *Samuel Coster's Werken* (1883).

³ The best edition is by P. Vlaming (Amsterdam, 1723).
⁴ On Visscher and his daughters see N. Beets, *Al de gedichten van Anna Roemers Visscher* (1881), and E. Gosse, *Studies in the Literature of Northern Europe* (1879).

having been the first to take advantage of the growing dissension in the body of the old chamber of the Eglantine to form a new institution. In 1617 Coster founded what he called the "First Dutch Academy." This was in fact a theatre, where, for the first time, dramas could be publicly acted under the patronage of no chamber of rhetoric. Coster himself had come before the world in 1612 with his farce of *Tenue is the Boor*, based on a folk-song in Jan Roulans's *Liedekens Boeckh*, and he continued this order of composition in direct emulation of Bredero, but with less talent. In 1615 he began a series of "blood-and-thunder" tragedies with his horrible *Ilyx*, and he continued this coarse style of tragic writing for several years. He survived at least until after 1648 as a supreme authority in Amsterdam upon all dramatic matters.

The first work of the greatest of all Dutch writers, Joost van den Vondel (1587-1679), was *Het Pascha* (1612), a tragedy or *Vondel* *tragi-comedy* on the exodus of the children of Israel, written, like all his succeeding dramas, on the recognized Dutch plan, in alexandrines, in five acts, and with choral interludes between the acts. There is comparatively little promise in *Het Pascha*. It was much inferior dramatically to the plays just being produced by Bredero, and metrically to the clear and eloquent tragedies and pastorals of Hooft; but it secured the young poet a position inferior only to theirs. Yet for a number of years he made no attempt to emphasize the impression he had produced on the public, but contented himself during the years that are the most fertile in a poet's life with translating and imitating portions of du Bartas's popular epic. The short and brilliant life of Bredero, his immediate contemporary and greatest rival, burned itself out in a succession of dramatic victories, and it was not until two years after the death of that great poet that Vondel appeared before the public with a second tragedy, the *Jerusalem laid Desolate*. Five years later, in 1625, he published what seemed an innocent study from the antique, his tragedy of *Palamedes, or Murdered Innocence*. All Amsterdam discovered, with smothered delight, that under the name of the hero was thinly concealed the figure of Barneveldt, whose execution in 1618 had been a triumph of the hated Calvinists. Thus, at the age of forty-one, the obscure Vondel became in a week the most famous writer in Holland. For the next twelve years, and till the accession of Prince Frederick Henry, Vondel had to maintain a hand-to-hand combat with the "Saints of Dort." This was the period of his most resolute and stinging satires; Cats took up the cudgels on behalf of the counter-Remonstrants, and there raged a war of pamphlets in verse. A purely fortuitous circumstance led to the next great triumph in Vondel's slowly developing career. The Dutch Academy, founded in 1617 almost wholly as a dramatic guild, had become so inadequately provided with stage accommodation that in 1638, having coalesced with the two chambers of the "Eglantine" and the "White Lavender," it ventured on the erection of a large public theatre, the first in Amsterdam. Vondel, as the greatest poet of the day, was invited to write a piece for the first night; on the 3rd of January 1638 the theatre was opened with the performance of a new tragedy out of early Dutch history, the famous *Cysbriecht van Aemstel*. The next ten years were rich in dramatic work from Vondel's hand; he supplied the theatre with heroic Scriptural pieces, of which the general reader will obtain the best idea if we point to the *Atahie* of Racine. In 1654, having already attained an age at which poetical production is usually discontinued by the most energetic of poets, he brought out the most exalted and sublime of all his works, the tragedy of *Lucifer*. Very late in life, through no fault of his own, financial ruin fell on the aged poet, and from 1658 to 1668—that is, from his seventieth to his eightieth year—this venerable and illustrious person, the main literary glory of Holland through her whole history, was forced to earn his bread as a common clerk in a bank, miserably paid, and accused of wasting his masters' time by the writing of verses. The city released him at last from this wretched bondage by a pension, and the wonderful old man went on writing odes and tragedies almost to his ninetieth year. He died

at last in 1679, of no disease, having outlived all his contemporaries and almost all his friends, but calm, sane and good-humoured to the last, serenely conscious of the legacy he left to a not too grateful country. Vondel is the typical example of Dutch intelligence and imagination at their highest development. Not merely is he to Holland all that Camoens is to Portugal and Mickiewicz to Poland, but he stands on a level with these men in the positive value of his writings.

Lyrical art was represented on its more spontaneous side by the songs and ballads of Jan Janssen Starter (b. 1594), an Englishman by birth, who was brought to Amsterdam in his thirteenth year. Very early in life he was made a member of the "Eglantine," and he worked beside Bredero for two years; but in 1614 he wandered away to Leeuwarden, in Friesland, where he founded a literary guild, and brought out, in 1618, his plays *Timbre de Cardone*, *Fenicie van Messine*, the subject of which is identical with that of Shakespeare's *Much Ado about Nothing*, and *Darvada*. But his great contribution to literature was his exquisite collection of lyrics, entitled the *Friesche Lusthof*, or Frisian Pleasance (1621). He returned to Amsterdam, but after 1625 we hear no more of him, and he is believed to have died as a soldier in Germany. The songs of Starter are in close relation to the lyrics of the English Elizabethans, and have the same exquisite simplicity and audacity of style.

While the genius of Holland clustered around the circle of Amsterdam, a school of scarcely less brilliance arose in Middelburg, the capital of Zeeland. The ruling spirit of this school was the famous Jakob Cats (1577-1660). In this voluminous writer, to whom modern criticism almost denies the name of poet, the genuine Dutch habit of thought, the utilitarian and didactic spirit which we have already observed in Houwaert and in Boendale, reached its zenith of fluency and popularity. During early middle life he produced the most important of his writings, his pastoral of *Galathea*, and his didactic poems, the *Maeckenplicht* and the *Sinne- en Minne-Beelden*. In 1624 he removed from Middelburg to Dort, where he soon after published his tedious ethical work called *Houwelick*, or Marriage; and this was followed from time to time by one after another of his monotonous moral pieces. Cats is an exceedingly dull and prosaic writer, whose alexandrines roll smoothly on without any power of riveting the attention or delighting the fancy. Yet his popularity with the middle classes in Holland has always been immense, and his influence extremely hurtful to the growth of all branches of literary art. Among the disciples of Cats, Jakob Westerbaen (1599-1670) was the most successful. His works included translations from Virgil, Ovid, Seneca, Terence and Juvenal, besides original poems. The Jesuit Adriaen Poirters (1606-1675) closely followed Cats in his remarkable *Masquer of the World*. A poet of Amsterdam, Jan Hermansz Krul (1602-1644), preferred to follow the southern fashion, and wrote didactic pieces in the Catsian manner.

A poet of dignified imagination and versatile form was Sir Constantijn Huygens (1596-1687), the diplomatist. He threw in his lot with the great school of Amsterdam, and became the intimate friend and companion of Vondel, Hooft and the daughters of Roemer Viisscher. His famous poem in praise of the Hague, *Balava Tempe*, appeared in 1622, and was, from a technical point of view, the most accomplished and elegant poem till that time produced in Holland. His collected poems, *Ottiorum libri sex*, were printed in 1625. *Oogentroost*, or Eye Consolation, was the fantastic title of a remarkable poem dedicated in 1647 to his blind friend, Lucretia van Trello. He printed in 1654 a topographical piece describing his own mansion, *Hofwijck*. Huygens represents the direction in which it would have been desirable that Dutch literature, now completely founded by Hooft and Vondel, should forthwith proceed, while Cats represents the tame and mundane spirit which was actually adopted by the nation. Huygens had little of the sweetness of Hooft or of the sublimity of Vondel, but his genius was eminently bright and vivacious, and he was a consummate

artist in metrical form. The Dutch language has never proved so light and supple in any hands as in his, and he attempted no class of writing, whether in prose or verse, that he did not adorn by his delicate taste and sound judgment. A blind admiration for John Donne, whose poems he translated, was the greatest fault of Huygens, who, in spite of his conceits, remains one of the most pleasing of Dutch writers. In addition to all this he comes down to us with the personal recommendation of having been "one of the most lovable men that ever lived."

Three Dutchmen of the 17th century distinguished themselves very prominently in the movement of learning and philosophic thought, but the illustrious names of Hugo Grotius (1583-1645) and of Baruch Spinoza (1632-1677) can scarcely be said to belong to Dutch literature. Balthasar Bekker (1634-1698), on the contrary, a Reformed preacher of Amsterdam, was a disciple of Descartes, who deserves to be remembered as the greatest philosophical writer who has used the Dutch language. His masterpiece, *Beloverde Wereld*, or the World Bewitched, appeared in 1691-1693. Bekker is popularly remembered most honourably by his determined attacks upon the system of a penal code for witchcraft.

From 1600 to 1650 was the blossoming time in Dutch literature. During this period the names of greatest genius were first made known to the public, and the vigour and grace of literary expression reached their highest development. It happened, however, that three men of particularly commanding talent survived to an extreme old age, and under the shadow of Vondel, Cats and Huygens there sprang up a new generation which sustained the great tradition until about 1680, when the final decline set in. Jan Vos (d. 1667) gained one illustrious success with his tragedy of *Aaron and Titus* in 1641, and lost still more in 1642 by his obscene farce of *Oene*.

His second tragedy of *Medea*, in 1665, and his collected poems in 1662, supported his position as the foremost pupil of Vondel. Geeraerd Brandt (1626-1685), the author of a *History of the Reformation* (4 vols., 1671-1704), deserves remembrance less as a tragic dramatist than as a consummate biographer, whose lives of Vondel and of De Ruyter are among the masterpieces of Dutch prose. Johan Antonides van der Goes (1647-1684) followed Vos as a skilful imitator of Vondel's tragical manner. His Chinese tragedies, *Trasil* (1665) and *Zungchin* (1666), scarcely gave promise of the brilliant force and fancy of his *Ysroom*, a poem in praise of Amsterdam, 1671. He died suddenly, in early life, leaving unfinished an epic poem on the life of St. Paul. Reyer Anso (1626-1669) marks the decline of taste and vigour; his once famous descriptive epic, *The Plague at Naples*, is singularly tame and roccoco in style. Joachim Oudaen (1628-1692) wrote in his youth two promising tragedies, *Johanna Gray* (1648) and *Konradyn* (1649). The Amsterdam section of the school of Cats produced Jeremias de Decker (1600-1666), author of *The Praise of Avarice*, a satirical poem in imitation of Erasmus, and Joannes Vollenhove (1631-1708), voluminous writer of didactic verse. The engraver Jan Luiken (1649-1708) published in 1671 a very remarkable volume of poems. In lyrical poetry Starter had a single disciple, Daniel Jonctijs (1600-1652), who published a volume of love songs in 1639 under the affected and untranslatable title of *Rooselijns ochtens ontdeed*. None of these poets, except in some slight degree Luiken, set before himself any more ambitious task than to repeat with skill the effects of his predecessors.

Meanwhile the romantic and voluminous romances of the French school of Scudéry and Honoré d'Urfé had invaded Holland and become fashionable. Johan van Heemskerck (1597-1656), a councillor of the Hague, set himself to reproduce this product in native form, and published in 1637 his *Batavian Arcadia*, the first original Dutch romance, in which a party of romantic youths journey from the Hague to Katwijk, and undergo all sorts of romantic adventures. This book was extremely popular, and was imitated by Hendrik

Hoemskerck.

Zoeteboom in his *Zaanlandsche Arcadia* (1658), and by Lambertus Bos in his *Dordtsche Arcadia* (1662). A far more spirited and original romance is the *Mirador* (1675) of Nikolaes Helmsius the younger (b. 1655), a book which resembles *Gil Blas*, and precedes it.

The drama fell into Gallicized hands at the death of Vondel and his immediate disciples. Lodewijk Meijer translated Corneille, and brought out his plays on the stage at Amsterdam, where he was manager of the national theatre or Schouwburg after Jan Vos. In connexion with Andries Pels (d. 1681), author of the tragedy of *Dido's Death*, Meijer constructed a dramatic club, entitled "Nil Volentibus Arduum," the great object of which was to inflict the French taste upon the public. Pels furthermore came forward as the censor of letters and satirist of barbarism in *Horace's Art of Poetry expounded*, in 1677, and in his *Use and Misuse of the Stage*, in 1681. Willem van Focquenbroch (1640-1679) was the most voluminous comic writer of this period. The close of the century saw the rise of two thoroughly Gallican dramatists, Jan van Paffenrode (d. 1673) and Pieter Bernagie (1656-1699), who may not unfairly be compared respectively to the Englishmen Farquhar and Shadwell. Thomas Asselijn (1630-1695) was a writer of more considerable talent and more homely instincts. He attempted to resist the dictatorship of Pels, and to follow the national tradition of Bredero. He is the creator of the characteristic Dutch type, the comic lover, Jan Klaassen, whom he presented on the stage in a series of ridiculous situations. Abraham Alewijn (b. 1664), author of *Jan Los* (1721), possessed a coarse vein of dramatic humour; he lived in Java, and his plays were produced in Batavia. Finally Pieter Langendijk, the author of a farce borrowed from *Don Quixote*, claims notice among the dramatists of this period, although he lived from 1683 to 1756, and properly belongs to the next century. With him the tradition of native comedy expired.

The Augustan period of poetry in Holland was even more blank and dull than in the other countries of northern Europe. Of the name preserved in the history of literature there are but very few that call for repetition here. Arnold Hoogvliet (1687-1763) wrote a passable poem in honour of the town of Vlaardingen, and a terrible Biblical epic, in the manner of Blackmore, on the history of Abraham. Hubert Cornelissen Poot (1689-1733) showed an unusual love of nature and freshness of observation in his descriptive pieces. Sybrand Feitama (1694-1758), who translated Voltaire's *Henriade* (1743), and wrote much dreary verse of the same class himself, is less worthy of notice than Dirk Smits (1702-1752), the mild and elegiac singer of Rotterdam. Tragic drama was more or less capably represented by Lucretia Wilhelmina van Merken (1722-1789), wife of the very dreary dramatist Nicolaas Simon van Winter (1718-1795).

In the midst of this complete dissolution of poetical style, a writer arose who revived an interest in literature, and gave to Dutch prose the classical grace of the 18th century. Justus van Effen (1684-1735) was born at Utrecht, fell into poverty early in life, and was thrown very much among the company of French émigrés, in connexion with whom he began literary life in 1713 by editing a French journal. Coming to London just when the *Tatler* and *Spectator* were in their first vogue, Van Effen studied Addison deeply, translated Swift and Defoe into French, and finally determined to transfer the beauties of English prose into his native language. It was not, however, until 1731, after having wasted the greater part of his life in writing French, that he began to publish his *Hollandsche Spectator*, which his death in 1735 soon brought to a close. Still, what he composed during the last four years of his life, in all its freshness, manliness and versatility, constitutes the most valuable legacy to Dutch literature that the middle of the 18th century left behind it.

The supremacy of the poetical clubs in every town produced a very weakening and Della-Cruscan effect upon literature, from which the first revolt was made by the famous brothers Van 't Saep Dr W. Bisshop, Justus van Effen . . . (Utrecht, 1899).

Gallican dramatists.

Decline of poetry.

Van Effen.

Haren,¹ so honourably known as diplomatists in the history of the Netherlands. Willem van Haren (1710-1768) wrote verses from his earliest youth, while Onno Zwier van Haren (1713-1770), strangely enough, did not begin to do so until he had passed middle life. They were friends of Voltaire, and they were both ambitious of success in epic writing, as understood in France at that period. Willem published in 1741 his *Gevallen van Friso*, a historical epos, and a long series of odes and solemn lyrical pieces. Onno, in a somewhat lighter strain, wrote *Piet and Agnietje, or Pandora's Box*, and a long series of tragedies in the manner of Voltaire.

Baroness de Lanney.

Juliana Cornelia de Lanney (1738-1782) was a writer of considerable talent, also of the school of Voltaire; her poems were highly esteemed by Bilderdijk, and she has a neatness of touch and clearness of penetration that give vivacity to her studies of social life. Jakobus Bellamy (1757-1786) was the son of a Swiss baker at Flushing; his pompous odes (*Gezangen myner Jeugd, 1782; Vaderlandsche Gezangen, 1782*) struck the final note of the false taste and Gallic pedantry that had deformed Dutch literature now for a century, and were for a short time excessively admired.

The year 1777 has been mentioned as the turning-point in the history of letters in the Netherlands. It was in that year that

The ladies Wolff and Deken.

Elizabeth (Betjen) Wolff* (1738-1804), a widow lady in Amsterdam, persuaded her friend Agatha (Aagjen) Deken (1741-1804), a poor but extremely intelligent governess, to throw up her situation and live with her.

For nearly thirty years these women continued together, writing in combination, and when the elder friend died on the 5th of November 1804, her companion survived her only nine days. Madam Wolff had appeared as a poetess so early as 1762, and again in 1769 and 1772, but her talent in verse was by no means very remarkable. But when the friends, in the third year of their association, published their *Letters on Divers Subjects*, it was plainly seen that in prose their talent was very remarkable indeed. Since the appearance of Heinsius's *Mivander* more than a century had passed without any fresh start in novel-writing being made in Holland. In 1782 the ladies Wolff and Deken, inspired partly by contemporary English writers, and partly by Goethe, published their first novel, *Sara Burgerhart*. In spite of the close and obvious following of Richardson, this was a masterly production, and it was enthusiastically received. Another novel, *Willem Leevend*, followed in 1785, and *Cornelia Wildschuw* in 1792. The ladies were residing in France at the breaking out of the Revolution, and they escaped the guillotine with difficulty. After this they wrote no more, having secured for themselves by their three unrivalled romances a place among the foremost writers of their country.

The last years of the 18th century were marked in Holland by a general revival of intellectual force. The romantic movement in Germany made itself deeply felt in all branches of Dutch literature, and German lyricism took the place hitherto held by French classicism. Pieter Nieuwland (1764-1794) was a feeble forerunner of the revival, but his short life and indifferent powers gave him no chance of directing the transition that he saw to be inevitable. One volume of poems appeared in 1788, and a second, posthumously, in 1797.

The real precursor and creator of a new epoch in letters was the famous Willem Bilderdijk (1756-1831) (q.v.). This remarkable man, whose force of character was even greater than his genius, impressed his personality on his generation so indelibly that to think of a Dutchman of the beginning of the 19th century is to think of Bilderdijk. In poetry his taste was strictly national and didactic; he began as a disciple of Cats, nor could he to the end of his life tolerate what he called "the puerilities of Shakespeare." His early love-songs, collected in 1781 and 1785, gave little promise of talent, but in his epic of *Elias* in 1786, he showed himself superior to all the Dutch poets since Huygens in mastery of form. For twenty years he lived a busy,

eventful life, writing great quantities of verse, and then commenced his most productive period with his didactic poem of *The Disease of the Learned*, in 1807; in 1808 he imitated Pope's *Essay on Man*, and published the tragedy of *Floris V.*, and in 1809 commenced the work which he designed to be his masterpiece, the epic of *De Ondergang der eerste Wereld* (The Destruction of the First World), which he never finished, and which appeared as a fragment in 1820. To the foreign student Bilderdijk is a singularly uninviting and unpleasing figure. He unites in himself all the unlovely and provincial features which deform the worst of his countrymen. He was violent, ignorant and dull; his view of art was confined to its declamatory and least beautiful side, and perhaps no writer of equal talent has shown so complete an absence of taste and tact. Ten Brink has summed up the character of Bilderdijk's writings in an excellent passage:—"As an artist," he says, "he can perhaps be best described in short as the cleverest versemaker of the 18th century. His admirable erudition, his power over language, more extended and more colossal than that of any of his predecessors, enabled him to write pithy and thoroughly original verses, although the general tone of his thought and expression never rose above the ceremonious, stogy and theatrical character of the 18th century." But in spite of his outrageous faults, and partly because these faults were the exaggeration of a marked national failing, Bilderdijk long enjoyed an unbroken and unbounded popularity in Holland. Fortunately, however, a sounder spirit has arisen in criticism, and the prestige of Bilderdijk is no longer preserved so religiously.

Bilderdijk's scorn for the dramas of Shakespeare was almost rivalled by that he felt for the new German poetry. Notwithstanding his opposition, however, the romantic fervour found its way into Holland, and first of all in the persons of Hieronymus van Alphen (1746-1803) and Pieter Leonard van de Kastiele (1748-1810), who amused themselves by composing funeral poems of the school of Gessner and Blair. Van Alphen at one time was extolled as a writer of verses for children, but neither in this nor in the elegiac line did he possess nearly so much talent as Rhiijnvis Feith (1753-1824), burgomaster of Zwolle, the very type of a prosperous and sentimental Dutchman. In his *Julia* (1783), a prose romance, Feith proved himself as completely the disciple of Goethe in *Werther* as Wolff and Deken had been of Richardson in *Sara Burgerhart*. In Johannes Kinker (1764-1845) a comic poet arose who, at the instigation of Bilderdijk, dedicated himself to the ridicule of Feith's sentimentalities. The same office was performed with more dignity and less vivacity by Baron W. E. van Perponcher (1741-1819), but Feith continued to hold the popular ear, and achieved an immense success with his poem *The Grave* in 1792. He then produced tragedies for a while, and in 1803 published *Antiquity*, a didactic epic. But his popularity waned before his death, and he was troubled by the mirth of such witty scoffers as Arend Fokke Simons (1755-1812), the disciple of Klopstock, and P. de Wacker van Zon (1758-1818), who, in a series of very readable novels issued under the pseudonym of Bruno Daalberg, sharply ridiculed the sentimental and funereal school.

Under the Batavian republic a historian of great genius arose in the person of Johannes Henricus van der Palm (1763-1840), whose brilliant and patriotic *Gedenkschrift van Nederlands Herstelling* (1816) has somewhat obscured his great fame as a politician and an Orientalist. The work commenced by Van der Palm in prose was continued in verse by Cornelis Loots (1765-1834) and Jan Frederik Helmers (1767-1813). Loots, in his *Balansans of the Time of Caesar* (1805), read his countrymen a lesson in patriotism, which Helmers far exceeded in originality and force by his *Dutch Nation* in 1812. Neither of these poets, however, had sufficient art to render their pieces classical, or, indeed, enough to protect them during their lifetime from the sneers of Bilderdijk. Other political writers, whose lyrical energies were stimulated by the struggle with France, were Maurits Cornelis van Hall (1768-1858), Samuel Iperusszoon Wiselius (1769-1845) and Jan ten Brink (1771-1839), the

¹ See Dr J. van Vloten, *Leven en werken van Willem en Onno van Haren* (1874), and Busken-Huet, *De van Haren's* (1875).

² See Dr J. van Vloten, *Elisabeth Wolff* . . . (1880).

Van der Palm.

Loots.

Halmers.

second of whom immortalized himself and won the favour of Bilderdijk by ridiculing the pretensions of such frivolous tragedians as Shakespeare and Schiller.

The healthy and national spirit in which the ladies Wolf and Deken had written was adopted with great spirit by a novelist in the next generation, Adriaan Loosjes (1761-1818), a bookseller at Haarlem. His romantic stories of medieval life, especially his *Charlotte van Bourbon*, are curiously like shadows cast forward by the Waverley Novels, but he has little of Sir Walter Scott's historical truth of vision. His production was incessant and his popularity great for many years, but he was conscious all through that he was at best but a disciple of the authoresses of *Sara Burgerhart*. Another disciple whose name should not be passed over is Maria Jacoba de Neufville (1775-1856), author of *Little Duties*, an excellent story somewhat in the manner of Mrs Opie.

A remarkable poet whose romantic genius strove to combine the power of Bilderdijk with the sweetness of Feith was Hendrik Tollens (1780-1856), whose verses have shown more vitality than those of most of his contemporaries. He struck out the admirable notion of celebrating the great deeds of Dutch history in a series of lyrical romances, many of which possess a lasting charm. Besides his folk-songs and popular ballads, he succeeded in a long descriptive poem, *A Winter in Nova Zembla*, 1819. He lacks the full accomplishment of a literary artist, but his inspiration was natural and abundant, and he thoroughly deserved the popularity with which his patriotic ballads were rewarded. Willem Messerschert (1790-1844), a friend and follower of Tollens, pushed the domestic and familiar tone of the latter to a still further point, especially in his genre poem of the *Golden Wedding*, 1825. Both these writers were natives and residents of Rotterdam, which also claims the honour of being the birthplace of

Adrianus Bogaers (1795-1870), the most considerable poetical figure of the time. Without the force and profusion of Bilderdijk, Bogaers has more truth to nature, more sweetness of imagination, and a more genuine gift of poetry than that clamorous writer, and is slowly taking a higher position in Dutch literature as Bilderdijk comes to take a lower one. Bogaers printed his famous poem *Jochebed* in 1835, but it had then been in existence more than thirteen years, so that it belongs to the second period of imaginative revival in Europe, and connects the name of its author with those of Byron and Heine. Still more beautiful was his *Voyage of Heemskerk to Gibraltar* (1836), in which he rose to the highest level of his genius. In 1846 he privately printed his *Romances and Ballads*. Bogaers had a great objection to publicity, and his reputation was long delayed by the secrecy with which he circulated his writings among a few intimate friends. A poet of considerable talent, whose powers were awakened by personal intercourse with Bogaers and Tollens, was Antoni Christiaan Winand Staring (1767-1840), who first at the age of fifty-three came before the world with a volume of *Poems*, but who continued to write till past his seventieth year. His amorous and humorous lyrics recall the best period of Dutch song, and are worthy to be named beside those of Starter and Vondel.

After 1830 Holland took a more prominent position in European thought than she could claim since the end of the 17th century.

In scientific and religious literature her men of letters showed themselves cognizant of the newest shades of opinion, and freely ventilated their ideas. The language resisted the pressure of German from the outside, and from within broke through its long stagnation and enriched itself, as a medium for literary expression, with a multitude of fresh and colloquial forms. At the same time, no very great genius arose in Holland in any branch of literature. The vast labours of Jakobus van Lennep (1802-1868) consist of innumerable translations, historical novels and national romances, which have gained for him the title of the leader of the Dutch romantic school.

The novels of Sir Walter Scott had a great influence on Dutch literature, and the period was rich in historical novels. J. van

der Hage (1806-1854), who wrote under the pseudonym of Jan Frederick Oltmans, was the author of the famous novels, *Castle Loovenstein in 1570* (1834), and *The Shepherd* (1838), both dealing with the national history. Other popular works were the antique romance *Charibles and Euphorion* (1831) of Petrus van Limburg-Brouwer (1795-1847), author of a history of Greek mythology; the *Meisjesvrouw Leclere* (1840), and the *Portretten van Joost van den Vondel* (1876) of the literary historian and critic J. A. Alberdingk Thijm (1820-1890); the *Jan Paessen* (1856) of Lodewijk Mulder (b. 1822); and the *Lucretia d'Este* of W. P. Walters (1827-1891). Johannes Kneppelhout (1814-1885) sketched university life at Leiden in two amusing volumes of *Studententypen* (1841) and *Studentenleven* (1844). Reinier Cornelis Bakhuizen van den Brink (1810-1865) was the chief critic of the romantic movement, and Everhard Johannes Potgieter (1808-1875) its mystical philosopher and esoteric lyrical poet. The genius and influence of Potgieter were very considerable, but they were exceeded by the gifts of Nicolaes Beets (q.v.), author of the famous *Camera Obscura* (1836), a masterpiece of humour and character. Johannes Pieter Hasebroek (1812-1896), who has been called the Dutch Charles Lamb, wrote in 1840 an admirable collection of essays entitled *Truth and Dreams*. Willem Hofdijk (1816-1888) wrote a collection of ballads, *Kennemerland* (1849-1852), and a series of epic and dramatic poems in the romantic style. Bernard ter Haar (1806-1881), an Amsterdam pastor and, in the last year of his life, a professor at Utrecht, made a reputation as a poet by his *Johannes and Theagenes, a legend of apostolic times* (1838). His poems were collected in 1866 and 1879. A poet of unusual power and promise was lost in the early death of Pieter Augustus de Genestet (1803-1861). His *Ese of Saint Nicholas* appeared in 1849, and was followed by two volumes of verse in 1851 and 1861, the second of which contains some poems that have attained great popularity. Among the poets should not be forgotten two writers of verse for children, Jan Pieter Heije (1809-1876) and J. J. A. Gouverneur (1809-1886). Criticism was represented by W. J. A. Jonckbloet (1817-1885), author of an excellent *History of Dutch Literature* (1868-1870), C. Busken Huet, and Jan ten Brink (1834-1901), author of a great number of valuable works on literary history, notably of a history of Dutch literature (1897), and a series of biographies of 19th century Dutch writers (new edition, 1902). His novels were collected in 13 volumes in 1885. With Isaak da Costa (q.v.), W. J. van Zeggelen (1811-1879), and J. J. L. Ten Kate (q.v.), the domestic tendency of Cats and Bilderdijk overpowered the influence of romanticism. The romantic drama found its best exponent in H. J. Schimmel (q.v.), who found a disciple in D. F. van Heyst (b. 1831), whose *George van Lalaing* was produced in 1873. Hugo Beijerman (ps. Glanor) produced a good play in his *Uitgeen* (1873), which was followed by other successes. Rosier Faassen (b. 1833) published his dramatic works in 1883.

The recent literature of Holland presents the interesting phenomenon of an aesthetic revolution, carefully and cleverly planned, crowned with unanticipated success, and dying away in a languor encouraged by the complete absence of organized resistance. It would perhaps be difficult to point to another European example so well defined of the vicissitudes which keep the history of literature varied and fresh. For the thirty or forty years preceding 1880 the course of *belles-lettres* in Holland was smooth and even sluggish. The Dutch writers had slipped into a conventionality of treatment and a strict limitation of form from which even the most striking talents among them could scarcely escape. In 1880 the most eminent authors of this early period were ready to pass away, and they appeared to be preparing no successors to take their place. The greatest humorist of Holland, Nicolaas Beets, had drawn his works together. The most interesting novelist, Mrs Gertrude Bosboom-Toussaint, had in her last psychological studies shown an unexpected sympathy with new ideas. M. G. L. van Loghem (b. 1849), known under the pseudonym of "Fiore delle Neve," made a great success by his *Zen tiefde in het Zuiden* (1881), followed in 1882 by *Liana*, and in

19th century in literature.

Recent developments.

1884 by *Van een Sultane*. Among the novelists were Gerard Keller (b. 1829), author of *From Home* (1867); Johan Gram (b. 1833), of whose novels *De Familie Schaffels* (1870) is the best known; Hendrik de Veer (1829-1890), author of *Frans Holster* (1871); Justus van Maurik (b. 1846), who wrote plays and short sketches of Amsterdam life (*Uit het Volk*, 1879), and Arnold Buning (b. 1846), whose *Marinus Sketches* (1880) won great popularity. The colonial novels of N. Marie C. Slood, born in Java in 1853, are widely read in Holland and Belgium, and many of them have been translated into German. A number of them were collected (Schiedam, 1900-1902) as *Romanistische Werken*. Adèle Opzoomer (b. 1856; pseud. A. C. S. Wallis) made her first success in 1877 with *In Days of Strife*. The two leading Dutch men of letters, however, besides Beets and Douwes Dekker, were critics, Conrad Busken-Huet (q.v.) and Carel Vosmaer (q.v.). In Huet the principles of the 1840-1880 period were summed up; he had been during all those years the fearless and trusty watch-dog of Dutch letters, as he understood them. He lived just long enough to become aware that a revolution was approaching, not to comprehend its character; but his accomplished fidelity to literary principle and his wide knowledge have been honoured even by the most bitter of the younger school. Vosmaer, although in certain directions more sympathetic than Huet, and himself an innovator, has not escaped so easily, because he has been charged with want of courage in accepting what he knew to be inevitable.

In November 1881 there died a youth named Jacques Perk (1860-1881), who had done no more than publish a few sonnets in the *Spectator*, a journal published by Vosmaer. He was no sooner dead, however, than his posthumous poems, and in particular a cycle of sonnets called *Mathilde*, were published (1882), and awakened extraordinary emotion. Perk had rejected all the formulas of rhetorical poetry, and had broken up the conventional rhythms. There had been heard no music like his in Holland for two hundred years. A group of young men, united in a sort of esoteric adoration of the memory of Perk, collected around his name. They joined to their band a man somewhat older than themselves, Marcellus Emants (born 1848), poet, novelist and dramatist, who had come forward in 1879 with a symbolical poem called *Lilith*, which had been stigmatized as audacious and meaningless; encouraged by the admiration of his juniors, Emants published in 1881 a treatise on *Young Holland*, in the form of a novel in which the first open attack was made on the old school. The next appearance was that of Willem Kloos (born 1857), who had been the editor and intimate friend of Perk, and who now undertook to lead the army of rebellion. His violent attacks on recognized authority in aesthetics began in 1882, and created a considerable scandal. For some time, however, the new poets and critics found a great difficulty in being heard, since all the channels of periodical literature were closed to them. But in 1883 Emants expressed his intellectual aspirations in his poem *The Twilight of the Gods*, and in 1884 the young school founded a review, *De Nieuwe Gids*, which was able to offer a direct challenge to *De Gids*, the ultra-respectable Dutch quarterly. In this year a new element was introduced: hitherto the influences of the young Dutch poetry had chiefly come from England; they were those of Shelley, Mrs Browning, the Rossetis. In 1884 Frans Netscher began to imitate with avidity the French naturalists. For some time, then, the new Dutch literature became a sort of mixture of Shelley and Zola, very violent, heady and bewildering. In 1885 the *Persephone* and other Poems of Albert Verwey (b. 1865) introduced a lyrical poet of real merit to Holland; Emants published his novel *Goudakker's Illusions*. This was the great flowering moment of the new school. It was at this juncture that the principal recent writer of Holland, Louis Couperus (b. 1863), made his first definite appearance. Born in the Hague, the opening years of his boyhood were spent in Java, and he had preserved in all his nature a certain tropical magnificence. In 1884 a little volume of lyrics, and in 1886 the more important *Orchids*, showed in Couperus a poet whose sympathies were at first entirely with the new school. But he was destined to be

a novelist, and his earliest story, *Elise Vere* (1889), already took him out of the ranks of his contemporaries. In 1890 he published *Destiny* (known as *Footsteps of Fate* in the English version), and in 1892 *Ecstasy*. This was followed in 1894 by *Majesty*, in 1896 by *World-wide Peace*, in 1898 by *Metamorphosis*, a delicate study of character, in 1899 by *Fidessa*, in 1901 by *Quiet Force*, and in 1902 by the first volume of a tetralogy called *The Books of Small Souls*. Of all these later books, some of which have been translated into English, by Couperus, it is perhaps *Ecstasy* in which the peculiar quality of his work is seen at present to the greatest advantage. This is an extreme sensitiveness to psychological phenomena, expressed in terms of singular delicacy and beauty. The talent of Couperus is like a rich but simple tropical flower laden with colour and odour. He separated himself, as he developed, from the more fanatical members of the group, and addressed himself to the wider public. Another writer, of a totally different class, resembling Couperus only in his defiance of the ruling system of aesthetics, is the prominent Ultramontane politician and bishop, E. J. A. M. Schaeppmann (born 1844), whose poem of *Aja Sofa* originally appeared in 1886. Recent novelists of some polemical vigour are H. Borel and van Hulzen. A very delightful talent was revealed by Frederick van Eeden in *Little Johnny* (1887), a prose fairy-tale; in *Ellen* (1891), a cycle of mysterious and musical elegies; and in *From the Cold Pools of Death* (1901), a very melancholy novel. Another poet of less refinement of spirit, but even greater sumptuousness of form, appeared in Helène Swarth-Lapidoth (born 1859), whose *Pictures and Voices* belongs to 1887. In that year also, in which Dutch literature reached its height of fecundity, was published the powerful and scandalous naturalistic novel, *A Lene*, by L. van Deyssel (K. J. L. Alberdingk Thijm) who had hitherto been known chiefly as a most uncompromising critic. After 1887 the condition of modern Dutch literature remained comparatively stationary, and within the last decade of the 19th century was definitely declining. In 1889, it is true, a new poet Herman Gorter, made his appearance with a volume of strange verses called *May*, eccentric both in prosody and in treatment. He held his own without any marked advance towards lucidity or variety. Since the recognition of Gorter, however, no really remarkable talent has made itself prominent in Dutch poetry, unless we except P. C. Boutens, whose *Verses* in 1898 were received with great respect. Willem Kloos, still the acute and somewhat turbulent leader of the school, collected his poems in 1894 and his critical essays in 1896. L. van Deyssel, though an effective reviewer, continued to lack the erudition which years should have brought to him. Gorter remained tenebrous, Helène Swarth-Lapidoth still gorgeous; the others, with the exception of Couperus, showed symptoms of sinking into silence. The entire school, now that the struggle for recognition is over, and its members are accepted as little classics and the tyrants of taste, rests on its triumphs and seems to limit itself to a repetition of its old experiments. The leading dramatist of the close of the century was Hermann Heijermans (b. 1864), a Jew of strong realistic and socialistic tendencies, and the author of innumerable gloomy plays. His *Ghetto* (1898) and *Ora et Labora* (1901) particularly display his peculiar talent. Other notable products of drama are those of de Koo, whose *Tobias Bolderman* (1900) and *Vier Ton* (1901) are effective comedies. Dutch literature presented features of remarkable interest between 1882 and 1888, but since that time the general heightening of the average of merit, the abandonment of the old dry conventions, and a recognition of the artistic value of words and forms, are more evident to a foreign observer than any very important single expression of the national genius in literary art. An exception should be made in favour of the powerful peasant-stories of Steijn Streuvels (Frank Lateur), a young baker by trade, whose *Summer Land* (1901) was a most promising production.

AUTHORITIES.—Dr W. J. A. Jonckbloet, *Geschiedenis der Nederlandsche Letterkunde* (4th ed., 1889-1892); Dr J. ten Brink, *Kleinse Geschiedenis der Nederlandschen Letteren* (Haarlem, 1877); and the same author's *Geschiedenis der Nederlandsche Letterkunde* (1897), with elaborate illustrations, facsimiles of MSS. and title pages, &c.;

Dr J. van Vloten, *Schets van de Geschiedenis der Nederlandschen Letteren* (1879); L. Schneider, *Geschichte der niederländischen Literatur* (Leipzig, 1887); G. Kalf, *Literatuur en tooneel te Amsterdam in de zeventiende eeuw* (Haarlem, 1895).

Interesting observations on the development of the new school in Dutch literature will be found in Willem Kloos, *Veertien Jaar Literatuur-Geschiedenis* (2 vols., 1880-1896), and in L. van Deyssel, *Verzamelde Opstellen* (4 vols., 1890-1897), and in the series of monographs and bibliographies by Prof. J. ten Brink, *Geschiedenis der Noord-Nederlandsche Letteren in de XIX^e Eeuw* (Rotterdam, new ed. 1902, &c.). (E. G.)

DUTCH WARS, a convenient general title for a series of European wars between 1652 and 1678, which centred chiefly upon the political and commercial relations of the Netherlands with England and France. By Englishmen the term "Dutch Wars" is usually applied to the two purely naval wars of 1652-53 and 1663-67 and to the Anglo-Dutch or naval part of the war that began in 1672. But the last of these was part of a much wider struggle by land, known to Continental historians as the Dutch War of 1672-78, and the second part of this article deals with their struggle on the various frontiers of France, which was illustrated by the genius of Turenne and Condé.

I. NAVAL OPERATIONS

First Dutch War (1652-53).—Though political causes were at work, the main incentive to hostility between the peoples was commercial rivalry. It was therefore natural that their first encounters should have taken place between fleets engaged in conveying trade, or in endeavouring to intercept the trade of their enemy. Blows were exchanged before war was formally declared. On the 12th of May 1652 an English officer, Captain Young, stopped a Dutch convoy near the Start in order to enforce the salute to the English flag, which England then demanded from all who used the seas round her coast. The demand was resisted, and was only yielded to after a sharp conflict. Though the Dutch were still endeavouring to negotiate a peace with the Council of State which governed in the British Isles after the execution of King Charles I., they made ready for war. In May forty sail of their war-ships appeared off Dover under command of Martin Harpertzoon Tromp—then the best known of their admirals. There were then 8 British ships in Dover under Rear-Admiral Nicholas Bourne, and 15 near Rye under Robert Blake, a member of parliament, and soldier who had gained a great reputation in the Civil War. Blake came into the Straits of Dover with his ships, and on the 10th of May a sharp collision took place between him and Tromp. Bourne joined his countryman after the action began. The encounter, which the Dutch attributed to the English, and the English to the Dutch, made war inevitable, even if the relations of the two powers had allowed of the maintenance of peace. The first operations on both sides took the form of attacks on trade. Sir George Ayscue, who had lately returned from the West Indies, whither he had been sent to subdue the Royalist party in Barbados, had a sharp encounter with a Dutch convoy while on his way up Channel to the Downs, and had captured several prizes. The Council of State, being mainly anxious to destroy the Dutch trade and fisheries, began by reinforcing Blake, and sending him north to scatter the Dutch herring fleet. He had with him 60 vessels. Ayscue remained in the Downs with 16. Soon after Blake had gone, Tromp appeared in the Downs with a stronger force and threatened an attack on Ayscue. Want of wind prevented the operation. Tromp was also most intent on collecting the home-coming Dutch convoys, and seeing them safe into port. He therefore also sailed north to meet the Baltic trade. No meeting, however, took place between him and Blake, while bad weather scattered the Dutch. Their herring fishery was ruined for the year, and the outcry against Tromp was loud. He was notoriously no friend to the Loewenstein party then prevalent in Holland, and was displaced, his place being taken by Cornelius de Witt and Michiel Adriaansoon de Ruyter. De Ruyter was sent into the Channel to convoy the outward-bound convoys, and meet the home-coming trade. On the 16th of August he had an encounter off Plymouth with Ayscue, whom he worsted, and then cruised at the Land's End. The failure of Ayscue, who

was not employed again in this war, induced the Council of State to send Blake, who had now returned from the north, into the Channel. He was not, however, more successful. His fleet was allowed to become scattered, and the Dutchman brought his convoy back safe after a partial action with Penn, Blake's subordinate, on the 16th of August.

So far the operations had been confined to commerce destroying, or to the protection of trade by convoy. The next moves were more purely warlike. In the 27th of September the Dutch appeared in force off the mouth of the Thames, and Blake, whose fleet was collected in the Downs, stood to sea. On the 28th of September the first real battle of the war was fought off the Kentish Knock, a shoal opposite the coast of Essex. The English fleet standing to the north passed to west of the Dutch, and then turned. In the close engagement which followed, the Dutch were defeated. They did not fight well, and their failure was attributed in part to the discontent of their seamen with the removal of Tromp, and the unpopularity of de Witt. The states-general found it necessary to replace Tromp, who was at once sent to sea, again with the charge of seeing the outward-bound trade down Channel, and waiting for the homeward-bound. Blake had not remained on the coast of Holland, for the Council of State was still almost as intent as the Dutch on conveying trade or molesting the enemy's. It brought its fleet back, and then divided the ships, sending some to the north with Penn, and keeping the others, 40 in all, with Blake in the Downs. Thus when Tromp appeared "at the back of the Goodwins" with a fleet of 80 war-ships and a crowd of merchant vessels on the 20th of November, Blake was not in a position to engage him with any assured prospect of success. But he made the attempt, and a hot engagement took place off Dungeness on the 30th. Two English vessels were taken, and the loss would have been greater if some of the English captains had not shown themselves backward. Many of the ships were merchant vessels pressed or hired, and commanded by their own skippers, who displayed little military spirit. Blake, who offered to resign, complained of the conduct of many of them, and some were punished. The Council of State saw the necessity for making a strong effort against Tromp, who ranged the Channel unopposed. Penn was recalled from the north, Richard Deane and George Moak were united with Blake as "admirals and generals at sea," and a competent force was collected by the middle of February. The legend (for it is nothing more) that Tromp hoisted a broom at his mainmast-head to announce his intention to sweep the English off the sea, refers to this period.

On the 13th of February 1653 the Dutch admiral, who had now collected the homeward-bound convoys, was off Plymouth on his way back to Holland, and was attacked by the English fleet. The encounter, which lasted from the 18th to the 20th of February and ranged from Plymouth to Calais, is commonly named the "Three Days' Battle" and was described by Clarendon as "stupendous." The Dutch admiral brought his charge of merchant ships up Channel between him and the French shore. His war-ships were arranged in what was called a half-moon, and was in fact an obtuse angle with his flagship, the "Brederode," at the apex. During the 18th and 19th, the attacks of the English though fierce were partial, and met with no great success. Tromp had to complain of the conduct of several of his captains. On the 20th his line was broken and some 60 of his merchant ships were captured. He anchored in some confusion in Calais roads. Yet by taking advantage of the dark, and the turn of the tide, he succeeded in carrying the great majority of his merchant ships home. The English fleet had suffered severely, Blake himself was seriously wounded, and his colleague Deane was also hurt. Blake's wound disabled him greatly through the remainder of the war.

The Three Days' Battle was followed by a pause in the war. On the English side much damage had to be repaired. The administration of the navy, called upon as it was to deal with a war of unprecedented magnitude, was overtaxed by the obligation to refit ships, raise crews, and provide for the numerous sick or wounded. The close approach of the great political

crisis in which Cromwell expelled the Long Parliament and established the Protectorate (17th of April 1653), may have had some influence. The fleet adhered to the new government on the 22nd of April. On the Dutch side much damage had to be repaired, and their complicated administration, by five independent admiralty boards, rendered rapid work impossible. They had also begun to realize that the quality of their ships was inferior. Reflection had further shown them that to hamper their fleets by imposing the direct protection of a great flock of merchant ships on them was not even an effectual way to protect commerce. When, therefore, Tromp was next sent to sea, it was with an unhampered fleet of war-ships, and for the purpose of bringing the English fleet to battle.

In spite of their heavy losses and their awkward administration, the Dutch were at sea before the end of May, and were close to the mouth of the Thames. The English fleet was not all ready. Part was in the river fitting out under Blake, who had not fully recovered from his wound. The bulk of it was, however, ready for service, and Blake's colleagues, Monk and Deane, attacked Tromp on the 2nd of June. Changes of wind made the battle somewhat confused. At first the English were to windward and they bore down with Rear-Admiral John Lawson in command of the van. Tromp, conscious that his ships were weaker in build, at first drew away, firing at the spars of the English ships in order to cripple them. A shift of the wind having given him the weather-gage, he concentrated a vigorous attack on Lawson. But the wind changed again and transferred the weather-gage to the English. Monk and Deane brought on a general action, in which the Dutch were outmatched, and forced to retreat to their own coast. Deane was slain by a cannon-shot by the side of his colleague Monk, who threw his cloak over the mangled body. Blake, informed by the sound of the cannon, which was audible on the Thames, that an action was in progress, hurried to sea and joined Monk in the pursuit of the Dutch on the 3rd of June. Tromp was driven into port and told the states-general that they must build better ships if they wished to beat the English at sea. Blake was forced by his still unhealed wound to go ashore, and the sole command was left to Monk, who remained cruising on the coast of Holland. The states-general now sought for peace, but Cromwell's demands were excessive, and could not be accepted without a surrender of the independence of Holland. A last effort was therefore made to regain the command of the sea. A great fleet was fitted out, partly at Flushing, partly in the Texel. Between the 26th and the 30th of July Tromp, by a series of skilful manœuvres, united the divided Dutch squadrons in the face of Monk's fleet, and on the 30th he stood out to sea with the wind in his favour, and gave battle. More than a hundred vessels were engaged on either side. The Dutch admiral manœuvred to keep, and Monk to gain, the weather-gage. The fleets passed on opposite tacks, and the Dutch tried to destroy their enemy with fire-ships without success. At last the weatherly qualities of the ships enabled Monk to break through the Dutch line, cutting some of their ships off from the others. The vessels thus cut off fled to the Maas, and Tromp with the others retired to the Texel. He was shot dead by a musket bullet in the retreat. The loss of life had been heavy on both sides. Six captains of Monk's fleet were slain. The Dutch now sought peace, and Cromwell offered better terms. During the fighting in the North Sea the Mediterranean trade of England had suffered severely. A squadron of trading ships and a few war vessels were blocked in Italian ports till some of them were taken and others forced to flee in March 1653 off Leghorn. The battle of the 31st of July was the last serious operation of the war, though peace was not formally made till some months later.

Second Dutch War (1663-67).—Although the formal declaration of war was not made by the government of King Charles II. till March 1665, the operations of the second Dutch War began in October 1663. The king and his brother the duke of York (James II.), who were largely interested in the slave-trading Guinea Company, were eager to remove the Dutch ports from the slave coast. They knew that war with the Republic, which had recovered very rapidly from the disasters of the war of 1652-53,

would be popular with the trading classes in England. They relied also on the known reluctance of the Dutch government to go to war. In October 1663, therefore, a squadron was sent out under command of Sir Robert Holmes to attack the Dutch in Gambia and America. Their posts on the African coast were captured and New Amsterdam (now New York) taken. The states-general under the skilful management of the Grand Pensionary, John de Witt, retaliated by sending de Ruyter to the Mediterranean, where he was cruising against the Barbary pirates, to follow Holmes. De Ruyter re-established the Dutch posts in Gambia, and, though he failed to retake New Amsterdam, did much injury to English trade before he returned to Holland. It may be pointed out that all colonial settlements belonged at that time exclusively to England, and the war was made entirely by her, and in her interest, Scotland and Ireland having no share. Numbers of Scotch sailors and of English deserters served in the Dutch fleet in this war—the bad administration of the navy and the constant ill-treatment of the crews having caused bitter discontent. Other attacks were made on Dutch trade during 1664, but the great operations of war did not begin till May 1665. In that month the duke of York was on the east coast of England with a fleet of 80 to 90 sail, composed, according to the custom of the time, of vessels of all sizes. A Dutch fleet of corresponding strength was sent to sea, under command of Baron Opdam van Wassenaer. In this war we do not find that the movements of fleets were subordinated to the work of providing convoy. They were sent to sea for the much more intelligent purpose of seeking out the enemy and driving him off. It was understood that the trade of the victor would be secure.

The first battle took place from 30 to 40 m. S.E. of Lowestoft, on the 3rd of June 1665. By the bad conduct of some of the captains in the centre of the Dutch line, the English, who fought with much spirit, were able to win a considerable victory. Opdam's flagship was blown up and he perished. But the pursuit of the English fleet was feeble, and the retreat of the Dutch was ably covered by Cornelius van Tromp, son of Martin Tromp. Much scandal was caused by the mysterious circumstances in which an order to shorten sail was given in the English flagship, and doubts were expressed of the courage of the duke of York. He withdrew, or was withdrawn, from the active command at sea, and was replaced by the earl of Sandwich. On the Dutch side vigorous measures were taken to enforce good discipline. Four of the captains who had misbehaved on the 3rd of June were shot for cowardice, and others were dismissed. De Ruyter was named commander-in-chief, and John de Witt, or later his brother Cornelius, accompanied the admiral as delegate of the states-general to support his authority. The earl of Sandwich did nothing becoming a capable commander. Under his command the fleet made no attempt to blockade the Dutch coast, but was turned from its proper work to engage in a prize-hunting plot with the king of Denmark. The object was to plunder a Dutch convoy which had taken refuge at Bergen in Norway, then united to Denmark. The mutual interest of the associates led to the failure of the plot. Sir Thomas Teddeman, who was sent by Sandwich to attack the Dutch at Bergen, was suspected by the Danish governor of intending to play false, was fired on by the batteries, and was beaten off. De Ruyter covered the return of the trade to Holland. Sandwich, who had taken some prizes, unlawfully seized part of their cargoes for the benefit of himself and the other flag officers. A loud outcry was raised in the fleet and the country. Sandwich was displaced, and his command was transferred to Monk, with whom was associated the king's cousin, Prince Rupert. The war had so far been unsuccessful for England. The victory of the 3rd of June was barren. Great injury was inflicted on English trade by Dutch cruisers, while the wasteful administration of his officers reduced the king's treasury to much embarrassment. Winter suspended the movements of the fleets.

The year 1666 (called the *annus mirabilis*, for it included the plague and the fire of London) was marked by fierce fighting and changes of fortune. The French, who had signed a treaty with Holland in 1662, were reluctantly induced to intervene in

the war as the enemies of England. By May a Dutch fleet of some eighty sail was at sea, preparing to watch the English, and unite with the French. Monk and Rupert were fitting out a fleet of nearly the same strength in the Thames. Under the influence of their fear of a French naval force King Charles's ministers committed a great blunder. They detached Prince Rupert into the Channel with 20 ships, leaving Monk with only 57 to face the Dutch. The English commander put to sea, and found the enemy anchored on the coast of Flanders, in three divisions. He boldly attacked the van, hoping to cripple it before it could be helped by the centre and rear. This daring and well-judged move brought on the Four Days' Battle of the 1st, 2nd, 3rd and 4th of June (O.S.). On the 1st the Dutch van, under Cornelius van Tromp, bore the brunt of the English attack. The fighting was very fierce. One English admiral, Sir William Berkeley, was slain, and another, Sir John Harman, was in great danger. Monk drew off at night without doing all the harm he had wished to the Dutch. During the 2nd of June the fleets engaged again, and on this day the self-will of Van Tromp, who commanded the rear in the battle, and the misconduct of some of the ships in the van, prevented De Ruyter from making full use of his numbers. Yet Monk was clearly overtaxed, and on the 3rd he prepared to retreat to the Thames. During this movement the "Prince" (100) carrying the flag of Admiral Sir Robert Ayscue, ran on the Galloper Sand, and was lost. In the evening Prince Rupert returned, and by hugging the coast of Kent to the south of the fleets, was able to rejoin his colleague. Monk and Rupert renewed the battle on the 4th. It was fought with extreme fury, and terminated in the retreat of the English to the Thames with a loss of 20 ships and 6000 men.

The Dutch remained masters of the approach to the Thames till the 21st of July. They menaced the coast of Essex, and could easily have covered an invasion of England by a French army if Louis XIV. had been disposed to send one. Danger stimulated the English government to active exertions, and by the 21st of July Monk and Rupert were enabled by a happy combination of wind and tide to set to sea through the passage called the Swin. A storm which scattered both fleets delayed their meeting till the 25th of July. On that and the two succeeding days the Dutch were again defeated and driven into port. The English fleet then burnt the Dutch East India Company's dockyard at Terschelling, inflicting great loss. But the fruits of the victory were less than they would have been if it had been properly followed up. The British fleet withdrew to its own coast and within a month De Ruyter was at sea again, hoping to effect a junction with a French squadron. The French failed to keep tryst, and De Ruyter was watched by Rupert, who was now in sole command, Monk having been recalled to London to take command amid the confusion caused by the fire and the plague. Nor did the failure of King Charles's government to press the war with vigour end here. Embarrassed by want of money, on bad terms with his parliament, and secretly intent on schemes incompatible with a policy which could earn the approval of his subjects, the king preferred to spend what money he could command on raising troops, and neglected his fleet. Peace negotiations were begun with the Dutch, and the line-of-battle ships were put out of commission. A light squadron was, however, kept at sea to injure the Dutch trade, and as no armistice was arranged the Republic was free to continue warlike operations. The Dutch, being well aware of the disarmed condition of the English coast, sent out a powerful fleet again under the command of De Ruyter in June. It entered the Thames, forced the entrance of the Medway, and burnt both the dockyard at Chatham and a number of the finest ships in the navy which were lying in the river. A terrible panic prevailed in London, where an attack was expected. The Dutch were content with the injury they had done at Chatham, and dropped down the river. De Ruyter remained cruising in the Channel till the peace of Breda was signed in July. During the last months of the war Sir John Harman had fought a successful campaign in the West Indies against the French on whom he inflicted a severe defeat at Martinique

on the 24th of June. By the terms of the peace England retained possession of New York, but the war, though it contained some passages glorious to her arms, was very disastrous to her commerce.

Third Dutch War (1672-74).—This war differed very materially in its inception and conduct from the first and second. They had been popular in England, and even the second gave Englishmen not a little to be proud of. The third was undertaken by the king in pursuit of a policy arranged between him and his cousin Louis XIV. Their avowed object was a partition of Holland, but there was a secret understanding that King Charles II. was to establish Roman Catholicism, and to make himself despotic in England, with the help of the French king. This hidden purpose was suspected, and the war became intensely unpopular with the English parliament and nation. Parliament would grant the king no supplies, and he could find the means of fitting out a fleet only by defrauding his creditors. The English fleets were, therefore, comparatively small, were ill-provided and had to co-operate with French squadrons which in the then raw state of King Louis' young navy, proved inefficient allies.

In this as in former wars, attacks on Dutch commerce preceded a formal declaration of hostilities. On the 13th of March 1672 Sir Robert Holmes fell upon a Dutch convoy under the command of Van Ness in the Channel. In the penalty of the dockyards Holmes could not be provided with the force he was promised, and the enterprise was but partially successful. It was characteristic of the morality of his time and the spirit of the English navy as it had been shaped by the corrupt government of Charles II., that the officers concerned quarrelled violently and accused one another of fraud. A fleet of 60 sail was with difficulty got together under the duke of York, who now went to sea for the second time. The duke was joined in May, and at Portsmouth, by 40 French ships under the comte d'Estrées, a soldier and noble who had been made an admiral late in life. The allies entered the North Sea but did not take the offensive against the Dutch. The English were ill supplied, and were compelled to anchor at Southwold Bay on the coast of Suffolk in order to obtain water and provisions. The Dutch, who had to contend with an overwhelming French invasion on shore, nevertheless fitted out a fleet of 70 to 80 sail of the line and the command was given to De Ruyter. On the 28th of May 1672 he fell upon the allies in a N.W. wind. D'Estrées, who was stationed with his squadron at the south end of the line, went to sea on the port tack, heading to the S.E. The English, who constituted the centre and rear, stood out on the starboard tack. Thus the allies were at once divided into two widely separated bodies, and the Dutch admiral was able to concentrate nearly his whole force on the centre division, which suffered severely. The flagship of the duke of York, the "Prince" (100), was so shattered that he was compelled to leave her, and go to the "St Michael." The "Royal James" (100), the flagship of his second in command, the earl of Sandwich, after being much shattered by the Dutch artillery, was set alight by a fire-ship, and destroyed with enormous loss of life. The earl himself perished. His body was picked up three days afterwards, so disfigured that it was only recognized by the star on his coat. The ships at the head of the English line at last tacked to the support of the centre, and at evening De Ruyter drew off. A foolish attempt was made to claim his retreat as a victory, but the allies were too severely damaged to attempt an attack on the Dutch during the rest of the year. The Republic was so hard pressed by the French invasion that it had to land the gunpowder from its ships for the service of its army.

In 1673 the allies made an effort to invade Holland from the sea coast. Prince Rupert replaced the duke of York, who as a Roman Catholic was driven from office by the newly passed Test Act. He was supplied with 54 ships and was joined early in the year by d'Estrées with 27. Soldiers were embarked, and in May the allied fleet stood over to the Dutch coast. The distress of the Republic prevented it from equipping more than 55 ships, but the patriotism of the race was roused to white heat, and in

De Ruyter they possessed an admiral of consummate skill and heroic character. He took up an anchorage at Schooneveld and stood on his guard. On the 28th of May Rupert and d'Estrées, believing that De Ruyter was too much afraid of their superior numbers to venture to sea, sent in a squadron of light vessels and fire-ships to attack him, but he took the offensive at once, scattering the light squadron, and falling with energy on the rest of the fleet, which, not being in expectation of a vigorous assault, was taken at a disadvantage. On this occasion the English placed the French in the centre, in order to avoid such a separation as had taken place in the battle at Southwold Bay. But the disposition made no difference in the result. De Ruyter concentrated on the van and centre of the allies, and in spite of his great inferiority of numbers was able to be superior at the point of attack. The allies were compelled to retreat, and De Ruyter, satisfied with having averted the invasion of his country, anchored at West-Kappel.

Seven days later, on the 4th of June, a second encounter took place. The French were now placed in the rear of the line as it engaged. The Dutch admiral, who had the advantage of the wind, fell on the English in the van and centre. His inferiority in numbers did not allow him to push his attack quite home, but he inflicted so much injury that the allies were forced to return to the Thames to refit. At the end of July the allies again appeared off the coast of Holland, bringing four thousand soldiers in the war-ships and two thousand in transports. De Ruyter's fleet had been raised to 70 vessels, but the allies had also been reinforced and were 90 strong. On the 11th of August the Dutch admiral kept in the shallow waters of the coast looking for a favourable opportunity to attack. On the 11th of August the wind, which had been westerly, turned to the S.E., giving him the weather gage. The French division was leading, and De Ruyter fell furiously upon the English in the centre and rear. The French were kept in play by a small squadron under Bankert, while De Ruyter drove Prince Rupert in the centre out of the line, and in the rear Cornelius van Tromp fought a desperate duel with the English rear division commanded by Sir E. Spragge. The two admirals engaged in a species of personal conflict, and each was compelled to shift his flag to another vessel. While Sir E. Spragge, whose second flagship was shattered by the Dutch fire, was on his way to a third, his boat was sunk by a cannon shot and he was drowned.

The defeat of the allies was undeniable, and a violent quarrel broke out between them. Want of money, and the increasing violence of popular opposition to the French alliance, compelled the king to withdraw from the war. Peace was made in the following spring.

In this war, which presented no features of a creditable kind, the loss to English commerce from Dutch cruisers was so great that it was found necessary to suspend the clause of the navigation act which forbade the purchase of foreign-built vessels.

As England withdrew from her alliance with Louis XIV., the other powers of Europe, frightened by the growth of the aggressive French power, began to come forward to the support of Holland. The coalition then formed continued the struggle till 1678. But the war was conducted mainly on the land. The French king, who knew that his fleet was not as yet capable of meeting the Dutch single-handed, was content to withdraw his ships from the North Sea and the ocean. The Dutch, who had to pay subsidies to their German allies, and to support a large army, could spare little for their fleet. For some time they willingly confined themselves to efforts to protect their commerce from French privateers. In 1674 a revolt of the people of Sicily against their Spanish rulers gave the French king an opportunity of seizing the island. Spain, unable to defend its possession single-handed, appealed to the Dutch for naval help. In September 1675 De Ruyter was sent into the Mediterranean with 18 sail of the line and four fire-ships. The force was inadequate, but it was all that Holland could spare. The Dutch admiral, who was hampered rather than helped by his Spanish allies, did his best to make good his weakness by skilful management. He cruised off Messina to intercept the supplies which were being brought to the

French garrison by a fleet of 20 sail under the command of Abraham Duquesne. Conscious that he must spare his small force as much as possible, he abstained from such vigorous attacks as he had made in 1672 and 1673. When Duquesne appeared on the 7th of January 1676 near the Lipari Islands, De Ruyter allowed them to get the weather-gage, and on the 8th of January waited passively for their attack. The French, with more recklessness than was usual with them in later times, bore down on their enemy courageously but in some disorder. Their leading ships were severely mauled, and their whole force so crippled that they could make no pursuit of the Dutch when they drew off, their injured ships being towed by the Spanish galleys, in the late afternoon. Duquesne was able to reach Messina and join the French ships at anchor there. De Ruyter made his way to Palermo, which was in the hands of the Spaniards. One of his vessels sank on the way and he was reduced to 17. It is true that his allies provided him with 10 ships of their own, but the Spanish navy had sunk to abject inefficiency. Their commander, the marquis of Bayona, arrogantly insisted on occupying the centre of the line with his worthless squadron instead of allowing his ships to be scattered among the Dutch for support. When on the 22nd of April the allies, 27 strong, met the fleet of Duquesne, 20 ships, off Agosta, they attacked from windward. De Ruyter, who led the van, was mortally wounded. The Spaniards in the centre behaved very ill, and no victory was gained. The serious fighting was, in fact, confined to the vans of the two fleets. After the battle the allies retired to Syracuse, where De Ruyter died, and where their ships were mostly destroyed by the French a month later. Reinforcements sent out from Holland were stopped in the Straits of Gibraltar and blockaded in Cadiz. The French remained masters of the Mediterranean. In the meantime, however, angry disputes had arisen between France and England. King Louis XIV. enforced his belligerent rights at sea with as much disregard of neutral interests as was shown by England in later times. His naval officers insisted on making prize of all Dutch-built vessels found under the English flag. In 1678 war seemed imminent between France and England. King Louis then withdrew his soldiers from Sicily, and made the peace of Nijmegen.

AUTHORITIES.—For the English side, see *Naval History of England*, by Thomas Lediard (London, 1735); *Memorials of Sir W. Penn*, by Grenville Penn (London, 1833); *The First Dutch War, 1652-1654*, edited by S. R. Gardiner for the Navy Record Society (1899). For the Dutch side: *Het Leven van Bedrjck van den Hoere Michiel de Ruiter*, by Gerard Brandt (Amsterdam, 1687); *Geschiedenis van den Nederlandsche Zeevegen*, by J. C. de Jongke (Haarlem, 1858); *Annales des Provinces-Unies*, by J. Bannages de Beauval (The Hague, 1726). For the French side: *Abraham du Quesne et la marine de son temps*, by A. Jal (Paris, 1873). For the small Spanish share: *Armada Española*, by Captain Cesareo Fernandez Duro (Madrid, 1895-1901). For critical studies of these wars the reader may be referred to *Naval Warfare*, by Rear-admiral P. H. Colomb (London, 1899), and *The Influence of Sea Power upon History*, by Captain A. T. Mahan. (D. H.)

II. OPERATIONS ON LAND

The contemporary military history of Europe included, first, the war between France and Spain, 1654-59, usually called the Spanish Fronde, of which the most notable incident was the great battle of the Dunes fought on the 14th of June 1658 between the French and English under Turenne and the Spaniards under Condé, in which a contingent of Cromwell's soldiers bore a conspicuous part. About the same time a war was fought in northern Europe (1655-60), celebrated chiefly for the three days' battle of Warsaw (28th, 29th, 30th July 1656), and the successful invasion of Denmark by the Swedes, carried out from island to island over the frozen sea (February 1658), and culminating in a long siege of Copenhagen (1658-59). Between the second and third wars of England and the United Provinces came the short War of Devolution (1667-68)—a war of sieges in the Low Countries in which the French were commanded chiefly by Turenne. In 1668 the French under Condé made a rapid conquest of Franche-Comté. This was, however, given up at the peace. The war of 1672-78, the first of the three great wars of Louis XIV., was fought on a grander scale.

Invasion of Holland, 1672.—The diplomacy of Louis had, before the outbreak of war, deprived Holland of her allies—England (treaty of Dover, 1670), Sweden (treaty of Stockholm, 1672) and the emperor, and when he declared war on the United Provinces in March 1672, it seemed that the Dutch could offer little resistance. The French army under Louis in person started from Charleroi and marched down the Meuse unopposed. The powerful Dutch fortress of Maastricht was masked, and the French then moved towards Düsseldorf. In the electorate of Cologne they were in friendly company, and the main army soon moved down the Rhine from Düsseldorf, the corps of Turenne on the left bank, that of Condé on the right. At the same time a corps under Marshal Luxemburg, composed of Louis' German allies (Cologne and Münster) moved from Westphalia towards Over-Yssel and Groningen. The Rhine fortresses offered but little resistance to the advance of Turenne and Condé. William of Orange with a weak field army tried to defend the Yssel-Rhine line, but the French rapidly forced the passage of the Rhine at Tollhuis (June 12th) and passed into the Betuwe (between the Leck and the Waal). Condé now advised a cavalry raid on Amsterdam, but Louis, acting on the suggestion of the war minister Louvois, preferred to reduce Nijmegen, Gorinchem and other places, before entering Utrecht province. Condé's plan was, however, partially carried out by Count Rochefort, who with 1800 troopers captured successively Amersfoort and Naarden. His further progress was checked at Muiden, which the Dutch garrisoned in the nick of time, and he returned to the main army, taking Utrecht *en route*. Louis now moved on Amsterdam, brushing aside the feeble opposition which was offered, and it seemed that the French must achieve their object in one short campaign. But the Dutch people were roused. The month before, the citizens of Utrecht had refused to raze their suburban villas, and defence of the fortifications had consequently been impossible. Now, the dykes were cut and the sluices opened, and Amsterdam was covered by a wide inundation, against which the invader was powerless. At the same time the men of Zealand repulsed a French raid from Ath on Ardenburg, and this infraction of the neutrality of the Spanish Netherlands served but to raise up another enemy for Louis. Luxemburg too, at first successful, was repulsed before Groningen. A revolution placed William of Orange at the head of the government. The alliance of Brandenburg and the Mainz electorate had already been secured, and Spain, justly fearing for the safety of her Flemish possessions, soon joined them. The emperor followed, and Louis was now opposed, not by one state, but by a formidable coalition.

War against the Coalition.—In the autumn the war spread to the Rhine. No attempt could be made on Amsterdam until the ice should cover the floods. Turenne was therefore despatched to Westphalia and Condé to Alsace, while a corps of observation was formed on the Meuse to watch the Spanish Netherlands. But the coalition had not yet developed its full strength, and Turenne's skill checked the advance of the Imperialists under Montecucculi and of the Brandenburgers under the Great Elector. A war of manœuvre on the middle Rhine ended in favour of the French, and the allies then turned against the territories of Cologne and Münster, while William, disappointed in his hopes of joining forces with his friends, made a bold, but in the end unsuccessful, raid on Charleroi (September-December 1672). The allies in Germany were now not merely checked but driven from point to point by Turenne, who on this occasion displayed a degree of energy rare in the military history of the period. The troops of Cologne and Münster formed part of his army, other friends of Louis were preparing to take the field, and after a severe winter campaign, the elector, defeated in combat and manœuvre, was forced back to the Weser, and being but weakly supported by the Imperialists, found himself compelled to make a separate peace (June 6th, 1673). Turenne then turned his attention to the Imperialists who were assembling in Bohemia, and made ready to meet them at Wetzlar. Meanwhile the other French armies were fully employed. Corps of observation were formed in Roussillon and Lorraine. Condé in Holland was to

renew his efforts against the Amsterdam defences; during the winter the demands of the war on the Rhine had reduced the French forces in the provinces to the size of a mere army of occupation.¹ Louis' own army, originally collected for the relief of Charleroi in December, advanced on Maastricht, and after a brief siege, in which Vauban directed the besiegers, captured this most important fortress (June 20th, 1673). But this was the last success of the French armies in the campaign. Condé made no headway against Amsterdam, and William retook Naarden (September 14th). Louis, after the capture of Maastricht led his army southwards into Lorraine and overran the electorate of Trier. But nothing of importance was gained, and Turenne's summer campaign was wholly unsuccessful.

Capture of Bonn.—From Wetzlar he moved to Aschaffenburg, Louis at the same time keeping back, for the intended conquest of Franche-Comté, many soldiers who would have been more usefully employed in Germany. Soon the Imperialists advanced in earnest, greatly superior in numbers. Marching via Eger and Nuremberg (September 3rd) on the Main, Montecucculi drew Turenne to the valley of the Tauber; then, having persuaded the bishop of Würzburg to surrender the bridge of that place, he passed to the right bank of the Main before Turenne could intervene. The Imperialists soon arrived at Frankfurt, and the French position was turned. Montecucculi thus achieved one of the greatest objects of the 17th century strategist, the wearing down of the enemy in repeated and useless marches. The French retreat to the Rhine was painful and costly, and Montecucculi then passed that river at Mainz and made for Trier. Turenne followed, unable to do more than conform to his opponent's movements, and took post to defend Trier and Alsace. Thereupon Montecucculi turned northward to meet William of Orange, who evaded Condé's weak army and marched rapidly via Venló (22nd October) on Coblenz. The elector of Trier, who had not forgotten the depredations of Louis' army in the spring, followed the example of the bishop of Würzburg and gave a free passage at Coblenz. William and Montecucculi joined forces in the electorate and promptly besieged Bonn. This fortress fell on the 12th of November, and the troops of the coalition gained possession of an unbroken line from Amsterdam to the Breisgau, while Louis' German allies (Cologne and Münster), now isolated, had to make peace at once. William wintered in Holland, Montecucculi in Cologne and Jülich, and the Spaniards, who had served with William, in their own provinces of the Meuse. A century after the outbreak of the War of Independence the Dutch and the Spaniards are thus found making war as allies, a striking proof of the fact that all questions but those of dynastic interests had been effectually settled by the peace of Westphalia. Louis' allies were leaving him one by one. The German princes and the empire itself rallied to the emperor, Denmark joined the coalition (January 1674), the Great Elector re-entered the war, and soon afterwards England made peace.

1674.—In 1674 therefore Louis reluctantly evacuated those of the United Provinces occupied by his army. He had derived a considerable revenue from the enemy's country, and he had moreover quartered his troops without expense. The resources of the French government were almost intact for the coming campaign; the corps of observation in Roussillon was continued, and its commander, Marshal Schomberg, made a successful campaign against the Spaniards, and the war was carried even into Sicily. Condé, in the Spanish Low Countries, opposed with inferior forces the united army of Spaniards, Dutch and Austrians under William, and held the Meuse from Grave to Charleroi on the Sambre. The war in this quarter was memorable for Condé's last, and William's first, battle, the desperate and indecisive engagement of Senefé (August 11th), in which the two armies lost one-seventh of their strength in killed alone. The

¹ Marshal Luxemburg, who was left in command of the army in Holland during the winter of 1672-73, had indeed made a bold attempt to capture Leiden and the Hague by marching a corps from Utrecht across the frozen inundations. But a sudden thaw imperilled his force and he had to make a painful retreat along the dykes to Utrecht. Holland was again inundated in 1673.

French, however, in the course of the year lost a few fortresses on the Meuse, including Grave and Huy. The king's part in the campaign was, as usual, a war of sieges; an army under his personal command overran Franche-Comté in six weeks, and Louis, aided by the genius of Vauban, reduced Besançon in nine days. Turenne's Rhine campaign began with an invasion of Germany, undertaken to prevent interference with Louis in Franche-Comté. Bournonville, the imperial commander who now replaced Montecucculi, lay in the Cologne and Trier electorates. An army of South Germans in the Breisgau, after an unsuccessful attempt to invade Alsace, moved northward to the Neckar valley with the intention of uniting with Bournonville, who was moving up the Rhine to meet them. Turenne determined to attack the southern army under the duke of Lorraine and Count Caprara before the junction could be effected. He crossed the Rhine at Philipsburg early in June, and on the 16th fell upon the inferior forces of Caprara in their entrenched position of Sinsheim. The result of the battle was a complete victory for the French, who followed up their success by draining a portion of Bournonville's army (on which the duke of Lorraine had rallied his forces) from the Neckar (action of Ladenburg near Heidelberg, July 7th). Turenne then laid waste the Palatinate, in order that it should no longer support an army, and fell back over the Rhine, ignoring the reproaches of the elector palatine, who vainly challenged him to a duel. This devastation has usually been considered as a grave stain on the character of the commander who ordered it, but Turenne's conception of duty did not differ in this respect from that of Cromwell, Marlborough, Wellington and the generals of the American Civil War. It was held to be necessary and expedient, and it was accordingly carried out. Bournonville's army near Frankfurt was still to be dealt with, and the Great Elector and his Brandenburgers were rapidly approaching the Main valley. After a slight attempt to invade Lorraine, which Turenne easily stopped, the Imperialists suddenly recrossed the Rhine and marched rapidly into the neighbourhood of the Strassburg bridge.

Turenne's Winter Campaign in Alsace.—The magistrates of this city were not less amenable than had been the bishop of Würzburg in 1673. Bournonville obtained a free passage, and Turenne was too late to oppose him. The French general, however, determined to fight, as he had done at Sinsheim, to prevent the junction of the two hostile armies. The Great Elector was still in the Neckar valley when the battle of Enzheim (8 m. from Strassburg) was fought on the 4th of October. This time it was indecisive, and Bournonville's superior forces, soon augmented by the arrival of the elector, spread into Alsace. Turenne steadily retired to his camp of Dettweiler, unable for the moment to do more, and the Germans took up winter quarters in all the towns from Belfort to Strassburg (October-November 1674). But Turenne was preparing for another winter campaign, the most brilliant in the great commander's career.

First he placed the fortresses of middle Alsace in a state of defence, to deceive the enemy. Then he withdrew the whole of the field army quietly into Lorraine. Picking up on his way such reinforcements as were available, he marched southward with all speed behind the Vosges, and in the last stages of the movement he even split up his forces into many small bodies, that the enemy's spies might be misled. After a severe march through hilly country and in the midst of snowstorms, the French reunited near Belfort, and without a moment's delay poured into Alsace from the south. The scattered Imperialists were driven towards Strassburg, every corps which tried to resist being cut off. Bournonville stood to fight at Mülhausen with such forces as he could collect (29th December 1674) but Turenne's men carried all before them. The advance continued to Colmar, where the elector, who was now in command of the Germans, stood on the defensive with forces equal to Turenne's own. The battle of Türkheim (5th of January 1675) nevertheless resulted in another and this time a decisive victory for the French; a few days after the battle Turenne could report that

there was not a soldier of the enemy left in Alsace. His army now went into winter quarters about Strassburg, and drew supplies from the German bank of the Rhine and even from the Neckar valley (January 1675).

1675.—This opening of the campaign promised well, and Louis as usual took the field as early as possible. In the course of the spring (May-June) the king's army recaptured some of the lost fortresses of the Meuse and took in addition Liège and Limburg. The expeditionary corps in Sicily also gained some successes in this campaign, and Schomberg invaded Catalonia. On the Rhine was fought the last campaign of Turenne and Montecucculi. The elector having withdrawn his forces to Brandenburg (see SWEDEN: *History*), Montecucculi resumed command, and between Philipsburg and Strassburg the two great commanders manoeuvred for an advantage, each seeking to cover his own country and to live upon that of the enemy. At last Turenne prevailed and had the Imperialists at a disadvantage on the Sasbach, where, in opening the action, he was killed by a cannon-shot (July 27th). The sequel showed how dependent was even the best organized army of the time upon the personality of its commander.

All the advantages won were hastily surrendered, and Montecucculi, sharply following up the retreat of the French, drove them over the Rhine and almost to the Vosges. At the same time the duke of Lorraine defeated Marshal Créquî (August 11th) at Conzer Brücke on the Moselle, and recaptured Trier (September 6th), which, as a set-off against Bonn, Turenne had taken in the autumn of 1673. The situation was more than alarming for the French, but Condé was destined to achieve a last success—for once a success of careful strategy and prudent manoeuvre. Luxemburg was left in charge in Flanders, and the prince took command of the remnant of Turenne's old army and of the fugitives of Créquî's. Montecucculi's skill failed completely to shake his position, and in the end the prince compelled him to retire over the Rhine. Condé and Montecucculi retired from their commands at the close of the year, Turenne was dead, and a younger generation of commanders henceforward carried on the war.

1676.—In 1676 the naval successes of France in the Mediterranean enabled the corps under Marshal Vivonne in Sicily to make considerable progress, and he won an important victory at Messina on the 25th of March. Vivonne was made viceroy of Sicily. Louis himself, with his marshals and Vauban, conducted the campaign in the north. The town of Condé fell on the 26th of April, and the king then manoeuvred against the prince of Orange in the neighbourhood of Valenciennes. An attempt made by the latter in the summer to besiege Maastricht was frustrated by Marshal Schomberg with a detachment of the king's army (August). Rochefort meanwhile covered the Meuse country and Luxemburg. Créquî, who had now returned from captivity (he had been taken after the battle of Conzer Brücke) opposed the Imperialists in Lorraine, but he was unable to prevent the fall of Philipsburg, which occurred on the 17th of September. The French now laid waste the land between the Meuse and Moselle for the same reason which brought about the devastation of the Palatinate in 1674, and the year closed with a war of manoeuvre on the upper Rhine between the Imperialists under the duke of Lorraine and the French under Luxemburg.

1677.—The chief event of the campaign of 1677 in the Netherlands was the siege of Valenciennes, which fortress was invested by Louis in the first weeks of the campaigning season. Five marshals of France served under the king in this enterprise, but their advice was of less value than that of Vauban, whose plans the king followed implicitly, even so far as to order an assault *de vive force* against the unanimous opinion of the marshals. This succeeded beyond Vauban's own expectation; the picked troops entrusted with the attack of an outwork forced their way into the town itself (March 17th). The success was followed by the siege of St Omer and the defeat of William's relieving army by the duke of Orleans (battle of Mont Cassel, April 11th, 1677). The summer campaign was a contest of skill

between Luxemburg and William, which resulted in favour of the French. The prince of Orange failed in an attempt to take Charleroi, and Marshal D'Humières captured St Ghislain.

In Germany the credit of the French successes was due to Créquy, who was no longer the defeated general of Conzer Brücke, but the most successful of Turenne's pupils. He began by driving back the duke of Lorraine to the Rhine. Another attempt by the Lorraine family to reconquer their duchy was thus foiled, and at the same time a second imperial army under the duke of Saxe-Eisenach, which had crossed the Rhine by Philippsburg, was shut up in an island of the Rhine and forced to make terms with the French. A large reinforcement sent by the duke of Lorraine to the assistance of Saxe-Eisenach was completely defeated by Créquy in the battle of Kochersberg near Strassburg (October 7th) and the marshal followed up his successes by the capture of Freiburg on the 14th of November. During the year there was a brisk war in the West Indies, and also in Catalonia, where the French maintained the ground won by Schomberg in the previous campaign.

1678.—In 1678 Louis took the field in February. The skilful manoeuvres of the French, whether due to Louis' own generalship or that of his advisers, resulted in the speedy capture of Ghent and Ypres (March), and the retention of the prizes in the usual war of posts which followed. The last battle of the war was fought at St Denis (outside Mons) between William and Luxemburg on the 14th of August, three days after the peace of Nijmegen had been concluded. William sustained another defeat, but the battle was one of the most fiercely contested of the whole war. On the Rhine, Créquy began by winning the battle of Rheinfelden (July 6th), after which he inflicted upon the Imperialists another defeat at Gengenbach (July 23rd) and took Kehl. In the short campaign of 1679, before France and the empire had concluded peace, he was equally successful.

In Spain the French army under Marshal de Navailles had also made steady progress, and thus the last campaign was wholly in favour of the French. The peace of Nijmegen gave Louis many of the Netherlands frontier fortresses, and little else. He was threatened by the intervention of England on the side of the coalition, and would have made peace earlier but for his reluctance to abandon his ally Sweden. The French army had, however, well established its reputation. Vauban was unique amongst the officers of his time, and Créquy and Luxemburg were not unworthy successors of Turenne and Condé. The two marshals added to their reputation in the "Reunion War" of 1680-84. Créquy died in 1684 at the age of sixty-one, Luxemburg's greatest triumph was won ten years later (see GRAND ALLIANCE, WAR OF THE). Vauban retired from active service as a marshal twenty-five years after the peace of Nijmegen. But the interest of the war does not reside wholly in the personalities of the leaders. There were great commanders before Turenne and Condé. It is as the début of a new method of military organization and training—the first real test of the standing army as created by Louvois—that the Dutch War of 1672-79 is above all instructive. (C. F. A.)

DUTCH WEST INDIA COMPANY, THE (*De Westindische Compagnie*), a company founded by letters-patent from the Netherlands states-general dated the 3rd of June 1621. The purpose for which the company was formed was to regulate and protect the contraband trade already carried on by the Dutch in the American and African possessions of Spain and Portugal, and to establish colonies on both continents and their islands. By the terms of the charter the company was to be composed of five boards or branches, established in Amsterdam, Zealand, the Meuse (Rotterdam), the North Department (Friesland and Hoorn), and Groningen. Each was to be represented on the general governing board according to the importance of the capital contributed by it. Thus Amsterdam, which contributed four-ninths of the capital, had eight directors on the board. Zealand, which subscribed two-ninths, had four. Rotterdam was represented by two directors, though it only contributed one-ninth. The northern district and Groningen, which each contributed one-ninth, appointed one director each. Another

director was appointed by the states-general. In 1629 a ninth representative was given to Amsterdam, and the strength of the whole board was fixed at nineteen.

The company was granted the monopoly of the trade with America and Africa and between them, from the Arctic regions to the Straits of Magellan, and from the Tropic of Cancer to the Cape of Good Hope. The policy the company proposed to follow was to use its monopoly on the coast of Africa in order to secure the cheap and regular supply of negro slaves for the possessions it hoped to acquire in America. The trade was thrown open by the voluntary action of the company in 1638. The general board was endowed with ample power to negotiate treaties, and make war and peace with native princes; to appoint its officials, generals and governors; and to legislate in its possessions subject to the laws of the Netherlands. The states-general undertook to secure the trading rights of the company, and to support it by a subvention of one million guilders (about £100,000). In case of war the states-general undertook to contribute sixteen vessels of 300 tons and upwards for the defence of the company, which, however, was to bear the expense of maintaining them. In return for these aids the states-general claimed a share in the profits, stipulated that the company must maintain sixteen large vessels (300 tons and upwards) and fourteen "yachts" (small craft of 50 to 100 tons or so); required that all the company's officials should take an oath of allegiance to themselves as well as to the board of directors; and that all despatches should be sent in duplicate to themselves and to the board.

The history of the Dutch West India Company is one of less prosperity than that of the Dutch East India Company. In early days the trade was not sufficient to meet the heavy expense of the armaments raised against Spain and Portugal. A compensation was found in the plunder of Spanish and Portuguese galleons and carracks. In 1628 the company's admiral Piet Heijn captured a vast booty in the Spanish treasure-ships. But this source of profit was dried up by the success of the company's cruisers, which destroyed their enemy's trade. Profit had to be sought in the development of the colonies established on the continent of America. In this field the successes of the company were counterbalanced by not a few failures. The company was never able to secure the control of the supply of slaves from Africa. Its settlement of New Netherland was lost to England. In the West Indies it gained a valuable footing among the islands. It occupied St Eustatius in 1634, Curaçao with Bonaire and Aruba in 1634 and 1635, Saba in 1640 and St Martin in 1648. But its greatest conquests and its greatest losses were alike met on the continent of South America. After a first unsuccessful occupation in 1623 of Bahia, which was immediately retaken by a combined Spanish and Portuguese armament, the company obtained a firm footing in Pernambuco. The story of the wars which arose out of this invasion belongs to the history of Brazil. The company had been largely guided in its policy of assailing the Portuguese possessions by the advice of the Jews, who were numerous in Brazil, and who found means to communicate with their fellows in religion, the refugees in Amsterdam. The most prosperous period of the company was during the tolerant and liberal administration of Count John Maurice of Nassau-Siegen (1636-1644).

The monopolist tendency of all Dutch colonization, the religious hostility of the Roman Catholic Portuguese, and the support given by France and England to Portugal after her revolt from Spain, combined at last to make the position of the company in Brazil untenable. It resigned all claim on the country by the treaty of 1661. But though deprived of its establishment in Brazil, the company found a compensation in Surinam and Essequebo (Dutch Guiana), where there was no Spanish or Portuguese population to resist it, and where the resources of the country offered great profits. The advantages of the settlement in Guiana were not, however, reaped by the company founded in 1621. In 1674 it had become so embarrassed that it was dissolved, and reconstructed in 1675. The newly formed company continued to exploit the Dutch possessions in

America till 1794, when they were all swept into the general reorganization consequent on the French invasion of Holland. The West India Company founded after the Napoleonic epoch in 1828 was only meant to develop trade, and was not successful.

AUTHORITIES.—P. M. Nitscher, *Les Hollandais au Brésil* (the Hague, 1853), the work of a Dutch author writing in French. See also Southey, *History of Brazil* (London, 1810), and E. B. O'Callaghan, *History of New Netherland* (New York, 1846–1848).

DUTENS, LOUIS (1730–1812), French writer, was born at Tours, of Protestant parents, on the 15th of January 1730. He went to London, where his uncle was a jeweller, and there obtained a situation as tutor in a private family. In this position he learnt Greek and mathematics, and studied oriental languages, also Italian and Spanish. He took orders, and was appointed chaplain and secretary to the English minister at the court of Turin in October 1758. In 1760–1762 he was chargé d'affaires at Turin. Lord Bute, before retiring from office in 1763, procured him a pension. He again went to Turin as chargé d'affaires; and during this second mission he collected and published a complete edition of the works of Leibnitz (Geneva, 6 vols., 1768) and wrote his *Recherches sur l'origine des découvertes attribuées aux modernes* (1766). On his return to England the duke of Northumberland procured him the living of Elsdon, in Northumberland, and made him tutor to his son. In 1775 he became a member of the French Academy of Inscriptions and a fellow of the Royal Society. Dutens was for a third time chargé d'affaires at Turin. He was in Paris in 1783, and returned to London the following year. He died in London on the 23rd of May 1812.

The principal works of Dutens were his *Recherches sur l'origine des découvertes attribuées aux modernes* (1766, 2 vols.); *Appel au bon sens* (London, 1777, 8vo), directed in defence of Christianity against the French philosophers, and published anonymously; *Explication de quelques médailles de peuples, de rois et de villes grecques et phéniciennes* (London, 1773); *Explication de quelques médailles du cabinet de Duane* (1774); *Troisième dissertation sur quelques médailles grecques et phéniciennes* (1776); *Logique, ou l'art de raisonner* (1773); *Des pierres précieuses et des pierres fines, avec les moyens de les connaître et de les baluer* (Paris, 1776); *Itinéraire des routes les plus fréquentes, ou journal d'un voyage aux principales villes d'Europe* (Paris, 1775), frequently republished; *Considérations théologiques sur les moyens de réunir toutes les églises chrétiennes* (1798); *Œuvres mêlées*, containing his most important works published up to the date (London, 1797, 4 vols.); *L'Ami des étrangers qui voyagent en Angleterre* (1789, 8vo); *Histoire de ce qui s'est passé pour le rétablissement d'une régence en Angleterre* (1789); *Recherches sur le tems le plus reculé de l'usage des volées chez les anciens* (1795); *Mémoires d'un voyageur qui se repose* (Paris, 1786, 3 vols.). The first two volumes of the last-named work contain the life of the author, written in a romantic style; the third bears the title of *Dutensiana*, and is filled with remarks, anecdotes and bons mots. (See memoir of Dutens in the *Gentleman's Magazine* for 1812.)

DUTROCHET, RENÉ JOACHIM HENRI (1776–1847), French physiologist, was born at ChâteaudeNéon (Indre) on the 14th of November 1776, and died at Paris on the 4th of February 1847. In 1799 he entered the military marine at Rochefort, but soon left it to join the Vendean army. In 1802 he began the study of medicine at Paris; and he was subsequently appointed chief physician to the hospital at Burgos. After an attack of typhus he returned in 1809 to France, where he devoted himself to the study of the natural sciences. His scientific publications were numerous, and covered a wide field, but his most noteworthy work was embryological. His "*Recherches sur l'accroissement et la reproduction des végétaux*," published in the *Mémoires du muséum d'histoire naturelle* for 1821, procured him in that year the French Academy's prize for experimental physiology. In 1837 appeared his *Mémoires pour servir à l'histoire anatomique et physiologique des végétaux et des animaux*, a collection of all his more important biological papers.

DUTT, MICHAEL MADHU SUDAN (1824–1873), the greatest native poet of India in the 19th century, was born at Sagandari, in the district of Jessore in Bengal, on the 25th of January 1824. His father was a pleader in Calcutta, and young Madhu Sudan received his education in the Hindu college of Calcutta, and was the foremost among the distinguished young students of his day, many of whom lived to make their mark in the literature and social progress of their country. Madhu Sudan left the college in 1842, and in the following year ran away to avoid a marriage into

which his father wished to force him, and embraced the Christian religion. Continuing his studies now in the Bishop's college, Madhu Sudan learnt Greek and Latin and some modern European languages, and in 1848 went to Madras. There he wrote English verses, and married the daughter of a European indigo-planter, but was soon separated from her. He then united himself with an English lady, the daughter of an educational officer; and she remained true to him through life amidst all his misfortunes, and was the mother of the children he left. With her Madhu Sudan returned to Calcutta in 1856, and soon discovered that the true way for winning literary distinction was by writing in his own language, not by composing verses in English. His three classical dramas—*Sarmishtha*, *Padmavati*, and *Krishna Kumari*—appeared between 1858 and 1861, and were recognized as works of merit. But his great ambition was to introduce blank verse into Bengali. His knowledge of Sanskrit poetry, his appreciation of the Greek and Latin epics, and his admiration of Dante and of Milton, impelled him to break through the fetters of the Bengali rhyme, and to attempt a spirited and elevated style in blank verse. His first poem in blank verse, the *Tilottama*, was only a partial success; but his great epic which followed in 1861, the *Meghnad-Badha*, took the Indian world by surprise, and at once established his reputation as the greatest poet of his age and country. He took his story from the old Sanskrit epic, the *Ramayana*, but the beauty of the poem is all his own, and he imparted to it the pathos and sweetness of Eastern ideas combined with the vigour and loftiness of Western thought. In 1862 Madhu Sudan left for Europe. He lived in England for some years, and was called to the bar; and in 1867 returned to his country to practise as a barrister in Calcutta. But the poet was unfitted for a lawyer's vocation; his liabilities increased, his health failed, his powers declined. He still wrote much, but nothing of enduring merit. His brilliant but erratic life ended in a Calcutta hospital on the 29th of June 1873.

DUTY (from "due," that which is owing, O. Fr. *deu*, *dâ*, past participle of *devoir*; Lat. *debere*, *debitum*; cf. "debt"), a term loosely applied to any action or course of action which is regarded as morally incumbent, apart from personal likes and dislikes or any external compulsion. Such action must be viewed in relation to a principle, which may be abstract in the highest sense (e.g. obedience to the dictates of conscience) or based on local and personal relations. That a father and his children have mutual duties implies that there are moral laws regulating their relationship; that it is the duty of a servant to obey his master within certain limits is part of a definite contract, whereby he becomes a servant engaging to do certain things for a specified wage. Thus it is held that it is not the duty of a servant to infringe a moral law even though his master should command it. For the nature of duty in the abstract, and the various criteria on which it has been based, see ERRORS.

From the root idea of obligation to serve or give something in return, involved in the conception of duty, have sprung various derivative uses of the word; thus it is used of the services performed by a minister of a church, by a soldier, or by any employee or servant. A special application is to a tax, a payment due to the revenue of a state, levied by force of law. Properly a "duty" differs from a "tax" in being levied on specific commodities, transactions, estates, &c., and not on individuals; thus it is right to talk of import-duties, excise-duties, death- or succession-duties, &c., but of income-tax as being levied on a person in proportion to his income.

DU VAIR, GUILLAUME (1556–1621), French author and lawyer, was born in Paris on the 7th of March 1556. Du Vair was in orders, and, though during the greater part of his life he exercised only legal functions, he was from 1617 till his death bishop of Lisieux. His reputation, however, is that of a lawyer, a statesman and a man of letters. He became in 1584 councillor of the parlement of Paris, and as deputy for Paris to the Estates of the League he pronounced his most famous politico-legal discourse, an argument nominally for the Salic law, but in reality directed against the alienation of the crown of France to the Spanish infant, which was advocated by the extreme Leaguers. Hearty IV.

acknowledged his services by entrusting him with a special commission as magistrate at Marseilles, and made him master of requests. In 1595 appeared his treatise *De l'éloquence française et des raisons pour quoi elle est demeurée si basse*, in which he criticises the orators of his day, adding by way of example some translations of the speeches of ancient orators, which reproduce the spirit rather than the actual words of the originals. He was sent to England in 1596 with the marshal de Bouillon to negotiate a league against Spain; in 1599 he became first president of the parlement of Provence (Aix); and in 1603 was appointed to the see of Marseilles, which he soon resigned in order to resume the presidency. In 1616 he received the highest promotion open to a French lawyer and became keeper of the seals. He died at Tonneins (Lot-et-Garonne) on the 3rd of August 1621. Both as speaker and writer he holds a very high rank, and his character was equal to his abilities. Like other political lawyers of the time, Du Vair busied himself not a little in the study of philosophy. The most celebrated of his treatises are *La Philosophie morale des Stoïques*, translated into English (1664) by Charles Cotton; *De la constance et consolation des calamités publiques*,¹ which was composed during the siege of Paris in 1589, and applied the Stoic doctrine to present misfortunes; and *La Sainte Philosophie*, in which religion and philosophy are intimately connected. Pierre Chartron drew freely on these and other works of Du Vair. F. de Brunetière points out the analogy of Du Vair's position with that afterwards developed by Pascal, and sees in him the ancestor of the Jansenists. Du Vair had a great indirect influence on the development of style in French, for in the south of France he made the acquaintance of Malherbe, who conceived a great admiration for Du Vair's writings. The reformer of French poetry learned much from the treatise *De l'éloquence française*, to which the counsels of his friend were no doubt added. Du Vair's works were published in folio at Paris in 1647. See Nicéron, *Mémoires*, vol. 43; and monographs by C. A. Sapey (1847 and 1858).

DUVAL, ALEXANDRE VINCENT PINEUX (1767-1842), French dramatist, was born at Rennes on the 6th of April 1767. He was in turn sailor, architect, actor, theatrical manager and dramatist. He is the characteristic dramatist of the Empire, but the least ambitious of his dramas have best stood the test of time. *Les Projets de ménage* (1790), *Les Tuteurs vengés* (1794) and *Les Héritiers* (1796) have been revived on the modern French stage. Others among his plays, which number more than sixty, are *Le Menuisier de Livonie* (1805), *La Manie des grands* (1817) and *Le Faux Bonhomme* (1821). In 1812 he was elected to the Academy. He died on the 1st of September 1842.

DUVAL, CLAUDE (1643-1670), a famous highwayman, was born at Domfront, Normandy, in 1643. Having entered domestic service in Paris, he came to England at the time of the Restoration in attendance on the duke of Richmond, and soon became a highwayman notorious for the daring of his robberies no less than for his gallantry to ladies. Large rewards were offered for his capture, and he was at one time compelled to seek refuge in France. In the end he was captured in London, and hanged at Tyburn on the 21st of January 1670. His body was buried in the centre aisle of Covent Garden church, under a stone with the following epitaph:—

"Here lies Du Vall: Reader if male thou art,
Look to thy purse: if female to thy heart."

A full account of his adventures, ascribed to William Pope, was reprinted in the *Harleian Miscellany*, and Samuel Butler published a satirical ode *To the Happy Memory of the Most Renowned Du Val*.

DUVENECK, FRANK (1848-), American figure and portrait painter, was born at Covington, Kentucky, on the 9th of October 1848. He was a pupil of Diez in the Royal Academy of Munich, and a prominent member of the group of Americans who in the 'seventies overturned the traditions of the Hudson River School and started a new art movement. His work shown in Boston and elsewhere about 1875 attracted great attention,

¹ Translated into English by Andrew Comt in 1622 as *A Buckler against Aderstise*.

and many pupils flocked to him in Germany and Italy, where he made long visits. After returning from Italy to America, he gave some attention to sculpture, and modelled a fine monument to his wife, now in the English cemetery in Florence.

DU VERGIER DE HAURANNE, JEAN (1581-1643), abbot of St Cyran, father of the Jansenist revival in France, was born of wealthy parents at Bayonne in 1581, and studied theology at the Flemish university of Louvain. After taking holy orders he settled in Paris, where he became known as a mine of miscellaneous erudition. In 1609 he distinguished himself by his *Question royale*, an elaborate answer to a problem casually thrown out by King Henry IV. as to the exact circumstances under which a subject ought to give his life for his sovereign. His learning was presently diverted into a more profitable channel. The Louvain of his time was the scene of many conflicts between the Jesuit party, which stood for scholasticism and Church-authority, and the followers of Michael Baius (q.v.), who upheld the mysticism of St Augustine. Into this controversy Du Vergier was presently dragged by his friendship with Cornelius Jansen, a young champion of the Augustinian party, who had come to Paris to study Greek. The two divines went off together to Du Vergier's home at Bayonne, where he became a canon of the cathedral, and Jansen a tutor in the bishop's seminary. Here they remained some years, intently studying the fathers. Eventually, however, Jansen went back to Louvain, while Du Vergier became confidential secretary to the bishop of Poitiers, and was presently made sinecure abbot of St Cyran. Thereafter he was generally called M. de St Cyran. At Poitiers he was brought into contact with Richelieu—as yet unknown to political fame, and simply the zealous young bishop of the neighbouring diocese of Luçon. Western Touraine being the headquarters of French Protestantism, the two prelates turned St Cyran's learning against the Huguenots. He began to dream of reforming Catholicism on Augustinian lines, and thus defeating the Protestants by their own weapons. They appealed to primitive antiquity; he answered that his Church understood antiquity better than theirs. They appealed to the spirit of St Paul; he answered that Augustine had saved that spirit from etherealizing away, by coupling it with a high sacramental theory of the Church. They flung practical abuses in the teeth of Rome; he entered on a bold campaign to bring those abuses to an end. Before long, his reforming zeal involved him in many quarrels—so much so that he left Poitiers and settled down in Paris. Here he became widely known as a director of consciences, forming a particular friendship with the influential Arnauld family. But his general projects of reform were by no means allowed to sleep, though here he worked hand in hand with his old friend Jansen. Both traced the evils of their time to the Jesuits and Schoolmen. Their dialectic had corrupted theology; their hand-to-mouth utilitarianism had played havoc with traditional church-institutions. Accordingly, Jansen set to work to remedy one evil by writing a big book on St Augustine, the great master of theological method. St Cyran dealt with the other evil in an equally bulky treatise, the *Petrus Aurelius* (1633). This indicts the Jesuits for every sort and kind of misdemeanour. It deals much with what Pascal will presently call their *dévotion aisée*; but still more with crimes of a technical sort, especially their defiance of episcopal authority. Thereby the book gained for its author's projects of reform a great deal of Gallican support. On the other hand, it gave much annoyance to Richelieu, now the all-powerful and extremely Erastian prime minister. After failing more than once to stop St Cyran's mouth with a bishopric, he had him arrested as a disturber of ecclesiastical peace (14th of March 1638). He remained shut up in the castle of Vincennes until Richelieu's death (December 1642). Then he was at once set free; but the long imprisonment had told heavily on his health, and he died of a stroke of apoplexy in October 1643.

St Cyran's character has been always something of a puzzle. Many excellent contemporary judges were profoundly impressed; others, as one of them said, went away bewildered by this strange abbé, who never argued a question out, but leapt from

one point to another in broken, incoherent phrases. Grace of expression he had none; perhaps no man of equal spiritual insight ever found it so hard to make his meaning clear, whether on paper or by word of mouth. On the other hand, Jansenism, considered as a practical religious revival, is altogether his work. He dragged the Augustinian mysticism out of the Louvain classrooms, and made it a vital spiritual force in France. Without him there would have been no Pascal—no Provincial Letters, and no *Pensées*.

There is an excellent life of St Cyran by his secretary, Claude Lancelot, published at Cologne in two volumes, 1738. A selection of his *Lettres chrétiennes* was edited by his disciple, Robert Arnauld d'Andilly (Paris, 1645). An entirely different collection of *Lettres spirituelles* was printed at Cologne in 1744. (St C.)

DUVEYRIER, HENRI (1840-1892), French explorer of the Sahara, was born in Paris on the 28th of February 1840. His youth was spent partly in London, where he met Heinrich Barth, then preparing the narrative of his travels in the western Sudan. At the age of nineteen Duveyrier, who had already learnt Arabic, began a journey in the northern parts of the Sahara which lasted nearly three years. On returning to France he received, in 1863, the gold medal of the Paris Geographical Society, and in 1864 published *Exploration du Sahara: les Touareg du nord*. In the war of 1870 he was taken prisoner by the Germans. Subsequently he made several other journeys in the Sahara, adding considerably to the knowledge of the regions immediately south of the Atlas, from the eastern confines of Morocco to Tunisia. He also examined the Algerian and Tunisian *skats* and explored the interior of western Tripoli. Duveyrier devoted special attention to the customs and speech of the Tuareg, with whom he lived for months at a time, and to the organization of the Senussi. In 1881 he published *La Tunisie*, and in 1884 *La Confrérie musulmane de Sidi Mokammed Ben Alt-Es-Sendusi et son domaine géographique*. He died at Sevres on the 25th of April 1892.

DUX (Czech *Duchcov*), a town of Bohemia, Austria, 86 m. N.N.W. of Prague by rail. Pop. (1900) 11,921, three-fourths German. It is situated in the centre of an extensive and well-worked lignite deposit and manufactures glass, porcelain and earthenware. In Dux is a castle belonging to Count Waldstein, a kinsman of Wallenstein, which contains a picture gallery with two portraits of Wallenstein by Van Dyck, and a museum with a collection of arms and armour and several relics of the great general.

DUXBURY, a township of Plymouth county, Massachusetts, on Massachusetts Bay, 36 m. S.S.E. of Boston. Pop. (1890) 1908; (1905, state census) 2028. Area, 25.5 sq. m. Duxbury is served by the Old Colony system of the New York, New Haven & Hartford railway. In the township are the villages of Duxbury, South Duxbury, West Duxbury, North Duxbury, Island Creek and Millbrook. The soil is sandy, the surface of the country well wooded and broken by a number of ponds and creeks. Duxbury is a summer resort, with a large hotel at Standish Shore. Duxbury has a public library, and is the seat of the Powder Point school for boys, and Partridge Academy, founded in 1828 by a bequest of \$10,000 from George Partridge of Duxbury, and incorporated in 1830. On Captain's Hill is the Standish Monument (begun in 1872), a circular tower, on an octagonal base, of rough Hallowell granite, surmounted by a statue of Miles Standish, 124 ft. from the ground. The Standish house, built in 1666 by Miles's son, Alexander, is still in existence. In South Duxbury is an old burying ground, in which the oldest marked grave is that of Jonathan Alden (d. 1607), son of John Alden. For many years there were important cod and mackerel fisheries here and Duxbury clams were famous; there were large shippards in Duxbury in the 18th century and in the first half of the 19th. At present cranberries are the only product of importance. The first settlement was made here in 1631 by Miles Standish (to whom Captain's Hill was granted), William Brewster, John Alden, and a few others. In 1632 a church was organized and the present name was adopted from Duxbury Hall, Lancashire, the old seat of the Standish family; the Indian name had been *Mattakeeset*. The township was incorporated in 1637; it

originally included Bridgewater and parts of Pembroke and Kingston.

See Justin Winsor, *History of Duxbury* (Boston, 1849); and Laurence Bradford, *Historic Duxbury in Plymouth County* (Boston, 1900).

DVINA, the name of two rivers of European Russia.

1. The **NORTHERN DVINA**, or *Dvina Syevernaya*, belongs to the basin of the White Sea, and is formed by the junction of the Sukhona and the Yug, which, rising, the former in the south-west and the latter in the south-east of the government of Volodga, meet in the neighbourhood of Velikiy-Ustyug, at a height of 300 ft. above the sea, in 61° 20' N. and 46° 20' E. The conjoint stream then flows N.W. to the Gulf of Archangel, which it reaches 50 m. below the city of Archangel. From its mouth to the confluence of the co-tributary streams the distance is about 470 m., and to the source of the Sukhona 780 m. The drainage area is estimated at 141,000 sq. m. Except at the rapids the current of the Dvina is comparatively slow, as the average fall per mile is only 9 in. Till its union with the Vychedga, a river which exceeds it in volume, it flows for the most part in a single, well-defined and permanent channel; but below that point it often splits into several branches, and not infrequently alters its course. In the neighbourhood of Archangel it divides into three distinct arms, which form a regular delta; but of these that of Berezoa alone is navigable for sea-going vessels, and even it is impeded by a bar at the mouth, with not more than 14½ or 15½ ft. of water at full tide. Just above the point where the delta begins the river is joined by a large tributary, the Pinega, from the right. Above the confluence of the Vychedga the breadth is about 1750 ft.; below that point it widens out to 3500 ft.; and near Archangel it attains more than three times that measure. The channel is free from ice for about 174 days in the year. By means of the Duke Alexander of Württemberg Canal, the river is connected with the Neva and the Volga.

2. The **SOUTHERN DVINA**, or *Dvina Zapadnaya*, in German *Düna* and in Lettish *Daugava*, belongs to the Baltic basin, and takes its rise in a small lake about 800 ft. above the level of the sea, in the government of Tver, not far from the sources of the Volga and the Dnieper. After dividing Tver in part from Pakov in part, it skirts the east and south of the government of Vitebsk, separates part of the latter from Vilna, and then divides Vitebsk and Livonia from Courland, and disembogues in the southern end of the Gulf of Riga. Its length is 640 m. and it drains an area of 32,960 sq. m. From Dvinsk (Dünaburg) to Riga, a distance of 135 m., there is altogether a fall of 295 ft., of which 105 ft. are in the 40 m. from Jakobstadt to Friedrichstadt. In the lower part of its course the river attains an ordinary depth of 30 ft. and an average breadth of 1400 ft.; but during the spring flood it sometimes rises 14 ft. above its usual level, and its waters spread out to a mile in width. Near the mouth the river is usually free from ice for 245 days in the year, and in the government of Vitebsk for 220. It is navigable from the confluence of the Mezha (i.e. from Vitebsk) downwards, but the number of rapids and shallows greatly diminishes its value. Navigation can also be carried on by the following tributaries: the Usvyat, Mezha, Kasplya, Ulla, Disna and Bolder-aa. This river was formerly called the Khezir or Turunt, and at the present day it has the name of Polot among the White Russians. Salmon and lampreys abound in its waters. (P. A. K.; J. T. BR.)

DVINSK, the official name since 1893 of **DÜNABURG**, a town and fortress of western Russia, in the government of Vitebsk, 162 m. by rail N.W. of the city of Vitebsk, on the right bank of the Dvina (Düna), in 55° 53' N. and 26° 23' E., and at the intersection of two main railway lines—Riga-Smolensk and Vilna-St Petersburg. It is the chief strategic position for the defence of the Dvina. It consists of four portions—the main town, or fortress, the old suburb, the new suburb, and on the left bank of the river the village of Griva. Among the industrial establishments are tanneries and breweries, saw-mills, flour-mills, brick and tile works and limekilns. The town is an important commercial centre, especially for flax, hemp, tallow and timber. The population increased from 25,764 in 1860 to 72,231 in 1900,

consisting chiefly of Jews (about 30,000), Lithuanians and Letts.

Dünaburg was originally founded in 1278 by the Livonian Knights of the Sword, about 12 m. farther down the river than its present site, at a spot still known as the Old Castle or *Starý Zámek*. In 1559 it was mortgaged by the grand-master of the Knights to Sigismund Augustus, king of Poland. Although captured in 1576 by Ivan the Terrible of Russia, it was again restored to Poland; and in 1582 Stephen Bathori, king of Poland, transferred the fortress to its present site. In the 17th century it was held alternately by the Swedes and the Russians. It was finally incorporated with Russia in 1772 on the first division of Poland. In July 1812 the *l'île-de-pont* was vainly stormed by the French under Oudinot, but a few weeks afterwards the town was captured by them under Macdonald.

DVOŘÁK, ANTON (1841-1904), Bohemian musical composer, born at Nelahozeves (otherwise Mülhausen) in Bohemia on the 8th of September 1841, was the son of Frantisek Dvořák, a small publican and village butcher. At the door of his father's inn Dvořák first appeared as a practical musician, taking his place among the fiddlers who scraped out their "furiants" and other wild dances for the benefit of the holiday-making local beaux and belles. At the village school he learnt from Josef Spitz both to sing and to play the violin, with so much effect that soon he was able to assist in the parish church services. At twelve years old he was sent by his father to Zlonic, near Schlan, to an uncle, with whom he lived while passing through the higher-grade classes at school. Here, too, he was fortunate enough to find a valuable friend in A. Liehmann, organist and chief musician of the little town, a competent musician, who instructed the boy in elementary theory, organ and pianoforte playing. The theory studies, however, could not long be continued, since Liehmann soon acknowledged in his own dialect that the boy was extraordinarily full of promise ("Aus Tonda, dem Sappermentabuben 'mal' was werden könnte"), at the same time realizing that he could not do much to assist. But Dvořák soon left Zlonic for Böhmischn-Kamnitz, where he learnt German and advanced his musical studies under Hancke. A year later he was summoned to return to Zlonic to assist his father, who had set up in business there. But his craving for a musical career was not to be checked, and after considerable trouble with his father consent was obtained to his settling in Prague in order to devote himself entirely to music.

In October 1857 Dvořák entered the organ-school of the *Gesellschaft der Kirchenmusik*, where he worked for three years. The small financial aid his father was at first able to lend soon ceased, and after being in Prague but a few months Dvořák found himself practically thrown on his own resources. By playing the viola in a private orchestra and in various inns of the town he succeeded in obtaining a precarious livelihood. On the opening in 1862 of the Bohemian Interimstheater, Dvořák, with part of this band, formed the nucleus of the theatrical orchestra, and remained connected with it for eleven years, when he became organist of the church of St Adalbert. At this time his small stipend was augmented slightly by the fees of a few pupils, though the privations suffered by him and his wife (for he had recently married) must have been great. But in spite of financial worry and of the amount of time he had to devote to his professional duties and private pupils, Dvořák found leisure not only for his own studies of the classics, but also to compose. His work, like his daily life, was beset with difficulties, for he had not the means to provide himself with sufficient music-paper, much less to hire a pianoforte; and it is possible that several of his important early works would never have been written had it not been for the generosity of Karel Bendl, the composer, who helped him in many ways.

Dvořák himself said afterwards that he retained no recollection of much that he then composed. In and about 1864 two symphonies, a host of songs, some chamber-music, and an entire opera, *Alfred*, lay unheard in his desk. The libretto of this opera was made up from materials found in an old almanack. Most of these works were burnt long ago. In 1873 he made his

first bid for popularity by his patriotic hymn *Die Erben des weissen Berge* (published many years later as Op. 30). Its reception was enthusiastic, and Dvořák's subsequent works were eagerly awaited and warmly received on production. In 1874 his opera *König und Köhler* resulted in a fiasco at Prague, owing to its mixture of styles. Nothing daunted, Dvořák recomposed the whole work in three months. In 1875, on the recommendation of Brahms and Hanslick, he obtained a stipend from the Kultus-Ministerium at Vienna, which freed him from care and enabled him to indulge in composition to his heart's content. Following on this success came a commission in 1877 for a series of Slavic dances, which took the public by storm. Immediately compositions, old and new, began to pour from the publisher. English sympathy was entirely won by the *Stabat Mater* in 1883, and increased by the symphonies in D, D. mi., and F, G, and E. mi. (*The American*), and the cantata *The Spectre's Bride*, based on K. J. Erben's elaboration of the Bohemian version of the saga treated in Bürger's *Leonore*. The favourable effect produced by these works was somewhat chilled by the oratorio *St Ludmila*, a comparatively feeble work written "to suit English taste" for the Leeds Festival of 1886. The three overtures Opp. 91, 92, 93, failed to hold their place, but the pseudo-American symphony has become one of Dvořák's most popular works, and much of his chamber-music, of which there is abundance, seems quite permanent in its place in concert programmes. In 1892, after having frequently visited England, Dvořák became head of the National Conservatory of Music of America in New York. There he remained till 1895, when he returned to Prague, where he died on the 1st of May 1904.

Dvořák's music is characteristically national, though less purely so than that of Smetana. But in spite of his industry and dramatic talent not one of his operas has been really successful. A master of the orchestra and a composer of real individuality, he earned and deserved his place among the elect, not only by his great gifts, but by his abnormal energy in their development.

See W. H. Hadow, *Studies in Modern Music* (second series, 1908).

DWARAKA, DWARAKA, or JIGAT, a town of British India, in Baroda state, near the extremity of the peninsula of Kathiawar, Bombay. Pop. (1901) 7535. As the birthplace and residence of Krishna, it is the most sacred spot in this part of India, and its principal temple is visited annually by many thousand pilgrims. The approach from the sea is by a fine flight of stone steps, and the great spire rises to a height of 150 ft.

DWARF (A.S. *dwergr*, D. *dwergr*, Icel. *dverg*), the term generally used to describe an extraordinarily under-sized individual of a race of normal stature (for dwarf-races see PYGMY). In Scandinavian mythology the word connoted smallness and deformity, and was used of the elfins and goblins who were supposed to live on the mountains or in the bowels of the earth, and to be kings of metals and mines. The later use of the word certainly does not imply deformity, for many of the dwarfs of history have been singularly graceful and well formed. Dwarfishness is, however, often accompanied by disproportion of the limbs.

From the earliest historic times dwarfs attracted attention, and there was much competition on the part of kings and the wealthy to obtain the little folk as attendants. It is certain that members of the tiny Akka race of Equatorial Africa figured at the courts of the Pharaohs of the early dynasties and were much valued. Philetas of Coa, poet and grammarian (circa 330 B.C.), tutor of Ptolemy Philadelphus, was alleged to be so tiny that he had to wear leaden shoes lest he should be blown away. The Romans practised artificial dwarfing, and the Latin *nanus* or *pumilo* were terms alternatively used to describe the natural and unnatural dwarf. Julia, the niece of Augustus, had a dwarf named Coropas 2 ft. 4 in. high, and a freed-maid Andromeda who measured the same.

Various recipes for dwarfing children have been from time to time in vogue. The most effective, according to report, was to anoint the backbone with the grease of moles, bats and dormice.

The stunting of the growth of stable-boys who aspire to jockey's honours is in no sense true dwarfing.

In later days there have been many dwarf-favourites at European courts. British tradition has its earliest dwarf mentioned in the old ballad which begins "In Arthur's court Tom Thumb did live"; and on this evidence the prototype of the modern Tom Thumb is alleged to have lived at the court of King Edgar. Of authentic English dwarfs the first appears to be John Jarvis (2 ft. high), who was page to Queen Mary I. Her brother Edward VI. had his dwarf Xit. But the first English dwarf of whom there is anything like an authentic history is Jeffery Hudson (1619-1682). He was the son of a butcher at Oakham, Rutlandshire, who kept and baited bulls for George Villiers, first duke of Buckingham. Neither of Jeffery's parents was under-sized, yet at nine years he measured scarcely 18 in., though he was gracefully proportioned. At a dinner given by the duke to Charles I. and his queen he was brought in to table in a pie out of which he stepped, and was at once adopted by Henrietta Maria. The little fellow followed the fortunes of the court in the Civil War, and is said to have been a captain of horse, earning the nickname of "strenuous Jeffery" for his activity. He fought two duels—one with a turkey-cock, a battle recorded by Davenant, and a second with Mr Crofts, who came to the meeting with a squirt, but who in the more serious encounter which ensued was shot dead by little Hudson, who fired from horseback, the saddle putting him on a level with his antagonist. Twice was Jeffery made prisoner—once by the Dunkirkers as he was returning from France, whither he had been on homely business for the queen; the second time was when he fell into the hands of Turkish pirates. His sufferings during this latter captivity made him, he declared, grow, and in his thirtieth year, having been of the same height since he was nine, he steadily increased until he was 3 ft. 9 in. At the Restoration he returned to England, where he lived on a pension granted him by the duke of Buckingham. He was later accused of participation in the "Popish Plot," and was imprisoned in the Gate House. He was released and shortly after died in the sixty-third year of his age.

Contemporary with Hudson were the two other dwarfs of Henrietta Maria, Richard Gibson and his wife Anne. They were married by the queen's wish; and the two together measured only 2 in. over 7 ft. They had nine children, five of whom, who lived, were of ordinary stature. Edmund Waller celebrated the nuptials, Evelyn designated the husband as the "compendium of a man," and Lely painted them hand in hand. Gibson was miniature painter to Charles I., and drawing-master to the daughters of James II., Queens Mary and Anne, when they were children. This Cumberland pygmy, who began his career as a page, first in a "gentle," next in the royal family, died in 1690, in his seventy-fifth year, and is buried in St Paul's, Covent Garden. The last court dwarf in England was Copperrin, a lively little imp in the service of the princess (Augusta) of Wales, the mother of George III. The last dwarf retainer in a gentleman's family was the one kept by Mr Beckford, the author of *Vathek* and builder of Fonthill. He was rather too big to be flung from one guest to another, as used to be the custom at dinners in earlier days when a dwarf was a "necessity" for every noble family.

Of European court dwarfs the most famous were those of Philip IV. of Spain, the hunchbacks whose features have been immortalized by Velazquez. Stanislas, king of Poland, owned Nicholas Ferry (Bébé), who measured 2 ft. 9 in. He was one of three dwarf children of peasant parents in the Vosges. He died in his 23rd year (1764). But Bébé was not so remarkable as Richebourg, who died in Paris in 1858, at the age of 90. He was only 23 in. high. He began life as a servant in the Orleans family. In later years he was their pensioner. He is said to have been put to strange use in the Revolution—passing in and out of Paris as an infant in a nurse's arms, but with despatches, dangerous to carry, in the little man's baby-wrappings!

Of dwarfs exhibited in England, the most celebrated was the Pole, Borulwaski (1739-1837). At six he measured 17 in., and

he finally in his thirtieth year reached 39 in. He had a sister shorter than himself by the head and shoulders. Borulwaski was a handsome man, a wit, and something of a scholar. He travelled over all Europe; and he—born in the reign of George II.—died in his well-earned retirement near Durham, in the reign of Victoria. Borulwaski lies buried at Durham by the side of the Falstaffian Stephen Kemble. The companionship reminds one of that of the dwarf skeleton of Jonathan Wild by the side of that of the Irish Giant, at the Royal College of Surgeons, London.

In the year in which Borulwaski died, Charles Stratton, better known as "General Tom Thumb," was born. When twenty-five he was 31 in. high. In 1844 he appeared in England, where he had an extraordinary success. One result of his season at the Egyptian Hall, London, was to kill Haydon the painter. The latter presented his great work "The Banishment of Aristides" for exhibition in the same building. The public rushed to see the dwarf. He took £600 the first week, while Haydon's masterpiece drew but £7, 13s. The result was that the artist committed suicide in despair. After extensive travel in both hemispheres, Stratton again visited England in 1857, but the dwarf man, despite many personal and intellectual qualities, was less attractive than the dwarf boy. In the year 1863 the "General" married the very minute American lady, Lavinia Warren (born in 1842). He died on the 15th of July 1883.

Other modern dwarfs include Signor Hervio Nano, who played at the Olympic Theatre, London, in 1843; three Highlanders named MacKinlay, children of a Scots shepherd, the shortest of whom was 45 in.; a Spaniard, Don Francisco Hidalgo (29 in.); a Dutchman, Jan Hannema (28 in.); and Mary Jane Youngman (Australia), who at fifteen was 35 in. high. She was called the "dwarf-giantess" because she was 3 ft. 6 in. round the shoulders, 4 ft. 3 in. round the waist, and 2 ft. round the leg. Much interest was aroused by the so-called Aztec dwarfs who were exhibited in London in 1853. In 1867 the pair were married, the ceremony being publicly performed, and the bride's robes are said to have cost no less than £2000. The wedding-breakfast was held at Willis's Rooms. From time to time other dwarfs have been exhibited, among whom the most remarkable has been Che-mah, a Chinese, 42 years old and 25 in. high, who appeared in London in 1880. George Prou (1774-1851), who was less than 3 ft. high, was a well-known character in London in the early Victorian period, as a messenger at the Houses of Parliament.

See E. J. Wood, *Giants and Dwarfs* (1860).

DWARS, a tract of country in north-east India. It consists of two divisions, the Western Dwargs and the Eastern Dwargs, both of which belonged to Bhutan prior to the Bhutan War of 1864-65, as a result of which they passed into possession of the British, when the Eastern Dwargs were assigned to Assam and the Western to Bengal. Since 1905 both divisions have been in the province of Eastern Bengal and Assam. The five Eastern Dwargs, entitled respectively Bijni, Sidli, Chirang, Ripu and Guma, are situated in the Goalpara district of Eastern Bengal and Assam, forming a strip of flat country lying beneath the Bhutan mountains. It is an unhealthy country for natives as well as Europeans, and is but slightly developed. The Western Dwargs form a region lying at the foot of the Himalayas in the north-east of the Jalpaiguri district of Eastern Bengal and Assam, which comprises nine *parganas*, namely, Bhalka, Bhatibari, Baxa, Chakao-Kshattriya, Madari, Lakshimpur, Maraghat, Mainaguri and Chengmari. The Western Dwargs are an important centre of the tea-planting industry.

DWIGHT, JOHN (d. 1703), the first distinguished English potter. One can only surmise as to his parentage, and the date of his birth has been variously given from 1637 to 1640. Apparently he was educated at Oxford, and in 1661 was appointed registrar and scribe to the diocese of Chester, and the same year he proceeded to the degree of B.C.L. of Christ Church, Oxford. He resided at Chester for some time and acted as secretary to four successive bishops. One of these, Bishop Hall, also held the rectory of Wigan, Lancashire, and Dwight seems to have resided in that town, for three of his children were baptized there between

1667 and 1671. In 1671, while he still apparently resided in Wigan, he was granted his first patent for "the mystery of transparent earthenware, commonly known by the names of porcelain or china, and of stoneware, vulgarly called Cologne ware." It is not believed that much, if any, work was executed at Wigan, and he probably removed to Fulham in 1672 or 1673, as his name first appears on the rate books of Fulham, where he was rated for a house in Bear Street, in 1674. He died in 1703, and his business was carried on by his descendants for some time, but with gradually diminishing success. It has been claimed that Dwight made the first porcelain in England, but there is no proof of this, though magnificent specimens of stoneware from his hands are in existence. The British Museum contains a number of the best of Dwight's pieces, of which the finest is the bust of Prince Rupert. Other specimens are in the Victoria and Albert Museum, and they are sufficient to establish Dwight's fame as a potter of the first rank. (See CERAMICS.)

DWIGHT, JOHN SULLIVAN (1813-1893), American writer on music, was born at Boston and educated at Harvard. He became a Unitarian minister, but abandoned this career and joined the Brook Farm settlement as a teacher of music and other subjects. In 1848 he settled as a musical critic at Boston, being best known as founder and editor of the *Journal of Music* (1852-1881), the most important musical periodical that has been published in America. He died on the 5th of September 1893.

G. W. Cooke edited his letters (1898) and also wrote a memoir (1899).

DWIGHT, THEODORE WILLIAM (1822-1892), American jurist and educationalist, cousin of Theodore Dwight Woolsey and of Timothy Dwight, was born on the 18th of July 1822 in Catskill, New York. His father, Benjamin Woolsey Dwight (1780-1850), an abolitionist and reformer, removed to Clinton, New York, in 1831. The son graduated at Hamilton College in 1840, studied physics under S. F. B. Morse and John William Draper, taught classics in Utica Academy in 1840-1841, and studied law for one year at Yale. He was tutor at Hamilton in 1841-1846, at the same time teaching law privately; was made Maynard professor of law, history, civil polity, and political economy in 1846; received recognition of his law school in 1853, and in 1858 accepted an invitation to Columbia to teach law upon his own condition that he should found a law school. He himself was this school for many years and did not retire from it until 1891, about a year before his death, at Clinton, New York, on the 28th of June 1892. A man of broad culture, he was best known as the founder of a famous school of law and a famous method of legal teaching, which was broadly educational and which called for class-room recitation on the text-book studied and opposed mere "taking notes" on lectures. His questioning was illustrative and its method Socratic. He was a non-resident professor of law at Cornell (1869-1871) and at Amherst (1870-1872). Dwight was an able jurist, frequently acted as referee in difficult questions, in 1874-1875 was a judge of the New York commission of appeals, appointed to clear the docket of the court of appeals, and in 1886 was counsel for the five Andover professors charged with heresy. He was a prominent figure in political and social (notably prison) reforms; published in 1867 a *Report on the Prisons and Reformatories of the United States and Canada*, the result of his labours on a New York state prison commission with Enoch Cobb Wines (1806-1870); favoured indeterminate sentences; drew up the bill for the establishment of the Elmira Reformatory; and organized the State Charities Aid Association. He edited Sir Henry Maine's *Ancient Law* (1864); was associate editor of the *American Law Register* and legal editor of *Johnson's Cyclopaedia*; and published *Charitable Uses: Argument in the Ross Will Case* (1863).

DWIGHT, TIMOTHY (1752-1817), American divine, writer, and educationalist, was born at Northampton, Massachusetts, on the 14th of May 1752. His father, Timothy Dwight, a graduate of Yale College (1744), was a merchant, and his mother was the third daughter of Jonathan Edwards. He was remarkably precocious, and is said to have learned the alphabet at a single lesson, and to have been able to read the Bible before he

was four years old. In 1769 he graduated at Yale College, and then for two years taught in a grammar school at New Haven. He was a tutor in Yale College from 1771 to 1777; and then, having been licensed to preach, was a chaplain for a year in a regiment of troops engaged in the War of Independence, inspiring the troops both by his sermons and by several stirring war songs, the most famous of which is "Columbia." From 1778 until 1783 he lived at Northampton, studying, farming, preaching, and dabbling in politics. From 1783 until 1795 he was pastor of the Congregational church at Greenfield Hill, Connecticut, where he opened an academy which at once acquired a high reputation and attracted pupils from all parts of the Union. From 1795 until his death at Philadelphia, Pennsylvania, on the 11th of January 1817, he was president of Yale College, and by his judicious management, by his remarkable ability as a teacher—he taught a variety of subjects, including theology, metaphysics, logic, literature and oratory,—and by his force of character and magnetic personality, won great popularity and influence, and restored that institution to the high place from which it had fallen before his appointment. President Dwight was also well known as an author. In verse he wrote an ambitious epic in eleven books, *The Conquest of Canaan*, finished in 1774, but not published until 1785; a somewhat ponderous and solemn satire, *The Triumph of Infidelity* (1788), directed against Hume, Voltaire and others; *Greenfield Hill* (1794), the suggestion for which seems to have been derived from John Denham's *Cooper's Hill*; and a number of minor poems and hymns, the best known of which is that beginning "I love thy kingdom, Lord." Many of his sermons were published posthumously under the titles *Theology Explained and Defended* (5 vols., 1818-1819), to which a memoir of the author by his two sons, W. T. and Sereno E. Dwight, is prefixed, and *Sermons by Timothy Dwight* (2 vols., 1828), which had a large circulation both in the United States and in England. Probably his most important work, however, is his *Travels in New England and New York* (4 vols., 1821-1822), which contains much material of value concerning social and economic New England and New York during the period 1796-1817.

See W. B. Sprague's "Life of Timothy Dwight" in vol. iv. (second series) of Jared Sparks's *Library of American Biography*, and especially an excellent chapter in Moses Coit Tyler's *Three Men of Letters* (New York, 1895).

His fifth son, **SERENO EDWARDS DWIGHT** (1786-1850), born in Greenfield Hill, Connecticut, graduated at Yale in 1803, was a tutor there in 1806-1810, and successfully practised law in New Haven in 1810-1816. Licensed to preach in 1816, he was the chaplain of the United States Senate for one year, was pastor of the Park Street church, Boston, in 1817-1826, and in 1833-1835 was president of Hamilton College, Clinton, New York. His career was wrecked by accidental mercury poisoning, which interfered with his work in Boston and at Hamilton College, and made his life after 1830 solitary and comparatively unfruitful. His publications include *Life and Works of Jonathan Edwards* (10 vols., 1830); *The Hebrew Wife* (1836), an argument against marriage with a deceased wife's sister; and *Select Discourses* (1851); to which was prefixed a biographical sketch by his brother William Dwight (1795-1865), who was also successively a lawyer and a Congregational preacher.

President Dwight's grandson, **TIMOTHY DWIGHT** (1828-), a famous preacher and educationalist, was born at Norwich, Connecticut, on the 16th of November 1828. He graduated at Yale in 1849, continued his studies there and at Bonn and Berlin, was professor of sacred literature and New Testament Greek in the Yale Divinity School from 1858 to 1886, was licensed to preach in 1861, and from 1886 to 1890 was president of Yale, which during his administration greatly prospered and became in name and in fact a university. Dr Dwight was also a member in 1876-1885 of the American committee for the revision of the English Bible, was an editor from 1866 to 1874 of the *New Englander*, which later became the *Yale Review*, and besides editing and annotating several volumes of the English translation of H. A. W. Meyer's *Kritisch-exegetischer Kommentar zum Neuen Testament*, and writing many magazine articles, published a

collection of sermons entitled *Thoughts of and for the Inner Life* (1896).

DYAKS, or DAYAKS, the name given to the wild tribes found in Borneo by the Malays on their first settlement there. Whether they are the aborigines of the island or the successors of a Negrito people whom they expelled is uncertain. If the latter, they are descendants of an early pre-Malayan immigration. In any case, though regarded by the Malays as aliens, the Dyaks are of the same stock as the Malays. For themselves they have no general name; but, broken as they are into numerous tribes, they are distinguished by separate tribal names, many of which seem to be merely those of the rivers on which their settlements are situated. Sir Harry Keppel, who attempted to form a classification of the Dyaks according to their ethnographical affinity, divides them into five principal branches. The first of these, which he calls the north-western, includes the natives of Sadong, Sarawak, Sambas, Landak, Tayan, Melionow and Sangow. They all speak the same language, and are remarkable for their dependence on the Malay princes. The second branch, which is called emphatically the Malayan from its greater retention of Malay characteristics, occupies the north coast in Banting, Batang-Lupar, Rejang and part of the valley of the Kapuas. To the third or Parian branch belong the Dyaks of the rivers Kuti and Passir, who are said to speak a language like that of Macassar. The fourth consists of the Beyadjoes, who are settled in the valley of the Banjermassin; and the fifth and lowest comprises the Manketans and Punans, who are still nomadic and ignorant of agriculture.

Physically the Dyaks differ little from the Malays except in their slimmer figure, lighter colour, more prominent nose and higher forehead. In disposition they are as cheerful as the Malay is morose. The typical Dyak is rather slightly built, but is active and capable of enduring great fatigue. His features are distinctly marked and often well formed. The forehead is generally high, and the eyes are dark; the cheek-bones are broad; the hair is black, and the colour of the skin a pure reddish brown, frequently, in the female, approaching the Chinese complexion. The beard is generally scanty, and in many tribes the men pull out all the hair of the face. Both sexes file, dye, and sometimes bore holes in the teeth and insert gold buttons. In dress there is considerable variety, great alterations having resulted from foreign influence. The original and still prevailing style is simple, consisting of a waistcloth, generally of blue cotton, for the men, and a tight-fitting petticoat for the women, who acquire a peculiar mincing gait from its interference with their walking. The favourite ornaments of both sexes are brass rings for the legs and arms, hoops of rattan decorated in various ways, necklaces of white and black beads, and crescent-shaped ear-rings of a large size. The lobes of the ears are distended sometimes nearly to the shoulders by disks of metal and bits of stick. Tattooing is practised by most of the tribes, and the skulls of infants are artificially deformed. The men usually go bare-headed, or wear a bright-coloured kerchief. The custom of betel-chewing being most universal, the betel-pouch is always worn at the side. The weapons in use are a curved sword and a long spear. The bow is unknown, but its place among some tribes is partly supplied by the blowpipe, in the boring of which they show great skill. When going to war the Dyak wears a strong padded jacket, which proves no bad defence. A curious custom among some tribes is the imprisonment of young girls for two or three years before puberty, during which time they are not allowed to see even their mothers.

The Dyak is decidedly intelligent, has a good memory and keen powers of observation, is unsuspecting and hospitable, and honest and truthful to a striking degree. The various tribes differ greatly in religious ceremonies and beliefs. They have no temples, priests or regular worship; but the father of each family performs rites. A supreme god, Sang-Sang, seems generally acknowledged, but subordinate deities are supposed to watch over special departments of the world and human affairs. Sacrifices both of animals and fruits—and in some cases even of human beings—are offered to appease or invoke the gods; divination of various kinds is resorted to for the purpose of

deciding the course to be pursued in any emergency; and criminals are subjected to the ordeal by poison or otherwise. Offerings are made to the dead, and there is a very strong belief in the existence of evil spirits, and all kinds of calamities and diseases are ascribed to their malignity. Thus almost the whole medical system of the Dyaks consists in the application of appropriate charms or the offerings of conciliatory sacrifices. Many of those natives who have had much intercourse with the Malays have adopted a kind of mongrel Mahommedanism, with a mixture of Hindu elements. The transmigration of souls seems to be believed in by some tribes; and some have a system of successive heavens rising one above the other very much in the style of the Hindu cosmogony. In the treatment of their dead much variety prevails; they are sometimes buried, sometimes burned, and sometimes elevated on a lofty framework. The Dyaks have no exact calculation of the year, and simply name the months first month, second month, and so on. They calculate the time of day by the height of the sun, and if asked how far distant a place is can only reply by showing how high the sun would be when you reached it if you set out in the morning.

In agriculture, navigation, and manufactures they have made some progress. In a few districts a slight sort of plough is used, but the usual instrument of tillage is a kind of cleaver. Two crops, one of rice and the other of maize or vegetables, are taken, and then the ground is allowed to lie fallow for eight or ten years. The inland Dyaks collect the forest products, rattan, gutta-percha, beeswax and edible birds' nests, and exchange them for clothing or ornaments, especially brass wire or brass guns in which consists the wealth of every chief. They spin and weave their own cotton, and dye the cloth with indigo of their own growing. Their iron and steel instruments are excellent, the latter far surpassing European wares in strength and fineness of edge. Their houses are neatly built of bamboos, and raised on piles a considerable height from the ground; but perhaps their most remarkable constructive effort is the erection of suspension bridges and paths over rivers and along the front of precipices, in which they display a boldness and ingenuity that surprise the European traveller. In the centre of most villages is the communal house where the unmarried men live, which serves as a general assembly hall. Some have a circuit of no less than 1000 ft. One on the banks of the Lundi was 600 ft. long and housed 400 persons.

The Dyaks have always been notorious for head-hunting, a custom which has now been largely suppressed. It is essentially a religious practice, the Dyak seeking a consecration for every important event of his life by the acquisition of one or more skulls. A child is believed ill-fated to whose mother the father has not at its birth presented skulls. The young man is not admitted to full tribal rights, nor can he woo a bride with any hope of success, until he has a skull or more to adorn his hut; a chief's authority would not be acknowledged without such trophies of his prowess. The strictest rules govern head-hunting: a period of fasting and confession, of isolation in a taboo hut, precedes the expedition, for which the Dyak clothes himself in the skins of wild beasts and puts on an animal mask. The Dyak curiously enough prefers the head of a fellow-tribesman, and the hunt is usually one of ambush rather than of open combat. Among some tribes it was not sufficient to kill the victim. He was tortured first, his body sprinkled with his own blood, and even his flesh eaten under the eyes of priests and priestesses who presided over the rites. Skulls, especially those of enemies, were held in great veneration. At meals the choicest morsels were offered them: they were supplied with betel and tobacco: fulsome compliments and prayers for success in battle addressed to them. Head-hunting at one time threatened the very existence of the race; but in spite of their reformation in this respect the Dyaks are not on the increase, a fact for which A. R. Wallace accounts by the hard life the women lead and their consequent slight fecundity.

The Dyaks speak a variety of dialects, most of which are still very slightly known. The tribes on the coast have adopted a great number of pure Malay words into common use, and it is

often hard to ascertain their own proper synonyms. The American missionaries have investigated the dialects of the west coast (Landak, &c.), and their Rhenish brethren have devoted their attention to those of the south, into one of which (that of Pulu Petak) a complete translation of the Bible has been made. Mr Hardeland, the translator, has also published a Dyak-German dictionary.

DYCE, ALEXANDER (1798–1869), English dramatic editor and literary historian, was born in Edinburgh on the 30th of June 1798. After receiving his early education at the high school of his native city, he became a student at Exeter College, Oxford, where he graduated B.A. in 1819. He took holy orders, and became a curate at Lanteglos, in Cornwall, and subsequently at Nayland, in Suffolk; in 1827 he settled in London. His first books were *Select Translations from Quintus Smyrnaeus* (1821), an edition of Collins (1827), and *Specimens of British Poetesses* (1825). He issued annotated editions of George Peele, Robert Greene, John Webster, Thomas Middleton, Marlowe, and Beaumont and Fletcher, with lives of the authors and much illustrative matter. He completed, in 1833, an edition of James Shirley left unfinished by William Gifford, and contributed biographies of Shakespeare, Pope, Akenside and Beattie to Pickering's *Aldine Poets*. He also edited (1836–1838) Richard Bentley's works, and *Specimens of British Sonnets* (1833). His carefully revised edition of John Skelton, which appeared in 1843, did much to revive interest in that trenchant satirist. In 1857 his edition of Shakespeare was published by Moxon; and the second edition, a great improvement on the old one, was issued by Chapman & Hall in 1866. He also published *Remarks on Collier's and Knight's Editions of Shakespeare* (1844); *A Few Notes on Shakespeare* (1853); and *Strictures on Collier's new Edition of Shakespeare* (1859), a contribution to the Collier controversy (see COLLIER, JOHN PAYNE), which ended a long friendship between the two scholars. He was intimately connected with several literary societies, and undertook the publication of Kempe's *Nine Days' Wonder* for the Camden Society; and the old plays of *Timon* and *Sir Thomas More* were published by him for the Shakespeare Society. He was associated with Halliwell-Phillips, John Payne Collier and Thomas Wright as one of the founders of the Percy Society, for publishing old English poetry. Dyce also issued *Recollections of the Table Talk of Samuel Rogers* (1856). He died on the 15th of May 1869. He had collected a valuable library, containing amongst other treasures many rare Elizabethan books, and this collection he bequeathed to the South Kensington Museum. He displayed untiring industry, abundant learning, and admirable critical acumen in his editions of the old English poets. His wide reading in Elizabethan literature enabled him to explain much that was formerly obscure in Shakespeare; while his sound judgment was a check to extravagance in emendation. While preserving all that was valuable in former editions, Dyce added much fresh matter. His *Glossary*, a large volume of 500 pages, was the most exhaustive that had appeared.

DYCE, WILLIAM (1806–1864), British painter, was born in Aberdeen, where his father, a fellow of the Royal Society, was a physician of some repute. He attended Marischal College, took the degree of M.A. at sixteen years of age, and was destined for one of the learned professions. Showing a turn for design instead, he studied in the school of the Royal Scottish Academy in Edinburgh, then as a probationer (not a full student) in the Royal Academy of London, and thence, in 1825, he proceeded to Rome, where he spent nine months. He returned to Aberdeen in 1826, and painted several pictures; one of these, "Bacchus nursed by the Nymphs of Nysa," was exhibited in 1827. In the autumn of that year he went back to Italy, showing from the first a strong sympathy with the earlier masters of the Florentine and allied schools. A "Virgin and Child" which he painted in Rome in 1828 was much noticed by Overbeck and other foreign artists. In 1829 Dyce settled in Edinburgh, taking at once a good rank in his profession, and showing considerable versatility in subject-matter. Portrait-painting for some years occupied much of his time; and he was particularly prized for

likenesses of ladies and children. In February 1837 he was appointed master of the school of design of the Board of Manufactures, Edinburgh. In the same year he published a pamphlet on the management of schools of this description, which led to his transfer from Edinburgh, after eighteen months' service there, to London, as superintendent and secretary of the then recently established school of design at Somerset House. Dyce was sent by the Board of Trade to the continent to examine the organization of foreign schools; and a report which he eventually printed, 1840, led to a remodelling of the London establishment. In 1842 he was made a member of the council and inspector of provincial schools, a post which he resigned in 1844. In this latter year, being appointed professor of fine art in King's College, London, he delivered a remarkable lecture, *The Theory of the Fine Arts*. In 1835 he had been elected an associate of the Royal Scottish Academy; this honour he relinquished upon settling in London, and he was then made an honorary R.S.A. In 1844 he became an associate, in 1848 a full member, of the London Royal Academy; he also was elected a member of the Academy of Arts in Philadelphia. He was active in the deliberations of the Royal Academy, and it is said that his tongue was the dread of the urbane President, Sir Charles Eastlake, for Dyce was keen in speech as in visage; it was on his proposal that the class of retired Academicians was established. In January 1850 Dyce married Jane, daughter of Mr James Brand, of Bedford Hill, Surrey. He died at Streatham on the 14th of February 1864, leaving two sons and two daughters.

Dyce was one of the most learned and accomplished of British painters—one of the highest in aim, and most consistently self-respecting in workmanship. His finest productions, the frescoes in the robing-room in the Houses of Parliament, did honour to the country and time which produced them. Generally, however, there is in Dyce's work more of earnestness, right conception, and grave, sensitive, but rather restricted powers of realization, than of authentic greatness. He has elevation, draughtsmanship, expression, and on occasion fine colour; along with all these, a certain leaning on precedent, and castigated semi-conventionalized type of form and treatment, which bespeak rather the scholarly than the originating mind in art. The following are among his principal or most interesting works (oil pictures, unless otherwise stated). 1829: "The Daughters of Jethro defended by Moses"; "Puck." 1830: "The Golden Age"; "The Infant Hercules strangling the Serpents" (now in the National Gallery, Edinburgh); "Christ crowned with Thorns." 1835: "A Dead Christ" (large lunette altarpiece). 1836: "The Descent of Venus," from Ben Jonson's *Triumph of Love*; "The Judgment of Solomon," prize cartoon in tempera for tapestry (National Gallery, Edinburgh). 1837: "Francesca da Rimini" (National Gallery, Edinburgh). 1838, and again 1846: "The Madonna and Child." 1839: "Dunstan separating Edwy and Elgiva." 1844: "Joash shooting the Arrow of Deliverance" (the finest perhaps of the oil-paintings). 1850: "The Meeting of Jacob and Rachel." 1851: "King Lear and the Fool in the Storm." 1855: "Christabel." 1857: "Titian's first essay in Colouring." 1859: "The Good Shepherd." 1860: "St John bringing Home his Adopted Mother"; "Pegwell Bay" (a coast scene of remarkably minute detail, showing the painter's partial adhesion to the "pre-Raphaelite" movement). 1861: "George Herbert at Bemerton." Dyce executed some excellent cartoons for stained glass:—that for the choristers' window, Ely Cathedral, and that for a vast window at Alnwick in memory of a duke of Northumberland; the design of "Paul rejected by the Jews," now at South Kensington, belongs to the latter. In fresco-painting his first work appears to have been the "Consecration of Archbishop Parker," painted in Lambeth palace. In one of the Westminster Hall competitions for the decoration of the Houses of Parliament, he displayed two heads from this composition; and it is related that the great German fresco-painter Cornelius, who had come over to England to give advice, with a prospect of himself taking the chief direction of the pictorial scheme, told the prince consort frankly that the English ought not to be asking for him, when they had such a painter

their own as Mr Dyce. The cartoon by Dyce of the "Baptism of Ethelbert" was approved and commissioned for the House of Lords, and is the first of the works done there, 1846, in fresco. In 1848 he began his great frescoes in the Robing-room—subjects from the legend of King Arthur, exhibiting chivalric virtue. The whole room was to have been finished in eight years; but ill-health and other vexations trammelled the artist, and the series remains uncompleted. The largest picture figures "Hospitality, the admission of Sir Tristram into the fellowship of the Round Table." Then follow—"Religion," the Vision of Sir Galahad and his Companions; "Generosity," Arthur unhorsed, and spared by the Victor; "Courtesy," Sir Tristram harping to la Belle Ysault; "Mercy," Sir Gawaine's Vow. The frescoes of sacred subjects in All Saints' church, Margaret Street, London; of "Comus," in the summer-house of Buckingham Palace; and of "Neptune and Britannia," at Osborne House, are also by this painter.

Dyce was an elegant scholar in more ways than one. In 1828 he obtained the Blackwell prize at Aberdeen for an essay on animal magnetism. In 1843-1844 he published an edition of the Book of Common Prayer, with a dissertation on Gregorian music, and its adaptation to English words. He founded the Motett Society, for revival of ancient church-music, was a fine organist, and composed a "non nobis" which has appropriately been sung at Royal Academy banquets. His last considerable writing relating to his own art was published in 1853, *The National Gallery: its Formation and Management*.

See Redgrave's *Dictionary of Artists* (1878), and *Dictionary of National Biography* (W. M. R.).

DYEING (O. Eng. *dedgian, deah*; Mid. Eng. *deyen*), the art of colouring textile and other materials in such a manner that the colours will not be readily removed by those influences to which they are likely to be submitted—e.g. washing, rubbing, light, &c. The materials usually dyed are those made from the textile fibres, silk, wool, cotton, &c., and intended for clothing or decoration; but in addition to these may be mentioned straw, fur, leather, paper, &c.

The art of dyeing dates from prehistoric times, and its practice probably began with the first dawn of civilization. Although we cannot trace the successive stages of its development from the beginning, we may suppose they were somewhat similar to those witnessed among certain uncivilized tribes to-day—e.g. the Maoris of New Zealand. At first the dyes were probably mere fugitive stains obtained by means of the juices of fruits, and the decoctions of flowers, leaves, barks and roots; but in course of time methods were discovered, with the aid of certain kinds of earth and mud containing alumina or iron, whereby the stains could be rendered permanent, and then it was that the true art of dyeing began. There is no doubt that dyeing was, in the early period of its history, a home industry practised by the women of the household, along with the sister arts of spinning and weaving, for the purpose of embellishing the materials manufactured for clothing.

Historical evidence shows that already at a remote period a high state of civilization existed in Persia, India, and China, and the belief is well founded that the arts of dyeing and printing have been practised in these countries during a long succession of ages. In early times the products and manufactures of India were highly prized throughout Southern Asia, and in due course they were introduced by Arabian merchants to Phœnicia and Egypt, with which countries commercial intercourse, by way of the Persian and Arabian Gulfs, seems to have existed from time immemorial. Eventually the Egyptians themselves began to practise the arts of dyeing and printing, utilizing no doubt both the knowledge and the materials derived from India. Pliny the historian has left us a brief record of the methods employed in Egypt during the first century, as well as of the Tyrian purple dye celebrated already 1000 B.C., while the chemical examination of mummy cloths by Thomson and Schunck testifies to the use by the Egyptian dyers of indigo and madder. The Phœnician and Alexandrian merchants imported drugs and dyestuffs into Greece, but we know little or nothing of the methods of dyeing pursued by

the Greeks and Romans, and such knowledge as they possessed seems to have been almost entirely lost during the stormy period of barbarism reigning in Europe during the 5th and succeeding centuries. In Italy, however, some remnants of the art fortunately survived these troublous times, and the importation of Oriental products by the Venetian merchants about the beginning of the 13th century helped to revive the industry. From this time rapid progress was made; and the dyers formed important guilds in Florence, Venice and other cities. It was about this time, too, that a Florentine named Rucellai rediscovered the method of making the purple dye orcliff from certain lichens of Asia Minor. In 1429 there was published at Venice, under the title of *Mariegola dell' arte de tentori*, the first European book on dyeing, which contained a collection of the various processes in use at the time. From Italy a knowledge of dyeing gradually extended to Germany, France and Flanders, and it was from the latter country that the English king Edward III. procured dyers for England, a Dyers' Company being incorporated in 1472 in the city of London.

A new impetus was given to the industry of dyeing by the discovery of America in 1492, as well as by the opening up of the way to the East Indies round the Cape of Good Hope in 1498. A number of new dyestuffs were now introduced, and the dyewood trade was transferred from Italy to Spain and Portugal, for the East Indian products now came direct to Europe round the Cape instead of by the old trade routes through Persia and Asia Minor. Eastern art-fabrics were introduced in increasing quantity, and with them came also information as to the methods of their production. In Europe itself the cultivation of dye-plants gradually received more and more attention, and both woad and madder began to be cultivated, about 1507, in France, Germany and Holland. Under the influence of Spain the Dutch largely developed their industries and made considerable progress in dyeing. The Spaniards, on their first arrival in Mexico (1518), noticed the employment of the red dyestuff cochineal by the natives, and at once imported it to Europe, where an increasing demand for the new colouring matter gradually developed in the course of the century. A further impetus was given to the trade by the Dutch chemist Drebbel's accidental discovery, in 1630, of the method of dyeing a brilliant scarlet on wool by means of cochineal and tin solutions. The secret was soon communicated to other dyers, and the new scarlet was dyed as a speciality at the Gobelins dyeworks in Paris, and some time later (1643) at a dyeworks in Bow, near London.

In 1662 the newly established Royal Society in London took a useful step in advancing the art of dyeing, and in order to inform and assist practical dyers, caused the publication of the first original account, in the English language, of the methods employed in dyeing, entitled "An apparatus to the history of the common practices of Dyeing." Ten years later the French Minister Colbert sought to improve as well as control the operations of dyeing, by publishing a code of instructions for the use of the woollen dyers and manufacturers in France. From this time, too, a succession of eminent chemists were appointed by the French government to devote some of their attention to the study of the industrial arts, including dyeing, with a view to their progress and improvement. Dujay, Hellot, Macquer, Berthollet, Roard and Chevreul (1700-1825) all rendered excellent service to the art, by investigating the chemical principles of dyeing, by publishing accounts of the various processes in vogue, by examining the nature and properties of the dyestuffs employed, and by explaining the cause of the several phenomena connected with dyeing. With the advent of the 18th century, certain old prejudices against the use of foreign dyewoods gradually disappeared, and very rapid progress was made owing to the birth of the modern chemistry and the discovery of several useful chemical products and processes—e.g. Prussian Blue (1710), Saxony Blue or Indigo Extract (1740), sulphuric acid (1774), murexide (1776), picric acid (1788), carbonate of soda (1793), bleaching powder (1798). Experiments on the practical side of bleaching and dyeing were made during this period, in England by Thomas Henry, Home and Bancroft, and in France by

Dambourney, Gouffroy and others, each of whom has left interesting records of his work.

Down to the middle of the 19th century natural dyestuffs alone, with but few exceptions, were at the command of the dyer. But already in the year 1834 the German chemist Runge noticed that one of the products obtained by distilling coal-tar, namely, aniline, gave a bright blue coloration under the influence of bleaching powder. No useful colouring matter, however, was obtained from this product, and it was reserved for the English chemist Sir W. H. Perkin to prepare the first aniline dye, namely, the purple colouring matter Mauve (1856). The discovery of other brilliant aniline dyestuffs followed in rapid succession, and the dyer was in the course of a few years furnished with Magenta, Aniline Blue, Hofmann's Violet, Iodine Green, Bismarck Brown, Aniline Black, &c. Investigation has shown that the products of the distillation of coal-tar are very numerous, and some of them are found to be specially suitable for the preparation of colouring matters. Such, for example, are benzene, naphthalene and anthracene, from each of which distinct series of colouring matters are derived. In 1869 the German chemists Graebe and Liebermann succeeded in preparing Alizarin, the colouring matter of the madder-root, from the coal-tar product anthracene, a discovery which is of the greatest historical interest, since it is the first instance of the artificial production of a vegetable dyestuff. Another notable discovery is that of artificial Indigo by Baeyer in 1878. Since 1856, indeed, an ever-increasing number of chemists has been busily engaged in pursuing scientific investigations with the view of preparing new colouring matters from coal-tar products, and of these a few typical colours, with the dates of their discovery, may be mentioned: Cachou de Laval (1873); Eosin (1874); Alizarin Blue (1877); Xylidine Scarlet (1878); Biebrich Scarlet (1879); Congo Red (1884); Primuline Red (1887); Rhodamine (1887); Paranitraniline Red (1889); Alizarin Bordeaux (1890); Alizarin Green (1895). At the present time it may truly be said that the dyer is furnished with quite an embarrassing number of coal-tar dyestuffs which are capable of producing every variety of colour possessing the most diverse properties. Many of the colours produced are fugitive, but a considerable number are permanent and withstand various influences, so that the general result for some years has been the gradual displacement of the older natural dyestuffs by the newer coal-tar colours.

During this period of discovery on the part of the chemist, the mechanical engineer has been actively engaged in devising machines suitable for carrying out, with a minimum of manual labour, all the various operations connected with dyeing. This introduction of improved machinery into the dyeing trade has resulted in the production of better work, it has effected considerable economy, and may be regarded as an important feature in modern dyeing.

The art of dyeing is a branch of applied chemistry in which the dyer is continually making use of chemical and physical principles in order to bring about a permanent union between the material to be dyed and the colouring matter applied. If cotton or wool is boiled in water containing finely powdered charcoal, or other insoluble coloured powder, the material is not dyed, but merely soiled or stained. This staining is entirely due to the entanglement of the coloured powder by the rough surface of the fibre, and a vigorous washing and rubbing suffices to remove all but mere traces of the colour. True dyeing can only result when the colouring matter is presented to the fibre in a soluble condition, and is then, by some means or other, rendered insoluble while it is absorbed by, or is in direct contact with, the fibre. There must always be some marked physical or chemical affinity existing between fibre and colouring matter, and this depends upon the physical and chemical properties of both. It is well known that the typical fibres, wool, silk and cotton, behave very differently towards the solution of any given colouring matter, and that the method of dyeing employed varies with each fibre. As a general rule wool has the greatest attraction for colouring matters, and dyes most readily; cotton has the least attraction, while silk occupies

in this respect an intermediate position. These differences may be to some extent due to differences of physical structure in the fibres, but they are mainly due to their different chemical composition.

On the other hand, a given fibre, e.g. cotton, behaves quite differently in dyeing towards various colouring matters. Some of these are not at all attracted by it, and are incapable of being used as dyestuffs for cotton. For others cotton exhibits a marked attraction, so that it is readily dyed by mere steeping in a hot solution of the colouring matter. Again, for other colouring matters cotton has little or no attraction, and cannot be dyed with them until it has been previously impregnated or prepared with a metallic salt, tannic acid or some other agent which is capable of combining with the colouring matter and precipitating it as an insoluble coloured compound within or upon the fibre. Such differences of behaviour are to be ascribed to differences in the chemical constitution or atomic arrangement of the various colouring matters.

In the case of the coal-tar colours we are, for the most part, well acquainted with their chemical constitution, and in accordance with this knowledge the chemist has arranged them in the following groups:—(1) Nitro Colours. (2) Azo Colours, including Amido-azo, Oxy-azo, Tetrazo and Polyazo Colours. (3) Hydrazone Colours. (4) Oxy-quinone Colours, including Quinone-oxime Colours. (5) Diphenylmethane and Triphenylmethane Colours, including Rosaniline, Rosolic acid and Phthalene Colours. (6) Quinoneimide Colours, including Indamine, Indophenol, Thiazine, Thiazone, Oxazine, Oxazone, Azine, Induline, Quinoxaline and Fluorindine Colours. (7) Aniline Black. (8) Quinoline and Acridine Colours. (9) Thiazol Colours. (10) Oxy-ketone, Xanthone, Flavone and Coumarine Colours. (11) Indigo. (12) Colours of unknown constitution.

This arrangement of the colouring matters in natural chemical groups is well suited for the requirements of the chemist, but another classification is that based on the mode of their application in dyeing. This is much simpler than the previous one, and being better adapted for the practical purposes of the dyer, as well as for explaining the various methods of dyeing, it is preferred for this article. According to this arrangement colouring matters are classified under the following groups:—(1) Acid Colours. (2) Basic Colours. (3) Direct Colours. (4) Developed Colours. (5) Mordant Colours. (6) Miscellaneous Colours. (7) Mineral Colours. It is well to state that there is no sharp line of division between some of these groups, for many colours are applicable by more than one method, and might quite well be placed in two, or even three, of the above groups. This may be due either to the kind of fibre to which the colouring matter is to be applied, or to certain details in the chemical constitution of the latter which give it a twofold character.

ACID COLOURS.—These dyestuffs are so called because they dye the animal fibres wool and silk in an acid bath; they do not dye cotton. From a chemical point of view the colouring matters themselves are of an acid character, this being due to the presence in the molecule of nitro (NO_2) or sulphonic acid (HSO_3) groups. According to their origin and constitution they may be distinguished as nitro compounds, sulphonated azo compounds and sulphonated basic colours. The acid colours are usually sold in the form of their alkali salts, as variously coloured powders soluble in water. For the alkali salts in neutral or alkaline solution wool and silk have little or no affinity, but dyeing rapidly occurs if the solution is acidified with sulphuric acid whereby the colour-acid is liberated. This addition of acid, however, is necessary not only to set free the colour-acid of the dyestuff, but also to alter partially the chemical composition of the fibre, and thus render it capable of uniting more readily with the free colour-acid. It has been shown, namely, that if wool is boiled with dilute sulphuric acid, and then thoroughly washed with boiling-water till free from acid, it acquires the property of being dyed with acid colours even in neutral solution. By this treatment a portion of the wool substance is converted into so-called *lanuginic acid*, which has a strong attraction for the colour-acid of the dyestuff, with which it forms an insoluble coloured compound. For dyeing wool, the general rule is to charge the dyebath with the amount of dyestuff necessary to give the required colour, say from $\frac{1}{2}$ to 2 or 6% on the weight of wool employed, along with 10% sodium sulphate (Glauber's salt) and 4% sulphuric acid (1.84 sp. gr.). The woollen material is then

General principles.

introduced and continually handled or moved about in the solution, while the temperature of the latter is gradually raised to the boiling point in the course of $\frac{1}{2}$ to 1 hour; after boiling for $\frac{1}{2}$ to 1 hour longer, the operation is complete, and the material is washed and dried.

In practice, modifications of this normal process may be introduced, in order to ensure the dyeing of an even colour, *i.e.* free from such irregularities as cloudiness, streaks, &c., which may be due to the quality of the material or to the special properties of the acid colour employed. Materials of a firm, close texture, also the existence of a strong affinity between fibre and colouring matter, do not generally lend themselves to the dyeing of even colours, or to a satisfactory penetration of the material. Some acid colours dye even colours without any difficulty; others, however, do not. The addition of sodium sulphate to the dyebath exerts a restraining action; the dyeing therefore proceeds more slowly and regularly, and a more equal distribution and better absorption of the colouring matter takes place. Other devices to obtain even colours are: the use of old dye-liquors, a diminished amount of acid, the employment of weaker acids, *e.g.* acetic or formic acid or ammonium acetate, and the entering of the material at a low temperature.

In the application of so-called Alkali Blue the process of dyeing in an acid bath is impossible, owing to the insolubility of the colour- acid in an acid solution. Wool and silk, however, possess an affinity for the alkali salt of the colouring matter in neutral or alkaline solution, hence these fibres are dyed with the addition of about 5% borax; the material acquires only a pale colour, that of the alkali salt, in this dyebath, but by passing the washed material into a cold or tepid dilute solution of sulphuric acid a full bright blue colour is developed, due to the liberation of the colour-acid within the fibres. In the case of other acid colours, *e.g.* Chromotrope, Chrome Brown, Chromogen, Alizarin Yellow, &c., the dyeing in an acid bath is followed by a treatment with a boiling solution of bichromate of potash, alum, or chromium fluoride, whereby the colouring matter on the fibre is changed into insoluble oxidation products or colour-lakes. This operation of developing or fixing the colour is effected either in the same bath at the end of the dyeing operation, or in a separate bath. See also *Artificial Mordant Colours*.

When dyeing with certain acid colours, *e.g.* Eosine, Phloxine and other allied bright pink colouring matters derived from resorcin, the use of sulphuric acid as an assistant must be avoided, since the colours would thereby be rendered paler and duller, and only acetic acid must be employed.

The properties of the dyes obtained with the acid colours are extremely varied. Many are fugitive to light; on the other hand, many are satisfactorily fast, some even being very fast in this respect. As a rule, they do not withstand the operations of milling and scouring very well, hence acid colours are generally unsuitable for tweed yarns or for loose wool. They are largely employed, however, in dyeing other varieties of woollen yarn, silk yarn, union fabrics, dress materials, leather, &c. Previous to the discovery of the coal-tar colours very few acid colours were known, the most important one being Indigo Extract. Prussian Blue as applied to wool may also be regarded as belonging to this class, also the purple dyestuff known as Archil or Cudbear.

The following list includes some of the more important acid colours now in use, arranged according to the colour they yield in dyeing:—

Red.—Wool scarlet, brilliant scarlet, erythrine, crocea scarlet, brilliant crocin, violamine G, scarlet 3R, crystal scarlet, new cocine, chromotrope 2R, azo acid magenta, Victoria scarlet, xyridine scarlet, Palatine scarlet, Biebrich scarlet, pyrotine, orchil red, Bordeaux B, milling red, azo carmine, acid magenta, fast acid violet A 2R, naphthylamine red, fast red, claret red, eosine, erythrosine, rose Bengale, phloxine, cyanosine, cloth red, lanafuchsine, rosinduline, erio carmine.

Orange.—Diphenylamine orange, methyl orange, naphthol orange, crocin orange, brilliant orange, orange G, orange N, mandarin G R.

Yellow.—Picric acid, naphthol yellow S, fast yellow, brilliant yellow S, azoflavine, metanil yellow, resorcin yellow, tartrazine, quinoline yellow, milling yellow, azo yellow, Victoria yellow, brilliant yellow S, citronine, Indian yellow.

Green.—Acid green, guinea green, fast green, patent green, cyanol green, erio green, brilliant acid green G.

Blue.—Alkali blue, soluble blue, opal blue, methyl blue, Höchst new blue, patent blue, ketone blue, cyanine, thiocarmine, fast blue, induline, violamine 3 B, azo acid blue, wool blue, indigo extract, erio glucine, erio cyanine, erio blue, lanacyl blue, sulphon-azurine, sulphon-cyanine.

Violet.—Acid violet, red violet, regina violet, formyl violet, violamine B, fast violet, azo acid violet, erio violet, lanacyl violet.

Brown.—Fast brown, naphthylamine brown, acid brown, resorcin brown, azo brown, chrome brown, chromogene.

Black.—Naphthol black, azo black, wool black, naphthylamine black, jet black, anthracic black, Victoria black, azo acid black, brilliant black, union black, brilliant black B.

BASIC COLOURS.—These colouring matters are the salts of organic colour-bases, their name being derived from the fact that their dyeing power resides entirely in the basic part of the salt. In the free state the bases are colourless and insoluble, but in combination

with acids they form salts which are coloured and for the most part soluble in water. They are usually sold in the form of powder or crystals, the latter exhibiting frequently a beautiful metallic lustre. Wool and silk are dyed in a neutral bath, *i.e.* without any addition, the material not requiring any previous preparation. During the dyeing operation the animal fibres appear to play the part of an acid, for they decompose the colouring matter and unite with the colour-base to form an insoluble coloured salt or lake, while the acid of the colouring matter is liberated and remains in solution. Although, as a rule, a neutral dyebath is employed in dyeing wool, a slight addition (2%) of soap is sometimes made in order to give a brighter colour, while in other cases, *e.g.* with Victoria Blue, the dyebath must of necessity be made distinctly acid with acetic or sulphuric acid. Silk is usually dyed in a bath containing "boiled-off liquor" (*i.e.* the spent soap-liquor from the operation of scouring) neutralized or slightly acidified with acetic or tartaric acid. For a full colour use 2 or 3% colouring matter, enter the wool at a low temperature, heat gradually to near the boiling point in the course of $\frac{1}{2}$ hour, and continue dyeing for $\frac{1}{2}$ hour. Owing to the slight solubility of many basic colours, it is important to take the precaution of filtering the colour solution into the dyebath through a flannel filter, also to neutralize the alkalinity of calcareous water with a little acetic acid, to prevent decomposition of the colouring matter and precipitation of the colour-base.

Unlike the animal fibres, cotton has little or no affinity for the basic colours; hence the cotton dyer makes use of the fact that cotton has a natural attraction for tannic acid, and that the latter forms insoluble lakes with the bases of basic colours. Previous to dyeing, the cotton is prepared with tannic acid by steeping in a cold solution of the latter for several hours; cotton pieces are run at full width through a solution containing 2 to 6 oz. per gallon of tannic acid, and after being evenly squeezed are dried on steam cylinders. The cotton is then worked in a solution of tartar emetic or stannic chloride, so that the tannic acid absorbed by the fibre may be fixed upon it as insoluble tannate of antimony or tin. Although the tannic acid is thus united with metallic oxide, it still has the power of attracting the base of the colouring matter, and there is fixed upon the fibre an insoluble colour-lake, namely, a tannate of antimony and colour-base, which constitutes the dye. In this process the tannic acid is called the *mordant*, the tartar emetic acts as the *fixing-agent* for the tannic acid, and the cotton as finally prepared for dyeing is said to be *mordanted*. The proportions employed, reckoned on the weight of cotton, may vary from 2 to 10% tannic acid, or the equivalent in a decoction of sumach, myrabolans, or other tannin matter, and $\frac{1}{2}$ to 3% tartar emetic. After mordanting and fixing of the mordant, the cotton is well washed and dyed in the cold or at 60° C. for $\frac{1}{2}$ to 1 hour with the necessary colouring matter. Applied in this manner, basic colours are moderately fast to soap, but generally not to the action of light.

Linen is dyed in the same manner as cotton. Jute is dyed without any previous preparation, since it behaves like a tannin-mordanted fibre, attracting the basic colours direct.

The basic colours, to which class most of the earlier coal-tar colours belonged, are remarkable for their great colouring power, and in most cases for the brilliancy of the colours they yield. With the exception of certain dark colours, they are fugitive to light. It is interesting to note that the only one vegetable colouring matter is at present recognized as belonging to this class, namely, the yellow dyestuff barberry bark and root (*Berberis vulgaris*) which contains the alkaloid berberine.

The following is a list of the more important basic colours derived from coal-tar:—

Red.—Magenta, safranin, rhodamine, pyronine red, rhoduline red, roazein, induline scarlet.

Orange.—Chrysoidine, phosphine, acridine orange, tannin orange.

Yellow.—Auramine, benzoflavine, thioflavine T, acridine yellow, homophosphine, rhoduline yellow.

Green.—Malachite green, emerald green, imperial green, China green, brilliant green, Victoria green, diamond green, methylene green, azine green.

Blue.—Methylene blue, new methylene blue, toluidine blue, thionine blue, indamine blue, Victoria blue, night blue, Nile blue, turquoise blue, marine blue, indofine blue, metamine blue, Capri blue, indazine, methaphenylene blue, paraphenylene blue, tolylene blue, indigene, indol blue, diphen blue, setopaline, setocyanine, setoglauine, Helvetia blue.

Violet.—Methyl violet, crystal violet, ethyl purple, methylene violet, mauve, paraphenylene violet, rhoduline violet, methylene heliotrope.

Brown.—Bismarck brown.

Black.—Diazine black.

Grey.—Methylene grey, nigrisine, new grey.

DIRECT COLOURS.—The characteristic feature of the dyestuffs belonging to this class is that they dye cotton "direct" *i.e.* without the aid of mordants. Two distinct series of colouring matters of this group may be distinguished—namely, *Direct Cotton Colours* and *Sulphide Colours*.

(a) *Direct Cotton Colours.*—The colours of this class are frequently called the Substantive Cotton Colours, Benzo Colours, Diamine Colours, Congo Colours. Considered from the chemical point of

view, they are mostly alkali salts of sulphonated tetrazo colours obtained by diazotising certain diamido compounds, e.g. benzidine, diamido-stilbene, &c. and uniting the products thus obtained with various amines or phenols. The first colouring matter of this class was the so-called Congo red, discovered in 1884, and since that time a very great number have been introduced which yield almost every variety of colour. The method of dyeing cotton consists in merely boiling the material in a solution of the dyestuff, when the cotton absorbs and retains the colouring matter by reason of a special natural affinity. The concentration of the dyebath is of the greatest importance, since the amount of colour taken up by the fibre is in an inverse ratio to the amount of dye liquor present in the bath. The addition of 1 to 3 oz. sodium sulphate and $\frac{1}{2}$ to $\frac{3}{4}$ oz. carbonate of soda per gallon gives deeper colours, since it diminishes the solubility of the colouring matter in the water and increases the affinity of the cotton for the colouring matter. An excess of sodium sulphate is to be avoided, otherwise precipitation of the colouring matter and imperfect dyeing result. With many dyestuffs it is preferable to use $\frac{1}{2}$ to $\frac{3}{4}$ oz. soap instead of soda. On cotton the dyed colours are usually not very fast to light, and some are sensitive to alkali or to acid, but their most serious defect is that they are not fast to washing, the colour tending to run and stain neighbouring fibres. Their fastness to light and washing is, however, greatly improved by a short ($\frac{3}{4}$ hour) after-treatment with a boiling solution of copper sulphate ($\frac{3}{4}$ %), with or without the addition of bicarbonate of potash (1 %). Wool and silk are dyed with the direct colours either neutral or with the addition of a little acetic acid to the dyebath. On these fibres the dyed colours are usually faster than on cotton to washing, milling and light; some are very fast even to light—e.g. Diamine fast red, chrysofenine, Hessian yellow, &c. Many of the Direct Colours are very useful for dyeing plain adhesions on union fabrics composed of wool and cotton, silk and cotton, or wool and silk. Owing to the facility of their application, they are also very suitable for use as household dyes, especially for cotton goods.

A few vegetable dyestuffs belong to this class, notably Turmeric, saffron, annatto and safflower, but they all yield colours which are fugitive to light, and they are now of little importance. Turmeric is the underground stem or tuber of *Curcuma tinctoria*, a plant growing abundantly in the East Indies. It dyes cotton, wool and silk in a bath acidified with acetic acid or alum, yielding a bright yellow colour which is turned brown by alkalis. Saffron consists of the stigmata of the flower of *Crocus sativus*, which is grown in Austria, France and Spain. It dyes a bright orange-yellow colour. Annatto is the pulpy mass surrounding the seeds of *Bixa orellana*, a plant which grows in South America—e.g. Brazil, Cayenne, &c. It dyes cotton and silk in an alkaline or soap bath an orange colour, which is turned red by acids. Safflower consists of the dried florets of *Carthamus tinctorius*, which is grown in the East Indies, Egypt and southern Europe. Cotton is dyed a brilliant pink colour by working it in a cold alkaline (sodium carbonate) extract of the colouring matter, while gradually acidifying the solution with citric acid (lime-juice).

The Direct Colours which are derived from coal-tar products are very numerous indeed; they are largely employed, and occupy a very important position among dyestuffs. The following list includes the principal coal-tar colours of this group—

Red.—Congo red, brilliant Congo, benzopurpurine, brilliant purpurine, delta-purpurine, diamine scarlet, diamine fast red, rosaurine, salmon red, erica, Titan pink, St Denis red, Columbia red, naphthylene red, Congo rubine, acetopurpurine, dianol red, thiamine crimson, geranine, brilliant geranine, Columbia fast scarlet, benzo fast scarlet, thiamine red, diamine rose, Dongola red, rosophenine.

Orange.—Congo orange, benzo orange, toluylene orange, mikado orange, brilliant orange, Columbia orange, diamine orange, pyramine orange, benzo fast orange.

Yellow.—Chrysofenine, cresotin yellow, diamine yellow, carbazol yellow, chrysofenine, Hessian yellow, curcume yellow, thiazol yellow, thioflavine S, oriol, mimosa yellow, Columbia yellow, cotton yellow, chloramine yellow, direct yellow, diamine fast yellow, diamine gold, sun yellow, stilbene yellow, chlorophenine, oxphenine.

Green.—Benzo olive, Columbia green, benzo green, diamine green, direct green, diphenyl green, oxamine green, eboi green.

Blue.—Azo blue, benzoazurine, brilliant azurine, sulphon-azurine, diamine blue, benzo indigo blue, benzo black blue, Chicago blue, Columbia blue, Erie blue, Zambezi blue, benzo cyanine, Congo blue, diamine sky blue, brilliant benzo blue, benzo chrome black blue, oxamine blue, diphenyl blue, diaminceral blue, diaminogene, benzo fast blue, diazo indigo blue, brilliant chlorazol blue.

Violet.—Hessian purple, Congo Corinth, heliotrope, Congo violet, diamine violet, Hessian violet, azo violet, benzo violet, violet black, diamine Bordeaux, chlorantine lilac, diphenyl violet, triazol violet, Columbia violet.

Brown.—Benzo brown, Congo brown, toluylene brown, diamine brown, cotton brown, Hessian brown, terra-cotta, mikado brown, catechu brown, wool brown, Columbia brown, Zambezi brown, benzo chrome brown, direct fast brown, direct bronze brown, chloramine brown, triazol brown, toluylene brown, dianol brown, Crumppall direct fast brown.

Black.—Diamine black, Columbia black, Nyansa black, Tabora black, Zambezi black, chromanil black, benzo black, benzo fast

black, direct blue black, Pluto black, oxydiamine black, diamine jet black, polyphenyl black, union black, triazol black, Titan black, cotton black, oxamine black.

Grey.—Benzo grey, benzo black, azo mauve, diaminogene, neutral grey.

(b) **Sulphide Colours.**—These dyestuffs are only suitable for dyeing the vegetable fibres, since they must be applied in a strongly alkaline bath. The dyestuff Cachou de Laval, discovered in 1873, was the first member of this group, and was obtained by melting a mixture of sodium sulphide and various organic substances—e.g. bran, sawdust, &c. In recent years numerous other dyestuffs have been added to the list, namely, grey, blue, green, brown, and especially black colours, by submitting certain definite amido compounds of the aromatic series to a similar treatment with sodium sulphide or sodium thiosulphate, and subsequent oxidation. The mode of dyeing with these colours is based on the fact that they are soluble in an alkaline reducing agent, and if the cotton is worked in the solution, subsequent oxidation develops the colour, which is fixed upon the fibre in an insoluble condition. The material is boiled for about one hour in a solution of the colour (10 to 15 %), with the addition of sodium carbonate (1 to 10 %), common salt (10 to 20 %), and sodium sulphide (5 to 30 %); it is then washed in water, and may be developed by heating in a bath containing 2 to 5 % of bichromate of soda, and 3 to 6 % acetic acid. A final washing with water containing a little soda to remove acidity is advisable. The sulphide colours are remarkable for their fastness to light, alkalis, acids and washing, but unless proper care is exercised the cotton is apt to be tendered on being stored for some time.

The following list includes some of the most important of the colours of this class—

Yellow.—Immedial yellow, pyrogene yellow, sulphur yellow, thion yellow, thiogene yellow.

Orange.—Eclipse phosphine, immedial orange, pyrogene orange, thion orange, thiogene orange.

Green.—Pyrogene green, Italian green, eclipse green, pyrol green, immedial green, katigene green, thionol green.

Blue.—Immedial blue, immedial sky blue, eclipse blue, katigene indigo, pyrogene blue, sulphur blue, thion blue, thiogene blue.

Violet.—Katigene violet, thiogene heliotrope, thiogene purple.

Brown.—Pyrogene brown, pyrogene yellow, Cachou de Laval, thiocatechine, katigene black brown, eclipse brown, immedial brown, katigene brown, dianol brown.

Grey and Black.—Pyrogene grey, Vidal black, immedial black, katigene black, anthraquinone black, St Denis black, amidazol black, cross dye black, eclipse black, carbide black, thiogene black, sulphaniiline black, sulfogene black, pyrogene black, dianol black, sulphur black, thion black, kryogene black.

This class of colours is continually increasing in number, and for certain purposes in cotton dyeing the group has acquired great importance.

DEVELOPED COLOURS.—This group includes certain azo colours which are developed or produced upon the fibre itself (usually cotton) by the successive application of their constituent elements. It may be conveniently divided into the following sub-groups—

Insoluble Azo Colours, Developed Direct Colours, Benzo Nitrol Colours.

(a) The **Insoluble Azo Colours** are produced as insoluble coloured precipitates by adding a solution of a diazo compound to an alkaline solution of a phenol, or to an acid solution of an amido compound. The necessary diazo compound is prepared by allowing a solution containing nitrous acid to act upon a solution of a primary aromatic amine. It is usually desirable to keep the solutions cool with ice, owing to the very unstable nature of the diazo compounds produced. The colour obtained varies according to the particular diazo compound, as well as the amine or phenol employed, β -naphthol being the most useful among the latter. The same coloured precipitates are produced upon the cotton fibre if the material is first impregnated with an alkaline solution of the phenol, then dried and passed into a cold solution of the diazo solution. The most important of these colours is *para-nitraniline red*, which is dyed in enormous quantities on cotton pieces. The pieces are first "prepared" by running them on a padding machine through a solution made up of 30 grms. β -naphthol, 20 grms. caustic soda, 50 grms. Turkey red oil, and 5 grms. tartar emetic in 1000 grms. (1 litre) water. They are then dried on the drying-machine, and are passed, after being allowed to cool, into the diazo solution, which is prepared as follows: 15 grms. *para-nitraniline* are dissolved in 53 c.c. hydrochloric acid (34° Tw.) and a sufficiency of water. To the cold solution a solution of 101 grms. sodium nitrite is added while stirring. The whole is then made up to 1200 c.c., and just before use 60 grms. sodium acetate are added. The colour is developed almost immediately, but it is well to allow the cotton to remain in contact with the solution for a few minutes. The dyed cotton is squeezed, washed, soaped slightly, and finally rinsed in water and dried. A brilliant red is then obtained which is fast to soap but not to light. If the *para-nitraniline* used in the foregoing process is replaced by *meta-nitraniline*, a yellowish-orange colour is obtained; with *naphthylamine*, a claret-red; with *amido-azo-toluene*, a brownish red; with *benzidine*, a dark chocolate; with *dianisidine*, a dark blue; and so on. The dyed colours are fast to washing and are much used in practice, particularly the

paranitraniline red, which serves as a substitute for Turkey-red, although it is not so fast to light as the latter.

(b) *Developed Direct Colours*.—The primuline colours were the first representatives of this class and are derived from the yellow dyestuff known as primuline, which dyes cotton in the same manner as the direct colours. The primuline yellow thus obtained is fugitive to light and of little practical value, but since the colouring matter is an amido base it can be diazotized in the fibre and then developed in solutions of phenols or amines, whereby azo dyes of various hues may be obtained, according to the developer employed; thus, β -naphthol develops a bright red colour, resorcin develops an orange, phenol a yellow, naphthylamine a brown, &c. The dyeing of the primuline yellow is effected by boiling the cotton for one hour in a solution of primuline (5%) and common salt (10 to 20%). The *diazotizing* operation consists in passing the dyed and rinsed cotton for 5 to 10 minutes into a cold solution of nitrous acid—i.e. a solution of $\frac{1}{2}$ oz. sodium nitrite per gallon of water, slightly acidified with sulphuric acid. The diazotized material should not be exposed to light, but at once washed in cold water and passed into the developer. The *developing* process consists in working the diazotized material for 5 to 10 minutes in a cold solution of the necessary phenol, and finally washing with water. The only developer of any practical importance is a solution of β -naphthol in caustic soda, which produces primuline red. The primuline colours are best adapted for cotton dyeing, and the colours obtained are fast to washing and to moderate soaping, but they are not very fast to light.

If cotton is dyed with other direct colours containing free amido groups, the colour can be diazotized on the dyed fibre exactly in the same manner as in the case of primuline-dyed cotton, and then developed by passing into the solution of an amine or phenol, or by treating it with a warm solution of sodium carbonate. In this manner a new azo dye is produced upon the fibre, which differs from the original one not only in colour, but also by being faster to washing and other influences. A treatment with copper sulphate solution after development is frequently beneficial in rendering the colour faster to light. Some Direct Colours, indeed, are of little value, owing, for example, to their sensibility to acids, until they have been diazotized and developed, the usual developers being β -naphthol, resorcinol, phenol and phenylene-diamine.

The following Direct Colours, after being applied to cotton, may be submitted to the above treatment, the colours produced being chiefly blue, brown and black:—

Blue.—Diazurine, diazo blue, diamine blue, diaminoene.

Red.—Rosanthene.

Brown.—Diazo brown, diamine cutch, diamine brown, cotton brown.

Grey and Black.—Benzo blue, diazo blue black, diazo black, diamine black, diazo brilliant black.

(c) *Benzo Nitrol Colours*.—These are certain Direct Colours, dyed on cotton in the ordinary manner, which are then developed by passing into a diazo solution—e.g. diazotized para-nitraniline, &c. The dyed colour here plays the part of a phenol or amine, and reacts with the diazo compound to produce a new colour. The process is similar to the production of the Insoluble Azo Colours, the β -naphthol which is there applied to the fibre being here replaced by a Direct Colour. The colour of the latter is rendered much deeper by the process, and also faster to washing and to the action of acids. The dyestuffs recommended for application in the manner described are: Benzo nitrol brown, tolylene brown, direct fast brown, Pluto black, direct blue black.

"*Topping*" Direct Colours.—The direct colours possess the remarkable property of precipitating the basic colours from aqueous solution. Use is frequently made of this property for "topping" cotton dyed with direct colours either with a view to obtain compound shades or to brighten the colour. Thus by dyeing cotton first yellow in chrysamine and then dyeing it again in a cold bath of methylene blue a brilliant shade of green results. If, on the other hand, a direct blue is topped with methylene blue, its brilliancy may be enhanced.

MORDANT COLOURS.—The colouring matters of this class include some of the most important dyestuffs employed, since they furnish many colours remarkable for their fastness to light, washing and other influences. Employed by themselves, Mordant Colours are usually of little or no value as dyestuffs, because, with few exceptions, either they are not attracted by the fibre, particularly in the case of cotton, or they only yield a more or less fugitive stain. Their importance and value as dyestuffs are due to the fact that they act like weak acids and have the property of combining with metallic oxides to form insoluble coloured compounds termed "lakes," which vary in colour according to the metallic oxide or salt employed. The most stable lakes are those in which the colouring matter is combined with two metallic oxides, a sesquioxide and a monoxide—e.g. alumina and lime. In applying colouring matters of this class the object of the dyer is to precipitate and fix these coloured lakes upon and within the fibre, for which purpose two operations are necessary, namely, *mordanting* and *dyeing*.

The *mordanting* operation aims at fixing upon the fibre the necessary metallic oxide or insoluble basic salt, which is called the *mordant*, although the term is also applied to the original metallic salt employed. In the subsequent dyeing operation the mordanted material

is boiled with a solution of the colouring matter, during which the metallic oxide attracts and chemically combines with the colouring matter, producing the coloured lake *in situ* on the fibre, which thus becomes dyed. The mode of applying the mordants varies according to the nature of the fibre and the metallic salt employed, the chief mordants at present in use being salts of chromium, aluminium, tin, copper and iron. The method of mordanting wool depends upon its property of decomposing metallic salts, and fixing upon itself an insoluble metallic compound, when boiled in their solutions. This decomposition is facilitated by the heating and by the dilution of the solution, but it is chiefly due to the action of the fibre itself. The exact nature of the substance fixed upon the fibre has not in all cases been determined; probably it is a compound of the metallic oxide with the wool-substance itself, which has the character of an amido-acid. The mordant most largely employed for wool is bichromate of potash, since, besides being simply applied, and leaving the wool with a soft feel, it yields with the various mordant-dyestuffs a large variety of fast colours. The wool is boiled for 1 to 1½ hours in a solution containing 2 to 3% bichromate of potash on the weight of the wool employed. During this operation the wool at first attracts chromic acid, which is gradually reduced to chromium chromate, so that the mordanted fibre has finally a pale olive-yellow tint. In the dyebath, under the influence of a portion of the dyestuff, further complete reduction to chromic hydrate occurs before it combines with the colouring matter. Not unfrequently certain so-called "assistants" are employed in small amount along with the bichromate of potash—e.g. sulphuric acid, cream of tartar, tartaric acid, lactic acid, &c. The use of the organic acids here mentioned ensures the complete reduction of the chromic acid on the wool to chromic hydrate already in the mordant bath, and the pale greenish mordanted wool is better adapted for dyeing with colours which are susceptible to oxidation—e.g. alizarin blue. For special purposes chromium fluoride, chrome alum, &c., are employed. Alum or aluminium sulphate (8%), along with acid potassium tartrate (cream of tartar) (7%), is used for brighter colours—e.g. reds, yellows, &c. The object of the tartar is to retard the mordanting process and ensure the penetration of the wool by the mordant, by preventing superficial precipitation through the action of ammonia liberated from the wool; it ensures the ultimate production of clear, bright, full colours. For still brighter colours, notably yellow and red, stannous chloride was at one time largely employed, now it is used less frequently; and the same may be said of copper and ferrous sulphate, which were used for dark colours. Silk may be often mordanted in the same manner as wool, but as a rule it is treated like cotton. The silk is steeped for several hours in cold neutral or basic solutions of chromium chloride, alum, ferric sulphate, &c., then rinsed in water slightly, and passed into a cold dilute solution of silicate of soda, in order to fix the mordants on the fibre as insoluble silicates. Cotton does not, like wool and silk, possess the property of decomposing metallic salts, hence the methods of mordanting this fibre are more complex, and vary according to the metallic salts and colouring matters employed, as well as the particular effects to be obtained. One method is to impregnate the cotton with a solution of so-called "sulphated oil" or "Turkey-red oil"; the oil-prepared material is then dried and passed into a cold solution of some metallic salt—e.g. aluminium acetate, basic chromium chloride, &c. The mordant is thus fixed on the fibre as a metallic oleate, and after a passage through water containing a little chalk or silicate of soda to remove acidity, and a final rinsing, the cotton is ready for dyeing. Another method of mordanting cotton is to fix the metallic salt on the fibre as a tannate instead of an oleate. This is effected by first steeping the cotton in a cold solution of tannic acid or in a cold decoction of some tannin matter, e.g. sumach, in which operation the cotton attracts a considerable amount of tannic acid; after squeezing, the material is steeped for an hour or more in a solution of the metallic salt, and finally washed. The mordants employed in this case are various—e.g. basic aluminium or ferric sulphate, basic chromium chloride, stannic chloride (cotton spirits), &c. There are other methods of mordanting cotton besides those mentioned, but the main object in all cases is to fix an insoluble metallic compound on the fibre. It is interesting to note that whether the metallic oxide is united with the substance of the fibre, as in the case of wool and silk, or precipitated as a tannate, oleate, silicate, &c., as in the case of cotton or silk, it still has the power of combining with the colouring matter in the dyebath to form the coloured "lake" or dye on the material.

The *dyeing* operation consists in working the mordanted material in a solution of the necessary colouring matter, the dyebath being gradually raised to the boiling point. With many colouring matters, e.g. with alizarin, it is necessary to add a small percentage of calcium acetate to the dyebath, and also acetic acid if wool is being dyed. In wool-dyeing, also, the mordanting operation may follow that of dyeing instead of preceding it, in which case the boiling of the wool with dyestuff is termed "stuffing," and the subsequent developing of the colour by applying the mordant is termed "saddening," because this method has in the past been usually carried out with iron and copper mordants, which give dull or sad colours. The method of "stuffing and saddening" may, however, be carried out with other mordants, even for the production of bright colours, and it is now frequently employed with certain alizarin dyestuffs

for the production of pale shades which require to be very even and regular in colour. There is still another method of applying Mordant Colours in wool-dyeing, in which the dyestuff and the mordant are applied simultaneously from the beginning; it is known as the "single-bath method." It is only successful, however, in the case of certain colouring matters and mordants, to some of which reference will be made in the following paragraphs.

The Natural Mordant Colours.—It is interesting to note that nearly all the natural or vegetable dyestuffs employed belong to the class of Mordant Colours, the most important of these being included in the following list:—*Madder, Cochineal, Peachwood, Sapanwood, Limawood, Camwood, Barwood, Sanderswood, Old Fustic, Young Fustic, Quercitron Bark, Persian Berries, Weld, Logwood.* *Madder* consists of the dried ground roots of *Rubia tinctorum*, a plant of Indian origin. Formerly cultivated largely in France and Holland, it was long one of the most important dyestuffs employed, chiefly in the production of Turkey-red and in calico-printing, also in wool-dyeing. With the different mordants it yields very distinct colours, all fast to light and soap, namely, red with aluminium, orange with tin, reddish brown with chromium, purple and black with iron. *Madder* contains two closely allied colouring matters, namely, alizarin and purpurin. The former, which is by far the more important, is now prepared artificially from the coal-tar product anthracene, and has almost entirely superseded *madder*.

Cochineal is the dried scale-insect *Coccus cacti*, which lives on certain of the cactus plants of Mexico and elsewhere. The rearing of cochineal was once a large and important industry, and although still pursued, it has seriously declined, in consequence of the discovery of the azo scarlets derived from coal-tar. The colouring matter of cochineal, carminic acid, is believed by chemists to be a derivative of naphthalene, but its artificial production has not yet been accomplished. *Cochineal* dyes a purple colour with chromium mordant, crimson with aluminium, scarlet with tin, and grey or slate with iron. Its chief employment is for the purpose of dyeing crimson, and more especially scarlet, on wool. *Crimson* is dyed by mordanting the wool with alum and tartar and dyeing in a separate bath with ground cochineal. *Scarlet* on wool is obtained by the single-bath method, namely, by dyeing the wool with a mixture of stannous chloride (or nitrate of tin), oxalic acid, and cochineal. It is usual to add also a small amount of the yellow dyestuff flavine in order to obtain a yellowish shade of scarlet. The cochineal colours are very fast to light, but somewhat susceptible to the action of alkalis.

Peachwood, Sapanwood and *Limawood* are usually referred to as the "soluble red-woods," because of the solubility in water of the colouring principle they contain. They consist of the ground wood of various species of *Caesalpinia* found in Central America, the East Indies and Peru. They all yield more or less similar colours with the different mordants—claret-brown with chromium, red with aluminium, bright red with tin, dark slate with iron. Owing to the fugitive character of all the colours to light, these dyewoods are now comparatively little employed in dyeing.

Camwood, Barwood and *Sanderswood* represent the so-called "insoluble red-woods," their colouring principles being sparingly soluble even in boiling water. They are obtained from certain species of *Pterocarpus* and *Baphia*, large trees growing in the interior of West Africa. Their general dyeing properties are similar, a claret-brown being obtained with chromium mordant, a brownish red with aluminium, a brighter red with tin, and purplish brown with iron. Their chief employment is in wool-dyeing, for the production of various shades of brown, being best applied by the "stuffing and maddening" method above described; but since the colours are fugitive to light, they are now very largely replaced by alizarin. A brown on wool is obtained by first boiling for one to two hours in a decoction of the ground wood (50%), and then boiling in a separate bath in solution of bichromate of potash (2%) for half an hour. These dye-woods are also employed by the indigo-dyer, in order to give a brownish ground colour to the wool previous to dyeing in the indigo vat, and thus obtain a deeper, fuller blue. The colouring matters contained in these dyewoods have not been exhaustively examined.

Fustic is a yellow dyestuff, and consists of the wood of the dyer's mulberry tree, *Morus tinctoria*, which grows in Cuba, Jamaica, &c. It is still an important and largely used dyestuff, being cheap, and the colours obtained from it being satisfactorily fast to light and other influences. With chromium mordant it yields an olive-yellow or "old-gold" shade; with aluminium, yellow; with tin, a brighter yellow; with iron, an olive-green. It is chiefly employed in wool-dyeing along with other dyestuffs, and furnishes the yellow in compound shades. Two colouring principles exist in *Old Fustic*, namely, morin and maclurin, the former being the most important, and generally regarded as the true colouring matter.

Quercitron Bark consists of the inner bark of an oak-tree, *Quercus tinctoria*, which grows in the North American States. It dyes somewhat like *Old Fustic*, but gives with aluminium and tin mordants brighter yellows, for which colours it is chiefly used. The colouring principle of *Quercitron Bark* is called quercitrin, which by the action of boiling mineral acid solutions is decomposed, with the production of the true colouring matter termed quercetin.

So-called *Flavine* is a commercial preparation of Quercitron Bark consisting of quercitrin or of quercetin; it is much used by wool-dyers for the production of bright yellow and orange colours. Wool is dyed in single bath by boiling with a mixture of Flavine (8%), stannous chloride (4%) and oxalic acid (2%). Flavine is used in small quantity along with cochineal for dyeing scarlet on wool.

Persian Berries are the dried unripe fruit of various species of *Rhamnus* growing in the Levant. The general dyeing properties are similar to those of Quercitron Bark, the orange colour given with tin mordant being particularly brilliant. The high price of this dyestuff causes its employment to be somewhat limited. The colouring matter of *Persian Berries* is called xanthorhamnin, which by the action of fermentation and acids yields the true dyestuff rhamnetin.

Weld is the dried plant *Reseda luteola*, a species of wild mignonette, formerly largely cultivated in Europe. Its dyeing properties resemble those of Quercitron Bark, but the yellows with aluminium and tin mordants are much brighter and purer, and also faster to light. It is still used to a limited extent for dyeing a bright yellow on woollen cloth and braid for the decoration of military uniforms. Quite recently the colouring matter of *Weld*, namely, luteolin, has been prepared artificially, but the process is too expensive to be of practical use.

Logwood is the heart-wood of *Haematoxylon campechianum*, a tree growing in Central America. It is the most important natural dyewood at present employed, being largely used for dyeing dark blues and black on silk, wool and cotton. With chromium and aluminium mordants logwood dyes a dark blue, and even black; with tin, a dark purple; and with iron, black. The colours are only moderately fast to light. On wool the mordant is bichromate of potash; on cotton and silk an iron mordant is employed. Before use by the dyer the logwood is ground and aged or oxidized, by allowing moistened heaps of the ground wood to ferment slightly, and by frequently turning it over to expose it freely to the air. By this means the colouring principle haematoxylin which logwood contains is changed into the true colouring matter haematein. The constitution of this colouring matter has been recently discovered; it is very closely allied to the brazillin of peachwood, sapanwood and limawood, and is also a member of the γ -pyrone group of colouring matters.

The importance of the above-mentioned natural dyestuffs is gradually diminishing in favour of mordant dyestuffs and others derived from coal-tar. *Fustic* and *logwood* are perhaps the most largely used, and may continue to be employed for many years, no satisfactory artificial substitutes having hitherto come into the market.

The Artificial Mordant Colours are well represented by alizarin, the colouring matter of the *madder* root, which was the first natural dyestuff prepared artificially from the coal-tar product anthracene (1868). For this reason many of these colours are frequently referred to as the Alizarin Colours. At the present time, however, there are numerous Mordant Colours which are prepared from other initial materials than anthracene; they are not chemically related to alizarin, and for these the term Alizarin Colours is therefore inappropriate. The property, which Mordant Colours possess in common, of combining with metals and producing lakes, which readily adhere to the fibre, depends upon their chemical constitution, more particularly upon the general and relative position in the molecule of certain side atomic groups. In alizarin there are, for example, two characteristic hydroxyl groups (OH) occupying a special (ortho) position in the molecule, i.e. they are next to each other, and also next to one of the so-called ketone groups (C=O). In other Mordant Colours there are carboxyl (COOH) as well as hydroxyl groups, which are all-important in this respect. In addition to this, the general dyeing property is influenced by the constitution of the molecule itself, and by the presence of other side-groups, e.g. NH₂, HSO₃, &c., which modify the colour as to solubility, or hue. Hence it is that the members of this group, while possessing the mordant-dyeing property in common, differ materially in other points. Some, like alizarin, are not in themselves to be regarded as colouring matters, but rather as colouring principles, because they only yield useful dyes in combination with metallic oxides. According to their constitution, these may yield one or many colours with the various metallic oxides employed, and they are used for cotton as well as for wool and silk. Other Mordant Colours, e.g. many of the Direct Colours and others, are capable of dyeing either the vegetable or animal fibres without the aid of a mordant; they are fully developed colouring matters in themselves, and possess the mordant-dyeing property as an additional feature, in consequence of the details of their chemical constitution, to which reference has been made in the foregoing paragraphs. As a rule these yield, at most, various shades of the colour with the different oxides, and are only suitable for the animal fibres, particularly wool.

In the following list, the most important artificial Mordant Colours are arranged according to the colour they give in conjunction with the aluminium mordant, unless otherwise indicated. Some of those named here dye the animal fibres, even without mordants; some are Direct Colours possessing mordant-dyeing

properties, others are sulphonic acid derivatives of Alizarin Colours, suitable for wool but not for cotton.

Red.—Alizarin, anthrapurpurin, flavopurpurin, purpurin, alizarin Bordeaux, alizarin garnet R, alizarin maroon, alizarin S, cloth red, diamine fast red, anthracene red, chrome red, chrome Bordeaux, salicine red, erio chrome red, emin red, milling red.

Orange and Yellow.—Alizarin orange, alizarin orange G, alizarin yellow paste, alizarin yellow A, alizarin yellow C, anthracene yellow, galloflavin, alizarin yellow GG, alizarin yellow R, diamond flavin G, chrome yellow D, Crumpall yellow, fast yellow, diamond yellow, benzo orange R, cloth orange, carbasol yellow, chryamine, milling orange.

Green.—Coerulein, coerulein S, alizarin green S, fast green (Fe), naphthol green (Fe), Dioxin (Fe), Gambine (Fe), azo green, gallian green, alizarin green G and B, acid alizarin green, alizarin cyanine green, alizarin viridine, diamond green, chrome green, Domingo green.

Blue.—Alizarin blue, alizarin blue S, alizarin cyanine, anthracene blue, brilliant alizarin blue, alizarin indigo blue S, gallianic indigo, acid alizarin blue, brilliant alizarin cyanine, alizarin griolet, alizarin sky blue, alizarin saphirole, gallianic blue, delphine blue, gallamine blue, celestine blue, chrome blue, gallazine A, phenocyanine, coreine.

Purple and Violet.—Gallein, alizarin heliotrope, anthraquinone violet, chrome prime, gallocyanine, chrome violet, anthracene chrome violet.

Brown.—Anthracene brown, chromogen, cloth brown, diamond brown, alizarin brown, fast brown, alizarin acid brown, chrome brown, palatine chrome brown, erio chrome brown.

Black.—Alizarin black, diamond black, alizarin blue black, alizarin cyanine black, alizarin fast grey, chromotrope, chrome black, erio chrome black, anthracite black, acid alizarin black, anthracene chrome black.

A brief description of the application of a few of the more important of the above colouring matters will suffice.

Alizarin, Anthrapurpurin and Flavopurpurin give somewhat similar shades with the different mordants, namely, brown with chromium, red with aluminium, orange with tin, and purple with iron.

In wool-dyeing they are applied along with other Mordant Colours on chromium mordant for the production of a large variety of compound shades, browns, drabs, greys, &c. the presence of acetic acid in the dyebath being advantageous. When alum and tartar mordant is employed, for the production of reds, it is necessary to add a small amount (4%) of calcium acetate to the dyebath, in order to neutralize the strong acidity of the mordanted wool, and to furnish the calcium of the colour-lake fixed upon the fibre, which is regarded as an aluminium-calcium compound of the colouring matter.

In cotton-dyeing the above colouring matters are chiefly used for the production of so-called Turkey-red, a colour remarkable for its brilliancy and its fastness to light and soap. These properties are due to the preparation of the cotton with oil, in addition to the ordinary mordanting and dyeing, whereby there is fixed on the fibre a permanent and stable lake, in which aluminium and calcium are combined with alizarin and some form of fatty oxy-acid. In the older process employed, the preparation of the cotton with oil was effected by passing the material several times through emulsions of olive oil and potassium carbonate solution; at a later date, and even now in the case of cloth, the cotton is first impregnated with hot oil (Steiner's process), then passed through solutions of alkali carbonate. After the preparation with oil or oil-emulsions, the cotton is "stoved," i.e. heated for several hours in special chambers or stoves to a temperature of about 70° C., during which operation the oil is decomposed and oxidized and becomes indelibly attached to the fibre. The oil-prepared cotton is steeped in cold solutions of basic aluminium sulphate or acetate, washed, dyed with alizarin, and finally boiled for several hours with soap solution under pressure in order to brighten the colour. In the more recent and much more expeditious "sulphated-oil process" castor oil is employed instead of olive oil, and before use it is submitted to a treatment with sulphuric acid, the sulphated oil thus obtained being finally more or less neutralized with alkali. The cotton is impregnated with this sulphated-oil solution, dried, mordanted with aluminium acetate, dyed, dried, steamed and soaped. The operation of steaming plays an important part in brightening and fixing the colour-lake on the fibre. In these and all other Turkey-red processes, the oil, probably in the form of a fatty oxy-acid, acts as a fixing agent for the aluminium and enters into the composition of the red lake, imparting to it both brilliancy and permanency.

Alizarin S is a sulphonic acid derivative of alizarin, and since it is much more soluble, it readily yields level colours. Silk is dyed in a similar manner to wool, the fibre being mordanted by the ordinary methods and then dyed in a separate bath.

Domingo Fast Red is applied to cotton as a Direct Colour, with the addition of soda or soap to the dyebath. By treating the dyed colour with a solution of fluoride of chromium, its fastness to washing is materially increased. Wool is dyed in a similar manner, sodium sulphate being added to the dyebath, and the dyed colour treated with fluoride of chromium or bichromate of potash. On wool, the colour is so extremely fast to light and to milling that it may well serve as a substitute for alizarin.

Alizarin Orange is employed in the same manner as alizarin. In wool-dyeing it is usually applied on chromium mordant for browns and a variety of compound shades in combination with other Alizarin Colours and dyewood extracts, less frequently on aluminium mordant.

Galloflavin is used in wool and silk dyeing on chromium mordant as a substitute for fustic and other yellow dyewoods, to furnish the yellow part of compound shades.

The alizarin yellows, R and GG, anthracene yellow, diamond flavine, chrome yellow, diamond yellow, carbasol yellow, chryamine, &c., are Direct Colours with mordant-dyeing properties. They also serve as substitutes for fustic in wool or silk dyeing, and are dyed either on a chromium mordant, or first in an acid bath and afterwards saddened with bichromate of potash.

Coerulein is employed in dyeing wool, silk or cotton with aluminium or chromium mordants, either as a self-colour or for compound shades. With aluminium mordant the colour is a moderately bright green, more particularly on silk; with chromium mordant, an olive-green. Coerulein S is the more soluble bisulphite compound of the ordinary coerulein. It is applied in the same manner; care being taken, however, to dye for some time (one hour) at a temperature not exceeding 60° C. until the bath is nearly exhausted, and then only raising the temperature to the boiling point. Without this precaution coerulein S is decomposed, and the ordinary insoluble coerulein is precipitated. The colours obtained are very fast to light.

Fast Green, Dioxin and Gambine are chiefly of use in calico-printing and in wool-dyeing. With iron mordant they yield olive-greens, which on wool are extremely fast to light. Cotton is impregnated with ferrous acetate, dried, aged and fixed with silicate of soda, then dyed in a neutral bath. Wool is mordanted with ferrous sulphate and tartar (3% of each) and dyed in a neutral bath.

Acid Alizarin Green, Alizarin Cyanine Green and Diamond Green all dye wool direct in a bath acidified with acetic or sulphuric acid, and the dyed colour may be afterwards fixed or saddened with bichromate of potash, or they may be dyed on chromium-mordanted wool. The first method is very useful for pale shades, since the colours are very level or regular.

Alizarin Blue is a dark blue dyestuff which, owing to the fastness of the colours it yields, has for many years been regarded as a worthy substitute for indigo in wool-dyeing. It is applied in the same manner as alizarin, the chromium mordant being alone employed. Alizarin blue S is the soluble sodium bisulphite compound of alizarin blue; it corresponds, therefore, to the above-mentioned coerulein S, and in its application the same precautions as to the temperature of the dyebath are necessary. The fastness of the dyed colours to light, milling and acid satisfy the highest requirements.

Alizarin Cyanine, Anthracene Blue and Brilliant Alizarin Blue were discovered later than the above-mentioned alizarin blues, and, owing to their greater solubility and other advantages, they have largely replaced them as substitutes for indigo. They are dyed on chromium-mordanted wool, silk or cotton, and yield dark purplish or greenish blue, according to the particular brand employed. The fastness of the dyed colours to light, and general durability, are very satisfactory, but in fastness to milling and acids they are to some extent inferior to alizarin blue.

Celestine Blue and Chrome Blue dye purplish blue and bright blue respectively, and are dyed in the ordinary way upon a chromium mordant. The colours they yield are inferior to the Alizarin Colours in fastness to light, but on account of their clear shades they are often used for brightening other colours.

Brilliant Alizarin Cyanine, Alizarin Viridine and Alizarin Saphirole are true Alizarin Colours, and possess the same fastness to light as other colours of this class. Unlike most of the Alizarin Colours, they are capable of dyeing wool satisfactorily without the aid of a metallic mordant—namely, with the addition of sulphuric acid to the dyebath, in the same manner as the Acid Colours. If necessary, the dyed colours may be treated with bichromate of potash. The colours thus produced are very fast to light and very level, hence these dyestuffs are valuable in the production of the most delicate compound shades, such as drabs, slate, greys, &c., which are desired to be fast to light. Alizarin saphirole dyes clear blue, the colour produced being much more brilliant even than those of brilliant alizarin cyanine.

Gallein, Gallocyanine, and especially Chrome Violet, dye somewhat bright purple shades, and are hence frequently employed for brightening other colours, but they are only moderately fast to light. They are applied in the usual manner on a chromium mordant.

Anthracene Brown is largely employed in the production of compound shades. It dyes a dark, somewhat reddish, brown on chromium mordant, the colour being very even and extremely fast to light.

Alizarin Black is dyed on chromium mordant in the same manner as alizarin, and is used as a self-colour or in combination with other Alizarin Colours.

Diamond Black is very useful for dyeing good blacks on wool, fast to light and acids. The wool is first dyed with the addition of acetic and finally sulphuric acid. When the dyebath is exhausted,

bichromate of potash (2%) is added, and boiling is continued for half an hour longer.

The *orio chroma colours* (black, brown, red, &c.) are applied in wool dyeing like diamond black.

Chromatops, of which there are several brands, is an Acid Colour which is applied to wool in an acid bath in the usual manner. The red or purple colours thus obtained are saddened in the same bath with bichromate of potash and changed into black, the colouring matter being oxidized and simultaneously combined with chromium.

MISCELLANEOUS COLOURS.—Under this head there may be arranged a few dyestuffs which, although capable of inclusion under one or other of the foregoing groups, it is more convenient to treat of separately. Indigo, Aniline Black and Catechu, for example, might be placed in the class of Developed Colours, since they are all developed on the fibre, and indeed by the same method, namely, by oxidation.

Indigo is one of our most important blue dyestuffs, which has been employed from the earliest times. Indigo, being insoluble in water, would be of no use in dyeing if it were not capable of being rendered soluble. This is effected in two ways, corresponding to which there are two methods of dyeing with indigo. One method consists in dissolving the indigo in very strong sulphuric acid, whereby it is converted into indigotin-disulphonic acid (Indigo Extract), which is readily soluble in water. This substance belongs to the group of Acid Colours; hence it is applied to the animal fibres—wool and silk, by boiling in a solution of the colouring matter slightly acidified with sulphuric acid. The second and most important method is based on the fact that under the influence of reducing agents (*i.e.* substances capable of yielding nascent hydrogen) indigo blue is changed into indigo white, which is soluble in alkali, the solution thus obtained being called a "vat." If textile materials are steeped in a clear yellow solution of the reduced indigo and then exposed to air, the indigo white absorbed by the fibre is oxidized and reconverted into indigo blue within and upon the fibre, which thus becomes dyed blue; this is the so-called "indigo-vat" method of dyeing. Comparing the two methods, the "indigo-extract" method is only applicable to the animal fibres, and although it gives brighter colours, they are fugitive to light and are decolorized by washing with alkaline solutions; the "vat method" is applicable to all fibres, and gives somewhat dull blues, which are very fast to light, washing, &c.

Cotton is dyed by means of the "lime and copperas vat," the "zinc powder vat," or the "hydrosulphite vat." In the first-mentioned vat the ingredients are quicklime, ferrous sulphate and finely ground indigo; the lime decomposes the ferrous sulphate and precipitates ferrous hydrate; this quickly reduces the indigo to indigo white, which dissolves in the excess of lime present. The ingredients of the zinc powder vat are zinc powder, lime and indigo; in the presence of the lime and indigo the zinc takes up oxygen from the water, liberating the hydrogen necessary to reduce the indigo, as in the previous vat. The constituents of the hydrosulphite vat are hydrosulphite of soda, lime and indigo. The requisite hydrosulphite of soda is prepared by allowing zinc powder (13 lb) to act upon a cold concentrated solution of bisulphite of soda (17 gallons of sp. gr. 1.225), taking care to avoid, as much as possible, access of air and any heating of the mixture, to prevent decomposition. The solution thus obtained is thoroughly neutralized by the addition of lime; and after settling, the clear liquor is used for the vat, along with indigo and lime. Here again the hydrosulphite takes up oxygen from the water and liberates the necessary hydrogen. It is found convenient to prepare, in the first instance, a very concentrated standard of reduced indigo, and to add as much of this to the dye-vat as may be required, along with lime and a little hydrosulphite of soda. The advantages of this vat are that it is easily prepared and that there is very little sediment; moreover, it can be employed in dyeing wool, as well as cotton, and it is now very generally in use. The vat usually employed for dyeing wool is the so-called "wood vat," which differs from the foregoing in that the hydrogen necessary to reduce the indigo and bring it into solution is furnished, not by the action of chemical agents, but by means of fermentation. The ingredients of the wood vat are indigo, wood, bran, madder and lime. The wood here employed is prepared by grinding the leaves of the wood plant (*Isatis tinctoria*) to a paste, which is allowed to ferment and then partially dried. It serves as the ferment to excite lactic and butyric fermentation with the aid of the bran and madder, the necessary hydrogen being thus evolved. Excessive fermentation is avoided by making timely additions of lime; sluggish fermentation is accelerated by additions of bran and slightly raising the temperature. When the reduction and complete solution of the indigo is effected, the vat is allowed to settle, and the woollen material is immersed and moved about in the clear liquor for half an hour to two hours, according to the shade required, then squeezed and exposed to the air in order to develop the blue-colour on the fibre.

This indigo red is an artificial colouring matter belonging to the indigo series and comes into the market in the form of a paste. It is used in dyeing in exactly the same way as indigo, yielding shades which range from a somewhat dull pink to a full claret shade of red. The colours obtained are remarkable for their fastness.

Indanthrene. This colouring matter, which is also sold as a paste,

is an anthracene derivative, being formed by the action of caustic potash on β -amidoanthraquinone. It is reduced by hydrosulphite of soda yielding a blue vat, in which cotton and other vegetable fibres are dyed in the same way as in the indigo vat. Since a fair amount of caustic soda is necessary for the setting of the vat, the dyestuff is not suitable for animal fibres. Indanthrene yields on cotton reddish shades of blue which are extremely fast to all external influences; in fact the colour is so fast that when once fixed on cotton it cannot be removed again from the fibre by any known means.

Other vat colours belonging to this series, which are similarly applied, are flavanthrene (yellow), viridanthrene (green), fuscantanthrene (grey-brown), violanthrene (dull violet) and melanthrene (grey to black). The *alcol colours* resemble the indanthrene colours in their properties and application.

Aniline Black differs from other dyes in that it is not sold as a ready-made dyestuff, but is produced *in situ* upon the fibre by the oxidation of aniline. It is chiefly used for cotton, also for silk and cotton-silk union fabrics, but seldom or not at all for wool.

Properly applied, this colour is one of the most permanent to light and other influences with which we are acquainted. One method of dyeing cotton is to work the material for about two hours in a cold solution containing aniline (10 parts), hydrochloric acid (20 parts), bichromate of potash (20 parts), sulphuric acid (20 parts), and ferrous sulphate (10 parts). The ferrous sulphate being employed is oxidized by the chromic acid to a ferric salt, which serves as a carrier of oxygen to the aniline. This method of dyeing is easily carried out, and it gives a good black; but since much of the colouring matter is precipitated on the fibre superficially as well as in the bath itself, the colour has the defect of rubbing off. Another method is to impregnate the cotton with a solution containing aniline hydrochloride (35 parts), neutralized with addition of a little aniline oil, sodium chloride (70 parts), ammonium chloride (10 parts). Another mixture is 1.8 part aniline salt, 12 parts potassium ferrocyanide, 200 parts water, 3.5 parts potassium chlorate dissolved in water. After squeezing, the material is passed through a special oxidation chamber, the air of which is heated to about 50° C. and also supplied with moisture. This oxidizing or ageing is continuous, the material passing into the chamber at one end in a colourless condition, and after about 20 minutes passing out again with the black fully developed, a final treatment with hot chromic acid solution and soaping being necessary to complete the process. In this method, employing the first-mentioned solution, chlorate of copper is formed, and this being a very unstable compound, readily decomposes, and the aniline is oxidized by the liberated chlor-oxygen compounds. The presence in the mixture of a metallic salt is very important in aiding the development of the black, and for this purpose salts of vanadium, cerium and copper have proved to be specially useful. The chemistry of aniline black is still incomplete, but it would appear that there are several oxidation products of aniline. The first product is so-called emeraldine, a dark green substance of the nature of a salt, which by treatment with alkali yields a dark blue base called aurine. The further oxidation of emeraldine yields nigraniline, also a dark green salt, but the free base of which has a violet black colour. The latter becomes greenish under the influence of acids, especially sulphuric acid, and this explains the defect known as "greening" which is developed in ordinary aniline blacks during exposure to air. By a supplementary oxidation with chromic acid such a black is rendered ungreenable, the nigraniline being probably changed into the more stable chromate of nigraniline.

Catechu is a valuable brown dyestuff, obtained from various species of *Acacia*, *Arcaea* and *Uncaria* growing in India. The wood, leaves and fruit of these plants are extracted with boiling water; the decoction is then evaporated to dryness or to a pasty consistency. Catechu is largely used by the cotton dyer for the production of brown, drab and similar colours. It is seldom employed for wool. Cotton is usually dyed by boiling it for about one hour in a decoction of catechu (100% containing copper sulphate (5%). After squeezing, the material is boiled for about fifteen minutes in a solution of bichromate of potash (1 oz. per gal.), then washed and dried. By repeating the operations two or three times deeper shades are obtained. During the boiling with catechu the cotton attracts the active principles catechin and catechu-tannic acid, but it thus acquires only a pale brown colour; in the bichromate of potash, however, these are oxidized to form insoluble japonic acid, which permeates the fibre, and a deep brown colour is thus developed. Catechu browns are fast to a variety of influences, *e.g.* washing, alkalis, acids, &c., but less so to light. Catechu has been recently much employed, in conjunction with copper sulphate, for dyeing the so-called khaki-brown on woollen material for military clothing. On silk, catechu is much used for weighting purposes in dyeing black.

MINERAL COLOURS.—These include Chrome Yellow, Iron Buff, Prussian Blue and Manganese Brown.

Chrome Yellow is only useful in cotton-dyeing as a self-colour, or for conversion into chrome orange, or, in conjunction with indigo, for the production of fast green colours. The cotton is first impregnated with a solution of lead acetate or nitrate, squeezed, and then passed through a solution of sodium sulphate or lime water to fix the lead on the fibre as sulphate or oxide of lead. The

material is then passed through a solution of bichromate of potash. The colour is changed to a rich orange by a short, rapid passage through boiling milk of lime, and at once washing with water, a basic chromate of lead being thus produced. The colour is fast to light, but has the defect of being blackened by sulphuretted hydrogen.

Iron Buff is produced by impregnating the cotton with a solution of ferrous sulphate, squeezing, passing into sodium hydrate or carbonate solution, and finally exposing to air, or passing through a dilute solution of bleaching powder. The colour obtained, which is virtually oxide of iron, or iron-rust, is fast to light and washing, but is readily removed by acids.

Prussian Blue is applicable to wool, cotton and silk, but since the introduction of coal-tar blues its employment has been very much restricted. The colour is obtained on cotton by first dyeing an iron buff, according to the method just described, and then passing the dyed cotton into an acidified solution of potassium ferrocyanide, when the blue is at once developed. A similar method is employed for silk. Wool is dyed by heating it in a solution containing potassium ferrocyanide and sulphuric acid. The colour is developed gradually as the temperature rises; it may be rendered brighter by the addition of stannous chloride. On wool and silk Prussian blue is very fast to light, but alkalis turn it brown (ferric oxide).

Manganese Brown or Bronze is applied in wool, silk and cotton dyeing. The animal fibres are readily dyed by boiling with a solution of potassium permanganate, which, being at first absorbed by the fibre, is readily reduced to insoluble brown manganic hydrate. Since caustic potash is generated from the permanganate and is liable to act detrimentally on the fibre, it is advisable to add some magnesium sulphate to the permanganate bath in order to counteract this effect. Imitation furs are dyed in this manner on wool-plush, the tips or other parts of the fibres being bleached by the application of sulphurous acid. Cotton is dyed by first impregnating it with a solution of manganous chloride, then dyeing and passing into a hot solution of caustic soda. There is thus precipitated on the fibre manganous hydrate, which by a short passage into a cold dilute solution of bleaching powder is oxidized and converted into the brown manganic hydrate. This manganese bronze or brown colour is very susceptible to, and readily bleached by, reducing agents; hence when exposed to the action of an atmosphere in which gas is freely burnt, the colour is liable to be discharged, especially where the fabric is most exposed. In other respects manganese bronze is a very fast colour.

Dyeing on a large Scale.—It is not possible to give here more than a bare outline of the methods which are used on the large scale for dyeing textile fibres, yarns and fabrics. In principle, dyeing is effected by allowing an aqueous¹ solution of the dyestuff, with or without additions (alkalis, acids, salts, &c.), to act, usually at an elevated temperature, on the material to be dyed. During the process it is necessary, in order to ensure the uniform distribution of the dyestuff in the material, that the latter should either be moved more or less continuously in the dye liquor or that the dye liquor should be circulated through the material. The former mode of operation is in general use for hank, warp and piece dyeing, but for textile fibres in the loose condition or in the form of "slubbing," "aliver" or "cops" (see SPINNING) the latter method has, in consequence of the introduction of improved machinery, come more and more into vogue within recent years.

Loose Material.—Cotton and wool are frequently dyed in the loose state, *i.e.* before being subjected to any mechanical treatment. The simplest method of effecting this is to treat the material in open vessels (boilers) which can be heated either by means of steam or direct fire. Since, however, a certain amount of felting or matting of the fibres cannot be avoided, it is frequently found to be more advantageous to effect these treatments in specially constructed apparatus in which the dye liquors are circulated through the material.

Yarn.—Yarn may be dyed either in the hank, in the warp or in the cop, *i.e.* in the form in which the yarn leaves the spinning frame. The dyeing in the *hank* is carried out in rectangular dye-vats constructed of wood or stone like that shown in fig. 1, in which the hanks are suspended from smooth wooden poles or rods resting on the sides, and are thus immersed almost entirely in the dye liquor. The heating of the vat is effected either by means of live steam, *i.e.* by blowing steam into the dye solution from a perforated pipe which runs along the bottom of the vat,

¹ The term "dry dyeing," which is carried out only to a very limited extent, relates to the dyeing of fabrics with the dyestuff dissolved in liquids other than water, *e.g.* benzene, alcohol, &c.

or by means of a steam coil similarly situated. In order to expose the hanks as uniformly as possible to the action of the dye liquor, they are turned by hand at regular intervals until the operation is finished. Washing off is effected in the same or in a similar vessel, after which excess of water is removed by wringing by hand, through squeezing rollers or, what is generally preferred, in a hydro-extractor (centrifugal machine). The drying of the dyed and washed yarn is generally effected by suspending it

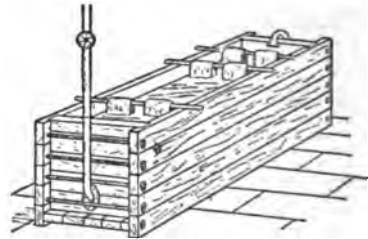

FIG. 1.—Dye-vat for Yarn.

on poles in steam-heated drying chambers. Yarn in the *warp* is dyed in vats or "boxes" like that shown in fig. 2, through which it is caused to pass continuously. The warps to be dyed pass slowly up and down over the loose rollers in the first box B, then through squeezing rollers S into the next, and the same thing occurs in the second (also third and fourth in a four-box machine) box A, whence they are delivered through a second pair of squeezing rollers S₁ into the wagon W. The boxes may contain the same or different liquors, according to the nature of the dyestuff employed. Washing is done in the same machine, while drying is effected on a cylinder drying machine like that shown in figs. 8 and 9 of BLEACHING. Latterly, machines have been introduced for dyeing warps on the beam, the dye liquor being caused to circulate through the material, and the system appears to be meeting with considerable success. Large quantities of yarn, especially cotton, are now dyed in the cop. When the dyed yarn is to be used as welf the main advantage of this method is at once apparent, inasmuch as the labour, time and waste of material incurred by reeling into hanks and then winding back into the compact form so as to fit into the shuttle are avoided. On the other hand the number of fast dyestuffs suitable for cop dyeing is very limited. In the original cop-dyeing machine constructed by Graemiger a thin tapering perforated metallic tube is inserted in the hollow of each cop. The cops are then attached to a perforated disk (which con-

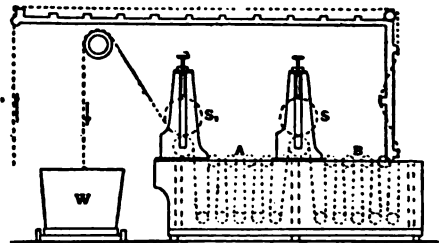

FIG. 2.

stitutes the lid of a chamber of box) by inserting the protruding ends of the tubes into the perforations. The chamber is now immersed in the dye-bath and the hot liquor is drawn through the cops by means of a centrifugal pump and returned continuously to the dye-bath. This principle, which is known as the skewer or spindle system, is the one on which most modern cop-dyeing machines are based. In the so-called "compact" system of cop dyeing the cops are packed as closely as possible in a box, the top and bottom (or the two opposite sides) of which are

perforated, the interstices between the cops being filled up with loose cotton, ground cork or sand. The dye liquor is then drawn by suction or forced by pressure through the box, thus permeating and dyeing the cops.

Pieces.—Plain shades are usually dyed in the piece, this being the most economical and at the same time the most expeditious means of obtaining the desired effect. The dyeing of piece goods may be effected by running them through the dye liquor either at full breadth or in rope form. The machine in most common use for the first method is the Lancashire "jigger," which is simple in principle and is shown in section in fig. 3. It consists essentially of a dye-vessel constructed of wood or cast iron and containing loose guide rollers, r and r , at the top and bottom. By coupling up the roller B with the driving gear the pieces which are batched

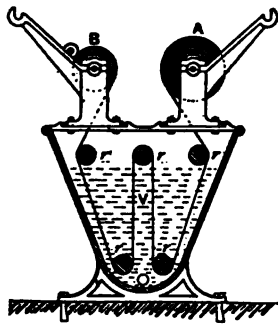

FIG. 3.—Dye-jigger.

on A are drawn through the dye liquor and rolled on to B. A band brake (not shown in the figure) applied to the axis of A gives the pieces the required amount of tension in passing through the dye-bath. As soon as the whole of the pieces have passed through in this way from A to B, the machine is reversed, and roller A draws them back again through the bath in a similar way on to roller A. This alternating process goes on until the dyeing is finished, when the goods are washed off, squeezed and dried. The jigger is especially useful in cotton piece dyeing, one great advantage being that it is suited for what is known as a "short bath," i.e. a bath containing a minimum amount of dye liquor, this being of great importance in the application of dyestuffs which do not exhaust well, like the direct colours and the sulphide colours. The padding machine is similar in principle to the jigger, the pieces running over loose guide rollers through the mordant or dye solution contained in a trough of suitable shape and size, but on leaving the machine they pass through a

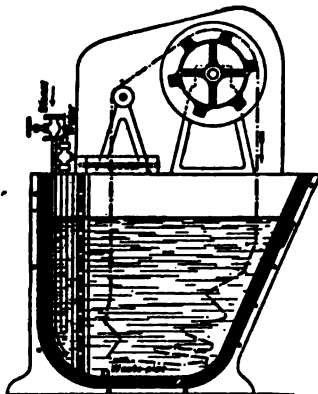

FIG. 4.—Dye-vat for Piece Goods.

pair of squeezing rollers which uniformly express the excess of liquor and cause it to be returned to the bath. The padding machine is used more for preparing (mordanting, &c.) than for dyeing.

For the dyeing of pieces in rope form a so-called "dye-beck" is used, which is a machine of larger dimensions than the jigger. Across the dye-bath is attached a winch W (see fig. 4), by means of which the pieces, sewn together at the ends so as to form an endless band, are caused to circulate through the machine, being drawn up on the front side of the machine and allowed to drop back into the dye liquor on the other. This form of machine is particularly suited for the mordanting and dyeing of heavy goods. Washing off may be done in the same machine.

The drying of piece goods is done on steam-heated cylinders like those used for the drying of bleached goods (see BLEACHING).

The operations which precede dyeing vary according to the material to be dyed and the effects which it is desired to produce. Loose wool, woollen and worsted yarn and piece goods of the same material are almost invariably scoured (see BLEACHING) before dyeing in order to remove the oily or greasy impurities which would otherwise interfere with the penetration of the dye solution. Silk is subjected to the process of discharging or boiling off (see BLEACHING) in order to remove the silk gum or sericine. Cotton which is to be dyed in dark shades does not require any preparatory treatment, but for light or very bright shades it is bleached before dyeing. Wool and silk are seldom bleached before dyeing. Cotton, wool and union (cotton warp and worsted weft) fabrics are frequently singed (see BLEACHING) before dyeing. Worsted yarn, especially two-fold yarn, is very liable to curl and become entangled when scoured, and in order to avoid this it is necessary to stretch and "set" it. To this end it is stretched tight on a specially constructed frame, placed in boiling water, and then cooled. Similarly, union fabrics are liable to "cockle" when wetted, and although this defect may be put right in finishing, spots of water or raindrops will give an uneven appearance of a permanent character to the goods. To avoid this, the pieces are subjected previous to dyeing to the so-called "crabbing" process, in which they are drawn under great tension through boiling water and wound on to perforated hollow cylinders. Steam is then blown through the goods and they are allowed to cool.

With respect to the question of colour, we meet with two kinds of substances in nature, those which possess colour and those which do not. Why this difference? The physicist says the former are bodies which reflect all the coloured rays of the spectrum composing white light—if opaque, they appear white; if transparent, they are colourless. The latter are bodies which absorb some of the spectrum rays only, reflecting the remainder, and these together produce the impression of colour. A black substance is one which absorbs all the spectrum rays. The fundamental reason, however, of this difference of action on the part of substances towards light remains still unknown. All substances which possess colour are not necessarily dyestuffs, and the question may be again asked, Why? It is a remarkable circumstance that most of the dyestuffs at present employed occur among the so-called aromatic or benzene compounds derived from coal-tar, and a careful study of these has furnished a general explanation of the point in question, which briefly is, that the dyeing property of a substance depends upon its chemical constitution. Speaking generally, those colouring matters which have the simplest constitution are yellow, and as the molecular weight increases their colour passes into orange, red, violet and blue. In recent years chemists have begun to regard the constitution of nearly all dyestuffs as similar to that of Quinone, and some even believe that all coloured organic compounds have a quinonoid structure. According to O. N. Witt, a colourless hydrocarbon, e.g. benzene, becomes coloured by the introduction of one or more special groups of atoms, which he terms the colour-bearing or *chromophorous groups*, e.g. NO_2 , $-\text{N}=\text{N}-$, &c. Benzene, for example, is colourless, whereas nitro-benzene and azo-benzene are yellow. Such compounds containing chromophorous groups are termed chromogens, because, although not dyestuffs themselves, they are capable of generating such by the further introduction of salt-forming atomic groups, e.g. OH , NH_2 . These Witt terms *auxochromous groups*. In this way the chromogen *tri-nitro-benzene*, $\text{C}_6\text{H}_3(\text{NO}_2)_3$, becomes the dyestuff *tri-nitro-phenol* (picric acid), $\text{C}_6\text{H}_2(\text{NO}_2)_3(\text{OH})$, and the chromogen *azo-benzene*, $\text{C}_6\text{H}_5\text{N}:\text{N}-\text{C}_6\text{H}_5$, is changed into the dyestuff *amido-azo-benzene* (Fast Yellow), $\text{C}_6\text{H}_4\text{N}:\text{N}-\text{C}_6\text{H}_4(\text{NH}_2)$. These two dyestuffs are typical of a large number which possess either an acid or a basic character according as they contain hydroxyl (OH) or amido (NH_2) groups, and correspond to the Acid Colours and Basic Colours to which reference has already been made. Other important atomic groups which frequently occur, in addition to the above, are the carboxyl (COOH) and the sulphonic acid (HSO_3) groups; these either increase the solubility of the

colouring matter or assist in causing it to be attracted by the fibre, &c. In many cases the free colour-acid or free colour-base has little colour, this being only developed in the salt. The free base rosaniline, for example, is colourless, whereas the salt magenta (rosaniline hydrochloride) has a deep crimson colour in solution. The free acid Alizarin is orange, while its alumina-salt is bright red. It may be here stated that the scientific classification of colouring matters into Nitro-colours, Azo-colours, &c., already alluded to, is based on their chemical constitution, or the chromophorous groups they contain, whereas the classification according to their mode of application is dependent upon the character and arrangement of the auxochromous groups. The question of the mordant-dyeing property of certain colouring matters containing (OH) and (COOH) groups has already been explained under the head of *Artificial Mordant Colours*.

The peculiar property characteristic of dyestuffs, as distinguished from mere colouring matters, namely, that of being readily attracted by the textile fibres, notably the animal fibres, appears then to be due to their more or less marked acid or basic character. Intimately connected with this is the fact that these fibres also exhibit partly basic and partly acid characters, due to the presence of carboxyl and amido groups. The behaviour of magenta is typical of the Basic Colours. As already indicated, rosaniline, the base of magenta, is colourless, and only becomes coloured by its union with an acid, and yet wool and silk can be as readily dyed with the colourless rosaniline (base) as with the magenta (salt). The explanation is that the base rosaniline has united with the fibre, which here plays the part of an acid, to form a coloured salt. It has also been proved that in dyeing the animal fibres with magenta (rosaniline hydrochloride), the fibre unites with the rosaniline only, and liberates the hydrochloric acid. Further, magenta will not dye cotton unless the fibre is previously prepared, e.g. with the mordant tannic acid, with which the base rosaniline unites to form an insoluble salt. In dyeing wool it is the fibre itself which acts as the mordant. In the case of the Acid Colours the explanation is similar. In many of these the free colour-acid has quite a different colour from that of the alkali-salt, and yet on dyeing wool or silk with the free colour-acid, the fibre exhibits the colour of the alkali-salt and not of the colour-acid. In this case the fibre evidently plays the part of a base. Another fact in favour of the view that the union between fibre and colouring matter is of a chemical nature, is that by altering the chemical constitution of the fibre its dyeing properties are also altered; oxycellulose and nitrocellulose, for example, have a greater attraction for Basic Colours than cellulose. Such facts and considerations as these have helped to establish the view that in the case of dyeing animal fibres with many colouring matters the operation is a *chemical process*, and not merely a mechanical absorption of the dyestuff. A similar explanation does not suffice, however, in the case of dyeing cotton with the Direct Colours. These are attracted by cotton from their solutions as alkali salts, apparently without decomposition. The affinity existing between the fibre and colouring matter is somewhat feeble, for the latter can be removed from the dyed fibre by merely boiling with water. The depth of colour obtained in dyeing varies with the concentration of the colour solution, or with the amount of some neutral salt, e.g. sodium chloride, added as an assistant to the dye-bath; moreover, the dye-bath is not exhausted. The colouring matter is submitted to the action of two forces, the solvent power of the water and the affinity of the fibre, and divides itself between the fibre and the water. After dyeing for some time, a state of equilibrium is attained in which the colouring matter is divided between the fibre and the water in a given ratio, and prolonged dyeing does not intensify the dyed colour.

Some investigators hold the view that in some cases the fibres exert a purely physical attraction towards colouring matters, and that the latter are held in an unchanged state by the fibre. The phenomenon is regarded as one of purely mechanical surface-attraction, and is compared with that exercised by animal charcoal when employed in decolorizing a solution of some colouring matter. Some consider such direct dyeing as mere diffusion of

the colouring matter into the fibre, and others that the colouring matter is in a state of "solid solution" in the fibre, similar to the solution of a metallic oxide in coloured glass. According to this latter view, the cause of the dyeing of textile fibres is similar to the attraction or solvent action exerted by ether when it withdraws colouring matter from an aqueous solution by agitation. Latterly the view has been advanced that dyeing is due to precipitation of the colloid dyestuffs by the colloid substance of the fibre.

In the case of colours which are dyed on mordants, the question is merely transferred to the nature of the attraction which exists between the fibre and the mordant, for it has been conclusively established that the union between the colouring matter and the mordant is essentially chemical in character.

From our present knowledge it will be seen that we are unable to give a final answer to the question of whether the dyeing process is to be regarded as a chemical or a mechanical process. There are arguments and facts which favour both views; but in the case of wool and silk dyeing, the prevailing opinion in most cases is in favour of the chemical theory, whereas in cotton-dyeing, the mechanical theory is widely accepted. Probably no single theory can explain satisfactorily the fundamental cause of attraction in all cases of dyeing, and further investigation is needed to answer fully this very difficult and abstruse question.

The poisonous nature or otherwise of the coal-tar dyes has been frequently discussed, and the popular opinion, no doubt dating from the time when magenta and its derivatives were contaminated with arsenic, seems to be that they are ^{Co-} ^{coloured} for the most part really poisonous, and ought to be avoided for colouring materials worn next the skin, for articles of food, &c. It is satisfactory to know that most of the colours are not poisonous, but some few are—namely, Picric acid, Victoria Orange, Aurantia, Coralline, Metanil Yellow, Orange II, and Safranin. Many coal-tar colours have, indeed, been recommended as antiseptics or as medicinal remedies, e.g. Methyl Violet, Auramine and Methylene Blue, because of their special physiological action. In histology and bacteriology many coal-tar colours have rendered excellent service in staining microscopic preparations, and have enabled the investigator to detect differences of structure, &c., previously unsuspected. In photography many of the more fugitive colouring matters, e.g. Cyanine, Eosine, Quinoline Red, &c., are employed in the manufacture of ortho-chromatic plates, by means of which the colours of natural objects can be photographed in the same degrees of light and shade as they appear to the eye—blue, for example, appearing a darker grey, yellow, a lighter grey, in the printed photograph.

Since the year 1856, in which the first coal-tar colour, mauve, was discovered, the art of dyeing has made enormous advances, mainly in consequence of the continued introduction of coal-tar colours having the most varied properties and suitable for nearly every requirement. The old idea that the vegetable dyestuffs are superior in fastness to light is gradually being given up, and, if one may judge from the past, it seems evident that in the future there will come a time when all our dyestuffs will be prepared by artificial means.

AUTHORITIES.—Macquer, *Hellot and le Pileur d'Apigny, The Art of Dyeing Wool, Silk and Cotton* (London, 1789); Bancroft, *Philosophy of Permanent Colours* (2 vols., London, 1813); Berthollet-Üre, *Elements of the Art of Dyeing* (2 vols., London, 1824); Chevreul, *Recherches chimiques sur la teinture* (Paris, 1835-1861); O'Neill, *The Chemistry of Calico Printing, Dyeing and Bleaching* (Manchester, 1860); *Dictionary of Calico Printing and Dyeing* (London, 1862); Schützenberger, *Traité des matières colorantes* (2 vols., Paris, 1867); Bolley, *Die Spinnfasern und die im Pflanzen- und Thierkörper vorkommenden Farbstoffe* (1867); Crookes, *A Practical Handbook of Dyeing and Calico-Printing* (London, 1874); Jarman, *Wool-Dyeing* (1876); O'Neill, *Textile Colourist* (4 vols., Manchester, 1876); Calvert, *Dyeing and Calico Printing* (Manchester, 1876); Moyret, *Traité de la teinture des soies* (Lyon, 1877); O'Neill, *The Practice and Principles of Calico Printing, Bleaching and Dyeing* (Manchester, 1878); Girardin, *Matières textiles et matières tinctoriales* (Paris, 1880); Hummel, *The Dyeing of Textile Fabrics* (London, 1883); Sansone, *Dyeing* (Manchester, 1888); Witt, *Chemische Technologie der Geppinnfasern* (Brunswick, 1888); Benedict and Knecht, *The Chemistry of the Coal-Tar Colours* (London, 1889); Hurst, *Silk Dyeing, Printing and Finishing* (London, 1892); Noelting and

Lehne, *Anilinschwärze* (Berlin, 1892); Knecht, Rawson and Loewenthal, *Manual of Dyeing* (London, 1908); Steinbeck, *Bleichen und Färben der Seide und Halbwolle* (Berlin, 1893); Gardner, *Wool-Dyeing* (Manchester, 1896); Rawson, Gardner and Laveack, *A Dictionary of Dyes, Mordants, &c.* (London, 1901); Gray-Renda, *Les Mordants en teinture et en impression* (Paris, 1898); Georgievitch, *The Chemical Technology of Textile Fabrics* (London, 1902); Paterson, *The Science of Colour Mixing* (London, 1900); Paterson, *Colour Matching on Textiles* (London, 1901); Beech, *The Dyeing of Cotton Fabrics* (London, 1901); Beech, *The Dyeing of Woolen Fabrics* (London, 1902); *The Journal of the Society of Dyers and Colourists* (Bradford, 1885-1908) and the publications of the colour manufacturers. (J. J. H.; E. K.)

DYER, SIR EDWARD (d. 1607), English courtier and poet, son of Sir Thomas Dyer, Kt., was born at Sharpsham Park, Somersetshire. He was educated, according to Anthony à Wood, either at Balliol College or at Broadgates Hall, Oxford. He left the university without taking a degree, and after some time spent abroad appeared at Queen Elizabeth's court. His first patron was the earl of Leicester, who seems to have thought of putting him forward as a rival to Sir Christopher Hatton in the queen's favour. He is mentioned by Gabriel Harvey with Sidney as one of the ornaments of the court. Sidney in his will desired that his books should be divided between Fulke Greville (Lord Brooke) and Dyer. He was employed by Elizabeth on a mission (1584) to the Low Countries, and in 1589 was sent to Denmark. In a commission to inquire into manors unjustly alienated from the crown in the west country he did not altogether please the queen, but he received a grant of some forfeited lands in Somerset in 1588. He was knighted and made chancellor of the order of the Garter in 1596. William Oldys says of him that he "would not stoop to fawn," and some of his verses seem to show that the exigencies of life at court oppressed him. He was buried at St Saviour's, Southwark, on the 11th of May 1607. Wood says that many esteemed him to be a Rosicrucian, and that he was a firm believer in alchemy. He had a great reputation as a poet among his contemporaries, but very little of his work has survived. Puttenham in the *Arte of English Poesie* speaks of "Maister Edward Dyer, for Elegie most sweete, solempne, and of high conceit." One of the poems universally accepted as his is "My Mynde to me a kingdome is." Among the poems in *England's Helicon* (1600), signed S.E.D., and included in Dr A. B. Grosart's collection of Dyer's works (*Miscellanies of the Fuller Worthies Library*, vol. iv., 1876) is the charming pastoral "My Phillis hath the morning sunne," but this comes from the *Phillis* of Thomas Lodge. Grosart also prints a prose tract entitled *The Praise of Nothing* (1585). The *Six Idyllia* from Theocritus, reckoned by J. P. Collier among Dyer's works, were dedicated to, not written by, him.

DYER, JOHN (c. 1700-1758), British poet, the son of a solicitor, was born in 1699 or 1700 at Aberglasney, in Carmarthenshire. He was sent to Westminster school and was destined for the law, but on his father's death he began to study painting. He wandered about South Wales, sketching and occasionally painting portraits. In 1726 his first poem, *Grongar Hill*, appeared in a miscellany published by Richard Savage, the poet. It was an irregular ode in the so-called Pindaric style, but Dyer entirely rewrote it into a loose measure of four cadences, and printed it separately in 1727. It had an immediate and brilliant success. *Grongar Hill*, as it now stands, is a short poem of only 150 lines, describing in language of much freshness and picturesque charm the view from a hill overlooking the poet's native vale of Towy. A visit to Italy bore fruit in *The Ruins of Rome* (1740), a descriptive piece in about 600 lines of Miltonic blank verse. He was ordained priest in 1741, and held successively the livings of Calthorpe in Leicestershire, Belchford (1751), Coningsby (1752), and Kirby-on-Bane (1756), the last three being Lincolnshire parishes. He married, in 1741, a Miss Ensor, said to be descended from the brother of Shakespeare. In 1757 he published his longest work, the didactic blank-verse epic *The Fleece*, in four books, discoursing of the tending of sheep, of the shearing and preparation of the wool, of weaving, and of trade in woollen manufactures. The town took no interest in it, and Dodsley

facetiously prophesied that "Mr Dyer would be buried in woollen." He died at Coningsby of consumption, on the 15th of December 1758.

His poems were collected by Dodsley in 1770, and by Mr Edward Thomas in 1903 for the *Welsh Library*, vol. iv.

DYER, THOMAS HENRY (1804-1888), English historical and antiquarian writer, was born in London on the 4th of May 1804. He was originally intended for a business career, and for some time acted as clerk in a West India house; but finding his services no longer required after the passing of the Negro Emancipation Act, he decided to devote himself to literature. In 1850 he published the *Life of Calvin*, a conscientious and on the whole impartial work, though the character of Calvin is somewhat harshly drawn, and his influence in the religious world generally is insufficiently appreciated. Dyer's first historical work was the *History of Modern Europe* (1861-1864; 3rd ed. revised and continued to the end of the 19th century, by A. Hassall, 1901), a meritorious compilation and storehouse of facts, but not very readable. The *History of the City of Rome* (1865) down to the end of the middle ages was followed by the *History of the Kings of Rome* (1868), which, upholding against the German school the general credibility of the account of early Roman history, given in Livy and other classical authors, was violently attacked by J. R. Seeley and the *Saturday Review*, as showing ignorance of the comparative method. More favourable opinions of the work were expressed by others, but it is generally agreed that the author's scholarship is defective and that his views are far too conservative. *Roma Regalis* (1872) and *A Plea for Livy* (1873) were written in reply to his critics. Dyer frequently visited Greece and Italy, and his topographical works are probably his best; amongst these mention may be made of *Pompeii, its History, Buildings and Antiquities* (1867, new ed. in Bohn's *Illustrated Library*), and *Ancient Athens, its History, Topography and Remains* (1873). His last publication was *On Imitative Art* (1882). He died at Bath on the 30th of January 1888.

DYMOKE, the name of an English family holding the office of king's champion. The functions of the champion were to ride into Westminster Hall at the coronation banquet, and challenge all comers to impugn the king's title (see CHAMPION). The earliest record of the ceremony at the coronation of an English king dates from the accession of Richard II. On this occasion the champion was Sir John Dymoke (d. 1381), who held the manor of Scryvelsby, Lincolnshire, in right of his wife Margaret, granddaughter of Joan Ludlow, who was the daughter and co-heiress of Philip Marmion, last Baron Marmion. The Marmions claimed descent from the lords of Fontenay, hereditary champions of the dukes of Normandy, and held the castle of Tamworth, Leicestershire, and the manor of Scryvelsby, Lincolnshire. The right to the championship was disputed with the Dymoke family by Sir Baldwin de Freville, lord of Tamworth, who was descended from an elder daughter of Philip Marmion. The court of claims eventually decided in favour of the owners of Scryvelsby on the ground that Scryvelsby was held in grand serjeanty, that is, that its tenure was dependent on rendering a special service, in this case the championship.

Sir Thomas Dymoke (1428?-1471) joined a Lancastrian rising in 1466, and, with his brother-in-law Richard, Lord Willoughby and Welles, was beheaded in 1471 by order of Edward IV. after he had been induced to leave sanctuary on a promise of personal safety. The estates were restored to his son Sir Robert Dymoke (d. 1546), champion at the coronations of Richard III., Henry VII. and Henry VIII., who distinguished himself at the siege of Tournai and became treasurer of the kingdom. His descendants acted as champions at successive coronations. Lewis Dymoke (d. 1820) put in an unsuccessful claim before the House of Lords for the barony of Marmion. His nephew Henry (1801-1865) was champion at the coronation of George IV. He was accompanied on that occasion by the duke of Wellington and Lord Howard of Effingham. Henry Dymoke was created a baronet; he was succeeded by his brother John, rector of Scryvelsby (1804-1873), whose son Henry Lionel died wit'

issue in 1875, when the baronetcy became extinct, the estate passing to a collateral branch of the family. After the coronation of George IV. the ceremony was allowed to lapse, but at the coronation of King Edward VII. H. S. Dymoke bore the standard of England in Westminster Abbey.

DYNAMICS (from Gr. *dynamis*, strength), the name of a branch of the science of Mechanics (q.v.). The term was at one time restricted to the treatment of motion as affected by force, being thus opposed to Statics, which investigated equilibrium or conditions of rest. In more recent times the word has been applied comprehensively to the action of force on bodies either at rest or in motion, thus including "dynamics" (now termed kinetics) in the restricted sense and "statics."

ANALYTICAL DYNAMICS.—The fundamental principles of dynamics, and their application to special problems, are explained in the articles MECHANICS and MOTION, LAWS OF, where brief indications are also given of the more general methods of investigating the properties of a dynamical system, independently of the accidents of its particular constitution, which were inaugurated by J. L. Lagrange. These methods, in addition to the unity and breadth which they have introduced into the treatment of pure dynamics, have a peculiar interest in relation to modern physical speculation, which finds itself confronted in various directions with the problem of explaining on dynamical principles the properties of systems whose ultimate mechanism can at present only be vaguely conjectured. In determining the properties of such systems the methods of analytical geometry and of the infinitesimal calculus (or, more generally, of mathematical analysis) are necessarily employed; for this reason the subject has been named Analytical Dynamics. The following article is devoted to an outline of such portions of general dynamical theory as seem to be most important from the physical point of view.

1. General Equations of Impulsive Motion.

The systems contemplated by Lagrange are composed of discrete particles, or of rigid bodies, in finite number, connected (it may be) in various ways by invariable geometrical relations, the fundamental postulate being that the position of every particle of the system at any time can be completely specified by means of the instantaneous values of a finite number of independent variables q_1, q_2, \dots, q_n , each of which admits of continuous variation over a certain range, so that if x, y, z be the Cartesian co-ordinates of any one particle, we have for example

$$x = f(q_1, q_2, \dots, q_n), \quad y = g(x), \quad z = h(x), \dots \quad (1)$$

where the functions f differ (of course) from particle to particle. In modern language, the variables q_1, q_2, \dots, q_n are *generalized co-ordinates* serving to specify the *configuration* of the system; their derivatives with respect to the time are denoted by $\dot{q}_1, \dot{q}_2, \dots, \dot{q}_n$, and are called the *generalized components of velocity*. The continuous sequence of configurations assumed by the system in any actual or imagined motion (subject to the given connexions) is called the *path*.

For the purposes of a connected outline of the whole subject it is convenient to deviate somewhat from the historical order of development, and to begin with the consideration of *impulsive motion*. Whatever the actual motion of the system at any instant, we may conceive it to be generated instantaneously from rest by the application of proper impulses. On this view we have, if x, y, z be the rectangular co-ordinates of any particle m ,

$$m\dot{x} = X', \quad m\dot{y} = Y', \quad m\dot{z} = Z', \dots \quad (2)$$

where X', Y', Z' are the components of the impulse on m . Now let $\delta x, \delta y, \delta z$ be any infinitesimal variations of x, y, z which are consistent with the connexions of the system, and let us form the equation

$$\sum m(\delta x + \delta y + \delta z) = \sum (X' \delta x + Y' \delta y + Z' \delta z), \dots \quad (3)$$

where the sign \sum indicates (as throughout this article) a summation extending over all the particles of the system. To transform (3) into an equation involving the variations $\delta q_1, \delta q_2, \dots$ of the generalized co-ordinates, we have

$$\delta x = \frac{\partial x}{\partial q_1} \delta q_1 + \frac{\partial x}{\partial q_2} \delta q_2 + \dots, \quad \delta y, \quad \delta z, \dots \quad (4)$$

$$\delta x = \frac{\partial x}{\partial q_1} \delta q_1 + \frac{\partial x}{\partial q_2} \delta q_2 + \dots, \quad \delta y, \quad \delta z, \dots \quad (5)$$

and therefore

$$\sum m(\delta x + \delta y + \delta z) = A_{11} \delta q_1 + A_{12} \delta q_2 + \dots \delta q_1 + (A_{21} \delta q_1 + A_{22} \delta q_2 + \dots) \delta q_2 + \dots, \quad (6)$$

where

$$A_{11} = \sum m \left\{ \left(\frac{\partial x}{\partial q_1} \right)^2 + \left(\frac{\partial y}{\partial q_1} \right)^2 + \left(\frac{\partial z}{\partial q_1} \right)^2 \right\}, \dots \quad (7)$$

$$A_{12} = \sum m \left\{ \frac{\partial x}{\partial q_1} \frac{\partial x}{\partial q_2} + \frac{\partial y}{\partial q_1} \frac{\partial y}{\partial q_2} + \frac{\partial z}{\partial q_1} \frac{\partial z}{\partial q_2} \right\} = A_{21}, \dots$$

If we form the expression for the kinetic energy T of the system, we find

$$2T = \sum m(\dot{x}^2 + \dot{y}^2 + \dot{z}^2) = A_{11} \dot{q}_1^2 + A_{22} \dot{q}_2^2 + \dots + 2A_{12} \dot{q}_1 \dot{q}_2 + \dots \quad (8)$$

The coefficients $A_{11}, A_{22}, \dots, A_{12}, \dots$ are by an obvious analogy called the *coefficients of inertia* of the system; they are in general functions of the co-ordinates q_1, q_2, \dots . The equation (6) may now be written

$$\sum m(\delta x + \delta y + \delta z) = \frac{\partial T}{\partial \dot{q}_1} \delta q_1 + \frac{\partial T}{\partial \dot{q}_2} \delta q_2 + \dots \quad (9)$$

This may be regarded as the cardinal formula in Lagrange's method. For the right-hand side of (9) we may write

$$\sum (X' \delta x + Y' \delta y + Z' \delta z) = Q'_1 \delta q_1 + Q'_2 \delta q_2 + \dots \quad (10)$$

where

$$Q'_1 = \sum (X' \frac{\partial x}{\partial q_1} + Y' \frac{\partial y}{\partial q_1} + Z' \frac{\partial z}{\partial q_1}), \dots \quad (11)$$

The quantities Q_1, Q_2, \dots are called the *generalized components of impulse*. Comparing (9) and (10), we have, since the variations $\delta q_1, \delta q_2, \dots$ are independent,

$$\frac{\partial T}{\partial \dot{q}_1} = Q'_1, \quad \frac{\partial T}{\partial \dot{q}_2} = Q'_2, \dots \quad (12)$$

These are the general equations of impulsive motion.

It is now usual to write

$$\dot{p}_1 = \frac{\partial T}{\partial \dot{q}_1}, \dots \quad (13)$$

The quantities p_1, p_2, \dots represent the effects of the several component impulses on the system, and are therefore called the *generalized components of momentum*. In terms of them we have

$$\sum m(\delta x + \delta y + \delta z) = p_1 \delta q_1 + p_2 \delta q_2 + \dots \quad (14)$$

Also, since T is a homogeneous quadratic function of the velocities $\dot{q}_1, \dot{q}_2, \dots$,

$$2T = p_1 \dot{q}_1 + p_2 \dot{q}_2 + \dots \quad (15)$$

This follows independently from (14), assuming the special variations $\delta x = \dot{x} dt, \delta y = \dot{y} dt, \dots$, and therefore $\delta q_1 = \dot{q}_1 dt, \delta q_2 = \dot{q}_2 dt, \dots$

Again, if the values of the velocities and the momenta in any other motion of the system through the same configuration be distinguished by accents, we have the identity

$$p_1 \dot{q}'_1 + p_2 \dot{q}'_2 + \dots = p'_1 \dot{q}_1 + p'_2 \dot{q}_2 + \dots, \quad (16)$$

each side being equal to the symmetrical expression

$$A_{11} \dot{q}'_1 \dot{q}_1 + A_{22} \dot{q}'_2 \dot{q}_2 + \dots + A_{12} (\dot{q}'_1 \dot{q}_2 + \dot{q}'_2 \dot{q}_1) + \dots \quad (17)$$

The theorem (16) leads to some important reciprocal relations. Thus, let us suppose that the momenta p_1, p_2, \dots all vanish with the exception of p_1 , and similarly that the momenta p'_1, p'_2, \dots all vanish except p'_2 . We have then $p_1 \dot{q}'_1 = p'_2 \dot{q}_2$, or

$$\dot{q}_1 = p'_2 / p_1, \dots \quad (18)$$

The interpretation is simplest when the co-ordinates q_1, q_2 are both of the same kind, e.g. both lines or both angles. We may then conveniently put $\dot{q}_1 = \dot{p}'_1$, and assert that the velocity of the first type due to an impulse of the second type is equal to the velocity of the second type due to an equal impulse of the first type. As an example, suppose we have a chain of straight links hinged each to the next, extended in a straight line, and free to move. A blow at right angles to the chain, at any point P, will produce a certain velocity at any other point Q; the theorem asserts that an equal velocity will be produced at P by an equal blow at Q. Again, an impulsive couple acting on any link A will produce a certain angular velocity in any other link B; an equal couple applied to B will produce an equal angular velocity in A. Also if an impulse F applied at P produce an angular velocity ω in a link A, a couple F ω applied to A will produce a linear velocity ωs at P. Historically, we may note that reciprocal relations in dynamics were first recognized by H. L. F. Helmholtz in the domain of acoustics; their use has been greatly extended by Lord Rayleigh.

The equations (13) determine the momenta p_1, p_2, \dots as linear functions of the velocities $\dot{q}_1, \dot{q}_2, \dots$. Solving these, we can express $\dot{q}_1, \dot{q}_2, \dots$ as linear functions of p_1, p_2, \dots . The resulting equations give us the velocities produced by any given system of impulses. Further, by substitution in (8), we can express the kinetic energy as a homogeneous quadratic function of the momenta p_1, p_2, \dots . The kinetic energy, as so expressed, will be denoted by T' ; thus

$$2T' = A'_{11} p_1^2 + A'_{22} p_2^2 + \dots + 2A'_{12} p_1 p_2 + \dots \quad (19)$$

where $A'_{11}, A'_{22}, \dots, A'_{12}, \dots$ are certain coefficients depending on the configuration. They have been called by Maxwell the *coefficients of mobility* of the system. When the form (19) is given, the values

Reciprocal
theorems

Velocities
in terms of
momenta

of the velocities in terms of the momenta can be expressed in a remarkable form due to Sir W. R. Hamilton. The formula (15) may be written

$$p_1 \dot{q}_1 + p_2 \dot{q}_2 + \dots = T + T', \quad (20)$$

where T is supposed expressed as in (8) and T' as in (19). Hence if, for the moment, we denote by δ a variation affecting the velocities, and therefore the momenta, but not the configuration, we have

$$p_1 \delta \dot{q}_1 + p_2 \delta \dot{q}_2 + \dots + \delta T + \delta T' = \frac{\partial T}{\partial p_1} \delta p_1 + \frac{\partial T}{\partial p_2} \delta p_2 + \dots + \frac{\partial T}{\partial p_1} \delta p_1 + \frac{\partial T}{\partial p_2} \delta p_2 + \dots \quad (21)$$

In virtue of (13) this reduces to

$$\delta p_1 + \delta p_2 + \dots = \frac{\partial T}{\partial p_1} \delta p_1 + \frac{\partial T}{\partial p_2} \delta p_2 + \dots \quad (22)$$

Since $\delta p_1, \delta p_2, \dots$ may be taken to be independent, we infer that

$$\delta_1 = \frac{\partial T}{\partial p_1}, \quad \delta_2 = \frac{\partial T}{\partial p_2}, \quad \dots \quad (23)$$

In the very remarkable exposition of the matter given by James Clerk Maxwell in his *Electricity and Magnetism*, the Hamiltonian expressions (23) for the velocities in terms of the impulses are obtained directly from first principles, and the formulæ (13) are then deduced by an inversion of the above argument.

An important modification of the above process was introduced by E. J. Routh and Lord Kelvin and P. G. Tait. Instead of expressing the kinetic energy in terms of the velocities alone, or in terms of the momenta alone, we may express it in terms of the velocities corresponding to some of the co-ordinates, say q_1, q_2, \dots, q_m , and of the momenta corresponding to the remaining co-ordinates, which (for the sake of distinction) we may denote by x, x', x'', \dots . Thus, T being expressed as a homogeneous quadratic function of $q_1, q_2, \dots, q_m, x, x', x'', \dots$, the momenta corresponding to the co-ordinates x, x', x'', \dots may be written

$$x = \frac{\partial T}{\partial x'}, \quad x' = \frac{\partial T}{\partial x''}, \quad x'' = \frac{\partial T}{\partial x'''}, \quad \dots \quad (24)$$

These equations, when written out in full, determine x, x', x'', \dots as linear functions of $q_1, q_2, \dots, q_m, x, x', x'', \dots$. We now consider the function

$$R = T - x\dot{x} - x'\dot{x}' - x''\dot{x}'' - \dots, \quad (25)$$

supposed expressed, by means of the above relations in terms of $q_1, q_2, \dots, q_m, x, x', x'', \dots$. Performing the operation δ on both sides of (25), we have

$$\frac{\partial R}{\partial q_1} \delta q_1 + \dots + \frac{\partial R}{\partial x} \delta x + \dots = \frac{\partial T}{\partial q_1} \delta q_1 + \dots + \frac{\partial T}{\partial x} \delta x + \dots - \delta x\dot{x} - \delta x'\dot{x}' - \dots \quad (26)$$

where, for brevity, only one term of each type has been exhibited. Omitting the terms which cancel in virtue of (24), we have

$$\frac{\partial R}{\partial q_1} \delta q_1 + \dots + \frac{\partial R}{\partial x} \delta x + \dots = \frac{\partial T}{\partial q_1} \delta q_1 + \dots - \dot{x}\delta x - \dots \quad (27)$$

Since the variations $\delta q_1, \delta q_2, \dots, \delta q_m, \delta x, \delta x', \delta x'', \dots$ may be taken to be independent, we have

$$p_1 = \frac{\partial T}{\partial \dot{q}_1} = \frac{\partial R}{\partial \dot{q}_1}, \quad p_2 = \frac{\partial T}{\partial \dot{q}_2} = \frac{\partial R}{\partial \dot{q}_2}, \quad \dots \quad (28)$$

and
$$x = \frac{\partial R}{\partial \dot{x}}, \quad x' = -\frac{\partial R}{\partial \dot{x}'}, \quad x'' = -\frac{\partial R}{\partial \dot{x}''}, \quad \dots \quad (29)$$

An important property of the present transformation is that, when expressed in terms of the new variables, the kinetic energy is the sum of two homogeneous quadratic functions, thus

$$T = \mathfrak{W} + K, \quad (30)$$

where \mathfrak{W} involves the velocities $\dot{q}_1, \dot{q}_2, \dots, \dot{q}_m$ alone, and K the momenta x, x', x'', \dots alone. For in virtue of (29) we have, from (25),

$$T = R - \left(\frac{\partial R}{\partial x} x + \frac{\partial R}{\partial x'} x' + \frac{\partial R}{\partial x''} x'' + \dots \right), \quad (31)$$

and it is evident that the terms in R which are bilinear in respect of the two sets of variables $\dot{q}_1, \dot{q}_2, \dots, \dot{q}_m$ and x, x', x'', \dots will disappear from the right-hand side.

It may be noted that the formula (30) gives immediate proof of two important theorems due to Bertrand and to Lord Kelvin respectively. Let us suppose, in the first place, that the system is started by given impulses of certain types, but is otherwise free. J. L. F. Bertrand's theorem is to the effect that the kinetic energy is greater than if by impulses of the remaining types the system were constrained to take any other course. We may suppose the co-ordinates to be so chosen that the constraint is expressed by the vanishing of the velocities $\dot{q}_1, \dot{q}_2, \dots, \dot{q}_m$, whilst the given impulses are x, x', x'', \dots . Hence the energy in the actual motion is greater than in the constrained motion by the amount \mathfrak{W} .

Again, suppose that the system is started with prescribed velocity components $\dot{q}_1, \dot{q}_2, \dots, \dot{q}_m$, by means of proper impulses of the corresponding types, but is otherwise free, so that in the motion actually generated we have $x = 0, x' = 0, x'' = 0, \dots$ and therefore $K = 0$. The kinetic energy is therefore less than in any other motion consistent with the prescribed velocity-conditions by the value which K assumes when x, x', x'', \dots represent the impulses due to the constraints.

Simple illustrations of these theorems are afforded by the chain of straight links already employed. Thus if a point of the chain be held fixed, or if one or more of the joints be made rigid, the energy generated by any given impulses is less than if the chain had possessed its former freedom.

3. Continuous Motion of a System.

We may proceed to the continuous motion of a system. The equations of motion of any particle of the system are of the form $m\ddot{x} = X, \quad m\ddot{y} = Y, \quad m\ddot{z} = Z \quad (1)$

Now let $x + iy, y + iz, z + ix$ be the co-ordinates of m in any Lagrangian's arbitrary motion of the system differing infinitely little *equation* from the actual motion, and let us write the equation

$$\Sigma m(\dot{x}\dot{x} + \dot{y}\dot{y} + \dot{z}\dot{z}) = \Sigma(X\dot{x} + Y\dot{y} + Z\dot{z}) \quad (2)$$

Lagrange's investigation consists in the transformation of (2) into an equation involving the independent variations $\delta q_1, \delta q_2, \dots, \delta q_m$. It is important to notice that the symbols δ and d/dt are commutative, since

$$\delta \dot{x} = \frac{d}{dt}(\delta x + \delta x) - \frac{d\delta x}{dt} = \frac{d\delta x}{dt}, \quad \text{etc.} \quad (3)$$

Hence

$$\begin{aligned} \Sigma m(\dot{x}\dot{x} + \dot{y}\dot{y} + \dot{z}\dot{z}) &= \frac{d}{dt} \Sigma m(\dot{x}\dot{x} + \dot{y}\dot{y} + \dot{z}\dot{z}) \\ &\quad - \Sigma m(\dot{x}\dot{x} + \dot{y}\dot{y} + \dot{z}\dot{z}) \\ &= \frac{d}{dt}(p_1 \dot{q}_1 + p_2 \dot{q}_2 + \dots) - \dot{T}, \quad (4) \end{aligned}$$

by § 1 (14). The last member may be written

$$p_1 \delta \dot{q}_1 + p_2 \delta \dot{q}_2 + \dots - \frac{\partial T}{\partial \dot{q}_1} \delta q_1 - \frac{\partial T}{\partial \dot{q}_2} \delta q_2 - \dots \quad (5)$$

Hence, omitting the terms which cancel in virtue of § 1 (13), we find

$$\Sigma m(\dot{x}\dot{x} + \dot{y}\dot{y} + \dot{z}\dot{z}) = \left(p_1 - \frac{\partial T}{\partial \dot{q}_1} \right) \delta q_1 + \left(p_2 - \frac{\partial T}{\partial \dot{q}_2} \right) \delta q_2 + \dots \quad (6)$$

For the right-hand side of (2) we have

$$\Sigma(X\dot{x} + Y\dot{y} + Z\dot{z}) = Q_1 \delta q_1 + Q_2 \delta q_2 + \dots \quad (7)$$

where

$$Q_1 = \Sigma \left(X \frac{\partial x}{\partial \dot{q}_1} + Y \frac{\partial y}{\partial \dot{q}_1} + Z \frac{\partial z}{\partial \dot{q}_1} \right), \quad (8)$$

The quantities Q_1, Q_2, \dots are called the *generalised components of force* acting on the system.

Comparing (6) and (7) we find

$$p_1 - \frac{\partial T}{\partial \dot{q}_1} = Q_1, \quad p_2 - \frac{\partial T}{\partial \dot{q}_2} = Q_2, \quad \dots \quad (9)$$

or, restoring the values of p_1, p_2, \dots

$$\frac{d}{dt} \left(\frac{\partial T}{\partial \dot{q}_1} \right) - \frac{\partial T}{\partial q_1} = Q_1, \quad \frac{d}{dt} \left(\frac{\partial T}{\partial \dot{q}_2} \right) - \frac{\partial T}{\partial q_2} = Q_2, \quad \dots \quad (10)$$

These are Lagrange's general equations of motion. Their number is of course equal to that of the co-ordinates q_1, q_2, \dots to be determined.

Analytically, the above proof is that given by Lagrange, but the terminology employed is of much more recent date, having been first introduced by Lord Kelvin and P. G. Tait; it has greatly promoted the physical application of the subject. Another proof of the equations (10), by direct transformation of co-ordinates, has been given by Hamilton and independently by other writers (see MECHANICS), but the variational method of Lagrange is that which stands in closest relation to the subsequent developments of the subject. The chapter of Maxwell, already referred to, is a most instructive commentary on the subject from the physical point of view, although the proof there attempted of the equations (10) is fallacious.

In a "conservative system" the work which would have to be done by extraneous forces to bring the system from rest in some standard configuration to rest in the configuration (q_1, q_2, \dots, q_n) is independent of the path, and may therefore be regarded as a definite function of q_1, q_2, \dots, q_n . Denoting this function (the *potential energy*) by V, we have, if there be no extraneous force on the system,

$$\Sigma(X\dot{x} + Y\dot{y} + Z\dot{z}) = -\dot{V}, \quad (11)$$

and therefore

$$Q_1 = -\frac{\partial V}{\partial q_1}, \quad Q_2 = -\frac{\partial V}{\partial q_2}, \quad \dots \quad (12)$$

Hence the typical Lagrange's equation may be now written in the form

$$\frac{d}{dt} \left(\frac{\partial T}{\partial \dot{q}_i} \right) - \frac{\partial T}{\partial q_i} = - \frac{\partial V}{\partial q_i} \quad (13)$$

or, again,

$$\dot{p}_i = - \frac{\partial}{\partial q_i} (V - T) \quad (14)$$

It has been proposed by Helmholtz to give the name *kinetic potential* to the combination $V - T$.

As shown under MECHANICS, § 22, we derive from (10)

$$\frac{\partial T}{\partial t} = Q_1 \dot{q}_1 + Q_2 \dot{q}_2 + \dots \quad (15)$$

and therefore in the case of a conservative system free from extraneous force,

$$\frac{d}{dt} (T + V) = 0 \text{ or } T + V = \text{const.} \quad (16)$$

which is the equation of energy. For examples of the application of the formula (13) see MECHANICS, § 22.

3. *Constrained Systems.*

It has so far been assumed that the geometrical relations, if any, which exist between the various parts of the system are of the type § 1 (1), and so do not contain t explicitly. The extension of Lagrange's equations to the case of "varying relations" of the type

$$x = f(t, q_1, q_2, \dots, q_n), \quad y = g(t, \dots), \quad z = h(t, \dots) \quad (1)$$

was made by J. M. L. Vieille. We now have

$$\dot{x} = \frac{\partial x}{\partial t} + \frac{\partial x}{\partial q_1} \dot{q}_1 + \frac{\partial x}{\partial q_2} \dot{q}_2 + \dots, \quad \text{etc., etc.} \quad (2)$$

$$\dot{y} = \frac{\partial y}{\partial t} + \frac{\partial y}{\partial q_1} \dot{q}_1 + \frac{\partial y}{\partial q_2} \dot{q}_2 + \dots, \quad \text{etc., etc.} \quad (3)$$

so that the expression § 1 (8) for the kinetic energy is to be replaced by

$$2T = a_0 + 2a_1 \dot{q}_1 + 2a_2 \dot{q}_2 + \dots + A_{11} \dot{q}_1^2 + A_{22} \dot{q}_2^2 + \dots + A_{12} \dot{q}_1 \dot{q}_2 + \dots \quad (4)$$

where

$$a_0 = 2m \left\{ \frac{(\partial x}{\partial t})^2 + \frac{(\partial y}{\partial t})^2 + \frac{(\partial z}{\partial t})^2} \right\}, \quad (5)$$

$$a_1 = 2m \left\{ \dot{q}_1 \frac{\partial x}{\partial q_1} + \dot{q}_2 \frac{\partial y}{\partial q_1} + \dot{q}_3 \frac{\partial z}{\partial q_1} \right\}, \quad \dots$$

and the forms of A_{11}, A_{22} are as given by § 1 (7). It is to be remembered that the coefficients $a_0, a_1, a_2, \dots, A_{11}, A_{22}, \dots, A_{12}, \dots$ will in general involve t explicitly as well as implicitly through the co-ordinates q_1, q_2, \dots . Again, we find

$$\begin{aligned} \Sigma m (\dot{x}^2 + \dot{y}^2 + \dot{z}^2) &= (a_0 + A_{11} \dot{q}_1 + A_{22} \dot{q}_2 + \dots) \dot{q}_1^2 \\ &\quad + (a_1 + A_{12} \dot{q}_2 + A_{21} \dot{q}_1 + \dots) \dot{q}_2^2 + \dots \\ &= \frac{\partial T}{\partial \dot{q}_1} \dot{q}_1 + \frac{\partial T}{\partial \dot{q}_2} \dot{q}_2 + \dots \\ &= \dot{p}_1 \dot{q}_1 + \dot{p}_2 \dot{q}_2 + \dots \quad (6) \end{aligned}$$

where \dot{p}_i is defined as in § 1 (13). The derivation of Lagrange's equations then follows exactly as before. It is to be noted that the equation § 2 (15) does not as a rule now hold. The proof involved the assumption that T is a homogeneous quadratic function of the velocities $\dot{q}_1, \dot{q}_2, \dots$

It has been pointed out by R. B. Hayward that Vieille's case can be brought under Lagrange's by introducing a new co-ordinate (χ) in place of t , so far as it appears explicitly in the relations (1). We have then

$$2T = a_0 \chi^2 + 2(a_1 \dot{q}_1 + a_2 \dot{q}_2 + \dots) \chi + A_{11} \dot{q}_1^2 + A_{22} \dot{q}_2^2 + \dots + 2A_{12} \dot{q}_1 \dot{q}_2 + \dots \quad (7)$$

The equations of motion will be as in § 2 (10), with the additional equation

$$\frac{d}{d\chi} \frac{\partial T}{\partial \dot{\chi}} - \frac{\partial T}{\partial \chi} = X, \quad (8)$$

where X is the force corresponding to the co-ordinate χ . We may suppose X to be adjusted so as to make $\dot{\chi} = 0$, and in the remaining equations nothing is altered if we write t for χ before, instead of after, the differentiations. The reason why the equation § 2 (15) no longer holds is that we should require to add a term $X \dot{\chi}$ on the right-hand side; this represents the rate at which work is being done by the constraining forces required to keep $\dot{\chi}$ constant.

As an example, let x, y, z be the co-ordinates of a particle relative to axes fixed in a solid which is free to rotate about the axis of z . If ϕ be the angular co-ordinate of the solid, we find without difficulty

$$2T = m(x^2 + y^2 + z^2) + 2I \omega (x\dot{y} - y\dot{x}) + [I + m(x^2 + y^2)] \dot{\phi}^2 \quad (9)$$

where I is the moment of inertia of the solid. The equations of motion, viz.

$$\frac{d}{dt} \frac{\partial T}{\partial \dot{x}} - \frac{\partial T}{\partial x} = X, \quad \frac{d}{dt} \frac{\partial T}{\partial \dot{y}} - \frac{\partial T}{\partial y} = Y, \quad \frac{d}{dt} \frac{\partial T}{\partial \dot{z}} - \frac{\partial T}{\partial z} = Z, \quad (10)$$

and

$$\frac{d}{dt} \frac{\partial T}{\partial \dot{\phi}} - \frac{\partial T}{\partial \phi} = \Phi. \quad (11)$$

become

$$m(x - 2\dot{\phi}y - y\dot{\phi} - \gamma\dot{\phi}) = X, \quad m(y + \dot{\phi}x - x\dot{\phi} + \gamma\dot{\phi}) = Y, \quad m\dot{z} = Z, \quad (12)$$

and

$$\frac{d}{dt} [I + m(x^2 + y^2)] \dot{\phi} + m(x\dot{y} - y\dot{x}) = \Phi. \quad (13)$$

If we suppose Φ adjusted so as to maintain $\dot{\phi} = 0$, or (again) if we suppose the moment of inertia I to be infinitely great, we obtain the familiar equations of motion relative to moving axes, viz.

$$m(x - 2\omega y - \omega^2 z) = X, \quad m(y + 2\omega x - \omega^2 y) = Y, \quad m\dot{z} = Z, \quad (14)$$

where ω has been written for $\dot{\phi}$. These are the equations which we should have obtained by applying Lagrange's rule at once to the formula

$$2T = m(x^2 + y^2 + z^2) + 2m\omega(x\dot{y} - y\dot{x}) + m\dot{z}^2(x^2 + y^2), \quad (15)$$

which gives the kinetic energy of the particle referred to axes rotating with the constant angular velocity ω . (See MECHANICS, § 13.)

More generally, let us suppose that we have a certain group of co-ordinates $x, x', x'' \dots$ whose absolute values do not affect the expression for the kinetic energy, and that by suitable forces of the corresponding types the velocity-components $\dot{x}, \dot{x}', \dot{x}'' \dots$ are maintained constant. The remaining co-ordinates being denoted by q_1, q_2, \dots, q_n , we may write

$$2T = \mathfrak{E} + T_0 + 2(a_1 \dot{q}_1 + a_2 \dot{q}_2 + \dots) \dot{x} + 2(a'_1 \dot{q}_1 + a'_2 \dot{q}_2 + \dots) \dot{x}' + \dots \quad (16)$$

where \mathfrak{E} is a homogeneous quadratic function of the velocities $\dot{q}_1, \dot{q}_2, \dots, \dot{q}_n$ of the type § 1 (8), whilst T_0 is a homogeneous quadratic function of the velocities $\dot{x}, \dot{x}', \dot{x}'' \dots$ alone. The remaining terms, which are bilinear in respect of the two sets of velocities, are indicated more fully. The formulae (10) of § 2 give n equations of the type

$$\frac{d}{dt} \left(\frac{\partial \mathfrak{E}}{\partial \dot{q}_i} \right) - \frac{\partial \mathfrak{E}}{\partial q_i} + (r, 1) \dot{q}_1 + (r, 2) \dot{q}_2 + \dots - \frac{\partial T_0}{\partial \dot{q}_i} = Q_i \quad (17)$$

where

$$(r, s) = \left(\frac{\partial a_r}{\partial \dot{q}_s} - \frac{\partial a_s}{\partial \dot{q}_r} \right) \dot{x} + \left(\frac{\partial a'_r}{\partial \dot{q}_s} - \frac{\partial a'_s}{\partial \dot{q}_r} \right) \dot{x}' + \dots \quad (18)$$

These quantities (r, s) are subject to the relations

$$(r, s) = - (s, r), \quad (r, r) = 0. \quad (19)$$

The remaining differential equations, equal in number to the co-ordinates $x, x', x'' \dots$, yield expressions for the forces which must be applied in order to maintain the velocities $\dot{x}, \dot{x}', \dot{x}'' \dots$ constant; they need not be written down. If we follow the method by which the equation of energy was established in § 2, the equations (17) lead, on taking account of the relations (19), to

$$\frac{d}{dt} (\mathfrak{E} - T_0) = Q_1 \dot{q}_1 + Q_2 \dot{q}_2 + \dots + Q_n \dot{q}_n \quad (20)$$

or, in case the forces Q_i depend only on the co-ordinates q_1, q_2, \dots, q_n and are conservative,

$$\mathfrak{E} + V - T_0 = \text{const.} \quad (21)$$

The conditions that the equations (17) should be satisfied by zero values of the velocities $\dot{q}_1, \dot{q}_2, \dots, \dot{q}_n$ are

$$Q_i = - \frac{\partial T_0}{\partial \dot{q}_i} \quad (22)$$

or in the case of conservative forces

$$\frac{\partial}{\partial q_i} (V - T_0) = 0, \quad (23)$$

i.e. the value of $V - T_0$ must be stationary.

We may apply this to the case of a system whose configuration relative to axes rotating with constant angular velocity (ω) is defined by means of the n co-ordinates q_1, q_2, \dots, q_n . This is important on account of its bearing on the kinetic theory of the tides. Since the Cartesian co-ordinates x, y, z of any particle m of the system relative to the moving axes are functions of q_1, q_2, \dots, q_n , of the form § 1 (1), we have, by (15)

$$2\mathfrak{E} = \Sigma m (\dot{x}^2 + \dot{y}^2 + \dot{z}^2), \quad 2T_0 = \omega^2 \Sigma m (x^2 + y^2) \quad (24)$$

$$a_i = \Sigma m \left(\frac{\partial y}{\partial \dot{q}_i} - \frac{\partial z}{\partial \dot{q}_i} \right), \quad (25)$$

whence

$$(r, s) = 2\omega \Sigma m \frac{\partial (z, y)}{\partial (q_i, q_j)} \quad (26)$$

The conditions of relative equilibrium are given by (23).

It will be noticed that this expression $V - T_0$, which is to be stationary, differs from the true potential energy by a term which represents the potential energy of the system in relation to fictitious "centrifugal forces." The question of stability of relative equilibrium will be noticed later (§ 6).

It should be observed that the remarkable formula (20) may in the present case be obtained directly as follows. From (15) and (14) we find

$$\begin{aligned} \frac{d}{dt} \left(\frac{\partial T}{\partial \dot{q}_i} \right) &= \frac{d}{dt} (\mathfrak{E} + T_0) + \omega \Sigma m (x\dot{y} - y\dot{x}) \\ &= \frac{d}{dt} (\mathfrak{E} - T_0) + \omega \Sigma m (x\dot{y} - y\dot{x}). \end{aligned} \quad (27)$$

This must be equal to the rate at which the forces acting on the system do work, viz. to

$$\omega \Sigma (xY - yX) + Q_1 \dot{q}_1 + Q_2 \dot{q}_2 + \dots + Q_n \dot{q}_n,$$

where the first term represents the work done in virtue of the rotation.

We have still to notice the modifications which Lagrange's equations undergo when the co-ordinates q_1, q_2, \dots, q_n are not all independently variable. In the first place, *Case-strained systems.* we may suppose them connected by a number m ($< n$) of relations of the type

$$A_i(q_1, q_2, \dots, q_n) = 0, B_j(q_1, q_2, \dots, q_n) = 0, \text{ \&c.} \quad (28)$$

These may be interpreted as introducing partial constraints into a previously free system. The variations $\delta q_1, \delta q_2, \dots, \delta q_n$ in the expressions (6) and (7) of § 2 which are to be equated are no longer independent, but are subject to the relations

$$\frac{\partial A_i}{\partial q_1} \delta q_1 + \frac{\partial A_i}{\partial q_2} \delta q_2 + \dots = 0, \frac{\partial B_j}{\partial q_1} \delta q_1 + \frac{\partial B_j}{\partial q_2} \delta q_2 + \dots = 0, \text{ \&c.} \quad (29)$$

Introducing indeterminate multipliers λ, μ, \dots , one for each of these equations, we obtain in the usual manner m equations of the type

$$\frac{d}{dt} \frac{\partial T}{\partial \dot{q}_i} - \frac{\partial T}{\partial q_i} = Q_i + \lambda \frac{\partial A_i}{\partial q_i} + \mu \frac{\partial B_j}{\partial q_i} + \dots \quad (30)$$

in place of § 2 (10). These equations, together with (28), serve to determine the n co-ordinates q_1, q_2, \dots, q_n and the m multipliers λ, μ, \dots

When t does not occur explicitly in the relations (28) the system is said to be *holonomic*. The term connotes the existence of integral (as opposed to differential) relations between the co-ordinates, independent of the time.

Again, it may happen that although there are no prescribed relations between the co-ordinates q_1, q_2, \dots, q_n , yet from the circumstances of the problem certain geometrical conditions are imposed on their variations, thus

$$A_1 \delta q_1 + A_2 \delta q_2 + \dots = 0, B_1 \delta q_1 + B_2 \delta q_2 + \dots = 0, \text{ \&c.} \quad (31)$$

where the coefficients are functions of q_1, q_2, \dots, q_n and (possibly) of t . It is assumed that these equations are not integrable as regards the variables q_1, q_2, \dots, q_n ; otherwise, we fall back on the previous conditions. Cases of the present type arise, for instance, in ordinary dynamics when we have a solid rolling on a (fixed or moving) surface. The six co-ordinates which serve to specify the position of the solid at any instant are not subject to any necessary relation, but the conditions to be satisfied at the point of contact impose three conditions of the form (31). The general equations of motion are obtained, as before, by the method of indeterminate multipliers, thus

$$\frac{d}{dt} \frac{\partial T}{\partial \dot{q}_i} - \frac{\partial T}{\partial q_i} = Q_i + \lambda A_i + \mu B_i + \dots \quad (32)$$

The co-ordinates q_1, q_2, \dots, q_n and the indeterminate multipliers λ, μ, \dots , are determined by these equations and by the velocity-conditions corresponding to (31). When t does not appear explicitly in the coefficients, these velocity-conditions take the forms

$$A_1 \dot{q}_1 + A_2 \dot{q}_2 + \dots = 0, B_1 \dot{q}_1 + B_2 \dot{q}_2 + \dots = 0, \text{ \&c.} \quad (33)$$

Systems of this kind, where the relations (31) are not integrable, are called *non-holonomic*.

4. Hamiltonian Equations of Motion.

In the Hamiltonian form of the equations of motion of a conservative system with unvarying relations, the kinetic energy is supposed expressed in terms of the momenta p_1, p_2, \dots and the co-ordinates q_1, q_2, \dots , as in § 1 (19). Since the symbol δ now denotes a variation extending to the co-ordinates as well as to the momenta, we must add to the last member of § 1 (21) terms of the types

$$\frac{\partial T}{\partial q_1} \delta q_1 + \frac{\partial T}{\partial q_2} \delta q_2 + \dots \quad (1)$$

Since the variations $\delta p_1, \delta p_2, \dots, \delta p_n, \delta q_1, \delta q_2, \dots$ may be taken to be independent, we infer the equations § 1 (23) as before, together with

$$\frac{\partial T}{\partial q_1} = -\frac{\partial T}{\partial q_1}, \frac{\partial T}{\partial q_2} = -\frac{\partial T}{\partial q_2}, \dots \quad (2)$$

Hence the Lagrangian equations § 2 (14) transform into

$$p_1 = -\frac{\partial}{\partial \dot{q}_1} (T+V), p_2 = -\frac{\partial}{\partial \dot{q}_2} (T+V), \dots \quad (3)$$

If we write $H = T+V, \dots \dots \dots (4)$

so that H denotes the total energy of the system, supposed expressed in terms of the new variables, we get

$$p_1 = -\frac{\partial H}{\partial \dot{q}_1}, p_2 = -\frac{\partial H}{\partial \dot{q}_2}, \dots \quad (5)$$

If to these we join the equations

$$q_1 = \frac{\partial H}{\partial p_1}, q_2 = \frac{\partial H}{\partial p_2}, \dots \quad (6)$$

which follow at once from § 1 (23), since V does not involve $\dot{p}_1, \dot{p}_2, \dots$ we obtain a complete system of differential equations of the first order for the determination of the motion.

The equation of energy is verified immediately by (5) and (6), since these make

$$\frac{dH}{dt} = \frac{\partial H}{\partial p_1} \dot{p}_1 + \frac{\partial H}{\partial p_2} \dot{p}_2 + \dots + \frac{\partial H}{\partial q_1} \dot{q}_1 + \frac{\partial H}{\partial q_2} \dot{q}_2 + \dots = 0. \quad (7)$$

The Hamiltonian transformation is extended to the case of varying relations as follows. Instead of (4) we write

$$H = p_1 \dot{q}_1 + p_2 \dot{q}_2 + \dots - T + V, \quad (8)$$

and imagine H to be expressed in terms of the momenta p_1, p_2, \dots the co-ordinates q_1, q_2, \dots , and the time. The internal forces of the system are assumed to be conservative, with the potential energy V . Performing the variation δ on both sides, we find

$$\delta H = \delta p_1 \dot{q}_1 + \dots - \frac{\partial T}{\partial \dot{q}_1} \delta \dot{q}_1 + \frac{\partial V}{\partial q_1} \delta q_1 + \dots \quad (9)$$

terms which cancel in virtue of the definition of p_1, p_2, \dots being omitted. Since $\delta p_1, \delta p_2, \dots, \delta q_1, \delta q_2, \dots$ may be taken to be independent, we infer

$$\dot{q}_1 = \frac{\partial H}{\partial p_1}, \dot{q}_2 = \frac{\partial H}{\partial p_2}, \dots \quad (10)$$

and $\frac{\partial}{\partial q_1} (T-V) = -\frac{\partial H}{\partial q_1}, \frac{\partial}{\partial q_2} (T-V) = -\frac{\partial H}{\partial q_2}, \dots \quad (11)$

It follows from (11) that

$$p_1 = -\frac{\partial H}{\partial \dot{q}_1}, p_2 = -\frac{\partial H}{\partial \dot{q}_2}, \dots \quad (12)$$

The equations (10) and (12) have the same form as above, but H is no longer equal to the energy of the system.

5. Cyclic Systems.

A cyclic or gyrostatic system is characterized by the following properties. In the first place, the kinetic energy is not affected if we alter the absolute values of certain of the co-ordinates, which we will denote by x, x', x'', \dots , provided the remaining co-ordinates q_1, q_2, \dots, q_m and the velocities (including of course the velocities $\dot{x}, \dot{x}', \dot{x}'', \dots$) are unaltered. Secondly, there are no forces acting on the system of the types x, x', x'', \dots . This case arises, for example, when the system includes gyrostats which are free to rotate about their axes, the co-ordinates x, x', x'', \dots then being the angular co-ordinates of the gyrostats relatively to their frames. Again, in theoretical hydrodynamics we have the problem of moving solids in a frictionless liquid; the ignored co-ordinates x, x', x'', \dots then refer to the fluid, and are infinite in number. The same question presents itself in various physical speculations where certain phenomena are ascribed to the existence of latent motions in the ultimate constituents of matter. The general theory of such systems has been treated by E. J. Routh, Lord Kelvin, and H. L. F. Helmholtz.

If we suppose the kinetic energy T to be expressed, as in Lagrange's method, in terms of the co-ordinates and the velocities, the equations of motion corresponding *respectively* to x, x', x'', \dots reduce, in virtue of the above hypotheses, to the forms

$$\frac{d}{dt} \frac{\partial T}{\partial \dot{x}} = 0, \frac{d}{dt} \frac{\partial T}{\partial \dot{x}'} = 0, \frac{d}{dt} \frac{\partial T}{\partial \dot{x}''} = 0, \dots \quad (1)$$

whence $\frac{\partial T}{\partial \dot{x}} = \alpha, \frac{\partial T}{\partial \dot{x}'} = \alpha', \frac{\partial T}{\partial \dot{x}''} = \alpha'', \dots \quad (2)$

where $\alpha, \alpha', \alpha'', \dots$ are the constant momenta corresponding to the cyclic co-ordinates x, x', x'', \dots . These equations are linear in $\dot{x}, \dot{x}', \dot{x}'', \dots$; solving them with respect to these quantities and substituting in the remaining Lagrangian equations, we obtain m differential equations to determine the remaining co-ordinates q_1, q_2, \dots, q_m . The object of the present investigation is to ascertain the general form of the resulting equations. The retained co-ordinates q_1, q_2, \dots, q_m may be called (for distinction) the *palpable* co-ordinates of the system; in many practical questions they are the only co-ordinates directly in evidence.

If, as in § 1 (25), we write $R = T - \alpha \dot{x} - \alpha' \dot{x}' - \alpha'' \dot{x}'' - \dots \quad (3)$

and imagine R to be expressed by means of (2) as a quadratic function of $\dot{q}_1, \dot{q}_2, \dots, \dot{q}_m, \alpha, \alpha', \alpha'', \dots$ with coefficients which are in general functions of the co-ordinates q_1, q_2, \dots, q_m , then, performing the operation δ on both sides, we find

$$\frac{\partial R}{\partial \dot{q}_1} \delta \dot{q}_1 + \dots + \frac{\partial R}{\partial \dot{q}_m} \delta \dot{q}_m + \dots + \frac{\partial R}{\partial \alpha} \delta \alpha + \dots + \frac{\partial R}{\partial \alpha'} \delta \alpha' + \dots + \frac{\partial R}{\partial \alpha''} \delta \alpha'' + \dots + \frac{\partial R}{\partial q_1} \delta q_1 + \dots + \frac{\partial R}{\partial q_2} \delta q_2 + \dots - \delta \dot{x} - \delta \dot{x}' - \delta \dot{x}'' - \dots \quad (4)$$

Omitting the terms which cancel by (2), we find

$$\frac{\partial T}{\partial \dot{q}_1} = \frac{\partial R}{\partial \dot{q}_1}, \quad \frac{\partial T}{\partial \dot{q}_2} = \frac{\partial R}{\partial \dot{q}_2}, \quad \dots \quad (5)$$

$$\frac{\partial T}{\partial q_1} = \frac{\partial R}{\partial q_1}, \quad \frac{\partial T}{\partial q_2} = \frac{\partial R}{\partial q_2}, \quad \dots \quad (6)$$

$$\dot{x} = \frac{\partial R}{\partial x}, \quad \dot{x}' = -\frac{\partial R}{\partial x'}, \quad \dot{x}'' = -\frac{\partial R}{\partial x''}, \quad \dots \quad (7)$$

Substituting in § 2 (10), we have

$$\frac{d}{dt} \frac{\partial R}{\partial \dot{q}_1} - \frac{\partial R}{\partial q_1} = Q_1, \quad \frac{d}{dt} \frac{\partial R}{\partial \dot{q}_2} - \frac{\partial R}{\partial q_2} = Q_2, \quad \dots \quad (8)$$

These are Routh's forms of the modified Lagrangian equations. Equivalent forms were obtained independently by Helmholtz at a later date.

The function R is made up of three parts, thus

$$R = R_{200} + R_{111} + R_{000} \quad (9)$$

where R_{200} is a homogeneous quadratic function of q_1, q_2, \dots, q_n , R_{111} is a homogeneous quadratic function of x, x', x'', \dots , whilst R_{000} consists of products of the velocities $\dot{q}_1, \dot{q}_2, \dots, \dot{q}_n$ into the momenta x, x', x'', \dots . Hence from (3) and (7) we have

$$T = R - \left(x \frac{\partial R}{\partial x} + x' \frac{\partial R}{\partial x'} + x'' \frac{\partial R}{\partial x''} + \dots \right) = R_{200} - R_{000} \quad (10)$$

If, as in § 1 (30), we write this in the form

$$T = \mathfrak{W} + K \quad (11)$$

then (3) may be written

$$R = \mathfrak{W} - K + \beta_1 \dot{q}_1 + \beta_2 \dot{q}_2 + \dots \quad (12)$$

where β_1, β_2, \dots are linear functions of x, x', x'', \dots , say

$$\beta_1 = a_1 x + a_1' x' + a_1'' x'' + \dots \quad (13)$$

the coefficients a, a', a'', \dots being in general functions of the co-ordinates q_1, q_2, \dots, q_n . Evidently β_1 denotes that part of the momentum-component $\partial R / \partial \dot{q}_1$ which is due to the cyclic motions. Now

$$\frac{d}{dt} \frac{\partial R}{\partial \dot{q}_1} = \frac{d}{dt} \left(\frac{\partial \mathfrak{W}}{\partial \dot{q}_1} + \beta_1 \right) = \frac{d}{dt} \frac{\partial \mathfrak{W}}{\partial \dot{q}_1} + \frac{\partial \beta_1}{\partial q_1} \dot{q}_1 + \frac{\partial \beta_1}{\partial q_2} \dot{q}_2 + \dots \quad (14)$$

$$\frac{\partial R}{\partial q_1} = \frac{\partial \mathfrak{W}}{\partial q_1} - \frac{\partial K}{\partial q_1} + \frac{\partial \beta_1}{\partial q_1} \dot{q}_1 + \frac{\partial \beta_2}{\partial q_1} \dot{q}_2 + \dots \quad (15)$$

Hence, substituting in (8), we obtain the typical equation of motion of a gyrostatic system in the form

$$\frac{d}{dt} \frac{\partial \mathfrak{W}}{\partial \dot{q}_1} - \frac{\partial \mathfrak{W}}{\partial q_1} + (r_1 \dot{q}_1 + r_2 \dot{q}_2 + \dots + r_n \dot{q}_n) \dot{q}_1 + \dots + \frac{\partial K}{\partial q_1} = Q_1 \quad (16)$$

where

$$(r, s) = \frac{\partial \beta_r}{\partial q_s} - \frac{\partial \beta_s}{\partial q_r} \quad (17)$$

This form is due to Lord Kelvin. When q_1, q_2, \dots, q_n have been determined, as functions of the time, the velocities corresponding to the cyclic co-ordinates can be found, if required, from the relations (7), which may be written

$$\left. \begin{aligned} x &= \frac{\partial K}{\partial x} - a_1 \dot{q}_1 - a_2 \dot{q}_2 - \dots \\ x' &= \frac{\partial K}{\partial x'} - a_1' \dot{q}_1 - a_2' \dot{q}_2 - \dots \\ &\quad \& \dots, \& \dots \end{aligned} \right\} \quad (18)$$

It is to be particularly noticed that

$$(r, r) = 0, \quad (r, s) = -(s, r) \quad (19)$$

Hence, if in (16) we put $r = 1, 2, 3, \dots, n$, and multiply by $\dot{q}_1, \dot{q}_2, \dots, \dot{q}_n$ respectively, and add, we find

$$\frac{d}{dt} (\mathfrak{W} + K) = Q_1 \dot{q}_1 + Q_2 \dot{q}_2 + \dots \quad (20)$$

or, in the case of a conservative system

$$\mathfrak{W} + V + K = \text{const.} \quad (21)$$

which is the equation of energy.

The equation (16) includes § 3 (17) as a particular case, the eliminated co-ordinate being the angular co-ordinate of a rotating solid having an infinite moment of inertia.

In the particular case where the cyclic momenta x, x', x'', \dots are all zero, (16) reduces to

$$\frac{d}{dt} \frac{\partial \mathfrak{W}}{\partial \dot{q}_1} - \frac{\partial \mathfrak{W}}{\partial q_1} = Q_1 \quad (22)$$

The form is the same as in § 2, and the system now behaves, as regards the co-ordinates q_1, q_2, \dots, q_n , exactly like the acyclic type there contemplated. These co-ordinates do not, however, now fix the position of every particle of the system. For example, if by suitable forces the system be brought back to its initial con-

figuration (so far as this is defined by q_1, q_2, \dots, q_n), after performing any evolutions, the ignored co-ordinates x, x', x'', \dots will not in general return to their original values.

If in Lagrange's equations § 2 (10) we reverse the sign of the element dt , the equations are unaltered. The motion is therefore reversible; that is to say, if as the system is passing through any configuration its velocities $\dot{q}_1, \dot{q}_2, \dots, \dot{q}_n$ be all reversed, it will (if the forces be the same in the same configuration) retrace its former path. But it is important to observe that the statement does not in general hold of a gyrostatic system; the terms of (16), which are linear in $\dot{q}_1, \dot{q}_2, \dots, \dot{q}_n$, change sign with dt , whilst the others do not. Hence the motion of a gyrostatic system is not reversible, unless indeed we reverse the cyclic motions as well as the velocities $\dot{q}_1, \dot{q}_2, \dots, \dot{q}_n$. For instance, the precessional motion of a top cannot be reversed unless we reverse the spin.

The conditions of equilibrium of a system with latent cyclic motions are obtained by putting $\dot{q}_1 = 0, \dot{q}_2 = 0, \dots, \dot{q}_n = 0$ in (16); viz. they are

$$Q_1 = \frac{\partial K}{\partial q_1}, \quad Q_2 = \frac{\partial K}{\partial q_2}, \quad \dots \quad (23)$$

These may of course be obtained independently. Thus if the system be guided from (apparent) rest in the configuration (q_1, q_2, \dots, q_n) to rest in the configuration $(q_1 + \delta q_1, q_2 + \delta q_2, \dots, q_n + \delta q_n)$, the work done by the forces must be equal to the increment of the kinetic energy. Hence

$$Q_1 \delta q_1 + Q_2 \delta q_2 + \dots = \delta K \quad (24)$$

which is equivalent to (23). The conditions are the same as for the equilibrium of a system without latent motion, but endowed with potential energy K. This is important from a physical point of view, as showing how energy which is apparently potential may in its ultimate essence be kinetic.

By means of the formulæ (18), which now reduce to

$$x = \frac{\partial K}{\partial x}, \quad x' = \frac{\partial K}{\partial x'}, \quad x'' = \frac{\partial K}{\partial x''}, \quad \dots \quad (25)$$

K may also be expressed as a homogeneous quadratic function of the cyclic velocities x, x', x'', \dots . Denoting it in this form by T_0 , we have

$$\delta(T_0 + K) = 2\delta K = \delta(x^2 + x'^2 + x''^2 + \dots) \quad (26)$$

Performing the variations, and omitting the terms which cancel by (2) and (25), we find

$$\frac{\partial T_0}{\partial \dot{q}_1} = -\frac{\partial K}{\partial \dot{q}_1}, \quad \frac{\partial T_0}{\partial \dot{q}_2} = -\frac{\partial K}{\partial \dot{q}_2}, \quad \dots \quad (27)$$

so that the formulæ (23) become

$$Q_1 = -\frac{\partial T_0}{\partial \dot{q}_1}, \quad Q_2 = -\frac{\partial T_0}{\partial \dot{q}_2}, \quad \dots \quad (28)$$

A simple example is furnished by the top (MECHANICS, § 22). The cyclic co-ordinates being ψ, ϕ , we find

$$2\mathfrak{W} = A\dot{\psi}^2, \quad 2K = \frac{(\mu - \nu \cos \theta)^2}{A \sin^2 \theta} \dot{\phi}^2, \quad (29)$$

whence we may verify that $\partial T_0 / \partial \dot{\phi} = -\partial K / \partial \dot{\phi}$ in accordance with (27). And the condition of equilibrium

$$\frac{\partial K}{\partial \psi} = -\frac{\partial V}{\partial \psi} \quad (30)$$

gives the condition of steady precession.

6. Stability of Steady Motion.

The small oscillations of a conservative system about a configuration of equilibrium, and the criterion of stability, are discussed in MECHANICS, § 23. The question of the stability of given types of motion is more difficult, owing to the want of a sufficiently general, and at the same time precise, definition of what we mean by "stability." A number of definitions which have been propounded by different writers are examined by F. Klein and A. Sommerfeld in their work *Über die Theorie des Kreisels* (1897-1903). Rejecting previous definitions, they base their criterion of stability on the character of the changes produced in the path of the system by small arbitrary disturbing impulses. If the undisturbed path be the limiting form of the disturbed path when the impulses are indefinitely diminished, it is said to be stable, but not otherwise. For instance, the vertical fall of a particle under gravity is reckoned as stable, although for a given impulsive disturbance, however small, the deviation of the particle's position at any time t from the position which it would have occupied in the original motion increases indefinitely with t . Even this criterion, as the writers quoted themselves recognize, is not free from ambiguity unless the phrase "limiting form," as applied to a path, be strictly defined. It appears, moreover, that a definition which is analytically precise may not in all cases be easy to reconcile with geometrical prepossessions. Thus a particle moving in a circle about a centre of force varying inversely as the cube of the distance will if slightly disturbed either fall into the centre, or recede to infinity, after describing in either case a spiral with an infinite number of

convolutions. Each of these spirals has, analytically, the circle as its limiting form, although the motion in the circle is most naturally described as unstable.

A special form of the problem, of great interest, presents itself in the steady motion of a gyrostatic system, when the non-eliminated co-ordinates q_1, q_2, \dots, q_m all vanish (see § 5). This has been discussed by Routh, Lord Kelvin and Tait, and Poincaré. These writers treat the question, by an extension of Lagrange's method, as a problem of small oscillations. Whether we adopt the notion of stability which this implies, or take up the position of Klein and Sommerfeld, there is no difficulty in showing that stability is ensured if $V+K$ be a minimum as regards variations of q_1, q_2, \dots, q_m . The proof is the same as that of Dirichlet for the case of statical stability.

We can illustrate this condition from the case of the top, where, in our previous notation,

$$V+K = Mgh \cos \theta + \frac{(\mu - \cos \theta)^2}{2A \sin^2 \theta} + \frac{p^2}{2C} \quad (1)$$

To examine whether the steady motion with the centre of gravity vertically above the pivot is stable, we must put $\mu = \mu$. We then find without difficulty that $V+K$ is a minimum provided $\mu^2 \geq 4AMgh$. The method of small oscillations gave us the condition $\mu^2 > 4AMgh$, and indicated instability in the cases $\mu^2 \leq 4AMgh$. The present criterion can also be applied to show that the steady precessional motions in which the axis has a constant inclination to the vertical are stable.

The question remains, as before, whether it is essential for stability that $V+K$ should be a minimum. It appears that from the point of view of the theory of small oscillations it is not essential, and that there may even be stability when $V+K$ is a maximum. The precise conditions, which are of a somewhat elaborate character, have been formulated by Routh. An important distinction has, however, been established by Thomson and Tait, and by Poincaré, between what we may call *ordinary* or *temporary* stability (which is stability in the above sense) and *permanent* or *secular* stability, which means stability when regard is had to possible dissipative forces called into play whenever the co-ordinates q_1, q_2, \dots, q_m vary. Since the total energy of the system at any instant is given (in the notation of § 5) by an expression of the form $\mathcal{E} = V+K$, where \mathcal{E} cannot be negative, the argument of Thomson and Tait, given under MECHANICS, § 23, for the statical question, shows that it is a necessary as well as a sufficient condition for secular stability that $V+K$ should be a minimum. When a system is "ordinarily" stable, but "secularly" unstable, the operation of the frictional forces is to induce a gradual increase in the amplitude of the free vibrations which are called into play by accidental disturbances.

There is a similar theory in relation to the constrained systems considered in § 3 above. The equation (21) there given leads to the conclusion that for secular stability of any type of motion in which the velocities $\dot{q}_1, \dot{q}_2, \dots, \dot{q}_n$ are zero it is necessary and sufficient that the function $V-T_0$ should be a minimum.

The simplest possible example of this is the case of a particle at the lowest point of a smooth spherical bowl which rotates with constant angular velocity (ω) about the vertical diameter. This position obviously possesses "ordinary" stability. If a be the radius of the bowl, and θ denote angular distance from the lowest point, we have

$$V-T_0 = mga(1 - \cos \theta) - \frac{1}{2}m\omega^2 a^2 \sin^2 \theta; \quad (2)$$

this is a minimum for $\theta=0$ only so long as $\omega^2 < g/a$. For greater values of ω the only position of "permanent" stability is that in which the particle rotates with the bowl at an angular distance $\cos^{-1}(g/\omega^2 a)$ from the lowest point. To examine the motion in the neighbourhood of the lowest point, when frictional forces are taken into account, we may take fixed ones, in a horizontal plane, through the lowest point. Assuming that the friction varies as the relative velocity, we have

$$\begin{cases} \dot{x} = -\beta^2 x - k(z + \omega y), \\ \dot{y} = -\beta^2 y - k(y - \omega x), \end{cases} \quad (3)$$

where $\beta^2 = g/a$. These combine into

$$\ddot{z} + k(1 + \beta^2 i k \omega)z = 0, \quad (4)$$

where $z = x + iy, i = \sqrt{-1}$. Assuming $s = C\omega^2$, we find

$$\lambda = -\frac{1}{2}k(1 + \omega/\beta) = i\beta, \quad (5)$$

if the square of k be neglected. The complete solution is then

$$z + iy = C_1 e^{\lambda t} + C_2 e^{\lambda' t} + C_3 e^{\lambda'' t} + C_4 e^{\lambda''' t}, \quad (6)$$

where

$$\beta_1 = \frac{1}{2}k(1 - \omega/\beta), \quad \beta_2 = \frac{1}{2}k(1 + \omega/\beta). \quad (7)$$

This represents two superposed circular vibrations, in opposite directions, of period $2\pi/\beta$. If $\omega < \beta$, the amplitude of each of these diminishes asymptotically to zero, and the position $x=0, y=0$ is permanently stable. But if $\omega > \beta$ the amplitude of that circular vibration which agrees in sense with the rotation ω will continually increase, and the particle will work its way in an ever-widening spiral path towards the eccentric position of secular stability. If the bowl be not spherical but ellipsoidal, the vertical diameter being a principal axis, it may easily be shown that the lowest position is permanently stable only so long as the period of the rotation is

longer than that of the slower of the two normal modes in the absence of rotation (see MECHANICS, § 13).

7. Principle of Least Action.

The preceding theories give us statements applicable to the system at any one instant of its motion. We now come to a series of theorems relating to the whole motion of the system between any two configurations through which it passes. viz. we consider the actual motion and compare it with other imaginable motions, differing infinitely little from it, between the same two configurations. We use the symbol δ to denote the transition from the actual to any one of the hypothetical motions.

The best-known theorem of this class is that of *Least Action*, originated by P. L. M. de Maupertuis, but first put in a definite form by Lagrange. The "action" of a single particle in passing from one position to another is the space-integral of the momentum, or the time-integral of the *vis viva*. The action of a dynamical system is the sum of the actions of its constituent particles, and is accordingly given by the formula

$$A = \sum \int m v ds = \sum \int m v^2 dt = 2 \int T dt. \quad (1)$$

The theorem referred to asserts that the free motion of a conservative system between any two given configurations is characterized by the property

$$\delta A = 0, \quad (2)$$

provided the total energy have the same constant value in the varied motion as in the actual motion.

If t, t' be the times of passing through the initial and final configurations respectively, we have

$$\begin{aligned} \delta A &= \delta \int_{t'}^t \sum m (\dot{x}^2 + \dot{y}^2 + \dot{z}^2) dt \\ &= 2 \int_{t'}^t \delta T dt + 2T' \delta t' - 2T \delta t, \end{aligned} \quad (3)$$

since the upper and lower limits of the integral must both be regarded as variable. This may be written

$$\begin{aligned} \delta A &= \int_{t'}^t \delta T dt + \int_{t'}^t \sum m (\dot{x} \delta x + \dot{y} \delta y + \dot{z} \delta z) dt + 2T' \delta t' - 2T \delta t \\ &= \int_{t'}^t \delta T dt + \left[\sum m (\dot{x} \delta x + \dot{y} \delta y + \dot{z} \delta z) \right]_{t'}^t \\ &\quad - \int_{t'}^t \sum m (\dot{x} \delta x + \dot{y} \delta y + \dot{z} \delta z) dt + 2T' \delta t' - 2T \delta t. \end{aligned} \quad (4)$$

Now, by d'Alembert's principle,

$$\sum m (\dot{x} \delta x + \dot{y} \delta y + \dot{z} \delta z) = -\delta V, \quad (5)$$

and by hypothesis we have

$$\delta(T+V) = 0. \quad (6)$$

The formula therefore reduces to

$$\delta A = \left[\sum m (\dot{x} \delta x + \dot{y} \delta y + \dot{z} \delta z) \right]_{t'}^t + 2T' \delta t' - 2T \delta t. \quad (7)$$

Since the terminal configurations are unaltered, we must have at the lower limit

$$\dot{x} \delta x + \dot{y} \delta y + \dot{z} \delta z = 0, \quad \delta x + \dot{x} \delta t = 0, \quad (8)$$

with similar relations at the upper limit. These reduce (7) to the form (2).

The equation (2), it is to be noticed, merely expresses that the variation of A vanishes to the first order; the phrase *stationary action* has therefore been suggested as indicating more accurately what has been proved. The action in the free path between two given configurations is in fact not invariably a minimum, and even when a minimum it need not be the *least possible* subject to the given conditions. Simple illustrations are furnished by the case of a single particle. A particle moving on a smooth surface, and free from extraneous force, will have its velocity constant; hence the theorem in this case resolves itself into

$$\delta \int ds = 0, \quad (9)$$

i.e. the path must be a geodesic line. Now a geodesic is not necessarily the *shortest* path between two given points on it; for example, on the sphere a great-circle arc ceases to be the shortest path between its extremities when it exceeds 180° . More generally, taking any surface, let a point P , starting from O , move along a geodesic; this geodesic will be a minimum path from O to P until P passes through a point O' (if such exist), which is the intersection with a consecutive geodesic through O . After this point the minimum property ceases. On an anticlastic surface two geodesics cannot intersect more than once, and each geodesic is therefore a minimum path between any two of its points. These illustrations are due to K. G. J. Jacobi, who has also formulated the general criterion, applicable to all dynamical systems, as follows:—Let O and P denote any two configurations on a natural path of the system. If this be the sole free path from O to P with the prescribed amount of energy, the action from O to P is a minimum. But if

there be several distinct paths, let P vary from coincidence with O along the first-named path; the action will then cease to be a minimum when a configuration O' is reached such that two of the possible paths from O to O' coincide. For instance, if O and P be positions on the parabolic path of a projectile under gravity, there will be a second path (with the same energy and therefore the same velocity of projection from O), these two paths coinciding when P is at the other extremity (O') say of the focal chord through O. The action from O to P will therefore be a minimum for all positions of P short of O'. Two configurations such as O and O' in the general statement are called conjugate *kinetic foci*. Cf. VARIATIONS, CALCULUS OF.

Before leaving this topic the connexion of the principle of stationary action with a well-known theorem of optics may be noticed. For the motion of a particle in a conservative field of force the principle takes the form

$$\int \delta v ds = 0. \dots (10)$$

On the copular theory of light v is proportional to the refractive index μ of the medium, whence

$$\int \delta \mu ds = 0. \dots (11)$$

In the formula (2) the energy in the hypothetical motion is prescribed, whilst the time of transit from the initial to the final configuration is variable. In another and generally more convenient theorem, due to Hamilton, the time of transit is prescribed to be the same as in the actual motion, whilst the energy may be different and need not (indeed) be constant. Under these conditions we have

$$\int_i^f (T-V) dt = 0. \dots (12)$$

where i, f are the prescribed times of passing through the given initial and final configurations. The proof of (12) is simple; we have

$$\begin{aligned} \int_i^f (T-V) dt &= \int_i^f (\delta T - \delta V) dt = \int_i^f [Zm(\delta x + \delta y + \delta z) - \delta V] dt \\ &= [Zm(\delta x + \delta y + \delta z)]_i^f \\ &\quad - \int_i^f [Zm(\delta x + \delta y + \delta z) + \delta V] dt. \dots (13) \end{aligned}$$

The integrated terms vanish at both limits, since by hypothesis the configurations at these instants are fixed; and the terms under the integral sign vanish by d'Alembert's principle.

The fact that in (12) the variation does not affect the time of transit renders the formula easy of application in any system of co-ordinates. Thus, to deduce Lagrange's equations, we have

$$\begin{aligned} \int_i^f (\delta T - \delta V) dt &= \int_i^f \left\{ \frac{\delta T}{\delta q_1} \delta q_1 + \frac{\delta T}{\delta q_2} \delta q_2 + \dots + \frac{\delta V}{\delta q_1} \delta q_1 - \dots \right\} dt \\ &= [\rho_1 \delta q_1 + \rho_2 \delta q_2 + \dots]_i^f \\ &\quad - \int_i^f \left\{ \rho_1 \frac{\delta T}{\delta q_1} + \frac{\delta V}{\delta q_1} \right\} \delta q_1 + \left\{ \rho_2 \frac{\delta T}{\delta q_2} + \frac{\delta V}{\delta q_2} \right\} \delta q_2 + \dots \left\} dt. (14) \end{aligned}$$

The integrated terms vanish at both limits; and in order that the remainder of the right-hand member may vanish it is necessary that the coefficients of $\delta q_1, \delta q_2, \dots$ under the integral sign should vanish for all values of t , since the variations in question are independent, and subject only to the condition of vanishing at the limits of integration. We are thus led to Lagrange's equation of motion for a conservative system. It appears that the formula (12) is a convenient as well as a compact embodiment of the whole of ordinary dynamics.

The modification of the Hamiltonian principle appropriate to the case of cyclic systems has been given by J. Larmor. If we write, as in § 1 (25),

$$R = T - \alpha x - \alpha' x' - \alpha'' x'' - \dots \dots (15)$$

we shall have

$$\int_i^f (R-V) dt = 0. \dots (16)$$

provided that the variation does not affect the cyclic momenta $\alpha, \alpha', \alpha'', \dots$, and that the configurations at times t and t' are unaltered, so far as they depend on the palpable co-ordinates q_1, q_2, \dots, q_n . The initial and final values of the ignored co-ordinates will in general be affected.

To prove (16) we have, on the above understandings,

$$\begin{aligned} \delta \int_i^f (R-V) dt &= \int_i^f (\delta T - \delta \alpha x - \dots - \delta V) dt \\ &= \int_i^f \left(\frac{\delta T}{\delta q_1} \delta q_1 + \dots + \frac{\delta T}{\delta q_n} \delta q_n + \dots - \delta V \right) dt. (17) \end{aligned}$$

where terms have been cancelled in virtue of § 5 (2). The last member of (17) represents a variation of the integral

$$\int_i^f (T-V) dt$$

on the supposition that $\delta x = 0, \delta x' = 0, \delta x'' = 0, \dots$ throughout, whilst $\delta q_1, \delta q_2, \delta q_n$ vanish at times t and t' ; i.e. it is a variation in which the initial and final configurations are absolutely unaltered. It therefore vanishes as a consequence of the Hamiltonian principle in its original form.

Larmor has also given the corresponding form of the principle of least action. He shows that if we write

$$A = \int (2T - \alpha x - \alpha' x' - \alpha'' x'' - \dots) dt, \dots (18)$$

then

$$\delta A = 0. \dots (19)$$

provided the varied motion takes place with the same constant value of the energy, and with the same constant cyclic momenta, between the same two configurations, these being regarded as defined by the palpable co-ordinates alone.

§ 8. Hamilton's Principal and Characteristic Functions.

In the investigations next to be described a more extended meaning is given to the symbol δ . We will, in the first instance, denote by it an infinitesimal variation of the most general kind, affecting not merely the values of the co-ordinates at any instant, but also the initial and final configurations and the times of passing through them. If we put

$$S = \int_i^f (T-V) dt, \dots (20)$$

we have, then,

$$\begin{aligned} \delta S &= (T'-V')\delta t' - (T-V)\delta t + \int_i^f (\delta T - \delta V) dt \\ &= (T'-V')\delta t' - (T-V)\delta t + [Zm(\delta x + \delta y + \delta z)]_i^f. (21) \end{aligned}$$

Let us now denote by $x', y', z', x'', y'', z'', \dots$ the final co-ordinates (i.e. at time $t' + \delta t'$) of a particle m . In the terms in (21) which relate to the upper limit we must therefore write $\delta x' - \delta x''$, $\delta y' - \delta y''$, $\delta z' - \delta z''$ for $\delta x, \delta y, \delta z$. With a similar modification at the lower limit, we obtain

$$\begin{aligned} \delta S &= -H\delta t + Zm(\delta x' + \delta y' + \delta z') \\ &\quad - Zm(\delta x'' + \delta y'' + \delta z''), \dots (22) \end{aligned}$$

where $H = (T+V)$ is the constant value of the energy in the free motion of the system, and $\tau = (t' - t)$ is the time of transit. In generalized co-ordinates this takes the form

$$\begin{aligned} \delta S &= -H\delta \tau + \rho'_1 \delta q'_1 + \rho'_2 \delta q'_2 + \dots \\ &\quad - \rho_1 \delta q_1 - \rho_2 \delta q_2 - \dots \dots (23) \end{aligned}$$

Now if we select any two arbitrary configurations as initial and final, it is evident that we can in general (by suitable initial velocities or impulses) start the system so that it will of itself pass from the first to the second in any prescribed time τ . On this view of the matter, S will be a function of the initial and final co-ordinates (q_1, q_2, \dots and q'_1, q'_2, \dots) and the time τ , as independent variables. And we obtain at once from (23)

$$\left. \begin{aligned} \rho'_1 &= \frac{\delta S}{\delta q'_1}, \rho'_2 = \frac{\delta S}{\delta q'_2}, \dots \\ \rho_1 &= -\frac{\delta S}{\delta q_1}, \rho_2 = -\frac{\delta S}{\delta q_2}, \dots \end{aligned} \right\} \dots (24)$$

and

$$H = -\frac{\delta S}{\delta \tau} \dots (25)$$

S is called by Hamilton the *principal function*; if its general form for any system can be found, the preceding equations suffice to determine the motion resulting from any given conditions. If we substitute the values of ρ_1, ρ_2, \dots and H from (24) and (25) in the expression for the kinetic energy in the form T' (see § 1), the equation $T' + V = H \dots (26)$

becomes a partial differential equation to be satisfied by S . It has been shown by Jacobi that the dynamical problem resolves itself into obtaining a "complete" solution of this equation, involving $n+1$ arbitrary constants. This aspect of the subject, as a problem in partial differential equations, has received great attention at the hands of mathematicians, but must be passed over here. There is a similar theory for the function

$$A = 2 \int T dt = S + H\tau. \dots (27)$$

It follows from (24) that

$$\begin{aligned} \delta A &= \delta S + \rho'_1 \delta q'_1 + \rho'_2 \delta q'_2 + \dots \\ &\quad - \rho_1 \delta q_1 - \rho_2 \delta q_2 - \dots \dots (28) \end{aligned}$$

This formula (it may be remarked) contains the principle of "least

Characteristic
Action

action" as a particular case. Selecting, as before, any two arbitrary configurations, it is in general possible to start the system from one of these, with a prescribed value of the total energy H , so that it shall pass through the other. Hence, regarding A as a function of the initial and final co-ordinates and the energy, we find

$$\left. \begin{aligned} \rho'_1 &= \frac{\partial A}{\partial q'_1}, \rho'_2 = \frac{\partial A}{\partial q'_2}, \dots \\ \rho_1 &= -\frac{\partial A}{\partial q_1}, \rho_2 = -\frac{\partial A}{\partial q_2}, \dots \end{aligned} \right\} \dots \dots (10)$$

and
$$\tau = \frac{\partial A}{\partial H} \dots \dots \dots (11)$$

A is called by Hamilton the *characteristic function*; it represents, of course, the "action" of the system in the free motion (with prescribed energy) between the two configurations. Like S , it satisfies a partial differential equation, obtained by substitution from (10) in (7).

The preceding theorems are easily adapted to the case of cyclic systems. We have only to write

$$S = \int_i^f (R - V) dt = \int_i^f (T - \kappa \dot{x} - \kappa' \dot{x}' - \dots - V) dt \dots (12)$$

in place of (1), and

$$A = \int (2T - \kappa \dot{x} - \kappa' \dot{x}' - \dots) dt \dots \dots (13)$$

in place of (8); cf. § 7 *ad fin.* It is understood, of course, that in (12) S is regarded as a function of the initial and final values of the palpable co-ordinates q_1, q_2, \dots, q_n , and of the time of transit τ , the cyclic momenta being invariable. Similarly in (13), A is regarded as a function of the initial and final values of q_1, q_2, \dots, q_n , and of the total energy H , with the cyclic momenta invariable. It will be found that the forms of (4) and (9) will be conserved, provided the variations $\delta q_1, \delta q_2, \dots$ be understood to refer to the palpable co-ordinates alone. It follows that the equations (5), (6) and (10), (11) will still hold under the new meanings of the symbols.

9. *Reciprocal Properties of Direct and Reversed Motions.*

We may employ Hamilton's principal function to prove a very remarkable formula connecting any two slightly disturbed natural motions of the system. If we use the symbols δ and Δ to denote the corresponding variations, the theorem is

$$\frac{d}{dt} Z(\delta p, \Delta q, -\Delta p, \delta q) = 0; \dots \dots (1)$$

or, integrating from t to t' ,

$$Z(\delta p, \Delta q, -\Delta p, \delta q) = Z(\delta p, \Delta q, -\Delta p, \delta q) \dots (2)$$

If for shortness we write

$$(r, s) = \frac{\partial S}{\partial q_r} \frac{\partial S}{\partial q_s}, (r, s') = \frac{\partial S}{\partial q_r} \frac{\partial S}{\partial q_{s'}} \dots \dots (3)$$

we have

$$\delta p_r = -Z_r(r, s) \delta q_s - Z_r(r, s') \delta q_{s'} \dots (4)$$

with a similar expression for Δp_r . Hence the right-hand side of (2) becomes

$$-Z_r(\Sigma(r, s) \delta q_s + \Sigma(r, s') \delta q_{s'}) \Delta q_r + Z_r(\Sigma(r, s) \Delta q_s + \Sigma(r, s') \Delta q_{s'}) \delta q_r = Z_r(\Sigma(r, s') \delta q_{s'} - \Delta q_{s'}) \dots (5)$$

The same value is obtained in like manner for the expression on the left hand of (2); hence the theorem, which, in the form (1), is due to Lagrange, and was employed by him as the basis of his method of treating the dynamical theory of *Variation of Arbitrary Constants*.

The formula (2) leads at once to some remarkable reciprocal relations which were first expressed, in their complete form, by

Helmholtz. Consider any natural motion of a conservative system between two configurations O and O' through which it passes at times t and t' respectively, and let $t' - t = \tau$. As the system is passing through O let a small impulse δp be given to it, and let the consequent alteration in the co-ordinate q , after the time τ be δq . Next consider the *reversed* motion of the system, in which it would, if undisturbed, pass from O' to O in the same time τ . Let a small impulse $\delta p'$ be applied as the system is passing through O' , and let the consequent change in the co-ordinate q' after a time τ be $\delta q'$. Helmholtz's first theorem is to the effect that

$$\delta q_r \delta p'_r = \delta q'_r \delta p_r \dots \dots (6)$$

To prove this, suppose, in (2), that all the δq vanish, and likewise all the δp with the exception of δp_r . Further, suppose all the $\Delta q'$ to vanish, and likewise all the $\Delta p'$ except $\Delta p'_r$, the formula then gives

$$\delta p_r \Delta q_r = -\Delta p'_r \delta q'_r \dots (7)$$

which is equivalent to Helmholtz's result, since we may suppose the symbol Δ to refer to the reversed motion, provided we

change the signs of the δp . In the most general motion of a top (MECHANICS, § 22), suppose that a small impulsive couple about the vertical produces after a time τ a change $\delta \theta$ in the inclination of the axis, the theorem asserts that in the reversed motion an equal impulsive couple in the plane of θ will produce after a time τ a change $\delta \theta'$ in the azimuth of the axis, which is equal to $\delta \theta$. It is understood, of course, that the couples have no components (in the generalized sense) except of the types indicated; for instance, they may consist in each case of a force applied to the top at a point of the axis, and of the accompanying reaction at the pivot. Again, in the corpuscular theory of light let O, O' be any two points on the axis of a symmetrical optical combination, and let V, V' be the corresponding velocities of light. At O let a small impulse be applied perpendicular to the axis so as to produce an angular deflection $\delta \theta$, and let δ' be the corresponding lateral deviation at O' . In like manner in the reversed motion, let a small deflection $\delta \theta'$ at O' produce a lateral deviation δ at O . The theorem (6) asserts that

$$\frac{\delta}{V \delta \theta} = \frac{\delta'}{V' \delta \theta'} \dots \dots (8)$$

or, in optical language, the "apparent distance" of O from O' is that of O' from O in the ratio of the refractive indices at O' and O respectively.

In the second reciprocal theorem of Helmholtz the configuration O is slightly varied by a change δq , in one of the co-ordinates, the momenta being all unaltered, and $\delta q'$ is the consequent variation in one of the momenta after second time τ . Similarly in the reversed motion a change $\delta p'$ produces after time τ a change of momentum δp . The theorem asserts that

$$\delta p'_r \delta q_r = \delta p_r \delta q'_r \dots \dots (9)$$

This follows at once from (2) if we imagine all the δp to vanish, and likewise all the δq save δq_r , and if (further) we imagine all the $\Delta p'$ to vanish, and all the $\Delta q'$ save $\Delta q'_r$. Reverting to the optical illustration, if F, F' be principal foci, we can infer that the convergence at F' of a parallel beam from F is to the convergence at F of a parallel beam from F' in the inverse ratio of the refractive indices at F' and F . This is equivalent to Gauss's relation between the two principal focal lengths of an optical instrument. It may be obtained otherwise as a particular case of (8).

We have by no means exhausted the inferences to be drawn from Lagrange's formula. It may be noted that (6) includes as particular cases various important reciprocal relations in optics and acoustics formulated by R. J. E. Clausius, Helmholtz, Thomson (Lord Kelvin) and Tait, and Lord Rayleigh. In applying the theorem care must be taken that in the reversed motion the reversal is complete, and extends to every velocity in the system; in particular, in a cyclic system the cyclic motions must be imagined to be reversed with the rest. Conspicuous instances of the failure of the theorem through incomplete reversal are afforded by the propagation of sound in a wind and the propagation of light in a magnetic medium.

It may be worth while to point out, however, that there is no such limitation to the use of Lagrange's formula (1). In applying it to cyclic systems, it is convenient to introduce conditions already laid down, viz. that the co-ordinates q are the palpable co-ordinates and that the cyclic momenta are invariable. Special inference can then be drawn as before, but the interpretation cannot be expressed so neatly owing to the non-reversibility of the motion.

AUTHORITIES.—The most important and most accessible early authorities are J. L. Lagrange, *Mécanique analytique* (1st ed. Paris, 1788, 2nd ed. Paris, 1811; reprinted in *Œuvres*, vols. xi., xii., Paris, 1888-89); Hamilton, "On a General Method in Dynamics," *Phil. Trans.* 1834 and 1835; C. G. J. Jacobi, *Vorlesungen über Dynamik* (Berlin, 1866, reprinted in *Werke*, Supp.-Bd., Berlin, 1884). An account of the extensive literature on the differential equations of dynamics and on the theory of variation of parameters is given by A. Cayley, "Report on Theoretical Dynamics," *Brit. Assn. Rep.* (1857), *Mathematical Papers*, vol. iii. (Cambridge, 1890). For the modern developments reference may be made to Thomson and Tait, *Natural Philosophy* (1st ed. Oxford, 1867, 2nd ed. Cambridge, 1879); Lord Rayleigh, *Theory of Sound*, vol. i. (1st ed. London, 1877, 2nd ed. London, 1894); E. J. Routh, *Stability of Motion* (London, 1877) and *Rigid Dynamics* (4th ed. London, 1884); H. Helmholtz, "Über die physikalische Bedeutung des Prinzips der kleinsten Action," *Crelle*, vol. c., 1886, reprinted (with other cognate papers) in *Wis. Abh.* vol. iii. (Leipzig, 1895); J. Larmor, "On Least Action," *Proc. Lond. Math. Soc.* vol. xv. (1884); E. T. Whittaker, *Analytical Dynamics* (Cambridge, 1904). As to the question of stability, reference may be made to H. Poincaré, "Sur l'équilibre d'une masse fluide animée d'un mouvement de rotation," *Acta math.* vol. vii. (1885); F. Klein and A. Sommerfeld, *Theorie der Kreisels*, pts. 1, 2 (Leipzig, 1897-1898); A. Lioupanoff and J. Hadamard, *Louville, 5me série*, vol. iii. (1897); T. J. I. Bromwich, *Proc. Lond. Math. Soc.* vol. xxxiii. (1901). A remarkable interpretation of various dynamical principles is given by H. Hertz in his posthumous work *Die Prinzipien der Mechanik* (Leipzig, 1894), of which an English translation appeared in 1900. (H. Lb.)

DYNAMITE (Gr. *dynamis*, power), the name given to several explosive preparations containing nitroglycerin (*g.s.*) which are almost exclusively used for blasting purposes. The first practical application of nitroglycerin in this way was made by A. Nobel in 1863. He soaked gunpowder with the liquid and fired the gunpowder by an ordinary fuse. Later he found that nitroglycerin could be detonated by the explosion of several materials such as fulminate of mercury, the use of which as a detonator he patented in 1867. In 1866-1867 he experimented with charcoal and other substances, and found the infusorial earth known as kieselguhr, which consists mainly of silica (nearly 95%), eminently adapted to the purpose, as it was inert, non-combustible, and after a little heating and preparation very porous, retaining a large amount of nitroglycerin as water is held in a sponge, without very serious exudation on standing. This kieselguhr dynamite is generally made by incorporating three parts of nitroglycerin with one part of the dry earth, the paste being then formed into cylindrical cartridges. This work is done by hand. Generally a small percentage of the kieselguhr is replaced by a mixture containing sodium and ammonium carbonates, talc and ochre. This product is known as dynamite No. 1. Disabilities attaching to kieselguhr dynamite are that when placed in water the nitroglycerin is liable to be exuded or displaced, also that, like nitroglycerin itself, it freezes fairly easily and thawing the frozen cartridges is a dangerous operation. Other substances, e.g. kaolin, tripoli, magnesia alba (magnesium carbonate), alumina, sugar, charcoal, some powdered salts and mixtures of sawdust and salts, have been shown to be absorbents more or less adapted to the purpose of making a dynamite. Charcoal from cork is said to absorb about 90% of its weight of nitroglycerin. With the idea of obtaining greater safety, mixtures have been made of nitroglycerin with wood fibre, charcoal and metallic nitrates. Lithofracteur, for instance, consists of 50% nitroglycerin and a mixture of prepared sawdust, kieselguhr and barium nitrate. Carbonite contains 25% of nitroglycerin, the remainder being a mixture of wood-meal and alkali nitrates, with about 1% of sulphur. Dualin, atlas dynamite and pentolite are other modifications.

A convenient form in which nitroglycerin can be made up for blasting purposes, especially in wet ground, is the gelatinous material obtained by the action of nitroglycerin, either alone or with the help of solvents, on low-grade or soluble gun-cottons. It is known as blasting gelatin, and was first made by Nobel by incorporating 6 or 7% of low nitrated cellulose (collodion cotton or soluble gun-cotton) with slightly warmed nitroglycerin. The result is a transparent plastic material, of specific gravity 1.5 to 1.6, which may be kept under water for a long time without appreciable change. It is less sensitive to detonation than ordinary dynamite, and although its explosion is slightly slower it is more powerful than dynamite and much superior to the liquid nitroglycerin. Blasting gelatin also freezes and is sensitive to percussion in this state. Camphor and other substances have been added to blasting gelatin to render it more solid and less sensitive. Some modifications of blasting gelatin, e.g. gelnite, contain wood-meal and such oxygen-containing salts as potassium nitrate. Experience has conclusively shown that dynamites are more satisfactory, quicker, and more intense in action than liquid nitroglycerin.

To prevent nitroglycerin and some of the forms of dynamite from freezing it has been proposed to add to them small quantities of either mono-chlor-dinitroglycerin or of a nitrated poly-glycerin. The former is obtained by first acting upon glycerin with hydrogen chloride to produce *m*-chlorhydrin or chlor-propylene glycol, $C_2H_3O_2Cl$, which is then nitrated as in the case of glycerin. The latter is obtained by heating glycerin for six or seven hours to about 300° C., whereby water is split off in such manner that a diglycerin $C_2H_3O_2$, for the most part, results. This on nitration in the usual manner gives a product $C_2H_3N_2O_8$, which burns and explodes in a similar manner to ordinary nitroglycerin, but is less sensitive and does not so easily freeze. The mono- and di-nitrates of glycerin have also been proposed as additions to ordinary nitroglycerin (*g.s.*) for the same purpose. (W. R. E. H.)

DYNAMO (a shortened form of "dynamo-electric machine," from Gr. *dynamis*, power), a machine for converting mechanical into electrical energy.

The dynamo ranks with the telegraph and telephone as one of the three striking applications of electrical and magnetic science to which the material progress that marked the second half of the 19th century was in no small measure due. Since the discovery of the principle of the dynamo by Faraday in 1831 the simple model which he first constructed has been gradually developed into the machines of 5000 horse-power or more which are now built to meet the needs of large cities for electric lighting and power, while at the same time the numbers of dynamos in use have increased almost beyond estimate. Yet such was the insight of Faraday into the fundamental nature of the dynamo that the theory of its action which he laid down has remained essentially unchanged. His experiments on the current which was set up in a coil of wire during its movement across the poles of a magnet led naturally to the explanation of induced electromotive force as caused by the linking or unlinking of magnetic lines of flux with an electric circuit. For the more definite case of the dynamo, however, we may, with Faraday, make the transition from line-linkage to the equivalent conception of "line-cutting" as the source of E.M.F.—in other words, to the idea of electric conductors "cutting" or intersecting the lines of flux in virtue of relative motion of the magnetic field and electric circuit. On the 28th of October 1831 Faraday mounted a copper disk so that it could be rotated edgewise between the poles of a permanent horse-shoe magnet. When so rotated, it cut the lines of flux which passed transversely through its lower half, and by means of two rubbing contacts, one on its periphery and the other on its spindle, the circuit was closed through a galvanometer, which indicated the passage of a continuous current so long as the disk was rotated (fig. 1). Thus by the invention of the first dynamo Faraday proved his idea that the E.M.F. induced through the interaction of a magnetic field and an electric circuit was due to the passage of a portion of the electric circuit across the lines of flux, or vice versa, and so could be maintained if the cutting of the lines were made continuous.¹ In comparison with Faraday's results, the subsequent advance is to be regarded as a progressive perfecting of the mechanical and electro-magnetic design, partly from the theoretical and partly from the practical side, rather than as modifying or adding to the idea which was originally present in his mind, and of which he already saw the possibilities.

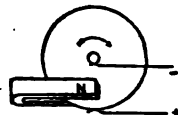

FIG. 1.

A dynamo, then, is a machine in which, by means of continuous relative motion, an electrical conductor or system of conductors forming part of a circuit is caused to cut the lines of a magnetic field or fields; the cutting of the magnetic flux induces an electromotive force in the conductors, and when the circuit is closed a current flows, whereby mechanical energy is converted into electrical energy.

Little practical use could be made of electrical energy so long as its only known sources were frictional machines and voltaic batteries. The cost of the materials for producing electrical currents on a large scale by chemical action was prohibitive, while the frictional machine only yielded very small currents at extremely high potentials. In the dynamo, on the other hand, electrical energy in a convenient form could be cheaply and easily obtained by mechanical means, and with its invention the application of electricity to a wide range of commercial purposes became economically possible. As a converter of energy from one form to another it is only surpassed in efficiency by another electrical appliance, namely, the transformer (see TRANSFORMERS). In this there is merely conversion of electrical energy at a high potential into electrical energy at a low potential, or vice versa, but in the dynamo the mechanical energy which must be applied to maintain the relative movement of magnetic field and conductor is absorbed, and reappears in an electrical form. A true transformation takes place, and the proportion which the rate of

¹ Experimental Researches in Electricity, series ii. § 6, para. 236, 259-260, and series xxviii. § 34.

² Ibid. series i. § 4, para. 84-90.

delivery of electrical energy bears to the power absorbed, or in other words the *efficiency*, is the more remarkable. The useful return or "output" at the terminals of a large machine may amount to as much as 95% of the mechanical energy which forms the "input." Since it needs some prime mover to drive it, the dynamo has not made any direct addition to our sources of energy, and does not therefore rank with the primary battery or oil-engine, or even the steam-engine, all of which draw their energy more immediately from nature. Yet by the aid of the dynamo the power to be derived from waterfalls can be economically and conveniently converted into an electrical form and brought to the neighbouring factory or distant town, to be there reconverted by motors into mechanical power. Over any but very short distances energy is most easily transmitted when it is in an electrical form, and turbine-driven dynamos are very largely and successfully employed for such transmission. Thus by conducting to the utilisation of water-power which may previously have had but little value owing to its disadvantageous situation, the dynamo may almost be said to have added another to our available natural resources.

The two essential parts of the dynamo, as required by its definition, may be illustrated by the original disk machine of Faraday. They are (1) the *iron magnet*, between the poles of which a magnetic field exists, and (2) the *electrical conductors*, represented by the rotating copper disk. The sector of the disk cutting the lines of the field forms part of a closed electric circuit, and has an E.M.F. induced in it, by reason of which it is no longer simply a conductor, but has become "active." In its more highly developed form the simple copper disk is elaborated into a system of many active wires or bars which form the "winding," and which are so interconnected as to add up their several E.M.F.'s. Since these active wires are usually mounted on an iron structure, which may be likened to the keeper or "armature" of a magnet rotating between its poles, the term "armature" has been extended to cover not only the iron core, but also the wires on it, and when there is no iron core it is even applied to the copper conductors themselves. In the dynamo of Faraday the "armature" was the rotating portion, and such is the case with modern continuous-current dynamos; in alternators, however, the magnet, or a portion of it, is more commonly rotated while the armature is stationary. It is in fact immaterial to the action whether the one or the other is moved, or both, so long as their relative motion causes the armature conductors to cut the magnetic flux. As to the ultimate reason why an E.M.F. should be thereby induced, physical science cannot as yet yield any surer knowledge than in the days of Faraday.¹ For the engineer, it suffices to know that the E.M.F. of the dynamo is due to the cutting of the magnetic flux by the active wires, and, further, is proportional to the rate at which the lines are cut.²

The equation of the *electromotive force* which is required in order to render this statement quantitative must contain three factors, namely, the density of the flux in the air-gap through which the armature conductors move, the active length of these wires, and the speed of their movement. For given values of the first and third factors and a single straight wire moved parallel to itself through a uniform field, the maximum rate of cutting is evidently obtained when the three directions of the lines

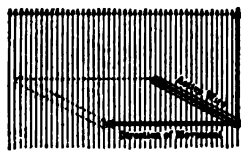

FIG. 2.

of the conductor's length and of the relative motion are respectively at right angles to each other, as shown by the three co-ordinate axes of fig. 2. The E.M.F. of the single wire is then

$$E = B_p LV \times 10^{-8} \text{ volts} \dots (1)$$

where B_p is the density of the flux within the air-gap expressed in C.G.S. lines per

square centimetre, L is the active length of the conductor within the field in centimetres, and V is the velocity of movement in centimetres per second. Further, the direction in which the E.M.F. has the above maximum value is along the length of the conductor, its "sense" being determined by

the direction of the movement³ in relation to the direction of the field.

The second fundamental equation of the dynamo brings to light its mechanical side, and rests on H. C. Oersted's discovery of the interaction of a magnetic field and an electric current. If a straight electric conductor through which a current is passing be so placed in a magnetic field that its length is not parallel to the direction of the lines of flux, it is acted on by a force which will move it, if free, in a definite direction relatively to the magnet; or if the conductor is fixed and the magnet is free, the latter will itself move in the opposite direction. Now in the dynamo the active wires are placed so that their length is at right angles to the field; hence when they are rotated and an electric current begins to flow under the E.M.F. which they induce, a mutual force at once arises between the copper conductors and the magnet, and the direction of this force must by Lenz's law be opposed to the direction of the movement. Thus as soon as the disk of fig. 1 is rotated and its circuit is closed, it experiences a mechanical pull or drag which must be overcome by the force applied to turn the disk. While the magnet must be firmly held so as to remain stationary, the armature must be of such mechanical construction that its wires can be forcibly driven through the magnetic field against the mutual pull. This law of electrodynamic action may be quantitatively stated in an *equation of mechanical force*, analogous to the equation (1) of electromotive force, which states the law of electromagnetic induction. If a conductor of length L cm., carrying a current C amperes, is immersed in a field of uniform density B_p , and the length of the conductor is at right angles to the direction of the lines, it is acted on by a force

$$F = B_p LC \times 10^{-4} \text{ dynes,} \dots (2)$$

and the direction of this force is at right angles to the conductor and to the field. The rate at which electrical energy is developed, when this force is overcome by moving the conductor as a dynamo through the field, is $EC = B_p LVC \times 10^{-4}$ watts, whence the equality of the mechanical power absorbed and the electrical power developed (as required by the law of the conservation of energy) is easily established. The whole of this power is not, however, available at the terminals of the machine; if R_a be the resistance of the armature in ohms, the passage of the current C_a through the armature conductors causes a drop of pressure of $C_a R_a$ volts, and a corresponding loss of energy in the armature at the rate of $C_a^2 R_a$ watts. As the resistance of the external circuit R_e is lowered, the current $C = E_a / (R_e + R_a)$ is increased. The increase of the current is, however, accompanied by a progressive increase in the loss of energy over the armature, and as this is expended in heating the armature conductors, their temperature may rise so much as to destroy the insulating materials with which they are covered. Hence the temperature which the machine may be permitted to attain in its working is of great importance in determining its output, the current which forms one factor therein being primarily limited by the heating which it produces in the armature winding. The lower the resistance of the armature, the less the rise of its temperature for a given current flowing through it; and the reason for the almost universal adoption of copper as the material for the armature conductors is now seen to lie in its high conductivity.⁴

Since the voltage of the dynamo is the second factor to which its output is proportional, the conditions which render the induced E.M.F. a maximum must evidently be reproduced as far as possible in practice, if the best use is to be made of a given mass of iron and copper. The first problem, therefore, in the construction of the dynamo is the disposition of the wires and field in such a manner that the three directions of field, length of active conductors, and movement are at right angles to one another, and so that the relative motion is continuous. Reciprocating motion, such as would be obtained by direct attachment of the conductors to the piston of a steam-engine, has

¹ *Id.*, *ib.* series i. § 4, para. 114-119.

² *Id.*, *ib.* series ii. § 6, para. 211, 213; series xxviii. § 34, para. 3152.

³ "On the Physical Lines of Magnetic Force," *Phil. Mag.*, June 1852.

⁴ Faraday, *Exp. Res.* series xxviii. § 34, para. 3104, 3114-3115.

been successfully employed only in the special case of an "oscillator,"¹ producing a small current very rapidly changing in direction. Rotary motion is therefore universally adopted, and with this two distinct cases arise. Either (A) the active length of the wire is parallel to the axis of rotation, or (B) it is at right angles to it.

(A) If a conductor is rotated in the gap between the poles of a horse-shoe magnet, and these poles have plane parallel faces opposing one another as in fig. 3, not only is the density of the flux in the interpolar gap small, but the direction of movement is not always at right angles to the direction of the lines, which for the most part pass straight across from one opposing face to the other. When the conductor is midway between the poles (*i.e.* either at its highest or lowest point), it is at this instant sliding along the lines and does not cut them, so that its E.M.F. is zero. Taking this position as the starting-point, as the conductor moves round, its rate of line-cutting increases to a maximum when it has moved through a right angle and is opposite to the centre of a pole-face (as in fig. 3), from which point onward the rate decreases to zero when it has moved

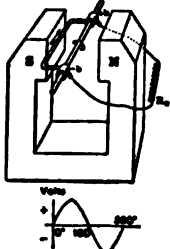

Fig. 3.

through 180°. Each time the conductor crosses a line drawn symmetrically through the gap between the poles and at right angles to the axis of rotation, the E.M.F. along its length is reversed in direction, since the motion relatively to the direction of the field is reversed. If the ends of the active conductor are electrically connected to two collecting rings fixed upon, but insulated from, the shaft, two stationary brushes *bb* can be pressed on the rings so as to make a sliding contact. An external circuit can then be connected to the brushes, which will form the "terminals" of the machine, the periodically reversed or alternating E.M.F. induced in the active conductor will cause an alternating current to flow through conductor and external circuit, and the simplest form of "alternator" is obtained. If the field cut by the straight conductor is of uniform density, and all the lines pass straight across from one pole-face to the other (both of which assumptions are approximately correct), a curve connecting the instantaneous values of the E.M.F. as ordinates with time or degrees of angular movement as abscissae (as shown at the foot of fig. 3), will, if the speed of rotation be uniform, be a sine curve. If, however, the conductor is mounted on an iron

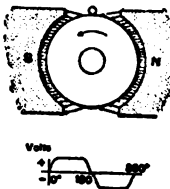

Fig. 4.

as shown in fig. 4—flat-topped, with rounded corners rapidly sloping down to the zero line.

But a single wire cannot thus be made to give more than a few volts, and while dynamos for voltages from 5 to 10 are required for certain purposes, the voltages in common use range from

¹ Invented by Nikola Tesla (*Elec. Eng.* vol. xiii. p. 83. Cf. Brit. Pat. Spec. Nos. 2801 and 2812, 1894). Several early inventors, *e.g.* Salvatore dal Negro in 1832 (*Phil. Mag.* third series, vol. i. p. 45), adopted reciprocating or oscillatory motion, and this was again tried by Edison in 1878.

² The advantage to be obtained by making the poles closely embrace the armature core was first realized by Dr Werner von Siemens in his "shuttle-wound" armature (Brit. Pat. No. 3107, 1856).

100 to 10,000. It is therefore necessary to connect a number of such wires in series, so as to form an "armature winding." If several similar conductors are arranged along the length of the iron core parallel to the first (fig. 5), the E.M.F.'s generated in the conductors which at any moment are under the same pole are similarly directed, and are opposite to the directions of the E.M.F.'s in the conductors under the other pole (cf. fig. 5 where the dotted and crossed ends of the wires indicate E.M.F.'s directed respectively towards and away from the observer). Two distinct

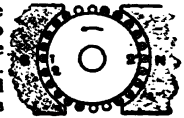

Fig. 5.

methods of winding thence arise, the similarity of the E.M.F.'s under the same pole being taken advantage of in the first, and the opposite E.M.F.'s under N and S poles in the second.

1. The first, or *ring-winding*, was invented by Dr Antonio Pacinotti of Florence³ in 1860, and was subsequently and independently reintroduced in 1870⁴ by the Belgian electrician, Zénobe Théophile Gramme, whence it is also frequently called the "Gramme" winding. By this method the farther end of conductor 1 (fig. 5) is joined in series to the near end of conductor 2; this latter lies next to it on the surface of the core or immediately above it, so that both are simultaneously under the same pole-piece. For this series connexion to be possible, the armature core must be a hollow cylinder, supported from the shaft on an open non-magnetic spider or hub, between the arms of which there is room for the internal wire completing the loop (fig. 6). The end of one complete loop or turn embracing one side of the armature core thus forms the starting-point for another loop, and the process can be continued if required to form a coil of two or more turns. In the ring armature the iron core serves the double purpose of conducting the lines across from one pole to the

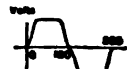
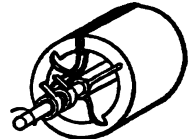

Fig. 6.

other, and also of shielding from the magnetic flux the hollow interior through which the connecting wires pass. Any lines which leak across the central space are cut by the internal wires, and the direction of cutting is such that the E.M.F. caused thereby opposes the E.M.F. due to the active conductors proper on the external surface. If, however, the section of iron in the core be correctly proportioned, the number of lines which cross the interior will bear but a small ratio to those which pass entirely through the iron, and the counter E.M.F. of the internal wires will become very small; they may then be regarded simply as connectors for joining the external active wires in series.

2. The second or *drum* method was used in the original "shuttle-wound" armatures invented by Dr Werner von Siemens in 1856, and is sometimes called the "Siemens" winding. The farther end of conductor 1 (fig. 5) is joined by a connecting wire to the farther end of another conductor 2' situated nearly diametrically opposite on the other side of the core and under the opposite pole-piece. The near end of the complete loop or turn is then brought across the end of the core, and can be used as the starting-point for another loop beginning with conductor 2, which

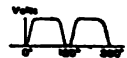
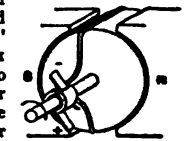

Fig. 7.

is situated by the side of the first conductor. The iron core may now be solid from the surface to the shaft, since no connecting wires are brought through the centre, and each loop embraces the entire armature core (fig. 7). By the formation of two loops in the ring armature and of the single loop in the drum armature, two active wires are placed in series;

³ *Nuovo Cimento* (1865), 19, 378.

⁴ Brit. Pat. No. 1668 (1870); *Comptes rendus* (1871), 73, 175.

the curves of instantaneous E.M.F. are therefore similar in shape to that of the single wire (fig. 4), but with their ordinates raised throughout to double their former height, as shown at the foot of fig. 6.

Next, if the free ends of either the ring or drum loops, instead of being connected to two collecting rings, are attached to the two halves of a split-ring insulated from the shaft (as shown in fig. 7 in connexion with a drum armature), and the stationary brushes are so set relatively to the loops that they pass over from the one half of the split-ring to the other half at the moment when the loops are passing the centre of the interpolar gap, and so are giving little or no E.M.F., each brush will always remain either positive or negative. The current in the external circuit attached to the brushes will then have a constant direction, although the E.M.F. in the active wires still remains alternating; the curve of E.M.F. obtained at the brushes is thus (as in fig. 7) entirely above the zero line. The first dynamo of H. Pixii,¹ which immediately followed Faraday's discovery, gave an alternating current, but in 1832² the alternator was converted into a machine giving a *unidirectional current* by the substitution of a rudimentary "commutator" in place of mercury collecting cups.

(B) So far the length of the active wires has been parallel to the axis of rotation, but they may equally well be arranged perpendicularly thereto. The poles will then have plane faces and the active wires will be disposed with their length approximately radial to the axis of the shaft. In order to add their E.M.F.'s in series, two types of winding may be employed, which are precisely analogous in principle to the ring and drum windings under arrangement (A).

3. The *discoidal* or flat-ring armature is equivalent to a ring of which the radial depth greatly exceeds the length, with the poles presented to one side of the ring instead of embracing its cylindrical surface. A similar set of poles is also presented to the opposite side of the ring, like poles being opposite to one another, so that in effect each polar surface is divided into two halves, and the groups of lines from each side bifurcate and pass circumferentially through the armature core to issue into the adjacent poles of opposite sign.

4. In the *disk* machine, no iron core is necessary for the armature, the two opposite poles of unlike sign being brought close together, leaving but a short path for the lines in the air-gap through which the active wires are rotated.

If the above elementary dynamos are compared with fig. 1, it will be found that they all possess a distinctive feature which is not present in the original disk machine of Faraday. In the four types of machine above described each active wire in each revolution first cuts the group of lines forming a field in one direction, and then cuts the same lines again in the opposite direction relatively to the sense of the lines, so that along the length of the wire the E.M.F. alternates in direction. But in the dynamo of fig. 1 the sector of the copper disk which is at any moment moving through the magnetic field and which forms the single active element is always cutting the lines in the same manner, so that the E.M.F. generated along its radial length is continuous and unchanged in direction. This radical distinction differentiates the two classes of *heteropolar* and *homopolar* dynamos, Faraday's disk machine of fig. 1 being the type of the latter class. In it the active element may be arranged either

parallel or at right angles to the axis of rotation; but in both cases, in order to increase the E.M.F. by placing two or more elements in series, it becomes necessary either (1) to employ some form of sliding contact by which the current may be collected from the end of one active element and passed round a connecting wire into the next element without again cutting the field in the reverse direction, or (2) to form on the armature a loop of which each side is alternately active and inactive. The first method limits the possibilities of the homopolar machine so greatly when large currents and high voltages are required that it is now only used in rare instances, as e.g. occasionally in dynamos driven by steam-turbines which have a very high speed of rotation. The second alternative may be carried into effect with any of the four methods of armature winding, but is practically confined to the drum and disk types. In its drum form the field is divided into two or more projecting poles, all of the same sign, with intervening neutral spaces of equal width, and the span of the loop in the direction of rotation is at least equal to the width of a polar projection, as in fig. 8, where two polar projections are shown. Each side of the loop then plays a dual part; it first cuts the lines of one polar projection and generates an E.M.F., and next becomes an inactive connecting wire, while the action is taken up by the opposite side of the loop which has previously served as a connector but now cuts the lines of the next polar projection. The E.M.F. is thus always in the same direction along the side which is at any moment active, but alternates round the loop as a whole, and the distinctive peculiarity of the homopolar machine, so soon as any form of "winding" is introduced into its armature, is lost. It results that the homopolar principle, which would prima facie appear specially suitable for the generation of a unidirectional E.M.F. and continuous current, can seldom be used for this

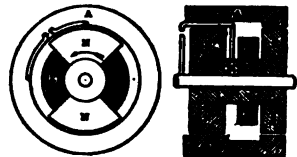

FIG. 8.

purpose and is practically confined to alternators. It may therefore be said that in almost all dynamos, whether they supply an alternating or a continuous current in the external circuit, the E.M.F. and current in the armature are alternating.

Ring winding was largely employed in early continuous-current dynamos and also in the alternators of Gramme and H. Wilde, and later of Auguste de Méritens. Disk winding was also successfully introduced for alternators, as in the magneto-machines of Nollet (1849) and the alternators of Wilde (1866) and Siemens (1878), and its use was continued in the machines of W. M. Mordey and S. Z. Ferranti. But although the ring, discoidal-ring and disk methods of winding deserve mention from their historical importance, experience has shown that drum winding possesses a marked superiority for both electrical and manufacturing reasons; the three former methods have in fact been practically discarded in its favour, so that the drum method will hereafter alone be considered.

The drum coil, composed of several loops wound side by side, may therefore be regarded as the constituent active element out of which the armature winding of the modern dynamo is developed. Its application to the multipolar machine is easily followed from fig. 9, which illustrates the heteropolar type of dynamo. The span of the loops, which is nearly 180° or across the diameter of the two-pole machine, is reduced approximately to 90° in the four-pole or to 60° in the six-pole machine and so on, the curvature of the coil becoming gradually less as the number of poles is increased. The passage of a coil through two magnetic fields of opposite direction yields a complete wave of E.M.F., such as is shown in fig. 6, and the time in seconds taken to pass through such a complete cycle is the "period" of the alternating E.M.F. The number of complete periods through which the E.M.F. of the coil passes per second is called the "periodicity" or "frequency" of the machine. In the bipolar machine this

¹ *Ann. Chim. Phys.* 1. 322

² *Ibid.* li. 76. Since in H. Pixii's machine the armature was stationary, while both magnet and commutator rotated, four brushes were used, and the arrangement was not so simple as the split-ring described above, although the result was the same. J. Saxton's machine (1833) and E. M. Clarke's machine (1835, see Sturgeon's *Annals of Electricity*, i. 145) were similar to one another in that a unidirectional current was obtained by utilizing every alternate half-wave of E.M.F., but the former still employed mercury collecting cups, while the latter employed metal brushes. W. Sturgeon in 1835 followed Pixii in utilizing the entire wave of E.M.F., and abandoned the mercury cups in favour of metal brushes pressing on four semicircular disks (*Scientific Researches*, p. 252). The simple split-ring is described by Sir C. Wheatstone and Sir W. F. Cooke in their Patent No. 8345 (1840).

is equal to the number of revolutions per second, and in the multipolar machine it is equal to the number of pairs of fields through which the coil passes in one second; hence in general the periodicity is $pN/60$, where N = the number of revolutions per minute and p = the number of pairs of poles, and this holds true of the E.M.F. and current round the coil, even though the

small currents circulating through the interior of the separate laminations. Each thin iron plate is either coated with an insulating varnish or has one of its sides covered with a sheet of very thin paper; the thickness of the laminae is usually about one-fortieth of an inch, and if this is not exceeded the rate at which energy is dissipated by eddy-currents in the core is so far reduced that it does not seriously impair the efficiency of the machine.

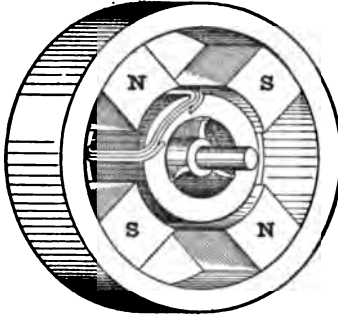

I. Smooth.

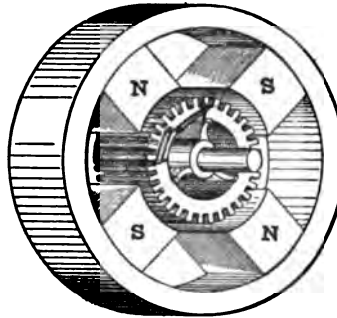

II. Toothed.

FIG. 9.

E.M.F. and current furnished to the external circuit may be rendered unidirectional or continuous. The only difference on this point is that in the continuous-current machine the poles are usually fewer than in the alternator, and the periodicity is correspondingly lower. Thus in the former case the number of poles ranges from 2 to 12 and the usual frequencies from 5 to 20; but with alternators the frequencies in commercial use range from 25 to 120, and in large machines driven by slow-speed engines the number of poles may even be as high as 60.

The drum coil may be applied either to the external surface of a rotating armature, the field-magnet being external and stationary (fig. 9), or to the internal surface of a stationary armature (fig. 10), the field-magnet being internal and rotating. While the former combination is universally adopted in the continuous-current dynamo, the latter is more usual in

that it may be said to have superseded the smooth-surface armature.

Not only does the toothed armature reduce the length of the air-gap to the minimum permitted by mechanical and magnetic considerations, and furnish better mechanical protection to the armature coils, but it also ensures the positive holding of the active wires against the mechanical drag which they experience as they pass through the magnetic field. Further, the active wires in the toothed armature are relieved of a large proportion of this mechanical drag, which is transferred to the iron teeth. The lines of the field, after passing through the air-gap proper, divide between the teeth and the slots in proportion to their relative permeances. Hence at any moment the active wires are situated in a weak field, and for a given armature current the force on them is only proportional to this weak field. This important result is connected with the fact that when the armature is giving current the distribution of the lines over the face of each tooth is distorted, so that they become denser on the "trailing" side than on the "leading" side;¹ the effect of the non-uniform distribution acting on all the teeth is to produce a magnetic drag on the armature core proportional to the current passing through the wires, so that the total resisting force remains the same as if the armature had a smooth core. The amount by which the stress on the active wires is reduced entirely depends upon the degree to which the teeth are saturated, but, since the relative permeability of iron even at a flux density of 20,000 lines per sq. cm. is to that of air approximately as 33:1, the embedded wires are very largely relieved of the driving stress. An additional gain is that solid bars of much greater width can be used in the toothed armature than on a smooth core without appreciable loss from eddy-currents within their mass.

A disadvantage of the slotted core is, however, that it usually necessitates the lamination of the pole-pieces. If the top of the slot is open, and its width of opening is considerably greater than the length of the air-gap from the iron of the pole-face to the surface of the teeth, the lines become unequally distributed not only at the surface of the teeth, but also at the face of the pole-pieces; and this massing of the lines into bands causes the density at the pole-face to be rhythmically varied as the teeth pass under it. No such variation can take place in a solid mass of metal without the production of eddy-currents within it; hence if the width of the slot-opening is equal to or exceeds twice the length of the single air-gap, lamination of the pole-pieces in the same plane as that of the armature core becomes advisable.

If the wires are threaded through holes or tunnels pierced close to the periphery of the core, the same advantages are gained as with open slots, and lamination of the pole-pieces is rendered unnecessary. But on the other hand, the process of winding becomes laborious and expensive, while the increase in the inductance of

the modern alternator. In either case the iron armature core must be "laminated"; the passage of the lines of the field across its surface sets up E.M.F.'s which are in opposite directions under poles of opposite sign, so that if the core were a solid mass a current-sheet would flow along its surface opposite to a pole, and complete its circuit by passing through the deeper layers of metal or by returning in a sheet under a pole of opposite sign. Such "eddy-currents" can be practically avoided by dividing the metal core into laminations at right angles to the length of the active wires which are themselves arranged to secure the greatest rate of line-cutting and maximum E.M.F. The production of the eddy-current E.M.F. is not thereby prevented, but the paths of the eddy-currents are so broken up that the comparatively high resistance with which they meet reduces their amount very greatly. The laminae must be lightly insulated from one another, right up to their edges, so that the E.M.F.'s which still act across their thickness will not be added up along the length of the core, but will only produce extremely

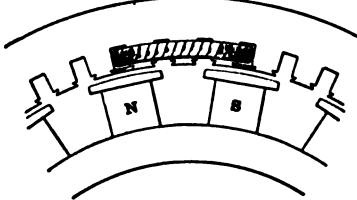

FIG. 10.

¹ By the "leading" side of the tooth or of an armature coil or sector is to be understood that side which first enters under a pole after passing through the interpolar gap, and the edge of the pole under which it enters is here termed the "leading" edge as opposed to the "trailing" edge or corner from under which a tooth or coil emerges into the gap between the poles; cf. fig. 30, where the leading and trailing pole-corners are marked *l* and *t*.

the coils owing to their being surrounded by a closed iron circuit is prejudicial to sparkless commutation in the continuous-current dynamo and to the regulation of the voltage of the alternator. A compromise is found in the half-closed slot, which is not uncommon in alternators, although the open slot is more usual in continuous-current dynamos.

With the addition of more turns to the elementary drum loop or of several complete coils, new questions arise, and in connexion therewith the two great classes of machines, viz. alternators and continuous-current dynamos, which have above been treated side by side, diverge considerably, so that they are best considered separately. The electromotive-force equation of the alternator will be first deduced, and subsequently that of the continuous-current machine.

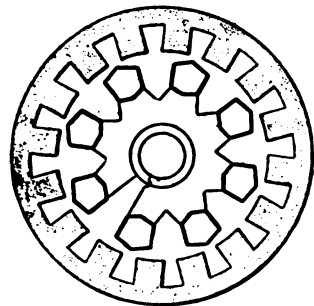

FIG. 11.

Corresponding to the number of pairs of poles in the multipolar alternator, it is evident that there may also be an equal number of coils as shown diagrammatically in fig. 11. The additional coils, being similarly situated in respect to other pairs of poles, will exactly reproduce

the E.M.F. of the original coil in phase and magnitude, so that when they are connected in series the total E.M.F. will be proportional to the number of coils in series; or if they are connected in parallel, while not adding to the E.M.F., they will proportionately increase the current-carrying capacity of the combination. But within each coil the addition of more loops will not cause an equal increase in the total E.M.F., unless the phases of the component E.M.F.'s due to the several turns are identical, and on this account it becomes necessary to consider the effect of the width of the coil-side.

If the additional loops are wound within the same slots as the original loop, the winding is "concentrated," and each turn will then add the same E.M.F. But if the coil-side is divided between two or more slots, the phase of the E.M.F. yielded by the wires in one slot being different from that of the wires in another neighbouring slot, the sum of all the E.M.F.'s will be less than

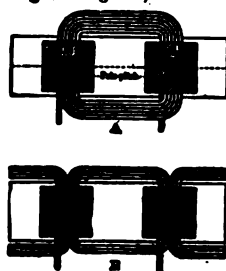

FIG. 12.

the E.M.F. of one component loop multiplied by the number of loops or turns in the coil. The percentage reduction in the E.M.F. will depend upon the number of the slots in a coil-side and their distance apart, i.e. on the virtual width of the coil-side expressed as a fraction of the "pole-pitch" or the distance measured along the pitch-line from the centre of one pole to the centre of a neighbouring pole of opposite sign (fig. 12). The winding is now to be regarded as "grouped," since a small number of distinct phases corresponding to the groups within the two, three or four slots have to be compounded together. As the number of slots per coil-side is increased, an approach is gradually made to the case of "uniform distribution," such as would obtain in a smooth-core armature in which the turns of the coil are wound closely side by side. Thus in the six-turn coil of fig. 12 A, which represents the development of a two-pole armature when the core is cut down to the shaft and opened out flat, there are in effect six phases compounded together, each of which differs but little from that of its next neighbour. With numerous wires lying still closer together a large number of phases are

compounded until the distribution becomes practically uniform; the decrease in the E.M.F., as compared with that of a single turn multiplied by the number in series, is then immediately dependent upon the width of the coil-side relatively to the pole-pitch.

If the width of the inner loop of fig. 12 A is less than that of the pole-face, its two sides will for some portion of each period be moving under the same pole, and "differential action" results, the net E.M.F. being only that due to the difference between the E.M.F.'s of the two sides. The loop of smallest width must therefore exceed the width of pole-face, if direct differential action is to be avoided. The same consideration also determines the width of the outer loop; if this be deducted from twice the pole-pitch, the difference should not be less than the width of the pole-face, so that, e.g., in a bipolar machine the outer loop may stand to the S. pole exactly as the inner loop stands to the N. pole (fig. 13). In other words, the width of the coil-side must not exceed the width of the interpolar gap between two fields. Evidently then if the ratio of the pole-width to the pole-pitch approaches unity, the width of the coil-side must be very small, and vice versa. A compromise between these conflicting considerations is found if the pole is made not much more than half the pole-pitch, and the width of the coil-side is similarly about half the pole-pitch and therefore equal in width to the pole (fig. 13). A single large coil, such as that of fig. 12 A, can, however, equally well be divided into two halves by taking the end-connexions of one half of the turns round the opposite side of the shaft (fig. 12 B), as indeed has already been done in fig. 13. Each sheaf or band of active wires corresponding to a pole is thereby unaffected, but the advantages are gained that the axial length of the end-connexions is halved, and that they have less inductance. Thus if in fig. 11 there are four turns per coil, fig. 14 is electrically equivalent to it (save that the coils are here shown divided into two parallel paths, each carrying half the total current). When the large coils are divided as above described, it results that there are as many coils as there are poles, the outer loop of the small coil having a width equal to the pole-pitch, and the inner a width equal to the pole-face.

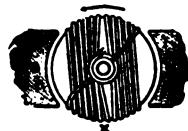

FIG. 13.

Such is the form which the "single-phase alternator" takes, but since only one-half of the armature core is now covered with winding, an entirely distinct but similar set of coils may be wound to form a second armature circuit between the coils of the first circuit. The phase of this second circuit will differ by 90° or a quarter of a period from that of the first, and it may either be used to feed an entirely separate external circuit possibly at a different pressure or, if it be composed of the same number of turns and therefore gives the same voltage, it may be interconnected with the first circuit to form a "quarter-phase alternator," as will be more fully described later. By an extension of the same process, if the width of each side of a coil is reduced to one-sixth of the pole-pitch, three armature circuits can be wound on the same core, and a "three-phase alternator," giving waves of E.M.F. differing in phase by 120°, is obtained.

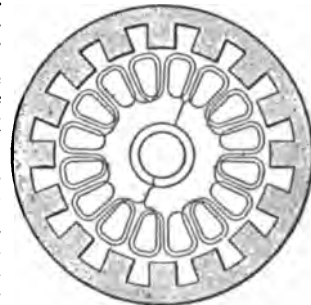

FIG. 14.

The fundamental "electromotive-force equation" of the heteropolar alternator can now be given a more definite form. Let Z_c be the number of C. G. S. lines or the total flux, which issuing from any

one pole flows through the armature core, to leave it by another pole of opposite sign. Since each active wire cuts these lines, first as they enter the armature core and then as they emerge from it to enter another pole, the total number of lines cut in one revolution by any one active wire is $2pZ_a$. The time in seconds taken by one revolution is $60/N$. The average E.M.F. induced in each active wire in one revolution being proportional to the number of lines cut divided by the time taken to cut them is therefore $2Z_a(\rho N/60) \times 10^{-8}$ volts. The active wires which are in series and form one distinct phase may be divided into as many bands as there are poles; let each such band contain t active wires, which as before explained may either form one side of a single large coil or the adjacent sides of two coils when the large coil is divided into two halves. Since the wires are joined up into loops, two bands are best considered together, which with either arrangement yield in effect a single coil of t turns. The average E.M.F.'s of all the wires in the two bands when added together will therefore be $4Z_a(\rho N/60)t \times 10^{-8}$. But unless each band is concentrated within a single slot, there must be some differential action as they cross the neutral line between the poles, so that the last expression is virtually the gross average E.M.F. of the loops on the assumption that the component E.M.F.'s always act in agreement round the coil and do not at times partially neutralize one another. The net average E.M.F. of the coil as a whole, or the arithmetical mean of all the instantaneous values of a half-wave of the actual E.M.F. curve, is therefore reduced to an extent depending upon the amount of differential action and so upon the width of the coil-side when this is not concentrated. Let k be the coefficient by which the gross average E.M.F. must be multiplied to give the net average E.M.F.; then k may be called the "width-factor," and will have some value less than unity when the wires of each band are spread over a number of slots. The net average E.M.F. of the two bands corresponding to a pair of poles is thus $e_{av} = 4k^2 Z_a(\rho N/60)t \times 10^{-8}$.

The shape of the curve of instantaneous E.M.F. of the coil must further be taken into account. The "effective" value of an alternating E.M.F. is equal to the square root of the mean square of its instantaneous values, since this is the value of the equivalent unidirectional and unvarying E.M.F., which when applied to a given resistance develops energy at the same rate as the alternating E.M.F., when the effect of the latter is averaged over one or any whole number of periods. Let k^* = the ratio of the square root of the mean square to the average E.M.F. of the coil, i.e. $k^* = \frac{\text{effective E.M.F.}}{\text{average E.M.F.}}$. Since it depends upon the shape of the E.M.F. curve, k^* is also known as the "form-factor"; thus if the length of gap between pole-face and armature core and the spacing of the wires were so graduated as to give a curve of E.M.F. varying after a sine law, the form-factor would have the particular value of $\pi/2\sqrt{2} = 1.11$, and to this condition practical alternators more or less conform. The effective E.M.F. of the two bands corresponding to a pair of poles is thus $e_{eff} = 4k^* k^2 Z_a(\rho N/60)t \times 10^{-8}$.

In any one phase there are p pairs of bands, and these may be divided into q parallel paths, where q is one or any whole number of which p is a multiple. The effective E.M.F. of a complete phase is therefore $pq e_{eff}/q$. Lastly, if m = the number of phases into which the armature winding is divided, and r = the total number of active wires on the armature counted all round its periphery, $t = r/2pm$, and the effective E.M.F. per phase is $E_a = 2k^* k^2 Z_a(\rho N r/60mq) \times 10^{-8}$.

The two factors k and k^* may be united into one coefficient, and the equation then takes its final form

$$E_a = 2k Z_a(\rho N r/60 m q) \times 10^{-8} \text{ volts} \dots \dots \dots (16)$$

In the alternator q is most commonly 1, and there is only one circuit per phase; finally the value of K or the product of the width-factor and the form-factor usually falls between the limits of 1 and 1.25.

We have next to consider the effect of the addition of more armature loops in the case of dynamos which give a unidirectional E.M.F. in virtue of their split-ring collecting device, i.e. of the type shown in fig. 7 with drum armature or its equivalent ring form. As before, if the additional loops are wound in continuation of the first as one coil connected to a single split-ring, this coil must be more or less concentrated into a narrow band; since if the width becomes nearly equal to or exceeds the width of the interpolar gap, the two edges of the coil-side will just as in the alternator act differentially against one another during part of each revolution. The drum winding with a single coil thus gives an armature of the H- or "shuttle" form invented by Dr Werner von Siemens. Although the E.M.F. of such an arrangement may have a much higher maximum value than that of the curve of fig. 7 for a single loop, yet it still periodically varies during each revolution and so gives a pulsating current, which is for most practical uses unsuitable. But such pulsation might be largely reduced if, for example, a second coil were placed at right angles to the original coil and the two were connected in series; the crests of the wave of E.M.F. of the second

coil will then coincide with the hollows of the first wave, and although the maximum of the resultant curve of E.M.F. may be no higher its fluctuations will be greatly decreased. A special displacement of the new coils along the pole-pitch, somewhat as in a polyphase machine, thus suggests itself, and the process may be carried still further by increasing the number of equally spaced coils, provided that they can be connected in series and yet can have their connexion with the external circuit reversed as they pass the neutral line between the poles.

Given two coils at right angles and with their split-rings displaced through a corresponding angle of 90° , they may be connected in series by joining one brush to the opposite brush of the second coil, the external circuit being applied to the two remaining brushes.¹ The same arrangement may again be repeated with another pair of coils in parallel with the first, and we thus obtain fig. 15 with four split-rings, their connexions to

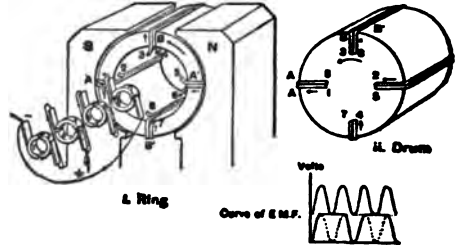

FIG. 15.

the loops being marked by corresponding numerals; the four coils will give the same E.M.F. as the two, but they will be jointly capable of carrying twice the current, owing to their division into two parallel circuits. Now in place of the four split-rings may be employed the greatly simplified four-segment structure shown in fig. 16, which serves precisely the same purpose as the four split-rings but only requires two instead of eight brushes. The effect of joining brush 2 in fig. 15 across to brush 3, brush 4 to brush 5, 5 to 6, &c., has virtually been to connect the end of coil A with the beginning of coil B, and the end of coil B with the beginning of coil A, and so on, until they form a continuous closed helix. Each sector of fig. 16 will therefore replace two halves of a pair of adjacent split-rings, if the end and beginning of a pair of adjacent coils are connected to it in a regular order of sequence. The four sectors are insulated from one another and from the shaft, and the whole structure is known as the "commutator," its function being not simply to collect the current but also to commute its direction in any coil as it passes the interpolar gap. The principle of the "closed-coil continuous-current armature" is thus reached, in which there are at least two parallel circuits from brush to brush, and from which a practically steady current can be obtained. Each coil is successively short-circuited, as a brush bridges over the insulation between the two sectors which terminate it; and the brushes must be so set that the period of short-circuit takes place when the coil is generating little or no E.M.F., i.e. when it is moving through the zone between the pole-tips. The effect of the four coils in reducing the percentage fluctuation of the E.M.F. is very marked, as shown at the foot of fig. 15 (where the upper curve is the resultant obtained by adding together the separate curves of coils A and B), and the levelling process may evidently be carried still further by the insertion of more coils and more corresponding sectors in the commutator, until the whole



FIG. 16.

¹ Such was the arrangement of Wheatstone's machine (Brit. Pat. No. 9022 of 1841, which was the first to give a more nearly "continuous" current, the number of sections and split-rings being five.

² Its development from the split-ring was due to Pacinotti and Gramme (Brit. Pat. No. 1668, 1870) in connexion with their ring armatures.

armature is covered with winding. For example, figs. 17 and 18 show a ring and a drum armature, each with eight coils and eight commutator sectors; their resultant curve, on the assumption that a single active wire gives the flat-topped curve of fig. 4,

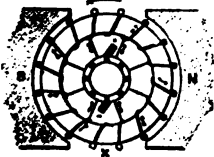

FIG. 17.

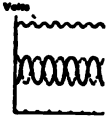
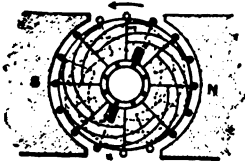

FIG. 18.

will be the upper wavy line of E.M.F. obtained by adding together two of the resultant curves of fig. 15, with a relative displacement of 45°. The amount of fluctuation for a given number of commutator sectors depends upon the shape of the curve of E.M.F. yielded by the separate small sections of the armature winding; the greater the polar arc, the less the fluctuation. In practice, with a polar arc equal to about 0.75 of the pitch, any number of sectors over 32 per pair of poles yields an E.M.F. which is sensibly constant throughout one or any number of revolutions.

The fundamental electro-motive-force equation of the continuous-current heteropolar machine is easily obtained by analogy from that of the alternator. The gross average E.W.F. from the two sides of a drum loop without reference to its direction is as before $4Z_c(\rho N/60) \times 10^{-8}$ volts. But for two reasons it is not average E.M.F.

may be less; the span of the loop may be less than the pole-pitch, so that even when the brushes are so set that the position of short-circuit falls on the line where the field changes its direction, the two sides of the loop for some little time act against each other; or, secondly, even if the span of the loop be equal to the pole-pitch, the brushes may be so set that the reversal of the direction of its induced E.M.F. does not coincide with the reversal of the current by the passage of the coil under the brushes. The net average E.M.F. of the loop is therefore proportional to the algebraic sum of the lines which it cuts in passing from one brush to another, and this is equal to the net amount of the flux which is included within the loop when situated in the position of short-circuit under a brush. The amount of this flux may be expressed as $k'Z_c$, where k' is some coefficient, less than unity if the span of the coil be less than the pole-pitch, and also varying with the position of the brushes. The net average E.M.F. of the loop is therefore

$$4k'Z_c(\rho N/60) \times 10^{-8}$$

In practice the number of sections of the armature winding is so large and their distribution round the armature periphery is so uniform, that the sum total of the instantaneous E.M.F.'s of the several sections which are in series becomes at any moment equal to the net average E.M.F. of one loop multiplied by the number which are in series. If the winding is divided into q parallel circuits, the number of loops in series is $1/2g$, so that the total E.M.F. is $E_c = 2(k'/g)Z_c(\rho N/60) \times 10^{-8}$ volts. Thus as compared with the alternator not only is there no division of the winding into separate phases, but the form-factor k'' disappears, since the effective and average E.M.F.'s are the same. Further whereas in the alternator q may = 1, in the continuous-current closed-coil armature there can never be less than two circuits in parallel from brush to brush, and if more, their number must always be a multiple of two, so that q can never be less than two and must always be an even number. Lastly, the factor k' is usually so closely equal to 1, that the simplified equation may in practice be adopted, viz.

$$E_c = (2/g)Z_c(\rho N/60) \times 10^{-8} \text{ volts} \quad (1b)$$

The fundamental equation of the electromotive force of the dynamo in its fully developed forms (1 a) (and 1 b) may be com-

pared with its previous simple statement (1.). The three variable terms still find their equivalents, but are differently expressed, the density B , being replaced by the total flux of one field Z_c , the length l of the single active wire by the total number of such wires r , and the velocity of movement V by the number of revolutions per second. Even when the speed is fixed, an endless number of changes may be rung by altering the relative values of the remaining two factors; and in successful practice these may be varied between fairly wide limits without detriment to the working or economy of the machine. While it may be said that the equation of the E.M.F. was implicitly known from Faraday's time onwards, the difficulty under which designers laboured in early days was the problem of choosing the correct relation of Z_c or r for the required output; this, again, was due chiefly to the difficulty of predetermining the total flux before the machine was constructed. The general error lay in employing too weak a field and too many turns on the armature, and credit must here be given to the American inventors, E. Weston and T. A. Edison, for their early appreciation of the superiority in practical working of the drum armature, with comparatively few active wires rotating in a strong field.

Continuous-current Dynamos.—On passing to the separate consideration of alternators and continuous-current dynamos, the chief constructive features of the latter will first be taken in greater detail. As already stated in the continuous-current dynamo the armature is usually the rotating portion, and the necessity of laminating its core has been generally described. The thin iron stampings employed to build up the core take the form of circular washers or "disks," which in small machines are strung directly on the shaft; in larger multipolar machines, in which the required radial depth of iron is small relatively to the diameter, a central cast iron hub supports the disks. Since the driving force is transmitted through the shaft to the disks, they must in the former case be securely fixed by keys sunk into the shaft; when a central hub is employed (fig. 19) it is keyed to the shaft, and its projecting arms engage in notches stamped on the inner circumference of the disks, or the latter have dovetailed projections fitting into the arms. The disks are then tightly compressed and clamped between stout end-plates so as to form a nearly solid iron cylinder of axial length slightly exceeding the corresponding dimension of the poles. If the armature is more than 4 ft. in diameter, the disks become too large to be conveniently handled in one piece, and are therefore made in segments, which are built up so as to break joint alternately. Prior to assembly, the external circumference of each disk is notched in a stamping machine with the required number of slots to receive the armature coils, and the longitudinal grooves thereby formed in the finished core only require to have their sharp edges

The armature core.

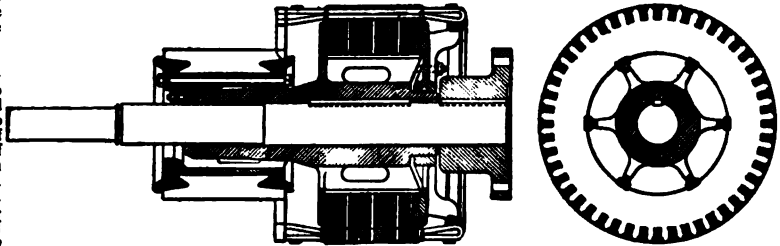

FIG. 19.

smoothed off so that there may be no risk of injury to the insulation of the coils.

With open slots either the armature coils may be encased with wrappings of oiled linen, varnished paper and thin flexible micanite sheeting in order to insulate them electrically from the iron slots in which they are afterwards embedded; or the slots may be themselves lined with moulded troughs of micanite, &c., for the reception of the armature coils, the latter method being necessary with half-closed slots. According to the nature of the coils armatures may be divided into the two classes of coil-wound and bar-wound. In the former class, round copper wire, double-cotton covered, is

Armature windings.

employed, and the coils are either wound by hand directly on to the armature core, or are shaped on formers prior to being inserted in the armature slots. Hand-winding is now only employed in very small bipolar machines, the process being expensive and accompanied by the disadvantage that if one section requires to be repaired, the whole armature usually has to be dismantled and re-wound. Former-wound coils are, on the other hand, economical in labour, perfectly symmetrical and interchangeable, and can be thoroughly insulated before they are placed in the slots. The shapers employed in the forming process are very various, but are usually arranged to give to the finished coil a lozenge shape, the two straight active sides which fit into the straight slots being joined by V-shaped ends; at each apex of the coil the wire is given a twist, so that the two sides fall into different levels, an upper and a lower, corresponding to the two layers which the coil-sides form on the finished armature. Rectangular wire of comparatively small section may be similarly treated, and if only one loop is required per section, wide and thin strip can be bent into a complete loop, so that the only soldered joints are those at the commutator end where the loops are interconnected. But finally with massive rectangular conductors, the transition must be made to bar-winding, in which each bar is a half-loop, insulated by being taped after it has been bent to the required shape; the separate bars are arranged on the armature in two layers, and their ends are soldered together subsequently to form loops. As a general rule, whether bars or former-wound coils are employed, the armature is barrel-wound, *i.e.* the end-connexions project outwards from the slots with but little change of level, so that they form a cylindrical mass supported on projections from the end-plates of the core (fig. 19); but, in certain cases, the end-connexions are bent downwards at right angles to the shaft, and they may then consist of separate strips of copper bent to a so-called butterfly or evolute shape.

After the coils or loops have been assembled in the slots on the armature core, and the commutator has been fixed in place on the shaft, the soldering of the ends of the coils proceeds, by which at once the union of the end of one coil with the beginning of the next, and also their connexion to the commutator sectors, is effected, and in this lies the essential part of armature winding.

The development of the modern drum armature, with its numerous coils connected in orderly sequence into a symmetrical winding, as contrasted with the earlier Siemens armatures, was initiated by F. von Hefner Alteneck (1871), and the laws governing the interconnexion of the coils have now been elaborated into a definite system of winding formulæ. Whatever the number of wires or bars in each side of a coil, *i.e.* whether it consist of a single loop or of many turns, the final connexions of its free ends are not thereby affected, and it may be mentally replaced by a single loop with two active inducing sides.

The coil-sides in their final position are thus to be regarded as separate primary elements, even in number, and distributed uniformly round the armature periphery or divided into small, equally spaced groups by being located within the slots of a toothed armature. Attention must then be directed simply to the span of the back connexion between the elements at the end of the armature further from the commutator, and to the span of the front connexion by which the last turn of a coil is finally connected to the first turn of the next in sequence, precisely as if each coil of many turns were reduced to a single loop. In order to avoid

direct differential action, the span of the back connexion which fixes the width of the coil must exceed the width of the pole-face, and should not be far different from the pole-pitch; it is usually a little less than the pole-pitch. Taking any one element as No. 1 in fig. 20, where for simplicity a smooth-core bipolar armature is shown, the number of winding-spaces, each to be occupied by an element, which must be counted off in order to find the position of the next element in series, is called the "pitch" of the end-connexion, front or back, as the case may be. Thus the back pitch of the winding as marked by the dotted line in fig. 20 is

7, the second side of the first loop being the element numbered 1-7=8. In forming the front end-connexion which completes the loop and joins it to the next in succession, two possible cases present themselves. By the first, or "lap-winding," the front end-connexion is brought backwards, and passing on its way to a junction with a commutator sector is led to a third element lying within the two sides of the first loop, *i.e.* the second loop starts with the element, No. 3, lying next but one to the starting-point of the

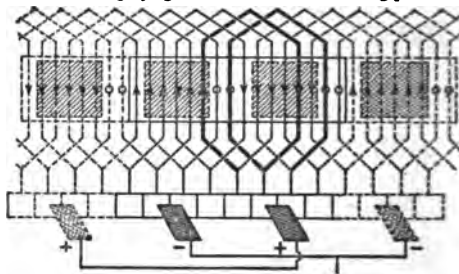
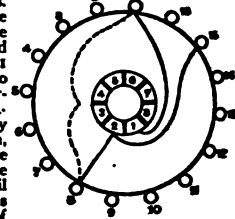

FIG. 21.

first loop. The winding therefore returns backwards on itself to form each front end, but as a whole it works continually forwards round the armature, until it finally "re-enters," after every element has been traversed. The development of the completed winding on a flat surface shows that it takes the form of a number of partially overlapping loops, whence its name originates. The form-plate portion of fig. 21 gives the development of an armature similar to that of fig. 18 when cut through at the point marked X and opened out; two of the overlapping loops are marked thereon in heavy lines.

The multipolar lap-wound armature is obtained by simply repeating the bipolar winding p times, as indicated by the dotted additions of fig. 21 which convert it from a two-pole to a four-pole machine. The characteristic feature of the lap-wound armature is that there are as many parallel paths from brush to brush, and as many points at which the current must be collected, as there are poles. As the bipolar closed-coil continuous-current armature has been shown to consist in reality of two circuits in parallel, each giving the same E.M.F. and carrying half the total current, so the multipolar lap-wound drum consists of p pairs of parallel paths, each giving the same E.M.F. and carrying $1/2p$ of the total current. Thus in equation 1, δ we have $q=2p$, and the special form which the E.M.F. equation of the lap-wound armature takes is $E_a = Z_a(N\delta\omega) \times 10^{-8}$ volts. All the brushes which are of the same sign must be connected together in order to collect the total armature current. The several brush-sets of the multipolar lap-wound machine may again be reduced to two by "cross-connexion" of sectors situated $360/p$



Wave-loops

FIG. 22.

apart, but this is seldom done, since the commutator must then be lengthened p times in order to obtain the necessary brush contact-surface for the collection of the entire current.

But for many purposes, especially where the voltage is high and the current small, it is advantageous to add together the inductive effect of the several poles of the multipolar machine by throwing the E.M.F.'s of half the total number of elements into series, the number of parallel circuits being conversely again reduced to two. This is effected by the second method of winding the closed-coil continuous current drum, which is known

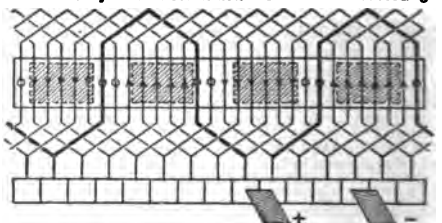

FIG. 23.

Wave-winding

apart, but this is seldom done, since the commutator must then be lengthened p times in order to obtain the necessary brush contact-surface for the collection of the entire current.

as "wave-winding." The front pitch is now in the same direction round the armature as the back pitch (fig. 22), so that the beginning of the second loop, i.e. element No. 15, lies outside the first loop. After p loops have been formed and as many elements have been traversed as there are poles, the distance covered either falls short of or exceeds a complete tour of the armature by two winding-spaces, or the width of two elements. A second and third tour are then made, and so on, until finally the winding again closes upon itself. When the completed winding is developed as in fig. 23, it is seen to work continuously forwards round the armature in zigzag waves, one of which is marked in heavy lines, and the number of complete tours is equal to the average of the back and front pitches. Since the number of parallel circuits from brush to brush is $q = 2$, the *E.M.F. equation of the wave-wound drum* is $E_a = pZ_a(N/60) \times 10^{-8}$ volts. Only two sets of brushes are necessary, but in order to shorten the length of the commutator, other sets may also be added at the point of highest and lowest potential up to as many in number as there are poles. Thus the advantage of the wave-wound armature is that for a given voltage and number of poles the number of active wires is only $1/p$ of that in the lap-wound drum, each being of larger cross-section in order to carry p times as much current; hence the ratio of the room occupied by the insulation to the copper area is less, and the available space is better utilized. A further advantage is that the two circuits from brush to brush consist of elements influenced by all the poles, so that if for any reason, such as eccentricity of the armature within the bore of the pole-pieces, or want of uniformity in the magnetic qualities of the poles, the flux of each field is not equal to that of every other, the equality of the voltage produced by the two halves of the winding is not affected thereby.

In appearance the two classes of armatures, lap and wave, may be distinguished in the barrel type of winding by the slope of the upper layer of back end-connexions, and that of the front connexions at the commutator end being parallel to one another in the latter, and oppositely directed in the former.

After completion of the winding, the end-connexions are firmly bound down by bands of steel or phosphor bronze binding wire, so as to resist the stress of centrifugal force. In the case

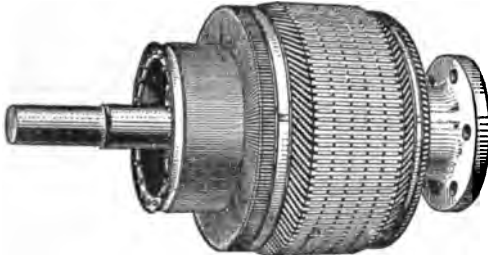

FIG. 24.

of smooth-surface armatures, such bands are also placed at intervals along the length of the armature core, but in toothed armatures, although the coils are often in small chambers secured in the slots by similar bands of a non-magnetic high-resistance wire, the use of hard-wood wedges driven into notches at the sides of the slots becomes preferable, and in very large machines indispensable. The external appearance of a typical armature with lap-winding is shown in fig. 24.

A sound mechanical construction of the commutator is of vital importance to the good working of the continuous-current dynamo. The narrow, wedge-shaped sectors of hard-drawn copper, with their insulating strips of thin mica, are built up into a cylinder, tightly clamped together, and turned in the lathe; at each end a V-shaped groove is turned, and into these are fitted rings of micanite of corresponding section (fig. 19); the whole is then slipped over a cast iron sleeve, and at either end strong rings are forced into the V-shaped grooves under great pressure and fixed by a number of closely-pitched tightening bolts. In dynamos driven by steam-turbines in which the peripheral speed of the commutator is very high, rings of steel are frequently shrunk on the surface of the commutator at either end and at its centre. But in every case the copper must be entirely insulated from the supporting body of metal by the interposition of mica or micanite and the prevention of any movement of the sectors under

frequent and long-continued heating and cooling calls for the greatest care in both the design and the manufacture.

On passing to the second fundamental part of the dynamo, namely, the field-magnet, its functions may be briefly recalled as follows:—It has to supply the magnetic flux; to provide for it an iron path as nearly closed as possible upon the armature, save for the air-gaps which must exist between the pole-system and the armature core, the one stationary and the other rotating; and, lastly, it has to give the lines such direction and intensity within the air-gaps that they may be cut by the armature wires to the best advantage. Roughly corresponding to the three functions above summarized are the three portions which are more or less differentiated in the complete structure. These are: (1) the magnet "cores" or "limbs," carrying the exciting coils whereby the inert iron is converted into an electro-magnet; (2) the *yoke*, which joins the limbs together and conducts the flux between them; and (3) the *pole-pieces*, which face the armature and transmit the lines from the limbs through the air-gap to the armature core, or vice versa.

Forms of field-magnet.

Of the countless shapes which the field-magnet may take, it may be said, without much exaggeration, that almost all have been tried; yet those which have proved economical and successful, and hence have met with general adoption, may be classed under a comparatively small number of types. For bipolar machines the *single horse-shoe* (fig. 25), which is the lineal successor of the permanent magnet employed in the first magneto-electric machines, was formerly very largely used. It takes two principal forms, according as the pole-pieces and armature are above or beneath the magnet limbs and yoke. The "over-type" form is best suited to small belt-driven dynamos, while the "under-type" is admirably adapted to be directly driven by the steam-engine, the armature shaft being immediately coupled to the crank-shaft of the engine. In the latter case the magnet must be mounted on non-magnetic supports of gun-metal or zinc, so as to hold it at some distance away from the iron bedplate which carries both engine and dynamo; otherwise a large proportion of the flux which passes through the magnet limbs would leak through the bedplate across from pole to pole without passing through the armature core, and so would not be cut by the armature wires.

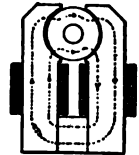

FIG. 25.

Next may be placed the "Manchester" field (fig. 26)—the type of a divided magnetic circuit in which the flux forming one field or pole is divided between two magnets. An exciting coil is placed on each half of the double horse-shoe magnet, the pair being so wound that consequent poles are formed above and below the armature. Each magnet thus carries one-half of the total flux, the lines of the two halves uniting to form a common field where they issue forth into or leave the air-gaps. The pole-pieces may be lighter than in the single horse-shoe type, and the field is much more symmetrical, whence it is well suited to ring armatures of large diameter. Yet these advantages are greatly discounted by the excessive magnetic leakage, and by the increased weight of copper in the exciting coils. Even if the greater percentage which the leakage lines bear to the useful flux is neglected, and the cross sectional area of each magnet core is but half that of the equivalent single horse-shoe, the weight of wire in the double magnet for the same rise of temperature in the coils must be some 40% more than in the single horse-shoe, and the rate at which energy is expended in heating the coils will exceed that of the single horse-shoe in the same proportion.

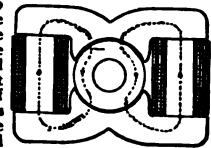

FIG. 26.

Thirdly comes the two-pole *ironclad* type, so called from the exciting coil being more or less encased by the iron yoke; this latter is divided into two halves, which pass on either side of the armature. Unless the yoke be kept well away from the polar edges and armature, the leakage across the air into the yoke becomes considerable, especially if only one exciting coil is used, as in fig. 27 A; it is better, therefore, to divide the excitation between two coils, as in fig. 27 B, when the field also becomes symmetrical.

From this form is easily derived the *multipolar* type of fig. 28 or fig. 29, which is by far the most usual for any number of poles from four upwards; its leakage coefficient is but small, and it is economical in weight both of iron and copper.

As regards the materials of which magnets are made, generally speaking there is little difference in the permeability of "wrought iron" or "mild steel forgings" and good "cast steel"; typical

The commutator.

(B,H) curves connecting the magnetizing force required with different flux-densities for these materials are given under ELECTROMAGNETISM. On the other hand there is a marked inferiority in the materials case of "cast iron," which for a flux-density of $B = 8000$ C.G.S. lines per sq. cm. requires practically the same number of ampere-turns per centimetre length as steel requires for $B = 16,000$. Whatever the material, if the flux-density be pressed to a high value the ampere-turns are very largely increased owing to its approaching saturation, and this implies either a large amount of copper in the field coils or an undue expenditure of electrical energy in their excitation. Hence there is a limit imposed by practical considerations to the density at which the magnet should be worked, and this limit may be placed at about $B = 16,000$ for wrought iron or steel, and at half this value for cast iron. For a given flux, therefore, the cast iron magnet must have twice the sectional area and be twice as heavy, although this disadvantage

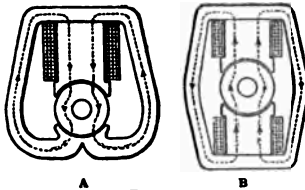

FIG. 27.

is partly compensated by its greater cheapness. If, however, cast iron be used for the portion of the magnetic circuit which is covered with the exciting coils, the further disadvantage must be added that the weight of copper on the field-magnet is much increased, so that it is usual to employ forgings or cast steel for the magnet cores on which the coils are wound. If weight is not a disadvantage, a cast iron yoke may be combined with the wrought iron or cast steel magnet cores. An absence of joints in the magnetic circuit is only desirable from the point of view of economy of expense in machining the component parts during manufacture; when the surfaces which abut against each other are drawn firmly together by screws, the want of homogeneity at the joint, which virtually amounts to the presence of a very thin film of air, produces little or no effect on the total reluctance by comparison with the very much longer air-gaps surrounding the armature. In order to reduce the eddy-currents in the pole-pieces, due to the use of toothed armatures with relatively wide slots, the poles themselves must be laminated, or must have fixed to them laminated pole-shoes, built up of thin strips of mild steel riveted together (as shown in fig. 29).

However it be built up, the mechanical strength of the magnet system must be carefully considered. Any two surfaces between which there exists a field of density B_p experience a force tending to draw them together proportional to the square of the density, and having a value of $B_p^2/(1.735 \times 10^8)$ lb per sq. in. of surface, over which the density may be regarded as having the uniform value B_p . Hence, quite stationary part of the dynamo tends to turn with the rotating part as soon as current is taken out of the armature, there exists a force tending to make the pole-pieces close on the armature as soon as the field is excited. Since both armature and magnet must be capable of resisting this force, they require to be rigidly held; although the one or the other must be capable of rotation, there should otherwise be no possibility of one part of the magnetic circuit shifting relatively to any other part. An important conclusion may be drawn from this circumstance. If the armature be placed

FIG. 28.

exactly concentric within the bore of the poles, and the two or more magnetic fields be symmetrical about a line joining their centres, there is no tendency for the armature core to be drawn in one direction more than in another; but if there is any difference between the densities of the several fields, it will cause an unbalanced stress on the armature and its shaft, under which it will bend, and as this bending is continually reversed relatively to the fibres of the shaft, they will eventually become weakened and give way. Especially is this likely to take place in dynamos with short air-gaps, wherein any difference in the lengths of the air-gaps produces a much greater percentage difference in the flux-density than in dynamos with long air-gaps. In toothed armatures with short air-gaps the shaft must on this account be sufficiently strong to withstand the stress without appreciable bending.

Reference has already been made to the importance in dynamo design of the *predetermination of the flux* due to a given number of ampere-turns wound on the field-magnet, or, conversely, of the number of ampere-turns which must be furnished by the exciting coils in order that a certain flux corresponding to one field may flow through the armature core from each pole. An equally important problem

is the correct proportioning of the field-magnet, so that the useful flux Z_m may be obtained with the greatest economy in materials and exciting energy. The key to the two problems is to be found in the concept of a magnetic circuit as originated by H. A. Rowland and R. H. M. Bosanquet;¹ and the full solution of both may be especially connected with the name of Dr J. Hopkinson, from his practical application of the concept in his design of the Edison-Hopkinson machine, and in his paper on "Dynamo-Electric Machinery."² The publication of this paper in 1886 begins the second era in the history of the dynamo; it at once raised its design from the level of empirical rules-of-thumb to a science, and is thus worthy to be ranked as the necessary supplement of the original discoveries of Faraday. The process of predetermining the necessary ampere-turns is described in a simple case under ELECTROMAGNETISM. In its extension to the complete dynamo, it consists merely in the division of the magnetic circuit into such portions as have the same sectional area and permeability and carry approximately the same total flux; the difference of magnetic potential that must exist between the ends of each section of the magnet in order that the flux may pass through it is then calculated *serialim* for the several portions into which the magnetic circuit is divided, and the separate items are summed up into one-

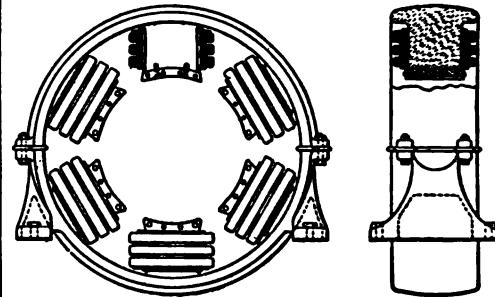

FIG. 29.

magnetomotive force that must be furnished by the exciting coils.

The chief sections of the magnetic circuit are (1) the air-gaps, (2) the armature core, and (3) the iron magnet.

The air-gap of a dynamo with smooth-core armature is partly filled with copper and partly with the cotton, mica, or other materials used to insulate the core and wires; all these substances are, however, sensibly non-magnetic, so that the whole interferic gap between the iron of the pole-pieces and the iron of the armature may be treated as an air-space, of which the permeability is constant for all values of the flux-density, and in the C.G.S. system is unity. Hence if l_p and A_p be the length and area of the single air-gap in cm. and sq. cm., the reluctance of the double air-gap is $2l_p/A_p$, and the difference of magnetic potential required to pass Z_m lines over this reluctance is $Z_m \cdot 2l_p/A_p = B_p \cdot 2l_p$; or, since one ampere-turn gives 1.257 C.G.S. units of magnetomotive force, the exciting power in ampere-turns required over the two air-gaps is $X_p = B_p \cdot 2l_p / 1.257 = 0.8 B_p \cdot 2l_p$. In the determination of the area A_p , a small allowance must be made for the fringe of lines which extend beyond the actual polar face. In the toothed armature with open slots, the lines are no longer uniformly distributed over the air-gap area, but are graduated into alternate bands of dense and weak induction corresponding to the teeth and slots. Further, the lines curve round into the sides of the teeth, so that their average length of path in the air and the air-gap reluctance is not so easily calculated. Allowance must be made for this by taking an increased length of air-gap $= ml_p$, where m is the ratio *maximum density/mean density*, of which the value is chiefly determined by the ratios of the width of tooth to width of slot and of the width of slot to the air-gap between pole-face and surface of the armature core.

¹ And extended by G. Kapp, "On Modern Continuous-Current Dynamo-Electric Machines," *Proc. Inst. C.E.* vol. lxxxiii. p. 136.

² Drs J. and E. Hopkinson, "Dynamo-Electric Machinery," *Phil. Trans.*, May 6, 1886; this was further expanded in a second paper on "Dynamo-Electric Machinery," *Proc. Roy. Soc.*, Feb. 15, 1892, and both are reprinted in *Original Papers on Dynamo-Machinery and Allied Subjects*.

The *armature core* must be divided into the teeth and the core proper below the teeth. Owing to the tapering section of the teeth, the density rises towards their root, and when this reaches a high value, such as 18,000 or more lines per sq. cm., the saturation of the iron again forces an increasing proportion of the lines outwards into the slot. A distinction must then be drawn between the "apparent" induction which would hold if all the lines were concentrated in the teeth, and the "real" induction. The area of the iron is obtained by multiplying the number of teeth under the pole-face by their width and by the net length of the iron core parallel to the axis of rotation. The latter is the gross length of the armature less the space lost through the insulating varnish or paper between the disks or through the presence of ventilating ducts, which are introduced at intervals along the length of the core. The former deduction averages about 7 to 10% of the gross length, while the latter, especially in large multipolar machines, is an even more important item. After calculating the density at different sections of the teeth, reference has now to be made to a (B, H) or flux-density curve, from which may be found the number of ampere-turns required per cm. length of path. This number may be expressed as a function of the density in the teeth, and if $f(B_t)$ be its average value over the length of a tooth, the ampere-turns of excitation required over the teeth on either side of the core as the lines of one field enter or leave the armature is $X_t = f(B_t) \cdot 2l_t$, where l_t is the length of a single tooth in cm.

In the core proper below the teeth the length of path continually shortens as we pass from the middle of the pole towards the centre line of symmetry. On the other hand, as the lines gradually accumulate in the core, their density increases from zero midway under the poles until it reaches a maximum on the line of symmetry. The two effects partially counteract one another, and tend to equalize the difference of magnetic potential required over the paths of varying lengths; but since the reluctivity of the iron increases more rapidly than the density of the lines, we may approximately take for the length of path (l_c) the minimum peripheral distance between the edges of adjacent pole-faces, and then assume the maximum value of the density of the lines as holding throughout the entire path. In ring and drum machines the flux issuing from one pole divides into two halves in the armature core, so that the maximum density of lines in the armature is $B_m = Z_p / 2ab$, where a = the radial depth of the disks in centimetres and b = the net length of iron core. The total exciting power required between the pole-pieces is therefore, at no load, $X_p = X_t + X_c$, where $X_c = f(B_m) \cdot l_c$; in order, however, to allow for the effect of the armature current, which increases with the load, a further term X_a must be added.

In the continuous-current dynamo it may be, and usually is, necessary to move the brushes forward from the interpolar line of symmetry through a small angle in the direction of rotation, in order to avoid sparking between the brushes and the commutator (*vide infra*). When the dynamo is giving current, the wires on either side of the diameter of commutation form a current-sheet flowing along the surface of the armature from end to end, and whatever the actual end-connections of the wires, the wires may be imagined to be joined together into a system of loops such that the two sides of each loop are carrying current in opposite directions. Thus a number of armature ampere-turns are formed, and their effect on the entire system of magnet and armature must be taken into account. So long as the diameter of commutation coincides with the line of symmetry, the armature may be regarded as a cylindrical electromagnet producing a flux of lines, as shown in fig. 30.

The direction of the self-induced flux in the air-gaps is the same as that of the lines of the external field in one quadrant on one side of DC, but opposed to it in the other quadrant on the same side of DC; hence in the resultant field due to the combined action of the field-magnet and armature ampere-turns, the flux is as much strengthened over the one half of each polar face as it is weakened over the other, and the total number of lines is unaffected, although their distribution is altered. The armature ampere-turns are then called *cross-turns*, since they produce a cross-field, which, when combined with the symmetrical field, causes the leading

pole-corners B to be weakened and the trailing pole-corners B' to be strengthened, the neutral line of zero field being thus twisted forwards in the direction of rotation. But when the brushes and diameter of commutation are shifted forward, as shown in fig. 31, it will be seen that a number of ampere-turns, forming a zone between the lines Dw and wC , are in effect wound immediately on the magnetic circuit proper, and this belt of ampere-turns is in direct opposition to the ampere-turns of the field, as shown by the dotted and crossed wires on the pole-pieces. The armature ampere-turns are then divisible into the two bands, the *back-turns*, included within twice the angle of lead λ , weakening the field, and the *cross-turns*, bounded by the lines Dm , wC , again producing distortion of the weakened sym-

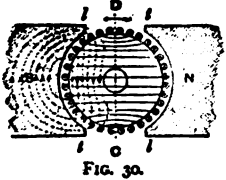

FIG. 30.

metrical field. If, therefore, a certain flux is to be passed through the armature core in opposition to the demagnetizing turns, the difference of magnetic potential between the pole-faces must include not only X_t , X_c , and X_p , but also an item X_a , in order to balance the "back" ampere-turns of the armature. The amount by which the brushes must be shifted forward increases with the armature current, and in corresponding proportion the back ampere-turns are also increased, their value being $cI \cdot 2\lambda / 360^\circ$, where c = the current carried by each of the r active wires. Thus the term X_a takes into account the effect of the armature reaction on the total flux; it varies as the armature current and angle of lead required to avoid sparking are increased; and the reason for its introduction in the fourth place ($X_p = X_t + X_c + X_a$), is that it increases the magnetic difference of potential of the poles which must exist between the poles of the dynamo, and to which the greater part of the leakage is due. The leakage paths which are in parallel with the armature across the poles must now be estimated, and so a new value be derived for the flux at the commencement of the *iron-magnet* path. If P = their joint permeance, the leakage flux due to the difference of potential at the poles is $s_p = 1 - 257 X_p \cdot XP$, and this must be added to the useful flux Z_p , or $Z_p = Z_p + s_p$. There are also certain leakage paths in parallel with the magnet cores, and upon the permeance of these a varying number of ampere-turns is acting as we proceed along the magnet coils; the magnet flux therefore increases by the addition of leakage along the length of the limbs, and finally reaches a maximum near the yoke. Either, then, the density in the magnet $B_m = Z_m / A_m$ will vary if the same sectional area be retained throughout, or the sectional area of the magnet must itself be progressively increased. In general, sufficient accuracy will be obtained by assuming a certain number of additional leakage lines s_m as traversing the entire length of magnet limbs and yoke ($= l_m$), so that the density in the magnet has the uniform value $B_m = (Z_p + s_m) / A_m$. The leakage flux added actually within the length of the magnet core or s_m will be approximately equal to half the total M.M.F. of the coils multiplied by the permeance of the leakage paths around one coil. The corresponding value of H can then be obtained from the (B, H) curve of the material of which the magnet is composed, and the ampere-turns thus determined must be added to X_p , or $X = X_p + X_m$, where $X_m = f(B_m) \cdot l_m$. The final equation for the exciting power required on a magnetic circuit as a whole will therefore take the form

$$X = AT = o - 8B_p \cdot 2l_p + f(B_t) \cdot 2l_t + f(B_m) \cdot l_m + X_t + f(B_m) \cdot l_m \quad (3)$$

If the magnet cores are of wrought iron or cast steel, and the yoke is of cast iron, the last term must be divided into two portions corresponding to the different materials, *i.e.* into $f(B_m) \cdot l_m + f(B_m) \cdot l_y$. In the ordinary multipolar machine with as many magnet-coils as there are poles, each coil must furnish half the above number of ampere-turns.

Since no substance is impermeable to the passage of magnetic flux, the only form of magnetic circuit free from leakage is one uniformly wound with ampere-turns over its whole length. The reduction of the magnetic leakage to a minimum in any given type is therefore primarily a question of distributing the winding as far as possible uniformly upon the circuit, and as the winding must be more or less concentrated into coils, it resolves itself into the necessity of introducing as long air-paths as possible between any surfaces which are at different magnetic potentials. No iron should be brought near the machine which does not form part of the magnetic circuit proper, and especially no iron should be brought near the poles, between which the difference of magnetic potential practically reaches its maximum value. In the design of a machine of the same size or similar type on which to experiment, the probable direction of the leakage flux must be assumed from the drawing, and the air surrounding the machine must be mapped out into areas, between which the permeances are calculated as closely as possible by means of such approximate formulæ as those devised by Professor G. Forbes.

In the earliest "magneto-electric" machines permanent steel magnets, either simple or compound, were employed, and for many years these were retained in certain alternators, some of which are still in use for arc lighting in lighthouses. But since the field they furnish is very weak, a great advance was made when they were replaced by soft iron electromagnets, which could be made to yield a much more intense flux. As early as 1831 Faraday¹ experimented with electromagnets, and after 1850 they gradually superseded the permanent magnet. When the total ampere-turns required to excite the electromagnet have been determined, it remains to decide how the excitation shall be obtained; and, according to the method

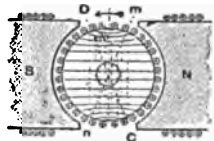

FIG. 31.

¹ *Exp. Res.*, series i. § 4, par. 111. In 1845 Wheatstone and Cooke patented the use of "voltaic" magnets in place of permanent magnets (No. 10,655).

Magnetic leakage.

Excitation of field-magnet.

adopted, continuous-current machines may be divided into four well-defined classes.

The simplest method, and that which was first used, is *separate excitation* from some other source of direct current, which may be either a primary or a secondary battery or another dynamo (fig. 32). But since the armature yields a continuous current, it was early suggested (by J. Brett in 1848 and F. Sinisteden in 1851) that this current might be utilized to increase the flux; combinations of permanent and electromagnets were therefore next employed, acting either on the main armature or on separate armatures, until

in 1867 Dr Werner von Siemens and Sir C. Wheatstone almost simultaneously discovered that the dynamo could be made *self-exciting* through the residual magnetism retained in the soft iron cores of the electromagnet. The former proposed to take the magnet of the current round the main coils which were in series with the armature and external circuit, while the latter proposed to utilize only a portion derived by a shunt from the main circuit; we thus arrive at the second and third classes, namely, *series* and *shunt* machines. The starting of the process of excitation in either case is the

same; when the brushes are touching the commutator and the armature is rotated, the small amount of flux left in the magnet is cut by the wires, and a very small current begins to flow round the closed circuit; this increases the flux, which in turn further increases the E.M.F. and current, until, finally, the cumulative effect stops through the increasing saturation of the iron cores. Fig. 33, illustrating the *series* machine, shows the winding of the exciting coils to be composed of a few turns of thick wire. Since the current is undivided throughout the whole circuit, the resistance of both the armature and field-magnet winding must be low as compared with that of the external circuit, if the useful power available at the terminals of the machine is to form a large percentage of the total electrical power—in other words, if the efficiency is to be high. Fig. 34 shows the third method, in which the winding of the field-magnets is a *shunt* or fine-wire circuit of many turns applied to the terminals of the machine; in this case the resistance of the shunt

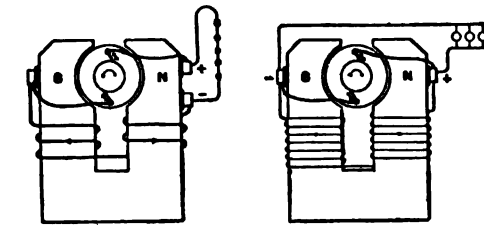

FIG. 33.

FIG. 34.

must be high as compared with that of the external circuit, in order that only a small proportion of the total energy may be absorbed in the field.

Since the whole of the armature current passes round the field-magnet of the series machine, any alteration in the resistance of the external circuit will affect the excitation and also the voltage. A curve connecting together corresponding values of external current and terminal voltage for a given speed of rotation is known as the *external-characteristic* of the machine; in its main features it has the same appearance as a curve of magnetic flux, but when the current exceeds a certain amount it begins to bend downwards and the voltage decreases. The reason for this will be found in the armature reaction at large loads, which gradually produces a more and more powerful demagnetizing effect, as the brushes are shifted forwards to avoid sparking; eventually the back ampere-turns overpower any addition to the field that would otherwise be due to the increased current flowing round the magnet. The "external characteristic" for a shunt machine has an entirely different shape. The field-magnet circuit being connected in parallel with the external circuit, the exciting current, if the applied voltage remains the same, is in no way affected by alterations in the resistance of the latter. As, however, an increase in the external current causes a greater loss of volts in the armature and a greater armature reaction, the terminal voltage, which is also the exciting voltage, is highest at no load and then diminishes. The fall is at first gradual, but after a certain critical value of the armature current is reached, the machine is rapidly demagnetized and loses its voltage entirely.

The last method of excitation, namely, *compound-winding* (fig. 35), is a combination of the two preceding, and was first used by S. A. Varley and by C. F. Brush. If a machine is in the first instance shunt-wound, and a certain number of series-turns are added, the latter, since they carry the external current, can be made to counteract the effect which the increased external current would have in lowering the voltage of the simple shunt machine. The ampere-turns of the series winding must be such that they not only balance the increase of the demagnetizing back ampere-turns on the armature, but further increase the useful flux, and compensate for the loss of volts over their own resistance and that of the armature. The machine will then give for a constant speed a nearly constant voltage at its terminals, and the curve of the external characteristic becomes a straight line for all loads within its capacity. Since with most prime movers an increase of the load is accompanied by a drop in speed, this effect may also be counteracted; while, lastly, if the series-turns are still further increased, the voltage may be made to rise with an increasing load, and the machine is "over-compounded."

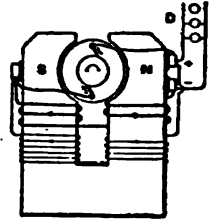

FIG. 35.

At the initial moment when an armature coil is first short-circuited by the passage of the two sectors forming its ends under the contact surface of a brush, a certain amount of electromagnetic energy is stored up in its magnetic field as linked with the ampere-turns of the coil when carrying its full share of the total armature current. During the period of short-circuit this quantity of energy has to be dissipated as the current falls to zero, and has again to be re-stored as the current is reversed and raised to the same value, but in the opposite direction. The period of short-circuit as fixed by the widths of the brush and of the mica insulation between the sectors, and by the peripheral speed of the commutator is extremely brief, and only lasts on an average from $\frac{1}{100}$ th to $\frac{1}{200}$ th of a second. The problem of sparkless commutation is therefore primarily a question of our ability to dissipate and to re-store the required amount of energy with sufficient rapidity.

An important aid towards the solution of this problem is found in the effect of the varying contact-resistance between the brush and the surfaces of the leading and trailing sectors which it covers. As the commutator moves under the brush, the area of contact which the brush makes with the leading sector diminishes, and the resistance between the two rises; conversely, the area of contact between the brush and the trailing sector increases and the resistance falls. This action tends automatically to bring the current through each sector into strict proportionality to the amount of its surface which is covered by the brush, and so to keep the current-density and the loss of volts over the contacts uniform and constant. As soon as the current-density in the two portions of the brush becomes unequal, a greater amount of heat is developed at the commutator surface, and this in the first place affords an additional outlet for the dissipation of the stored energy of the coil, while after reversal of the current it is the accompaniment of a re-storage of the required energy. This energy, as well as that which is spent in heating the coil, can in fact, in default of other sources, be derived through the action of the unequal current-density from the electrical output of the rest of the armature winding, and so only indirectly from the prime mover.

In practice, when the normal contact-resistance of the brushes is low relatively to the resistance of the coil, as is the case with metal brushes of copper or brass gauze, but little benefit can be obtained from the action of the varying contact-resistance. It exerts no appreciable effect until close towards the end of the period of short-circuit, and then only with such a high-current-density at the trailing edge of the leaving sector that at the moment of parting the brush-tip is fused, or its metal volatilized, and sparking has in fact set in. With such brushes, then, it becomes necessary to call in the aid of a reversing E.M.F. impressed upon the coil by the magnetic field through which it is moving. If such a reversing field comes into action while

Commutations and sparking at the brushes.

the current is still unreversed, its E.M.F. is opposed to the direction of the current, and the coil is therefore driving the armature forward as in a motor; it thus affords a ready means of rapidly dissipating part of the initial energy in the form of mechanical work instead of as heat. After the current has been reversed, the converse process sets in; and the prime mover directly expends mechanical energy not only in heating the coil, but also in storing up electromagnetic energy with a rapidity dependent upon the strength of the reversing field. The required direction of external field can be obtained in the dynamo by shifting the brushes forward, so that the short-circuited coil enters into the fringe of lines issuing from the leading pole-tip, *i.e.* by giving the brushes an "angle of lead." An objection to this process is that the main flux is thereby weakened owing to the belt of back ampere-turns which arises (*v. supra*). A still greater objection is that the amount of the angle of lead must be suited to the value of the load, the corrective power of copper brushes being very small if the reversing E.M.F. is not closely adjusted in proportion to the armature current.

On this account metal brushes have been almost entirely superseded by carbon moulded into hard blocks. With these, owing to their higher specific contact-resistance, a very considerable reversing effect can be obtained through the action of unequal current-density, and indeed in favourable cases complete sparklessness can be obtained throughout the entire range of load of the machine with a fixed position of the brushes. Yet if the work which they are called upon to perform exceeds certain limits, they tend to become overheated with consequent glowing or sparking at their tips, so that, wherever possible, it is advisable to reinforce their action by a certain amount of reversing field, the brushes being set so that their strength is roughly correct for, say, half load.

In the case of dynamos driven by steam-turbines, sparkless commutation is especially difficult to obtain owing to the high speed of rotation and the very short space of time in which the current has to be reversed. Special "reversing poles" then become necessary; these are wound with magnetizing coils in series with the main armature current, so that the strength of field which they yield is roughly proportional to the current which has to be reversed. These again may be combined with a "compensating winding" embedded in the pole-faces and carrying current in the opposite direction to the armature ampere-turns, so as to neutralize the cross effect of the latter and prevent distortion of the resultant field.

From the moment that a dynamo begins to run with excited field, heat is continuously generated by the passage of the current through the windings of the field-magnet coils and the armature, as well as by the action of hysteresis and eddy currents in the armature and pole-pieces. Whether the source of the heat be in the field-magnet or in the armature, the mass in which it originates will continue to rise in temperature until such a difference of temperature is established between itself and the surrounding air that the rate at which the heat is carried off by radiation, convection and conduction is equal to the rate at which it is being generated. Evidently, then, the temperature which any part of the machine attains after a prolonged run must depend on the extent and effectiveness of the cooling surface from which radiation takes place, upon the presence or absence of any currents of air set up by the rotation of itself or surrounding parts, and upon the presence of neighbouring masses of metal to carry away the heat by conduction. In the field-magnet coils the rate at which heat is being generated is easily determined, since it is equal to the square of the current passing through them multiplied by their resistance. Further, the magnet is usually stationary, and only indirectly affected by draughts of air due to the rotating armature. Hence for machines of a given type and of similar proportions, it is not difficult to decide upon some method of reckoning the cooling surface of the magnet coils S_m , such that the rise of temperature above that of the surrounding air may be predicted from an equation of the form $t = AW/S_m$, where W = the rate in watts at which heat is generated in the coils, and A is some constant depending upon the exact method of reckoning their cooling surface. As a general rule the cooling surface of a field-coil is reckoned as equal to the exposed outer surface of its wire, the influence of the end flanges being neglected, or only taken into account in the case of very short bobbins wound with a considerable depth of wire. In the case of the rotating armature a similar formula must be constructed, but

with the addition of a factor to allow for the increase in the effectiveness of any given cooling surface due to the rotation causing convection currents in the surrounding air. Only experiment can determine the exact effect of this, and even with a given type of armature it is dependent on the number of poles, each of which helps to break up the air-currents, and so to dissipate the heat. For example, in two-pole machines with drum bar-armatures, if the cooling surface be reckoned as equal to the cylindrical exterior plus the area of the two ends, the heating coefficient for a peripheral speed of 1500 ft. per minute is less than half of that for the same armature when at rest. A further difficulty still meets the designer in the correct predetermination of the total loss of watts in an armature before the machine has been tested. It is made up of three separate items, namely, the copper loss in the armature winding, the loss by hysteresis in the iron, and the loss by eddy currents, which again may be divided into those in the armature bars and end-connections, and those in the core and its end-plates. The two latter items are both dependent upon the speed of the machine; but whereas the hysteresis loss is proportional to the speed for a given density of flux in the armature, the eddy current loss is proportional to the square of the speed, and owing to this difference, the one loss can be separated from the other by testing an armature at varying speeds. Thus for a given rise of temperature, the question of the amount of current which can be taken out of an armature at different speeds depends upon the proportion which the hysteresis and eddy watts bear to the copper loss, and the ratio in which the effectiveness of the cooling surface is altered by the alteration in speed. Experimental data, again, can alone decide upon the amount of eddy currents that may be expected in given armatures, and caution is required in applying the results of one machine to another in which any of the conditions, such as the number of poles, density in the teeth, proportions of slot depth to width, &c., are radically altered.

It remains to add, that the rise of temperature which may be permitted in any part of a dynamo after a prolonged run is very generally placed at about 70° Fahr. above the surrounding air. Such a limit in ordinary conditions of working leads to a final temperature of about 170° Fahr., beyond which the durability of the insulation of the wires is liable to be injuriously affected. Upon some such basis the output of a dynamo in continuous working is rated, although for short periods of, say, two hours the normal full-load current of a large machine may be exceeded by some 25% without unduly heating the armature.

For the electro-deposition of metals or the electrolytic treatment of ores a continuous current is a necessity; but, apart from such use, the purposes from which the continuous-current dynamo is well adapted are so numerous that they cover nearly the whole field of electrical engineering, with one important exception. To meet these various uses, the pressures for which the machine is designed are of equally wide range; for the transmission of power over long distances they may be as high as 3000 volts, and for electrolytic work as low as five. Each electrolytic bath, with its leads, requires on an average only some four or five volts, so that even when several are worked in series the voltage of the dynamo seldom exceeds 60. On the other hand, the current is large and may amount to as much as from 1000 to 14,000 amperes, necessitating the use of two commutators, one at either end of the armature, in order to collect the current without excessive heating of the sectors and brushes. The field-magnets are invariably shunt-wound, in order to avoid reversal of the current through polarization at the electrodes of the bath. For incandescent lighting by glow lamps, the requirements of small isolated installations and of central stations for the distribution of electrical energy over large areas must be distinguished. For the lighting of a private house or small factory, the dynamo giving from 5 to 100 kilo-watts of output is commonly wound for a voltage of 100, and is driven by pulley and belt from a gas, oil or steam-engine; or, if approaching the higher limit above mentioned, it is often directly coupled to the crank-shaft of the steam-engine. If used in conjunction with an accumulator of secondary cells, it is shunt-wound, and must give the higher voltage necessary to charge the battery; otherwise it is compound-wound, in order to maintain the pressure on the lamps constant under all loads within its capacity. The compound-wound dynamo is likewise the most usual for the lighting of steamships, and is then directly coupled to its steam-engine; its output seldom exceeds 100 kilo-watts, at a voltage of 100 or 110. For larger installations a voltage of 250 is commonly used, while for central-station work, economy in the distributing

Use of
con-
tinuous-
current
dynamoes.

mains dictates a higher voltage, especially in connexion with a three-wire system; the larger dynamos may then give 500 volts, and be connected directly across the two outer wires. A pair of smaller machines coupled together, and each capable of giving 250 volts, are often placed in series across the system, with their common junction connected to the middle wire; the one which at any time is on the side carrying the smaller current will act as a motor and drive the other as a dynamo, so as to balance the system. The directly-coupled steam dynamo may be said to have practically displaced the belt- or rope-driven sets which were formerly common in central stations. The generating units of the central station are arranged in progressive sizes, rising from, it may be, 250 or 500 horse-power up to 750 or 1000, or in large towns to as much as 5000 horse-power. If for lighting only, they are usually shunt-wound, the regulation of the voltage, to keep the pressure constant on the distributing system under the gradual changes of load, being effected by variable resistances in the shunt circuit of the field-magnets.

Generators used for supplying current to electric tramways are commonly wound for 500 volts at no load and are over-compounded, so that the voltage rises to 550 volts at the maximum load, and thus compensates for the loss of volts over the transmitting lines. For arc lighting it was formerly usual to employ a class of dynamo which, from the nature of its construction, was called an "open-coil" machine, and which gave a unidirectional but pulsating current. Of such machines the Brush and Thomson-Houston types were very widely used; their E.M.F. ranged from 2000 to 3000 volts for working a large number of arcs in series, and by means of special regulators their current was maintained constant over a wide range of voltage. But as their efficiency was low and they could not be applied to any other purpose, they have been largely superseded in central stations by closed-coil dynamos or alternators, which can also be used for incandescent lighting. In cases where the central station is situated at some distance from the district to which the electric energy is to be supplied, voltages from 1000 to 2000 are employed, and these are transformed down at certain distributing centres by continuous-current transformers (see TRANSFORMERS and ELECTRICITY SUPPLY). These latter machines are in reality motor-driven dynamos, and hence are also called *motor-generators*; the armatures of the motor and dynamo are often wound on the same core, with a commutator at either end, the one to receive the high-pressure motor current, and the other to collect the low-pressure current furnished by the dynamo.

In all large central stations it is necessary that the dynamos should be capable of being run *in parallel*, so that their outputs may be combined on the same "omnibus bars" and thence distributed to the network of feeders. With simple shunt-wound machines this is easily effected by coupling together terminals of like sign when the voltage of the two or more machines are closely equal. With compound-wound dynamos not only must the external terminals of like sign be coupled together, but the junctions of the brush leads with the series winding must be connected by an "equalizing" lead of low resistance; otherwise, should the E.M.F. of one machine for any reason fall below the voltage of the omnibus bars, there is a danger of its polarity being reversed by a back current from the others with which it is in parallel.

Owing to the necessary presence in the continuous-current dynamo of the commutator, with its attendant liability to sparking at the brushes, and further, owing to the difficulty of insulating the rotating armature wires, a pressure of 3000 volts has seldom been exceeded in any one continuous-current machine, and has been given above as the limiting voltage of the class. If therefore it is required to work with higher pressures in order to secure economy in the transmitting lines, two or more machines must be coupled *in series* by connecting together terminals which are of unlike sign.¹ The stress of the total voltage may still fall on the insulation of the winding

¹ Between Moutiers and Lyons, a distance of 115 m., energy is transmitted on the Thury direct-current system at a maximum pressure of 60,000 volts. Four groups of machines in series are employed, each group consisting of four machines in series; the rated output of each component machine is 75 amperes at 3900 volts or 400 h.p. A water turbine drives two pairs of such machines through an insulating coupling, and the sub-base of each pair of machines is separately insulated from earth, the foundation being also of special insulating materials.

from the body of the machine; hence for high-voltage transmission of power over very long distances, the continuous-current dynamo in certain points yields in convenience to the alternator. In this there is no commutator, the armature coils may be stationary and can be more thoroughly insulated, while, further, if it be thought undesirable to design the machine for the full transmitting voltage, it is easy to wind the armature for a low pressure; this can be subsequently transformed up to a high pressure by means of the alternating-current transformer, which has stationary windings and so high an efficiency that but little loss arises from its use. With these remarks, the transition may be made to the fuller discussion of the alternator.

Alternators.

The frequency employed in alternating-current systems for distributing power and light varies between such wide limits as 25 and 133; yet in recent times the tendency *Frequency.* has been towards standard frequencies of 25, 50 and 100 as a maximum. High frequencies involve more copper in the magnet coils, owing to the greater number of poles, and a greater loss of power in their excitation, but the alternator as a whole is somewhat lighter, and the transformers are cheaper. On the other hand, high frequency may cause prejudicial effects, due to the inductance and capacity of the distributing lines; and in asynchronous motors used on polyphase systems the increased number of poles necessary to obtain reasonable speeds reduces their efficiency, and is otherwise disadvantageous, especially for small horse-powers. A frequency lower than 40 is, however, not permissible where arc lighting is to form any considerable portion of the work and is to be effected by the alternating current without rectification, since below this value the eye can detect the periodic alteration in the light as the carbons alternately cool and become heated. Thus for combined lighting and power 50 or 60 are the most usual frequencies; but if the system is designed solely or chiefly for the distribution of power, a still lower frequency is preferable. On this account 25 was selected by the engineers for the Niagara Falls power transmission, after careful consideration of the problem, and this frequency has since been widely adopted in similar cases.

The most usual type of heteropolar alternator has an internal rotating field-magnet system, and an external stationary armature, as in fig. 10. The coils of the armature, which must for high voltages be heavily insulated, are then not subjected to the additional stresses due to centrifugal force; and further, the collecting rings which must be attached to the rotating portion need only transmit the exciting current at a low voltage.

The homopolar machine possesses the advantages that only a single exciting coil is required, whatever the number of pole projections, and that both the armature and field-magnet coils may be stationary. From fig. 8 it will be seen that it is not

essential that the exciting coil should revolve with the internal magnet, but it may be supported from the external stationary armature while still embracing the central part of the rotor. The E.M.F. is set up in the armature coils through the periodic variation of the flux through them as the iron projections sweep past, and these latter may be likened to a number of "keepers," which complete the magnetic circuit. From the action of the rotating iron masses they may also be considered as the inducing elements or "inductors," and the homopolar machine is thence also known as the "inductor alternator." If the end of the rotor marked S in fig. 8 is split up into a number of S polar projections similar to the N poles, a second set of armature coils may be arranged opposite to them, and we obtain an inductor

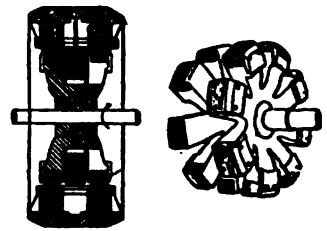

FIG. 36.

alternator with double armature. Or the polar projections at the two ends may be staggered, and a single armature winding be passed straight through the armature, as in fig. 36, which shows at the side the appearance of the revolving inductor with its crown of polar projections in one ring opposite to the gaps

may be subjected, its own weight tends to deform it. The segmental core-disks are usually secured to the internal circumference of a circular cast iron frame; the latter has a box section of considerable radial depth to give stiffness to it, and the disks are tightly clamped between internal flanges, one being a fixed

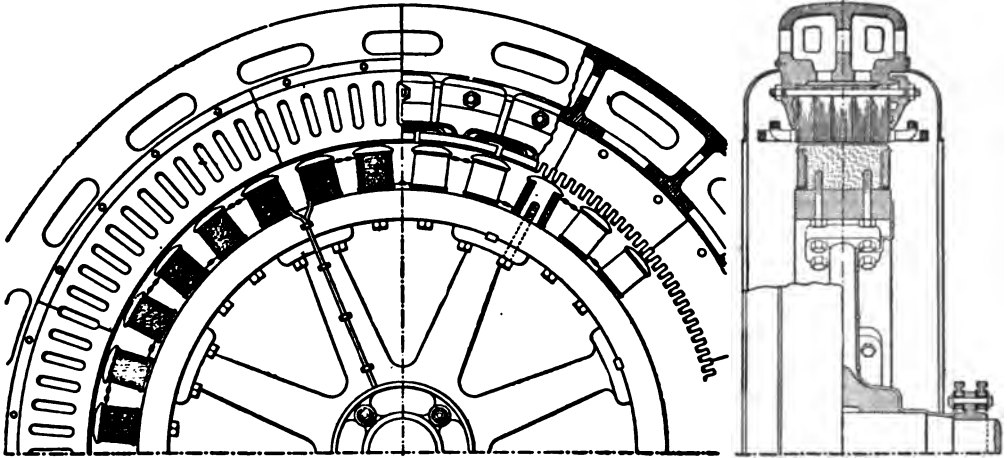

FIG. 37.

between the polar projections of the other ring. But in spite of its advantage of the single stationary exciting coil, the inductor alternator has such a high degree of leakage, and the effect of armature reaction is so detrimental in it, that the type has been gradually abandoned, and a return has been almost universally made to the heteropolar alternator with internal poles radiating outwards from a circular yoke-ring. The construction of a typical machine of this class is illustrated in fig. 37.

Since the field-magnet coils rotate, they must be carefully designed to withstand centrifugal force, and are best composed of flat copper strip wound on edge with thin insulation between adjacent layers. The coil is secured by the edges of the pole-shoes which overhang the pole and tightly compress the coil against the yoke-ring; the only effect from centrifugal force is then to compress still further the flat turns of copper against the pole-shoes without deformation. The poles are either of cast steel of circular or oblong section, bolted to the rim of the yoke-ring, or are built up of thin laminations of sheet steel. When the peripheral speed is very high, the yoke-ring will be of cast steel or may itself be built up of sheet steel laminations, this material being reliable and easily tested to ensure its sound mechanical strength. If the armature slots are open, the pole-pieces will in any case be laminated to reduce the eddy currents set up by the variation of the flux-density.

Owing to the great number of poles¹ of the alternator when driven by a reciprocating steam-engine, the diameter of its rotor is usually larger and its length less than in the continuous-current dynamo of corresponding output. The support of the armature core when of large diameter is therefore a more difficult problem, since, apart from any magnetic strains to which it

part of the frame and the other loose, with transverse bolts passing right through from side to side (fig. 37). In order to lessen the weight of the structure and its expense in material, the cast iron frame has in some cases been entirely dispensed with, and braced tie-rods have been used to render the effective iron of the armature core-disks self-supporting.

Owing to the high speed of the turbo-alternator, its rotor calls for the utmost care in its design to withstand the effect of centrifugal force without any shifting of the exciting coils, and to secure a perfect balance.

The appearance of the armature of a typical three-phase alternator is illustrated in fig. 38, which shows a portion of the lower half after removal of the field-magnet.

With open slots the coils, after being wound on formers to the required shape, are thoroughly impregnated with insulating compound, dried, and after a further wrapping with several layers of insulating material, finally pressed into the slots together with a sheet of leatheroid or flexible micanite. The end-connexions of each group of coils of one phase project straight out from the slots or are bent upwards alternately with those of the other phases, so that they may clear one another (fig. 37). A wooden wedge driven into a groove at the top of each slot is often used to lock the coil in place. With slots nearly closed at the top, the coils are formed by hand by threading the wire

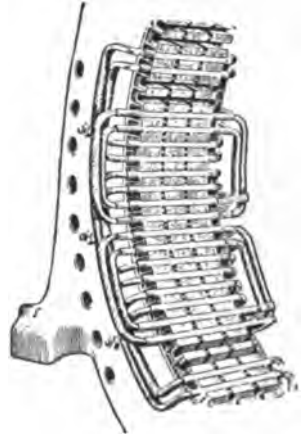

FIG. 38.

¹ For experiments on high-frequency currents, Nikola Tesla constructed an alternator having 384 poles and giving a frequency of about 10,000 (*Journ. Inst. Elec. Eng.* 1892, 21, p. 82). The opposite extreme is found in alternators directly coupled to the Parsons steam-turbine, in which, with a speed of 3000 revs. per min., only two poles are required to give a frequency of 50. By a combination of a Parsons steam-turbine running at 12,000 revs. per min. with an alternator of 140 poles a frequency of 14,000 has been obtained (*Engineering*, 25th of August 1899). For description of an experimental machine for 10,000 cycles per second when running at 3000 revs. per min., see *Trans. Amer. Inst. Elect. Eng.* vol. xxiii, p. 417.

through tubes of mica or specially prepared paper lining the slots; or with single-turn loops, stout bars of copper of U-shape can be driven through the slots and closed by soldered connexions at the other end.

The first experimental determination of the shape of the E.M.F. curve of an alternator was made by J. Joubert in 1880. A revolving contact-maker charged a condenser with the E.M.F. produced by the armature at a particular instant during each period. The condenser was discharged through a ballistic galvanometer, and from the measured throw the instantaneous E.M.F. could be deduced. The contact-maker was then shifted through a small angle, and the instantaneous E.M.F. at the new position corresponding to a different moment in the period was measured; this process was repeated until the E.M.F. curve for a complete period could be traced. Various modifications of the same principle have since been used, and a form of "oscillograph" (p. 8) has been perfected which is well adapted for the purpose of tracing the curves both of E.M.F. and of current. The machine on which Joubert carried out his experiments was a Siemens disk alternator having no iron in its armature, and it was found that the curve of E.M.F. was practically identical with a sine curve. The same law has also been found to hold true for a smooth-core ring or drum armature, but the presence of the iron core enables the armature current to produce greater distorting effect, so that the curves under load may vary considerably from their shape at no load. In toothed armatures, the broken surface of the core, and the still greater reaction from the armature current, may produce wide variations from the sine law, the general tendency being to give the E.M.F. curve a more peaked form. The great convenience of the assumption that the E.M.F. obeys the sine law has led to its being very commonly used as the basis for the mathematical analysis of alternator problems; but any deductions made from this premise require to be applied with caution if they are likely to be modified by a different shape of the curve. Further, the same alternator will give widely different curves even of E.M.F. and still more so of current, according to the nature of the external circuit to which it is connected. As will be explained later, the phase of the current relatively to the E.M.F. depends not only on the inductance of the external circuit, but also upon the inductance and capacity of the external circuit, so that the same current will produce different effects according to the amount by which it lags or leads. The question as to the relative advantages of differently shaped E.M.F. curves has led to much discussion, but can only be answered by reference to the nature of the work that the alternator has to do—i.e. whether it be arc lighting, motor driving, or incandescent lighting through transformers. The shape of the E.M.F. curve is, however, of great importance in one respect, since upon it depends the ratio of the maximum instantaneous E.M.F. to the effective value, and the insulation of the entire circuit, both external and internal, must be capable of withstanding the maximum E.M.F. While the maximum value of the sine curve is $\sqrt{2}$ or 1.414 times the effective value, the maximum value of a Λ curve is 1.732 times the effective value, so that for the same effective E.M.F. the armature wires must not only be more heavily insulated than in the continuous-current dynamo, but also the more peaked the curve the better must be the insulation.

Since an alternating current cannot be used for exciting the field-magnet, recourse must be had to some source of a direct current. This is usually obtained from a small auxiliary

Excitation. continuous-current dynamo, called an *exciter*, which may be an entirely separate machine, separately driven and used for exciting several alternators, or may be driven from the alternator itself; in the latter case the armature of the exciter is often coupled directly to the rotating shaft of the alternator, while its field-magnet is attached to the bed-plate. Although separate excitation is the more usual method, the alternator can also be made self-exciting if a part or the whole of the alternating current is "rectified," and thus converted into a direct current.

The general idea of the polyphase alternator giving two or more E.M.F.'s of the same frequency, but displaced in phase, has been already described. The several phases may be entirely independent, and such was the case with the early polyphase machines of Gramme, who used four independent circuits, and also in the large two-phase alternators designed by J. E. H. Gordon in 1883. If the phases are

thus entirely separate, each requires two collector rings and two wires to its external circuit, i.e. four in all for two-phase and six for three-phase machines. The only advantage of the polyphase machine as thus used is that the whole of the surface of the armature core may be efficiently covered with winding, and the output of the alternator for a given size be thereby increased. It is, however, also possible so to interlink the several circuits of the armature that the necessary number of transmitting lines to the external circuits may be reduced, and also the weight of copper in them for a given loss in the transmission.¹ The condition which obviously

must be fulfilled, for such interlinking of the phases to be possible, is that in the lines which are to meet at any common junction the algebraic sum of the instantaneous currents, reckoned as positive if away from such junction and as negative if towards it, must be zero. Thus if the phases be diagrammatically represented by the relative angular position of the coils in fig. 39, the current in the coils A and B differs in phase from the current in the coils C and D by a quarter of a period or 90°; hence if the two wires *b* and *d* be replaced by the single wire *bd*, this third wire will serve as a common path for the currents of the two phases either outwards or on their return. At any instant the value of the current in the third wire

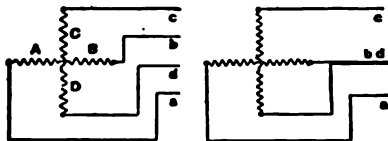

FIG. 39.

must be the vector sum of the two currents in the other wires, and if the shape of the curves of instantaneous E.M.F. and current are identical, and are assumed to be sinusoidal, the effective value of the current in the third wire will be the vector sum of the effective values of the currents in the other wires; in other words, if the system is balanced, the effective current in the third wire is $\sqrt{2}$, or 1.414 times the current in either of the two outer wires. Since the currents of the two phases do not reach their maximum values at the same time, the sectional area of the third wire need not be twice that of the others; in order to secure maximum efficiency by employing the same current density in all three wires, it need only be 40% greater than that of either of the outer wires. The effective voltage between the external leads may in the same way be calculated by a vector diagram, and with the above star connexion the voltage between the outer pair of wires *a* and *c* is $\sqrt{2}$, or 1.414 times the voltage between either of the outer wires and the common wire *bd*. Next, if the four coils are joined up into a continuous helix, just as in the winding of a continuous-current machine, four wires may be attached to equidistant points at the opposite ends of two diameters at right angles to each other (fig. 40). Such a method is known as the *mesh connexion*, and gives a perfectly symmetrical four-phase system of distribution. Four collecting rings are necessary if the armature rotates, and there is no saving in copper in the transmitting lines; but the importance of the arrangement lies in its use in connexion with rotary converters, in which it is necessary that the winding of the armature should form a closed circuit. If *e* = the effective voltage of one phase A, the voltage between any pair of adjacent lines in the diagram is *e*, and between *af* and *e* or *gn* and *d* is $e\sqrt{2}$. The current in any line is the resultant of the currents in the two phases connected to it, and its effective value is $e/\sqrt{2}$, where *c* is the current of one phase.

When we pass to machines giving three phases differing by 120°, the same methods of star and mesh connexion find their analogies. If the current in coil A (fig. 41) is flowing away from the centre, and has its maximum value, the currents in coils B and C are flowing towards the centre, and are each of half the magnitude of the current in A; the algebraic sum of the currents is therefore zero, and this will also be the case for all other instants. Hence the three

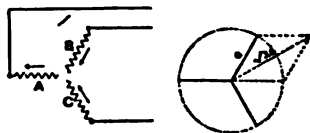

FIG. 41.

coils can be united together at the centre, and three external wires are alone required. In this star or "Y" connexion, if *e* be the effective voltage of each phase, or the voltage between any one of the three collecting rings and the common connexion, the volts between any pair of transmitting lines will be $E = e\sqrt{3}$ (fig. 41); if the load be balanced, the effective current *C* in each of the three lines will be equal, and the total output in watts will be $W = 3Ce = 3CE/\sqrt{3} = 1.732 EC$, or 1.732 times the product of the effective voltage between the lines and the current in any single line. Next, if the three coils are closed upon themselves in a mesh or *delta* fashion (fig. 42), the three transmitting wires may be connected to the junctions of the coils (by means of collecting rings if the armature rotates). The voltage *E* between any pair of wires is evidently

¹ As in the historical transmission of energy from Lauffen to Frankfort (1891).

that generated by one phase, and the current in a fine wire is the resultant of that in two adjacent phases; or in a balanced system, if c be the current in each phase, the current in the line wire beyond a collecting ring is $C = \sqrt{3}c$; hence the watts are $W = 3cE = 3CE/\sqrt{3} = 1.732 cE$, as before. Thus any three-phase winding may be changed over from the star to the delta connexion, and will then give 1.732 times as much current, but only $1/1.732$ times the voltage, so that the output remains the same.

The "armature reaction" of the alternator, when the term is used in its widest sense to cover all the effects of the alternating current in the armature as linked with a magnetic circuit or circuits, may be divided into three items which are different in their origin and consequences. In the first place the armature current produces a self-induced flux in local circuits independent of the main magnetic circuit, as e.g. linked with the ends of the coils as they project outwards from the armature core; such lines may be called "secondary leakage," of which the characteristic feature is that its amount is independent of the position of the coils relatively to the poles. The alternations of this flux give rise to an inductive voltage lagging 90° behind the phase of the current, and this leakage or reactance voltage must be directly counterbalanced electrically by an equal component in the opposite sense in the voltage from the main field. The second and third elements are more immediately magnetic and are entirely dependent upon the position of the coils in relation to the poles. When the side of a drum coil is immediately under the centre of a pole, its ampere-turns are cross-magnetizing, i.e. produce a distortion of the main flux, displacing its maximum density to one or other edge of the pole. When the coil-side is midway between the poles and the axes of coil and pole coincide, the coil stands exactly opposite to the pole and embraces the same magnetic circuit as the field-magnet coils; its turns are therefore directly magnetizing, either weakening or strengthening the main flux according to the direction of the current. In intermediate positions the ampere-turns of the coil gradually pass from cross to direct and vice versa. When the instantaneous values of either the cross or direct magnetizing effect are integrated over a period and averaged, due account being taken of the number of slots per coil-side and of the different phases of the currents in the polyphase machine, expressions are obtained for the equivalent cross and direct ampere-turns of the armature as acting upon a pair of poles. For a given winding and current, the determining factor in either the one or the other is found to be the relative phase angle between the axis of a coil in its position when carrying the maximum current and the centre of a pole, the transverse reaction being proportional to the cosine of this angle, and the direct reaction to its sine. If the external circuit is inductive, the maximum value of the current lags behind the E.M.F. and so behind the centre of the pole; such a negative angle of lag causes the direct magnetizing turns to become back turns, directly weakening the main field and lowering the terminal voltage. Thus, just as in the continuous-current dynamo, for a given voltage under load the excitation between the pole-pieces X_1 must not only supply the net excitation required over the air-gaps, armature core and teeth, but must also balance the back ampere-turns X_2 of the armature.

Evidently therefore the characteristic curve connecting armature current and terminal volts will with a constant exciting current depend on the nature of the load, whether inductive or non-inductive, and upon the amount of inductance already possessed by the armature itself. With an inductive load it will fall more rapidly from its initial maximum value, or, conversely, if the initial voltage is to be maintained under an increasing load, the exciting current will have to be increased more than if the load were non-inductive. In practical working many disadvantages result from a rapid drop of the terminal E.M.F. under increasing load, so that between no load and full load the variation in terminal voltage with constant excitation should not exceed 15%. Thus the output of an alternator is limited either by its heating or by its armature reaction, just as is the output of a continuous-current dynamo; in the case of the alternator, however, the limit set by armature reaction is not due to any sparking at the brushes, but to the drop in terminal voltage as the current is increased, and the consequent difficulty in maintaining a constant potential on the external circuit.

The joint operation of several alternators so that their outputs may be delivered into the same external circuit is sharply distinguished from the corresponding problem in continuous-current dynamo by the necessary condition that they must be in synchronism, i.e. not only must they be so driven that their frequency is the same, but their E.M.F.'s must be in phase or, as it is also expressed, the machines must be in step. Although in practice it is impossible to run two alternators in series unless they are rigidly coupled together—which virtually reduces them to one machine—two or more machines can be run in parallel, as was first described by H. Wilde in 1868 and subsequently redemonstrated by J. Hopkinson and W. G. Adams in 1884. Their E.M.F.'s should be as nearly as possible in syn-

chronism, but, as contrasted with series connexion, parallel coupling gives them a certain power of recovery if they fall out of step, or are not in exact synchronism when thrown into parallel. In such circumstances a synchronizing current passes between the two machines, due to the difference in their instantaneous pressures; and as this current agrees in phase more nearly with the leading than with the lagging machine, the former machine does work as a generator on the latter as a motor. Hence the lagging machine is accelerated and the leading machine is retarded, until their frequencies and phase are again the same.

The chief use of the alternator has already been alluded to. Since it can be employed to produce very high pressures either directly or through the medium of transformers, it is specially adapted to the electrical transmission of energy over long distances.¹ In the early days of electric lighting, the alternate-current system was adopted for a great number of central stations; the machines, designed to give a pressure of 2000 volts, supplied transformers which were situated at considerable distances and spread over large areas, without an undue amount of copper in the transmitting lines. While there was later a tendency to return to the continuous current for central stations, owing to the introduction of better means for economizing the weight of copper in the mains, the alternating current again came into favour, as rendering it possible to place the central station in some convenient site far away from the district which it was to serve. The pioneer central station in this direction was the Deptford station of the London Electric Supply Corporation, which furnished current to the heart of London from a distance of 7 m. In this case, however, the alternators were single-phase and gave the high pressure of 10,000 volts immediately, while more recently the tendency has been to employ step-up transformers and a polyphase system. The advantage of the latter is that the current, after reaching the distant sub-stations, can be dealt with by rotary converters, through which it is transformed into a continuous current. The alternator is also used for welding, smelting in electric furnaces, and other metallurgical processes where heating effects are alone required; the large currents needed therein can be produced without the disadvantage of the commutator, and, if necessary, transformers can be interposed to lower the voltage and still further increase the current. The alternating system can thus meet very various needs, and its great recommendation may be said to lie in the flexibility with which it can supply electrical energy through transformers at any potential, or through rotary converters in continuous-current form.

AUTHORITIES.—For the further study of the dynamo, the following may be consulted, in addition to the references already given:—

General: S. P. Thompson, *Dynamo-Electric Machinery—Continuous-Current Machines* (1904), *Alternating-Current Machinery* (1905, London); G. Kapp, *Dynamos, Alternators and Transformers* (London, 1893); *Id.*, *Electric Transmission of Energy* (London, 1894); *Id.*, *Dynamo Construction; Electrical and Mechanical* (London, 1899); H. F. Parrshall and H. M. Hobart, *Electric Generators* (London, 1900); C. C. Hawkins and F. Wallis, *The Dynamo* (London, 1903); E. Arnold, *Konstruktionstafeln für den Dynamobau* (Stuttgart, 1902); C. P. Steinmetz, *Elements of Electrical Engineering* (New York, 1901).

Continuous-Current Dynamos: J. Fischer-Hinnen, *Continuous-Current Dynamos* (London, 1899); E. Arnold, *Die Gleichstrommaschine* (Berlin, 1902); F. Niehammer, *Berechnung und Konstruktion der Gleichstrommaschinen und Gleichstrommotoren* (Stuttgart, 1904).

Alternators: D. C. Jackson and J. P. Jackson, *Alternating Currents and Alternating Current Machinery* (New York, 1903); J. A. Fleming, *The Alternator Current Transformer* (London, 1899); C. P. Steinmetz, *Alternating Current Phenomena* (New York, 1900); E. Arnold, *Die Wechselstromtechnik* (Berlin, 1904); S. P. Thompson, *Polyphase Electric Currents* (London, 1900); A. Stewart, *Modern Polyphase Machinery* (London, 1906); M. Oudin, *Standard Polyphase Apparatus and Systems* (New York, 1904). (C. C. H.)

¹ In the pioneer three-phase transmission between Laufen and Frankfurt (*Electrician*, vol. xxvi. p. 637, and xxvii. p. 548), the three-phase current was transformed up from about 55 to 8500 volts, the distance being 110 m. A large number of installations driven by water power are now at work, in which energy is transmitted on the alternating-current system over distances of about 100 m. at pressures ranging from 20,000 to 67,000 volts.

Armature reaction in alternators.



FIG. 43.

Use of alternators.

DYNAMOMETER (Gr. *δυναμις*, strength, and *μέτρον*, a measure), an instrument for measuring force exerted by men, animals and machines. The name has been applied generally to all kinds of instruments used in the measurement of a force, as for example electric dynamometers, but the term specially denotes apparatus used in connexion with the measurement of work, or in the measurement of the horse-power of engines and motors. If P represent the average value of the component of a force in the direction of the displacement, s , of its point of application, the product Ps measures the work done during the displacement. When the force acts on a body free to turn about a fixed axis only, it is convenient to express the work done by the transformed product $T\theta$, where T is the average turning moment or torque acting to produce the displacement θ radians. The apparatus used to measure P or T is the dynamometer. The factors s or θ are observed independently. Apparatus is added to some dynamometers by means of which a curve showing the variations of P on a distance base is drawn automatically, the area of the diagram representing the work done; with others, integrating apparatus is combined, from which the work done during a given interval may be read off directly. It is convenient to distinguish between absorption and transmission dynamometers. In the first kind the work done is converted into heat; in the second it is transmitted, after measurement, for use.

Absorption Dynamometers.—Baron Prony's dynamometer (*Ann. Chim. Phys.* 1821, vol. 19), which has been modified in various ways, consists in its original form of two symmetrically shaped timber beams clamped to the engine-shaft. When these are held from turning, their frictional resistance may be adjusted by means of nuts on the screwed bolts which hold them together until the shaft revolves at a given speed. To promote smoothness of action, the rubbing surfaces are lubricated. A weight is moved along the arm of one of the beams until it just keeps the brake steady midway between the stops which must be provided to hold it when the weight fails to do so. The general theory of this kind of brake is as follows:—Let F be the whole frictional resistance, r the common radius of the rubbing surfaces, W the force which holds the brake from turning and whose line of action is at a perpendicular distance R from the axis of the shaft, N the revolutions of the shaft per minute, ω its angular velocity in radians per second; then, assuming that the adjustments are made so that the engine runs steadily at a uniform speed, and that the brake is held still, clear of the stops and without oscillation, by W , the torque T exerted by the engine is equal to the frictional torque Fr acting at the brake surfaces, and this is measured by the static moment of the weight W about the axis of revolution; that is—

$$T = Fr = WR \dots (1)$$

Hence WR measures the torque T .

If more than one force be applied to hold the brake from turning, Fr , and therefore T , are measured by the algebraical sum of their individual moments with respect to the axis. If the brake is not balanced, its moment about the axis must be included. Therefore, quite generally,

$$T = \Sigma WR \dots (2)$$

The factor θ of the product $T\theta$ is found by means of a revolution counter. The power of a motor is measured by the rate at which it works, and this is expressed by $T\omega = \frac{T2\pi N}{60}$ in foot-pounds per second.

or $\frac{T2\pi N}{33,000}$ in horse-power units. The latter is commonly referred to as the "brake horse-power." The maintenance of the conditions of steadiness implied in equation (1) depends upon the constancy of F , and therefore of the coefficient of friction μ between the rubbing surfaces. The heating at the surfaces, the variations in their smoothness, and the variations of the lubrication make μ continuously variable, and necessitate frequent adjustment of W or of the nuts. J. V. Poncelet (1788-1867) invented a form of Prony brake which automatically adjusted its grip as μ changed, thereby maintaining F constant.

The principle of the compensating brake devised by J. G. Appold (1800-1865) is shown in fig. 1. A flexible steel band, lined with wood blocks, is gripped on the motor fly-wheel or pulley by a screw A , which, together with W , is adjusted to hold the brake steady. Compensation is effected by the lever L inserted at B . This has a slotted end, engaged by a pin P fixed to the framing, and it will be seen that its action is to slacken the band if the load tends to rise and to tighten it in the contrary case. The external forces holding the brake from turning are W , distant R from the axis, and the reaction, W_1 , say, of the lever against the fixed pin P , distant R_1 from the axis. The moment of W_1 may be positive or negative.

The torque T at any instant of steady running is therefore $[WR = W_1R_1]$.

Lord Kelvin patented a brake in 1858 (fig. 2) consisting of a rope or cord wrapped round the circumference of a rotating wheel, to one end of which is applied a regulated force, the other

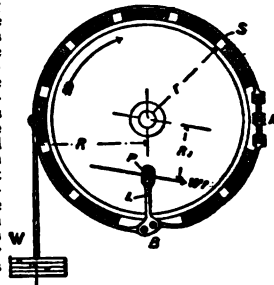

FIG. 1.

changes the weight W rises or falls against the action of the spring balance until a stable condition of running is obtained. The ratio $\frac{W}{p}$ is given by e^{θ} , where $e = 2.718$;

μ is the coefficient of friction and θ the angle, measured in radians, subtended by the arc of contact between the rope and the wheel. In fig. 2 $\theta = 2\pi$. The ratio W/p increases very rapidly as θ is increased, and therefore, by making θ sufficiently large, p may conveniently be made a small fraction of W , thereby rendering errors of observation of the spring balance negligible. Thus this kind of brake, though cheap to make, is, when θ is large enough, an exceedingly accurate measuring instrument, readily applied and easily controlled. It has come into very general use in recent years, and has practically superseded the older forms of block brakes.

It is sometimes necessary to use water to keep the brake wheel cool. Engines specially designed for testing are usually provided with a brake wheel having a trough-shaped rim. Water trickles continuously into the trough, and the centrifugal action holds it as an inside lining against the rim, where it slowly evaporates.

Fig. 3 shows a band-brake invented by Professor James Thomson, suitable for testing motors exerting a constant torque (see *Engineering*, 22nd October 1880).

To maintain e^{θ} constant, compensation for variation of μ is made by inversely varying θ . A and B are fast and loose pulleys, and the brake band is placed partly over the one and partly over the other. Weights W and w are adjusted to the torque. The band turns with the large pulley if μ increase, thereby slightly turning the loose pulley, otherwise at rest, until θ is adjusted to the new value of μ . This form of brake was also invented independently by J. A. M. L. Carpentier, and the principle has been used in the Raffard brake. A self-compensating brake of another kind, by Marcel Deprez, was described with Carpentier's in 1880 (*Bulletin de la société d'encouragement*, Paris). W. E. Ayerton and J. Perry used a band or rope brake in which compensation is effected by the pulley drawing in or letting out a part of the band or rope which has been roughened or in which a knot has been tied.

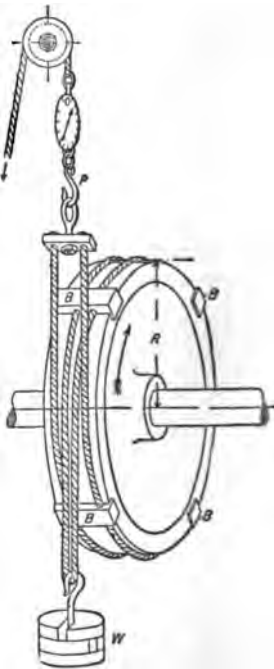

FIG. 2.

In an effective water-brake invented by W. Froude (see *Proc. Inst. M. E.* 1877), two similar castings, A and B , each consisting

of a boss and circumferential annular channel, are placed face to face on a shaft, to which B is keyed, A being free (fig. 4). A ring tube of elliptical section is thus formed. Each channel is divided into a series of pockets by equally spaced vanes inclined at 45°. When A is held still, and B rotated, centrifugal action sets up vortex currents in the water in the pockets; thus a continuous circulation is caused between B and A, and the consequent changes of momentum give rise to oblique reactions. The moments of the components of these actions and reactions in a plane to which the axis of rotation is at right angles are the two aspects of the torque acting, and therefore the torque acting on B through the shaft is measured by the torque required to hold A still.

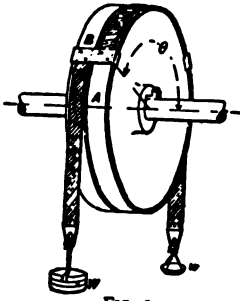

FIG. 3.

Froude constructed a brake to take up 2000 H.P. at 90 revs. per min. by duplicating this apparatus. This replaced the propeller of the ship whose engines were to be tested, and the outer casing was held from turning by a suitable arrangement of levers carried to weighing apparatus conveniently disposed on the wharf. The torque corresponding to 2000 H.P. at 90 revs. per min. is 116,772 foot-pounds, and a brake 5 ft. in diameter gave this resistance. Thin metal sluces were arranged to slide between the wheel and casing, and by their means the range of action could be varied from 300 H.P. at 120 revs. per min. to the maximum.

Professor Osborne Reynolds in 1887 patented a water-brake (see *Proc. Inst. C.E.* 99, p. 167), using Froude's turbine to obtain the highly resisting spiral vortices, and arranging passages in the casing for the entry of water at the hub of the wheel and its exit at the circumference. Water enters at E (fig. 5), and finds its way into the interior of the wheel, A, driving the air in front of it through the air-passages K, K. Then following into the pocketed chambers V₁, V₂, it is caught into the vortex, and finally escapes at the circumference, flowing away at F. The air-ways k, k, in the fixed vanes establish communication between the cores of the vortices and the atmosphere. From ½ to 30 H.P. may be measured at 100 revs. per min. by a brake-wheel of this kind 18 in. in diameter. For other speeds the power varies as the cube of the speed. The casing is held from turning by weights hanging on an attached arm. The cocks regu-

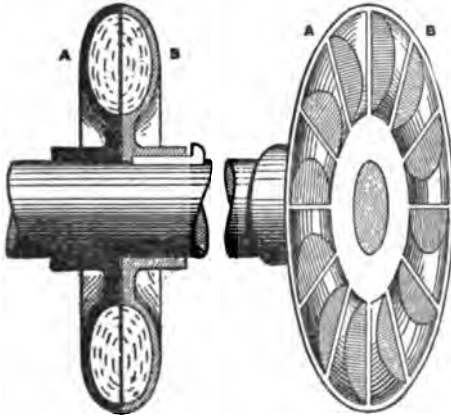

FIG. 4.

lating the water are connected to the casing, so that any tilting automatically regulates the flow, and therefore the thickness of the film in the vortex. In this way the brake may be arranged to maintain a constant torque, notwithstanding variation of the speed. In G. I. Alden's brake (see *Trans. Amer. Soc. Eng. vol. xi.*) the resistance is obtained by turning a cast iron disk against the frictional resistance of two thin copper plates, which are held in a casing free to turn upon the shaft, and are so arranged that the pressure between the rubbing surfaces is controlled, and the heat developed by friction carried away, by the regulated flow of water through the casing. The torque required to hold the casing still against the action of the disk measures the torque exerted by the shaft to which the disk is keyed.

Transmission Dynamometers.—The essential part of many transmission dynamometers is a spring whose deformation indirectly measures the magnitude of the force transmitted through it. For many kinds of spring the change of form is practically proportional to the force, but the relation should always be determined experimentally. General A. J. Morin (see *Notice sur divers appareils dynamométriques*, Paris, 1841), in his classical experiments on this apparatus, arranged his apparatus so that the change in form of the spring was continuously recorded on a sheet of paper drawn under a style. For longer experiments he used a "Compteur" or mechanical integrator, suggested by J. V. Poncelet, from which the work done during a given displacement could be read off directly.

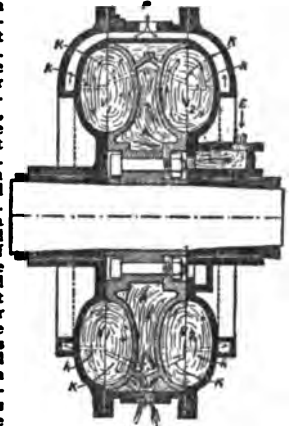

FIG. 5.

This device consists of a roller of radius *r*, pressed into contact with a disk. The two are carried on a common frame, so arranged that a change in form of the spring causes a relative displacement of the disk and roller, the point of contact moving radially from or towards the centre of the disk. The radial distance *x* is at any instant proportional to the force acting through the spring. The angular displacement, θ , of the disk is made proportional to the displacement, *s*, of the point of application of the force by suitable driving gear. If ϕ is the angular displacement of the roller corresponding to displacements, θ of the disk, and *ds* of the point of application of P, *a*, and C constants, then

$$d\phi = \frac{2\pi b}{r} \frac{ds}{r} Pds = C.Pds, \text{ and therefore } \phi = C \int_0^s Pds; \text{ that is, the}$$

angular displacement of the roller measures the work done during the displacement from *s*₁ to *s*₂. The shaft carrying the roller is connected to a counter so that ϕ may be observed. The angular velocity of the shaft is proportional to the rate of working. Morin's dynamometer is shown in fig. 6. The transmitting spring is made up of two flat bars linked at their ends. Their centres *s*₁, *s*₂, are held respectively by the pieces A, B, which together form a sliding pair. The block A carries the disk D, B carries the roller R and counting gear. The pulley E is driven from an axle of the carriage. In a dynamometer used by F. W. Webb to measure the tractive resistance of trains on the London & North-Western railway, a tractive pull or push compresses two spiral springs by a definite amount, which is recorded to scale by a pencil on a sheet of paper, drawn continuously from a storage drum at the rate of 3 in. per mile, by a roller driven from one of the carriage axles. Thus the diagram shows the tractive force at any instant. A second pencil electrically connected to a clock traces a time line on the diagram with a kick at every thirty seconds. A third pencil traces an observation line in which a kick can be made at will by pressing any one of the electrical pushes placed about the car, and a fourth draws a datum line. The spring of the dynamometer car used by W. Dean on the Great Western railway is made up of thirty flat plates, 7 ft. 6 in. long, 5 in. X ½ in. at the centre, spaced by distance pieces nibbed into the plates at the centre and by rollers at the ends. The draw-bar is connected to the buckle, which is carried on rollers, the ends of the spring resting on plates fixed to the under-frame. The gear operating the paper roll is driven from the axle of an independent wheel which is let down into contact with the rail when required. This wheel serves also to measure the distance travelled. A Morin disk and roller integrator is connected with the apparatus, so that the work done during a journey may be read off. Five lines are traced on the diagram.

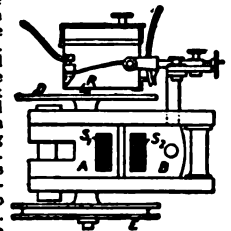

FIG. 6.

In spring dynamometers designed to measure a transmitted torque, the mechanical problem of ascertaining the change of form of the spring is complicated by the fact that the spring and the whole apparatus are rotating together. In the Ayrton and Perry transmission dynamometer or spring coupling of this

the relative angular displacement is proportional to the radius of the circle described by the end of a light lever operated by mechanism between the spring-connected parts. By a device used by W. E. Dalby (*Proc. Inst. C.E.* 1897-1898, p. 132) the change in form of the spring is shown on a fixed indicator, which may be placed in any convenient position. Two equal sprocket wheels Q_1, Q_2 , are fastened, the one to the spring pulley, the other to the shaft. An endless band is placed over them to form two loops, which during rotation remain at the same distance apart, unless relative angular displacement occurs between Q_1 and Q_2 (fig. 7) due to a change in form of the spring. The change in the distance d is proportional to the change in the torque transmitted from the shaft to the pulley. To measure this, guide pulleys are placed in the loops guided by a geometric slide, the one pulley carrying a scale, and the other an index. A recording drum or integrating apparatus may be arranged on the pulley frames. A quick variation, or a periodic variation of the magnitude of the force or torque transmitted through the springs, tends to set up oscillations, and this tendency increases the nearer the periodic time of the force variation

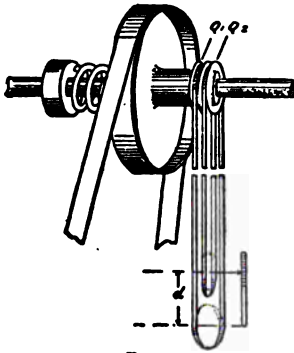

FIG. 7.

approaches a periodic time of the spring. Such vibrations may be damped out to a considerable extent by the use of a dash-pot, or may be practically prevented by using a relatively stiff spring.

Every part of a machine transmitting force suffers elastic deformation, and the force may be measured indirectly by measuring the deformation. The relation between the two should in all cases be found experimentally. G. A. Hirn (see *Les Pandynamètres*, Paris, 1876) employed this principle to measure the torque transmitted by a shaft. Signor Kosio used a telephonic method to effect the same end, and mechanical, optical and telephonic devices have been utilized by the Rev. F. J. Jervis-Smith. (See *Phil. Mag.* February 1898.)

H. Frahm,¹ during an important investigation on the torsional vibration of propeller shafts, measured the relative angular displacement of two flanges on a propeller shaft, selected as far apart as possible, by means of an electrical device (*Engineering*, 6th of February 1903). These measurements were utilized in combination with appropriate elastic coefficients of the material to find the horse-power transmitted from the engines along the shaft to the propeller. In this way the effective horse-power and also the mechanical efficiency of a number of large marine engines, each of several thousand horse-power, have been determined.

When a belt, in which the maximum and minimum tensions are respectively P and p lb, drives a pulley, the torque exerted

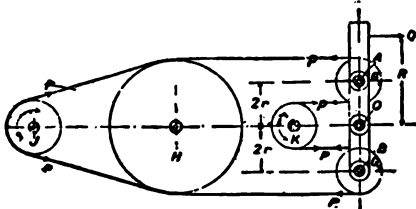

FIG. 8.

is $(P-p)r$ lb ft., r being the radius of the pulley plus half the thickness of the belt. P and p may be measured directly by leading the belt round two freely hanging guide pulleys, one in the tight, the other in the slack part of the belt, and adjusting loads on them until a stable condition of running is obtained. In W. Froude's belt dynamometer (see *Proc. Inst. M.E.*, 1858) (fig. 8) the guide pulleys G_1, G_2 are carried upon an arm free to turn about the axis O . H is a pulley to guide the approaching and receding parts of the belt to and from the beam in parallel directions. Neglecting friction, the

unbalanced torque acting on the beam is $4r(P-p)$ lb ft. If a force Q acting at R maintains equilibrium, $QR/4 = (P-p)r = T$. Q is supplied by a spring, the extensions of which are recorded on a drum driven proportionally to the angular displacement of the driving pulley; thus a work diagram is obtained. In the Farcot form the guide pulleys are attached to separate weighing levers placed horizontally below the apparatus. In a belt dynamometer built for the Franklin Institute from the designs of Tatham, the weighing levers are separate and arranged horizontally at the top of the apparatus. The weighing beam in the Helner-Alteneck dynamometer is placed transversely to the belt (see *Electrotechnischen Zeitschrift*, 1881, 7). The force Q , usually measured by a spring, required to maintain the beam in its central position is proportional to $(P-p)$. If the angle $\theta = \theta_0 = 120^\circ$, $Q = (P-p)$ neglecting friction.

When a shaft is driven by means of gearing the driving torque is measured by the product of the resultant pressure P acting between the wheel teeth and the radius of the pitch circle of the wheel fixed to the shaft. Fig. 9, which has been reproduced from J. White's *A New Century of Inventions* (Manchester, 1822), illustrates possibly the earliest application of this principle to dynamometry. The wheel D , keyed to the shaft overcoming the resistance to be measured, is driven from wheel N by two bevel wheels L, L , carried in a loose pulley K . The two shafts, though in a line, are independent. A torque applied to the shaft A can be transmitted to D , neglecting friction, without change only if the central pulley K is held from turning; the torque required to do this is twice the torque transmitted.

The torque acting on the armature of an electric motor is necessarily accompanied by an equal and opposite torque acting on the

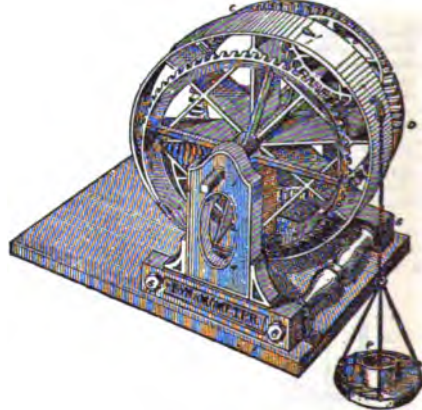

FIG. 9.

frame. If, therefore, the motor is mounted on a cradle free to turn about knife-edges, the reacting torque is the only torque tending to turn the cradle when it is in a vertical position, and may therefore be measured by adjusting weights to hold the cradle in a vertical position. The rate at which the motor is transmitting work is then

$12\pi n$ H.P., where n is the revolutions per second of the armature.

See James Dredge, *Electric Illumination*, vol. ii. (London, 1885); W. W. Beaumont, "Dynamometers and Friction Brakes," *Proc. Inst. C.E.* vol. xcv. (London, 1889); E. Brauer, "Über Bremsdynamometer und verwandte Kraftmesser," *Zeitschrift des Vereins deutscher Ingenieure* (Berlin, 1888); J. J. Flather, *Dynamometers and the Measurement of Power* (New York, 1893). (W. E. D.)

DYNASTY (Gr. *δυναστεία*, sovereignty, the position of a *huvarkopis*, lord, ruler, from *δύναμις*, to be able, *δύναμις*, power), a family or line of rulers, a succession of sovereigns of a country belonging to a single family or tracing their descent to a common ancestor. The term is particularly used in the history of ancient Egypt as a convenient means of arranging the chronology.

DYSART, a royal and police burgh and seaport of Fifeshire, Scotland, on the shore of the Firth of Forth, 2 m. N.E. of Kirkcaldy by the North British railway. Pop. (1901) 3562. It has a quaint old-fashioned appearance, many ancient houses in High Street bearing inscriptions and dates. The public buildings include a town hall, library, cottage hospital, mechanics' institute and memorial hall. Scarcely anything is left of the old chapel dedicated to St Dennis, which for a time was used as a

¹H. Frahm, "Neue Untersuchungen über die dynamischen Vorgänge in den Wellenleitungen von Schiffsmaschinen mit besonderer Berücksichtigung der Resonanzschwingungen," *Zeitschrift des Vereins deutscher Ingenieure*, 31st May 1902.

smithy; and of the chapel of St Serf, the patron saint of the burgh, only the tower remains. The chief industries are the manufacture of bed and table linen, towelling and woollen cloth, shipbuilding and flax-spinning. There is a steady export of coal, and the harbour is provided with a wet dock and patent slip. In smuggling days the "cauty carles" of Dysart were professed "free traders." In the 15th and 16th centuries the town was a leading seat of the salt industry ("salt to Dysart" was the equivalent of "coals to Newcastle"), but the salt-pans have been abandoned for a considerable period. Nail-making, once famous, is another extinct industry. During the time of the alliance between Scotland and Holland, which was closer in Fifeshire than in other counties, Dysart became known as Little Holland. To the west of the town is Dysart House, the residence of the earl of Rosalyn. With Burntisland and Kinghorn Dysart forms one of the Kirkcaldy district group of parliamentary burghs. The town is mentioned as early as 874 in connexion with a Danish invasion. Its name is said to be a corruption of the Latin *desertum*, "a desert," which was applied to a cave on the seashore occupied by St Serf. In the cave the saint held his famous colloquy with the devil, in which Satan was worsted and contemptuously dismissed. From James V. the town received the rights of a royal burgh. In 1559 it was the headquarters of the Lords of the Congregation, and in 1607 the scene of the meetings of the synod of Fife known as the Three Synods of Dysart. Ravensburgh Castle, on the shore to the west of the town, is the Ravensraig of Sir Walter Scott's ballad of "Rosabelle."

William Murray, a native of the place, was made earl of Dysart in 1643, and his eldest child and heir, a daughter, Elizabeth, obtained in 1670 a regnant of the title, which passed to the descendants of her first marriage with Sir Lionel Tollemache, Bart., of Helmingham; she married secondly the 1st duke of Lauderdale, but had no children by him, and died in 1698. This countess of Dysart (afterwards duchess of Lauderdale) was a famous beauty of the period, and notorious both for her amours and for her political influence. She was said to have been the mistress of Oliver Cromwell, and also of Lauderdale before her first husband's death, and was a leader at the court of Charles II. Wycherley is supposed to have aimed at her in his *Widow Blackacre* in the *Plain Dealer*. Her son, Lionel Tollemache (d. 1717), transmitted the earldom to his grandson Lionel (d. 1770), whose sons Lionel (d. 1799) and Wilbraham (d. 1831) succeeded; they died without issue, and their sister Louisa (d. 1840), who married John Manners, an illegitimate son of the second son of the 2nd duke of Rutland, became countess in her own right, being succeeded by her grandson (d. 1878), and his grandson, the 8th earl.

The earldom of Dysart must not be confounded with that of Desart (Irish), created (barony 1733) in 1793, and held in the Cuffe family, who were originally of Creech St Michael, Somerset, the Irish branch dating from Queen Elizabeth's time.

DYSENTERY (from the Gr. prefix *δυσ-*, in the sense of "bad," and *εντερον*, the intestine), also called "bloody flux," an infectious disease with a local lesion in the form of inflammation and ulceration of the lower portion of the bowels. Although at one time a common disease in Great Britain, dysentery is now very rarely met with there, and is for the most part confined to warm countries, where it is the cause of a large amount of mortality. (For the pathology see DIGESTIVE ORGANS.)

Recently considerable advance has been made in our knowledge of dysentery, and it appears that there are two distinct types of the disease: (1) amoebic dysentery, which is due to the presence of the amoeba histolytica (of Schaudinn) in the intestine; (2) bacillary dysentery, which has as causative agent two separate bacteria, (a) that discovered by Shiga in Japan, (b) that discovered by Flexner in the Philippine Islands. With regard to the bacillary type, at first both organisms were considered to be identical, and the name *bacillus dysenteriae* was given to them; but later it was shown that these bacilli are different, both in regard to their cultural characteristics and also in that one (Shiga) gives out a soluble toxin, whilst the

other has so far resisted all efforts to discover it. Further, the serum of a patient affected with one of the types has a marked agglutinative power on the variety with which he is infected and not on the other.

Clinically, dysentery manifests itself with varying degrees of intensity, and it is often impossible without microscopic examination to determine between the amoebic and bacillary forms. In well-marked cases the following are the chief symptoms. The attack is commonly preceded by certain premonitory indications in the form of general illness, loss of appetite, and some amount of diarrhoea, which gradually increases in severity, and is accompanied with griping pains in the abdomen (tormina). The discharges from the bowels succeed each other with great frequency, and the painful feeling of pressure downwards (tenesmus) becomes so intense that the patient is constantly desiring to defecate. The matters passed from the bowels, which at first resemble those of ordinary diarrhoea, soon change their character, becoming scanty, mucous or slimy, and subsequently mixed with, or consisting wholly of, blood, along with shreds of exudation thrown off from the mucous membrane of the intestine. The evacuations possess a peculiarly offensive odour characteristic of the disease. Although the constitutional disturbance is at first comparatively slight, it increases with the advance of the disease, and febrile symptoms come on attended with urgent thirst and scanty and painful flow of urine. Along with this the nervous depression is very marked, and the state of prostration to which the patient is reduced can scarcely be exceeded. Should no improvement occur death may take place in from one to three weeks, either from repeated losses of blood, or from gradual exhaustion consequent on the continuance of the symptoms, in which case the discharges from the bowels become more offensive and are passed involuntarily.

When, on the other hand, the disease is checked, the signs of improvement are shown in the cessation of the pain, in the evacuations being less frequent and more natural, and in relief from the state of extreme depression. Convalescence is, however, generally slow, and recovery may be imperfect—the disease continuing in a chronic form, which may exist for a variable length of time, giving rise to much suffering, and not unfrequently leading to an ultimately fatal result.

The dysentery poison appears to exert its effects upon the glandular structures of the large intestine, particularly in its lower part. In the milder forms of the disease there is simply a congested or inflamed condition of the mucous membrane, with perhaps some inflammatory exudation on its surface, which is passed off by the discharges from the bowels. But in the more severe forms ulceration of the mucous membrane takes place. Commencing in and around the solitary glands of the large intestine in the form of exudations, these ulcers, small at first, enlarge and run into each other, till a large portion of the bowel may be implicated in the ulcerative process. Should the disease be arrested these ulcers may heal entirely, but occasionally they remain, causing more or less disorganization of the coats of the intestines, as is often found in chronic dysentery. Sometimes, though rarely, the ulcers perforate the intestines, causing rapidly fatal inflammation of the peritoneum, or they may erode a blood vessel and produce violent haemorrhage. Even where they undergo healing they may cause such a stricture of the calibre of the intestinal canal as to give rise to the symptoms of obstruction which ultimately prove fatal. One of the severest complications of the disease is abscess of the liver, usually said to be solitary, and known as tropical abscess of the liver, but probably is more frequently multiple than is usually thought.

Treatment.—Where the disease is endemic or is prevailing epidemically, it is of great importance to use all preventive measures, and for this purpose the avoidance of all causes likely to precipitate an attack is to be enjoined. Exposure to cold after heat, the use of unripe fruit, and intemperance in eating and drinking should be forbidden; and the utmost care taken as to the quality of the food and drinking water. In houses or hospitals where cases of the disease are under treatment, disinfectants should be freely employed, and the evacuations of the

patients removed as speedily as possible, having previously been sterilized in much the same manner as is employed in typhoid fever. In the milder varieties of this complaint, such as those occurring sporadically, and where the symptoms are probably due to matters in the bowels setting up the dysenteric irritation, the employment of diaphoretic medicines is to be recommended, and the administration of such a laxative as castor oil, to which a small quantity of laudanum has been added, will often, by removing the source of the mischief, arrest the attack; but a method of treatment more to be recommended is the use of salines in large doses, such as one drachm of sodium sulphate from four to eight times a day. This treatment may with advantage be combined with the internal administration of ipecacuanha, which still retains its reputation in this disease. Latterly, free irrigation of the bowel with astringents, such as silver nitrate, tannalbin, &c., has been attended with success in those cases which have been able to tolerate the injections. In many instances they cannot be used owing to the extreme degree of irritability of the bowel. The operation of appendicectomy, or bringing the appendix to the surface and using it as the site for the introduction of the irrigating fluid, has been attended with considerable success.

In those cases due to Shiga's bacillus the ideal treatment has been put at our disposal by the preparation of a specific antitoxin; this has been given a trial in several grave epidemics of late, and may be said to be the most satisfactory treatment and offer the greatest hope of recovery. It is also of great use as a prophylactic.

The preparations of morphia are of great value in the symptomatic treatment of the disease. They may be applied externally as fomentations, for the relief of tormina; by rectal injection for the relief of the tenesmus and irritability of the bowel; hypodermically in advanced cases, for the relief of the general distress. In amoebic dysentery, warm injections of quinine *per rectum* have proved very efficacious, are usually well tolerated, and are not attended with any ill effects. The diet should be restricted, consisting chiefly of soups and farinaceous foods; more especially is this of importance in the chronic form. For the thirst ice may be given by the mouth. Even in the chronic forms, confinement to bed and restriction of diet are the most important elements of the treatment. Removal from the hot climate and unhygienic surroundings must naturally be attended to.

BIBLIOGRAPHY.—Allbutt and Rolleston, *System of Medicine*, vol. ii. part ii. (1907); "Dysentery," Drs Andrew Davidson and Simon Flexner; Davidson, *Hygiene and Diseases of Warm Climates* (Edinburgh, 1903); Fearnside in *Ind. Med. Gaz.* (July 1905); Ford in *Journal of Tropical Medicine* (July 15, 1904); Korentschewsky in *Bulletin de l'Institut Pasteur* (February 1905); Shiga: Oster and M'Crac's *System of Medicine*, vol. ii. p. 781 (1907); Skachivan and Stefansky in *Beihener klinische Wochenschrift* (February 11, 1907); Vaillard and Dopfer, on the treatment by antidyenteric serum, *Annales de l'Institut Pasteur*, No. 3, p. 326 (1906); J. A. Pottinger, "Appendicectomy in Chronic Dysentery," *Lancet*, J. December 28, 1907; Robert Doerr, *Das Dysenteriesyndrom* (Gustav Fischer, Jena, 1907); F. M. Sandwith, "Hunterian Lecture on the Treatment of Dysentery," *Lancet* (December 7, 1907).

DYSPEPSIA (from the Gr. prefix *δυσ-*, hard, ill, and *πέψω*, to digest), or indigestion, a term vaguely given to a group of pathological symptoms. There are comparatively few diseases of any moment where some of the phenomena of dyspepsia are not present as associated symptoms, and not infrequently these exist to such a degree as to mask the real disease, of which they are only complications. This is especially the case in many organic diseases of the alimentary canal, in which the symptoms of dyspepsia are often the most prominent. In its restricted meaning, however (and it is to this that the present article applies), the term is used to describe a functional derangement of the natural process of digestion, apart from any structural change in the organs concerned in the act.

The causes of this trouble may be divided into (a) those which concern the food, and (b) those which concern the organism. Among the causes connected with the food are not only the indulgence in indigestible articles of diet, but the too common

practice of eating too much of what may be otherwise quite wholesome and digestible, and irregular, too frequent or too infrequent meals. The quantity of food required by different individuals varies between wide limits, but also the quantity required by the same individual varies considerably according to circumstances, more food being needed in cold than in warm weather, and more in an active open-air occupation than in a sedentary one. The thorough mastication of the food is a very important precursor of digestion,¹ and this only too often fails, either owing to haste over meals or because of painful or deficient teeth. Again, the quality of the food is of importance, some kinds of flesh being harder and more difficult of mastication than others. This is especially the case with meat that has been smoked or salted, and with that cooked too soon after the death of the animal. Drinks are a common source of dyspepsia. Beer when new and its fermentation not completed is especially bad. Vinegar and acid wines, if taken in large quantities, tend to produce gastric catarrh, and tea is a very fruitful source of this trouble. Even too much water at meal-times may cause indigestion, since the food in the mouth is apt to be softened by the water instead of saliva, and also the gastric juice becomes unduly diluted, rendering the digestion in the stomach too slow and prolonged. Carious teeth and oral sepsis, from whatsoever cause, lead to the same trouble.

Of the causes which concern the organism, nervous influences come first. Bad news may take away all power of digestion and even provoke vomiting, and any worry or mental trouble tends to bring on this condition. General weakness and atony of the body affects the stomach in like degree, and, if the muscles of the abdominal wall be much wasted, they become too weak to support the abdominal viscera in place. Hence results a general tendency for these organs to fall, giving rise to a condition of visceroptosis, of which an obstinate dyspepsia is a very marked feature. Adhesions of the intestines from old inflammatory troubles, floating kidney and bad circulation may each be a cause of painful digestion. Again, a dyspepsia that will not yield to treatment is often one of the symptoms of renal disease, or, in young people of fifteen to twenty years of age, it may be the earliest sign of a gouty diathesis, or even of a more serious condition still—incipient phthisis. Chronic dyspepsia, by weakening the organism, renders it more liable to fall a prey to the attacks of the tubercle bacillus, but, on the other hand, the tuberculous lesion in the lung is often accompanied by a most intractable form of dyspepsia. From this it is clear that any condition which lessens the general well-being of the organism as a whole, apart from its producing any permanent morbid condition in the stomach, may yet interfere with the normal digestive processes and so give rise to dyspepsia.

The symptoms of dyspepsia, even when due to a like cause, are so numerous and diversified in different individuals that probably no description could exactly represent them as they occur in any given case. All that can be here attempted is to mention some of the more prominent morbid phenomena usually present in greater or less degree.

Very briefly, a furred tongue, foul breath, disturbance of appetite, nausea and vomiting, oppression in the chest, pain, flatulence and distension, acidity, pyrosis and constipation or diarrhoea are a few of the commonest symptoms.

When the attack is dependent on some error in diet, and the dyspepsia consequently more of an acute character, there is often pain followed with sickness and vomiting of the offensive matters, after which the patient soon regains his former healthy state. What are commonly known as "bilious attacks" are frequently of this character. In the more chronic cases of dyspepsia the symptoms are somewhat different. A sensation of discomfort comes on shortly after a meal, and is more of the nature of weight and distension in the stomach than of actual pain, although this too may be present. These feelings may come

¹This aspect of the matter—"buccal digestion"—has been specially emphasized in recent years by Horace Fletcher of the United States, whose experience of the results of systematic "chewing," confirmed by Sir M. Foster, Prof. Chittenden and others, has almost revolutionized the science of dietetics.

on after each meal, or only after certain meals, and they may arise irrespective of the kind of food taken, or only after certain articles of diet. As in most of such cases the food is long retained in the stomach, it is apt to undergo fermentive changes, one of the results of which is the accumulation of gases which cause flatulence and eructations of an acid or foul character. Occasionally quantities of hot, sour, tasteless or bitter fluid—pyrosis—or mouthfuls of half-digested food, regurgitate from the stomach. Temporary relief may be obtained when another meal is taken, but soon the uncomfortable sensations return as before. The appetite may be craving or deficient, or desirous of abnormal kinds of food. The tongue registers the gastric condition with great delicacy:—a pasty white fur on the tongue is considered a sign of weakness or atony of the digestive tract; a clean pointed tongue with large papillae, and rather red at the edges and tip, is a sign of gastric irritation; and a pale flabby tongue suggests the need of stimulating treatment. Constipation is more common in the chronic forms of dyspepsia, diarrhoea in the acute.

Numerous disagreeable and painful sensations in other parts are experienced, and are indeed often more distressing than the merely gastric symptoms. Pains in the chest, shortness of breathing, palpitation, headache, giddiness, affections of vision, coldness of the extremities, and general languor are common accompaniments of dyspepsia; while the nervous phenomena are specially troublesome in the form of sleeplessness, irritability, despondency and hypochondriasis.

As regards *treatment* only a few general observations can be made. The careful arrangement of the diet is a matter of first importance. Quantity must be regulated by the digestive capabilities of the individual, his age, and the demands made upon his strength by work. There is little doubt that the danger is in most instances on the side of excess, and the rule which enjoins the cessation from eating before the appetite is satisfied is a safe one for dyspeptics. Due time, too, must be given for the digestion of a meal, and from four to six hours are in general required for this purpose. Long fasts, however, are nearly as hurtful as too frequent meals. Of no less importance is the kind of food taken, and on this point those who suffer from indigestion must ever exercise the greatest care. It must be borne in mind that idiosyncrasy often plays an important part in digestion, some persons being unable to partake without injury of substances which are generally regarded as wholesome and digestible. In most cases it is found very helpful to separate the protein from the farinaceous food, and the more severe the dyspepsia the more thoroughly should this be done, only relaxing as the dyspepsia yields. No fluid should be drunk at meal-times, but from one to two tumblers of hot water should be drunk from an hour to an hour and a half before food. This washes any remnant of the last meal from the stomach, and also supplies material for the free secretion of saliva and gastric juice, thus promoting and accelerating digestion. The only exception to this is in the case of a dilated stomach, when it is wholly contra-indicated. With regard to mastication, Sir Andrew Clark's rule is a very good one, and is more easily followed than the ideal theory laid down by Horace Fletcher, according to whom any food is digestible if properly treated while still in the mouth. Clark's rule is that as the mouth normally contains thirty-two teeth, thirty-two bites should be given before the food is swallowed. This, of course, is a practical doctor's concession to human weakness. Mr Fletcher would train every one to "chew" till the contents of the mouth were swallowed by reflex action without deliberate act; and he applies this theory of mastication and salivation also to drinks (except water). Again, a lack of warmth being a source of dyspepsia, this should be attended to, the back of the neck, the front of the abdomen and the feet being the parts that require special attention. The feet should be raised on a stool, the ankles protected with warm stockings and a woollen "cummerbund" wound two or three times round the body. Experience has shown that in this complaint no particular kind of food or avoidance of food is absolutely to be relied on, but that in general the best diet is one of a mixed animal and vege-

table kind, simply but well cooked. The partaking of many dishes, of highly-seasoned or salted meats, raw vegetables, newly-baked bread, pastry and confectionery are all well-known common causes of dyspepsia, and should be avoided. When even the simple diet usually taken is found to disagree, it may be necessary to change it temporarily for a still lighter form, such as a milk diet, and that even in very moderate quantity.

The employment of alcoholic stimulants to assist digestion is largely resorted to, both with and without medical advice. While it seems probable that in certain cases of atonic dyspepsia, particularly in the feeble and aged, the moderate administration of alcohol has the effect of stimulating the secretion of gastric juice, and is an important adjuvant to other remedies, the advantages of its habitual use as an aid to digestion by the young and otherwise healthy, is more than questionable, and it will generally be found that among them, those are least troubled with indigestion who abstain from it. Rest should be taken both before and after food, and general hygienic measures are highly important, since whatever improves the state of the health will have a favourable influence on digestion. Hence regular exercise in the open air, early rising and the cold bath are to be strongly recommended.

The medicinal treatment of dyspepsia can only be undertaken by a physician, but the following is a very brief resumé of the drugs he depends on to-day. Bicarbonate of soda with some bitter, as quassia, gentian or columba, is much in vogue as a direct gastric stimulant. In irritable dyspepsia some form of bismuth in solution or powder; and, to assist digestion through the nervous system, nux vomica and strychnine can be relied on. To give directly digestive material, hydrochloric acid, pepsin and rennet are prescribed in many forms, but where there is much vomiting ingluvin is more efficacious than pepsin. When farinaceous food is badly borne, diastase is helpful, given either before or with the meal. To prevent fermentation, phenol, creasote and sulpho-carbolate of soda are all extremely useful in skilled hands; and for intestinal decomposition and flatulent distension, bismuth salicylate with salol or β -naphthol is much used. Cyllin, and charcoal in many forms, may be taken both for gastric and intestinal flatulence. But all these drugs, of proved value though they are, must be modified and combined to suit the special idiosyncrasy of the patient, and are therefore often worse than useless in inexperienced hands. The condition of the bowels must always have due attention.

See also DIGESTIVE ORGANS; NUTRITION AND DIETETICS.

DYSTELEOLOGY, a modern word invented by Haeckel (*Evolution of Man*) for the doctrine of purposelessness, as opposed to the philosophical doctrine of design (Telology).

DZUNGARIA, **DSONGARIA**, or **JUNGARIA**, a former Mongolian kingdom of Central Asia, raised to its highest pitch by Kaldan or Bushtu Khan in the latter half of the 17th century, but completely destroyed by Chinese invasion about 1757-1759. It has played an important part in the history of Mongolia and the great migrations of Mongolian stems westward. Now its territory belongs partly to the Chinese empire (east Turkestan and north-western Mongolia) and partly to Russian Turkestan (provinces of Semirychensk and Semipalatinsk). It derived its name from the Dsongars, or Songars, who were so called because they formed the left wing (*dson*, left; *gar*, hand) of the Mongolian army. Its widest limit included Kashgar, Yarkand, Khotan, the whole region of the T'ien Shan, or Tian-shan, Mountains, and in short the greater proportion of that part of Central Asia which extends from 35° to 50° N. and from 72° to 97° E. The name, however, is more properly applied only to the present Chinese province of T'ien Shan-pei-lu and the country watered by the Ili. As a political or geographical term it has practically disappeared from the map; but the range of mountains stretching north-east along the southern frontier of the Land of the Seven Streams, as the district to the south-east of the Balkhash Lake is called, preserves the name of Dzungarian Range.

E The fifth symbol in the English alphabet occupies also the same position in Phoenician and in the other alphabets descended from Phoenician. As the Semitic alphabets did not represent vowels, E was originally an aspirate. Its earliest form, while writing is still from right to left, is \aleph , the upright being continued some distance below the lowest of the cross-strokes. In some of the Greek alphabets it appears as ϵ with the upright prolonged at both top and bottom, but it soon took the form with which we are familiar, though in the earlier examples of this form the cross-strokes are not horizontal but drop at an angle, ϵ . In Corinth and places under its early influence like Megara, or colonised from it like Corcyra, the symbol for ϵ takes the form β or B , while at Sicily in the 6th and 5th centuries B.C. it is represented by λ . In early Latin it was sometimes represented by two perpendicular strokes of equal length, II .

In the earliest Greek inscriptions and always in Latin the symbol E represented both the short and the long e -sound. In Greek also it was often used for the close long sound which arose either by contraction of two short e -sounds or by the loss of a consonant, after a short e -sound, as in $\phi\lambda\epsilon\iota\upsilon\epsilon$, "you love," for $\phi\lambda\epsilon\iota\epsilon\upsilon\epsilon$, and $\phi\epsilon\alpha\upsilon\epsilon\upsilon\delta\epsilon$, "bright," out of an earlier $\phi\epsilon\alpha\upsilon\epsilon\upsilon\delta\epsilon$. The Ionian Greeks of Asia Minor, who had altogether lost the aspirate, were the first to use the symbol H for the long e -sound, and in official documents at Athens down to 403 B.C., when the Greek alphabet as still known was adopted by the state, E represented ϵ , η and the sound arising by contraction or consonant loss as mentioned above which henceforth was written with two symbols, ϵ , and being really a single sound is known as the "spurious diphthong." There were some minor distinctions in usage of the symbols E and H which need not here be given in detail. The ancient Greek name was ϵ , not *Epsilon* as popularly supposed; the names of the Greek letters are given from Kallias, an earlier contemporary of Euripides, in Athenaeus x. p. 453 d.

In Greek the short e -sound to which E was ultimately limited was a close sound inclining more towards i than ϵ ; hence the representation of the contraction of $\epsilon\epsilon$ by ϵ . Its value in Latin was exactly the opposite, the Latin short e being open, and the long close. In English there has been a gradual narrowing of the long vowels, ϵ becoming approximately ϵ_i and ϵ becoming i (Sweet, *History of English Sounds*, §§ 781, 817 ff. 2nd ed.). In languages where the diphthong ϵi has become a monophthong, the resulting sound is some variety of long e . Often the gradual assimilation can be traced through the intermediate stage of $\epsilon\epsilon$ to ϵ_i , as in the Old Latin *aidiilis*, which in classical Latin is *aidiilis*, and in medieval MSS. *aidiilis*.

The variety of spelling in English for the long and short e -sounds is conveniently illustrated in Miss Soames's *Introduction to the Study of Phonetics*, pp. 16 and 20. (P. Gl.)

EA (written by means of two signs signifying "house" and "water"), in the Babylonian religion, originally the patron deity of Eridu, situated in ancient times at the head of the Persian Gulf, but now, by reason of the constant accumulation of soil in the Euphrates valley, at some distance from the gulf. Eridu, meaning "the good city," was one of the oldest settlements in the Euphrates valley, and is now represented by the mounds known as Abu Shahrein. In the absence of excavations on that site, we are dependent for our knowledge of Ea on material found elsewhere. This is, however, sufficient to enable us to state definitely that Ea was a water-deity, and there is every reason to believe that the Persian Gulf was the body of water more particularly sacred to him. Whether Ea (or A-e as some scholars prefer) represents the real pronunciation of his name we do not know. All attempts to connect Ea with Yah and Yahweh are idle conjectures without any substantial basis. He is figured as a man covered with the body of a fish, and this

representation, as likewise the name of his temple E-apu, "house of the watery deep," points decidedly to his character as a god of the waters (see OANNES). Of his cult at Eridu, which reverts to the oldest period of Babylonian history, nothing definite is known beyond the fact that the name of his temple was E-saggila, "the lofty house"—pointing to a staged tower as in the case of the temple of Bel (ϵ .s.) at Nippur, known as E-Kur, i.e. "mountain house"—and that incantations, involving ceremonial rites, in which water as a sacred element played a prominent part, formed a feature of his worship. Whether Eridu at one time also played an important political rôle is not certain, though not improbable. At all events, the prominence of the Ea cult led, as in the case of Nippur, to the survival of Eridu as a sacred city, long after it had ceased to have any significance as a political centre. Myths in which Ea figures prominently have been found in Assur-bani-pal's library, indicating that Ea was regarded as the protector and teacher of mankind. He is essentially a god of civilization, and it was natural that he was also looked upon as the creator of man, and of the world in general. Traces of this view appear in the Marduk epic celebrating the achievements of this god, and the close connexion between the Ea cult at Eridu and that of Marduk also follows from two considerations: (1) that the name of Marduk's sanctuary at Babylon bears the same name, E-saggila, as that of Ea in Eridu, and (2) that Marduk is generally termed the son of Ea, who derives his powers from the voluntary abdication of the father in favour of his son. Accordingly, the incantations originally composed for the Ea cult were re-edited by the priests of Babylon and adapted to the worship of Marduk, and, similarly, the hymns to Marduk betray traces of the transfer of attributes to Marduk which originally belonged to Ea.

It is, however, more particularly as the third figure in the triad, the two other members of which were Anu (ϵ .s.) and Bel (ϵ .s.), that Ea acquires his permanent place in the pantheon. To him was assigned the control of the watery element, and in this capacity he becomes the *shar apsi*, i.e. king of the Apsu or "the deep." The Apsu was figured as an ocean encircling the earth, and since the gathering place of the dead, known as Aralu, was situated near the confines of the Apsu, he was also designated as En-Ki, i.e. "lord of that which is below," in contrast to Anu, who was the lord of the "above" or the heavens. The cult of Ea extended throughout Babylonia and Assyria. We find temples and shrines erected in his honour, e.g. at Nippur, Girsu, Ur, Babylon, Sippar and Nineveh, and the numerous epithets given to him, as well as the various forms under which the god appears, alike bear witness to the popularity which he enjoyed from the earliest to the latest period of Babylonian-Assyrian history. The consort of Ea, known as Damkina, "lady of that which is below," or Nin-Ki, having the same meaning, or Damgal-nunna, "great lady of the waters," represents a pale reflection of Ea and plays a part merely in association with her lord. (M. J. A.)

EABANI, the name of the friend of Gilgamesh, the hero in the Babylonian epic (see GILGAMESH, EPIC OF). Eabani, whose name signifies "Ea creates," pointing to the tradition which made the god Ea (ϵ .s.) the creator of mankind, is represented in the epic as the type of the primeval man. He is a wild man who lives with the animals of the field until lured away from his surroundings by the charms of a woman. Created to become a rival to Gilgamesh, he strikes up a friendship with the hero, and together they proceed to a cedar forest guarded by Khumbaba, whom they kill. The goddess Irina (a form of Ishtar, ϵ .s.) in revenge kills Eabani, and the balance of the epic is taken up with Gilgamesh's lament for his friend, his wanderings in quest of a remote ancestor, Ut-Napishtim, from whom he hopes to learn how he may escape the fate of Eabani, and his finally learning from his friend of the sad fate in store for all mortals except the favourites of the god, the

Ut-Napiaktim, to whom immortal life is vouchsafed as a special boon. (M. J.A.)

EACHARD, JOHN (1636?–1697), English divine, was born in Suffolk, and was educated at Catharine Hall, Cambridge, of which he became master in 1675 in succession to John Lightfoot. He was created D.D. in 1676 by royal mandate, and was twice (in 1679 and 1695) vice-chancellor of the university. He died on the 7th of July 1697. In 1676 he had published anonymously a humorous satire entitled *The Ground and Occasions of the Contempt of the Clergy enquired into in a letter to R. L.*, which excited much attention and provoked several replies, one of them being from John Owen. These were met by *Some Observations, &c.*, in a second letter to R. L. (1671), written in the same bantering tone as the original work. Eachard attributed the contempt into which the clergy had fallen to their imperfect education, their insufficient incomes, and the want of a true vocation. His descriptions, which were somewhat exaggerated, were largely used by Macaulay in his *History of England*. He gave amusing illustrations of the absurdity and poverty of the current pulpit oratory of his day, some of them being taken from the sermons of his own father. He attacked the philosophy of Hobbes in his *Mr Hobbs's State of Nature considered; in a dialogue between Philastus and Timothy* (1672), and in his *Some Opinions of Mr Hobbs considered in a second dialogue* (1673). These were written in their author's chosen vein of light satire, and Dryden praised them as highly effective within their own range. Eachard's own sermons, however, were not superior to those he satirized. Swift (*Works*, xii. 279) alludes to him as a signal instance of a successful humorist who entirely failed as a serious writer.

A collected edition of his works in three volumes, with a notice of his life, was published in 1774. *The Contents of the Clergy* was reprinted in E. Arber's *English Garner. A Free Enquiry into the Causes of the very great Esteem that the Nonconforming Preachers are generally in with their Followers* (1673) has been attributed to Eachard on insufficient grounds.

EADBALD (d. 640), king of Kent, succeeded to the throne on the death of his father Æthelberht in 616. He had not been influenced by the teaching of the Christian missionaries, and his first step on his accession was to marry his father's widow. After his subsequent conversion by Laurentius, archbishop of Canterbury, he recalled the bishops Mellitus and Justus, and built a church dedicated to the Virgin at Canterbury. He arranged a marriage between his sister Æthelberg and Edwin of Northumbria, on whose defeat and death in 633 he received his sister and Paulinus, and offered the latter the bishopric of Rochester. Eadbald married Emma, a Frankish princess, and died on the 20th of January 640.

See Bede, *Historia ecclesiastica* (ed. C. Plummer, Oxford, 1896); *Saxon Chronicle* (ed. J. Earle and C. Plummer, Oxford, 1899).

EADIE, JOHN (1810–1876), Scottish theologian and biblical critic, was born at Alva, in Stirlingshire, on the 9th of May 1810. Having taken the arts curriculum at Glasgow University, he studied for the ministry at the Divinity Hall of the Secession Church, a dissenting body which, on its union a few years later with the Relief Church, adopted the title United Presbyterian. In 1835 he became minister of the Cambridge Street Secession church in Glasgow, and for many years he was generally regarded as the leading representative of his denomination in Glasgow. As a preacher, though he was not eloquent, he was distinguished by good sense, earnestness and breadth of sympathy. In 1863 he removed with a portion of his congregation to a new church at Lansdowne Crescent. In 1843 Eadie was appointed professor of biblical literature and hermeneutics in the Divinity Hall of the United Presbyterian body. He held this appointment along with his ministerial charge till the close of his life. Though not a profound scholar, he was surpassed by few biblical commentators of his day in range of learning, and in soundness of judgment. In the professor's chair, as in the pulpit, his strength lay in the tact with which he selected the soundest results of biblical criticism, whether his own or that of others, and presented them in a clear and connected form, with a constant view

to their practical bearing. He received the degree of LL.D. from Glasgow in 1844, and that of D.D. from St Andrews in 1850.

His publications were connected with biblical criticism and interpretation, some of them being for popular use and others more strictly scientific. To the former class belong the *Biblical Cyclopaedia*, his edition of *Cruden's Concordance*, his *Early Oriental History*, and his discourses on the *Divine Love* and on *Paul the Preacher*; to the latter his commentaries on the Greek text of St Paul's epistles to the Ephesians, Colossians, Philippians and Galatians, published at intervals in four volumes. His last work was the *History of the English Bible* (2 vols., 1876). He rendered good service as one of the revisers of the authorized version. He died at Glasgow on the 3rd of June 1876. His valuable library was bought and presented to the United Presbyterian College.

EADMER, or **EDMER** (c. 1060–c. 1124), English historian and ecclesiastic, was probably, as his name suggests, of English, and not of Norman parentage. He became a monk in the Benedictine monastery of Christ Church, Canterbury, where he made the acquaintance of Anselm, at that time visiting England as abbot of Bec. The intimacy was renewed when Anselm became archbishop of Canterbury in 1093; thenceforward Eadmer was not only his disciple and follower, but his friend and director, being formally appointed to this position by Pope Urban II. In 1120 he was nominated to the archbishopric of St Andrews, but as the Scots would not recognize the authority of the see of Canterbury he was never consecrated, and soon afterwards he resigned his claim to the archbishopric. His death is generally assigned to the year 1124.

Eadmer left a large number of writings, the most important of which is his *Historiae novorum*, a work which deals mainly with the history of England between 1066 and 1122. Although concerned principally with ecclesiastical affairs scholars agree in regarding the *Historiae* as one of the ablest and most valuable writings of its kind. It was first edited by John Selden in 1623 and, with Eadmer's *Vita Anselmi*, has been edited by Martin Rule for the "Rolls Series" (London, 1884). The *Vita Anselmi*, first printed at Antwerp in 1551, is probably the best life of the saint. Less noteworthy are Eadmer's lives of St Dunstan, St Bregwin, archbishop of Canterbury, and St Oswald, archbishop of York; these are all printed in Henry Wharton's *Anglia Sacra*, part ii. (1691), where a list of Eadmer's writings will be found. The manuscripts of most of Eadmer's works are preserved in the library of Corpus Christi College, Cambridge.

See M. Rule, *On Eadmer's Elaboration of the first four Books of "Historiae novorum"* (1886); and Père Raguey, *Eadmer* (Paris, 1892).

EADS, JAMES BUCHANAN (1820–1887), American engineer, was born at Lawrenceburg, Indiana, on the 23rd of May 1820. His first engineering work of any importance was in raising sunken steamers. In 1845 he established glass works in St Louis. During the Civil War he constructed ironclad steamers and mortar boats for the Federal government. His next important engineering achievement was the construction of the great steel arch bridge across the Mississippi at St Louis (see *BAMCO*, fig. 29), upon which he was engaged from 1867 till 1874. The work, however, upon which his reputation principally rests was his deepening and fixing the channel at the mouths of the Mississippi by means of jetties, whereby the narrowed stream was made to scour out its own channel and carry the sediment out to sea. Shortly before his death he projected a scheme for a ship railway across the Isthmus of Tehuantepec, in lieu of an isthmian canal. He died at Nassau, in the Bahamas, on the 8th of March 1887.

EAGLE (Fr. *aigle*, from the Lat. *aquila*), the name generally given to the larger diurnal birds of prey which are not vultures; but the limits of the subfamily *Aquilinae* have been very variously assigned by different writers on systematic ornithology, and there are eagles smaller than certain buzzards. By some authorities the *Laemmergeier* of the Alps, and other high mountains of Europe, North Africa and Asia, is accounted an eagle, but by others the genus *Gyfaetus* is placed with the *Vulturidae* as its

common English name (bearded vulture) shows. There are also other forms, such as the South American *Harpyia* and its allies, which though generally called eagles have been ranked as buzzards. In the absence of any truly scientific definition of the family *Aquilinae* it is best to leave these and many other more or less questionable members of the group—such as the genera *Spizaetus*,



FIG. 1.—Sea-Eagle.

Circaetus, *Spilornis*, *Helotarsus*, and so forth—and to treat here of those whose position cannot be gainsaid.

True eagles inhabit all the regions of the world, and some seven or eight species at least are found in Europe, of which two are resident in the British Islands. In England and in the Lowlands of Scotland eagles only exist as stragglers; but in the Hebrides and some parts of the Highlands a good many may yet be found, and their numbers appear to have rather increased of late years than diminished; for the foresters and shepherds, finding that a high price can be got for their eggs, take care to protect the owners of the eyries, which are nearly all well known, and to keep up the stock by allowing them at times to rear their young. There are also now not a few occupiers of Scottish forests who interfere so far as they can to protect the king of birds.¹ In Ireland the extirpation of eagles seems to have been carried on almost unaffected by the prudent considerations which in the northern kingdom have operated so favourably for the race, and except in the wildest parts of Donegal, Mayo and Kerry, eagles in the sister island are almost birds of the past.

Of the two British species the erne (Icel. *Ærn*) or sea-eagle (by some called also the white-tailed and cinereous eagle)—*Haliaeetus albicilla*—affects chiefly the coast and neighbourhood of inland waters, living in great part on the fish and refuse that is thrown up on the shore, though it not unfrequently takes living prey, such as lambs, hares and rabbits. On these last, indeed, young examples mostly feed when they wander southward in

¹ Lord Breadalbane (d. 1871) was perhaps the first large landowner who set the example that has been since followed by others. On his unrivalled forest of Black Mount, eagles—elsewhere persecuted to the death—were by him ordered to be unmolested so long as they were not numerous enough to cause considerable depredations on the farmers' flocks. He thought that the spectacle of a soaring eagle was a fitting adjunct to the grandeur of his Argyllshire mountain scenery, and a good equivalent for the occasional loss of a lamb, or the slight deduction from the rent paid by his tenantry in consequence.

autumn, as they yearly do, and appear in England. The adults (fig. 1) are distinguished by their prevalent greyish-brown colour, their pale head, yellow beak and white tail—characters, however, wanting in the immature, which do not assume the perfect plumage for some three or four years. The eyry is commonly placed in a high cliff or on an island in a lake—sometimes on the ground, at others in a tree—and consists of a vast mass of sticks in the midst of which is formed a hollow lined with *Lezula sylvatica* (as first observed by John Wolley) or some similar grass, and here are laid the two or three white eggs. In former days the sea-eagle seems to have bred in several parts of England—as the Lake district, and possibly even in the Isle of Wight and on Dartmoor. This species inhabits all the northern part of the Old World from Iceland to Kamchatka, and breeds in Europe so far to the southward as Albania. In the New World, however, it is only found in Greenland, being elsewhere replaced by the white-headed or bald eagle, *H. leucocephalus*, a bird of similar habits, and the chosen emblem of the United States of America. In the far east of Asia occurs a still larger and finer sea-eagle, *H. pelagicus*, remarkable for its white thighs and upper wing-coverts. South-eastern Europe and India furnish a much smaller species, *H. leucorhynchus*, which has its representative, *H. leucogaster*, in the Malay Archipelago and Australia, and, as allies in South Africa and Madagascar, *H. vocifer* and *H. vociferoides* respectively. All these eagles may be distinguished by their scaly tarsi, while the group next to be treated of have the tarsi feathered to the toes.

The golden or mountain eagle, *Aquila chrysaetos*, is the second



FIG. 2.—Mountain-Eagle.

British species. This also formerly inhabited England, and a nest, found in 1668 in the Peak of Derbyshire, is well described by Willughby, in whose time it was said to breed also in the Snowdon range. It seldom if ever frequents the coast, and is more active on the wing than the sea-eagle, being able to take some birds as they fly, but a large part of its sustenance is the flesh of animals that die a natural death. Its eyry is generally placed and built like that of the other British species,² but the neighbourhood of

² As already stated, the site chosen varies greatly. Occasionally placed in a niche in what passes for a perpendicular cliff to which access could only be gained by a skilful cragsman with a rope, the writer has known a nest to within 10 or 15 yds. of which he rode on a pony. Two beautiful views of as many golden eagles' nests, drawn on the spot by Joseph Wolf, are given in the *Orithya Walleyana*, and a fine series of eggs is also figured in the same work.

water is not requisite. The eggs, from two to four in number, vary from a pure white to a mottled, and often highly coloured, surface, on which appear different shades of red and purple. The adult bird (fig. 2) is of a rich dark brown, with the elongated feathers of the neck, especially on the nape, light tawny, in which imagination sees a "golden" hue, and the tail marbled with brown and ashy-grey. In the young the tail is white at the base, and the neck has scarcely any tawny tint. The golden eagle does not occur in Iceland, but occupies suitable situations over the rest of the Palaearctic Region and a considerable portion of the Nearctic—though the American bird has been, by some, considered a distinct species. Domesticated, it has many times been trained to take prey for its master in Europe, and to this species is thought to belong an eagle habitually used by the Kirghiz Tatars, who call it *Bergut* or *Bearcoat*, for the capture of antelopes, foxes and wolves. It is carried hooded on horseback or on a perch between two men, and released when the quarry is in sight. Such a bird, when well trained, is valued, says P. S. Pallas, at the price of two camels. It is quite possible, however, that more than one kind of eagle is thus used, and the services of *A. heliaca* (which is the imperial eagle of some writers¹) and of *A. magnificus*—both of which are found in central Asia, as well as in south-eastern Europe—may also be employed.

A smaller form of eagle, which has usually gone under the name of *A. marina*, is now thought by the best authorities to include three local races, or, in the eyes of some, species. They inhabit Europe, North Africa and western Asia to India, and two examples of one of them—*A. clanga*, the form which is somewhat plentiful in north-eastern Germany—have occurred in Cornwall. The smallest true eagle is *A. pennata*, which inhabits southern Europe, Africa and India. Differing from other eagles of their genus by its wedge-shaped tail, though otherwise greatly resembling them, is the *A. audax* of Australia. Lastly may be noticed here a small group of eagles, characterized by their long legs, forming the genus *Nisaetus*, of which one species, *N. fasciatus*, is found in Europe. (A. N.)

EAGLEHAWK, a borough of Bendigo county, Victoria, Australia, 105 m. by rail N.N.W. of Melbourne and 4 m. from Bendigo, with which it is connected by steam tramway. Pop. (1901) 8130. It stands on the Bendigo gold-bearing reef, and its mines are important.

EAGRE (a word of obscure origin; the earliest form seems to be *higre*, Latinized as *higra*, which William of Malmesbury gives as the name of the bore in the Severn; the *New English Dictionary* rejects the usual derivations from the O. Eng. *egor* or *egor*, which is seen in compounds meaning "flood," and also the connexion with the Norse sea-god *Aegir*), a tide wave of great height rushing up an estuary (see **BOXE**), used locally of the Humber and Trent.

EAKINS, THOMAS (1844—), American portrait and figure painter, was born at Philadelphia, on the 25th of July 1844. A pupil of J. L. Gérôme, in the Ecole des Beaux-Arts, Paris, and also of Léon Bonnat, besides working in the studio of the sculptor Dumont, he became a prolific portrait painter. He also painted genre pictures, sending to the Centennial Exhibition at Philadelphia, in 1876, the "Chess Players," now in the Metropolitan Museum of Art, New York. A large canvas, "The Surgical Clinic of Professor Gross," owned by Jefferson Medical College, Philadelphia, contains many life-sized figures. Eakins, with his pupil Samuel Murray (b. 1870), modelled the heroic "Prophets" for the Witherspoon Building, Philadelphia, and his work in painting has a decided sculptural quality. He was for some years professor of anatomy at the schools of the Pennsylvania Academy of Fine Arts in Philadelphia. A man of great inventiveness, he experimented in many directions, depicting on canvas modern athletic sports, the negro, and early American life, but he is best known by his portraits. He received awards at the Columbian (1893), Paris (1900), Pan-American (1900), and the St Louis (1904), Expositions; and won the Temple

¹ Which species may have been the traditional emblem of Roman power, and the *Ales Jovis*, is very uncertain.

medal in the Pennsylvania Academy of Fine Arts, and the Proctor prize of the National Academy of Design.

EALING, a municipal borough in the Ealing parliamentary division of Middlesex, England, suburban to London, 9 m. W. of St Paul's cathedral. Pop. (1891) 23,979; (1901) 33,031. The nucleus of the town, the ancient village, lies south of the highroad to Uxbridge, west of the open Ealing Common. The place is wholly residential. At St Mary's church, almost wholly rebuilt c. 1870, are buried John Oldmixon, the historian (d. 1742), and Horne Tooke (d. 1812). The church of All Saints (1905) commemorates Spencer Perceval, prime minister, who was assassinated in the House of Commons in 1812. It was erected under the will of his daughter Frederica, a resident of Ealing. Gunnersbury Park, south of Ealing Common, is a handsome Italian mansion. Among former owners of the property was Princess Amelia, daughter of George II., who lived here from 1761 till her death in 1786. The name of Gunnersbury is said to be traceable to the residence here of Gunilda, niece of King Canute. The manor of Ealing early belonged to the see of London; but it is not mentioned in Domesday and its history is obscure.

EAR (common Teut.; O.E. *æare*, Ger. *Ohr*, Du. *oor*, akin to Lat. *auris*, Gr. *oûs*), in anatomy, the organ of hearing. The human ear is divided into three parts—external, middle and internal. The external ear consists of the pinna and the external auditory meatus. The pinna is composed of a yellow fibro-cartilaginous framework covered by skin, and has an external and an internal or cranial surface. Round the margin of the external surface in its upper three quarters is a rim called the helix (fig. 1, a), in which is often seen a little prominence



FIG. 1.—The Ear as seen in Section.

- | | |
|-----------------------------|---|
| a, Helix. | n, External auditory meatus. |
| b, Antitragus. | o, Membrana tympani. |
| c, Antihelix. | p, Tympanum. |
| d, Concha. | 1, points to malleus. |
| e, Lobule. | 2, to incus. |
| f, Mastoid process. | 3, to stapes. |
| g, Portio dura. | 4, to cochlea. |
| h, Styloid process. | 5, 6, 7, the three semicircular canals. |
| i, Internal carotid artery. | 8 and 9, facial and auditory nerves. |
| l, Eustachian tube. | |
| m, Tip of petrous process. | |

known as Darwin's tubercle, representing the folded-over apex of a prick-eared ancestor. Concentric with the helix and nearer the meatus is the antihelix (b), which, above, divides into two limbs to enclose the triangular fossa of the antihelix. Between the helix and the antihelix is the fossa of the helix. In front of the antihelix is the deep fossa known as the concha (fig. 1, d), and from the anterior part of this the meatus passes inward into the skull. Overlapping the meatus from in front is a flap called the tragus, and below and behind this is another smaller flap, the antitragus. The lower part of the pinna is the lobule (e), which contains no cartilage. On the cranial surface of the pinna elevations correspond to the concha and to the fossae

of the helix and antihelix. The pinna can be slightly moved by the anterior, superior and posterior auricular muscles, and in addition to these there are four small intrinsic muscles on the external surface, known as the helix major and minor, the tragus and the antitragus, and two on the internal surface called the obliquus and transversus. The external auditory meatus (fig. 1, *m*) is a tube running at first forward and upward, then a little backward and then forward and slightly downward; of course all the time it is also running inward until the tympanic membrane is reached. The tube is about an inch long, its outer third being cartilaginous and its inner two-thirds bony. It is lined by skin in its whole length, the sweat glands of which are modified to secrete the wax or cerumen.

The middle ear or tympanum (fig. 1, *p*) is a small cavity in the temporal bone, the shape of which may perhaps be realized by imagining a hock bottle subjected to lateral pressure in such a way that its circular section becomes triangular, the base of the triangle being above. The neck of the bottle, also laterally compressed, will represent the Eustachian tube (fig. 1, *l*), which runs forward, inward and downward, to open into the nasopharynx, and so admits air into the tympanum. The bottom of the bottle will represent the posterior wall of the tympanum, from the upper part of which an opening leads backward into the mastoid antrum and so into the air-cells of the mastoid process. Lower down is a little pyramid which transmits the stapedius muscle, and at the base of this is a small opening known as the iter chordae posterius, for the chorda tympani to come through from the facial nerve. The roof is formed by a very thin plate of bone, called the tegmen tympani, which separates the cavity from the middle fossa of the skull. Below the roof the upper part of the tympanum is somewhat constricted off from the rest, and to this part the term "attic" is often applied. The floor is a mere groove formed by the meeting of the external and internal walls. The outer wall is largely occupied by the tympanic membrane (fig. 1, *o*), which entirely separates the middle ear from the external auditory meatus; it is circular, and so placed that it slopes from above, downward and inward, and from behind, forward and inward. Externally it is lined by skin, internally by mucous membrane, while between the two is a firm fibrous membrane, convex inward about its centre to form the umbo. Just in front of the membrane on the outer wall is the Glaserian fissure leading to the glenoid cavity, and close to this is the canal of Huguier for the chorda tympani nerve. The inner wall shows a promontory caused by the cochlea and grooved by the tympanic plexus of nerves; above and behind it is the fenestra ovalis, while below and behind the fenestra rotunda is seen, closed by a membrane. Curving round, above and behind the promontory and fenestrae, is a ridge caused by the aqueductus Fallopii or canal for the facial nerve. The whole tympanum is about half an inch from before backward, and half an inch high, and is spanned from side to side by three small bones, of which the malleus (fig. 1, *z*) is the most external. This is attached by its handle to the umbo of the tympanic membrane, while its head lies in the attic and articulates posteriorly with the upper part of the next bone or incus (fig. 1, *g*). The long process of the incus runs downward and ends in a little knob called the os orbiculare, which is jointed on to the stapes or stirrup bone (fig. 1, *h*). The two branches of the stapes are anterior and posterior, while the footplate fits into the fenestra ovalis and is bound to it by a membrane. It will thus be seen that the stapes lies nearly at right angles to the long process of the incus. From the front of the malleus a slender process projects forward into the Glaserian fissure, while from the back of the incus the posterior process is directed backward and is attached to the posterior wall of the tympanum. These two processes form a fulcrum by which the lever action of the malleus and incus is brought about, so that when the handle of the malleus is pushed in by the membrane the head moves out; the top of the incus, attached to it, also moves out, and the os orbiculare moves in, and so the stapes is pressed into the fenestra ovalis. The stapedius and tensor tympani muscles, the latter of which enters the tympanum in a canal just above the

Eustachian tube to be attached to the malleus, modify the movements of the ossicles.

The mucous membrane lining the tympanum is continuous through the Eustachian tube with that of the naso-pharynx, and is reflected on to the ossicles, muscles and chorda tympani nerve. It is ciliated except where it covers the membrana tympani, ossicles and promontory; here it is stratified.

The internal ear or labyrinth consists of a bony and a membranous part, the latter of which is contained in the former. The bony labyrinth is composed of the vestibule, the semicircular canals and the cochlea. The vestibule lies just internal to the posterior part of the tympanum, and there would be a communication between the two, through the fenestra ovalis,



FIG. 2.—Diagram of the Membranous Labyrinth.

DC, Ductus cochlearis.
dr, Ductus reuniens.
S, Sacculus.
U, Utricle.
dr, Ductus endolymphaticus.
SC, Semicircular canals.
(After Waldeyer.)

were it not that the footplate of the stapes blocks the way. The inner wall of the vestibule is separated from the bottom of the internal auditory meatus by a plate of bone pierced by many foramina for branches of the auditory nerve (fig. 1, *g*), while at the lower part is the opening of the aqueductus vestibuli, by means of which a communication is established with the posterior cranial fossa. Posteriorly the three semicircular canals open into the vestibule; of these the external (fig. 1, *7*) has two independent openings, but the superior and posterior (fig. 1, *5* and *6*) join together at one end and so have a common opening, while at their other ends they open separately. The three canals have therefore five openings into the vestibule instead of six. One end of each canal is dilated to form its ampulla. The superior semicircular canal is vertical, and the two pillars of its arch are nearly external and internal; the external canal is horizontal, its two pillars being anterior and posterior, while the convexity of the arch of the posterior canal is backward and its two pillars are superior and inferior. Anteriorly the vestibule leads into the cochlea (fig. 1, *4*), which is twisted two and a half times round a central pillar called the modiolus, the whole cochlea forming a rounded cone something like the shell of a snail though it is only about 5 mm. from base to apex. Projecting from the modiolus is a horizontal plate which runs round it from base to apex like a spiral staircase; this is known as the lamina spiralis, and it stretches nearly half-way across the canal of the cochlea. At the summit it ends in a little hook named the hamulus. The modiolus is pierced by canals which transmit branches of the auditory nerve to the lamina spiralis.

The membranous labyrinth lies in the bony labyrinth, but does not fill it; between the two is the fluid called perilymph, while inside the membranous labyrinth is the endolymph. In the bony vestibule lie two membranous bags, the sacculus (fig. 2, *S*) in front, and the utricle (fig. 2, *U*) behind; each of these has a special patch or macula to which twigs of the auditory nerve are supplied, and in the mucous membrane of which specialized hair cells are found (fig. 3, *p*).

Attached to the maculae are crystals of carbonate of lime called otoliths. The membranous semicircular canals are very much smaller in section than the bony; in the ampulla of each is a ridge, the crista acústica, which is covered by a mucous

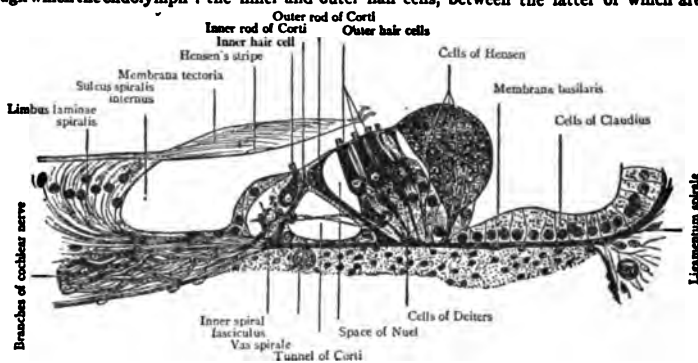

FIG. 3.—*c*, Columbar cells covering the crista acústica; *p*, peripheral, and *c*, central processes of auditory cells; *n*, nerve fibres.
(After Rüdinger.)

membrane containing sensory hair cells like those in the maculae. All the canals open into the utricle. From the lower part of the sacculle a small canal called the ductus endolymphaticus (fig. 2, *dv*) runs into the aqueductus vestibuli; it is soon joined by a small duct from the utricle, and ends, close to the dura mater of the posterior fossa of the cranium, as the saccus endolymphaticus, which may have minute perforations through which the endolymph can pass. Anteriorly the sacculle communicates with the membranous cochlea or scala media by a short ductus reuniens (fig. 2, *dr*). A section through each turn of the cochlea shows the bony lamina spiralis, already noticed, which is continued right across the canal by the basilar membrane (fig. 4, *bm*), thus cutting the canal into an upper and lower half and connected with the outer wall by the strong spiral ligament (fig. 4, *sl*). Near the free end of the lamina spiralis another membrane called the membrane of Reissner (fig. 4, *mR*) is attached, and runs outward and upward to the outer wall, taking a triangular slice out of the upper half of the section. There are now three canals seen in section, the upper of which is the scala vestibuli (fig. 4, SV), the middle and outer the scala media, ductus cochlearis or true membranous cochlea (fig. 4, DC), while the lower is the scala tympani (fig. 4, ST). The scala vestibuli and scala tympani communicate at the apex of the cochlea by an opening known as the helicotrema, so that the perilymph can here pass from one canal to the other. At the base of the cochlea the

at the apex of the cochlea, it ends in a blind extremity of considerable morphological interest called the lagena.

The scala media contains the essential organ of hearing or organ of Corti (fig. 4, *oc*), which lies upon the inner part of the basilar membrane; it consists of a tunnel bounded on each side of the inner and outer rods of Corti; on each side of these are the inner and outer hair cells, between the latter of which are



(From R. Howden—Cunningham's *Text-Book of Anatomy*.)
 FIG. 5.—Transverse Section of Corti's Organ from the Central Coil of Cochlea (Retzius).

found the supporting cells of Deiters. Most externally are the large cells of Hensen. A delicate membrane called the lamina reticularis covers the top of all these, and is pierced by the hairs of the hair cells, while above this is the loose membrana tectoria attached to the periosteum of the lamina spiralis, near its tip, internally, and possibly to some of Deiters' cells externally. The cochlear branch of the auditory nerve enters the lamina spiralis, where a spiral ganglion (fig. 4, *sg*) is developed on it; after this it is distributed to the inner and outer hair cells.

For further details see *Text-Book of Anatomy*, edited by D. J. Cunningham (Edinburgh, 1906); Quain's *Elements of Anatomy* (London, 1893); Gray's *Anatomy* (London, 1905); *A Treatise on Anatomy*, edited by H. Morris (London, 1902); *A Text-Book of Human Anatomy*, by A. Macalister (London, 1889).

Embryology.—The pinna is formed from six tubercles which appear round the dorsal end of the hyomandibular cleft or, more strictly speaking, pouch. Those for the tragus and anterior part of the helix belong to the first or mandibular arch, while those for the antitragus, antihelix and lobule come from the second or hyoid arch. The tubercle for the helix is dorsal to the end of the cleft where the two arches join. The external auditory meatus, tympanum and Eustachian tube are remains of the hyomandibular cleft, the membrana tympani being a remnant of the cleft membrane and therefore lined by ectoderm outside and entoderm inside. The origin of the ossicles is very doubtful. H. Gadov's view, which is one of the latest, is that all three are derived from the hyomandibular plate which connects the dorsal ends of the hyoid and mandibular bars (*Anatomischer Anzeiger*, Bd. xix., 1901, p. 396). Other papers which should be consulted are those of E. Gaupp, *Anatom. Hefte, Ergebnisse*, Bd. 8, 1898, p. 991, and J. A. Hammar, *Archiv. mikr. Anat.* lix., 1902. These papers will give a clue to the immense literature of the subject. The internal ear first appears as a pit from the cephalic ectoderm, the mouth of which in Man and other mammals closes up, so that a pear-shaped cavity is left. The stalk of the pear which is nearest the point of invagination is called the recessus labyrinthi, and this, after losing its connexion with the surface of the embryo, grows backward toward the posterior cranial fossa and becomes the ductus endolymphaticus. The lower part of the vesicle grows forward and becomes the cochlea, while from the upper part three hollow circular plates grow out, the central parts of which disappear, leaving the margin as the semicircular canals. Subsequently constrictions appear in the vesicle marking off the sacculle and utricle. From the surrounding

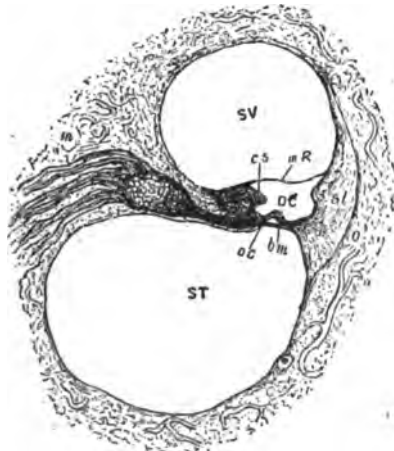

FIG. 4.—Transverse Section through the Tube of the Cochlea.

- | | |
|---------------------------|--|
| m, Modiolus. | bm, Basilar membrane. |
| O, Outer wall of cochlea. | cs, Crista spiralis. |
| SV, Scala vestibuli. | sl, Spiral ligament. |
| ST, Scala tympani. | sg, Spiral ganglion of auditory nerve. |
| DC, Ductus cochlearis. | oc, Organ of Corti, |
| mR, Membrane of Reissner. | |

perilymph in the scala vestibuli is continuous with that in the vestibule, but that in the scala tympani bathes the inner surface of the membrane stretched across the fenestra rotunda, and also communicates with the subarachnoid space through the aqueductus cochleae, which opens into the posterior cranial fossa. The scala media containing endolymph communicates, as has been shown, with the sacculle through the canalis reuniens, while,

mesoderm the petrous bone is formed by a process of chondrification and ossification.

See W. His, *Journ., Archiv f. Anat. und Phys.*, 1889, supplement, p. 1; also Streeter, *Am. Journ. of Anat.*, vi., 1907.

Comparative Anatomy.—The ectodermal inpushing of the internal ear has probably a common origin with the organs of the lateral line of fish. In the lower forms the ductus endolymphaticus retains its communication with the exterior on the dorsum of the head, and in some Elasmobranchs the opening is wide enough to allow the passage of particles of sand into the sacculle. It is probable that this duct is the same which, taking a different direction and losing its communication with the skin, abuts on the posterior cranial fossa of higher forms (see Rudolf Krause, "Die Entwicklung des Aq. vestibuli seu d. Endolymphaticus," *Anat. Anzeiger*, Bd. xix., 1901, p. 49). In certain Teleostean fishes the swim bladder forms a secondary communication with the internal ear by means of special ossicles (see G. Ridewood, *Journ. Anat. & Phys.* vol. xxvi.). Among the Cyclostomata the external semicircular canals are wanting; Petromyzon has the superior and posterior only, while in Myxine these two appear to be fused so that only one is seen. In higher types the three canals are constant. Concretions of carbonate of lime are present in the internal ears of almost all vertebrates; when these are very small they are called otoconia, but when, as in most of the teleostean fishes, they form huge concretions, they are spoken of as otoliths. One shark, *Squatina*, has sand instead of otoconia (C. Stewart, *Journ. Linn. Society*, xxix. 409). The utricle, sacculle, semicircular canals, ductus endolymphaticus and a short lagena are the only parts of the ear present in fish.

The Amphibia have an important sensory area at the base of the lagena known as the macula acustica basilaris, which is probably the first rudiment of a true cochlea. The ductus endolymphaticus has lost its communication with the skin, but it is frequently prolonged into the skull and along the spinal canal, from which it protrudes, through the intervertebral foramina, bulging into the coelom. This is the case in the common frog (A. Coggi, *Anat. Anz.* 5. Jahrg., 1890, p. 177). In this class the tympanum and Eustachian tube are first developed; the membrana tympani lies flush with the skin of the side of the head, and the sound-waves are transmitted from it to the internal ear by a single bony rod—the columella.

In the Reptilia the internal ear passes through a great range of development. In the Chelonina and Ophidia the cochlea is as rudimentary as in the Amphibia, but in the higher forms (Crocodylia) there is a lengthened and slightly twisted cochlea, at the end of which the lagena forms a minute terminal appendage. At the same time indications of the scalae tympani and vestibuli appear. As in the Amphibia the ductus endolymphaticus sometimes extends into the cranial cavity and on into other parts of the body. Snakes have no tympanic membrane. In the birds the cochlea resembles that of the crocodiles, but the posterior semicircular canal is above the superior where they join one another. In certain lizards and birds (owls) a small fold of skin represents the first appearance of an external ear. In the monotremes the internal ear is reptilian in its arrangement, but above them the mammals always have a spirally twisted cochlea, the number of turns varying from one and a half in the Cetacea to nearly five in the rodent *Coelogenys*. The lagena is reduced to a mere vestige. The organ of Corti is peculiar to mammals, and the single columella of the middle ear is replaced by the three ossicles already described in Man (see Alban Doran, "Morphology of the Mammalian Ossicula auditus," *Proc. Linn. Soc.*, 1876-1877, xiii. 185; also *Trans. Linn. Soc.* 2nd Ser. Zool. i. 371). In some mammals, especially Carnivora, the middle ear is enlarged to form the tympanic bulla, but the mastoid cells are peculiar to Man.

For further details see G. Retzius, *Das Gehörorgan der Wirbeltiere* (Stockholm, 1881-1884.); *Catalogue of the Museum of the R. College of Surgeons—Physiological Series*, vol. iii. (London, 1906); R. Wiedersheim's *Vergleichende Anatomie der Wirbeltiere* (Jena, 1902). (F. G. P.)

DISEASES OF THE EAR.

Modern scientific aural surgery and medicine (commonly known as Otology) dates from the time of Sir William Wilde of Dublin (1843), whose work marked a great advance in the application of anatomical, physiological and therapeutical knowledge to the study of this organ. Less noticeable contributions to the subject had not long before been made by Saunders (1827), Kramer (1833), Pilcher (1841) and Yearsley (1841). The next important event in the history of otology was the publication of J. Toynbee's book in 1860 containing his valuable anatomical and pathological observations. Von Tröltzsch of Würzburg, following on the lines of Wilde and Toynbee, produced two well-known works in 1861 and 1862, laying the foundation of the study in Germany. In that country and in Austria he was followed by Hermann Schwartz, Politzer, Gruber, Weber-Liel, Rüdinger, Moos and numerous others. France produced Itard, de la Charrière, Menière, Loewenberg and Bonnafont; and Belgium, Charles Delstanche, father and son. In Great Britain the work was carried on by James Hinton (1874), Peter Allen (1871), Patterson Cassells and Sir William Dalby. In America we may count among the early otologists Edward H. Clarke (1858), D. B. St John Roosa, H. Knapp, Clarence J. Blake, Albert H. Buck and Charles Burnett. Other workers all over the world are too numerous to mention.

Various Diseases and Injuries.—Diseases of the ear may affect any of the three divisions, the external, middle or internal ear. The commoner affections of the auricle are eczema, various tumours (simple and malignant), and serous and sebaceous cysts. Haematoma auris (othaematoma), or effusion of blood into the auricle, is often due to injury, but may occur spontaneously, especially in insane persons. The chief diseases of the external auditory canal are as follows:—impacted cerumen (or wax), circumscribed (or furuncular) inflammation, diffuse inflammation, strictures due to inflammatory affections, bony growths, fungi (otomycosis), malignant disease, caries and necrosis, and foreign bodies.

Diseases of the middle ear fall into two categories, suppurative and non-suppurative (i.e. with and without the formation of pus). Suppurative inflammation of the middle ear is either acute or chronic, and is in either case accompanied by perforation of the drum head and discharge from the ear. The chief importance of these affections, in addition to the symptoms of pain, deafness, discharge, &c., is the serious complications which may ensue from their neglect, viz. aural polypi, caries and necrosis of the bone, affections of the mastoid process, including the mastoid antrum, paralysis of the facial nerve, and the still more serious intracranial and vascular infective diseases, such as abscess in the brain (cerebrum or cerebellum), meningitis, with subdural and extradural abscesses, septic thrombosis of the sigmoid and other venous sinuses, and pyaemia. It is owing to the possibility of these complications that life insurance companies usually, and rightly, inquire as to the presence of ear discharge before accepting a life. Patterson Cassells of Glasgow urged this special point as long ago as 1877. Acute suppurative disease of the middle ear is often due to the exanthemata, scarlatina, measles and smallpox, and to bathing and diving. It may also be caused by influenza, diphtheria and pulmonary phthisis.

Non-suppurative disease of the middle ear may be acute or chronic. In the acute form the inflammation is less violent than in the acute suppurative inflammation, and is rarely accompanied by perforation. Chronic non-suppurative inflammation may be divided into the moist form, in which the symptoms are improved by inflation of the tympanum through the Eustachian tube, and the dry form (including sclerosis), which is more intractable and in which this procedure has little or no beneficial effect. Diseases of the internal ear may be primary or secondary to an affection of the tympanum or to intracranial disease.

Injuries to any part of the ear may occur, among the commoner being injuries to the auricle, rupture of the drum head (from explosions, blows on the ear or the introduction of sharp bodies into the ear canal), and injuries from fractured skull. Congenital

malformations of the ear are most frequently met with in the auricle and external canal.

Methods of Examination.—The methods of examining the ear are roughly threefold:—(1) Testing the hearing with watch, voice and tuning-fork. The latter is especially used to distinguish between disease of the middle ear (conducting apparatus) and that of the internal ear (perceptive apparatus). Our knowledge of the subject has been brought to its present state by the labours of many observers, notably Weber, Rinne, Schwabach, Lucae and Gellé. (2) Examination of the canal and drum-head with speculum and reflector, introduced by Kramer, Wilde and von Tröltzsch. (3) Examination of the drum-cavity through the Eustachian tube by the various methods of inflation.

Symptoms.—The chief symptoms of ear diseases are deafness, noises in the ear (tinnitus aurium), giddiness, pain and discharge. Deafness (or other disturbance of hearing) and noises may occur from disease in almost any part of the ear. Purulent discharge usually comes from the middle ear. Giddiness is more commonly associated with affections of the internal ear.

Treatment.—Ear diseases are treated on ordinary surgical and medical lines, due regard being had to the anatomical and physiological peculiarities of this organ of sense, and especially to its close relationship, on the one hand to the nose and naso-pharynx, and on the other hand to the cranium and its contents. The chief advance in aural surgery in recent years has been in the surgery of the mastoid process and antrum. The pioneers of this work were H. Schwartz of Halle, and Stacke of Erfurt, who have been followed by a host of workers in all parts of the world. This development led to increased attention being paid to the intracranial complications of suppurative ear disease, in the treatment of which great strides have been made in the last few years.

Effects of Diseases of the Nose on the Ear.—The influence of diseases of the nose and naso-pharynx on ear diseases was brought out by Loewenberg of Paris, Voltolini of Breslau, and especially by Wilhelm Meyer of Copenhagen, the discoverer of adenoid vegetations of the naso-pharynx ("adenoids"), who recognized the great importance of this disease and gave an inimitable account of it in the *Trans. of the Royal Medical and Chirurgical Society of London*, 1870, and the *Archiv für Ohrenheilkunde*, 1873. Adenoid vegetations, which consist of an abnormal enlargement of Luschka's tonsil in the vault of the pharynx, frequently give rise to ear disease in children, and, if not attended to, lay the foundation of nasal and ear troubles in after life. They are often associated with enlargement of the faucial tonsils.

Journals.—In 1864 the *Archiv für Ohrenheilkunde* was started by Politzer and Schwartz, and, in 1867, the *Monatsschrift für Ohrenheilkunde* (a monthly publication) was founded by Voltolini, Gruber, Weber-Liel and Rüdinger. Appearing first as the *Archives of Ophthalmology and Otolaryngology*, simultaneously in English and German, in 1869, the *Archives of Otolaryngology* became a separate publication under the editorship of Knapp, Moos and Roosa in 1879. Amongst other journals now existing are *Annales des maladies de l'oreille et du larynx* (Paris), *Journal of Laryngology* (London), *Centralblatt für Ohrenheilkunde* (Leipzig), &c.

Societies.—The earliest society formed was the American Otolaryngological Society (1868), which held annual meetings and published yearly transactions. Flourishing societies for the study of otology (sometimes combined with laryngology) exist in almost all civilized countries, and they usually publish transactions consisting of original papers and cases. The Otolaryngological Society of the United Kingdom was founded in 1900.

International Congresses.—International Otolaryngological congresses have been held at intervals of about four years at New York, Milan, Basel, Brussels, Florence, London and Bordeaux (1904). The proceedings of the congresses appear as substantial volumes.

Hospitals.—The earliest record of a public institution for the treatment of ear diseases is a Dispensary for Diseases of the Eye and Ear in London, started by Saunders and Cooper, which existed in 1804; the aural part, however, was soon closed, so that the actual oldest institution appears to be the Royal Ear Hospital, London, which was founded by Curtis in 1816. Four years later there was started the New York Eye and Ear Infirmary. At the present time in every large town of Europe and America ear diseases are treated either in separate departments of general hospitals or in institutions especially devoted to the purpose.

For a history of otology from the earliest times refer to *A Practical Treatise on the Diseases of the Ear*, by D. B. St John Roosa, M.D., LL.D. (6th edition, New York, 1885), and for a general account of

the present state of otological science to *A Text-Book of the Diseases of the Ear for Students and Practitioners*, by Professor Dr Adam Politzer, transl. by Milton J. Ballin, Ph.B., M.D., and Clarence J. Heller, M.D. (4th edition, London, 1902). (E. C. B. *)

EARL, a title and rank of nobility (corresponding to Lat. *comes*; Fr. *comte*), now the third in order of the British peerage, and accordingly intervening between marquess and viscount. Earl, however, is the oldest title and rank of English nobles, and was the highest until the year 1337, when the Black Prince was created duke of Cornwall by Edward III.

The nature of a modern earldom is readily understood, since it is a rank and dignity of nobility which, while it confers no official power or authority, is inalienable, indivisible, and descends in regular succession to all the heirs under the limitation in the grant until, on their failure, it becomes extinct.

The title is of Scandinavian origin, and first appears in England under Canute as *jarl*, which was Englished as *eorl*. Like the *caldorman*, whose place he took, the *eorl* was a great royal officer, who might beset over several counties, but who presided separately in the county court of each with the bishop of the diocese. Although there were counts in Normandy before the Norman Conquest, they differed in character from the English earls, and the earl's position appears to have been but slightly modified by the Conquest. He was still generally entitled to the "third penny" of the county, but his office tended, under Norman influence, to become an hereditary dignity and his sphere was restricted by the Conqueror to a single county. The right to the "third penny" is a question of some obscurity, but its possession seems to have been deemed the distinctive mark of an earl, while the girding with "the sword of the county" formed the essential feature in his creation or investiture, as it continued to do for centuries later. The fact that every earl was the earl of a particular county has been much obscured by the loose usage of early times, when the style adopted was sometimes that of the noble's surname (e.g. the Earls Ferrers), sometimes that of his chief seat (e.g. the Earls of Arundel), and sometimes that of the county. Palatine earldoms, or palatinates, were those which possessed *regalia*, i.e. special privileges delegated by the crown. The two great examples, which dated from Norman times, were Chester and Durham, where the earl and the bishop respectively had their own courts and jurisdiction, and were almost petty sovereigns.

The earliest known charter creating an earl is that by which Stephen bestowed on Geoffrey de Mandeville, in or about 1140, the earldom of Essex as an hereditary dignity. Several other creations by Stephen and the empress Maud followed in quick succession. From at least the time of the Conquest the earl had a double character; he was one of the "barons," or tenants in chief, in virtue of the fief he held of the crown, as well as an earl in virtue of his "belting" (with the sword) and his "third penny" of the county. His fief would descend to the heirs of his body; and the earliest charters creating earldoms were granted with the same "limitation." The dignity might thus descend to a woman, and, in that case, like the territorial fief, it would be held by her husband, who might be summoned to parliament in right of it. The earldom of Warwick thus passed through several families till it was finally obtained, in 1449, by the Kingmaker, who had married the heiress of the former earls. But in the case of "co-heiresses" (more daughters than one), the king determined which, if any, should inherit the dignity.

The 14th century saw some changes introduced. The earldom of March, created in 1328, was the first that was not named from a county or its capital town. Under Edward III. also an idea appears to have arisen that earldoms were connected with the tenure of lands, and in 1337 several fresh ones were created and large grants of lands made for their support. The first earldom granted with limitation to the heirs male of the grantee's body was that of Nottingham in 1383. Another innovation was the grant of the first earldom for life only in 1377. The girding with the sword was the only observance at a creation till the first year of Edward VI., when the imposition of the cap

of dignity and a circlet of gold was added. Under James I. the patent of creation was declared to be sufficient without any ceremony. An earl's robe of estate has three bars of ermine, but possibly it had originally four.

Something should be said of anomalous earldoms with Norman or Scottish styles. The Norman styles originated either under the Norman kings or at the time of the conquest of Normandy by the house of Lancaster. To the former period belonged that of Aumale, which successive fresh creations, under the Latinized form "Albemarle" have perpetuated to the present day (see ALBEMARLE, EARLS AND DUKES OF). The so-called earls of Eu and of Mortain, in that period, were really holders of Norman *comtés*. Henry V. and his son created five or six, it is said, but really seven at least, Norman countships or earldoms, of which Harcourt (1418), Perche (1419), Dreux (1427) and Mortain (? 1430) were bestowed on English nobles, Eu (1419), and Tankerville (1419) on English commoners, and Longueville (1419) on a foreigner, Gaston de Foix. Of these the earldom of "Eu" was assumed by the earls of Essex till the death of Robert, the parliament's general (1646), while the title of Tankerville still survives under a modern creation (1714). An anomalous royal licence of 1661 permitted the earl of Bath to use the title of earl of Corbeil by alleged hereditary right. Of Scottish earldoms recognized in the English parliament the most remarkable case is that of the Lords Umfraville, who were summoned for three generations (1297-1380), as earls of Angus; Henry, Lord Beaumont, also was summoned as earl of Buchan from 1334 to 1339.

The earldom of Chester is granted to the princes of Wales on their creation, and the Scottish earldom of Carrick is held by the eldest son of the sovereign under act of parliament.

The premier earldom is that of Arundel (*q.v.*), but as this is at present united with the dukedom of Norfolk, the oldest earldom not merged in a higher title is that of Shrewsbury (1442), the next in seniority being Derby (1485), and Huntingdon (1529). These three have been known as "the catskin earls," a term of uncertain origin. The ancient earldom of Wiltshire (1397) was unsuccessfully claimed in 1869 by Mr Scrope of Danby, and that of Norfolk (1312), in 1906, by Lord Mowbray and Stourton.

The premier earldom of Scotland as recognized by the Union Roll (1707), is that of Crawford, held by the Lindsay's since its creation in 1398; but it is not one of the ancient "seven earldoms." The Decree of Ranking (1606) appears to have recognized the earldom of Sutherland as the most ancient in virtue of a charter of 1347, but the House of Lords' decision of 1771 recognized it as having descended from at least the year 1275, and it may be as old as 1228. It is at present united with the dukedom of Sutherland. The original "seven earldoms" (of which it was one) represented seven provinces, each of which was under a "normaer." This Celtic title was rendered "jarl" by the Norsemen, and under Alexander I. (c. 1115) began to be replaced by earl (*comes*), owing to Anglo-Norman influence, which also tended to make these earldoms less official and more feudal.

In Ireland the duke of Leinster is, as earl of Kildare, premier earl as well as premier duke.

An earl is "Right Honourable," and is styled "My Lord." His eldest son bears his father's "second title," and therefore, that second title being in most cases a viscounty, he generally is styled "Viscount"; where, as with Devon and Huntingdon, there is no second title, one may be assumed for convenience; under all circumstances, however, the eldest son of an earl takes precedence immediately after the viscounts. The younger sons of earls are "Honourable," but all their daughters are "Ladies." In formal documents and instruments, the sovereign, when addressing or making mention of any peer of the degree of an earl, usually designates him "trusty and well-beloved cousin,"—a form of appellation first adopted by Henry IV., who either by descent or alliance was actually related to every earl and duke in the realm. The wife of an earl is a countess; she is "Right Honourable," and is styled "My Lady." For the earl's coronet see CROWN AND CORONET.

See Lord's Reports on the Dignity of a Peer; Pike's Constitutional

History of the House of Lords; Selden's Titles of Honour; G. E. (Okayne)'s Complete Peerage; Round's Geoffrey de Mandeville. (J. H. R.)

EARLE, JOHN (c. 1601-1665), English divine, was born at York about 1601. He matriculated at Christ Church, Oxford, but migrated to Merton, where he obtained a fellowship. In 1631 he was proctor and also chaplain to Philip, earl of Pembroke, then chancellor of the university, who presented him to the rectory of Bishopston in Wiltshire. His fame spread, and in 1641 he was appointed chaplain and tutor to Prince Charles. In 1643 he was elected one of the Assembly of Divines at Westminster, but his sympathies with the king and with the Anglican Church were so strong that he declined to sit. Early in 1643 he was chosen chancellor of the cathedral of Salisbury, but of this preferment he was soon deprived as a "malignant." After Cromwell's great victory at Worcester, Earle went abroad, and was named clerk of the closet and chaplain to Charles II. He spent a year at Antwerp in the house of Isaac Walton's friend, George Morley, who afterwards became bishop of Winchester. He next joined the duke of York (James II.) at Paris, returning to England at the Restoration. He was at once appointed dean of Westminster, and in 1661 was one of the commissioners for revising the liturgy. He was on friendly terms with Richard Baxter. In November 1662 he was consecrated bishop of Worcester, and was translated, ten months later, to the see of Salisbury, where he conciliated the nonconformists. He was strongly opposed to the Conventicle and Five Mile Acts. During the great plague Earle attended the king and queen at Oxford, and there he died on the 17th of November 1665.

Earle's chief title to remembrance is his witty and humorous work entitled *Microcosmographie, or a Peerce of the World discovered, in Essays and Characters*, which throws light on the manners of the time. First published anonymously in 1628, it became very popular, and ran through ten editions in the lifetime of the author. The style is quaint and epigrammatic; and the reader is frequently reminded of Thomas Fuller by such passages as this: "A university dunner is a gentlemen follower cheaply purchased, for his own money has hyr'd him." Several reprints of the book have been issued since the author's death; and in 1671 a French translation by J. Dymock appeared with the title of *Le Vice ridicul*. Earle was employed by Charles II. to make the Latin translation of the *Eikon Basilike*, published in 1649. A similar translation of R. Hooker's *Ecclesiastical Polity* was accidentally destroyed.

"Dr Earle," says Lord Clarendon in his *Life*, "was a man of great piety and devotion, a most eloquent and powerful preacher, and of a conversation so pleasant and delightful, so very innocent, and so very facetious, that no man's company was more desired and loved. No man was more negligent in his dress and habit and mien, no man more wary and cultivated in his behaviour and discourse. He was very dear to the Lord Falkland, with whom he spent as much time as he could make his own."

See especially Philip Bliss's edition of the *Microcosmographie* (London, 1811), and E. Arber's Reprint (London, 1868).

EARLE, RALPH (1751-1801), American historical and portrait painter, was born at Leicester, Massachusetts, on the 11th of May 1751. Like so many of the colonial craftsmen, Earle was self-taught, and for many years was an itinerant painter. He went with the Governor's Guard to Lexington and made battle sketches, from which in 1775 he painted four scenes, engraved by Amos Doolittle, which are probably the first historical paintings by an American. After the War of Independence, Earle went to London, entered the studio of Benjamin West, and painted the king and many notables. After his return to America in 1786 he made portraits of Timothy Dwight, Governor Caleb Strong, Roger Sherman, and other prominent men. He also painted a large picture of Niagara Falls. He died at Bolton, Connecticut, on the 16th of August 1801.

EARL MARSHAL, in England, a functionary who ranks as the eighth of the great officers of state. He is the head of the college of arms, and has the appointment of the kings-of-arms, heralds and pursuivants at his discretion. He attends the sovereign in opening and closing the session of parliament,

walking opposite to the lord great chamberlain on his or her right hand. It is his duty to make arrangements for the order of all state processions and ceremonies, especially for coronations and royal marriages and funerals. Like the lord high constable he rode into Westminster Hall with the champion after a coronation, till the coronation banquet was abandoned, taking his place on the left hand, and with the lord great chamberlain he assists at the introduction of all newly-created peers into the House of Lords.

The marshal appears in the feudal armies to have been in command of the cavalry under the constable, and to have in some measure superseded him as master of the horse in the royal palace. He exercised joint and co-ordinate jurisdiction with the constable in the court of chivalry, and afterwards became the sole judge of that tribunal till its obsolescence. The marshalship of England was formerly believed to have been inherited from the Clares by the Marshal family, who had only been marshals of the household. It was held, however, by the latter family, as the office of chief (*magister*) marshal, as early as the days of Henry I. Through them, under Henry III., it passed to the Bigods, as their eldest co-heirs. In 1306 it fell to the crown on the death of the last Bigod, earl of Norfolk, who had made Edward I. his heir, and in 1316 it was granted by Edward II. to his own younger brother, Thomas "of Brotherton," earl of Norfolk. As yet the style of the office was only "marshal" although the last Bigod holder, being an earl, was sometimes loosely spoken of as the earl marshal. The office, having reverted to the crown, was granted out anew by Richard II., in 1385, to Thomas Mowbray, earl of Nottingham, the representative of Thomas "of Brotherton." In 1386 the style of "earl marshal" was formally granted to him in addition. After several attainders and partial restorations in the reigns of the Tudors and the Stuarts, the earl marshalship was granted anew to the Howards by Charles II. in 1672 and entailed on their male line, with many specific remainders and limitations, under which settlement it has regularly descended to the present duke of Norfolk. Its holders, however, could not execute the office until the Roman Catholic emancipation, and had to appoint deputies. The duke is styled earl marshal "and hereditary marshal of England," but the double style would seem to be an error, though the Mowbrays, with their double creation (1385, 1386) might have claimed it. His Grace appends the letters "E.M." to his signature, and bears behind his shield two batons crossed in saltire, the marshal's rod (*virga*) having been the badge of the office from Norman times. There appear to have been hereditary marshals of Ireland, but their history is not well ascertained. The Keiths were Great Marshals of Scotland from at least the days of Robert Bruce, and were created earls marischal in or about 1458, but lost both earldom and office by the attainder of George, the 10th earl, in 1716. (See also MARSHAL; STATE, GREAT OFFICERS OF.)

See "The Marshalship of England," in J. H. Round, *Commons of London and Other Studies* (London, 1899); G. E. Cokayne's *Complete Peerage*. (J. H. R.)

EARL OM, RICHARD (1742-1822), English mezzotint engraver, was born and died in London. His natural faculty for art appears to have been first called into exercise by admiration for the lord mayor's state coach, just decorated by Cipriani. He tried to copy the paintings, and was sent to study under Cipriani. He displayed great skill as a draughtsman, and at the same time acquired without assistance the art of engraving in mezzotint. In 1765 he was employed by Alderman Boydell, then one of the most liberal promoters of the fine arts, to make a series of drawings from the pictures at Houghton Hall; and these he afterwards engraved in mezzotint. His most perfect works as engraver are perhaps the fruit and flower pieces after the Dutch artists Van Os and Van Huysum. Amongst his historical and figure subjects are—"Agrippina," after West; "Love in Bondage," after Guido Reni; the "Royal Academy," the "Embassy of Hyderbeck to meet Lord Cornwallis," and a "Tiger Hunt," the last three after Zoffany; and "Lord Heathfield," after Sir Joshua Reynolds. Earlom also executed a series of 200 facsimiles of

the drawings and sketches of Claude Lorraine, which was published in 3 vols. folio, under the title of *Liber veritatis* (1777-1819).

EARLSTON (formerly ERCLIDOUNE, of which it is a corruption), a parish and market town of Berwickshire, Scotland. Pop. (1901) 1049. It is situated on Leader Water in Lauderdale, 7½ m. S.E. of Edinburgh by the North British railway branch line from Reston Junction to St Boswells, and about 4 m. N.E. of Melrose. When the place was a hamlet of rude huts it was called Arcloldun, or "Prospect Fort," with reference to Black Hill (2003 ft.), on the top of which may yet be traced the concentric rings of the British fort by which it was crowned. It is said to be possible to make out the remains of the cave-dwellings of the Ottadani, the aborigines of the district. In the 12th and 13th centuries the Lindsays and the earls of March and Dunbar were the chief baronial families. The particular link with the remote past, however, is the ivy-clad ruin of the ancient tower, "The Rhymer's Castle," the traditional residence of Thomas Learmont, commonly called Thomas of Erclidoune, or Thomas the Rhymer, poet and prophet, and friend of the Fairies, who was born here about 1225. Rhymer's Tower was crumbling to pieces, and its stones were being used in the erection of dykes, cottages and houses, when the Edinburgh Border Counties Association acquired the relic and surrounding lands in 1895, and took steps to prevent further spoliation and decay. The leading manufactures are ginghams, tweeds and shirtings, and the town is also an important agricultural centre, stock sales taking place at regular intervals and cattle and horse fairs being held every year. Some 3 m. away is the estate of Bemersyde, said to have been in the possession of the Haigs for nearly 1000 years. The prospect from Bemersyde Hill was Sir Walter Scott's favourite view. The castle at Bemersyde was erected in 1535 to secure the peace of the Border.

EARLY, JUBAL ANDERSON (1816-1894), American soldier and lawyer, was born in Franklin county, Virginia, on the 3rd of November 1816, and graduated at the U.S. Military Academy in 1837. He served in the Seminole War of 1837-38, after which he resigned in order to practise law in Franklin county, Va. He also engaged in state politics, and served in the Mexican War as a major of Virginia volunteers. He was strongly opposed to secession, but thought it his duty to conform to the action of his state. As a colonel in the Confederate army, he rendered conspicuous service at the first battle of Bull Run (9.9.). Promoted brigadier-general, and subsequently major-general, Early served throughout the Virginian campaigns of 1862-63, and defended the lines of Fredericksburg during the battle of Chancellorsville. At Gettysburg he commanded his division of Ewell's corps. In the campaign of 1864 Early, who had now reached the rank of lieutenant-general, commanded the Confederate forces in the Shenandoah Valley. The action of Lynchburg left him free to move northwards, his opponent being compelled to march away from the Valley. Early promptly utilized his advantage, crossed the Potomac, and defeated, on the Monocacy, all the troops which could be gathered to meet him. He appeared before the lines of Washington, put part of Maryland and Pennsylvania under contribution, and only retired to the Valley when threatened by heavy forces hurriedly sent up to Washington. He then fought a successful action at Winchester, reappeared on the Potomac, and sent his cavalry on a raid into Pennsylvania. A greatly superior army was now formed under General Sheridan to oppose Early. In spite of his skill and energy the Confederate leader was defeated in the battles of Winchester and Fisher's Hill. Finally, on the 19th of October, after inflicting at first a severe blow upon the Federal army in its camps on Cedar Creek, he was decisively beaten by Sheridan. (See SHENANDOAH VALLEY CAMPAIGNS.) Waynesboro (March 1865) was his last fight, after which he was relieved from his command. General Early was regarded by many as the ablest soldier, after Lee and Jackson, in the Army of Northern Virginia, and one of the ablest in the whole Confederate army. That he failed to make headway against an army far superior in numbers, and led by a general of the calibre of Sheridan, cannot be held to prove the

falsity of this judgment. After the peace he went to Canada, but in 1867 returned to resume the practice of law. For a time he managed in conjunction with General Beaugard the Louisiana lottery. He died at Lynchburg, Va., on the 2nd of March 1894. General Early was for a time president of the Southern Historical Society, and wrote, besides various essays and historical papers, *A Memoir of the Last Year of the War, &c.* (1867).

EARLY ENGLISH PERIOD, in architecture, the term given by Rickman to the first pointed or Gothic style in England, nominally 1189-1307, which succeeded the Romanesque or Norman period towards the end of the 12th century, and developed into the Decorated period in the commencement of the 14th century. It is chiefly characterized by the almost universal employment of the pointed arch, not only in arches of wide span such as those of the nave arcade, but for doorways and windows. The actual introduction of the pointed arch took place at a much earlier date, as in the nave arcade of the Cistercian Abbey of Buildwas (1140), though the clerestory window above has semicircular arches. It is customary, therefore, to make allowance for a transitional epoch from the middle of the 12th century. Although the pointed arches used are sometimes equilateral and sometimes drop-arches, the lancet-arch is the most characteristic. The period is best recognized in England by the great depth given to the hollows of the mouldings, alternating with fillets and rolls, by the decoration of the hollows with the dog-tooth ornament, by the circular abacus of the capitals, and the employment of slender detached shafts of Purbeck marble which are attached to piers by circular moulded shaftings (*Fr. anneau*).

The arches are sometimes cusped; circles with trefoils, quatrefoils, &c., are introduced into the tracery, and large rose windows in the transept or nave, as at Lincoln (1220). The conventional foliage decorating the capitals is of great beauty and variety, and extends to spandrels, bosses, &c. In the spandrels of the arches of the nave, transept or choir arcades, diaper work is occasionally found, as in the transept of Westminster Abbey. The latter is one of the chief examples of the period, to which must be added the cathedral of Salisbury (except the tower); the Galilee at Ely; nave and transept of Wells (1225-1240); nave of Lincoln; west front of Peterborough; and the minster at Beverley. (R. P. S.)

EARN, the name of a loch and river in Perthshire, Scotland. The loch, lying almost due east and west, is 6½ m. long and ½ m. in maximum breadth, 287 ft. deep, with a mean depth of 138 ft., covers an area of nearly 4 sq. m., has a drainage basin of over 54½ sq. m., and stands 317 ft. above the sea. Its waters are said never to freeze. It discharges by the river Earn. The points of interest on its shores are Lochearnhead (at the southern extremity of Glen Ogle), which has a station on the Callander-Oban railway, and the ruins of St Blane's chapel; Edinample Castle, an old turreted mansion belonging to the marquess of Breadalbane, situated in well-wooded grounds near the pretty falls of the Ample; Ardvorlich House, the original of Darlinvarach in Scott's *Legend of Montrose*, and the village of St Fillans at the foot of the loch, once the terminus of the branch of the Caledonian railway from Perth. The river flows out of Loch Earn, pursues an eastward course with a gentle inclination towards the south, and reaches the Firth of Tay, 6½ m. below Perth, after a total run of 49 m. Its chief tributaries on the right are the Ruchil, Machany, Ruthven, May and Farg, and on the left, the Lednock and Turret. It is navigable by vessels of 50 tons as far up as Bridge of Earn, and is a notable fishing stream, abounding with salmon and trout, perch and pike being also plentiful. On the Lednock are the falls of the Devil's Cauldron and on the Turret and its feeders several graceful cascades. The principal places of interest on the banks of the Earn are Dunira, the favourite seat of Henry Dundas, 1st Viscount Melville, who took the title of his barony from the estate and to whose memory an obelisk was raised on the adjoining hill of Dunmore; the village of Comrie; the town of Crieff; the ruined castle of Innerpeffray, founded in 1610 by the 1st Lord Maderty, close to which is the library founded in 1691 by the 3rd Lord Maderty,

containing some rare black-letter books and the Bible that belonged to the marquess of Montrose; Gascon Hall, now in ruins, but with traditions reaching back to the days of Wallace; Dupplin Castle, a fine Tudor mansion, seat of the earl of Kinnoull, who derives from it the title of his viscounty; Aberdaigie, Forgandenny and Bridge of Earn, a health resort situated amidst picturesque surroundings. Strathearn, as the valley of the Earn is called, extending from the loch to the Firth of Tay, is a beautiful and, on the whole, fertile tract, though liable at times to heavy floods. The earl of Perth is hereditary steward of Strathearn.

EARNEST (probably a corruption of the obsolete *arles* or *erics*, adapted from Lat. equivalent *artha*, due to a confusion with the adjective "earnest," serious, O. Eng. *earnust*, cognate with Ger. *ernst*), the payment of a sum of money by the buyer of goods to the seller on the conclusion of a bargain as a pledge for its due performance. It is almost similar to the *artha* of the Roman law, which may be traced back in the history of legal institutions to a period when the validity of a contract depended not so much upon the real intention of the parties, as upon the due observance of a prescribed ceremony. But *earnest* was never part payment, which *artha* might have been. Apart from its survival as a custom, its chief importance in English law is its recognition by the Statute of Frauds as giving validity to contracts for the sale of goods of a value exceeding £10 (see SALE OF GOODS). It is in that statute clearly distinguished from part payment, consequently any sum, however small, would be sufficient as earnest, being given as a token that the contract is binding and should be expressly stated so by the giver. The giving of earnest, or *hand-money*, as it is sometimes called, has now fallen into very general disuse.

EAR-RING, an ornament worn pendent from the ear, and generally suspended (especially among the more civilized races) by means of a ring or hook passing through the pendulous lobe of the ear. Among savage races the impulse to decorate, or at any rate to modify the appearance of the ear, is almost universal. With such peoples the ear appendage is chiefly remarkable for its extravagant dimensions. Many examples may be seen in the ethnographic galleries of the British Museum. The Berawan people of Borneo use plugs through the lobe of the ear 3¼ in. in diameter. More extraordinary still is an example of a stone ear-plug worn by a Massai, 4½ in. in diameter and weighing 2 lb 14 oz. (*Man*, 1905, p. 22). It is stated that according to the Massai standard of fashion, the lobes of the ears should be enlarged so as to be capable of meeting above the head. Among the superior races, though ear ornaments of extravagant size and elaboration are not unknown, moderation in size is commonly observed, and greater attention is paid to workmanship and fineness of material.

The general usage appears to have been to have ear-rings worn in pairs, the two ornaments in all respects resembling each other; in ancient times, or more recently among Oriental races, a single ear-ring has sometimes been worn. The use of this kind of ornament, which constantly was of great value, dates from the remotest historical antiquity, the earliest mention of ear-rings occurring in the book of Genesis. It appears probable that the ear-rings of Jacob's family, which he buried with his strange idols at Bethel, were regarded as amulets or talismans, such unquestionably being the estimation in which some ornaments of this class have been held from a very early period, as they still are held in the East. Thus in New Zealand ear-rings are decorated with the teeth of enemies, and with talismanic sharks' teeth. Among all the Oriental races of whom we have any accurate knowledge, the Hebrews and Egyptians excepted, ear-rings always have been in general use by both sexes; while in the West, as well as by the Hebrews and Egyptians, as a general rule they have been considered exclusively female ornaments. By the Greeks and Romans also ear-rings were worn only by women, and the wearing of them by a man is often spoken of as distinctively oriental.

In archaic art, ear-rings are frequently represented or their traces are left in the perforated ear lobes of early statues. After the 4th century such perforations occur seldom. In one instance,

a Greek inscription records the weight of the detachable gold ornaments on a statue, among which a pair of ear-rings is included. Ear-rings of characteristic form are frequently discovered by excavation. In Egypt, a system of pendent chains is found hanging from a disk. In Assyria the decoration consists of pendants or knobs attached to a rigid ring. In the early civilization represented by Dr Schliemann's Trojan investigations, pieces of gold plate are suspended by parallel chains. In the Mycenaean period, ear-rings are infrequent in Greece, but have been found in abundance in the Mycenaean finds of Enkomi (Cyprus) in the form of pendent bulls'-heads, or of decorative forms based on the bull's head. In the tombs of the Greek settlers in the Crimea (4th century B.C.), ear-rings are found of marvellous complexity and beauty. The lexicographer Pollux, speaking of the names given to ear-rings, derived from their forms, mentions caryatids, hippocamps and centaureses. Jewels of the same class, of exquisite beauty and



From *La Grande Encyclopédie*.

FIG. 1.—Ear-ring from an Assyrian bas-relief.

of workmanship that is truly wonderful, have been rescued from the sepulchres of ancient Etruria. Ear-rings of comparatively simple forms, but set with pearls and other stones, were the mode in Rome. In some instances, the stones were of fabulous value. During the Byzantine period they once more attained an extravagant size. Researches among the burial places of Anglo-Saxon Britain have led to the discovery of jewels in considerable numbers, which among their varieties include ear-rings executed in a style that proves the Anglo-Saxons to have made no inconsiderable advances in the arts of civilization.

These same ornaments, which never have fallen into disuse, enjoy at the present day a considerable degree of favour, and the tide of fashion has set towards their increased use. Like all other modern jewels, however, the earrings of our own times as works of art can claim no historical attributes, because they consist as well of reproductions from all past ages and of every race as of fanciful productions that certainly can be assigned to no style of art whatever.

As one of the curiosities of the subject it may be mentioned that Antonia, wife of Drusus, is said by Pliny to have attached a pair of ear-rings to her pet lamprey.

EARTH (a word common to Teutonic languages, cf. Ger. *Erde*, Dutch *aarde*, Swed. and Dan. *jord*; outside Teutonic it appears only in the Gr. *ἔρως*, on the ground; it has been connected by some etymologists with the Aryan root *ar-*, to plough, which is seen in the Lat. *arare*, obsolete Eng. "ear," and Gr. *ἄροισ*, but this is now considered very doubtful; see G. Curtius, *Greek Etymology*, Eng. trans., i. 426; Max Müller, *Lectures*, 8th ed. i. 294). From early times the word "earth" has been used in several connexions—from that of soil or ground to that of the planet which we inhabit, but it is difficult to trace the exact historic sequence of the diverse usages. In the cosmogony of the Pythagoreans, Platonists and other philosophers, the term or its equivalent denoted an element or fundamental quality which conferred upon matter the character of earthiness; and in the subsequent development of theories as to the ultimate composition of matter by the alchemists, iatrochemists, and early phlogistonists an element of the same name was retained (see ELEMENT). In modern chemistry, the common term "earth" is applied to certain oxides:—the

"alkaline earths" (*q.v.*) are the oxides of calcium (lime), barium (baryta) and strontium (strontia); the "rare earths" (*q.v.*) are the oxides of a certain class of rare metals.

THE EARTH

The terrestrial globe is a member of the Solar system, the third in distance from the Sun, and the largest within the orbit of Jupiter. In the wider sense it may be regarded as composed of a gaseous atmosphere (see METEOROLOGY), which encircles the crust or lithosphere (see GEOGRAPHY), and surface waters or hydrosphere (see OCEAN AND OCEANOGRAPHY). The description of the surface features is a branch of Geography, and the discussions as to their origin and permanence belongs to Physiography (in the narrower sense), physiographical geology, or physical geography. The investigation of the crust belongs to geology and of rocks in particular to petrology.

In the present article we shall treat the subject matter of the Earth as a planet under the following headings:—(1) Figure and Size, (2) Mass and Density, (3) Astronomical Relations, (4) Evolution and Age. These subjects will be treated summarily, readers being referred to the article ASTRONOMY and to the cross-references for details.

1. *Figure and Size*.—To primitive man the Earth was a flat disk with its surface diversified by mountains, rivers and seas. In many cosmogonies this disk was encircled by waters, unmeasurable by man and extending to a junction with the sky; and the disk stood as an island rising up through the waters from the floor of the universe, or was borne as an immovable ship on the surface. Of such a nature was the cosmogony of the Babylonians and Hebrews; Homer states the same idea, naming the encircling waters *Ἠεωπείη*; and Hesiod regarded it as a disk midway between the sky and the infernal regions. The theory that the Earth extended downwards to the limit of the universe was subjected to modification when it was seen that the same sun and stars reappeared in the east after their setting in the west. But man slowly realized that the earth was isolated in space, floating freely as a balloon, and much speculation was associated about that which supported the Earth. Tunnels in the foundations to permit the passage of the sun and stars were suggested; the Greeks considered twelve columns to support the heavens, and in their mythology the god Atlas appears condemned to support the columns; while the Egyptians had the Earth supported by four elephants, which themselves stood on a tortoise swimming on a sea. Earthquakes were regarded as due to a movement of these foundations; in Japan this was considered to be due to the motion of a great spider, an animal subsequently replaced by a cat-fish; in Mongolia it is a hog; in India, a mole; in some parts of South America, a whale; and among some of the North American Indians, a giant tortoise.

The doctrine of the spherical form has been erroneously assigned to Thales; but he accepted the Semitic conception of the disk, and regarded the production of springs after earthquakes as due to the intruding of the waters under the Earth into fissures in the surface. His pupil, Anaximander (610-547), according to Diogenes Laërtius, believed it to be spherical (see *The Observatory*, 1894, P. 208); and Anaximenes probably held a similar view. The spherical form is undoubtedly a discovery of Pythagoras, and was taught by the Pythagoreans and by the Eleatic Parmenides. The expositor of greatest moment was Aristotle; his arguments are those which we employ to-day—the ship gradually disappearing from hull to mast as it recedes from the harbour to the horizon; the circular shadow cast by the Earth on the Moon during an eclipse, and the alteration in the appearance of the heavens as one passes from point to point on the Earth's surface.¹ He records attempts made to determine the circumference; but the first scientific investigation in this

¹ Aristotle regarded the Earth as having an upper inhabited half and a lower uninhabited one, and the air on the lower half as tending to flow upwards through the Earth. The obstruction of this passage brought about an accumulation of air within the Earth, and the increased pressure may occasion oscillations of the surface, which may be so intense as to cause earthquakes.

direction was made 150 years later by Eratosthenes. The spherical form, however, only became generally accepted after the Earth's circumnavigation (see GEOGRAPHY).

The historical development of the methods for determining the figure of the Earth (by which we mean a theoretical surface in part indicated by the ocean at rest, and in other parts by the level to which water freely communicating with the oceans by canals traversing the land masses would rise) and the mathematical investigation of this problem are treated in the articles EARTH, FIGURE OF THE, and GEODESY; here the results are summarized. Sir Isaac Newton deduced from the mechanical consideration of the figure of equilibrium of a mass of rotating fluid, the form of an oblate spheroid, the ellipticity of a meridian section being $1/231$, and the axes in the ratio 230:231. Geodetic measurements by the Cassinis and other French astronomers pointed to a prolate form, but the Newtonian figure was proved to be correct by the measurement of meridional arcs in Peru and Lapland by the expeditions organized by the French Academy of Sciences. More recent work points to an elliptical equatorial section, thus making the earth pear-shaped. The position of the longer axis is somewhat uncertain; it is certainly in Africa, Clarke placing it in longitude $8^{\circ} 15' W.$, and Schubert in longitude $41^{\circ} 4' E.$; W. J. Sollas, arguing from terrestrial symmetry, has chosen the position lat. $6^{\circ} N.$, long. $28^{\circ} E.$, i.e. between Clarke's and Schubert's positions. For the lengths of the axes and the ellipticity of the Earth, see EARTH, FIGURE OF THE.

2. *Mass and Density.*—The earliest scientific investigation on the density and mass of the Earth (the problem is really single if the volume of the Earth be known) was made by Newton, who, mainly from astronomical considerations, suggested the limiting densities 5 and 6; it is remarkable that this prophetic guess should be realized, the mean value from subsequent researches being about $5\frac{1}{2}$, which gives for the mass the value 6×10^{21} tons. The density of the Earth has been determined by several experimenters within recent years by methods described in the article GRAVITATION; the most probable value is there stated to be 5.527 .

3. *Astronomical Relations.*—The grandest achievements of astronomical science are undoubtedly to be associated with the elucidation of the complex motion of our planet. The notion that the Earth was fixed and immovable at the centre of an immeasurable universe long possessed the minds of men; and we find the illustrious Ptolemy accepting this view in the 2nd century A.D., and rejecting the notion of a rotating Earth—a theory which had been proposed as early as the 5th century B.C. by Philolaus on philosophical grounds, and in the 3rd century B.C. by the astronomer Aristarchus of Samos. He argued that if the Earth rotated then points at the equator had the enormous velocity of about 1000 m. per hour, and as a consequence there should be terrific gales from the east; the fact that there were no such gales invalidated, in his opinion, the theory. The Ptolemaic theory was unchallenged until 1543, in which year the *De Revolutionibus orbium Coelestium* of Copernicus was published. In this work it was shown that the common astronomical phenomena could be more simply explained by regarding the Earth as annually revolving about a fixed Sun, and daily rotating about itself. A clean sweep was made of the geocentric epicyclic motions of the planets which Ptolemy's theory demanded, and in place there was substituted a procession of planets about the Sun at different distances. The development of the Copernican theory—the corner-stone of modern astronomy—by Johann Kepler and Sir Isaac Newton is treated in the article ASTRONOMY: History; here we shall summarily discuss the motions of our planet and its relation to the solar system.

The Earth has two principal motions—revolution about the Sun, rotation about its axis; there are in addition a number of secular motions.

Revolution.—The Earth revolves about the Sun in an elliptical orbit having the Sun at one focus. The plane of the orbit is termed the ecliptic; it is inclined to the Earth's equator at an angle termed the obliquity, and the points of intersection

of the equator and ecliptic are termed the equinoctial points. The major axis of the ellipse is the line of apsides; when the Earth is nearest the Sun it is said to be in perihelion, when farthest it is in aphelion. The mean distance of the Earth from the Sun is a most important astronomical constant, since it is the unit of linear measurement; its value is about 93,000,000 m., and the difference between the perihelion and aphelion distances is about 3,000,000 m. The eccentricity of the orbit is 0.016751. A tabular comparison of the orbital constants of the Earth and the other planets is given in the article PLANET. The period of revolution with regard to the Sun, or, in other words, the time taken by the Sun apparently to pass from one equinox to the same equinox, is the tropical or equinoctial year; its length is 365 d. 5 hrs. 48 m. 46 sec. It is about 20 minutes shorter than the true or sidereal year, which is the time taken for the Sun apparently to travel from one star to it again. The difference in these two years is due to the secular variation termed precession (see below). A third year is named the *anomalous year*, which is the time occupied in the passage from perihelion to perihelion; it is a little longer than the sidereal.

Rotation.—The Earth rotates about an axis terminating at the north and south geographical poles, and perpendicular to the equator; the period of rotation is termed the day (*q.v.*), of which several kinds are distinguished according to the body or point of reference. The rotation is performed from west to east; this daily rotation occasions the *diurnal* motion of the celestial sphere, the rising of the Sun and stars in the east and their setting in the west, and also the phenomena of day and night. The inclination of the axis to the ecliptic brings about the presentation of places in different latitudes to the more direct rays of the sun; this is revealed in the variation in the length of daylight with the time of the year, and the phenomena of seasons.

Although the rotation of the Earth was an accepted fact soon after its suggestion by Copernicus, an experimental proof was wanting until 1851, when Foucault performed his celebrated pendulum experiment at the Pantheon, Paris. A pendulum about 200 ft. long, composed of a flexible wire carrying a heavy iron bob, was suspended so as to be free to oscillate in any direction. The bob was provided with a style which passed over a table strewn with fine sand, so that the style traced the direction in which the bob was swinging. It was found that the oscillating pendulum never retraced its path, but at each swing it was apparently deviated to the right, and moreover the deviations in equal times were themselves equal. This means that the floor of the Pantheon was moving, and therefore the Earth was rotating. If the pendulum were swung in the southern hemisphere, the deviation would be to the left; if at the equator it would not deviate, while at the poles the plane of oscillation would traverse a complete circle in 24 hours.

The rotation of the Earth appears to be perfectly uniform, comparisons of the times of transits, eclipses, &c., point to a variation of less than $1/1000$ th of a second since the time of Ptolemy. Theoretical investigations on the phenomena of tidal friction point, however, to a retardation, which may to some extent be diminished by the accelerations occasioned by the shrinkage of the globe, and some other factors difficult to evaluate (see TIME).

We now proceed to the secular variations.

Precession.—The axis of the earth does not preserve an invariable direction in space, but in a certain time it describes a cone, in much the same manner as the axis of a top spinning out of the vertical. The equator, which preserves approximately the same inclination to the ecliptic (there is a slight variation in the obliquity which we shall mention later), must move so that its intersections with the ecliptic, or equinoctial points, pass in a retrograde direction, i.e. opposite to that of the Earth. This motion is termed the precession of the equinoxes, and was observed by Hipparchus in the 2nd century B.C.; Ptolemy corrected the catalogue of Hipparchus for precession by adding $2^{\circ} 46'$ to the longitudes, the latitudes being unaltered by this motion, which at the present time is $50''$ annually, the complete circuit being made in about 26,000 years. Owing to precession the signs of the zodiac are traversing paths through the constellations, or,

in other words, the constellations are continually shifting with regard to the equinoctial points; at one time the vernal equinox Aries was in the constellations of that name; it is now in Pisces, and will then pass into Aquarius. The pole star, *i.e.* the star towards which the Earth's axis points, is also shifting owing to precession; in about 2700 B.C. the Chinese observed a Draconis as the pole star (at present a *Ursae minoris* occupies this position and will do so until 3500); in 13600 Vega (a *Lyrae*) the brightest star in the Northern hemisphere, will be nearest.

Precession is the result of the Sun and the Moon's attraction on the Earth not being a single force through its centre of gravity. If the Earth were a homogeneous sphere the attractions would act through the centre, and such forces would have no effect upon the rotation about the centre of gravity, but the Earth being spheroidal the equatorial band which stands up as it were beyond the surface of a sphere is more strongly attracted, with the result that the axis undergoes a tilting. The precession due to the Sun is termed the *solar precession* and that due to the Moon the *lunar precession*; the joint effect (two-thirds of which is due to the Moon) is the *luni-solar precession*. Solar precession is greatest at the solstices and zero at the equinoxes; the part of luni-solar precession due to the Moon varies with the position of the Moon in its orbit. The obliquity is unchanged by precession (see PRECESSION OF THE EQUINOXES).

Nutation.—In treating precession we have stated that the axis of the Earth traces a cone, and it follows that the pole describes a circle (approximately) on the celestial sphere, about the pole of the ecliptic. This is not quite true. Irregularities in the attracting forces which occasion precession also cause a slight oscillation backwards and forwards over the mean precessional path of the pole, the pole tracing a wavy line or nodding. Both the Sun and Moon contribute to this effect. Solar nutation depends upon the position of the Sun on the ecliptic; its period is therefore 1 year, and in extent it is only 1.2"; lunar nutation depends upon the position of the Moon's nodes; its period is therefore about 18.6 years, the time of revolution of the nodes, and its extent is 0.2". There is also given to the obliquity a small oscillation to and fro. Nutation is one of the great discoveries of James Bradley (1747).

Planetary Precession.—So far we have regarded the ecliptic as absolutely fixed, and treated precession as a real motion of the equator. The ecliptic (*q.v.*), however, is itself subject to a motion, due to the attractions of the planets on the Earth. This effect also displaces the equinoctial points. Its annual value is 0.13". The term General Precession in longitude is given to the displacement of the intersection of the equator with the apparent ecliptic on the latter. The standard value is 50.2453", which prevailed in 1850, and the value at 1850 + *t*, *i.e.* the constant of precession, is 50.2453" + 0.0002225" *t*. This value is also liable to a very small change. The nutation of the obliquity at time 1850 + *t* is given by the formula $23^{\circ} 27' 32.0'' - 0.47'' t$. Complete expressions for these functions are given in Newcomb's *Spherical Astronomy* (1908), and in the *Nautical Almanac*.

The variation of the *line of apsides* is the name given to the motion of the major axis of the Earth's orbit about the ecliptic. It is due to the general influence of the planets, and the revolution is effected in 21,000 years.

The variation of the eccentricity denotes an oscillation of the form of the Earth's orbit between a circle and ellipse. This followed the mathematical researches of Lagrange and Leverrier. It was suggested by Sir John Herschel in 1830 that this variation might occasion great climatic changes, and James Croll developed the theory as affording a solution of the glacial periods in geology (*q.v.*).

Variation of Latitude.—Another secular motion of the Earth is due to the fact that the axis of rotation is not rigidly fixed within it, but its polar extremities wander in a circle of about 50 ft. diameter. This oscillation brings about a variability in terrestrial latitudes, hence the name. Euler showed mathematically that such an oscillation existed, and, making certain assumptions as to the rigidity of the Earth, deduced that its period was 305 days; S. C. Chandler, from 1890 onwards,

deduced from observations of the stars a period of 428 days; and Simon Newcomb explained the deviation of these periods by pointing out that Euler's assumption of a perfectly rigid Earth is not in accordance with fact. For details of this intricate subject see the articles LATITUDE and EARTH, FIGURE OF THE.

4. *Evolution and Age.*—In its earliest history the mass now consolidated as the Earth and Moon was part of a vast nebulous aggregate, which in the course of time formed a central nucleus—our Sun—which shed its outer layers in such a manner as to form the solar system (see NEBULAR THEORY). The moon may have been formed from the Earth in a similar manner, but the theory of tidal friction suggests the elongation of the Earth along an equatorial axis to form a pear-shaped figure, and that in the course of time the protuberance shot off to form the Moon (see TIDE). The age of the Earth has been investigated from several directions, as have also associated questions related to climatic changes, internal temperature, orientation of the land and water (permanence of oceans and continents), &c. These problems are treated in the articles GEOLOGY and GEOGRAPHY.

EARTH, FIGURE OF THE. The determination of the figure of the earth is a problem of the highest importance in astronomy, inasmuch as the diameter of the earth is the unit to which all celestial distances must be referred.

Historical.

Reasoning from the uniform level appearance of the horizon, the variations in altitude of the circumpolar stars as one travels towards the north or south, the disappearance of a ship standing out to sea, and perhaps other phenomena, the earliest astronomers regarded the earth as a sphere, and they endeavoured to ascertain its dimensions. Aristotle relates that the mathematicians had found the circumference to be 400,000 stadia (about 46,000 miles). But Eratosthenes (*c.* 250 B.C.) appears to have been the first who entertained an accurate idea of the principles on which the determination of the figure of the earth really depends, and attempted to reduce them to practice. His results were very inaccurate, but his method is the same as that which is followed at the present day—depending, in fact, on the comparison of a line measured on the earth's surface with the corresponding arc of the heavens. He observed that at Syene in Upper Egypt, on the day of the summer solstice, the sun was exactly vertical, whilst at Alexandria at the same season of the year its zenith distance was $7^{\circ} 12'$, or one-fiftieth of the circumference of a circle. He assumed that these places were on the same meridian; and, reckoning their distance apart as 5000 stadia, he inferred that the circumference of the earth was 250,000 stadia (about 29,000 miles). A similar attempt was made by Posidonius, who adopted a method which differed from that of Eratosthenes only in using a star instead of the sun. He obtained 240,000 stadia (about 27,600 miles) for the circumference. Ptolemy in his *Geography* assigns the length of the degree as 500 stadia.

The Arabs also investigated the question of the earth's magnitude. The caliph Abdallah al Mamun (A.D. 814), having fixed on a spot in the plains of Mesopotamia, despatched one company of astronomers northwards and another southwards, measuring the journey by rods, until each found the altitude of the pole to have changed one degree. But the result of this measurement does not appear to have been very satisfactory. From this time the subject seems to have attracted no attention until about 1500, when Jean Fernel (1497-1558), a Frenchman, measured a distance in the direction of the meridian near Paris by counting the number of revolutions of the wheel of a carriage. His astronomical observations were made with a triangle used as a quadrant, and his resulting length of a degree was very near the truth.

Willebrord Snell¹ substituted a chain of triangles for actual linear measurement. He measured his base line on the frozen surface of the meadows near Leiden, and measured the angles of his triangles, which lay between Alkmaar and Bergen-op-Zoom, with a quadrant and semicircles. He took the precaution of

¹ Eratosthenes — seu de terrae ambitus vera quantitate suscitatus — 160, Lugduni-Batavorum (1617).

comparing his standard with that of the French, so that his result was expressed in toises (the length of the toise is about 6.39 English ft.). The work was recomputed and reobserved by P. von Muschenbroek in 1729. In 1637 an Englishman, Richard Norwood, published a determination of the figure of the earth in a volume entitled *The Seaman's Practice, containing a Fundamentall Probleme in Navigation experimentally verified, namely, touching the Compasse of the Earth and Sea and the quantity of a Degree in our English Measures*. He observed on the 11th of June 1633 the sun's meridian altitude in London as $62^{\circ} 1'$, and on the 6th of June 1635, his meridian altitude in York as $59^{\circ} 33'$. He measured the distance between these places partly with a chain and partly by pacing. By this means, through compensation of errors, he arrived at 367,176 ft. for the degree—a very fair result.

The application of the telescope to angular instruments was the next important step. Jean Picard was the first who in 1669, with the telescope, using such precautions as the nature of the operation requires, measured an arc of meridian. He measured with wooden rods a base line of 5663 toises, and a second or base of verification of 3902 toises; his triangulation extended from Malvoisine, near Paris, to Sourdon, near Amiens. The angles of the triangles were measured with a quadrant furnished with a telescope having cross-wires. The difference of latitude of the terminal stations was determined by observations made with a sector on a star in Cassiopeia, giving $1^{\circ} 22' 55''$ for the amplitude. The terrestrial measurement gave 78,850 toises, whence he inferred for the length of the degree 57,060 toises.

Hitherto geodetic observations had been confined to the determination of the magnitude of the earth considered as a sphere, but a discovery made by Jean Richer (d. 1666) turned the attention of mathematicians to its deviation from a spherical form. This astronomer, having been sent by the Academy of Sciences of Paris to the island of Cayenne, in South America, for the purpose of investigating the amount of astronomical refraction and other astronomical objects, observed that his clock, which had been regulated at Paris to beat seconds, lost about two minutes and a half daily at Cayenne, and that in order to bring it to measure mean solar time it was necessary to shorten the pendulum by more than a line (about $\frac{1}{4}$ th of an in.). This fact, which was scarcely credited till it had been confirmed by the subsequent observations of Varin and Deshayes on the coasts of Africa and America, was first explained in the third book of Newton's *Principia*, who showed that it could only be referred to a diminution of gravity arising either from a protuberance of the equatorial parts of the earth and consequent increase of the distance from the centre, or from the counteracting effect of the centrifugal force. About the same time (1673) appeared Christian Huygens' *De Horologio Oscillatorio*, in which for the first time were found correct notions on the subject of centrifugal force. It does not, however, appear that they were applied to the theoretical investigation of the figure of the earth before the publication of Newton's *Principia*. In 1690 Huygens published his *De Causa Gravitatis*, which contains an investigation of the figure of the earth on the supposition that the attraction of every particle is towards the centre.

Between 1684 and 1718 J. and D. Cassini, starting from Picard's base, carried a triangulation northwards from Paris to Dunkirk and southwards from Paris to Collioure. They measured a base of 7246 toises near Perpignan, and a somewhat shorter base near Dunkirk; and from the northern portion of the arc, which had an amplitude of $2^{\circ} 12' 9''$, obtained for the length of a degree 56,960 toises; while from the southern portion, of which the amplitude was $0^{\circ} 18' 57''$, they obtained 57,097 toises. The immediate inference from this was that, the degree diminishing with increasing latitude, the earth must be a prolate spheroid. This conclusion was totally opposed to the theoretical investigations of Newton and Huygens, and accordingly the Academy of Sciences of Paris determined to apply a decisive test by the measurement of arcs at a great distance from each other—one in the neighbourhood of the equator, the other in a high latitude. Thus arose the celebrated expeditions of the French

academicians. In May 1735 Louis Godin, Pierre Bouguer and Charles Marie de La Condamine, under the auspices of Louis XV., proceeded to Peru, where, assisted by two Spanish officers, after ten years of laborious exertion, they measured an arc of $3^{\circ} 7'$, the northern end near the equator. The second party consisted of Pierre Louis Moreau de Maupertuis, Alexis Claude Clairault, Charles Étienne Louis Camus, Pierre Charles Lemonnier, and Regnaud Outhier, who reached the Gulf of Bothnia in July 1736; they were in some respects more fortunate than the first party, inasmuch as they completed the measurement of an arc near the polar circle of $57'$ amplitude and returned within sixteen months from the date of their departure.

The measurement of Bouguer and De la Condamine was executed with great care, and on account of the locality, as well as the manner in which all the details were conducted, it has always been regarded as a most valuable determination. The southern limit was at Tarqui, the northern at Cotchesqui. A base of 6172 toises was measured in the vicinity of Quito, near the northern extremity of the arc, and a second base of 5360 toises near the southern extremity. The mountainous nature of the country made the work very laborious, in some cases the difference of heights of two neighbouring stations exceeding 1 mile; and they had much trouble with their instruments, those with which they were to determine the latitudes proving untrustworthy. But they succeeded by simultaneous observations of the same star at the two extremities of the arc in obtaining very fair results. The whole length of the arc amounted to 176,945 toises, while the difference of latitudes was $3^{\circ} 7' 3''$. In consequence of a misunderstanding that arose between De la Condamine and Bouguer, their operations were conducted separately, and each wrote a full account of the expedition. Bouguer's book was published in 1749; that of De la Condamine in 1751. The toise used in this measure was afterwards regarded as the standard toise, and is always referred to as the *Toise of Peru*.

The party of Maupertuis, though their work was quickly despatched, had also to contend with great difficulties. Not being able to make use of the small islands in the Gulf of Bothnia for the trigonometrical stations, they were forced to penetrate into the forests of Lapland, commencing operations at Tornæ, a city situated on the mainland near the extremity of the gulf. From this, the southern extremity of their arc, they carried a chain of triangles northward to the mountain Kittis, which they selected as the northern terminus. The latitudes were determined by observations with a sector (made by George Graham) of the zenith distance of α and δ Draconis. The base line was measured on the frozen surface of the river Tornæ about the middle of the arc; two parties measured it separately, and they differed by about 4 in. The result of the whole was that the difference of latitudes of the terminal stations was $57' 29'' .6$, and the length of the arc 55,023 toises. In this expedition, as well as in that to Peru, observations were made with a pendulum to determine the force of gravity; and these observations coincided with the geodetic results in proving that the earth was an oblate and not prolate spheroid.

In 1740 was published in the Paris *Mémoires* an account, by Cassini de Thury, of a remeasurement by himself and Nicolas Louis de Lacaille of the meridian of Paris. With a view to determine more accurately the variation of the degree along the meridian, they divided the distance from Dunkirk to Collioure into four partial arcs of about two degrees each, by observing the latitude at five stations. The results previously obtained by J. and D. Cassini were not confirmed, but, on the contrary, the length of the degree derived from these partial arcs showed on the whole an increase with an increasing latitude. Cassini and Lacaille also measured an arc of parallel across the mouth of the Rhone. The difference of time of the extremities was determined by the observers at either end noting the instant of a signal given by flashing gunpowder at a point near the middle of the arc.

While at the Cape of Good Hope in 1752, engaged in various astronomical observations, Lacaille measured an arc of meridian of $1^{\circ} 13' 17''$, which gave him for the length of the degree 57,037

toises—an unexpected result, which has led to the remeasurement of the arc by Sir Thomas Maclear (see GEODESY).

Passing over the measurements made between Rome and Rimini and on the plains of Piedmont by the Jesuits Ruggiero Giuseppe Bosovich and Giovanni Battista Beccaria, and also the arc measured with deal rods in North America by Charles Mason and Jeremiah Dixon, we come to the commencement of the English triangulation. In 1783, in consequence of a representation from Cassini de Thury on the advantages that would accrue from the geodetic connexion of Paris and Greenwich, General William Roy was, with the king's approval, appointed by the Royal Society to conduct the operations on the part of England, Count Cassini, Méchain and Delambre being appointed on the French side. A precision previously unknown was attained by the use of Ramsden's theodolite, which was the first to make the spherical excess of triangles measurable. The wooden rods with which the first base was measured were replaced by glass rods, which were afterwards rejected for the steel chain of Ramsden. (For further details see *Account of the Trigonometrical Survey of England and Wales*.)

Shortly after this, the National Convention of France, having agreed to remodel their system of weights and measures, chose for their unit of length the ten-millionth part of the meridian quadrant. In order to obtain this length precisely, the remeasurement of the French meridian was resolved on, and deputed to J. B. J. Delambre and Pierre François André Méchain. The details of this operation will be found in the *Base du système métrique décimale*. The arc was subsequently extended by Jean Baptiste Biot and Dominique François Jean Arago to the island of Iviza. Operations for the connexion of England with the continent of Europe were resumed in 1821 to 1823 by Henry Kater and Thomas Frederick Colby on the English side, and F. J. D. Arago and Claude Louis Mathieu on the French.

The publication in 1838 of Friedrich Wilhelm Bessel's *Gradmessung in Ostpreussen* marks an era in the science of geodesy. Here we find the method of least squares applied to the calculation of a network of triangles and the reduction of the observations generally. The systematic manner in which all the observations were taken with the view of securing final results of extreme accuracy is admirable. The triangulation, which was a small one, extended about a degree and a half along the shores of the Baltic in a N.N.E. direction. The angles were observed with theodolites of 12 and 15 in. diameter, and the latitudes determined by means of the transit instrument in the prime vertical—a method much used in Germany. (The base apparatus is described in the article GEODESY.)

The principal triangulation of Great Britain and Ireland, which was commenced in 1783 under General Roy, for the more immediate purpose of connecting the observatories of Greenwich and Paris, had been gradually extended, under the successive direction of Colonel E. Williams, General W. Mudge, General T. F. Colby, Colonel L. A. Hall, and Colonel Sir Henry James; it was finished in 1851. The number of stations is about 250. At 32 of these the latitudes were determined with Ramsden's and Airy's zenith sectors. The theodolites used for this work were, in addition to the two great theodolites of Ramsden which were used by General Roy and Captain Kater, a smaller theodolite of 18 in. diameter by the same mechanician, and another of 24 in. diameter by Messrs Troughton and Simms. Observations for determination of absolute azimuth were made with those instruments at a large number of stations; the stars α , δ , and λ Ursæ Minoris and ζ Cephei being those observed always at the greatest azimuths. At six of these stations the probable error of the result is under $0.4''$, at twelve under $0.5''$, at thirty-four under $0.7''$: so that the absolute azimuth of the whole network is determined with extreme accuracy. Of the seven base lines which have been measured, five were by means of steel chains and two with Colby's compensation bars (see GEODESY). The triangulation was computed by least squares. The total number of equations of condition for the triangulation is 920; if therefore the whole had been reduced in one mass, as it should have been, the solution of an equation of 920 unknown

quantities would have occurred as a part of the work. To avoid this an approximation was resorted to; the triangulation was divided into twenty-one parts or figures; four of these, not adjacent, were first adjusted by the method explained, and the corrections thus determined in these figures carried into the equations of condition of the adjacent figures. The average number of equations in a figure is 44; the largest equation is one of 77 unknown quantities. The vertical limb of Airy's zenith sector is read by four microscopes, and in the complete observation of a star there are 10 micrometer readings and 12 level readings. The instrument is portable; and a complete determination of latitude, affected with the mean of the declination errors of two stars, is effected by two micrometer readings and four level readings. The observation consists in measuring with the telescope micrometer the difference of zenith distances of two stars which cross the meridian, one to the north and the other to the south of the observer at zenith distances which differ by not much more than $10'$ or $15'$, the interval of the times of transit being not less than one nor more than twenty minutes. The advantages are that, with simplicity in the construction of the instrument and facility in the manipulation, refraction is eliminated (or nearly so, as the stars are generally selected within 25° of the zenith), and there is no large divided circle. The telescope, which is counterpoised on one side of the vertical axis, has a small circle for finding, and there is also a small horizontal circle. This instrument is universally used in American geodesy.

The principal work containing the methods and results of these operations was published in 1853 with the title "Ordnance Trigonometrical Survey of Great Britain and Ireland. Account of the observations and calculations of the principal triangulation and of the figure, dimensions and mean specific gravity of the earth as derived therefrom. Drawn up by Captain Alexander Ross Clarke, R.E., F.R.A.S., under the direction of Lieut.-Colonel H. James, R.E., F.R.S., M.R.I.A., &c." A supplement appeared in 1862: "Extension of the Triangulation of the Ordnance Survey into France and Belgium, with the measurement of an arc of parallel in 52° N. from Valencia in Ireland to Mount Kemmel in Belgium. Published by . . . Col. Sir Henry James."

Extensive operations for surveying India and determining the figure of the earth were commenced in 1800. Colonel W. Lambton started the great meridian arc at Punnae in latitude $8^\circ 9'$, and, following generally the methods of the English survey, he carried his triangulation as far north as $20^\circ 30'$. The work was continued by Sir George (then Captain) Everest, who carried it to the latitude of $29^\circ 30'$. Two admirable volumes by Sir George Everest, published in 1830 and in 1847, give the details of this undertaking. The survey was afterwards prosecuted by Colonel T. T. Walker, R.E., who made valuable contributions to geodesy. The working out of the Indian chains of triangle by the method of least squares presents peculiar difficulties, but, enormous in extent as the work was, it has been thoroughly carried out. The ten base lines on which the survey depends were measured with Colby's compensation bars.

The survey is detailed in eighteen volumes, published at Dehra Dun, and entitled *Account of the Operations of the Great Trigonometrical Survey of India*. Of these the first nine were published under the direction of Colonel Walker; and the remainder by Colonels Strahan and St G. C. Gore, Major S. G. Burrard and others. Vol. i., 1870, treats of the base lines; vol. ii., 1879, history and general descriptions of the principal triangulation and of its reduction; vol. v., 1879, pendulum operations (Captains T. P. Basevi and W. T. Heavyside); vols. xi., 1890, and xviii., 1906, latitudes; vols. ix., 1883, x., 1887, xv., 1893, longitudes; vol. xvii., 1901, the Indo-European longitude-arcs from Karachi to Greenwich. The other volumes contain the triangulations.

In 1860 Friedrich Georg Wilhelm Struve published his *Arc du méridien de $25^\circ 20'$ entre le Danube et la Mer Glaciale mesuré depuis 1816 jusqu'en 1855*. The latitudes of the thirteen astronomical stations of this arc were determined partly with vertical circles and partly by means of the transit instrument in the prime vertical. The triangulation, a great part of which, however, is a simple chain of triangles, is reduced by the method of least squares, and the probable errors of the resulting distances of parallels is given; the probable error of the whole arc in length is $3\frac{1}{2}$ toises. Ten base lines were measured. The sum

lengths of the ten measured bases is 29,863 toises, so that the average length of a base line is 19,100 ft. The azimuths were observed at fourteen stations. In high latitudes the determination of the meridian is a matter of great difficulty; nevertheless the azimuths at all the northern stations were successfully determined,—the probable error of the result at Fugienæs being $\approx 0''\cdot 53$.

Before proceeding with the modern developments of geodetic measurements and their application to the figure of the earth, we must discuss the "mechanical theory," which is indispensable for a full understanding of the subject.

Mechanical Theory.

Newton, by applying his theory of gravitation, combined with the so-called centrifugal force, to the earth, and assuming that an oblate ellipsoid of rotation is a form of equilibrium for a homogeneous fluid rotating with uniform angular velocity, obtained the ratio of the axes 229 : 230, and the law of variation of gravity on the surface. A few years later Huygens published an investigation of the figure of the earth, supposing the attraction of every particle to be towards the centre of the earth, obtaining as a result that the proportion of the axes should be 578 : 579. In 1740 Colin Maclaurin, in his *De causa physica fluxus et refluxus maris*, demonstrated that the oblate ellipsoid of revolution is a figure which satisfies the conditions of equilibrium in the case of a revolving homogeneous fluid mass, whose particles attract one another according to the law of the inverse square of the distance; he gave the equation connecting the ellipticity with the proportion of the centrifugal force at the equator to gravity, and determined the attraction on a particle situated anywhere on the surface of such a body. In 1743 Clairault published his *Théorie de la figure de la terre*, which contains a remarkable theorem ("Clairault's Theorem"), establishing a relation between the ellipticity of the earth and the variation of gravity from the equator to the poles. Assuming that the earth is composed of concentric ellipsoidal strata having a common axis of rotation, each stratum homogeneous in itself, but the ellipticities and densities of the successive strata varying according to any law, and that the superficial stratum has the same form as if it were fluid, he proved that

$$\frac{g' - g}{g} + e = \frac{1}{2}m,$$

where g , g' are the amounts of gravity at the equator and at the pole respectively, e the ellipticity of the meridian (or "flattening"), and m the ratio of the centrifugal force at the equator to g . He also proved that the increase of gravity in proceeding from the equator to the poles is as the square of the sine of the latitude. This, taken with the former theorem, gives the means of determining the earth's ellipticity from observation of the relative force of gravity at any two places. P. S. Laplace, who devoted much attention to the subject, remarks on Clairault's work that "the importance of all his results and the elegance with which they are presented place this work amongst the most beautiful of mathematical productions" (Isaac Todhunter's *History of the Mathematical Theories of Attraction and the Figure of the Earth*, vol. 1. p. 229).

The problem of the figure of the earth treated as a question of mechanics or hydrostatics is one of great difficulty, and it would be quite impracticable but for the circumstance that the surface differs but little from a sphere. In order to express the forces at any point of the body arising from the attraction of its particles, the form of the surface is required, but this form is the very one which it is the object of the investigation to discover; hence the complexity of the subject, and even with all the present resources of mathematicians only a partial and imperfect solution can be obtained.

We may here briefly indicate the line of reasoning by which some of the most important results may be obtained. If X , Y , Z be the components parallel to three rectangular axes of the forces acting on a particle of a fluid mass at the point x , y , z , then, ρ being the pressure there, and ρ the density,

$$d\rho = \rho(Xdx + Ydy + Zdz);$$

and for equilibrium the necessary conditions are, that $\rho(Xdx + Ydy + Zdz)$ be a complete differential, and at the free surface $Xdx + Ydy + Zdz = 0$. This equation implies that the resultant of the forces is normal to the surface at every point, and in a homogeneous fluid it is obviously the differential equation of all surfaces of equal pressure. If the fluid be heterogeneous then it is to be remarked that for forces of attraction according to the ordinary law of gravitation, if X , Y , Z be the components of the attraction of a mass whose potential is V , then

$$Xdx + Ydy + Zdz = \frac{dV}{dx}dx + \frac{dV}{dy}dy + \frac{dV}{dz}dz,$$

which is a complete differential. And in the case of a fluid rotating with uniform velocity, in which the so-called centrifugal force enters as a force acting on each particle proportional to its distance from the axis of rotation, the corresponding part of $Xdx + Ydy + Zdz$ is obviously a complete differential. Therefore for the forces with which we are now concerned $Xdx + Ydy + Zdz = dU$, where U is some function of x , y , z , and it is necessary for equilibrium that $d\rho = \rho dU$ be a complete differential; that is, ρ must be a function of U or a function of ρ , and so also ρ a function of U . So that $dU = 0$ is the differential equation of surfaces of equal pressure and density.

We may now show that a homogeneous fluid mass in the form of an oblate ellipsoid of revolution having a uniform velocity of rotation can be in equilibrium. It may be proved that the attraction of the ellipsoid $x^2 + y^2 + z^2(1 + e) = c^2(1 + e)$ upon a particle P of its mass at x , y , z has for components

$$X = -Ax, Y = -Ay, Z = -Cz,$$

where

$$A = 2\pi k^2 \rho \left(\frac{1 + e}{e} \tan^{-1} e - \frac{1}{2} \right),$$

$$C = 4\pi k^2 \rho \left(\frac{1 + e}{e} - \frac{1 + e}{2} \tan^{-1} e \right),$$

and k^2 the constant of attraction. Besides the attraction of the mass of the ellipsoid, the centrifugal force at P has for components $+x\omega^2$, $+y\omega^2$, 0 ; then the condition of fluid equilibrium is

$$(A - \omega^2)x dx + (A - \omega^2)y dy + Cdz = 0,$$

which by integration gives

$$(A - \omega^2)(x^2 + y^2) + Cz^2 = \text{const.}$$

This is the equation of an ellipsoid of rotation, and therefore the equilibrium is possible. The equation coincides with that of the surface of the fluid mass if we make

$$A - \omega^2 = C/(1 + e),$$

which gives

$$\frac{\omega^2}{2\pi k^2 \rho} = \frac{3 + e}{e} \tan^{-1} e - \frac{3}{2}.$$

In the case of the earth, which is nearly spherical, we obtain by expanding the expression for ω^2 in powers of e , rejecting the higher powers, and remarking that the ellipticity $e = \frac{1}{2}f$,

$$\omega^2/2\pi k^2 \rho = 4f^2/15 = 86/15.$$

Now if m be the ratio of the centrifugal force to the intensity of gravity at the equator, and $a = c/(1 + e)$, then

$$m = \omega^2/12k^2 \rho a, \therefore \omega^2/2\pi k^2 \rho = \frac{1}{2}m.$$

In the case of the earth it is a matter of observation that $m = 1/289$, hence the ellipticity

$$e = 5m/4 = 1/231,$$

so that the ratio of the axes on the supposition of a homogeneous fluid earth is 230 : 231, as stated by Newton.

Now, to come to the case of a heterogeneous fluid, we shall assume that its surfaces of equal density are spheroidal, concentric and having a common axis of rotation, and that the ellipticity of these surfaces varies from the centre to the outer surface, the density also varying. In other words, the body is composed of homogeneous spheroidal shells of variable density and ellipticity. On this supposition we shall express the attraction of the mass upon a particle in its interior, and then, taking into account the centrifugal force, form the equation expressing the condition of fluid equilibrium. The attraction of the homogeneous spheroid $x^2 + y^2 + z^2(1 + e) = c^2(1 + 2e)$, where e is the ellipticity (of which the square is neglected), on an internal particle, whose co-ordinates are $x = r$, $y = 0$, $z = s$, has for its x and s components

$$X' = -\frac{1}{2}\pi k^2 \rho (1 - \frac{1}{2}e), Z' = -\frac{1}{2}\pi k^2 \rho s(1 + \frac{1}{2}e),$$

the Y component being of course zero. Hence we infer that the attraction of a shell whose inner surface has an ellipticity e , and its outer surface an ellipticity $e + de$, the density being ρ , is expressed by

$$dX' = -\frac{1}{2}\pi k^2 \rho f de, dZ' = -\frac{1}{2}\pi k^2 \rho s de.$$

To apply this to our heterogeneous spheroid; if we put α for the semiaxis of that surface of equal density on which is situated the attracted point P , and α_0 for the semiaxis of the outer surface, the attraction of that portion of the body which is exterior to P , namely, of all the shells which enclose P , has for components

$$X_0 = -\frac{1}{2}\pi k^2 \rho \int_{\alpha_0}^{\alpha} \frac{d\alpha}{\alpha^2} d\alpha, Z_0 = -\frac{1}{2}\pi k^2 \rho \int_{\alpha_0}^{\alpha} \frac{d\alpha}{\alpha^2} d\alpha s,$$

both σ and ρ being functions of c . Again the attraction of a homogeneous spheroid of density ρ on an external point f, h has the components

$$\begin{aligned} X'' &= -\frac{4}{3}\pi\rho f r^2 [c^2(1+2e) - \lambda c^2], \\ Z'' &= -\frac{4}{3}\pi\rho h r^2 [c^2(1+2e) - \lambda c^2], \end{aligned}$$

$$\text{where } \lambda = \frac{1}{2}(4k^2 - f^2)/r^2, \lambda' = \frac{1}{2}(2k^2 - 3f^2)/r^2, \text{ and } r^2 = f^2 + h^2.$$

Now e being considered a function of c , we can at once express the attraction of a shell (density ρ) contained between the surface defined by $c+dc, \sigma+de$ and that defined by c, σ upon an external point; the differentials with respect to c , viz. $dX'' dZ''$, must then be integrated with ρ under the integral sign as being a function of c . The integration will extend from $c=0$ to $c=c_1$. Thus the components of the attraction of the heterogeneous spheroid upon a particle within its mass, whose co-ordinates are f, o, h , are

$$\begin{aligned} X &= -\frac{4}{3}\pi\rho f \left[\int_0^{c_1} \rho d[c^2(1+2e)] - \frac{\lambda}{2} \int_0^{c_1} \rho d(c^2) - \int_0^{c_1} \rho d\sigma \right], \\ Z &= -\frac{4}{3}\pi\rho h \left[\int_0^{c_1} \rho d[c^2(1+2e)] - \frac{\lambda}{2} \int_0^{c_1} \rho d(c^2) + \int_0^{c_1} \rho d\sigma \right]. \end{aligned}$$

We take into account the rotation of the earth by adding the centrifugal force $f\omega^2 = F$ to X . Now, the surface of constant density upon which the point f, o, h is situated gives $(1-2e)df + hdb = 0$; and the condition of equilibrium is that $(X+F)df + Zd\sigma = 0$. Therefore, $(X+F)h = Zf(1-2e)$,

which, neglecting small quantities of the order e^2 and putting $\omega^2 R^2 = 4s^2 k^2$, gives

$$\frac{2e}{c} \int_0^{c_1} \rho d[c^2(1+2e)] - \frac{6}{5} \int_0^{c_1} \rho d(c^2) - \frac{6}{5} \int_0^{c_1} \rho d\sigma = \frac{3F}{g}.$$

Here we must now put c for c_1 , c for r ; and $1+2e$ under the first integral sign may be replaced by unity, since small quantities of the second order are neglected. Two differentiations lead us to the following very important differential equation (Clairault):

$$\frac{d^2 e}{dc^2} + \frac{2ec}{f^2} \frac{de}{dc} + \left(\frac{2ec}{f^2} - \frac{6}{5} \right) e = 0.$$

When ρ is expressed in terms of c , this equation can be integrated. We infer then that a rotating spheroid of very small ellipticity, composed of fluid homogeneous strata such as we have specified, will be in equilibrium; and when the law of the density is expressed, the law of the corresponding ellipticities will follow.

If we put M for the mass of the spheroid, then

$$M = \frac{4\pi}{3} \int_0^{c_1} \rho d[c^2(1+2e)]; \text{ and } m = \frac{c}{M} \cdot \frac{4\pi}{3} \rho c^2$$

and putting $c = a$ in the equation expressing the condition of equilibrium, we find

$$M(2e - m) = \frac{4}{3}\pi \cdot \frac{6}{5} \int_0^a \rho d(c^2).$$

Making these substitutions in the expressions for the forces at the surface, and putting $r/c = 1 + e - \sigma(h/c)^3$, we get

$$\begin{aligned} G \cos \phi &= \frac{Mk^2}{ac} \left\{ 1 - e - \frac{3}{2}m + \left(\frac{5}{2}m - 2e \right) \frac{h^2}{a^2} \right\} \frac{f}{c} \\ G \sin \phi &= \frac{Mk^2}{ac} \left\{ 1 + e - \frac{3}{2}m + \left(\frac{5}{2}m - 2e \right) \frac{h^2}{a^2} \right\} \frac{h}{c}. \end{aligned}$$

Here G is gravity in the latitude ϕ , and a the radius of the equator. Since

$$\frac{\sec \phi}{ac} = \frac{c(f)}{ac} \left\{ 1 + e + \frac{eh^2}{a^2} \right\}, \quad G = \frac{Mk^2}{ac} \left\{ 1 - \frac{3}{2}m + \left(\frac{5}{2}m - 2e \right) \sin^2 \phi \right\},$$

an expression which contains the theorems we have referred to as discovered by Clairault.

The theory of the figure of the earth as a rotating ellipsoid has been especially investigated by Laplace in his *Mécanique céleste*. The principal English works are:—Sir George Airy, *Mathematical Tracts*, a lucid treatment without the use of Laplace's coefficients; Archdeacon Pratt's *Attractions and Figure of the Earth*; and O'Brien's *Mathematical Tracts*; in the last two Laplace's coefficients are used.

In 1845 Sir G. G. Stokes (*Comb. Trans.* viii.; see also *Comb. Dub. Math. Journ.*, 1849, iv.) proved that if the external form of the sea—imagined to percolate the land by canals—be a spheroid with small ellipticity, then the law of gravity is that which we have shown above; his proof required no assumption as to the ellipticity of the internal strata, or as to the past or present fluidity of the earth. This investigation admits of being regarded conversely, viz. as determining the elliptical form of the earth from measurements of gravity; if G , the observed value of gravity in latitude ϕ , be expressed in the form $G = g(1 + \beta \sin^2 \phi)$, where g is the value at the equator and β a coefficient. In this investigation, the square and higher powers

of the ellipticity are neglected; the solution was completed by F. R. Helmert with regard to the square of the ellipticity, who showed that a term with $\sin^2 \phi$ appeared (see Helmert, *Geodäsie*, ii. 83). For the coefficient of this term, the gravity measurements give a small but not sufficiently certain value; we therefore assume a value which agrees best with the hypothesis of the fluid state of the entire earth, this assumption is well supported, since even at a depth of only 50 km. the pressure of the superincumbent crust is so great that rocks become plastic, and behave approximately as fluids, and consequently the crust of the earth floats, to some extent, on the interior (even though this may not be fluid in the usual sense of the word). This is the geological theory of "Isostasis" (cf. Grotov); it agrees with the results of measurements of gravity (*vide infra*), and was brought forward in the middle of the 19th century by J. H. Pratt, who deduced it from observations made in India.

The $\sin^2 \phi$ term in the expression for G , and the corresponding deviation of the meridian from an ellipse, have been analytically established by Sir G. H. Darwin and E. Wiechert; earlier and less complete investigations were made by Sir G. B. Airy and O. Callandreau. In consequence of the $\sin^2 \phi$ term, two parameters of the level surfaces in the interior of the earth are to be determined; for this purpose, Darwin develops two differential equations in the place of the one by Clairault. By assuming Roche's law for the variation of the density in the interior of the Earth, viz. $\rho = \rho_1 - k(c/a)^3$, k being a coefficient, it is shown that in latitude 45° , the meridian is depressed about $3\frac{1}{2}$ metres from the ellipse, and the coefficient of the term $\sin^2 \phi \cos^2 \phi (= \frac{1}{2} \sin^2 \phi)$ is -0.0000295 . According to Wiechert the earth is composed of a kernel and a shell, the kernel being composed of material, chiefly metallic iron, of density near 8.2, and the shell, about 900 miles thick, of silicates, &c., of density about 3.2. On this assumption the depression in latitude 45° is 2½ metres, and the coefficient of $\sin^2 \phi \cos^2 \phi$ is, in round numbers, -0.0000280 .¹ To this additional term in the formula for G , there corresponds an extension of Clairault's formula for the calculation of the flattening from β with terms of the higher orders; this was first accomplished by Helmert.

For a long time the assumption of an ellipsoid with three unequal axes has been held possible for the figure of the earth, in consequence of an important theorem due to K. G. Jacobi, who proved that for a homogeneous fluid in rotation a spheroid is not the only form of equilibrium; an ellipsoid rotating round its least axis may with certain proportions of the axes and a certain time of revolution be a form of equilibrium.² It has been objected to the figure of three unequal axes that it does not satisfy, in the proportions of the axes, the conditions brought out in Jacobi's theorem ($c : a < 1/\sqrt{2}$). Admitting this, it has to be noted, on the other hand, that Jacobi's theorem contemplates a homogeneous fluid, and this is certainly far from the actual condition of our globe; indeed the irregular distribution of continents and oceans suggests the possibility of a sensible divergence from a perfect surface of revolution. We may, however, assume the ellipsoid with three unequal axes to be an interpolation form. More plausible forms are little adapted for computation.³ Consequently we now generally take the ellipsoid of rotation as a basis, especially so because measurements of gravity have shown that the deviation from it is but trifling.

Local Attraction.

In speaking of the figure of the earth, we mean the surface of the sea imagined to percolate the continents by canals. That

¹ O. Callandreau, "Mémoire sur la théorie de la figure des planètes," *Ann. obs. de Paris* (1889); G. H. Darwin, "The Theory of the Figure of the Earth carried to the Second Order of Small Quantities," *Mon. Not. R.A.S.*, 1899; E. Wiechert, "Über die Massenverteilung im Inneren der Erde," *Nach. d. kön. G. d. W. zu Göt.,* 1897. ² See I. Todhunter, *Proc. Roy. Soc.*, 1870. ³ J. H. Jeans, "On the Vibrations and Stability of a Gravitating Planet," *Proc. Roy. Soc.*, vol. 71; G. H. Darwin, "On the Figure and Stability of a liquid Satellite," *Phil. Trans.* 206, p. 161; A. E. H. Love, "The Gravitational Stability of the Earth," *Phil. Trans.* 207, p. 237; *ibid.* 80.

this surface should turn out, after precise measurements, to be exactly an ellipsoid of revolution is *a priori* improbable. Although it may be highly probable that originally the earth was a fluid mass, yet in the cooling whereby the present crust has resulted, the actual solid surface has been left most irregular in form. It is clear that these irregularities of the visible surface must be accompanied by irregularities in the mathematical figure of the earth, and when we consider the general surface of our globe, its irregular distribution of mountain masses, continents, with oceans and islands, we are prepared to admit that the earth may not be precisely any surface of revolution. Nevertheless, there must exist some spheroid which agrees very closely with the mathematical figure of the earth, and has the same axis of rotation. We must conceive this figure as exhibiting slight departures from the spheroid, the two surfaces cutting one another in various lines; thus a point of the surface is defined by its latitude, longitude, and its height above the "spheroid of reference." Calling this height *N*, then of the actual magnitude of this quantity we can generally have no information, it only obtrudes itself on our notice by its variations. In the vicinity of mountains it may change sign in the space of a few miles; *N* being regarded as a function of the latitude and longitude, if its differential coefficient with respect to the former be zero at a certain point, the normals to the two surfaces then will lie in the prime vertical; if the differential coefficient of *N* with respect to the longitude be zero, the two normals will lie in the meridian; if both coefficients are zero, the normals will coincide. The comparisons of terrestrial measurements with the corresponding astronomical observations have always been accompanied with discrepancies. Suppose *A* and *B* to be two trigonometrical stations, and that at *A* there is a disturbing-force drawing the vertical through an angle δ , then it is evident that the apparent zenith of *A* will be really that of some other place *A'*, whose distance from *A* is $r\delta$, when *r* is the earth's radius; and similarly if there be a disturbance at *B* of the amount δ' , the apparent zenith of *B* will be really that of some other place *B'*, whose distance from *B* is $r\delta'$. Hence we have the discrepancy that, while the geodetic measurements deal with the points *A* and *B*, the astronomical observations belong to the points *A'*, *B'*. Should δ, δ' be equal and parallel, the displacements *AA'*, *BB'* will be equal and parallel, and no discrepancy will appear. The non-recognition of this circumstance often led to much perplexity in the early history of geodesy. Suppose that, through the unknown variations of *N*, the probable error of an observed latitude (that is, the angle between the normal to the mathematical surface of the earth at the given point and that of the corresponding point on the spheroid of reference) be ϵ , then if we compare two arcs of a degree each in mean latitudes, and near each other, say about five degrees of latitude apart, the probable error of the resulting value of the ellipticity will be approximately $\pm \frac{1}{1776}\epsilon$, ϵ being expressed in seconds, so that if ϵ be so great as $2''$ the probable error of the resulting ellipticity will be greater than the ellipticity itself.

It is necessary at times to calculate the attraction of a mountain, and the consequent disturbance of the astronomical zenith, at any point within its influence. The deflection of the plumb-line, caused by a local attraction whose amount is $k^2 A\delta$, is measured by the ratio of $k^2 A\delta$ to the force of gravity at the station. Expressed in seconds, the deflection *A* is /

$$A = 12'' \cdot 447 A\delta / \rho,$$

where ρ is the mean density of the earth, δ that of the attracting mass, and $A = \int \frac{ds}{x^2}$, in which ds is a volume element of the attracting mass within the distance *s* from the point of deflection, and *x* the projection of *s* on the horizontal plane through this point, the linear unit in expressing *A* being a mile. Suppose, for instance, a table-land whose form is a rectangle of 12 miles by 8 miles, having a height of 500 ft. and density half that of the earth; let the observer be 2 miles distant from the middle point of the longer side. The deflection then is $1'' \cdot 472$; but at 1 mile it increases to $2'' \cdot 20$.

At sixteen astronomical stations in the English survey the

disturbance of latitude due to the form of the ground has been computed, and the following will give an idea of the results. At six stations the deflection is under $2''$, at six others it is between $2''$ and $4''$, and at four stations it exceeds $4''$. There is one very exceptional station on the north coast of Banffshire, near the village of Portsoy, at which the deflection amounts to $10''$, so that if that village were placed on a map in a position to correspond with its astronomical latitude, it would be 1000 ft. out of position! There is the sea to the north and an undulating country to the south, which, however, to a spectator at the station does not suggest any great disturbance of gravity. A somewhat rough estimate of the local attraction from external causes gives a maximum limit of $5''$, therefore we have $5''$ which must arise from unequal density in the underlying strata in the surrounding country. In order to throw light on this remarkable phenomenon, the latitudes of a number of stations between Nairn on the west, Fraserburgh on the east, and the Grampians on the south, were observed, and the local deflections determined. It is somewhat singular that the deflections diminish in all directions, not very regularly certainly, and most slowly in a south-west direction, finally disappearing, and leaving the maximum at the original station at Portsoy.

The method employed by Dr C. Hutton for computing the attraction of masses of ground is so simple and effectual that it can hardly be improved on. Let a horizontal plane pass through the given station; let *r, \theta* be the polar co-ordinates of any point in this plane, and *r, \theta, z*, the co-ordinates of a particle of the attracting mass; and let it be required to find the attraction of a portion of the mass contained between the horizontal planes $z=0, z=h$, the cylindrical surfaces $r=r_1, r=r_2$, and the vertical planes $\theta=\theta_1, \theta=\theta_2$. The component of the attraction at the station or origin along the line $\theta=\theta_0$ is

$$k^2 \int_{r_1}^{r_2} \int_{\theta_1}^{\theta_2} \int_0^h \frac{r^2 \cos \theta}{(r^2 + r^2)^{3/2}} dr d\theta dz$$

$$= k^2 \sin(\theta_2 - \theta_1) \log \left\{ \frac{r_2 + h}{r_1 + h} \sqrt{r_1^2 + h^2} / (r_1^2 + h^2) \right\}.$$

By taking $r_2 - r_1$, sufficiently small, and supposing h also small compared with $r_1 + r_2$ (as it usually is), the attraction is

$$k^2 (r_2 - r_1) (\sin \theta_2 - \sin \theta_1) h / r,$$

where $r = \frac{1}{2}(r_1 + r_2)$. This form suggests the following procedure. Draw on the contoured map a series of equidistant circles, concentric with the station, intersected by radial lines so disposed that the sines of their azimuths are in arithmetical progression. Then, having estimated from the map the mean heights of the various compartments, the calculation is obvious.

In mountainous countries, as near the Alps and in the Caucasus, deflections have been observed to the amount of as much as $30''$, while in the Himalayas deflections amounting to $60''$ were observed. On the other hand, deflections have been observed in flat countries, such as that noted by Professor K. G. Schweizer, who has shown that, at certain stations in the vicinity of Moscow, within a distance of 16 miles the plumb-line varies $16''$ in such a manner as to indicate a vast deficiency of matter in the underlying strata; deflections of $10''$ were observed in the level regions of north Germany.

Since the attraction of a mountain mass is expressed as a numerical multiple of $\delta : \rho$ the ratio of the density of the mountain to that of the earth, if we have any independent means of ascertaining the amount of the deflection, we have at once the ratio $\rho : \delta$, and thus we obtain the mean density of the earth, as, for instance, at Schiehallion, and afterwards at Arthur's Seat. Experiments of this kind for determining the mean density of the earth have been made in greater numbers; but they are not free from objection (see GRAVITATION).

Let us now consider the perturbation attending a spherical subterranean mass. A compact mass of great density at a small distance under the surface of the earth will produce an elevation of the mathematical surface which is expressed by the formula

$$y = a\rho \left[(1 - 2n \cos \theta + n^2)^{-1} - 1 \right],$$

where *a* is the radius of the (spherical) earth, $a(1 - n)$ the distance

of the disturbing mass below the surface, μ the ratio of the disturbing mass to the mass of the earth, and $a\theta$ the distance of any point on the surface from that point, say Q, which is vertically over the disturbing mass. The maximum value of y is at Q, where it is $y = \mu u (1 - u)$. The deflection at the distance $a\theta$ is $\Delta = \mu u \sin \theta (1 - 2u \cos \theta + u^2)^{-3/2}$, or since θ is small, putting $k + u = 1$, we have $\Delta = \mu \theta (k^2 + \theta^2)^{-3/2}$. The maximum deflection takes place at a point whose distance from Q is to the depth of the mass as $1 : \sqrt{2}$, and its amount is $2\mu/3 \sqrt{3k^2}$. If, for instance, the disturbing mass were a sphere a mile in diameter, the excess of its density above that of the surrounding country being equal to half the density of the earth, and the depth of its centre half a mile, the greatest deflection would be $5''$, and the greatest value of y only two inches. Thus a large disturbance of gravity may arise from an irregularity in the mathematical surface whose actual magnitude, as regards height at least, is extremely small.

The effect of the disturbing mass μ on the vibrations of a pendulum would be a maximum at Q; if ν be the number of seconds of time gained per diem by the pendulum at Q, and σ the number of seconds of angle in the maximum deflection, then it may be shown that $\nu/\sigma = \pi \sqrt{3/10}$.

The great Indian survey, and the attendant measurements of the degree of latitude, gave occasion to elaborate investigations of the deflection of the plumb-line in the neighbourhood of the high plateaus and mountain chains of Central Asia. Archdeacon Pratt (*Phil. Trans.*, 1855 and 1857), in instituting these investigations, took into consideration the influence of the apparent diminution of the mass of the earth's crust occasioned by the neighbouring ocean-basins; he concluded that the accumulated masses of mountain chains, &c., corresponded to subterranean mass diminutions, so that over any level surface in a fixed depth (perhaps 100 miles or more) the masses of prisms of equal section are equal. This is supported by the gravity measurements at Moré in the Himalayas at a height of 4696 metres, which showed no deflection due to the mountain chain (*Phil. Trans.*, 1871); more recently, H. A. Faye (*Compt. rend.*, 1880) arrived at the same conclusion for the entire continent.

This compensation, however, must only be regarded as a general principle; in certain cases, the compensating masses show marked horizontal displacements. Further investigations, especially of gravity measurements, will undoubtedly establish other important facts. Colonel S. G. Burrard has recently recalculated, with the aid of more exact data, certain Indian deviations of the plumb-line, and has established that in the region south of the Himalayas (lat. 24°) there is a subterranean perturbing mass. The extent of the compensation of the high mountain chains is difficult to recognize from the latitude observations, since the same effect may result from different causes; on the other hand, observations of geographical longitude have established a strong compensation.¹

Meridian Arcs.

The astronomical stations for the measurement of the degree of latitude will generally lie not exactly on the same meridian, and it is therefore necessary to calculate the arcs of meridian M which lie between the latitude of neighbouring stations. If S be the geodetic line calculated from the triangulation with the astronomically determined azimuths α_1 and α_2 , then

$$M = S \frac{\cos \alpha}{\cos \frac{1}{2} \Delta \alpha} \left\{ 1 + \frac{S^2}{4} \sin^2 \alpha \dots \right\},$$

in which $2\alpha = \alpha_1 + \alpha_2 - 180^\circ$, $\Delta \alpha = \alpha_2 - \alpha_1 - 180^\circ$.

The length of the arc of meridian between the latitudes ϕ_1 and ϕ_2 is

$$M = \int_{\phi_1}^{\phi_2} \rho d\phi = a \int_{\phi_1}^{\phi_2} \frac{(1 - e^2) d\phi}{(1 - e^2 \sin^2 \phi)^{3/2}}$$

where $a^2 e^2 = a^2 - b^2$; instead of using the eccentricity e , put the ratio of the axes $b : a = 1 - \epsilon$, $1 + \epsilon$, then

$$M = \int_{\phi_1}^{\phi_2} \frac{b(1 + \epsilon)(1 - \epsilon^2 \sin^2 \phi) d\phi}{(1 + 2\epsilon \cos 2\phi + \epsilon^2)^{3/2}}$$

This, after integration, gives

$$M/b = \left(1 + \epsilon + \frac{5}{4}\epsilon^2 + \frac{5}{4}\epsilon^3\right) \alpha_0 - \left(3\epsilon + 3\epsilon^2 + \frac{21}{8}\epsilon^3\right) \alpha_1 + \left(\frac{15}{8}\epsilon^2 + \frac{15}{8}\epsilon^3\right) \alpha_2 - \left(\frac{35}{24}\epsilon^3\right) \alpha_3.$$

where

$$\begin{aligned} \alpha_0 &= \phi_2 - \phi_1 \\ \alpha_1 &= \sin(\phi_2 - \phi_1) \cos(\phi_2 + \phi_1) \\ \alpha_2 &= \sin 2(\phi_2 - \phi_1) \cos 2(\phi_2 + \phi_1) \\ \alpha_3 &= \sin 3(\phi_2 - \phi_1) \cos 3(\phi_2 + \phi_1). \end{aligned}$$

The part of M which depends on ϵ^3 is very small; in fact, if we calculate it for one of the longest arcs measured, the Russian arc, it amounts to only an inch and a half, therefore we omit this term, and put for M/b the value

$$\left(1 + \epsilon + \frac{5}{4}\epsilon^2\right) \alpha_0 - \left(3\epsilon + 3\epsilon^2\right) \alpha_1 + \left(\frac{15}{8}\epsilon^2\right) \alpha_2.$$

Now, if we suppose the observed latitudes to be affected with errors, and that the true latitudes are $\phi_1 + x_1$, $\phi_2 + x_2$; and if further we suppose that $n_1 + dx$ is the true value of $a - b$; $a + b$, and that n_2 itself is merely a very approximate numerical value, we get, on making these substitutions and neglecting the influence of the corrections x on the position of the arc in latitude, i.e. on $\phi_1 + \phi_2$,

$$\begin{aligned} M/b &= \left(1 + n_1 + \frac{5}{4}n_1^2\right) \alpha_0 - \left(3n_1 + 3n_1^2\right) \alpha_1 + \left(\frac{15}{8}n_1^2\right) \alpha_2 \\ &+ \left\{ \left(1 + \frac{5}{2}n_1\right) \alpha_0 - \left(3 + 6n_1\right) \alpha_1 + \left(\frac{15}{4}n_1\right) \alpha_2 \right\} dx \\ &+ \left\{ 1 + n_1 - 3n_1 \frac{d\alpha_1}{d\alpha_0} \right\} d\alpha_0; \end{aligned}$$

here $d\alpha_0 = x_2 - x_1$; and as b is only known approximately, put $b = \phi_1(1 + u)$; then we get, after dividing through by the coefficient of $d\alpha_0$, which is $1 + n_1 - 3n_1 \cos(\phi_2 - \phi_1) \cos(\phi_2 + \phi_1)$, an equation of the form $x_2 = x_1 + k + f u + g v$, where for convenience we put v for dx .

Now in every measured arc there are not only the extreme stations determined in latitude, but also a number of intermediate stations so that if there be $s + 1$ stations there will be f equations

$$\begin{aligned} x_2 &= x_1 + f_1 u + g_1 v + h_1 \\ x_3 &= x_1 + f_2 u + g_2 v + h_2 \\ &\vdots \\ x_s &= x_1 + f_s u + g_s v + h_s \end{aligned}$$

In combining a number of different arcs of meridian, with the view of determining the figure of the earth, each arc will supply a number of equations in u and v and the corrections to its observed latitudes. Then, according to the method of least squares, those values of u and v are the most probable which render the sum of the squares of all the errors x a minimum. The corrections x which are here applied arise not from errors of observation only. The mere uncertainty of a latitude, as determined with modern instruments, does not exceed a very small fraction of a second as far as errors of observation go, but no accuracy in observing will remove the error that may arise from local attraction. This, as we have seen, may amount to some seconds, so that the corrections x to the observed latitudes are attributable to local attraction. Archdeacon Pratt objected to this mode of applying least squares first used by Bessel; but Bessel was right, and the objection is groundless. Bessel found, in 1841, from ten meridian arcs with a total amplitude of $50^\circ 6'$:

$$\begin{aligned} a &= 3272077 \text{ toises} = 6377397 \text{ metres.} \\ e \text{ (ellipticity)} &= (a - b)/a = 1/299.15 \text{ (prob. error} = 3.2). \end{aligned}$$

The probable error in the length of the earth's quadrant is ≈ 336 m.

We now give a series of some meridian-arcs measurements, which were utilized in 1866 by A. R. Clarke in the *Comparisons of the Standards of Length*, pp. 280-287; details of the calculations are given by the same author in his *Geodesy* (1880), pp 311 et seq.

The data of the French arc from Formentera to Dunkirk are—

¹ *Survey of India*, "The Attraction of the Himalaya Mountains upon the Plumb Line in India" (1901), p. 98.

Stations.	Astronomical Latitudes.		Distance of Parallels.
			Ft.
Formentera	38	39	53-17
Mountjouy	41	21	44-96
Barcelona	41	22	47-90
Carcaonne	43	12	54-30
Pantheon	48	50	47-98
Dunkirk	51	2	8-41
			982671-04
			987901-92
			1657287-93
			3710827-13
			4509790-84

The distance of the parallels of Dunkirk and Greenwich, deduced from the extension of the triangulation of England into France, in 1862, is 161,407.3 ft., which is 3.9 ft. greater than that obtained from Captain Kater's triangulation, and 3.2 ft. less than the distance calculated by Delambre from General Roy's triangulation. The following table shows the data of the English arc with the distances in standard feet from Formentera.

			Ft.
Formentera	51	28	38-30
Greenwich	52	13	26-59
Arbury	53	27	29-50
Clifton	56	14	53-60
Kellie Law	57	27	49-12
Seirling	60	49	37-21
Saxavord			4671198-3
			5943837-6
			4394063-4
			6413221-7
			6857323-3
			8086820-7

The latitude assigned in this table to Saxavord is not the directly observed latitude, which is 60° 49' 38.58", for there are here a cluster of three points, whose latitudes are astronomically determined; and if we transfer, by means of the geodesic connexion, the latitude of Gerth of Scaw to Saxavord, we get 60° 49' 36.59"; and if we similarly transfer the latitude of Balta, we get 60° 49' 36.46". The mean of these three is that entered in the above table.

For the Indian arc in long. 77° 40' we have the following data :-

			Ft.
Punnea	8	9	31-132
Putchapolliam	10	59	42-276
Dodagunta	12	59	52-165
Namthabad	15	5	53-562
Daumergha	18	3	15-292
Talkalhera	21	5	51-532
Kalianpur	24	7	11-262
Kaliana	29	30	48-322
			1029174-9
			1756562-0
			2518376-3
			3591788-4
			4697329-5
			5794695-7
			7755835-9

The data of the Russian arc (long. 26° 40') taken from Struve's work are as below :-

			Ft.
Staro Nekrasovsk	45	20	2-94
Vodu-Luy	47	1	24-98
Suprunokovy	48	45	3-04
Kremenets	50	5	49-95
Byelin	52	2	42-16
Nemesh	54	39	4-16
Jacobstadt	56	30	4-97
Dorpat	58	22	47-56
Hogland	60	5	9-84
Klipi-maki	62	38	5-25
Tornea	65	49	44-57
Stuor-oivi	68	40	58-00
Fuglenæs	70	40	11-23
			616529-81
			1246762-17
			1737551-48
			2448745-17
			3400312-63
			4076412-28
			476221-43
			5386135-99
			6317905-67
			7486789-97
			8530517-90
			9257921-06

From the arc measured in Cape Colony by Sir Thomas Maclear in long. 18° 30', we have

			Ft.
North End	29	44	17-66
Heerenlogement Berg	31	58	9-11
Royal Observatory	33	56	3-20
Zwart Kop	34	13	32-13
Cape Point	34	21	6-26
			811507-7
			1526386-8
			1632583-3
			1678375-7

And, finally, for the Peruvian arc, in long. 281° 0',

			Ft.
Tarqui	3	4	32-068
Cotchesqui	0	2	31-387
			1131036-3

Having now stated the data of the problem, we may seek that oblate ellipsoid (spheroid) which best represents the observations. Whatever the real figure may be, it is certain that if we suppose it an ellipsoid with three unequal axes, the arithmetical process will bring out an ellipsoid, which will agree better with all the observed latitudes than any spheroid would, therefore we do not prove that it is an ellipsoid; to prove this, arcs of

longitude would be required. The result for the spheroid may be expressed thus :-

$$a = 20926062 \text{ ft.} = 6378206.4 \text{ metres.}$$

$$b = 20855121 \text{ ft.} = 6356583.8 \text{ metres.}$$

$$c = 2092998 \text{ ft.} = 294.98.$$

As might be expected, the sum of the squares of the 40 latitude corrections, viz. 153.99, is greater in this figure than in that of three axes, where it amounts to 138.30. For this case, in the Indian arc the largest corrections are at Dodagunta, + 3.87", and at Kalianpur, - 3.68". In the Russian arc the largest corrections are + 3.76", at Tornea, and - 3.31", at Staro Nekrasovsk. Of the whole 40 corrections, 16 are under 1.0", 10 between 1.0" and 2.0", 10 between 2.0" and 3.0", and 4 over 3.0". The probable error of an observed latitude is $\pm 1.42''$; for the spheroidal it would be very slightly larger. This quantity may be taken therefore as approximately the probable amount of local deflection.

If ρ be the radius of curvature of the meridian in latitude ϕ , ρ' that perpendicular to the meridian, D the length of a degree of the meridian, D' the length of a degree of longitude, r the radius drawn from the centre of the earth, V the angle of the vertical with the radius-vector, then

$$\rho = 20890606.6 - 106411.5 \cos 2\phi + 225.8 \cos 4\phi$$

$$\rho' = 20961607.3 - 35390.9 \cos 2\phi + 45.2 \cos 4\phi$$

$$D = 364600.87 - 1857.14 \cos 2\phi + 3.94 \cos 4\phi$$

$$D' = 365538.48 \cos \phi - 310.17 \cos 3\phi + 0.39 \cos 5\phi$$

$$\log r/a = 9.9925645 + .0007374 \cos 2\phi - .0000019 \cos 4\phi$$

$$V = 700.44' \sin 2\phi - 1.19' \sin 4\phi.$$

A. R. Clarke has recalculated the elements of the ellipsoid of the earth; his values, derived in 1880, in which he utilized the measurements of parallel arcs in India, are particularly in practice. These values are :-

$$a = 20926202 \text{ ft.} = 6378249 \text{ metres.}$$

$$b = 20854895 \text{ ft.} = 6356515 \text{ metres.}$$

$$c = 292.465 = 293.465.$$

The calculation of the elements of the ellipsoid of rotation from measurements of the curvature of arcs in any given azimuth by means of geographical longitudes, latitudes and azimuths is indicated in the article GEODESY; reference may be made to *Principal Triangulation*, Helmert's *Geodäsie*, and the publications of the Kgl. Preuss. Geod. Inst. - *Lotabweichungen* (1886), and *Die europ. Längengradmessung im 52. Br.* (1893). For the calculation of an ellipsoid with three unequal axes see *Comparison of Standards*, preface; and for non-elliptical meridians, *Principal Triangulation*, p. 733.

Gravitation-Measurements.

According to Clairault's theorem (see above) the ellipticity e of the mathematical surface of the earth is equal to the difference $\frac{1}{2}m - \beta$, where m is the ratio of the centrifugal force at the equator to gravity at the equator, and β is derived from the formula $G = g(1 + \beta \sin^2 \phi)$. Since the beginning of the 19th century many efforts have been made to determine the constants of this formula, and numerous expeditions undertaken to investigate the intensity of gravity in different latitudes. If m be known, it is only necessary to determine β for the evaluation of e ; consequently it is unnecessary to determine G absolutely, for the relative values of G at two known latitudes suffice. Such relative measurements are easier and more exact than absolute ones. In some cases the ordinary thread pendulum, i.e. a spherical bob suspended by a wire, has been employed; but more often a rigid metal rod, bearing a weight and a knife-edge on which it may oscillate, has been adopted. The main point is the constancy of the pendulum. From the formula for the time of oscillation of the mathematically ideal pendulum, $t = 2\pi\sqrt{l/G}$, l being the length, it follows that for two points $G_1/G_2 = l_2^2/l_1^2$.

In 1808 J. B. Biot commenced his pendulum observations at several stations in western Europe, and in 1817-1825 Captain Louis de Freycinet and L. I. Duperry prosecuted similar observations far into the southern hemisphere. Captain Henry Kater confined himself to British stations (1818-1819); Captain E. Sabine, from 1819 to 1829, observed similarly, with Kater's pendulum, at seventeen stations ranging from the West Indies

to Greenland and Spitzbergen; and in 1824-1831, Captain Henry Foister (who met his death by drowning in Central America) experimented at sixteen stations; his observations were completed by Francis Baily in London. Of other workers in this field mention may be made of F. B. Lütke (1826-1829), a Russian rear-admiral, and Captains J. B. Basevi and W. T. Heaviside, who observed during 1865 to 1873 at Kew and at 29 Indian stations, particularly at Moré in the Himalayas at a height of 4696 metres. Of the earlier absolute determinations we may mention those of Biot, Kater, and Bessel at Paris, London and Königsberg respectively. The measurements were particularly difficult by reason of the length of the pendulums employed, these generally being second-pendulums over 1 metre long. In about 1880, Colonel Robert von Sterneck of Austria introduced the half-second pendulum, which permitted far quicker and more accurate work. The use of these pendulums spread in all countries, and the number of gravity stations consequently increased: in 1880 there were about 120, in 1900 there were about 1600, of which the greater number were in Europe. Sir E. Sabine¹ calculated the ellipticity to be 1/288.5, a value shown to be too high by Helmert, who in 1884, with the aid of 120 stations, gave the value 1/299.26,² and in 1901, with about 1400 stations, derived the value 1/298.3.³ The reason for the excessive estimate of Sabine is that he did not take into account the systematic difference between the values of G for continents and islands; it was found that in consequence of the constitution of the earth's crust (Pratt) G is greater on small

H, and g, the value at sea-level. This is supposed to take into account the attraction of the elevated strata or plateau; but, from the analytical method, this is not correct; it is also disadvantageous since, in general, the land-masses are compensated subterraneously, by reason of the isostasis of the earth's crust.

In 1849 Stokes showed that the normal elevations N of the geoid towards the ellipsoid are calculable from the deviations Δg of the acceleration of gravity, i.e. the differences between the observed g and the value calculated from the normal G formula. The method assumes that gravity is measured on the earth's surface at a sufficient number of points, and that it is conformably reduced. In order to secure the convergence of the expansions in spherical harmonics, it is necessary to assume all masses outside a surface parallel to the surface of the sea at a depth of 21 km. (= R X ellipticity) to be condensed on this surface (Helmert, *Geod. ii.* 172). In addition to the reduction with $2gH/R$, there still result small reductions with mountain chains and coasts, and somewhat larger ones for islands. The sea-surface generally varies but very little by this condensation. The elevation (N) of the geoid is then equal to

$$N = R \int^r FC^{-1} \Delta g_{\psi} d\psi,$$

where ψ is the spherical distance from the point N, and Δg_{ψ} denotes the mean value of Δg for all points in the same distance ψ around; F is a function of ψ , and has the following values:—

$\psi =$	0°	10°	20°	30°	40°	50°	60°	70°	80°	90°	100°	110°	120°	130°	140°	150°	160°	170°	180°
F =	1	1.22	0.94	0.47	-0.06	-0.54	-0.90	-1.08	-1.08	-0.91	-0.62	-0.37	+0.08	0.36	0.53	0.56	0.46	0.26	0

islands of the ocean than on continents by an amount which may approach to 0.3 cm. Moreover, stations in the neighbourhood of coasts shelving to deep seas have a surplus, but a little smaller. Consequently, Helmert conducted his calculations of 1901 for continents and coasts separately, and obtained G for the coasts 0.036 cm. greater than for the continents, while the value of β remained the same. The mean value, reduced to continents, is $G = 978.03(1 + 0.005302 \sin^2 \phi - 0.00007 \sin^2 2\phi)$ cm/sec².

The small term involving $\sin^2 2\phi$ could not be calculated with sufficient exactness from the observations, and is therefore taken from the theoretical views of Sir G. H. Darwin and E. Wiechert. For the constant $g = 978.03$ cm. another correction has been suggested (1906) by the absolute determinations made by F. Kühnen and Ph. Furtwängler at Potsdam.⁴

A report on the pendulum measurements of the 19th century has been given by Helmert in the *Comptes rendus des séances de la 13^e conférence générale de l'Association Géod. Internationale de Paris* (1900), ii. 139-385.

A difficulty presents itself in the case of the application of measurements of gravity to the determination of the figure of the earth by reason of the extrusion or standing out of the land-masses (continents, &c.) above the sea-level. The potential of gravity has a different mathematical expression outside the masses than inside. The difficulty is removed by assuming (with Sir G. G. Stokes) the vertical condensation of the masses on the sea-level, without its form being considerably altered (scarcely 1 metre radially). Further, the value of gravity (g) measured at the height H is corrected to sea-level by $+2gH/R$, where R is the radius of the earth. Another correction, due to P. Bouguer, is $-\frac{2}{3}\delta H/\rho R$, where δ is the density of the strata of height H, and ρ the mean density of the earth. These two corrections are represented in "Bouguer's Rule": $g_H = g_0(1 - 2H/R + 3H/\rho R)$, where g_0 is the gravity at height

H. Poincaré (*Bull. Astr.*, 1901, p. 5) has exhibited N by means of Lamé's functions; in this case the condensation is effected on an ellipsoidal surface, which approximates to the geoid. This condensation is, in practice, the same as to the geoid itself.

If we imagine the outer land-masses to be condensed on the sea-level, and the inner masses (which, together with the outer masses, causes the deviation of the geoid from the ellipsoid) to be compensated in the sea-level by a disturbing stratum (which, according to Gauss, is possible), and if these masses of both kinds correspond at the point N to a stratum of thickness D and density δ , then, according to Helmert (*Geod. ii.* 260) we have approximately

$$\Delta g = \frac{3}{2} \frac{g}{R} \left(\frac{\partial D}{\partial \rho} - N \right).$$

Since N slowly varies empirically, it follows that in restricted regions (of a few 100 km. in diameter) Δg is a measure of the variation of D. By applying the reduction of Bouguer to g, D is diminished by H and only gives the thickness of the ideal disturbing mass which corresponds to the perturbations due to subterranean masses. Δg has positive values on coasts, small islands, and high and medium mountain chains, and occasionally in plains; while in valleys and at the foot of mountain ranges it is negative (up to 0.2 cm.). We conclude from this that the masses of smaller density existing under high mountain chains lie not only vertically underneath but also spread out sideways.

The European Arc of Parallel in 52° Lat.

Many measurements of degrees of longitudes along central parallels in Europe were projected and partly carried out as early as the first half of the 19th century; these, however, only became of importance after the introduction of the electric telegraph, through which calculations of astronomical longitudes obtained a much higher degree of accuracy. Of the greatest moment is the measurement near the parallel of 52° lat., which extended from Valentia in Ireland to Orsk in the southern Ural mountains over 60° long. (about 6750 km.). F. G. W. Struve, who is to be regarded as the father of the Russo-Scandinavian latitude-degree measurements, was the originator of this investigation. Having made the requisite arrangements with the

¹ *Account of Experiments to Determine the Figure of the Earth by means of a Pendulum vibrating Seconds in Different Latitudes* (1825).
² Helmert, *Theorien d. höheren Geod. ii.*, Leipzig, 1884.
³ Helmert, *Sitzber. d. kgl. preuss. Ak. d. Wiss. zu Berlin* (1901), p. 136.
⁴ Bestimmung der absoluten Grösse der Schwerkraft zu Potsdam mit Reversionspendeln" (*Veröffentlichung des kgl. preuss. Geod. Inst., N.F.*, No. 27).

governments in 1857, he transferred them to his son Otto, who, in 1860, secured the co-operation of England. A new connexion of England with the continent, via the English Channel, was accomplished in the next two years; whereas the requisite triangulations in Prussia and Russia extended over several decennaries. The number of longitude stations originally arranged for was 15; and the determinations of the differences in longitude were uniformly commenced by the Russian observers E. I. von Försch, J. I. Zylinski, B. Tiele and others; Feaghmain (Valencia) being reserved for English observers. With the concluding calculation of these operations, newer determinations of differences of longitudes were also applicable, by which the number of stations was brought up to 29. Since local deflections of the plumb-line were suspected at Feaghmain, the most westerly station, the longitude (with respect to Greenwich) of the trigonometrical station Killorglin at the head of Dingle Bay was shortly afterwards determined.

The results (1891-1894) are given in volumes xviii. and l. of the memoirs (Zapiski) of the military topographical division of the Russian general staff, volume li. contains a reconnaissance of Orsk. The observations made west of Warsaw are detailed in the *Dissemp. Längengradmessung in 52^{er} Br.*, l. and li., 1893, 1896, published by the Kgl. Preuss. Geod. Inst.

The following figures are quoted from Helmert's report "Die Größe der Erde" (*Sitzb. d. Berl. Acad. d. Wiss.*, 1906, p. 535):—

Easterly Deviation of the Astronomical Zenith.		
Name.	Longitude.	°
Feaghmain	-10 21	-3.3
Killorglin	- 9 47	+2.8
Haverfordwest	- 4 58	+1.6
Greenwich	0 0	+1.5
Rosendael-Nieuport	+ 2 35	-1.7
Bona	+ 7 6	-4.4
Göttingen	+ 9 57	-2.4
Brocken	+10 37	+2.3
Leipzig	+12 23	+2.7
Rauenberg-Berlin	+13 23	+1.7
Grosenhain	+13 33	-2.9
Schneekoppe	+15 45	+0.1
Springberg	+16 37	+0.8
Breilau-Rosenthal	+17 2	+3.5
Trockenberg	+18 53	-0.5
Schöneae	+18 54	-2.9
Mirow	+19 18	+2.2
Warsaw	+21 2	-1.8
Grodno	+23 10	-2.8
Bobruisk	+29 54	+0.5
Orel	+36 4	+4.4
Lipetsk	+36 36	+0.2
Saratov	+46 3	+6.4
Samara	+50 7	-2.4
Orenburg	+55 7	+1.7
Orsk	+58 34	-8.0

These deviations of the plumb-line correspond to an ellipsoid having an equatorial radius (a) of nearly 6,378,000 metres (prob. error ± 70 metres) and an ellipticity $1/299.15$. The latter was taken for granted; it is nearly equal to the result from the gravity-measurements; the value for a then gives $Z\eta^2$ a minimum (nearly). The astronomical values of the geographical longitudes (with regard to Greenwich) are assumed, according to the compensation of longitude differences carried out by van de Sande Bakhuysen (*Comp. rend. des stances de la commission permanente de l'Association Géod. Internationale à Genève, 1893, annexe A.I.*). Recent determinations (Albrecht, *Astr. Nach.*, 3993/4) have introduced only small alterations in the deviations, a being slightly increased.

Of considerable importance in the investigation of the great arc was the representation of the linear lengths found in different countries, in terms of the same unit. The necessity for this had previously occurred in the computation of the figure of the earth from latitude-degree-measurements. A. R. Clarke instituted an extensive series of comparisons at Southampton (see *Comparisons of Standards of Length of England, France, Belgium, Prussia, Russia, India and Australia, made at the Ordnance Survey Office, Southampton, 1866*, and a paper in the *Philosophical Transactions* for 1873, by Lieut.-Col. A. R. Clarke, C.B., R.E.,

on the further comparisons of the standards of Austria, Spain, the United States, Cape of Good Hope and Russia) and found that 1 toise = 6.39453348 ft., 1 metre = 3.28086933 ft.

In 1875 a number of European states concluded the metre convention, and in 1877 an international weights-and-measures bureau was established at Breteuil. Until this time the metre was determined by the end-surfaces of a platinum rod (*mètre des archives*); subsequently, rods of platinum-iridium, of cross-section H , were constructed, having engraved lines at both ends of the bridge, which determine the distance of a metre. There were thirty of the rods which gave as accurately as possible the length of the metre; and these were distributed among the different states. (see WEIGHTS AND MEASURES). Careful comparisons with several standard toises showed that the metre was not exactly equal to 443,296 lines of the toise, but, in round numbers, $1/75000$ of the length smaller. The metre according to the older relation is called the "legal metre," according to the new relation the "international metre." The values are (see *Europ. Längengradmessung*, i. p. 230):—

Legal metre = 3.28086933 ft., International metre = 3.2808257 ft.

The values of a given above are in terms of the international metre; the earlier ones in legal metres, while the gravity formulæ are in international metres.

The International Geodetic Association (Internationale Erdmessung).

On the proposition of the Prussian lieutenant-general, Johann Jacob Baeyer, a conference of delegates of several European states met at Berlin in 1862 to discuss the question of a "Central European degree-measurement." The first general conference took place at Berlin two years later; shortly afterwards other countries joined the movement, which was then named "The European degree-measurement." From 1866 till 1886 Prussia had borne the expense incident to the central bureau at Berlin; but when in 1886 the operations received further extension and the title was altered to "The International Earth-measurement" or "International Geodetic Association," the co-operating states made financial contributions to this purpose. The central bureau is affiliated with the Prussian Geodetic Institute, which, since 1892, has been situated on the Telegraphenberg near Potsdam. After Baeyer's death Prof. Friedrich Robert Helmert was appointed director. The funds are devoted to the advancement of such scientific works as concern all countries and deal with geodetic problems of a general or universal nature. During the period 1897-1906 the following twenty-one countries belonged to the association:—Austria, Belgium, Denmark, England, France, Germany, Greece, Holland, Hungary, Italy, Japan, Mexico, Norway, Portugal, Rumania, Russia, Servia, Spain, Sweden, Switzerland and the United States of America. At the present time general conferences take place every three years.¹

Baeyer projected the investigation of the curvature of the meridians and the parallels of the mathematical surface of the earth stretching from Christiania to Palermo for 12 degrees of longitude; he sought to co-ordinate and complete the network of triangles in the countries through which these meridians passed, and to represent his results by a common unit of length. This proposition has been carried out, and extended over the greater part of Europe; as a matter of fact, the network has, with trifling gaps, been carried over the whole of western and central Europe, and, by some chains of triangles, over European Russia. Through the co-operation of France, the network has been extended into north Africa as far as the geographical latitude of 32°; in Greece a network, united with those of Italy and Bosnia, has been carried out by the Austrian colonel, Heinrich Hartl; Servia has projected similar triangulations; Rumania has begun to make the triangle measurements, and three base

¹ Die Königl. Observatorien für Astrophysik, Meteorologie und Geodäsie bei Potsdam (Berlin, 1890): Verhandlungen der I. Allgemeinen Konferenz der Bevollmächtigten zur mittlereurop. Gradmessung, October, 1864, in Berlin (Berlin, 1865); A. Hirsch, Verhandlungen der VII. Allg. Conf. der Internationalen Erdmessung, October, 1886, in Berlin (Berlin, 1887); und Verhandlungen der XI. Allg. Conf. d. I. E., October, 1893, in Berlin (1896).

lines have been measured by French officers with Brunner's apparatus. At present, in Rumania, there is being worked a connexion between the arc of parallel in lat. $47^{\circ}/48^{\circ}$ in Russia (stretching from Astrakan to Kiahnev) with Austria-Hungary. In the latter country and in south Bavaria the connecting triangles for this parallel have been recently revised, as well as the French chain on the Paris parallel, which has been connected with the German net by the co-operation of German and French geodesists. This will give a long arc of parallel, really projected in the first half of the 19th century. The calculation of the Russian section gives, with an assumed ellipticity of $1/299.15$, the value $\alpha = 6377350$ metres; this is rather uncertain, since the arc embraces only 19° in longitude.

We may here recall that in France geodetic studies have recovered their former expansion under the vigorous impulse of Colonel (afterwards General) François Perrier. When occupied with the triangulation of Algeria, Colonel Perrier had conceived the possibility of the geodetic junction of Algeria to Spain, over the Mediterranean; therefore the French meridian line, which was already connected with England, and was thus produced to the 60th parallel, could further be linked to the Spanish triangulation, cross thence into Algeria and extend to the Sahara, so as to form an arc of about 30° in length. But it then became urgent to proceed to a new measurement of the French arc, between Dunkirk and Perpignan. In 1869 Perrier was authorized to undertake that revision. He devoted himself to that work till the end of his career, closed by premature death in February 1888, at the very moment when the *Député de la guerre* had just been transformed into the Geographical Service of the Army, of which General F. Perrier was the first director. His work was continued by his assistant, Colonel (afterwards General) J. A. L. Bassot. The operations concerning the revision of the French arc were completed only in 1896. Meanwhile the French geodesists had accomplished the junction of Algeria to Spain, with the help of the geodesists of the Madrid Institute under General Carlos Ibañez (1879), and measured the meridian line between Algiers and El Aghuat (1881). They have since been busy in prolonging the meridians of El Aghuat and Biakra, so as to converge towards Wargla, through Ghardaia and Tuggurt. The fundamental co-ordinates of the Panthéon have also been obtained anew, by connecting the Panthéon and the Paris Observatory with the five stations of Bry-sur-Marne, Morlu, Mont Valerien, Chatillon and Montsouris, where the observations of latitude and azimuth have been effected.¹

According to the calculations made at the central bureau of the international association on the great meridian arc extending from the Shetland Islands, through Great Britain, France and Spain to El Aghuat in Algeria, $\alpha = 6377935$ metres, the ellipticity being assumed as $1/299.15$. The following table gives the difference: astronomical-geodetic latitude. The net does not follow the meridian exactly, but deviates both to the west and to the east; actually, the meridian of Greenwich is nearer the mean than that of Paris (Helmert, *Grösse d. Erde*).

West Europe-Africa Meridian-arc.²

Name.	Latitude.	A.-G.
Sanzord	60 49.6	-4.0
Balta	60 45.0	-6.1
Ben Hutig	58 33.1	+0.3
Cowhythe	57 41.1	+7.3
Great Stirling	57 27.8	-2.3
Kellie Law	56 14.9	-3.7
Calton Hill	55 57.4	+3.5
Durham	54 46.1	-0.9
Burleigh Moor	54 34.3	+2.1
Clifton Beacon	53 27.5	+1.3

West Europe-Africa Meridian-arc (contd.).

Name.	Latitude.	A.-G.
Arbury Hill	52 13.4	-3.0
Greenwich	51 28.6	-2.5
Nieuport	51 7.8	-0.4
Rosendaël	51 2.7	-0.9
Lihons	49 49.9	+0.5
Panthéon	48 50.8	-0.0
Chevry	48 0.5	+2.2
Saligny le Vif	47 2.7	+3.0
Arpheuille	46 13.7	+6.3
Puy de Dôme	45 46.5	+7.0
Rodes	44 21.4	+1.7
Carcassonne	43 13.3	+0.7
Riveaults	42 45.2	-0.7
Montolar	41 38.5	+3.6
Lérida	41 37.0	-0.2
Javalon	40 13.8	-0.2
Desierto	40 5.0	-4.5
Chinchilla	38 55.2	+2.2
Mola de Formentera	38 39.9	-1.2
Tetica	37 15.2	+3.5
Roldan	36 56.6	-6.0
Conjuros	36 44.4	-12.6
Mt. Sabiha	35 39.6	+6.8
Nemours	35 5.8	+7.4
Bousardah	36 46.0	+2.9
Algiers (Votrol)	36 45.1	-9.1
Guelit & Stel	35 7.8	-1.0
El Aghuat	33 46.0	-2.8

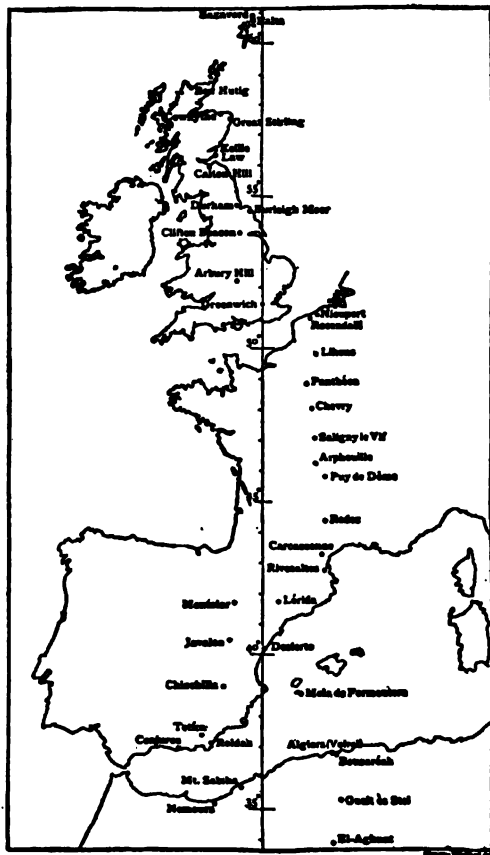

¹ Ibañez and Perrier, *Junction géod. et astr. de l'Algérie avec l'Espagne* (Paris, 1886); *Mémoires du dépôt général de la guerre*, t. xli; *Nouvelles méridiennes de France* (Paris, 1888, 1902, 1904); *Comptes rendus des séances de la 12^e-13^e conférence générale de l'Assoc. Géod. Internat.*, 1898 at Stuttgart, 1900 at Paris, 1903 at Copenhagen, 1906 at Budapest (Berlin, 1899, 1901, 1904, 1908); A. Ferrero, *Rapport sur les triangulations, prés. à la 12^e conf. gén.* 1898.
² R. Schumann, *C. r. de Budapest*, p. 244.

While the radius of curvature of this arc is obviously not uniform (being, in the mean, about 600 metres greater in the northern than in the southern part), the Russo-Scandinavian meridian arc (from 45° to 70°), on the other hand, is very uniformly curved, and gives, with an ellipticity of $1/299.15$, $a = 6378455$ metres; this arc gives the plausible value $1/298.6$ for the ellipticity. But in the case of this arc the orographical circumstances are more favourable.

The west-European and the Russo-Scandinavian meridians indicate another anomaly of the geoid. They were connected at the Central Bureau by means of east-to-west triangle chains (principally by the arc of parallel measurements in lat. 52°); it was shown that, if one proceeds from the west-European meridian arcs, the differences between the astronomical and geodetic latitudes of the Russo-Scandinavian arc become some $4''$ greater.¹

The central European meridian, which passes through Germany and the countries adjacent on the north and south, is under review at Potsdam (see the publications of the Kgl. Preuss. Geod. Inst., *Lotabweichungen*, Nos. 1-3). Particular notice must be made of the Vienna meridian, now carried southwards to Malta. The Italian triangulation is now complete, and has been joined with the neighbouring countries on the north, and with Tunis on the south.

The United States Coast and Geodetic Survey has published an account of the transcontinental triangulation and measurement of an arc of the parallel of 39° , which extends from Cape May (New Jersey), on the Atlantic coast, to Point Arena (California), on the Pacific coast, and embraces $48^\circ 46'$ of longitude, with a linear development of about 4225 km. (2625 miles). The triangulation depends upon ten base-lines, with an aggregate length of 86 km. the longest exceeding 17 km. in length, which have been measured with the utmost care. In crossing the Rocky Mountains, many of its sides exceed 100 miles in length, and there is one side reaching to a length of 294 km., or 183 miles; the altitude of many of the stations is also considerable, reaching to 4300 metres, or 14,108 ft., in the case of Pike's Peak, and to 14,421 ft. at Elbert Peak, Colo. All geometrical conditions subsisting in the triangulation are satisfied by adjustment, inclusive of the required accord of the base-lines, so that the same length for any given line is found, no matter for what line one may start.²

Over or near the arc were distributed 109 latitude stations, occupied with zenith telescopes; 73 azimuth stations; and 29 telegraphically determined longitudes. It has thus been possible to study in a very complete manner the deviations of the vertical, which in the mountainous regions sometimes amount to 25 seconds, and even to 29 seconds.

With the ellipticity $1/299.15$, $a = 6377897 = 65$ metres (prob. error); in this calculation, however, some exceedingly perturbed stations are excluded; for the employed stations the mean perturbation in longitude is $\pm 4.9''$ (zenith-deflection east-to-west $\pm 3.8''$).

The computations relative to another arc, the "eastern oblique arc of the United States," are also finished.³ It extends from Calais (Maine) in the north-east, to the Gulf of Mexico, and terminates at New Orleans (Louisiana), in the south. Its length is 2612 km. (1623 miles), the difference of latitude $15^\circ 1'$, and of longitude $22^\circ 47'$. In the main, the triangulation follows the Appalachian chain of mountains, bifurcating once, so as to leave an oval space between the two branches. It includes among its stations Mount Washington (1920 metres) and Mount Mitchell (2038 metres). It depends upon six base-lines, and the adjustment is effected in the same manner as for the arc of the

parallel. The astronomical data have been afforded by 91 latitude stations, 17 longitude stations, and 56 azimuth stations, distributed over the whole extent of the arc. The resulting dimensions of an osculating spheroid were found to be

$$a = 6378157 \text{ metres} = 90 \text{ (prob. error)}, \\ e(\text{ellipticity}) = 1/304.5 = 1.9 \text{ (prob. error)}.$$

With the ellipticity $1/309.15$, $a = 6378041$ metres ± 80 (prob. er.)

During the years 1903-1906 the United States Coast and Geodetic Survey, under the direction of O. H. Tittmann and the special management of John F. Hayford, executed a calculation of the best ellipsoid of rotation for the United States. There were 507 astronomical determinations employed, all the stations being connected through the net-work of triangles. The observed latitudes, longitude and azimuths were improved by the attractions of the earth's crust on the hypothesis of isostasis for three depths of the surface of 114, 121 and 162 km., where the isostasis is complete. The land-masses, within the distance of 4126 km., were taken into consideration. In the derivation of an ellipsoid of rotation, the first case proved itself the most favourable, and there resulted:—

$$a = 6378283 \text{ metres} = 74 \text{ (prob. er.)}, \text{ellipticity} = 1/297.8 = 0.9 \text{ (prob. er.)}.$$

The most favourable value for the depth of the isostatic surface is approximately 114 km.

The measurement of a great meridian arc, in long. 98° W., has been commenced; it has a range of latitude of 23° , and will extend over 50° when produced southwards and northwards by Mexico and Canada. It may afterwards be connected with the arc of Quito. A new measurement of the meridian arc of Quito was executed in the years 1901-1906 by the *Service géographique* of France under the direction of the *Académie des Sciences*, the ground having been previously reconnoitred in 1809. The new arc has an amplitude in latitude of $5^\circ 53' 33''$, and stretches from Tulcan (lat. $0^\circ 48' 25''$) on the borders of Columbia and Ecuador, through Columbia to Payta (lat. $-5^\circ 5' 8''$) in Peru. The end-points, at which the chain of triangles has a slight north-easterly trend, show a longitude difference of $3''$. Of the 74 triangle points, 64 were latitude stations; 6 azimuths and 8 longitude-differences were measured, three base-lines were laid down, and gravity was determined from six points, in order to maintain indications over the general deformation of the geoid in that region. Computations of the attraction of the mountains on the plumb-line are also being considered. The work has been much delayed by the hardships and difficulties encountered. It was conducted by Lieut.-Colonel Robert Bourgeois, assisted by eleven officers and twenty-four soldiers of the geodetic branch of the *Service géographique*. Of these officers mention may be made of Commandant E. Maurain, who retired in 1904 after suffering great hardships; Commandant L. Massenot, who died in 1905; and Captains I. Lacombe, A. Lallemand, and Lieut. Georges Perrier (son of General Perrier). It is conceivable that the chain of triangles in longitude 98° in North America may be united with that of Ecuador and Peru: a continuous chain over the whole of America is certainly but a question of time. During the years 1899-1902 the measurement of an arc of meridian was made in the extreme north, in Spitzbergen, between the latitudes $76^\circ 38'$ and $80^\circ 50'$, according to the project of P. G. Rosen. The southern part was determined by the Russians—O. Bäcklund, Captain D. D. Sergieffsky, F. N. Tchernychev, A. Hansky and others—during 1899-1901, with the aid of 1 base-line, 15 trigonometrical, 11 latitude and 5 gravity stations. The northern part, which has one side in common with the southern part, has been determined by Swedes (Professors Rosen, father and son, E. Jäderin, T. Rubin and others), who utilized 1 base-line, 9 azimuth measurements, 18 trigonometrical, 17 latitude and 5 gravity stations. The party worked under excessive difficulties, which were accentuated by the arctic climate. Consequently, in the first year, little headway was made.⁴

⁴ *Missions scientifiques pour la mesure d'un arc de méridien en Spitzberg entrepris en 1899-1902 sous les auspices des gouvernements russe et suédois. Mission russe (St Pétersbourg, 1904); Mission suédoise (Stockholm, 1904).*

¹ O. and A. Börsch, "Verbindung d. russ.-skandinav. mit der franz.-engl. Breitengradmessung" (*Verhandlungen der v. Allgem. Conf. d. I. E. in Paris, 1889, Ann. xi.*).

² U.S. Coast and Geodetic Survey; H. S. Pritchett, superintendent. *The Transcontinental Triangulation and the American Arc of the Parallel*, by C. A. Schott (Washington, 1900).

³ U.S. Coast and Geodetic Survey; O. H. Tittmann, superintendent. *The Eastern Oblique Arc of the United States*, by C. A. Schott (1902).

Sir David Gill, when director of the Royal Observatory, Cape Town, instituted the magnificent project of working a latitude-degree measurement along the meridian of 30° long. This meridian passes through Natal, the Transvaal, by Lake Tanganyika, and from thence to Cairo; connexion with the Russo-Scandinavian meridian arc of the same longitude should be made through Asia Minor, Turkey, Bulgaria and Rumania. With the completion of this project a continuous arc of 105° in latitude will have been measured.¹

Extensive triangle chains, suitable for latitude-degree measurements, have also been effected in Japan and Australia.

Besides, the systematization of gravity measurements is of importance, and for this purpose the association has instituted many reforms. It has ensured that the relative measurements made at the stations in different countries should be reduced conformably with the absolute determinations made at Potsdam; the result was that, in 1906, the intensities of gravitation at some 2000 stations had been co-ordinated. The intensity of gravity on the sea has been determined by the comparison of barometric and hypsometric observations (Mohr's method). The association, at the proposal of Helmert, provided the necessary funds for two expeditions:—English Channel—Rio de Janeiro, and the Red Sea—Australia—San Francisco—Japan. Dr O. Hecker of the central bureau was in charge; he successfully overcame the difficulties of the work, and established the tenability of the isostatic hypothesis, which necessitates that the intensity of gravity on the deep seas has, in general, the same value as on the continents (without regard to the proximity of coasts).²

As the result of the more recent determinations, the ellipticity, compression or flattening of the ellipsoid of the earth may be assumed to be very nearly $1/298.3$; a value determined in 1901 by Helmert from the measurements of gravity. The semi-major axis, a , of the meridian ellipse may exceed 6,378,000 intermetres by about 200 metres. The central bureau have adopted, for practical reasons, the value $1/299.15$, after Bessel, for which tables exist; and also the value $a = 6377397.155(1 + 0.0001)$.

The methods of theoretical astronomy also permit the evaluation of these constants. The semi-axis a is calculable from the parallax of the moon and the acceleration of gravity on the earth; but the results are somewhat uncertain: the ellipticity deduced from lunar perturbations is $1/297.8 \pm 2$ (Helmert, *Geodäsie*, ii. pp. 460–473); William Harkness (*The Solar Parallax and its related Constants*, 1891) from all possible data derived the values: ellipticity = $1/300.2 \pm 3$, $a = 6377972.125$ metres. Harkness also considered in this investigation the relation of the ellipticity to precession and nutation; newer investigations of the latter lead to the limiting values $1/296$, $1/298$ (Wiechert). It was clearly noticed in this method of determination that the influence of the assumption as to the density of the strata in the interior of the earth was but very slight (Radau, *Bull. astr.* ii. (1885) 157). The deviations of the geoid from the flattened ellipsoid of rotation with regard to the heights (the directions of normals being nearly the same) will scarcely exceed ± 100 metres (Helmert).³

The basis of the degree- and gravity-measurements is actually formed by a stationary sea-surface, which is assumed to be level. However, by the influence of winds and ocean currents the mean surface of the sea near the coasts (which one assumes as the fundamental sea-surface) can deviate somewhat from a level surface. According to the more recent levelling it varies at the most by only some decimeters.⁴

¹ Sir David Gill, *Report on the Geodetic Survey of South Africa, 1833–1892* (Cape Town, 1896), vol. ii. 1901, vol. iii. 1905.

² O. Hecker, *Bestimmung der Schwerkraft a. d. Atlantischen Ozean* (Veröffentl. d. Kgl. Preuss. Geod. Inst. No. 11), Berlin, 1903.

³ F. R. Helmert, "Neuere Fortschritte in der Erkenntnis der math. Erdgestalt," (*Verhandl. des VII. internationalen Geographen-Kongresses*, Berlin, 1899), London, 1901.

⁴ C. Lallemand, "Rapport sur les travaux du service du nivellement général de la France, de 1900 à 1903" (*Comp. rend. de la 14^e conf. gén. de l'Assoc. Géod. Intern.*, 1903, p. 178).

It is well known that the masses of the earth are continually undergoing small changes; the earth's crust and sea-surface reciprocally oscillate, and the axis of rotation vibrates relatively to the body of the earth. The investigation of these problems falls in the programme of the Association. By continued observations of the water-level on sea-coasts, results have already been obtained as to the relative motions of the land and sea (cf. GEOLOGY); more exact levelling will, in the course of time, provide observations on countries remote from the sea-coast. Since 1900 an international service has been organized between some astronomical stations distributed over the north parallel of $30^\circ 8'$, at which geographical latitudes are observed whenever possible. The association contributes to all these stations, supporting four entirely: two in America, one in Italy, and one in Japan; the others partially (Tschardjui in Russia, and Cincinnati observatory). Some observatories, especially Pulkowa, Leiden and Tokyo, take part voluntarily. Since 1906 another station for South America and one for Australia in latitude $-31^\circ 55'$ have been added. According to the existing data, geographical latitudes exhibit variations amounting to $\pm 0.25''$, which, for the greater part, proceed from a twelve- and a fourteen-month period.⁵ (A. R. C.; F. R. H.)

EARTH CURRENTS. After the invention of telegraphy it was soon found that telegraph lines in which the circuit is completed by the earth are traversed by natural electric currents which occasionally interfere seriously with their use, and which are known as "earth currents."

1. Amongst the pioneers in investigating the subject were several English telegraphists, e.g. W. H. Barlow (1) and C. V. Walker (2), who were in charge respectively of the Midland and South-Eastern telegraph systems. Barlow noticed the existence of a more or less regular diurnal variation, and the result—confirmed by all subsequent investigators—that earth currents proper occur in a line only when both ends are earthed. Walker, as the result of general instructions issued to telegraph clerks, collected numerous statistics as to the phenomena during times of large earth currents. His results and those given by Barlow both indicate that the lines to suffer most from earth currents in England have the general direction N.E. to S.W. As Walker points out, it is the direction of the terminal plates relative to one another that is the essential thing. At the same time he noticed that whilst at any given instant the currents in parallel lines have with rare exceptions the same direction, some lines show normally stronger currents than others, and he suggested that differences in the geological structure of the intervening ground might be of importance. This is a point which seems still somewhat obscure.

Our present knowledge of the subject owes much to practical men, but even in the early days of telegraphy the fact that telegraph systems are commercial undertakings, and cannot allow

⁵ T. Albrecht, *Resultate des internat. Breitendienstes*, i. and ii. (Berlin, 1903 and 1906); F. Klein and A. Sommerfeld, *Über die Theorie des Kreisels*, iii. p. 672; R. Spitaler, "Die periodischen Luftmassenverschiebungen und ihr Einfluss auf die Lagenänderung der Erdaxe" (*Petermanns Mitteilungen, Ergänzungsheft*, 137); S. Newcomb, "Statement of the Theoretical Laws of the Polar Motion" (*Astronomical Journal*, 1898, xix. 158); F. R. Helmert, "Zur Erklärung der beobachteten Breitenänderungen" (*Astr. Nachr.* No. 3014); J. Weeder, "The 14-monthly period of the motion of the Pole from determinations of the azimuth of the meridian marks of the Leiden observatory" (*Kon. Ak. van Wetenschappen te Amsterdam*, 1900); A. Sokolof, "Détermination du mouvement du pôle terr. au moyen des méridiennes de Poulkovo" (*Mé. math. et astr.* vii., 1894); J. Bonardorf, "Beobachtungen von 5 Cassiopejæ mit dem grossen Zenitteleskop" (*Mitteilungen der Nikolai-Hauptsternwarte zu Pulkowo*, 1907); J. Larmor and E. H. Hills, "The irregular movement of the Earth's axis of rotation: a contribution towards the analysis of its causes" (*Monthly Notices R.A.S.*, 1906, lvii. 22); A. S. Christie, "The latitude variation Tide" (*Phil. Soc. of Wash.*, 1895, *Bull.* xiii. 103); H. G. van de Sande Bakhuyzen, "Über die Änderung der Polhöhe" (*Astr. Nachr.* No. 3261); A. V. Bäcklund, "Zur Frage nach der Bewegung des Erdpoles" (*Astr. Nachr.* No. 3787); R. Schumann, "Über die Polhöhenänderung" (*Astr. Nachr.* No. 3873); "Numerische Untersuchung" (*Ergänzungshefte zu den Astr. Nachr.* No. 11); *Weitere Untersuchungen* (No. 412); *Bull. astr.*, 1900, June, report of different theoretical memoirs.

the public to wait the convenience of science, was a serious obstacle to their employment for research. Thus Walker feelingly says, when regretting his paucity of data during a notable earth current disturbance: "Our clerks were at their wits' end to clear off the telegrams. . . . At a time when observations would have been very highly acceptable they were too much occupied with their ordinary duties." Some valuable observations have, however, been made on long-telegraph lines where special facilities have been given.

Amongst these may be mentioned the observations on French lines in 1883 described by E. E. Blavier (8), and those on two German lines Berlin-Thorn and Berlin-Dresden during 1884 to 1888 discussed by B. Weinstein (4).

2. Of the experimental lines specially constructed perhaps the best known are the Greenwich lines instituted by Sir G. B. Airy (5), the lines at Pawlowsk due to H. Wild (6), and those at Parc Saint Maur, near Paris (7).

Experimental Lines.—At Greenwich observations were commenced in 1865, but there have been serious disturbances due to artificial currents from electric railways for many years. There are two lines, one to Dartford distant about 10 m., in a direction somewhat south of east, the other to Croydon distant about 8 m., in a direction west of south.

Information from a single line is incomplete, and unless this is clearly understood erroneous ideas may be derived. The times at which the current is largest and least, or when it vanishes, in an east-west line, tell nothing directly as to the amplitude at the time of the resultant current. The lines laid down at Pawlowsk in 1883 lay nearly in and perpendicular to the geographical meridian, a distinct desideratum, but were only about 1 km. long. The installation at Parc Saint Maur, discussed by T. Moureaux, calls for fuller description. There are three lines, one having terminal earth plates 14.8 km. apart in the geographical meridian, a second having its earth plates due east and west of one another, also 14.8 km. apart, and the third forming a closed circuit wholly insulated from the ground. In each of the three lines is a Deprez d'Arsonval galvanometer. Light reflected from the galvanometer mirrors falls on photographic paper wound round a drum turned by clockwork, and a continuous record is thus obtained.

3. Each galvanometer has a resistance of about 200 ohms, but is shunted by a resistance of only 2 ohms. The total effective resistances in the N.-S. and E.-W. lines are 225 and 348 ohms respectively. If i is the current recorded, L , g and s the resistances of the line, galvanometer and shunt respectively, then E , the difference of potential between the two earth plates, is given by

$$E = i(1 + g/s) [L + gs / (g + s)].$$

To calibrate the record, a Daniell cell is put in a circuit including 1000 ohms and the three galvanometers as shunted. If i' be the current recorded, e the E.M.F. of the cell, then $e = i'(1 + g/s) [1000 + 3gs / (g + s)]$. Under the conditions at Parc Saint Maur we may write 2 for $gs / (g + s)$, and 1.072 for e , and hence we have approximately $E = 0.240(i/i')$ for the N.-S. line, and $E = 0.371(i/i')$ for the E.-W. line.

The method of standardization assumes a potential difference between earth plates which varies slowly enough to produce a practically steady current. There are several causes producing currents in a telegraph wire which do not satisfy this limitation. During thunderstorms surges may arise, at least in overhead wires, without these being actually struck. Again, if the circuit includes a variable magnetic field, electric currents will be produced independently of any direct source of potential difference. In the third circuit at Parc Saint Maur, where no earth plates exist, the current must be mainly due to changes in the earth's vertical magnetic field, with superposed disturbances due to atmospheric electricity or aerial waves. Even in the other circuits, magnetic and atmospheric influences play some part, and when their contribution is important, the galvanometer deflection has an uncertain value. What a galvanometer records when traversed by a suddenly varying current depends on other things than its mere resistance.

Even when the current is fairly steady, its exact significance is not easily stated. In the first place there is usually an appreciable E.M.F. between a plate and the earth in contact with it, and this E.M.F. may vary with the temperature and the dryness of the soil. Naturally one employs similar plates buried to the same depth at the two ends, but absolute identity and invariability of conditions can hardly be secured. In some cases on short lines (8), there is reason to fear that plate E.M.F.'s have been responsible for a good deal that has been ascribed to true earth currents. With deep earth plates, in dry ground, the source of uncertainty can, however, enter but little into the diurnal inequality.

4. Another difficulty is the question of the resistance in the earth itself. A given E.M.F. between plates 10 m. apart may mean very different currents travelling through the earth according to the chemical constitution and condition of the surface strata.

According to Professor A. Schuster (9), if ρ and ρ' be the specific resistances of the material of the wire and of the soil, the current i which would pass along an underground wire formed of actual soil, equal in diameter to the wire connecting the plates, is given by $i = i' \rho / \rho'$, where i' is the observed current in the wire. As ρ' will vary with the depth, and be different in different places along the route, while discontinuities may arise from geological faults, water channels and so on, it is clear that even the most careful observations convey but a general idea as to the absolute intensity of the currents in the earth itself. In Schuster's formula, as in the formulæ deduced for Parc Saint Maur, it is regarded as immaterial whether the wire connecting the plates is above or below ground. This view is in accordance with records obtained by Blavier (8) from two lines between Paris and Nancy, the one an air line, the other underground.

5. The earliest quantitative results for the regular diurnal changes in earth currents are probably those deduced by Airy (5) from the records at Greenwich between 1865 and 1870. Airy resolved the observed currents from the two Greenwich lines in and perpendicular to the magnetic meridian (then about 21° to the west of astronomical north). The information given by Airy as to the precise meaning of the quantities he terms "magnetic tendency" to north and to west is somewhat scanty, but we are unlikely to be much wrong in accepting the figures as proportional to the earth currents from magnetic east to west and from magnetic north to south respectively. Airy gives mean hourly values for each month of the year. The corresponding mean diurnal inequality for the whole year appears in Table I, the unit being arbitrary. In every month the algebraic mean of the 24 hourly values represented a current from north to south in the magnetic meridian, and from east to west in the perpendicular direction; in the same arbitrary units used in Table I, the mean values of these two "constant" currents were respectively 777 and 559.

6. *Diurnal Variation.*—Probably the most complete records of diurnal variation are those discussed by Weinstein (4) which depend on several years' records on lines from Berlin to Thorn and to Thorn. Relative to Berlin the geographical co-ordinates of the other two places are:

Thorn	$0^\circ 29' N.$ lat. $5^\circ 12' E.$ long.
Dresden	$1^\circ 28' S.$ lat. $0^\circ 21' E.$ long.

Thus the Berlin-Dresden line was directed about 84° east of south and the Berlin-Thorn line somewhat more to the north. The latter line had a length about 2.18 times that of the former. The resistances in the two lines were made the same, so that we suppose the difference of potential between earth plates along a given direction to vary as their distance apart, the current observed in the Thorn-Berlin line has to be divided by 2.18, comparable with the other. In this way, resolving along the perpendicular to the geographical meridian, Weinstein's figures as proportional to the earth currents from east to west and from south to north respectively

$$J = 0.147i' + 0.435i, \text{ and } J' = 0.983i' - 0.10i$$

where i and i' are the observed currents in the Thorn-Berlin and Dresden-Berlin lines respectively, both being counted positive when flowing towards Berlin.

It is tacitly assumed that the average earth conductivity is the same between Berlin and Thorn as between Berlin and Dresden. It should also be noticed that local time at Berlin and Thorn differs by fully 20 minutes, while the crests of the diurnal variations in short lines at the two places would probably occur about the same local time. The result is probably a less sharp occurrence of maxima and minima, and a relatively smaller range, than in a short line having the same orientation.

It was found that the average current derived from a number of undisturbed days on either line might be regarded as made up of a "constant part" plus a regular diurnal inequality, the constant part representing the algebraic mean value of the 24 hourly readings. In both lines the constant part showed a decided alteration during the third year—changing sign in one line—in consequence, it is believed, of alterations made in the earth plates. The constant part was regarded as a plate effect, and was omitted from further consideration. Table I. shows in terms of an arbitrary unit—whose relation to that employed for Greenwich data is unknown—the diurnal inequality in the currents along the two lines, and the inequalities thence calculated for ideal lines in and perpendicular to the geographical meridian. Currents are regarded as positive when directed from Berlin to Dresden and from north to south, the opposite point of view to that adopted by Weinstein. The table also shows the mean numerical value of the resultant current (the "constant" part being omitted) for each hour of the day, for the year as a whole, and for winter (November to February), equinox (March, April, September, October) and summer (May to

arithmetic means from the several months composing the season in question.

7. The mean of the 24 hourly numerical values of the resultant current for each month of the year a deducible from Weinstein's data—the unit being the same as before—are given in Table II.

TABLE II.—Mean Numerical Value of Resultant Current.

Jan.	Feb.	March	April	May	June	July	Aug.	Sep.	Oct.	Nov.	Dec.
152	211	293	328	313	314	337	300	258	235	165	132

There is thus a conspicuous minimum at mid-winter, and but little difference between the monthly means from April to August. This is closely analogous to what is seen in the daily range of the magnetic elements in similar latitudes (see MAGNETISM, TERRESTRIAL). There is also considerable resemblance between the curve whose ordinates represent the diurnal inequality in the current passing from north to south, and the curve showing the hourly change in the westerly component of the horizontal magnetic force in similar European latitudes.

8. Relations with Sun-spots, Auroras and Magnetic Storms.—Weinstein gives curves representing the mean diurnal inequality for separate years. In both lines the diurnal amplitudes were notably smaller in the later years which were near sun-spot minimum. This raises a presumption that the regular diurnal earth currents, like the ranges of the magnetic elements, follow the 11-year sun-spot period. When we pass to the large and irregular earth currents, which are of practical interest in telegraphy, there is every reason to suppose that the sun-spot period applies. These currents are always accompanied by magnetic disturbances, and when specially striking by brilliant aurora. One most conspicuous example of this occurred in the end of August and beginning of September 1859. The magnetic disturbances recorded were of almost unexampled size and rapidity, the accompanying aurora was extraordinarily brilliant, and E.M.F.'s of 700 and 800 volts are said to have been reached on telegraph lines 500 to 600 km. long. It is doubtful whether the disturbances of 1859 have been equalled since, but earth current voltages of the order of 0.5 volts per mile have been recorded by various authorities, e.g. Sir W. H. Preece (10).

It was the practice for several years to publish in the *Ann. du bureau central météorologique* synchronous magnetic and earth current curves from Parc Saint Maur corresponding to the chief disturbances of the year. In most cases there is a marked similarity between the curve of magnetic declination and that of the north-south earth current. At times there is also a distinct resemblance

TABLE I.

Mean Diurnal Inequalities for the year.						Numerical Values of resultant current.				
Greenwich.			Thorn-Berlin-Dresden.			Thorn-Berlin-Dresden.				
Hour.	North to South (Mag.)	East to West (Mag.)	Berlin to Dresden.	Thorn to Berlin.	North to South (Ast.)	East to West (Ast.)	Mean hourly values from			
							Year.	Winter.	Equinox.	Summer.
.1	-94	-41	-17	-13	-20	-10	81	94	51	98
2	-68	-24	-6	-13	-9	-11	84	115	39	97
3	-44	-8	-1	-1	-1	-1	84	113	31	108
4	-18	+9	-20	+15	-17	+17	101	94	58	127
5	-30	-1	-79	+21	-74	+32	122	58	78	230
6	-63	-33	-139	+5	-136	+26	148	80	139	225
7	-121	-80	-138	-36	-144	-14	166	155	206	136.
8	-175	-123	-7	-98	-28	-92	203	152	185	271
9	-156	-137	+249	-156	+212	-184	305	67	272	575
10	-43	-77	+540	-184	+494	-254	557	232	628	811
11	+82	+1	+722	-165	+678	-263	728	411	885	887
Noon	+207	+66	+673	-107	+642	-200	675	441	848	735
1	+245	+94	+404	-20	+395	-79	400	284	510	406
2	+205	+113	+35	+55	+46	+47	400	68	103	125
3	+159	+97	-261	+29	-217	+133	272	136	107	125
4	+159	+108	-397	+114	-368	+167	404	218	355	324
5	+167	+118	-321	+108	-363	+160	397	206	503	492
6	+125	+95	-311	+96	-287	+137	319	176	453	532
7	+43	+35	-237	+85	-216	+115	247	180	333	446
8	-22	+4	-191	+74	-173	+98	201	207	250	312
9	-115	-49	-168	+59	-153	+81	174	208	217	181
10	-138	-74	-135	+40	-125	+58	138	155	194	120
11	-136	-70	-84	+18	-79	+29	89	64	149	111
Midnight	-147	-80	-43	-2	-43	+4	91	42	95	107
									119	111

August). There is a marked double period in both the N.-S. and E.-W. currents. In both cases the numerically largest currents occur from 10 A.M. to noon, the directions then being from north to south and from west to east. The currents tend to die out and change sign about 2 P.M., the numerical magnitude then rising again rapidly to 4 or 5 P.M. The current in the meridian is notably the largest. The numerical values assigned to the resultant current are

between the horizontal force magnetic curve and that of the east-west earth current, but exceptions to this are not infrequent. Similar phenomena appear in synchronous Greenwich records published by Airy in 1868; these show a close accordance between the horizontal force curves and those of the currents from magnetic east to west. Originally it was supposed by Airy that whilst rapid movements in the declination and north-south current curves sometimes

occurred simultaneously, there was a distinct tendency for the latter to precede the former. More recent examinations of the Greenwich records by W. Ellis (11), and of the Parc St Maur curves by Moureaux, have not confirmed this result, and it is now believed that the two phenomena are practically simultaneous.

There has also been a conflict of views as to the connexion between magnetic and earth current disturbances. Airy's observations tended to suggest that the earth current was the primary cause, and the magnetic disturbance in considerable part at least its effect. Others, on the contrary, have supposed earth currents to be a direct effect of changes in the earth's magnetic field. The prevailing view now is that both the magnetic and the earth current disturbances are due to electric currents in the upper atmosphere, these upper currents becoming visible at times as aurora.

9. There seems some evidence that earth currents can be called into existence by purely local causes, notably difference of level. Thus K. A. Brander (12) has observed a current flowing constantly for a good many days from Airolo (height 1160 metres) to the Hospice St Gotthard (height 2094 metres). In an 8-km. line from Resina to the top of Vesuvius L. Palmieri (13)—observing in 1889 at three-hour intervals from 9 A.M. to 9 P.M.—always found a current running uphill so long as the mountain was quiet. On a long line from Vienna to Graz A. Baumgartner (14) found that the current generally flowed from both ends towards intervening higher ground during the day, but in the opposite directions at night. During a fortnight in September and October 1885 hourly readings were taken of the current in the telegraph cable from Fort-William to Ben Nevis Observatory, and the results were discussed by H. N. Dickson (15), who found a marked preponderance of currents up the line to the summit. The recorded mean data, otherwise regarded, represent a "constant" current, equal to 20 in the arbitrary units employed by Dickson, flowing up the line, together with the following diurnal inequality, + denoting current towards Fort-William (i.e. down the hill, and nearly east to west).

Hour	1	2	3	4	5	6	7	8	9	10	11	12
A.M.	-21	-41	+13	+23	+55	-3	+25	-32	-59	-62	-46	+6
P.M.	+24	+18	+115	+18	+75	-5	+50	-9	-56	-37	-28	-34

There is thus a diurnal inequality, which is by no means very irregular considering the limited number of days, and it bears at least a general resemblance to that shown by Weinstein's figures for an east-west line in Germany. This will serve to illustrate the uncertainties affecting these and analogous observations. A constant current in one direction may arise in whole or part from plate E.M.F.'s; a current showing a diurnal inequality will naturally arise between any two places some distance apart whether they be at different levels or not. Finally, when records are taken only for a short time, doubts must arise as to the generality of the results. During the Ben Nevis observations, for instance, we are told that the summit was almost constantly enveloped in fog or mist. By having three earth plates in the same vertical plane, one at the top of a mountain, the others at opposite sides of it, and then observing the currents between the summit and each of the base stations, as well as directly between the base stations—during an adequate number of days representative of different seasons of the year and different climatic conditions—many uncertainties would soon be removed.

10. *Artificial Currents.*—The great extension in the applications of electricity to lighting, traction and power transmission, characteristic of the end of the 19th century, has led to the existence of large artificial earth currents, which exert a disturbing influence on galvanometers and magnetic instruments, and also tend to destroy metal pipes. In the former case, whilst the disturbance is generally loosely assigned to stray or "vagabond" earth currents, this is only partly correct. The currents used for traction are large, and even if there were a perfectly insulated return there would be a considerable resultant magnetic field at distances from the track which were not largely in excess of the distance apart of the direct and return currents

(16). At a distance of half a mile or more from an electric tram line the disturbance is usually largest in magnetographs recording the vertical component of the earth's field. The magnets are slightly displaced from the position they would occupy if undisturbed, and are kept in continuous oscillation whilst the trams are running (17). The extent of the oscillation depends on the damping of the magnets.

The distance from an electric tram line where the disturbance ceases to be felt varies with the system adopted. It also depends on the length of the line and its subdivision into sections, on the strength of the currents supplied, the amount of leakage, the absence or presence of "boosters," and finally on the sensitiveness of the magnetic instruments. At the U.S. Coast and Geodetic Survey's observatory at Cheltenham the effect of the Washington electric trams has been detected by highly sensitive magnetographs, though the nearest point of the line is 12 m. away (18). Amongst the magnetic observatories which have suffered severely from this cause are those at Toronto, Washington (Naval Observatory), Kew, Paris (Parc St Maur), Perpignan, Nice, Lisbon, Vienna, Rome, Bombay (Colaba) and Batavia. In some cases magnetic observations have been wholly suspended, in others new observatories have been built on more remote sites.

As regards damage to underground pipes, mainly gas and water pipes, numerous observations have been made, especially in Germany and the United States. When electric tramways have uninsulated returns, and the potential of the rails is allowed to differ considerably from that of the earth, very considerable currents are found in neighbouring pipes. Under these conditions, if the joints between contiguous pipes forming a main present appreciable resistance, whilst the surrounding earth through moisture or any other cause is a fair conductor, current passes locally from the pipes to the earth causing electrolytic corrosion of the pipes. Owing to the diversity of interests concerned, the extent of the damage thus caused has been very variously estimated. In some instances it has been so considerable as to be the alleged cause of the ultimate failure of water pipes to stand the pressure they are exposed to.

BIBLIOGRAPHY.—See Svante August Arrhenius, *Lehrbuch der kosmischen Physik* (Leipzig, 1903), pp. 984-990. For lists of references see J. E. Burbank, *Terrestrial Magnetism*, vol. 10 (1905), p. 23; and P. Bachmetjew (8). For papers descriptive of corrosion of pipes, &c., by artificial currents, see *Science Abstracts* (in recent years in the volumes devoted to engineering) under the heading "Traction, Electric; Electrolysis." The following are the references in the text—(1) *Phil. Trans. R.S.* for 1849, pt. i. p. 61; (2) *Phil. Trans. R.S.* vol. 151 (1861), p. 89, and vol. 152 (1862), p. 203; (3) *Étude des courants telluriques* (Paris, 1884); (4) *Die Erdströme im deutschen Reichstelegraphengebiet* (Braunschweig, 1900); (5) *Phil. Trans. R.S.* vol. 158 (1868), p. 465, and vol. 160 (1870), p. 215; (6) *Mém. de l'Académie St-Petersbourg*, t. 31, No. 12 (1883); (7) T. Moureaux, *Ann. du Bureau Central Mété.* (Année 1893), 1 Mem. p. B 23; (8) P. Bachmetjew, *Mém. de l'Académie St-Petersbourg*, vol. 12, No. 3 (1901); (9) *Terrestrial Magnetism*, vol. 3 (1898), p. 130; (10) *Journal Tel. Engineers* (1881); (11) *Proc. R.S.* vol. 52 (1892), p. 191; (12) *Akad. Abhandlung* (Helsingfors, 1888); (13) *Acad. Napoli Recl.* (1890), and *Atti* (1894, 1895); (14) *Pogg. Ann.* vol. 76, p. 135; (15) *Proc. R.S.E.* vol. 13, p. 530; (16) A. Rücker, *Phil. Mag.* 1 (1901), p. 423, and R. T. Glazebrook, *ibid.* p. 432; (17) J. Edler, *Elektrische Zeit.* vol. 20 (1899); (18) L. A. Bauer, *Terrestrial Magnetism*, vol. 11 (1906), p. 53. (C. C.)

EARTH-NUT, the English name for a plant known botanically as *Conopodium denudatum* (or *Bunium flexuosum*), a member of the natural order Umbelliferae, which has a brown tuberous root-stock the size of a chestnut. It grows in woods and fields, has a slender flexuous smooth stem 2 to 3 ft. high, much-divided leaves, and small white flowers in many-rayed terminal compound umbels. Boswell Syme, in *English Botany*, iv. 114, says: "The common names of this plant in England are various. It is known as earth-nut, pig-nut, ar-nut, kipper-nut, hawk-nut, jar-nut, earth-chestnut and ground-nut. Though really excellent in taste and unobjectionable as food, it is disregarded in England by all but pigs and children, both of whom appreciate it and seek eagerly for it." Dr Withering describes the roots as little inferior to chestnuts. In Holland

and elsewhere on the continent of Europe they are more generally eaten.

EARTH PILLAR, a pillar of soft rock, or earth, capped by some harder material that has protected it from denudation. The "bad lands" of western North America furnish numerous examples. Here "the formations are often beds of sandstone or shale alternating with unindurated beds of clay. A semi-arid climate where the precipitation is much concentrated seems to be most favourable to the development of this type of formation." The country round the Dead Sea, where loose friable sandy clay is capped by harder rock, produces "bad-land" topography. The cap of hard rock gives way at the joints, and the water making its way downwards washes away the softer material directly under the cracks, which become wider, leaving isolated columns of clay capped with hard sandstone or limestone. These become smaller and fewer as denudation proceeds, the pillars standing a great height at times, until finally they all disappear.

EARTHQUAKE. Although the terrible effects which often accompany earthquakes have in all ages forced themselves upon the attention of man, the exact investigation of seismic phenomena dates only from the middle of the 19th century. A new science has been thus established under the name of *seismology* (Gr. *seisipos*, an earthquake).

History.—Accounts of earthquakes are to be found scattered through the writings of many ancient authors, but they are, for the most part, of little value to the seismologist. There is a natural tendency to exaggeration in describing such phenomena, sometimes indeed to the extent of importing a supernatural element into the description. It is true that attempts were made by some ancient writers on natural philosophy to offer a rational explanation of earthquake phenomena, but the hypotheses which their explanations involved are, as a rule, too fanciful to be worth reproducing at the present day. It is therefore unnecessary to dwell upon the references to seismic phenomena which have come down to us in the writings of such historians and philosophers as Thucydides, Aristotle and Strabo, Seneca, Livy and Pliny. Nor is much to be gleaned from the pages of medieval and later writers on earthquakes, of whom the most notable are Fromondi (1527), Maggio (1571) and Travagini (1679). In England, the earliest work worthy of mention is Robert Hooke's *Discourse on Earthquakes*, written in 1668, and read at a later date before the Royal Society. This discourse, though containing many passages of considerable merit, tended but little to a correct interpretation of the phenomena in question. Equally unsatisfactory were the attempts of Joseph Priestley and some other scientific writers of the 18th century to connect the cause of earthquakes with electrical phenomena. The great earthquake of Lisbon in 1755 led the Rev. John Michell, professor of mineralogy at Cambridge, to turn his attention to the subject; and in 1760 he published in the *Philosophical Transactions* a remarkable essay on the Cause and Phenomena of Earthquakes. A suggestion of much scientific interest was made by Thomas Young, when in his *Lectures on Natural Philosophy*, published in 1807, he remarked that an earthquake "is probably propagated through the earth nearly in the same manner as a noise is conveyed through the air." The recognition of the fact that the seismologist has to deal with the investigation of wave-motion in solids lies at the very base of his science. In 1846 Robert Mallet communicated to the Royal Irish Academy his first paper "On the Dynamics of Earthquakes"; and in the following year W. Hopkins, of Cambridge, presented to the British Association a valuable report in which earthquake phenomena were discussed in some detail. Mallet's labours were continued for many years chiefly in the form of Reports to the British Association, and culminated in his great work on the Neapolitan earthquake of 1857. An entirely new impetus, however, was given to the study of earthquakes by an energetic body of observers in Japan, who commenced their investigations about the year 1880, mainly through the influence of Prof. John Milne, then of Tokyo. Their work, carried on by means of new instruments of precision, and since taken up by observers

in many parts of the world, has so extended our knowledge of earthquake-motion that seismology has now become practically a new department of physical science.

It is hardly too much to say, however, that the earliest systematic application of scientific principles to the study of the effects of an earthquake was made by Mallet in his investigation of the Neapolitan earthquake mentioned above. It is true, the great Calabrian earthquake of 1783 had been the subject of careful inquiry by the Royal Academy of Naples, as also by Deodat Dolomieu and some other scientific authorities; but in consequence of the misconception which at that time prevailed with regard to the nature of seismic activity, the results of the inquiry, though in many ways interesting, were of very limited scientific value. It was reserved for Mallet to undertake for the first time an extensive series of systematic observations in an area of great seismic disturbance, with the view of explaining the phenomena by the application of the laws of wave-motion.

The "Great Neapolitan Earthquake," by which more than 12,300 lives were lost, was felt in greater or less degree over all Italy south of the parallel of 42°, and has been regarded as ranking third in order of severity among the recorded earthquakes of Europe. The principal shock occurred at about 10 P.M. on the 16th of December 1857; but, as is usually the case, it had been preceded by minor disturbances and was followed by numerous after-shocks which continued for many months. Early in 1858, aided by a grant from the Royal Society, Mallet visited the devastated districts, and spent more than two months in studying the effects of the catastrophe, especially examining, with the eye of an engineer, the cracks and ruins of the buildings. His voluminous report was published in 1862, and though his methods of research and his deductions have in many cases been superseded by the advance of knowledge, the report still remains a memorable work in the history of seismology.

Much of Mallet's labour was directed to the determination of the position and magnitude of the subterranean source from which the vibratory impulses originated. This is known variously as the *seismic centre*, *centrum*, *hypocentre*, *origin* or *focus*. It is often convenient to regard this centre theoretically as a point, but practically it must be a locus or space of three dimensions, which in different cases varies much in size and shape, and may be of great magnitude. That part of the surface of the earth which is vertically above the centre is called the *epicentre*; or, if of considerable area, the epicentral or epifocal tract. A vertical line joining the epicentre and the focus was termed by Mallet the *seismic vertical*. He calculated that in the case of the Neapolitan earthquake the focal cavity was a curved lamelliform fissure, having a length of about 10 m. and a height of about 3½ m., whilst its width was inconsiderable. The central point of this fissure, the theoretical seismic centre, he estimated to have been at a depth of about 6½ m. from the surface. Dr C. Davison, in discussing Mallet's data, was led to the conclusion that there were two distinct foci, possibly situated on a fault, or plane of dislocation, running in a north-west and south-east direction. Mallet located his epicentre near the village of Caggiano, not far from Polla, while the other seems to have been in the neighbourhood of Montemurro, about 25 m. to the south-east.

The intensity, or violence, of an earthquake is greatest in or near the epicentre, whence it decreases in all directions. A line drawn through points of equal intensity forms a curve round the epicentre known as an *isoseist*, an *isoseismal* or an *isoseismic line*. If the intensity declined equally in all directions the isoseismals would be circles, but as this is rarely if ever the case in nature they usually become ellipses and other closed curves. The tract which is most violently shaken was termed by Mallet the *meioseismic area*, whilst the line of maximum destruction is known as the *meioseismic line*. That isoseismal along which the decline of energy is most rapid was called by K. von Seebach a *pleiostoseist*.

In order to determine the position of the seismic centre, Mallet made much use of the cracks in damaged buildings, especially

in walls of masonry, holding that the direction of such fractures must generally be at right angles to that in which the normal earthquake-wave reached them. In this way he obtained the "angle of emergence" of the wave. He also assumed that free-falling bodies would be overthrown and projected in the direction of propagation of the wave, so that the epicentre might immediately be found from the intersection of such directions. These data are, however, subject to much error, especially through want of homogeneity in the rocks, but Mallet's work was still of great value.

A different method of ascertaining the depth of the focus was adopted by Major C. E. Dutton in his investigation of the **Charleston earthquake, 1886.** Charleston earthquake of the 31st of August 1886 for the U.S. Geological Survey. This catastrophe was heralded by shocks of greater or less severity a few days previously at Summerville, a village 22 m. north-west of Charleston. The great earthquake occurred at 9:51 P.M., standard time of the 75th meridian, and in about 70 seconds almost every building in Charleston was more or less seriously damaged, while many lives were lost. The epicentral tract was mainly a forest region with but few buildings, and the principal records of seismological value were afforded by the lines of railway which traversed the disturbed area. In many places these rails were flexured and dislocated. Numerous fissures opened in the ground, and many of these discharged water, mixed sometimes with sand and silt, which was thrown up in jets rising in some cases to a height of 20 ft. Two epicentres were recognized—one near Woodstock station on the South Carolina railway, and the other, being the centre of a much smaller tract, about 14 m. south-west of the first and near the station of Rantowles on the Charleston and Savannah line. Around these centres and far away isoseismal lines were drawn, the relative intensity at different places being roughly estimated by the effects of the catastrophe on various structures and natural objects, or, where visible records were wanting, by personal evidence, which is often vague and variable. The Rossi-Forel scale was adopted. This is an arbitrary scale formulated by Professor M. S. de Rossi, of Rome, and Dr F. A. Forel, of Geneva, based mostly on the ordinary phenomena observed during an earthquake, and consisting of ten degrees, of which the lowest is the feeblest, viz. I. Microseismic shock; II. Extremely feeble shock; III. Very feeble shock; IV. Feeble; V. Shock of moderate intensity; VI. Fairly strong shock; VII. Strong shock; VIII. Very strong shock; IX. Extremely strong shock; X. Shock of extreme intensity. Other conventional scales, some being less detailed, have been drawn up by observers in such earthquake-shaken countries as Italy and Japan. A curve, or theoretical isoseismal, drawn through certain points where the decline of intensity on receding from the epicentre seems to be greatest was called by Dutton an "index-circle"; and it can be shown that the radius of such a circle multiplied by the square root of 3 gives the focal depth theoretically. In this way it was computed that in the Charleston earthquake the origin under Woodstock must have had a depth of about 12 m. and that near Rantowles a depth of nearly 8 m. The determination of the index-circle presents much difficulty, and the conclusions must be regarded as only approximate.

It is probable, according to R. D. Oldham, that local earthquakes may originate in the "outer skin" of the earth, whilst a large world-shaking earthquake takes its origin in the deeper part of the "crust," whence such a disturbance is termed a *bathysm*. Large earthquakes may have very extended origins, with no definite centre, or with several foci.

The gigantic disaster known as the "Great Indian Earthquake," which occurred on the 12th of June 1897, was the subject of careful investigation by the Geological Survey of India and was described in detail by the superintendent, R. D. Oldham. It is sometimes termed the Assam earthquake, since it was in that province that the effects were most severe, but the shocks were felt over a large part of India, and indeed far beyond its boundaries. Much of the area which suffered most disturbance

was a wild country, sparsely populated, with but few buildings of brick or stone from which the violence of the shocks could be estimated. The epicentral tract was of great size, having an estimated area of about 6000 sq. m., but the mischief was most severe in the neighbourhood of Shillong, where the stonework of bridges, churches and other buildings was absolutely levelled to the ground. After the main disturbance, shocks of greater or less severity continued at intervals for many weeks. It is supposed that this earthquake was connected with movement of subterranean rock-masses of enormous magnitude along a great thrust-plane, or series of such planes, having a length of about 200 m. and a maximum breadth of not less than 50 m. It is pointed out by Oldham that this may be compared for size with the great Faïlle du Midi in Belgium, which is known to extend for a distance of 120 m. The depth of the principal focus, though not actually capable of determination, was probably less than 5 m. from the surface. From the focus many secondary faults and fractures proceeded, some reaching the surface of the ground. Enormous landslips accompanied the earthquake, and as an indirect effect of these slides the form of the water-courses became in certain cases modified. Permanent changes of level were also observed.

Eight years after the great Assam earthquake India was visited by another earthquake, which, though less intense, resulted in the loss of about 20,000 lives. This catastrophe is known as the Kangra earthquake, since its centre seems to have been located in the Kangra valley, in the north-west Himalaya. It occurred on the 4th of April 1905, and the first great shocks were felt in the chief epifocal district at about 6.9 A.M., Madras time. Although the tract chiefly affected was around Kangra and Dharmasala, there was a subordinate epifocal tract in Dehra Dun and the neighbourhood of Mussoorie, whilst the effects of the earthquake extended in slight measure to Lahore and other cities of the plain. It is estimated that the earthquake was felt over an area of about 1,625,000 m. Immediately after the calamity a scientific examination of its effects was made by the Geological Survey of India, and a report was drawn up by the superintendent, C. S. Middlemiss.

The great earthquake, which, with the subsequent fire, wrought such terrible destruction in and around San Francisco on the 18th of April 1906, was the most disastrous ever recorded in California. It occurred between 10 and 15 minutes after 5 A.M., standard time of the 120th meridian. The moment at which the disaster began and the duration of the shock varied at different localities in the great area over which the earthquake was felt. At San Francisco the main shock lasted rather more than one minute.

According to the official Report, the earthquake was due to rupture and movement along the plane of the San Andreas fault, one of a series which runs for several hundred miles approximately in a N.W. and S.E. direction near the coast line. Evidence of fresh movement along this plane of dislocation was traced for a distance of 190 m. from San Juan on the south to Point Arena on the north. There the trace of the fault is lost beneath the sea, but either the same fault or another appears 75 m. to the north at Point Delgada. The belt of disturbed country is notoriously unstable, and part of the fault had been known as the "earthquake crack." The direction is marked by lines of straight cliffs, long ponds and narrow depressions, forming a Rift, or old line of seismic disturbance. According to Dr G. K. Gilbert the earthquake zone has a length of 300 or 400 m. The principal displacement of rock, in 1906, was horizontal, amounting generally to about 10 ft. (maximum 21 ft.), but there was also locally a slight vertical movement, which towards the north end of the fault reached 3 ft. Movement was traced for a distance of about 270 m., and it is estimated that at least 175,000 sq. m. of country must have been disturbed. In estimating the intensity of the earthquake in San Francisco a new scale was introduced by H. O. Wood. The greatest structural damage occurred on soft alluvial soil and "made ground." Most of the loss of property in San Francisco was

Great Indian earthquake, 1897.

Kangra earthquake, 1905.

California earthquake, 1906.

due to the terrible fire which followed the earthquake and was beyond control owing to the destruction of the system of water-supply.

Immediately after the catastrophe a California Earthquake Investigation Committee was appointed by the governor of the state; and the American Association for the Advancement of Science afterwards instituted a Seismological Committee. The elaborate Report of the State Investigation Committee, by the chairman, Professor A. C. Lawson, was published in 1908.

On the 17th of August 1906 a disastrous earthquake occurred at Valparaiso, and the year 1906 was marked generally by exceptional seismic activity.

The Jamaica earthquake of the 14th of January 1907 appears to have accompanied movement of rock along an east and west fracture or series of fractures under the sea a few miles from the city of Kingston. The statue of Queen Victoria at Kingston was turned upon its pedestal the eighth of a revolution.

A terrible earthquake occurred in Calabria and Sicily on December 28, 1908, practically destroying Messina and Reggio.

According to the official returns the total loss of life was 77,283. Whilst the principal centre seems to have been in the Strait of Messina, whence the disturbance is generally known as the Messina earthquake, there were independent centres in the Calabrian peninsula, a country which had been visited by severe earthquakes not long previously, namely on September 8, 1905, and October 23, 1907. The principal shock of the great Messina earthquake of 1908 occurred at 5.21 A.M. (4.21 Greenwich time), and had a duration of from 30 to 40 seconds. Neither during nor immediately before the catastrophe was there any special volcanic disturbance at Etna or at Stromboli, but it is believed that there must have been movement along a great plane of weakness in the neighbourhood of the Strait of Messina, which has been studied by E. Cortese. The sea-floor in the strait probably suffered great disturbance, resulting in the remarkable movement of water observed on the coast. At first the sea retired, and then a great wave rolled in, followed by others generally of decreasing amplitude, though at Catania the second was said to have been greater than the first. At Messina the height of the great wave was 2.70 metres, whilst at Ali and Giardini it reached 8.40 metres and at San Alessio as much as 11.7 metres. At Malta the tide-gauge recorded a wave of 0.91 metre. The depth of the chief earthquake-centre was estimated by Dr E. Oddone at about 9 kilometres. The earthquake and accompanying phenomena were studied also by Professor A. Riccò, Dr M. Baratta and Professor G. Platania and by Dr F. Omori of Tokyo. After the great disturbance, shocks continued to affect the region intermittently for several months. In certain respects the earthquake of 1908 presented much resemblance to the great Calabrian catastrophe of 1783.

It has been proposed by R. D. Oldham that the disturbance which causes the fracture and permanent displacement of the rocks during an earthquake should be called an "earthshake," leaving the term earthquake especially for the vibratory motion. The movement of the earthquake is molecular, whilst that of the earthshake is molar. Subsequently he suggested the terms *mochleusis* and *archesis* (*μολχλιωσις*, I heave; *ἀρχήσις*, I dance), to denote respectively the molar and the molecular movement, retaining the word earthquake for use in its ordinary sense.

In most earthquakes the proximate cause is generally regarded as the fracture and sudden movement of underground rock-masses. Disturbances of this type are known as "tectonic" earthquakes, since they are connected with the folding and faulting of the rocks of the earth's crust. They indicate a relief of the strain to which the rock-masses are subjected by mountain-making and other crustal movements, and they are consequently apt to occur along the steep face of a table-land or the margin of a continent with a great slope from land to sea. In many cases the immediate seat of the originating impulse is located beneath the sea, giving rise to submarine disturbances which have been called "seaquakes." Much attention has been given to these suboceanic disturbances by Professor E. Rudolph.

Professor J. H. Jeans has pointed out that the regions of the earth's crust most affected by earthquakes lie on a great circle corresponding with the equator of the slightly pear-shaped figure that he assigns to the earth. This would represent a belt of weakness, subject to crushing, from the tendency of the pear to pass into a spherical or spheroidal form under the action of internal stresses. According to the comte de Montessus de Ballore, the regions of maximum seismic instability appear to be arranged on two great circles, inclined to each other at about 67°. These are the Circumpacific and Mediterranean zones.

Maps of the world, showing the origins of large earthquakes each year, accompany the Annual Reports of the Seismological Committee of the British Association, drawn up by Professor Milne. It is important to note that Professor Milne has shown a relationship between earthquake-frequency and the wandering of the earth's pole from its mean position. Earthquakes seem to have been most frequent when the displacement of the pole has been comparatively great, or when the change in the direction of movement has been marked. Valuable earthquake catalogues have been compiled at various times by Alexis Perrey, R. and J. W. Mallet, John Milne, T. Oldham, C. W. C. Fuchs, F. de Montessus de Ballore and others.

Such earthquakes as are felt from time to time in Great Britain may generally be traced to the formation of faults, or rather to incidents in the growth of old faults. The East Anglian earthquake of the 22nd of April 1884—the most disastrous that had occurred in the British Isles for centuries—was investigated by Prof. R. Meldola and W. White on behalf of the Essex Field Club. The shocks probably proceeded from two foci—one near the villages of Peldon and Abberton, the other near Wivenhoe and Rowhedge, in N.E. Essex. It is believed that the superficial disturbance resulted from rupture of rocks along a deep fault. An attempt has been made by H. Darwin, for the Seismological Committee of the British Association, to detect and measure any gradual movement of the strata along a fault, by observation at the Ridgeway fault, near Upway, in Dorsetshire. Dr C. Davison in studying the earthquakes which have originated in Britain since 1889 finds that several have been "twins." A twin earthquake has two maxima of intensity proceeding from two foci, whereas a double earthquake has its successive impulses from what is practically a single focus. The Hereford earthquake of December 1896, which resulted in great structural damage, was a twin, having one epicentre near Hereford and the other near Ross. Davison refers it to a slip along a fault-plane between the anticlinal areas of Woolhope and May Hill; and according to the same authority the Inverness earthquake of the 18th of September 1901 was referable to movement along a fault between Loch Ness and Inverness. The South Wales earthquake of June 27, 1906, was probably due to movement connected with the Armorican system of folds, striking in an east and west direction.

It may be noted that when a slip occurs along a fault, the displacement underground may be but slight and may die out before reaching the surface, so that no scarp is formed. In connexion, however, with a seismic disturbance of the first magnitude the superficial features may be markedly affected. Thus, the great Japan earthquake of October 1891—known often as the Mino-Owari earthquake—was connected with the formation or development of a fault which, according to Professor B. Koto, was traced on the surface for a distance of nearly 50 m. and presented in places a scarp with a vertical throw of as much as 20 ft., while probably the maximum displacement underground was very much greater.

Although most earthquakes seem to be of tectonic type, there are some which are evidently connected, directly or indirectly, with volcanic activity (see VOLCANO). Such, it is commonly believed, were the earthquakes which disturbed the Isle of Ischia in 1881 and 1883, and were studied by Professor J. Johnston-Lavis and G. Mercalli. In addition to the tectonic and volcanic types, there are occasional earthquakes of minor importance which may be referred to the collapse of the roof of

Messina
earth-
quake,
1908.

British
earth-
quakes.

caverns, or other falls of rock in underground cavities at no great depth. According to Prof. T. J. J. See most earthquakes are due, directly or indirectly, to the explosive action of steam, formed chiefly by the leakage of sea-water through the ocean floor.

Whatever the nature of the impulse which originates the earthquake, it gives rise to a series of waves which are propagated through the earth's substance and also superficially. In one kind, known as normal or condensational waves, or waves of elastic compression, the particles vibrate to and from the centre of disturbance, moving in the direction in which the wave travels, and therefore in a way analogous to the movement of air in a sound-wave. Associated with this type are other waves termed transverse waves, or waves of elastic distortion, in which the particles vibrate across or around the direction in which the wave is propagated. The normal waves result from a temporary change of volume in the medium; the transverse from a change of shape. The distance through which an earth-particle moves from its mean position of rest, whether radially or transversely, is called the amplitude of the wave; whilst the double amplitude, or total distance of movement, to and fro or up and down, like the distance from crest to trough of a water wave, may be regarded as the range of the wave. The period of a wave is the time required for the vibrating particle to complete an oscillation. As the rocks of the earth's crust are very heterogeneous, the earthquake-waves suffer refraction and reflection as they pass from one rock to another differing in density and elasticity. In this way the waves break up and become much modified in course of transmission, thus introducing great complexity into the phenomena. It is known that the normal waves travel more rapidly than the transverse.

Measurements of the surface speed at which earthquake-waves travel require very accurate time-measurements, and these are not generally available in earthquake-shaken regions. Observations during the Charleston earthquake of 1886 were at that time of exceptional value, since they were made over a large area where standard time was kept. Lines drawn through places around the epicentre at which the shock arrives at the same moment are called coseismal lines. The motion of the wave is to be distinguished from the movement of the vibrating particles. The velocity of the earth-particle is its rate of movement, but this is constantly changing during the vibration, and the rate at which the velocity changes is technically called the acceleration of the particle.

Unfelt movements of the ground are registered in the earthquake records, or seismograms, obtained by the delicate instruments used by modern seismologists. From the study of the records of a great earthquake from a distant source, sometimes termed a teleseismic disturbance, some interesting inferences have been drawn with respect to the constitution of the interior of the earth. The complete record shows two phases of "preliminary tremors" preceding the principal waves. It is believed that while the preliminary tremors pass through the body of the earth, the principal waves travel along or parallel to the surface. Probably the first phase represents condensational, and the second phase distortional, waves. Professor Milne concludes from the speed of the waves at different depths that materials having similar physical properties to those at the surface may extend to a depth of about 30 m., below which they pass into a fairly homogeneous nucleus. From the different rates of propagation of the precursors it has been inferred by R. D. Oldham that below the outer crust, which is probably not everywhere of the same thickness, the earth is of practically uniform character to a depth of about six-tenths of the radius, but the remaining four-tenths may represent a core differing physically and perhaps chemically from the outer part. Oldham also suggests, from his study of oceanic and continental wave-paths, that there is probably a difference in the constitution of the earth beneath oceans and beneath continents.

The surface waves, which are waves of great length and long period and are propagated to great distances with practically a constant velocity, have been regarded as quasi-elastic gravitational

waves. Further, in a great earthquake the surface of the ground is sometimes visibly agitated in the epifocal district by undulations which may be responsible for severe superficial damage. (See also for elastic waves ELASTICITY, § 89.)

An old classification of earthquake-shocks, traces of which still linger in popular nomenclature, described them as "undulatory," when the movement of the ground was mainly in a horizontal direction; "subsultory," when the motion was vertical, like the effect of a normal wave at the epicentre; and "vorticoso," when the movement was rotatory, apparently due to successive impulses in varying directions.

The sounds which are associated with seismic phenomena, often described as subterranean rumbling and roaring, are not without scientific interest, and have been carefully studied by Davison. "Isacoustic lines" are curves drawn through places where the sound is heard by the same percentage of observers. The sound is always low and often inaudible to many.

The refined instruments which are now used by seismologists for determining the elements of earthquake motion and for recording earthquakes from distant origins are described in the article SEISMOETER. These instruments were developed as a consequence of the attention given in modern times to the study of earthquakes in the Far East. (F. W. R.*)

Strange as it may appear, the advances that have been made in the study of earthquakes and the world-wide interest shown in their phenomena were initiated in work commenced in Japan. When the Japanese government, desiring to adopt Western knowledge, invited to its shores bodies of men to act as its instructors, the attention of the newcomers was naturally attracted to the frequent shakings of the ground. Interest in these phenomena increased more rapidly than their frequency, and at length it was felt that something should be done for their systematic study. At midnight on the 22nd of February 1880 movements more violent than usual occurred; chimneys were shattered or rotated, tiles slid down from roofs, and in the morning it was seen that Yokohama had the appearance of a city that had suffered a bombardment. The excitement was intense, and before the ruins had been removed a meeting was convened and the Seismological Society of Japan established. The twenty volumes of original papers published by this body summarize to a large extent the results of the later study of seismology.¹

The attention of the students of earthquakes in Japan was at first directed almost entirely to seismometry or earthquake measurement. Forms of apparatus which then existed, as for example the seismographs, seismometers and seismoscopes of Mallet, Palmieri and others, were subjected to trial; but inasmuch as they did little more than indicate that an earthquake had taken place—the more elaborate forms recording also the time of its occurrence—they were rapidly discarded, and instruments were constructed to measure earthquake motion. Slightly modified types of the new instruments devised in Japan were adopted throughout the Italian peninsula, and it is fair to say that the seismometry developed in Japan revolutionized the seismometry of the world. The records obtained from the new instruments increased our knowledge of the character of earthquake motion, and the engineer and the architect were placed in a position to construct so that the effects of known movements could be minimized. It was no doubt the marked success, both practical and scientific, attending these investigations that led the Japanese government to establish a chair of seismology at its university, to organize a system of nearly 1000 observing stations throughout the country, and in 1893 to appoint a committee of scientific and practical men to carry out investigations which might palliate the effects of seismic disturbances. In the first year this committee received a grant of £5000, and as liberal sums for the same purpose appear from time to time in the

¹ The publications for 1880-1892 were termed the *Transactions of the Seismological Society of Japan*, and for 1893-1895 the *Seismological Journal of Japan*. The observations are now published by the Earthquake Investigation Committee of Japan, and edited by F. Omori, professor of seismology at the university of Tokyo.

parliamentary estimates, it may be assumed that the work has been fraught with good results. In their publications we find not only records of experiences and experiments in Japan, but descriptions and comments upon earthquake effects in other countries. In two of the volumes there are long and extremely well illustrated accounts of the earthquake which on the 12th of June 1897 devastated Assam, to which country two members of the above-mentioned committee were despatched to gather such information as might be of value to the architect and builder in earthquake-shaken districts.

A great impetus to seismological investigation in Europe and America was no doubt given by the realization of the fact that a large earthquake originating in any one part of the world may be recorded in almost any other. Italy for many years past has had its observatories for recording earthquakes which can be felt, and which are of local origin, but at the present time at all its first-class stations we find instruments to record the unfeared movements due to earthquakes originating at great distances, and as much attention is now paid to the large earthquakes of the world as to the smaller ones originating within Italian territory.¹ The *Kaiserliche Akademie der Wissenschaften* of Vienna established earthquake observatories in Austria,² and the Central Observatorium of St Petersburg has carried out similar work in Russia. Germany attached a seismological observatory to its university at Strassburg, whilst provision has been made for a professorship of Earth Physics (*Geophysik*) at Göttingen.³ In accordance with the recommendation of the British Association, seismographs of a similar character have been installed at stations all over the world.⁴ The principal objects of this extended and still extending system of stations are to determine the velocity with which motion is propagated over the surface and through the interior of the earth, to locate the positions of sub-oceanic earthquake origins, and generally to extend our knowledge respecting the physical nature of the planet on which we live.

We now know that earthquakes are many times more frequent than was previously supposed. In Japan, for example, between 1885 and 1892 no fewer than 8331 were recorded—that is to say, on the average there were during that time more than 1000 disturbances per year. Although many of these did not cause a sensible shaking over areas exceeding a few hundred square miles, many of them were sufficiently intense to propagate vibrations round and through the globe. If we pick out the well-marked earthquake districts of the world, and give to each of them a seismicity or earthquake frequency per unit area one-third of that in Japan, the conclusion arrived at is that considerable areas of our planet are on the average shaken every half-hour.

The knowledge which we now possess respecting the localities where earthquakes are frequent and the forms of the foci from which they have spread, enables us to speak definitely respecting the originating causes of many of these phenomena. It is found, for example, that although in many countries there may be displays of volcanic and seismic activity taking place almost side by side, it is only rarely that there is direct relationship between the two. Now and then, however, before a volcano breaks into eruption there may be a few ineffectual efforts to form a vent, each of which

¹ The chief Italian station is at Rocca di Papa near Rome. It is equipped with delicate instruments designed by its director, Giovanni Agamenone. The records since 1895 are published in the *Bollettino della Società Sismologica Italiana*, edited by Luigi Palazzo, director of the Central Office for Meteorology and Geodynamica at Rome.

² The chief Austrian publications are:—*Mittheilungen der Erdbebencommission der k. Akad. der Wissen. in Wien* (since 1897); *Die Erdbebenwarte (1901-1907)*; and the "Neueste Erdbebennachrichten, Beilage der Monatschrift," *Die Erdbebenwarte*.

³ The "International Seismological Association" was founded at Strassburg in 1903, and publishes the *Beiträge zur Geophysik*, edited by George Gerland, director of the Strassburg station; the papers are printed in several languages.

⁴ The records of the British Association stations are published (since 1896) in the *Reports*. Chile has a national earthquake service (founded after the Valparaiso earthquake of August 1906) directed by comte de Montessus de Bellore.

is accompanied by no more than a slight local shaking of the ground. This is true even for the largest and most violent eruptions, when mountains have with practically a single effort blown off their heads and shoulders. Thus the earthquake which accompanied the eruption of Bandaisan, in central Japan, in 1888 was felt only over a radius of 25 m. The analyses of the seismic registers of Japan clearly indicate that comparatively few shakings originate near to the volcanoes of the country, the majority of them, like those of many other countries, coming from regions where volcanic rocks are absent. The greatest number spread inland from the Pacific seaboard, the movement becoming more and more feeble as it approaches the backbone of the country, which is drilled with numerous volcanic vents. What is true for Japan is generally true for the western coasts of North and South America.

Speaking broadly, earthquakes are most frequent along the steeper flexures in the earth's surface, and in those regions where there is geological evidence to show that slow secular movements in the earth's crust are possibly yet in progress. With a unit distance of 2 degrees, or 120 geographical m., we find that the slopes running eastwards from the highlands of Japan and westwards from the Andean ridges down into the Pacific vary from 1 in 20 to 1 in 30, and it is on the faces or near to the bottom of these slopes that seismic efforts are frequent. The slopes running from Australia, eastern America and western Europe into the neighbouring oceans vary between 1 in 70 and 1 in 250, and in these regions earthquakes are of rare occurrence. The seismic activity met with in the Himalayas and the Alps finds its best explanation in the fact that these mountains are geologically recent, and there are no reasons to doubt that the forces which brought their folds into existence are yet in action.

This peculiar association of earthquakes with pronounced topographical configuration and certain geological conditions evidently indicates that the origin of many of them is connected with rock folding. Inasmuch as certain large earthquakes have been accompanied by rock fracture, as for example in 1891, when in central Japan a fault some 50 m. in length was created, whilst the origins of others have been distinctly traced to the line of an existing fault or its continuation, we may conclude that the majority of earthquakes are spasmodic accelerations in the secular movements which are creating (and in some instances possibly obliterating) the more prominent features of the earth's surface. These secular movements, which include upheavals, subsidences, horizontal displacements—all of which are explained on the assumption of a crust seeking support on a nucleus gradually contracting by loss of heat, are collectively referred to as bradyseismic (*βραδύς*, slow) movements. To these may be added movements directly attributable to the influence of gravity. Sub-oceanic districts in a state of seismic strain may be so far loaded by the accumulation of sediments that gentle bending may be accompanied by sudden yieldings. This possibly accounts for the frequency of earthquakes off the mouth of the Tonegawa on the eastern side of Japan. The distortions so frequently observed in fossils and pebbles, the varying thickness of contorted strata, and the "creep" in coal-mines, together with other phenomena, indicate that rocks may flow. Observations of this nature lead to the supposition that high plateau-like regions may be gradually subsiding under the influence of their own weight, and that the process of settlement may from time to time be spasmodic in its character. Whether the earthquakes which originate round the submerged basal frontiers of the continents bounding the Pacific are ever attributable to such activities, it is impossible to say. All that we know with certainty is that they are sometimes accompanied by such a vast displacement of material that the ocean has been set into a state of oscillation for periods of 24 hours, that in some instances there have been marked changes in depth, and that enormous sub-oceanic landslips have occurred. These phenomena are, however, equally well explained on the assumption of sudden faulting accompanied by violent shaking, which would dislodge steeply inclined beds of material beneath the ocean as it does upon the land.

Seismological research.

Frequency of earthquakes.

Volcanoes and earthquakes.

Origin of earthquakes.

Although the proximate cause of earthquake motion is traced to sudden yieldings in the crust of the earth brought about by some form of bradyseismical action, the existence of at least two distinct types of seismic motion indicates that the mechanical conditions accompanying the fracturing of rocks are not always identical. 90 or 95 % of the earthquakes which can be recorded consist of elastic or quasi-elastic vibrations. The remainder, including the large earthquakes, not only exhibit the elastic movements, but are accompanied by surface undulations which are propagated most certainly for some hundreds of miles round their origin, and then as horizontal movements sweep over the whole surface of the globe. The former of these may accompany the formation of a new fault or the sudden renewal of movement along an old one; they are cracking or rending effects, without any great displacement. The latter are probably fracturings accompanied by vertical and horizontal displacements of masses of the earth's crust sufficiently great to set up the observed surface undulations. These shocks are so frequently followed a few minutes later by disturbances, which from their similarity to the movements which have preceded them may be called earthquake echoes, that we are led to the speculation that we are here dealing with the caving-in of ill-supported portions of the earth's crust, the waves from which are radiated to boundaries and then returned to their origin to coalesce and give rise to a second impulse not unlike the primary. Succeeding the first repetition of motion recorded by the seismograph there is often a rhythmical repetition of similar wave groups, suggesting the existence within our earth of phenomena akin to multiple echoes.

The introduction of new methods into seismometry quickly revolutionized our ideas respecting the character of earthquake motion. Although an earthquake may be strongly felt within a distance of 50 m. from its origin, and although the movements in the upper storeys of buildings within the shaken area may be large, the actual range of the horizontal motion of the ground is usually less than $\frac{1}{10}$ of an inch. With such earthquakes ordinary seismographs for recording vertical motion do not show any disturbance. When the movement reaches $\frac{1}{2}$ in. it becomes dangerous, and a back-and-forth movement of an inch is usually accompanied by destructive effects. In this latter case the amplitude of the vertical record which indicates the existence of surface waves will vary between $\frac{1}{2}$ and $\frac{1}{3}$ of an inch. In the earthquake which devastated central Japan on the 26th of October 1891, nearly every building within the epifocal district fell, the ground was fissured, forests slipped down from mountain sides to dam up valleys, whilst the valleys themselves were permanently compressed. The horizontal movements seem to have reached 9 in. or 1 ft., and the surface undulations were visible to the eye.

The rapidity with which the movements are performed varies throughout a disturbance. A typical earthquake usually commences with minute elastic vibrations, the periods of which vary between $\frac{1}{2}$ and $\frac{1}{10}$ of a second. These are recorded by seismographs, and are noticed by certain of the lower animals like pheasants, which before the occurrence of movement perceptible to human beings scream as if alarmed. When an earthquake is preceded by a sound we have evidence of preliminary tremors even more rapid than those recorded by seismographs. Following these precursors there is a shock or shocks, the period of which will be 1 or 2 seconds. From this climax the movements, although irregular in character, become slower and smaller until finally they are imperceptible. The duration of a small earthquake usually varies from a few seconds to a minute, but large earthquakes, which are accompanied by surface undulations, may be felt for 2 or 3 minutes, whilst an ordinary seismograph indicates a duration of from 6 to 12 minutes. A free horizontal pendulum tells us that with severe earthquakes the ground comes to rest by a series of more or less rhythmical surgings continuing over 1 or 2 hours. Although the maximum displacement has a definite direction, the successive vibrations are frequently performed in many different azimuths. The predominating

direction at a given station in certain instances is apparently at right angles to the strike of the neighbouring strata, this being the direction of easiest yielding.

Earthquake motion as recorded at stations several thousands of miles distant from its origin exhibits characteristics strikingly different from those just described. The precursors now show periods of from 1 to 5 seconds, whilst the largest movements corresponding to the shocks may have periods of from 20 to 40 seconds. The interval of time by which the first tremors have outraced the maximum movement has also become greater. Within a few hundreds of miles from an origin this interval increases steadily, the velocity of propagation of the first movements being about 2 km. per second, whilst that of the latter may be taken at about 1.6 km. per second. Beyond this distance the velocity of transmission of the first movements rapidly increases, and for great distances, as for example from Japan to England, it is higher than we should expect for waves of compression passing through steel or glass. This observation precludes the idea that these preliminary tremors have travelled through the heterogeneous crust of the earth, and since the average velocity of their transmission increases with the length of the path along which they have travelled, and we but rarely obtain certain evidence that a seismograph has been disturbed by waves which have reached it by travelling in opposite directions round the world, we are led to the conclusion that earthquake precursors pass through our earth and not round its surface. The following table relating to earthquakes, which originated off the coast of Borneo on the 20th and 27th of September 1897, is illustrative of the velocities here considered:—

Localities.	Distance from origin in degrees.	Velocity in kms. per sec. if on chord.	Average depth of chord in kms.
Nicolaiëff	81°	8.1	8.0
Potsdam	92°	8.4	9.1
Catania, Ischia, Rocca di Papa, Rome	96°	9.0	9.5
Isle of Wight	103°	9.8	10.2

The chords referred to here are those joining the earthquake origins and distant observing stations, and it will be noted that one-quarter of the square root of the average depths at which these run closely corresponds to observed average velocities if wave paths followed chords. This increase of velocity with average depth shows that the paths followed through the earth must be curved with their convexity towards the centre of the earth. These observations do not directly tell us to what extent a true wave path is deflected from the direction of a chord, but they suggest as an extremely plausible assumption that the square of the speed is a linear function of the depth below the surface of the earth. With this assumption Dr C. G. Knott shows that the square of the speed (v^2) can be expressed linearly in terms of the average depth of the chord d , thus: $v^2 = 2.9 + .026 d$, the units being miles and seconds. The formula applies with fair accuracy to moderate and high values of d , but it gives too high a value for short chords. It follows that the square of the speed increases 0.9% per mile of descent in the earth. The conclusion we arrive at is that the preliminary tremors which pass through the earth do so in the vicinity of their origin at the rate of almost 2.3 km. per second. This velocity increases as the wave path plunges downwards, attaining in the central regions a velocity of 16 to 17 kms., whilst the highest average velocity which is across a diameter lies between 10 and 12 kms. per second.

The large surface waves radiating from an origin to a distant place have velocities lying between 1.6 and 4 kms. per second, and it has been observed that when the higher velocity has been noted this refers to an observation at a station very remote from the origin. One explanation of this is the assumption that only very large waves indicating a large initial disturbance are capable of travelling to great distances, and as pointed out by

Two types of earthquake motion.

Character of earthquake motion.

Period and duration.

R. D. Oldham, large waves under the influence of gravity will travel faster than small waves. These waves (which may be gravitational or distortional) are recorded as slow tiltings of the ground measured by angles of 0.5 to 10 or 15 seconds of arc, or as horizontal displacements of 0.5 to several millimetres. Their calculated lengths have reached 50 kms. (31 m.).

In the section of this article relating to the cause of earthquakes a little has been said about their frequency or the number of times these phenomena are repeated during a given interval of time. It has been shown that all countries are very often moved by earthquakes which have originated at great distances. Great Britain, for example, is crossed about 100 times a year by earthquake waves having durations of from 3 minutes to 3 hours, whilst the vibratory motions which originate in that country are not only small but of rare occurrence. In the earlier stages of the world's history, because the contraction of its nucleus was more rapid than it is at present, it is commonly inferred that phenomena accompanying bradyseismical activity must have been more pronounced and have shown themselves upon a grander scale than they do at the present time. Now, although the records of our rocks only carry us back over a certain portion of this history, they certainly represent an interval of time sufficiently long to furnish some evidence of such enfeeblement if it ever existed. So far from this being the case, however, we meet with distinct evidences in the later chapters of geological history of plutonic awakenings much more violent than those recorded at its commencement. During Palaeozoic times many mountain ranges were formed, and accompanying these orogenic processes there was marked volcanic activity. In the succeeding Secondary period plutonic forces were quiescent, but during the formation of the early Tertiaries, when some of the largest mountain ranges were created, they awoke with a vigour greater than had ever been previously exhibited. At this period it is not improbable that Scotland was as remarkable for its volcanoes and its earthquakes as Japan is at the present day. If the statement relating to the general decrease in bradyseismical changes referred merely to their frequency, and omitted reference to their magnitude, the views of the geologist and physicist might harmonize. One explanation for this divergence of opinion may rest on the fact that too little attention has been directed to all the conditions which accompany the adaptation of the earth's crust to its shrinking nucleus. As the latter grows smaller the puckerings and foldings of the former should grow larger. Each succeeding geological epoch should be characterized by mountain formations more stupendous than those which preceded them, whilst the fracturing, dislocation, caving-in of ill-supported regions, and creation of lines of freedom for the exhibition of volcanic activity which would accompany these changes, would grow in magnitude. The written records of many countries reflect but on a smaller scale the crystallized records in their hills. In 1844, at Comrie, in Perthshire, as many as twelve earthquakes were recorded in a single month, whilst now there are but one or two per year. Earthquake frequency varies with time. A district under the influence of hypogenic activities reaches a condition of seismic strain which usually is relieved rapidly at first, but subsequently more slowly.

The small shocks which follow an initial large disturbance are known as after-shocks. The first shock which in 1891 devastated central Japan was accompanied by the formation of a large fault, and the 3364 small shocks which succeeded this during the following two years are regarded as due to intermittent settlements of disjointed material. The decreasing frequency with which after-shocks occur may be represented by a curve. Dr F. Omori points out that the continuation of such a curve gives the means of determining the length of time which will probably elapse before the region to which it refers will return to the same seismic quiescence that it had prior to the initial disturbance.

The positive results that we have respecting the periodicity of earthquakes are but few. Generally earthquakes are somewhat more frequent during winter than during summer, and this applies to both the northern and southern hemispheres. The annual periodicity, which, however, does not show itself if only

destructive earthquakes are considered, finds an explanation, according to Dr Knott, in the annual periodicity of long-continued stresses, as for example those due to the accumulation of snow and to barometric gradients. *Periodicity.* For certain earthquake regions there appears to be a distinct semi-annual period for which no satisfactory explanation has yet been adduced. Although the elaborate registers of Japan, which have enabled us to group earthquakes according to their respective origins and varying intensities, and to separate after-shocks from initial disturbances, have been subjected by Dr Knott to most careful analysis, with the object of discovering periodicities connected with the ebb and flow of the tides, the lunar day or lunar months, nothing of marked character has been found. Certainly there is slight evidence of a periodicity connected with the times of conjunction and opposition of the sun and moon, and a maximum frequency near the time of perigee, but the effect of lunar stresses is comparatively insignificant. Ordinary earthquakes, and especially after-shocks, show a diurnal period, but we cannot say that there are more earthquakes during the night than during the day.

Many experiments and investigations have been made to determine a possible relationship between earthquakes and electrical phenomena, but beyond drawing attention to the fact that luminous appearances may accompany the friction of moving masses of rock, and that a temporary current may be established in a line by the disturbance of an earth-plate, these inquiries have yielded but little of importance. The inquiries respecting a possible relationship between adjustments so frequently taking place within and beneath that region called the crust of the earth and magnetic phenomena are, however, of a more promising nature. We have seen that at or near the origin of earthquakes which for several hours disturb continents, and occasionally cause oceans to oscillate for longer periods, we sometimes have direct evidence of the bodily displacement of many cubic miles of material. When this material is volcanic it is almost invariably magnetic, and we perceive in its sudden rearrangement causes which should produce magnetic effects within an epifocal district. In Japan, where attention is being directed to phenomena of this description, not only have such effects been observed, but unusual magnetic disturbances have been noted prior to the occurrence of large earthquakes. These may, of course, be regarded as mere coincidences, but when we consider volcanic and seismic activities as evidences of physical and chemical changes, together with mechanical displacements of a magnetic magma, it is reasonable to suppose that they should have at least a local influence upon magnetic needles. Another form of disturbance to which magnetic needles are subjected is that which accompanies the passage of large earth-waves beneath certain observatories situated at great distances from earthquake origins. At Utrecht, Potsdam and Wilhelmshaven the magnetographs are frequently disturbed by seismic waves, whilst at many other European observatories such effects are absent or only barely appreciable. To explain these marked differences in the behaviour of magnetic needles at different stations we are at present only in a position to formulate hypotheses. They may be due to the fact that different needles have different periodic times of oscillation; it is possible that at one observatory the mechanical movements of the ground are much greater than at others; we may speculate on the existence of materials beneath and around various observatories which are different in their magnetic characters; and, lastly, we may picture a crust of varying thickness, which from time to time is caused to rise and fall upon a magnetic magma, the places nearest to this being the most disturbed.

A subject to which but little attention has been directed is the effect which displays of seismic and volcanic activities have had upon the human mind. The effects are distinctly dual and opposite in character. In countries like *Effects on the human mind.* England, where earthquakes are seldom experienced, the prevailing idea is that they are associated with all that is baneful. For certain earthquakes, which fortunately are less frequent than those which are annually recorded,

partially true. A disastrous shock may unnerve a whole community. Effects of this nature, however, differ in a marked manner with different nationalities. After the shock of 1891, when Japan lost 9960 of its inhabitants, amongst the wounded indications of mental excitement were shown in spinal and other trouble. Notwithstanding the lightheartedness of this particular nation, it is difficult to imagine that the long series of seismic effects chronicled in Japanese history, which culminated in 1896 in the loss of 20,000 lives by sea-waves, has been without some effect upon its mental and moral character. Several earthquakes are annually commemorated by special services at temples. In bygone times governments have recognized earthquakes as visitations of an angry deity, whom they have endeavoured to appease by repealing stringent laws and taxes. In other countries the sermons which have been preached to show that the tremblings of the world were visitations consequent on impiety, and the prayers which have been formulated to ward off disasters in the future, far exceed in number the earthquakes which gave rise to them. In 1755 many of the English clergy held the view that Lisbon was destroyed because its inhabitants were Catholics, whilst the survivors from that disaster attributed their misfortune to the fact that they had tolerated a few Protestant heretics in their midst. To avoid a recurrence of disaster certain of these were baptized by force. In the myths relating to underground monsters and personages that are said to be the cause of earthquakes we see the direct effects which exhibitions of seismic and volcanic activity have produced upon the imagination. The beliefs, or more properly, perhaps, the poetical fancies, thus engendered have exhibited themselves in various forms. Beneath Japan there is said to be a catfish, which in other countries is replaced by a mole, a hog, an elephant or other living creature, which when it is restless shakes the globe. The Kamchadales picture a subterranean deity called Tuil, who in Scandinavian mythology is represented by the evil genius Loki. We have only to think of the reference in the Decalogue forbidding the making of graven images of that which is in the earth beneath, to see in early Biblical history evidence of a subterranean mythology; and it seems probable that the same causes which led to the creation of Pluto, Vulcan and Poseidon gave rise to practices condemned by Moses.

Perhaps the greatest practical benefits derived from seismological investigations relate to important changes and new principles which have been introduced into the arts of the engineer and builder when constructing in earthquake countries. The new rules and formulae, rather than being theoretical deductions from hypotheses, are the outcome of observation and experiment. True measures of earthquake motion have been given to us by modern seismometers, with the result that seismic destructivity can be accurately expressed in mechanical units. From observation we now know the greatest acceleration and maximum velocity of an earth particle likely to be encountered; and these are measures of the destructivity. The engineer is therefore dealing with known forces, and he has to bear in mind that these are chiefly applied in a horizontal direction. A formula connecting the acceleration requisite to overturn bodies of different dimensions has been given. The acceleration which will fracture or shatter a column firmly fixed at its foundation to the moving earth may be expressed as follows:—

$$a = \frac{1}{6} \frac{gFAB}{fw}$$

where

- a = the acceleration per sec. per sec.
- F = the force of cohesion, or force per unit surface, which when gradually applied produces fracture.
- A = area of base fractured.
- B = thickness of the column.
- f = height of centre of gravity of column above the fractured base.
- w = the weight of the portion broken off.

With this formula and its derivatives we are enabled to state the height to which a wall, for example, may be built capable of resisting any assumed acceleration. Experience has shown

that yielding first shows itself at the base of a pier, a wall or a building, and it is therefore clear that the lower portion of such structures should be of greater dimensions or stronger than that above. Piers having these increased dimensions below, and tapering upwards in a proper manner, so that every horizontal section is sufficiently strong to resist the effects of the inertia of its superstructure, are employed to carry railways in Japan. In that country cast-iron piers are things of the past, whilst piers of masonry, together with their foundations, no longer follow the rules of ordinary engineering practice.

After flood, fire, earthquake, or when opportunity presents itself, changes are introduced in the construction of ordinary buildings. In a so-called earthquake-proof house, although externally it is similar to other dwellings, we find rafters running from the ridge pole to the floor sills, an exceedingly light roof, iron straps and sockets replacing mortices and tenons, and many other departures from ordinary rules. Masonry arches for bridges or arched openings in walls (unless protected by lintels), heavy gables, ornamental copings, cappings for chimneys, have by their repeated failure shown that they are undesirable features for construction in earthquake countries. As sites for buildings it is well to avoid soft ground, on which the movement is always greater than on hard ground. Excessive movement also takes place along the face of unsupported openings, and for this reason the edges of scarps, bluffs, cuttings and river-banks are localities to be avoided. In short, the rules and precautions which have to be recognized so as to avoid or mitigate the effects of earthquake movement are so numerous that students of engineering and architecture in Japan receive a special course of lectures on this subject. When it is remembered that a large earthquake may entail a loss of life greater than that which takes place in many wars, and that for the reconstruction of ordinary buildings, factories and public works an expenditure of several million pounds sterling is required, the importance of these studies cannot be overrated. Severe earthquakes are fortunately unknown in the British Isles, but we have simply to turn our eyes to earthquake-shaken colonies and lands in close commercial touch with Great Britain to realize the importance of mitigating such disasters as much as possible, and any endeavour to obviate the wholesale destruction of life should appeal to the civilized communities of the world.

An unexpected application of seismometry has been to record the vibration of railway trains, bridges and steamships. An instrument of suitable construction will give records of the more or less violent jolting and vibratory movements of a train, and so localize irregularities due to changes in the character of ballast and sleepers, to variation in gauge, &c. An instrument placed on a locomotive throws considerable light upon the effects due to the methods of balancing the wheels, and by alterations in this respect a saving of fuel from 1 to 5 lb of coal per mile per locomotive has sometimes been effected.

By mapping the centres from which earthquakes originate off the coast of Japan, we have not only determined districts where geological activity is pronounced, but have placed before the cable engineer well-defined localities which it is advisable to avoid; and in the records of unfelt earthquakes which originate far from land similar information is being collected for the deeper parts of the oceans. Occasionally these records have almost immediately made clear the cause of a cable failure. From lack of such information in 1888, when the cables connecting Australia with the outer world were simultaneously broken, the sudden isolation was regarded as a possible operation of war, and the colonists called out their naval and military reserves. Records of earthquakes originating at great distances have also frequently enabled us to anticipate, to correct, to extend, or to disprove telegraphic accounts of the disasters. Whatever information a seismogram may give is certain, whilst the information gathered from telegrams may in the process of transit become exaggerated or minimized. Otherwise unaccountable disturbances in records from magnetographs, barographs and other instruments employed in observatories are frequently

Building to withstand earthquakes.

Applications of seismometry.

explained by reference to the traces yielded by seismometers. Perhaps the greatest triumph in seismological investigation has been the determination of the varying rates at which motion is propagated through the world. These measurements have already thrown new light upon its effective rigidity, and if we assume that the density of the earth increases uniformly from its surface towards its centre, so that its mean density is 5.5, then, according to Knott, the coefficient of elasticity which governs the transmission of preliminary tremors of an earthquake increases at a rate of nearly 1.2% per mile of descent. (J. M.)

AUTHORITIES.—J. Milne, *Seismology* (London, 1898), *Earthquakes* (London, 1898), Bakerian Lecture, "Recent Advances in Seismology," *Proc. Roy. Soc.*, 1906, 77, p. 365; J. A. Ewing, *Memoir on Earthquake Measurement* (Tokyo, 1883); C. E. Dutton, *Earthquakes in the Light of the New Seismology* (London, 1904); "The Charleston Earthquake of Aug. 31, 1886," Ninth Annual Report of the United States Geological Survey, 1889; W. H. Hobbs, *Earthquakes, an Introduction to Seismic Geology* (London, 1908), "The San Francisco Earthquake and Fire, 1906," *Bull. U.S. Geol. Surv. No. 324*; "The California Earthquake of Ap. 18, 1906," *Rep. State Earthq. Com.* (Washington, D.C., 1908); R. D. Oldham, "Report on the Great Earthquake of 12 June 1897," *Mem. Geol. Surv. India*, xxix, 1899, "On the Propagation of Earthquake Motion to great Distances," *Phil. Trans.*, 1900, A, vol. 194, p. 135; "The Constitution of the Interior of the Earth as revealed by Earthquakes," *Quar. Jour. Geol. Soc.*, 1906, 62, p. 456; 1907, 63, p. 344; C. Davison, *A Study of Recent Earthquakes* (London, 1905); *The Hereford Earthquake of December 17, 1860* (Birmingham, 1869), "The Investigation of Earthquakes," *Beitrag z. Geophysik*, Bd. ix., 1908, p. 201, and papers on British earthquakes in *Quar. Jour. Geol. Soc.*; T. J. J. See, "The Cause of Earthquakes, Mountain Formation and Kindred Phenomena connected with the Physics of the Earth," *Proc. Amer. Phil. Soc.*, 1906, 45, p. 273; F. Frech, "Erdbeben und Gebirgsbau," *Petermann's Mittheilungen*, Bd. 53, 1907, p. 245 (with maps); C. G. Knott, *The Physics of Earthquake Phenomena* (Oxford, 1908); Comte F. de Montessus de Ballore, *Les Tremblements de terre: géographie sismologique* (Paris, 1906), *La Science sismologique* (1907); *Transactions of the Seismological Society of Japan*; *Seismological Journal* (Yokohama); *Bollettino della Società Sismologica Italiana* (Rome); *Reports of the British Association*, containing the annual reports of the Committee for Seismological Investigations; papers in the *Beitrag zur Geophysik* and the *Ergänzungsbände*.

EARTH-STAR (*Gaster*), in botany, a kind of puff-ball, with a distinct outer coat which,



From Strasburger's *Lehrbuch der Botanik*, by permission of Gustav Fischer.
Gaster granulatus, nat. size.

into several divisions, which become reflexed and spread like a star. The inner coat enveloping the spores is supported, like a ball, either with or without a stalk on the upper face of the star. The spores escape generally by means of a distinct aperture which appears in the top of the ball. There are several species in Britain found on the ground or on decaying leaves. They are rare or local, but more common in the south or south-east of England than in other parts of Britain.

EARTHWORM, the common name of a chaetopod worm found nearly all over the world. Linnæus recognized only one species of earthworm and named it *Lumbricus terrestris*. There are now one thousand well-characterized species known from different parts of the world, and the number increases almost daily. The earthworms of England belong entirely to the three genera *Lumbricus*, *Allolobophora* and *Allurus*, which are further subdivided by some systematists; and these genera form the prevalent earthworm fauna of the Palaearctic region and are also very numerous in the Nearctic region. Elsewhere they do not appear to be indigenous, but are replaced by the numerous other genera of the families enumerated in the article Chaetopoda (q.v.). It is a remarkable fact that these genera, comprising a separate family *Lumbricidae*, when introduced into tropical and other countries, thrive abundantly and oust the indigenous forms. In gatherings of earthworms from various extra-European countries it is always found that if the collections have been made in cultivated ground and near the coast the worms are of European species; farther inland the native forms are met with. Inasmuch as in every case the *Lumbricidae* from non-European

countries are identical with European species, since it has been shown that these animals are very readily introduced accidentally with plants, &c., and in view of the fact that they are impatient of sea water, it seems clear that the presence of these *Lumbricidae* in other continents is due to accidental transportation. Most earthworms live in the soil, which they devour as they burrow through it. A few, like their allies the river worms (Limnicolae), habitually frequent streams, lakes, &c. One genus, at any rate, viz. *Pontodrilus*, seeks an unusual environment, and is found in heaps of sea-weed cast up by the sea. The range of this genus is therefore naturally wider than that of other genera which are confined to land masses and cannot cross the sea by their own efforts. It might be inferred, therefore, and the inference is proved by facts, that truly oceanic islands have no indigenous fauna of earthworms, but are inhabited by forms which are identical with those of neighbouring continents, and doubtless, therefore, accidentally introduced.

Like the leeches the earthworms produce cocoons which are a product of the glandular epithelium of the clitellum. In these cocoons are deposited the eggs together with a certain amount of albumen upon which the developing embryos feed. So far as is known, the production of cocoons is universal among earthworms and the remaining Oligochaeta of aquatic habit. The young leave the cocoon as fully formed earthworms in which, however, the genitalia are not fully developed. There is no free living larval stage. Out of a single cocoon emerge a varying number of young worms, the numbers being apparently characteristic of the species. The work of earthworms in aiding in the production of the subsoil and in levelling the surface was first studied by C. Darwin, and has since been investigated by others. This work is partly carried out beneath the surface and partly on the surface, upon which the worms wander at night and eject the swallowed and triturated earth; frequently castings of some height are formed of coiled ropes of agglutinated particles of mould. The indigenous species of Great Britain, about twenty in number, do not grow to a greater length than some 10 in.; but in several tropical countries there are species which grow to a length of from 3 to 6 ft. Thus we have in Natal the gigantic *Microchaeta rappi*, in Ceylon *Megascolex coerulescens*, in Australia *Megascolex australis*, and an equally large form in South America. (F. E. B.)

EARWIG, an insect belonging to the *Forficulidae*, a family usually referred to the Orthoptera, but sometimes regarded as typifying a special order, to which the names Dermaptera, Dermaptera and Euplexoptera have been given, in allusion to certain peculiarities in the structure of the wings in the species that possess them. The front wings are short and horny and when at rest meet without overlapping in the middle line, like the wing-cases of brachelytrous (cocktail) beetles. The hind wings, on the contrary, are for the most part membranous and, when extended, of large size; each consists of two portions, the distal of which, in virtue of the arrangement and jointing of its nervures, is capable of being both doubled up and folded fanwise beneath the proximal, which is partly horny when the wing is tucked away under the front wing-case of the same side. Apart from these characteristics, the most distinctive feature of earwigs is the presence at the end of the abdomen of a pair of pincers which are in reality modified appendages, known as cercopods, and represent the similar limbs of *Japyx* and the caudal feelers of *Campodea* and some other insects.

The *Forficulidae* are almost cosmopolitan; but the various species and genera differ from each other both in structure and size to a comparatively slight extent. The length and armature of the pincers and the presence or absence of wings are perhaps the most important features used by systematists in distinguishing the various kinds. Of particular zoological interest in this connexion is a Ceylonese genus *Dyscritina*, in which the cercopods are long, many-jointed and filiform during the early stages of growth, and only assume at the last moult the forcipate structure characteristic of the family. The best known earwig is the common European species, *Forficula auricularia*. This is gregarious and nocturnal. It hides by day under

the loosened bark of trees or in any crevice or hole sheltered from the light. At night it crawls about in search of food, which consists to a small extent of dead animal or vegetable matter, but principally, as gardeners are aware, of the petals and other parts of flowers of growing shoots and soft ripe fruit. During the winter earwigs lie dormant; but in the early months of the year females with their eggs may be found in the soil, frequently in deserted earthworm burrows. Maternal instincts are well developed, both the eggs, which number about fifty, and the young being carefully brooded and watched over by the parent. Except for the absence of wings, the young are miniature models of the adult. As growth proceeds the integument is periodically cast; and at the final moult the perfect winged insect appears. Males and females are like each other in size, but may be distinguished by the difference in the number of visible abdominal segments, the male having nine and the female seven. In the male, moreover, the pincers are caliper-like and toothed at the base, whereas in the female they are untoothed and only lightly curved at the tip. These differences suggest that the pincers aid in the pairing of the sexes. However that may be, they are known to be used in the folding of the wings; and their importance as weapons of defence is attested by the precision and effect with which they are wielded against assailants like ants.

(R. I. P.)

EASEMENT (Fr. *aïse*; O. Fr. *aisement*; Anglo-Lat. *aisiamentum*, a privilege or convenience), in English law, a species of "servitude" or limited right of use over land belonging to another. It is distinguished from *profits à prendre*—another species of servitude which involves a right to participate in the profits of the soil of another—since an easement confers merely a convenience (*aisiamentum*) to be exercised over the land of another (without any participation in the profits of it), *i.e.* a right to use the soil or produce of the soil in a way tending to the more convenient enjoyment of another piece of land. Thus a right of way is an easement, a right of common is a profit. An easement is distinguishable also from a licence, which, unless it is coupled with a grant, is personal to both grantor and grantee and is neither binding on the licensor, nor, in general, assignable by the licensee; while both the benefit and the burden of an easement are annexed to land (Gale on *Easements*, 8th ed. p. 2). With easements are sometimes classed certain closely allied "natural rights," such as a landowner's right to lateral support for his soil in its natural state, and a riparian owner's right to the natural flow of a stream.

The essential features of an easement, in the strict sense of the term, are therefore these: (i.) It is an incorporeal right; a right to the use and enjoyment of land—not to the land itself; (ii.) it is imposed upon corporeal property; (iii.) it is a right without profit; (iv.) it requires for its constitution two distinct tenements—the "dominant tenement" which enjoys the right, and the "servient tenement" which submits to it. This last characteristic excludes from the category of easements the so-called "easements *in gross*," such as a right of way conferred by grant independently of the possession of any tenement by the grantee. The true easement is an "appendant" or "appurtenant" right, not a "right *in gross*."

Further classifications of easements must be noted. They are divided into (a) *affirmative* or *positive*, those which authorize the commission of an act by the dominant owner, *e.g.* rights of way, a right to draw water from a spring, rights of aqueduct, and *negative*, when the easement restricts the rights of the servient owner over his own property, *e.g.* prevents him from building on land so as to obstruct ancient lights (cf. also the right to the support of neighbouring soil); (b) *continuous*, of which the enjoyment may be continual without the interference of man, *e.g.* access to light, and *discontinuous*, where there must be a fresh act on each occasion of the exercise of the right, *e.g.* a right of way, or right to draw water; (c) *apparent*, where there are visible external signs of the exercise of the right, *e.g.* a right to dam up a watercourse, and *non-apparent*, where such signs are absent, *e.g.* a right to lateral support from land, a prohibition to build above a certain height.

Acquisition of Easements.—Easements may be acquired (a) by express grant, either by statute, or by deed *inter vivos*, or by will; (b) by an implied grant; (c) by express or implied reservation, *e.g.* by the owner of land in selling the fee (as to implied reservation, see Gale on *Easements*, 8th ed. pp. 137 et seq.); (d) by prescription, either at common law or under the Prescription Act 1832. An express grant, or express reservation, of an easement cannot be effected except by deed. An easement arises by implied grant where a man makes one part of his tenement dependent on another, or makes the parts mutually interdependent, and grants any such part with the dependence attaching to it to another person (Innes, *Law of Easements*, 7th ed. p. 10). For example, a man builds two houses, each of which by the plan of construction receives support from the other; this mutual right of support is a *quasi*-easement, of which on severance of the tenements the grantee of one will have the benefit; where the enjoyment of the severed tenement could not be had at all without such a right, it is said to be an "easement of necessity."

Easements are acquired by prescription at common law by proof of "immemorial user" by the dominant owner and those through whom he claims. At one time it was thought that such proof must date back to the first year (1189) of Richard I. (see preamble to Prescription Act 1832). The ground, however, on which prescription was admitted as a means of acquiring easements was the fiction of a "lost grant." Long enjoyment of the right pointed to its having had a legal origin in a grant from the servient owner, and so any period of reasonably long use came to be accepted. A "lost grant" may be presumed to have been made (the question is one of fact) if 20 years' uninterrupted enjoyment is shown. To avoid the difficulties of proof of prescriptive right at common law, the Prescription Act 1832 established shorter periods of user. In the case of easements, other than light, the periods of prescription are 20 years for a claim that may be defeated, and 40 years for an indefeasible claim (s. 2). The right of access of light is dealt with under s. 3 (see ANCIENT LIGHTS). The enjoyment to become prescriptive must be open, *i.e.* of such a character that the owner of the tenement said to be servient has a reasonable opportunity of becoming aware of the adverse claim (*Union Lighterage Co. v. London Graving Dock Co.*, 1902, 2 Ch. 557); and it must be enjoyed as of right (*Gardner v. Hodgson's Kingston Brewery Co.*, 1903, A.C. 229) as against the owner of the tenement affected (*Kilgour v. Gaddes*, 1904, 1 K.B. 457). The periods of prescription are to be reckoned backwards from the time when some suit or matter involving the claim of the dominant owner has arisen (s. 4). Nothing is to be deemed an interruption unless the act of interruption has been submitted to, or acquiesced in, for a year (s. 4).

Easements may be extinguished (i.) by express release—here an instrument under seal is necessary; (ii.) by "merger," *i.e.* where both tenements become the property of the same owner; (iii.) by abandonment through non-user. In the case of discontinuous easements, the shortest period of non-user may suffice if there is direct evidence of an intention to abandon.

A word may be added here as to the right to air. It is an actionable nuisance to cause pollution of the air entering a dwelling-house. The owner of a dwelling-house may by prescription acquire a right to the passage of air through it by a defined channel; and the enjoyment without interruption of ventilation by means of air flowing in a definite channel, with the knowledge of the owner and occupier of the adjoining premises, creates a presumption of the grant of such an easement (see Gale on *Easements*, 8th ed. p. 338).

In *Scots Law* the term "easement" is unknown. Both the name "servitude" and the main species of servitudes existing in Roman law (*servitus*) have been adopted. The classification of servitudes into positive and negative, &c., and the modes of their creation and extinction, are similar to those of English law. The statutory period of prescription is 40 years (*Scots Acts* 1617, c. 12), or 20 years in the case of enjoyment under any *ex facie* valid irredeemable title duly recorded in the appropriate register of sasines (*Conveyancing [Scotland] Act* 1874). There are

certain servitudes special to Scots law, e.g. "thirlage," by which lands are "thirled" or bound to a particular mill, and the possessors obliged to grind their grain there, for payment of certain *milltines* (quantities of grain or meal, payable to the mill-owner) and *sequeis* (small quantities given to the mill servants) as the customary price of grinding. Statutory provision has been made for the commutation of these duties (Thirlage Act 1799), and they have now almost disappeared.

The French Code Civil (Arts. 637 et seq.) and the other European codes (e.g. Belgium, arts. 637 et seq.; Holland, arts. 721 et seq.; Italy, arts. 531 et seq.; Spain, arts. 530 et seq.; Germany, arts. 1018 et seq.) closely follow Roman law. French law is in force in Mauritius, and has been followed in Quebec (Civil Code, arts. 499 et seq.) and St Lucia (Civil Code, arts. 449 et seq.). In India the law is regulated, on English lines, by the Easements Act 1882 (Act v. of 1882). The term "easements," however, in India includes *profits à prendre*. In the South African colonies the law of easements is based on the Roman Dutch law (see Maasdorp, *Institutes of Cape Law*, 1904; Bk. ii. p. 166 et seq.). In most of the other colonies the law of easements is similar to English law. In some, however, it has been provided by statute that rights to the access and use of light or water cannot be acquired by prescription: e.g. Victoria (Water Act 1890, No. 1156, s. 3), Ontario (Real Property Limitation Act, Revised Stats. Ontario, 1897; c. 133, s. 36, light).

In the United States the law of easements is founded upon, and substantially identical with, English law. The English doctrine, however, as to acquisition of right of light and air by prescription is not accepted in most of the States.

AUTHORITIES.—*English Law:* Gale, *Law of Easements* (8th ed., London, 1908); Goddard, *Law of Easements* (6th ed., London, 1904); Innes, *Digest of the Law of Easements* (7th ed., London, 1903). *Indian Law:* Peacock, *Easements in British India* (Calcutta, 1904); Hudson and Inman, *Law of Light and Air* (2nd ed., London, 1905). *Scots Law:* Erskine, *Principles of the Law of Scotland* (20th ed., Edinburgh, 1903). *American Law:* Jones, *Law of Easements* (New York, 1898); Bouvier, *Law Dict.* (Boston and London, 1897); *Ruling Cases*, London and Boston, 1894-1901, tit. *Easement* (A. W. R.).

EAST, ALFRED (1849—), English painter and etcher, was born at Kettering on the 15th of December 1849. One of the most prominent among modern English landscape painters, he received his art education first at the Glasgow School of Art and then in Paris at the École des Beaux-Arts, and under Robert-Fleury and Bouguereau. His landscapes are remarkable for the lyrical use of colour and for the pleasing rhythm of line which is the result of careful selection and building up of the elements that constitute the scene. Based on keen observation of the colour of nature and on careful studies of the details, they are arranged with a rare and by no means obvious sense of balance and compositional beauty which summarily discards all disturbing accidents of nature. He also achieved distinction as an etcher, and published an instructive and useful volume on landscape painting (London, 1906). He began to exhibit at the Royal Academy in 1882, and was elected an associate. In 1906 he became president of the Royal Society of British Artists. Many of his works are to be found in the English provincial galleries; Manchester owns "The Silent Somme" and "Autumn"; Liverpool, "Gibraltar from Algeiras"; Leeds, "The Golden Valley"; Birmingham, "Hayle from Lelant"; Preston, "An Idyll of Spring"; and Hull, "Evening on the Cotswolds." His "Passing Storm" is at the Luxembourg; "The Nene Valley" at the Venice gallery; and "A Haunt of Ancient Peace" at the National gallery in Budapest. In 1903 he received the order of the Crown of Italy in connexion with his services to the Venice International exhibition; and he was made an honorary member of the Japanese Meiji Bijutsu Kai.

EAST ANGLIA, one of the kingdoms into which Anglo-Saxon Britain was divided. Bede gives no information about its origin except that its earliest settlers were Angles. The kingdom of East Anglia comprised the two counties of Norfolk and Suffolk. With regard to the western boundary we have no accurate information, but it was probably formed by the fens of Cambridgeshire.

This kingdom first appears in Bede's narrative early in the 7th century, when its power was at its height. Towards the end of the reign of Æthelberht, who died about 616, Rædwald of East Anglia, who had apparently spent some time at the court of Kent, began to win for himself the chief position among the Anglo-Saxon kings of his day. His position was assured, at least temporarily, in 617, when he decided to espouse the cause of the Northumbrian prince Edwin, then a fugitive at his court, and defeated Æthelfrith of Northumbria on the banks of the Idle, a tributary of the Trent, in Mercian territory. Rædwald had been converted to Christianity in Kent, but after his return home he relapsed, according to Bede, owing to the influence of his wife, and there were to be seen in the same building a Christian and a pagan altar. Bede states that Rædwald was the son of Tytili, the son of Wuffa, from whom the East Anglian royal family derived their name Wuffingas. According to the *Historia Brittonum* Guffa (Wuffa) was the son of (Guecha) Wehha, who first ruled the East Angles in Britain. This would put the organization of the kingdom in the first or second quarter of the 6th century. Eorpwald, the son of Rædwald, was converted to Christianity by Edwin, but was soon afterwards slain by Richebht (627 or 628), whereupon the kingdom again became pagan for three years, when Sigeberht, the brother of Eorpwald, became king and founded a see for Felix at Dunwich. Sigeberht also founded a school in East Anglia, and on the arrival of an Irish missionary named Furseus he built him a monastery at *Cnobheresburg*, perhaps to be identified with Burgh Castle. Before 644, however, Sigeberht resigned the crown in favour of his brother Egric and retired to a monastery. Shortly afterwards both brothers were slain by Penda of Mercia in his invasion of East Anglia, and Anna became king. This king was an enthusiastic Christian, and converted Cornwall, king of Wessex, who had fled to his court. Two of his daughters, Sæthryth and Æthelberg, took the veil; while another, Sexburg, was married to Earconberht, king of Kent; and a fourth, Æthelthryth, after two marriages, with Tondberht of the South Gyrwe and Ecgrifht of Northumbria, became abbess of Ely. In 654 Anna was slain by Penda of Mercia, and was succeeded by his brother Æthelhere, who was killed in 655 at the Winwæd, fighting for the Mercian king against Oswio of Northumbria. In 673 Archbishop Theodore divided the East Anglian diocese into two, Elmham being the seat of the northern, Dunwich that of the southern bishop. A long blank follows in the history of this kingdom, until in 792 we find Offa of Mercia slaying Æthelberht, king of East Anglia, who is said to have been his son-in-law. East Anglia was subject to the supremacy of the Mercian kings until 825, when its people slew Beornwulf of Mercia, and with their king acknowledged Egcebrht (Egbert) of Wessex as their lord. In 870 Edmund, king of East Anglia, was killed by the Danes under I'varr and Ubbi, the sons of Ragnar Loðbrok.

The following is a list of the kings of East Anglia of whom there is record:—Wehha; Wuffa; Rædwald, son of Tytili and grandson of Wuffa (reigning 617); Eorpwald, son of Rædwald (d. 627 or 628); Sigeberht, brother of Eorpwald; Egric, brother of Sigeberht (both slain before 644); Anna, son of Ene and grandson of Tytili (d. 654); Æthelhere, brother of Anna (d. 655); Æthelwald, a third brother; Aldwulf (succ. 663, d. 713), son of Æthelric and grandson of Ene; Elfwald, son of Aldwulf (d. 740); Hun Beonna and Alberht; Æthelberht (792); Edmund (870).

After the death of Ragnar Loðbrok's sons East Anglia was occupied by the Danish king Guthrum, who made a treaty with Alfred settling their respective boundaries, probably about 880. Guthrum died in 890. A later king named Eohric took up the cause of Æthelwald, the son of Æthelred I., and was slain in the fight with the Kentish army at the Holm in 905. A war broke out with King Edward the Elder in 913; in 921 a king whose name is unknown was killed at the fall of Tempsford, and in the same year the Danes of East Anglia submitted to Edward the Elder. From this time, probably, East Anglia was governed by English earls, the most famous of whom were Æthelstan, surnamed Half-King (932-956) and his sons,

Æthelwold (956-962), and Æthelwine, surnamed *Dei amicus* (962-992).

See Bede, *Hist. Eccl.* (ed. C. Plummer, Oxford, 1896), ii. 5, 15, iii. 7, 8, 18-20, 22, iv. 3, 5, 23; *Saxon Chronicle* (ed. Earle and Plummer, Oxford, 1899), s. a. 823, 838, 866, 870, 880, 885, 890, 894, 905, 921; *Historia Brittonum* (San-Marie, 1844), s. 59; H. Sweet, *Oldest English Texts*, p. 171 (London, 1885). (F. G. M. B.)

EASTBOURNE, a municipal borough (1883) in the Eastbourne parliamentary division of Sussex, England, 61 m. S.S.E. of London by the London, Brighton & South Coast railway. Pop. (1891) 34,966; (1901) 43,344; (local census, 1909) 49,286. It is situated 3 m. N.E. of Beachy Head, the loftiest headland on the English Channel coast. It once consisted of three parts—the village of East Bourne, a mile inland; South Bourne, lying back from the shore; and Seahouses, facing the beach. The church of St Mary, the ancient parish church of East Bourne, is a fine transitional Norman building; and there are numerous modern churches and chapels. The principal buildings and institutions are the town hall and municipal buildings, the Princess Alice Memorial and other hospitals, a free library and, among many high-class schools, Eastbourne College for boys, founded in 1867. There is a fine pier with pavilion, and a marine parade nearly 3 m. in extent, arranged in terraced promenades. Devonshire Park of 13 acres is pleasantly laid out, and contains a pavilion and a theatre. The duke of Devonshire is the principal landowner. Golf links are laid out on the neighbouring downs. A Roman villa was formerly seen close to the shore, but it is not now visible. The corporation consists of a mayor, 8 aldermen and 24 councillors. In 1910 the corporation promoted a bill in parliament to add the Hampden Park district in the parish of Willingdon to the borough and to make Eastbourne, with this extension, a county borough.

EAST CHICAGO, a city of Lake county, Indiana, U.S.A., on Lake Michigan, about 10 m. S.E. of the business centre of Chicago. Pop. (1890) 1255; (1900) 3411 (1331 foreign-born); (1910) 19,098. It is served by several railways, including the Pennsylvania, the Wabash, the Chicago Terminal Transfer (whose shops are here), the Lake Shore & Michigan Southern, the Chicago, Indiana & Southern, and the Indiana Harbor railways. East Chicago covers an area whose greatest dimensions are 4 by $3\frac{1}{2}$ m. That part of the city along the lake, known as Indiana Harbor, dates from 1901 and has grown very rapidly because of its position at the southernmost part of the Calumet District, and because of the meeting here of railway and lake commerce. A good harbour has been constructed, a new ship canal connecting the harbour with the Calumet river. East Chicago is industrially virtually a part of "Greater" Chicago; among its manufactures are iron and steel, cement, lumber, boilers, hay presses, chains, chemicals and foundry products. East Chicago was chartered as a city in 1893.

EASTER, the annual festival observed throughout Christendom in commemoration of the resurrection of Jesus Christ. The name Easter (Ger. *Ostern*), like the names of the days of the week, is a survival from the old Teutonic mythology. According to Bede (*De Temp. Ral.* c. xv.) it is derived from *Eostre*, or *Ostira*, the Anglo-Saxon goddess of spring, to whom the month answering to our April, and called *Eostur-monath*, was dedicated. This month, Bede says, was the same as the *mensis paschalis*, "when the old festival was observed with the gladness of a new solemnity."

The name of the festival in other languages (as Fr. *paques*; Ital. *pasqua*; Span. *pascoa*; Dan. *paaske*; Dutch *paasch*; Welsh *pasg*) is derived from the Lat. *pascha* and the Gr. *πάσχα*. These in turn come from the Chaldee or Aramaean form *pascha*, of the Hebrew name of the Passover festival *פסח* *pasach*, from *פסח* "he passed over," in memory of the great deliverance, when the destroying angel "passed over the houses, of the children of Israel in Egypt when he smote the Egyptians" (Exod. xii. 27).

An erroneous derivation of the word *pascha* from the Greek *πάσχειν*, "to suffer," thus connected with the sufferings or passion of the Lord, is given by some of the Fathers of the Church, as Irenæus, Tertullian and others, who were ignorant of Hebrew.

St Augustine (*In Joann. Tract.* 55) notices this false etymology, shows how similarity of sound had led to it, and gives the correct derivation.

There is no indication of the observance of the Easter festival in the New Testament, or in the writings of the apostolic Fathers. The sanctity of special times was an idea absent from the minds of the first Christians. "The whole of time is a festival unto Christians because of the excellency of the good things which have been given" is the comment of St Chrysostom on 1 Cor. v. 7, which has been erroneously supposed to refer to an apostolic observance of Easter. The ecclesiastical historian Socrates (*Hist. Eccl.* v. 22) states, with perfect truth, that neither the Lord nor his apostles enjoined the keeping of this or any other festival. He says: "The apostles had no thought of appointing festival days, but of promoting a life of blamelessness and piety"; and he attributes the observance of Easter by the church to the perpetuation of an old usage, "just as many other customs have been established."

This is doubtless the true statement of the case. The first Christians continued to observe the Jewish festivals, though in a new spirit, as commemorations of events which those festivals had foreshadowed. Thus the Passover, with a new conception added to it of Christ as the true Paschal Lamb and the first fruits from the dead, continued to be observed, and became the Christian Easter.

Although the observance of Easter was at a very early period the practice of the Christian church, a serious difference as to the day for its observance soon arose between the Christians of Jewish and those of Gentile descent, which led to a long and bitter controversy. The point at issue was when the Paschal fast was to be reckoned as ending. With the Jewish Christians, whose leading thought was the death of Christ as the Paschal Lamb, the fast ended at the same time as that of the Jews, on the fourteenth day of the moon at evening, and the Easter festival immediately followed, without regard to the day of the week. The Gentile Christians, on the other hand, unfettered by Jewish traditions, identified the first day of the week with the Resurrection, and kept the preceding Friday as the commemoration of the crucifixion, irrespective of the day of the month. With the one the observance of the day of the month, with the other the observance of the day of the week, was the guiding principle.

Generally speaking, the Western churches kept Easter on the first day of the week, while the Eastern churches followed the Jewish rule, and kept Easter on the fourteenth day. St Polycarp, the disciple of St John the Evangelist and bishop of Smyrna, visited Rome in 159 to confer with Anicetus, the bishop of that see, on the subject; and urged the tradition, which he had received from the apostle, of observing the fourteenth day. Anicetus, however, declined to admit the Jewish custom in the churches under his jurisdiction, but readily communicated with Polycarp and those who followed it. About forty years later (197) the question was discussed in a very different spirit between Victor, bishop of Rome, and Polycrates, metropolitan of proconsular Asia. That province was the only portion of Christendom which still adhered to the Jewish usage, and Victor demanded that all should adopt the usage prevailing at Rome. This Polycrates firmly refused to agree to, and urged many weighty reasons to the contrary, whereupon Victor proceeded to excommunicate Polycrates and the Christians who continued the Eastern usage. He was, however, restrained from actually proceeding to enforce the decree of excommunication, owing to the remonstrance of Irenæus and the bishops of Gaul. Peace was thus maintained, and the Asiatic churches retained their usage unmolested (Euseb. *H.E.* v. 23-25). We find the Jewish usage from time to time reasserting itself after this, but it never prevailed to any large extent.

A final settlement of the dispute was one among the other reasons which led Constantine to summon the council of Nicea in 325. At that time the Syrians and Antiochenes were the solitary champions of the observance of the fourteenth day. The decision of the council was unanimous that Easter was to be kept on Sunday, and on the same Sunday throughout the world,

and "that none should hereafter follow the blindness of the Jews" (Socrates, *H.E.* i. 9). The correct date of the Easter festival was to be calculated at Alexandria, the home of astronomical science, and the bishop of that see was to announce it yearly to the churches under his jurisdiction, and also to the occupant of the Roman see, by whom it was to be communicated to the Western churches. The few who afterwards separated themselves from the unity of the church and continued to keep the fourteenth day, were named *Quartodecimani*, and the dispute itself is known as the *Quarto-deciman* controversy. Although measures had thus been taken to secure uniformity of observance, and to put an end to a controversy which had endangered Christian unity, a new difficulty had to be encountered owing to the absence of any authoritative rule by which the paschal moon was to be ascertained. The subject is a very difficult and complex one (see also CALENDAR). Briefly, it may be explained here that Easter day is the first Sunday after the full moon following the vernal equinox. This, of course, varies in different longitudes, while a further difficulty occurred in the attempt to fix the correct time of Easter by means of cycles of years, when the changes of the sun and moon more or less exactly repeat themselves. At first an eight years' cycle was adopted, but it was found to be faulty, then the Jewish cycle of 84 years was used, and remained in force at Rome till the year 457, when a more accurate calculation of a cycle of 532 years, invented by Victorius of Aquitaine, took its place. Ultimately a cycle of 19 years was accepted, and it is the use of this cycle which makes the Golden Number and Sunday Letter, explained in the preface to the Book of Common Prayer, necessary. Owing to this lack of decision as to the accurate finding of Easter, St Augustine tells us (*Epist.* 23) that in the year 387 the churches of Gaul kept Easter on the 21st of March, those of Italy on the 18th of April, and those of Egypt on the 25th of April; and it appears from a letter of Leo the Great (*Epist.* 64, *ad Marcian.*) that in 455 there was a difference of eight days between the Roman and the Alexandrine Easter. Gregory of Tours relates that in 577 "there was a doubt about Easter. In Gaul we with many other cities kept Easter on the fourteenth calends of May, others, as the Spaniards, on the twelfth calends of April."

The ancient British and Celtic churches followed the cycle of 84 years which they had originally received from Rome, and their stubborn refusal to abandon it caused much bitter controversy in the 8th century between their representatives and St Augustine of Canterbury and the Latin missionaries. These latter unfairly attempted to fix the stigma of the Quartodeciman observance on the British and Celtic churches, and they are even now sometimes ignorantly spoken of as having followed the Asiatic practice as to Easter. This, however, is quite erroneous. The British and Celtic churches always kept Easter according to the Nicene decree on a Sunday. The difference between them and the Roman Church, at this period, was that they still followed the 84 years' cycle in computing Easter, which had been abandoned at Rome for the more accurate cycle of 532 years. This difference of calculation led to Easter being observed on different Sundays, in certain years, in England, by the adherents of the two churches. Thus Bede records that in a certain year (which must have been 645, 647, 648 or 651) Queen Eansleda, who had received her instruction from a Kentish priest of the Roman obedience, was fasting and keeping Palm Sunday, while her husband, Oswy, king of Northumbria, following the rule of the British church, was celebrating the Easter festival. This diversity of usage was ended, so far as the kingdom of Northumbria was concerned, by the council of Streaneshalch, or Whitby, in 654. To Archbishop Theodore is usually ascribed the credit of ending the difference in the rest of England in 669.

The Gregorian correction of the calendar in 1582 has once more led to different days being observed. So far as Western Christendom is concerned the corrected calendar is now universally accepted, and Easter is kept on the same day, but it was not until 1752 that the Gregorian reformation of the calendar was adopted in Great Britain and Ireland. Jealousy of everything emanating from Rome still keeps the Eastern churches from correcting the

calendar according to the Gregorian reformation, and thus their Easter usually falls before, or after, that of the Western churches, and only very rarely, as was the case in 1865, do the two coincide.

Easter, as commemorating the central fact of the Christian religion, has always been regarded as the chief festival of the Christian year, and according to a regulation of Constantine it was to be the first day of the year. This reckoning of the year as beginning at Easter lingered in France till 1565, when, by an ordinance of Charles IX., the 1st of January finally took its place.

Four different periods may be mentioned as connected with the observance of Easter, viz. (1) the preparatory fast of the forty days of Lent; (2) the fifteen days, beginning with the Sunday before and ending with the Sunday after Easter, during which the ceremonies of Holy Week and the services of the Octave of Easter were observed; this period, called by the French the *Quintaine de Pâques*, was specially observed in that country; (3) the Octave of Easter, during which the newly-baptized wore their white garments, which they laid aside on the Sunday after Easter, known as *Dominica in albis depositis* from this custom; another name for this Sunday was *Pascha clausum*, or the close of Easter, and from a clipping of the word "close" the English name of "Low" Sunday is believed to be derived; (4) Eastertide proper, or the paschal season beginning at Easter and lasting till Whit Sunday, during the whole of which time the festival character of the Easter season was maintained in the services of the church.

Many ecclesiastical ceremonies, growing up from early times, clustered round the celebration of the Easter festival. One of the most notable of these was the use of the paschal candle. This was a candle of very large dimensions, set in a candlestick big enough to hold it, which was usually placed on the north side, just below the first ascent to the high altar. It was kept alight during each service till Whitsuntide. The Paschal, as it was called at Durham cathedral, was one of the chief sights of that church before the Reformation. It was an elaborate construction of polished brass, and, contrary to the usual custom, seems to have been placed in the centre of the altar-step, long branches stretching out towards the four cardinal points, bearing smaller candles. The central stem of the candlestick was about 38 ft. high, and bore the paschal candle proper, and together they reached a combined height of about 70 ft., the candle being lighted from an opening above. Other paschal candles seem to have been of scarcely less size. At Lincoln, *c.* 1300, the candle was to weigh three stones of wax; at Salisbury in 1517 it was to be 36 ft. long; and at Westminster in 1558 it weighed no less than 3 cwt. of wax. After Whitsuntide what remained was made into smaller candles for the funerals of the poor. In the ancient churches at Rome the paschal candlesticks were fixtures, but elsewhere they were usually movable, and were brought into the church and set up on the Thursday before Easter. At Winchester the paschal candlestick was of silver, and was the gift of Canute. Others of more or less importance are recorded as having been at Canterbury, Bury St Edmunds, Hereford and York. The burning of the paschal candle still forms part of the Easter ceremonial of the Roman Catholic Church (see LIGHTS, CEREMONIAL).

The liturgical colour for Easter was everywhere white, as the sign of joy, light and purity, and the churches and altars were adorned with the best ornaments that each possessed. Flowers and shrubs no doubt in early times were also used for this purpose, but what evidence there is goes against the medieval use of such decorations, which are so popular at the present day.

It is not the purpose of this article to enter on the wide subject of the popular observances, such as the giving and sending of Pasch or Easter eggs as presents. For such the reader may consult Brand's *Popular Antiquities*, Hone's *Every-Day Book*, and Chambers's *Book of Days*.

AUTHORITIES.—Bingham, *Antiquities of the Christian Church*; Bede, *Ecclesiastical History of England*; Procter and Frere, *A New History of the Book of Common Prayer* (London, 1901); Surtees Society, *Rites of Durham*, ed. J. T. Fowler (1903); De Morgan, *Companion to the Almanac* (1845); De Moleon, *Voyages liturgiques* (Paris, 1718). (T. M. F.)

EASTER ISLAND (Rapanui, *i.e.* Great Rapa), an island in the eastern part of the South Pacific ocean, belonging to Chile (since 1888), in $27^{\circ} 8' S.$ and $109^{\circ} 28' W.$, 1400 m. E. of Pitcairn, and 2000 m. from the South American coast. It is roughly triangular in shape, with its hypotenuse 12 m. long running north-east and south-west, and its three angles marked by three volcanic peaks, of which the north-eastern reaches 1768 ft. of altitude. The area of the island is 45 sq. m. The coast has no good natural harbour, and landing is difficult. There is no lack of fertile soil, and the climate is moist enough to make up for the absence of running water. Formerly the island appears to have been wooded, but it now presents only a few bushes (*Edwardsia*, *Broussonetia*, &c.), ferns, grasses, sedges, &c. The natives grow bananas in the shelter of artificial pits, also sugar-canes and sweet potatoes, and keep a few goats and a large stock of domestic fowls, and a Tahitian commercial house breeds cattle and sheep on the island.

It is doubtful whether Rapanui was discovered by Davis in 1686, though it is sometimes marked Davis Island on maps. Admiral Roggeveen reached it on Easter day 1722; in 1774 Captain Cook discovered it anew and called it Teapi or Waihu. It was subsequently visited by La Pérouse (1776), Kotzebue (1816), &c. At the time of Roggeveen's discovery the island probably contained from 2000 to 3000 inhabitants of Polynesian race, who, according to their own tradition, came from Rapa Iiti (Little Rapa) or Oparo, one of the Tubuai or Austral group. In 1863 a large proportion of the inhabitants were kidnapped by the Peruvians and transported to work at the guano diggings on the Chinchu Islands. The next year a Jesuit mission from Tahiti reached the island and succeeded in the task of civilization. The natives, who number scarcely one hundred, are all Christians.

Easter Island is famous for its wonderful archaeological remains. Here are found immense platforms built of large cut stones fitted together without cement. They are generally built upon headlands, and on the slope towards the sea. The walls on the seaside are, in some of the platforms, nearly 30 ft. high and from 200 to 300 ft. long, by about 30 ft. wide. Some of the squared stones are as much as 6 ft. long. On the land side of the platforms there is a broad terrace with large stone pedestals upon which once stood colossal stone images carved somewhat into the shape of the human trunk. On some of the platforms there are upwards of a dozen images, now thrown from their pedestals and lying in all directions. Their usual height is from 14 to 16 ft., but the largest are 37 ft., while some are only about 4 ft. They are formed from a grey trachytic lava found at the east end of the island. The top of the heads of the images is cut flat to receive round crowns made of a reddish vesicular tuff found at a crater about 8 m. distant from the quarry where the images were cut. A number of these crowns still lie at the crater apparently ready for removal, some of the largest being over 10 ft. in diameter. In the atlas illustrating the voyage of La Pérouse a plan of the island is given, with the position of several of the platforms. Two of the images are also represented in a plate. One statue, 8 ft. in height and weighing 4 tons, was brought to England, and is now in the British Museum. In one part of the island are the remains of stone houses nearly 100 ft. long by about 20 ft. wide. These are built in courses of large flat stones fitted together without cement, the walls being about 5 ft. thick and over 5 ft. high. They are lined on the inside with upright slabs, on which are painted geometrical figures and representations of animals. The roofs are formed by placing slabs so that each course overlaps the lower one until the opening becomes about 5 ft. wide, when it is covered with flat slabs reaching from one side to the other. The lava rocks near the houses are carved into the resemblance of various animals and human faces, forming, probably, a kind of picture writing. Wooden tablets covered with various signs and figures have also been found. The only ancient implement discovered on the island is a kind of stone chisel, but it seems impossible that such large and numerous works could have been executed with such a tool. The present inhabitants of Easter Island know nothing of the construction of these remarkable works; and the entire

subject of their existence in this small and remote island is a mystery.

EASTERN BENGAL AND ASSAM, a province of British India, which was constituted out of Assam and the eastern portion of Bengal on the 16th of October 1905. Area 111,569 sq. m.; pop. (1901) 30,961,459. It is situated between $20^{\circ} 45'$ and $28^{\circ} 17' N.$, and between $87^{\circ} 48'$ and $97^{\circ} 5' E.$ The province, as thus re-constituted, consists of the Bengal districts of Dacca, Mymensingh, Faridpur, Backergunje, Tippera, Noakhali, Chittagong, Chittagong Hill Tracts, Rajshahi, Dinajpur, Jalpaiguri, Rangpur, Bogra, Pabna, Malda, and the native states of Kuch Behar and Hill Tippera; and the whole of the former area of Assam consisting of the districts of Goalpara, Kamrup, Darrang, Nowgong, Sibsagar, Lakhimpur, Sylhet, Cachar, Garo Hills, Khasi and Jaintia Hills, Naga Hills and Lushai Hills. It is bounded on the N. by Bhutan, on the W. by Burma, on the S. by Burma and the Bay of Bengal, and on the E. by Bengal. The line of demarcation between Bengal and the new province begins at the frontier of Bhutan, east of Darjeeling, runs south-west to Sahibganj on the Ganges and thence follows the course of the Ganges down to the deltaic branch, called the Harihargata, which leaves the main stream above Goalanda, and the course of the latter, which runs south into the Bay of Bengal. The capital of the province is Dacca, and its chief port is Chittagong.

The Bengal districts which were transferred to Eastern Bengal and Assam comprised northern and eastern Bengal, the most prosperous and least overcrowded portion of Bengal. The land there is less densely populated, wages are higher and food cheaper, and the rainfall more copious and more regular, while the staple crops of jute, tobacco and rice command a higher price relative to the rent of the land than in Behar or other parts of Bengal. The population are largely Mahomedans and of a more virile stock than the Bengali proper. Northern Bengal corresponds almost exactly with the Rajshahi division and lies within the boundaries of the Ganges and Brahmaputra rivers. It contains much high land of a stiff red clay, with an undulating surface covered for the most part with scrub jungle. The inhabitants are Indo-Chinese, not Indo-Aryans as in Bengal proper, and are Mahomedan by religion instead of Hindu. Eastern Bengal consists of the Dacca and Chittagong divisions which are mainly Bengali in race and Hindu in religion. For the Assamese districts see ASSAM. The province as a whole contains 18,036,688 Mahomedans and 12,036,538 Hindus. In language 27,272,895 of the inhabitants speak Bengali, 1,349,784 speak Assamese, and the remainder Hindi and various hill dialects, Manipuri, Bodo, Khasi and Garo. The administration is in the hands of a lieutenant-governor, assisted by a legislative council of fifteen members. Under him are five commissioners, and financial matters are regulated by a board of revenue consisting of two members.

The constitution of the new province arose out of the fact that Bengal had grown too unwieldy for the administration of a single lieutenant-governor. In 1868 Sir Stafford Northcote drew attention to the greatly augmented demands that the outlying portions of Bengal made on the time and labour of the government. At that time the population of the province was between 40 and 50 millions, and the question was left in abeyance until 1903, when the population had risen to 78½ millions. In the meantime the importance of rendering Assam a self-contained and independent administration with a service of its own, and of providing for its future commercial expansion, had arisen. These two considerations led Lord Curzon to propose that Bengal should be lopped of territory both on its eastern and western borders, and that all the districts east of the Brahmaputra should be constituted into a separate province. This proposal was bitterly opposed by the Hindus of Bengal on the ground that it would destroy the unity of the Bengali race; and their agitation was associated with the *Swadeshi* (own country) movement for the boycott of British goods.

After the constitution of the province in October 1905, the agitation in Eastern Bengal increased. Public meetings of protest were held, vernacular broadsheets containing scandalous

attacks on the British authorities were circulated, schoolboys and others were organized and drilled as so-called "national volunteers," and employed as pickets to prevent the sale of British goods. Such was the state of things when Sir J. Bampfylde Fuller entered on his office as first lieutenant-governor of Eastern Bengal in January 1906. His reception was ominous. Representative bodies that were dominated by Hindus refused to vote the usual addresses of welcome, and non-official Hindus abstained from paying the customary calls. There were, however, no further overt signs of objection to the lieutenant-governor personally, and after a month or two—in spite of, or perhaps because of, his efforts to restrain sedition and to keep discipline in the schools—there was a decided change in the attitude of Hindu opinion. At Dacca, in July, for instance, the reception at Government House was attended by large numbers of Bengali gentlemen, who assured the lieutenant-governor that "the trouble was nearly ended." The agitation was, in fact, largely artificial, the work of Calcutta lawyers, journalists and schoolmasters; the mass of the people, naturally law-abiding, was unmoved by it so long as the government showed a firm hand; while the Mussulmans, who formed a large proportion of the whole, saw in the maintenance of the partition and of the prestige of the British government the guarantees of their own security.

All seemed to be going well when an unfortunate difference of opinion occurred between the lieutenant-governor and the central government, resulting in the resignation of Sir Bampfylde Fuller (August 1906) and in ulterior consequences destined to be of far-reaching import. The facts are briefly as follows. Acting on a report of Dr P. Chatterji, inspector of schools, dated January 2, 1906, the lieutenant-governor, on the 10th of February, addressed a letter to the registrar of Calcutta University recommending that the privilege of affiliation to the university should be withdrawn from the Banwarilal and Victoria high schools at Sirajganj in Pabna, as a punishment for the seditious conduct of both pupils and teachers. Apart from numerous cases of illegal interference with trade and of disorder in the streets reported against the students, two specific outrages of a serious character were instanced as having occurred on the 15th of November: the raiding of a cart laden with English cloth belonging to Marwari traders, and a cowardly assault by some 40 or 50 lads on the English manager of the Bank of Bengal. These outrages "were not the result of thoughtlessness or sudden excitement, but were the outcome of a regularly organized scheme, set on foot and guided by the masters of these schools, for employing the students in enforcing a boycott." All attempts to discover and punish the offenders had been frustrated by the refusal of the school authorities to take action, and in the opinion of the lieutenant-governor the only course open was to apply the remedy suggested in the circular letter addressed to magistrates and collectors (October 10, 1905) by Mr R. W. Carlyle, the officiating chief secretary to the government of Bengal, directing them, in the event of students taking any part in political agitation, boycotting and the like, to inform the heads of schools or colleges concerned that, unless they prevented such action being taken by the boys attending their institutions, their grant-in-aid and the privilege of competing for scholarships and of receiving scholarship-holders would be withdrawn, and that the university would be asked to disaffiliate their institutions.

The reply, dated July 5th, from the secretary in the home department of the government of India, was—to use Sir Bampfylde's own later expression—to throw him over. It was likely that a difference of opinion in the syndicate of the university would arise as to the degree of culpability that attached to the proprietors of the schools; in the event of the syndicate taking any "punitive action," the matter was certain to be raised in the senate, and would lead to an acrimonious public discussion, in which the partition of Bengal and the administration of the new province would be violently attacked; and in the actual state of public opinion in Bengal it seemed to the government of India highly inexpedient that such a debate should take place. "Collective punishment," too, "would be liable to be mis-

construed in England," and the government preferred to rely on the gradual effect of the new university regulations, which aimed "at discouraging the participation of students in political movements by enforcing the responsibility of masters and the managing committees of schools for maintaining discipline."

On receipt of this communication Sir Bampfylde Fuller at once tendered his resignation to the viceroy (July 15). He pointed out that to withdraw from the position taken up would be "concession, not in the interests of education, but to those people in Calcutta who have been striving to render my government impossible, in order to discredit the partition"; that previous concessions had had merely provocative effects, and that were he to give way in this matter his authority would be so weakened that he would be unable to maintain order in the country. On the 3rd of August, after some days of deliberation, the viceroy telegraphed saying that he was "unable to reconsider the orders sent," and accepting Sir Bampfylde's resignation. By the Anglo-Indian press the news was received with something like consternation, the *Times of India* describing the resignation as one of the gravest blunders ever committed in the history of British rule in India, and as a direct incentive to the forces of disquiet, disturbance and unrest. Equally emphatic was the verdict of the Mussulman community forming two-thirds of the population of Eastern Bengal. On the 7th of August, the day of Sir Bampfylde Fuller's departure from Dacca, a mass-meeting of 30,000 Mahomedans was held, which placed on record their disapproval of a system of government "which maintains no continuity of policy," and expressed its feeling that the lowering of British prestige must "alienate the sympathy of a numerically important and loyal section of His Majesty's subjects"; and many meetings of Mussulmans subsequently passed resolutions to the same general effect. The *Akhbar-i-Islam*, the organ of Bombay Mussulman opinion, deplored the "unwise step" taken by the government, and ascribed it to Lord Minto's fear of the Babu press, a display of weakness of which the Babus would not be slow to take advantage.

This latter prophecy was not slow in fulfilling itself. So early as the 8th of August Calcutta was the scene of several large demonstrations at which the Swadeshi vow was renewed, and at which resolutions were passed declining to accept the partition as a settled fact, and resolving on the continuance of the agitation. The tone of the Babu press was openly exultant: "We have read the familiar story of the Russian traveller and the wolves," said a leading Indian newspaper in Calcutta. "The British government follows a similar policy. First the little babies were offered up in the shape of the *Bande Mataram* circular and the Carlyle circular. Now a bigger boy has gone in the person of our own Joseph. Courage, therefore, O wolves! Press on and the horse will soon be yours to devour! Afterwards the traveller himself will alone be left."¹ The task before the new lieutenant-governor of Eastern Bengal, the Hon. L. Harc, was obviously no easy one. The encouragement given to sedition by the weakness of the government in this case was shown by later events in Bengal and elsewhere (see INDIA: *History, ad fin.*).

For the early history of the various portions of the province see BENGAL and ASSAM.

See Sir James Bourdillon, *The Partition of Bengal* (Society of Arts, 1905); official blue-books on *The Reconstitution of the Provinces of Bengal and Assam* (Cd. 2658 and 2746), and *Resignation of Sir J. Bampfylde Fuller*, lieutenant-governor, &c. (Cd. 3242). A long letter from Sir J. B. Fuller, headed *J'accuse*, attacking the general policy of the Indian government in regard to the seditious propaganda, appeared in the *Times* of June 6, 1908.

EASTERN QUESTION, THE, the expression used in diplomacy from about the time of the congress of Verona (1822) to comprehend the international problems involved in the decay of the Turkish empire and its supposed impending dissolution. The essential questions that are involved are so old that historians commonly speak of the "Eastern Question" in reference to events that happened long before the actual phrase was coined. But, wherever used, it is always the Turkish Question, the

¹ Quoted by Mr. ——— in *The Times* of November 22, 1906.

generic term in which subsidiary issues, e.g. the Greek, Armenian or Macedonian questions, are embraced. That a phrase of so wide and loose a nature should have been stereotyped in so narrow a sense is simply the outcome of the conditions under which it was invented. To the European diplomatists of the first half of the 19th century the Ottoman empire was still the only East with which they were collectively brought into contact. The rivalry of Great Britain and Russia in Persia had not yet raised the question of the Middle East; still less any ambitions of Germany in the Euphrates valley. The immense and incalculable problems involved in the rise of Japan, the awakening of China, and their relations to the European powers and to America—known as the Far Eastern Question—are comparatively but affairs of yesterday.

The Eastern Question, though its roots are set far back in history—in the ancient contest between the political and intellectual ideals of Greece and Asia, and in the perennial rivalry of the powers for the control of the great trade routes to the East—dates in its modern sense from the treaty of Kuchuk Kainarji in 1774, which marked the definitive establishment of Russia as a Black Sea power and formed the basis of her special claims to interfere in the affairs of the Ottoman empire. The compact between Napoleon and the emperor Alexander I. at Tilsit (1807) marked a new phase, which culminated in 1812 in the treaty of Bucharest, in which Russia definitely appeared as the protector of the Christian nationalities subject to the Ottoman sultan.

The attitude of the various powers in the Eastern Question was now defined. Russia, apart from her desire to protect the Orthodox nationalities subject to the Ottoman power, aimed at owning or controlling the straits by which alone she could find an outlet to the Mediterranean and the ocean beyond. Austria, once the champion of Europe against the Turk, saw in the Russian advance on the Danube a greater peril than any to be feared from the moribund Ottoman power, and made the maintenance of the integrity of Turkey a prime object of her policy. She was thus brought into line with Great Britain, whose traditional friendship with Turkey was strengthened by the rise of a new power whose rapid advance threatened the stability of British rule in India. But though Austria, Great Britain and presently France, were all equally interested in maintaining the Ottoman empire, the failure of the congress of Vienna in 1815 to take action in the matter of a guarantee of Turkey, and the exclusion of the Sultan from the Holy Alliance, seemed to endorse the claim of Russia to regard the Eastern Question as "her domestic concern" in which "Europe" had no right to interfere. The revolt of the Greeks (1821) put this claim to the test; by the treaty of Adrianople (1829) Russia stipulated for their autonomy as part of the price of peace, but the powers assembled in conference at London refused to recognize this settlement, and the establishment of Greece as an independent kingdom (1832) was really aimed at the pretensions and the influence of Russia. These reached their high-water mark in the treaty of Unkjar Silelessi (July 8th, 1832). It was no longer a question of the partition of Turkey or of a Russian conquest of Constantinople, but of the deliberate degradation by Russia of the Ottoman empire into a weak state wholly dependent upon herself. The ten years' crisis (1831-1841) evoked by the revolt of Mehemet Ali, pasha of Egypt, thus resolved itself into a diplomatic struggle between Russia and the other powers to maintain or to recover influence at Constantinople. The Russian experiment of maintaining the integrity of Turkey while practically treating her as a vassal state, ended with the compromise of 1841; and the emperor Nicholas I. reverted to the older idea of expelling the Turks from Europe. The Eastern Question, however, slumbered until, in 1851, the matter of the Holy Places was raised by Napoleon III., involving the whole question of the influence in Ottoman affairs of France under the capitulations of 1740 and of Russia under the treaty of 1774. The Crimean War followed and in 1856 the treaty of Paris, by which the powers hoped to stem the tide of Russian advance and establish the integrity of a reformed Ottoman state. Turkey

was now for the first time solemnly admitted to the European concert. The next critical phase was opened in 1871, when Russia took advantage of the collapse of France to denounce the Black Sea clauses of the treaty of 1856. The renewal of an aggressive policy thus announced to the world soon produced a new crisis in the Eastern Question, which had meanwhile become complicated by the growth of Pan-Slav ideals in eastern Europe. In 1875 a rising in Herzegovina gave evidence of a state of feeling in the Balkan peninsula which called for the intervention of Europe, if a disastrous war were to be prevented. But this intervention, embodied in the "Andrassy Note" (December 1875) and the Berlin memorandum (May 1876), met with the stubborn opposition of Turkey, where the "young Turks" were beginning to oppose a Pan-Islamic to the Pan-Slav ideal. The Russo-Turkish War of 1877-78 followed, concluded by the treaty of San Stefano, the terms of which were modified in Turkey's favour by the congress of Berlin (1878), which marks the beginning of the later phase of the Eastern Question. Between Russia and Turkey it interposed, in effect, a barrier of independent (Rumania, Servia) and quasi-independent (Bulgaria) states, erected with the counsel and consent of collective Europe. It thus, while ostensibly weakening, actually tended to strengthen the Ottoman power of resistance.

The period following the treaty of Berlin is coincident with the reign of Sultan Abd-ul-Hamid II. The international position of the Ottoman empire was strengthened by the able, if Machiavelian, statecraft of the sultan; while the danger of disruption from within was lessened by the more effective central control made possible by railways, telegraphs, and the other mechanical improvements borrowed from western civilization. With the spread of the Pan-Islamic movement, moreover, the undefined authority of the sultan as caliph of Islam received a fresh importance even in countries beyond the borders of the Ottoman empire, while in countries formerly, or nominally still, subject to it, it caused, and promised to cause, incalculable trouble.

The Eastern Question thus developed, in the latter years of the 19th century, from that of the problems raised by the impending break-up of a moribund empire, into the even more complex question of how to deal with an empire which showed vigorous evidence of life, but of a type of life which, though on all sides in close touch with modern European civilization, was incapable of being brought into harmony with it. The belief in the imminent collapse of the Ottoman dominion was weakened almost to extinction; so was the belief, which inspired the treaty of 1856, in the capacity of Turkey to reform and develop itself on European lines. But the Ottoman empire remained, the mistress of vast undeveloped wealth. The remaining phase of the Eastern Question, if we except the concerted efforts to impose good government on Macedonia in the interests of European peace, or the side issues in Egypt and Arabia, was the rivalry of the progressive nations for the right to exploit this wealth. In this rivalry Germany, whose interest in Turkey even so late as the congress of Berlin had been wholly subordinate, took a leading part, unhampered by the traditional policies or the humanitarian considerations by which the interests of the older powers were prejudiced. The motives of German intervention in the Eastern Question were ostensibly commercial; but the Bagdad railway concession, postulating for its ultimate success the control of the trade route by way of the Euphrates valley, involved political issues of the highest moment and opened up a new and perilous phase of the question of the Middle East.

This was the position when in 1908 an entirely new situation was created by the Turkish revolution. As the result of the patient and masterly organization of the "young Turks," combined with the universal discontent with the rule of the sultan and the palace *camarilla*, the impossible seemed to be achieved, and the heterogeneous elements composing the Ottoman empire to be united in the desire to establish a unified state on the constitutional model of the West. The result on the international situation was profound. Great Britain hastened to re-knit the bonds of her ancient friendship with Turkey; the powers, without exception, professed their sympathy with the new régime.

The establishment of a united Turkey on a constitutional and nationalist basis was, however, not slow in producing a fresh complication in the Eastern Question. Sooner or later the issue was sure to be raised of the status of those countries, still nominally part of the Ottoman empire, but in effect independent, like Bulgaria, or subject to another state, like Bosnia and Herzegovina. The cutting of the Gordian knot by Austria's annexation of Bosnia and Herzegovina, and by the proclamation of the independence of Bulgaria, and of Prince Ferdinand's assumption of the old title of tsar (king), threatened to raise the Eastern Question once more in its acutest form. The international concert defined in the treaty of Berlin had been rudely shaken, if not destroyed; the denunciation by Austria, without consulting her co-signatories, of the clauses of the treaty affecting herself seemed to invalidate all the rest, and in the absence of the restraining force of a united concert of the great powers, free play seemed likely once more to be given to the rival ambitions of the Balkan nationalities, the situation being complicated by the necessity for the dominant party in the renovated Turkish state to maintain its prestige. During the anxious months that followed the Austrian *coup*, the efforts of diplomacy were directed to calming the excitement of Servians, Montenegrins and the Young Turks, and to considering a European conference in which the *fait accompli* should be regularized in accordance with the accepted canons of international law. The long delay in announcing the assembly of the conference proved the extreme difficulty of arriving at any satisfactory basis of settlement; and though the efforts of the powers succeeded in salving the wounded pride of the Turks, and restraining the impetuosity of the Serbs and Montenegrins, warlike preparations on the part of Austria continued during the winter of 1908-1909, being justified by the agitation in Servia, Montenegro and the annexed provinces. It was not till April 1909 (see *EUROPE. ad fin.*) that the crisis was ended, through the effectual backing given by Germany to Austria; and Russia, followed by England and France, gave way and assented to what had been done.

See *TURKEY: History*, where cross-references to the articles on the various phases of the Eastern Question will be found, together with a bibliography. See also E. Driault, *La Question d'orient depuis son origine* (Paris, 1896), a comprehensive sketch of the whole subject, including the Middle and Far East. (W. A. P.)

EAST GRINSTEAD, a market town in the East Grinstead parliamentary division of Sussex, England, 30 m. S. by E. from London by the London, Brighton & South Coast railway. Pop. of urban district (1901) 6094. St Swithin's church contains, among numerous ancient memorials, one of the iron memorial slabs (1507) peculiar to certain churches of Sussex, and recalling the period when iron was extensively worked in the district. There may be noticed Sackville College (an almshouse founded in 1608), and St Margaret's home and orphanage, founded by the Rev. John Mason Neale (1818-1866), warden of Sackville College. Brewing and brick and tile making are carried on. In the vicinity (near Forest Row station) is the golf course of the Royal Ashdown Forest Golf Club.

The hundred of East Grinstead (Grenestede, Estgrensted) was in the possession of the count of Mortain in 1086, but no mention of a vill or manor of East Grinstead is made in the Domesday Survey. In the reign of Henry III. the hundred was part of the honour of Aquila, then in the king's hands. The honour was granted by him to Peter of Savoy, through whom it passed to his niece Queen Eleanor. In the next reign the king's mother held the borough of East Grinstead as parcel of the honour of Aquila. East Grinstead was included in a grant by Edward III. to John of Gaunt, duke of Lancaster, and it remained part of the duchy of Lancaster until James I. granted the borough to Sir George Rivers, through whom it was obtained by the Sackvilles, earls of Dorset. East Grinstead was a borough by prescription. In the 16th century it was governed by an alderman, bailiff and constable. It returned two members to parliament from 1307 until 1832, but was disenfranchised by the Reform Act. In 1285 the king ordered that his market at Grenestede should be held on Saturday instead of Sunday, and in 1516 the inhabitants of the town were granted a market each

week on Saturday and a fair every year on the eve of St Andrew and two days following. Charles I. granted the earl of Dorset a market on Thursday instead of the Saturday market, and fairs on the 16th of April and the 26th of September every year. Thursday is still the market-day, and cattle-fairs are now held on the 21st of April and the 11th of December.

EAST HAM, a municipal borough in the southern parliamentary division of Essex, England, contiguous to West Ham, and thus forming geographically part of the eastward extension of London. Pop. (1901) 96,018. Its modern growth has been very rapid, the population being in the main of the artisan class. There are some chemical and other factories. The ancient parish church of St Mary Magdalen retains Norman work in the chancel, which terminates in an eastern apse. There is a monument for Edmund Neville who claimed the earldom of Westmorland in the 17th century, and William Stukeley, the antiquary, was buried in the churchyard. East Ham was incorporated in 1904, and among its municipal undertakings is a technical college (1905). The corporation consists of a mayor, 6 aldermen and 18 councillors. Area, 3320½ acres.

EASTHAMPTON, a township of Hampshire county, Mass., U.S.A., in the Connecticut Valley. Pop. (1900) 5603, of whom 1731 were foreign-born; (1905) 6808; (1910) 8524. It is served by the Boston & Maine, and the New York, New Haven & Hartford railways, and by Interurban electric railways. The township is generally level, and is surrounded by high hills. In East-hampton are a free public library and Williston Seminary; the latter, one of the oldest and largest preparatory schools in New England, was founded in 1841 by the gifts of Samuel Williston (1795-1874) and Emily Graves Williston (1797-1885). Mr and Mrs Williston built up the industry of covering buttons with cloth, at first doing the work by hand, then (1827) experimenting with machinery, and in 1848 building a factory for making and covering buttons. As the soil was fertile and well watered, the township had been agricultural up to this time. It is now chiefly devoted to manufacturing. Among its products are cotton goods, especially mercerized goods, for the manufacture of which it has one of the largest plants in the country; rubber, thread, elastic fabrics, suspenders and buttons. Parts of Northampton and Southampton were incorporated as the "district" of East-hampton in 1785; it became a township in 1809, and in 1841 and 1850 annexed parts of Southampton.

EAST HAMPTON, a township of Suffolk county, New York, in the extreme S.E. part of Long Island, occupying the peninsula of Montauk, and bounded on the S. and E. by the Atlantic Ocean, and on the N. by Block Island Sound, Gardiner's Bay and Peconic Bay. Pop. (1900) 3746; (1905) 4303; (1910) 4722. The township, 25 m. long and 8 m. at its greatest width from north to south, has an irregular north coast-line and a very regular south coast-line. The surface is rougher to the west where there are several large lakes, notably Great Pond, 2 m. long. The scenery is picturesque and the township is much frequented by artists. Montauk Lighthouse, on Turtle Hill, was first built in 1795. At Montauk, after the Spanish-American War, was Camp Wikoff, a large U.S. military camp. The township is served by the southern division of the Long Island railway, the terminus of which is Montauk. Other villages of the township, all summer resorts, are: Promised Land, Amagansett, East Hampton and Sag Harbor; the last named, only partly in the township, was incorporated in 1803 and had a population of 1066 in 1900, and 3084 in 1910. Silverware and watch cases are manufactured here. From Sag Harbor, which is a port of entry, a daily steamer runs to New York city. The village received many gifts in 1906-1908 from Mrs Russell Sage. Most of the present township was bought from the Indians (Montauks, Corchaugs and Shinnecocks) in 1648 for about £30, through the governors of Connecticut and New Haven, by nine Massachusetts freemen, mostly inhabitants of Lynn, Massachusetts. With twenty other families they settled here in 1649, calling the place Maidstone, from the old home of some of the settlers in Kent; but as early as 1650 the name East Hampton was used in reference to the earlier settlement of South Hampton. Until

1664, when all Long Island passed to the duke of York, the government was by town meeting, autonomous and independent except for occasional appeals to Connecticut. In 1683 Gardiner's Island, settled by Lion Gardiner in 1639 and so one of the first English settlements in what is now New York state, was made a part of Long Island and of East Hampton township. The English settlements in East Hampton were repeatedly threatened by pirates and privateers, and there are many stories of treasure buried by Captain Kidd on Gardiner's Island and on Montauk Point. The Clinton Academy, opened in East Hampton village in 1785, was long a famous school. Of the church built here in 1653 (first Congregational and after 1747 Presbyterian in government), Lyman Beecher was pastor in 1799-1810; and in East Hampton were born his elder children. Whale fishing was begun in East Hampton in 1675, when four Indians were engaged by whites in off-shore whaling; but Sag Harbor, which was first settled in 1730 and was held by the British after the battle of Long Island as a strategic naval and shipping point, became the centre of the whaling business. The first successful whaling voyage was made from Sag Harbor in 1785, and although the Embargo ruined the fishing for a time, it revived during 1830-1850. Cod and menhaden fishing, the latter for the manufacture of fish-oil and guano, were important for a time, but in the second half of the 19th century Sag Harbor lost its commercial importance.

EAST INDIA COMPANY, an incorporated company for exploiting the trade with India and the Far East. In the 17th and 18th centuries East India companies were established by England, Holland, France, Denmark, Scotland, Spain, Austria and Sweden. By far the most important of these was the English East India Company, which became the dominant power in India, and only handed over its functions to the British Government in 1858 (see also **DUTCH EAST INDIA COMPANY**, **OSTEND COMPANY**).

The English East India Company was founded at the end of the 16th century in order to compete with the Dutch merchants, who had obtained a practical monopoly of the trade with the Spice Islands, and had raised the price of pepper from 3s. to 8s. per lb. Queen Elizabeth incorporated it by royal charter, dated December 31, 1600, under the title of "The Governor and Company of Merchants of London, trading into the East Indies." This charter conferred the sole right of trading with the East Indies, i.e. with all countries lying beyond the Cape of Good Hope or the Straits of Magellan, upon the company for a term of 15 years. Unauthorized interlopers were liable to forfeiture of ships and cargo. There were 125 shareholders in the original East India Company, with a capital of £72,000: the first governor was Sir Thomas Smythe. The early voyages of the company, from 1601 to 1612, are distinguished as the "separate voyages," because the subscribers individually bore the cost of each voyage and reaped the whole profits, which seldom fell below 100%. After 1612 the voyages were conducted on the joint stock system for the benefit of the company as a whole. These early voyages, whose own narratives may be read in Purchas, pushed as far as Japan, and established friendly relations at the court of the Great Mogul. In 1610-1611 Captain Hippon planted the first English factories on the mainland of India, at Masulipatam and at Pettapoli in the Bay of Bengal. The profitable nature of the company's trade had induced James I. to grant subsidiary licences to private traders; but in 1609 he renewed the company's charter "for ever," though with a proviso that it might be revoked on three years' notice if the trade should not prove profitable to the realm.

Meanwhile friction was arising between the English and Dutch East India Companies. The Dutch traders considered that they had prior rights in the Far East, and their ascendancy in the Indian Archipelago was indeed firmly established on the basis of territorial dominion and authority. In 1613 they made advances to the

English company with a suggestion for co-operation, but the offer was declined, and the next few years were fertile in disputes between the armed traders of both nations. In 1619 was ratified

a "treaty of defence" to prevent disputes between the English and Dutch companies. When it was proclaimed in the East, hostilities solemnly ceased for the space of an hour, while the Dutch and English fleets, dressed out in all their flags and with yards manned, saluted each other; but the treaty ended in the smoke of that stately salutation, and perpetual and fruitless contentions between the Dutch and English companies went on just as before. In 1623 these disputes culminated in the "massacre of Amboyna," where the Dutch governor tortured and executed the English residents on a charge of conspiring to seize the fort. Great and lasting indignation was aroused in England, but it was not until the time of Cromwell that some pecuniary reparation was exacted for the heirs of the victims. The immediate result was that the English company tacitly admitted the Dutch claims to a monopoly of the trade in the Far East, and confined their operations to the mainland of India and the adjoining countries.

The necessity of good ships for the East Indian trade had led the company in 1609 to construct their dockyard at Deptford, from which, as Monson observes, dates "the increase of great ships in England." Down to the middle of the 19th century, the famous "East Indiamen" held unquestioned pre-eminence among the merchant vessels of the world. Throughout the 17th century they had to be prepared at any moment to fight not merely Malay pirates, but the armed trading vessels of their Dutch, French and Portuguese rivals. Many such battles are recorded in the history of the East India Company, and usually with successful results.

It was not until it had been in existence for more than a century that the English East India Company obtained a practical monopoly of the Indian trade. In 1635, a year after the Great Mogul had granted it the liberty of trading throughout Bengal, Charles I. issued a licence to Courten's rival association, known as "the Assada Merchants," on the ground that the company had neglected English interests. The piratical methods of their rivals disgraced the company with the Mogul officials, and a *modus vivendi* was only reached in 1649. In 1657 Cromwell renewed the charter of 1609, providing that the Indian trade should be in the hands of a single joint stock company. The new company thus formed bought up the factories, forts and privileges of the old one. It was further consolidated by the fostering care of Charles II, who granted it five important charters. From a simple trading company, it grew under his reign into a great chartered company — to use the modern term — with the right to acquire territory, coin money, command fortresses and troops, form alliances, make war and peace, and exercise both civil and criminal jurisdiction. It is accordingly in 1689, when the three presidencies of Bengal, Madras and Bombay had lately been established, that the ruling career of the East India Company begins, with the passing by its directors of the following resolution for the guidance of the local governments in India:—"The increase of our revenue is the subject of our care, as much as our trade; 'tis that must maintain our force when twenty accidents may interrupt our trade; 'tis that must make us a nation in India; without that we are but a great number of interlopers, united by His Majesty's royal charter, fit only to trade where nobody of power thinks it their interest to prevent us; and upon this account it is that the wise Dutch, in all their general advices that we have seen, write ten paragraphs concerning their government, their civil and military policy, warfare, and the increase of their revenue, for one paragraph they write concerning trade." From this moment the history of the transactions of the East India Company becomes the history of British India (see **INDIA: HISTORY**). Here we shall only trace the later changes in the constitution and powers of the ruling body itself.

The great prosperity of the company under the Restoration and the immense profits of the Indian trade, attracted a number of private traders, both outside merchants and dismissed or retired servants of the company, who came to be known as "interlopers." In 1683 the case of Thomas Sandys, an interloper, raised the whole question of the

The East Indiamen.

The acquisition of territory.

English and Dutch disputes.

The interlopers.

royal prerogative to create a monopoly of the Indian trade. The case was tried by Judge Jeffreys, who upheld the royal prerogative; but in spite of his decision the custom of interloping continued and laid the foundation of many great fortunes. By 1691 the interlopers had formed themselves into a new society, meeting at Dowgate, and rivaling the old company; the case was carried before the House of Commons, which declared in 1694 that "all the subjects of England have equal right to trade to the East Indies unless prohibited by act of parliament." This decision led up to the act of 1698, which created a new East India Company in consideration of a loan of two millions to the state. The old company subscribed £315,000 and became the dominant factor in the new body; while at the same time it retained its charter for three years, its factories, forts and assured position in India. The rivalry between the two companies continued both in England and in India, until they were finally amalgamated by a tripartite indenture between the companies and Queen Anne (1702), which was ratified under the Godolphin Award (1708). Under this award the company was to lend the nation £3,200,000, and its exclusive privileges were to cease at three years' notice after this amount had been repaid. But by this time the need for permanence in the Indian establishment began to be felt, while parliament would not relinquish its privilege of "milking" the company from time to time. In 1712 an act was passed continuing the privileges of the company even after their fund should be redeemed; in 1730 the charter was prolonged until 1766, and in 1742 the term was extended until 1783 in return for the loan of a million. This million was required for the war with France, which extended to India and involved the English and French companies there in long-drawn hostilities, in which the names of Duplex and Clive became prominent.

So long as the company's chief business was that of trade, it was left to manage its own affairs. The original charter of Elizabeth had placed its control in the hands of a governor and a committee of twenty-four, and this arrangement subsisted in essence down to the time of George III. The chairman and court of directors in London exercised unchecked control over their servants in India. But after Clive's brilliant victory at Plassey (1757) had made the company a ruling power in India, it was felt to be necessary that the British government should have some control over the territories thus acquired. Lord North's Regulating Act (1773) raised the governor of Bengal—Warren Hastings—to the rank of governor-general, and provided that his nomination, though made by a court of directors, should in future be subject to the approval of the crown; in conjunction with a council of four, he was entrusted with the power of peace and war; a supreme court of judicature was established, to which the judges were appointed by the crown; and legislative power was conferred on the governor-general and his council. Next followed Pitt's India Bill (1784), which created the board of control, as a department of the English government, to exercise political, military and financial superintendence over the British possessions in India. This bill first authorized the historic phrase "governor-general in council." From this date the direction of Indian policy passed definitely from the company to the governor-general in India and the ministry in London. In 1813 Lord Liverpool passed a bill which further gave the board of control authority over the company's commercial transactions, and abolished its monopoly of Indian trade, whilst leaving it the monopoly of the valuable trade with China, chiefly in tea. Finally, under Earl Grey's act of 1833, the company was deprived of this monopoly also. Its property was then secured on the Indian possessions, and its annual dividends of ten guineas per £100 stock were made a charge upon the Indian revenue. Henceforward the East India Company ceased to be a trading concern and exercised only administrative functions. Such a position could not, in the nature of things, be permanent, and the great cataclysm of the Indian Mutiny was followed by the entire transference of Indian administration from the company to the crown, on the 2nd of August 1858.

See *Purchas his Pilgrimes* (ed. 1905), vols. 2, 3, 4, 5, for the charter of Elizabeth and the early voyages; Sir W. W. Hunter, *History of British India* (1899); Beckles Willson, *Ledger and Sward* (1903); Sir George Birdwood, *Report on the Old Records of the India Office* (1879); *The East India Company's First Letter Book* (1895); *Letters Received by the East India Company from its Servants in the East*, ed. Foster, (1896 ff.). See also the interesting memorial volume *Relics of the Honourable East India Company* (ed. Griggs, 1909), letterpress by Sir G. Birdwood and W. Foster.

EAST INDIES, a name formerly applied vaguely, in its widest sense, to the whole area of India, Further India and the Malay Archipelago, in distinction from the West Indies, which, at the time of their discovery, were taken to be the extreme parts of the Indian region. The term "East Indies" is still sometimes applied to the Malay Archipelago (*q.v.*) alone, and the phrase "Dutch East Indies" is commonly used to denote the Dutch possessions which constitute the greater part of that archipelago. The Dutch themselves use the term *Nederlandsch-Indië*.

EASTLAKE, SIR CHARLES LOCK (1793–1865), English painter, was born on the 17th of November 1793 at Plymouth, where his father, a man of uncommon gifts but of indolent temperament, was solicitor to the admiralty and judge advocate of the admiralty court. Charles was educated (like Sir Joshua Reynolds) at the Plympton grammar-school, and in London at the Charterhouse. Towards 1809, partly through the influence of his fellow-Devonian Haydon, of whom he became a pupil, he determined to be a painter; he also studied in the Royal Academy school. In 1813 he exhibited in the British Institution his first picture, a work of considerable size, "Christ restoring life to the Daughter of Jairus." In 1814 he was commissioned to copy some of the paintings collected by Napoleon in the Louvre; he returned to England in 1815, and practised portrait-painting at Plymouth. Here he saw Napoleon a captive on the "Bellerophon"; from a boat he made some sketches of the emperor, and he afterwards painted, from these sketches and from memory, a life-sized full-length portrait of him (with some of his officers) which was pronounced a good likeness; it belongs to the marquess of Lansdowne. In 1817 Eastlake went to Italy; in 1819 to Greece; in 1820 back to Italy, where he remained altogether fourteen years, chiefly in Rome and in Ferrara.

In 1827 he exhibited at the Royal Academy his picture of the Spartan Isidas, who (as narrated by Plutarch in the life of Agesilaus), rushing naked out of his bath, performed prodigies of valour against the Theban host. This was the first work that attracted much notice to the name of Eastlake, who in consequence obtained his election as A.R.A.; in 1830, when he returned to England, he was chosen R.A. In 1850 he succeeded Shee as president of the Royal Academy, and was knighted. Prior to this, in 1841, he had been appointed secretary to the royal commission for decorating the Houses of Parliament, and he retained this post until the commission was dissolved in 1862. In 1843 he was made keeper of the National Gallery, a post which he resigned in 1847 in consequence of an unfortunate purchase that roused much animadversion, a portrait erroneously ascribed to Holbein; in 1855, director of the same institution, with more extended powers. During his directorship he purchased for the gallery 155 pictures, mostly of the Italian schools. He became also a D.C.L. of Oxford, F.R.S., a chevalier of the Legion of Honour, and member of various foreign academies.

In 1849 he married Miss Elizabeth Rigby, who had already then become known as a writer (*Letters from the Baltic*, 1841; *Livonian Tales*, 1846; *The Jewess*, 1848) and as a contributor to the *Quarterly Review*. Lady Eastlake (1809–1893) had for some years been interested in art subjects, and after her marriage she naturally devoted more attention to them, translating Waagen's *Treasures of Art in Great Britain* (1854–1857), and completing Mrs Jameson's *History of our Lord in Works of Art*. In 1865 Sir Charles Eastlake fell ill at Milan; and he died at Pisa on the 24th of December in the same year. Lady Eastlake, who survived him for many years, continued to play an active part as a writer on art (*Five Great Painters*, 1883, &c.), and had a large circle of friends among the most interesting men and women of the day. In 1880 she published a volume of *Letters from Fr*

describing events in Paris during 1780), written by her father, Edward Rigby (1747-1821), a distinguished Norwich doctor who was known also for his practical interest in agriculture, and who is said to have made known the flying shuttle to Norwich manufacturers.

As a painter, Sir Charles Eastlake was gentle, harmonious, diligent and correct; lacking fire of invention or of execution; eclectic, without being exactly imitative; influenced rather by a love of ideal grace and beauty than by any marked bent of individual power or vigorous originality. Among his principal works (which were not numerous, 51 being the total exhibited in the Academy) are: 1828, "Pilgrims arriving in sight of Rome" (repeated in 1835 and 1836, and perhaps on the whole his *chef-d'œuvre*); 1829, "Byron's Dream" (in the Tate Gallery); 1834, the "Escape of Francesco di Carrara" (a duplicate in the Tate Gallery); 1841, "Christ Lamenting over Jerusalem" (ditto); 1843, "Hagar and Ishmael"; 1845, "Comus"; 1849, "Helena"; 1851, "Ippolita Torelli"; 1853, "Violante"; 1855, "Beatrice." These female heads, of a refined semi-ideal quality, with something of Venetian glow of tint, are the most satisfactory specimens of Eastlake's work to an artist's eye. He was an accomplished and judicious scholar in matters of art, and published, in 1840, a translation of Goethe's *Theory of Colours*; in 1847 (his chief literary work) *Materials for a History of Oil-Painting*, especially valuable as regards the Flemish school; in 1848, *Contributions to the Literature of the Fine Arts* (a second series was edited by Lady Eastlake in 1870, and accompanied by a Memoir from her pen); in 1851 and 1855, translated editions of Kugler's *History of the Italian School of Painting*, and *Handbook of Painting* (new edition, by Lady Eastlake, 1874).

See W. Cosmo Monkhouse, *Pictures by Sir Charles Eastlake, with biographical and critical Sketch* (1875). (W. M. R.)

EAST LIVERPOOL, a city of Columbiana county, Ohio, U.S.A., on the Ohio river, about 106 m. S.E. of Cleveland. Pop. (1890) 10,956; (1900) 16,485, of whom 2112 were foreign-born; (1910 census) 20,387. It is served by the Pennsylvania railway, by river steamboats, and by interurban electric lines. Next to Trenton, New Jersey, East Liverpool is the most important place in the United States for the manufacture of earthenware and pottery, 4859 out of its 5228 wage-earners, or 92.9%, being employed in this industry in 1905, when \$5,373,852 (83.5% of the value of all its factory products) was the value of the earthenware and pottery. No other city in the United States is so exclusively devoted to the manufacture of pottery; in 1908 there were 32 potteries in the city and its immediate vicinity. The manufacture of white ware, begun in 1872, is the most important branch of the industry—almost half of the "cream-coloured," white granite ware and semivitreous porcelain produced in the United States in 1905 (in value, \$4,344,468 out of \$9,195,703) being manufactured in East Liverpool. Though there are large clay deposits in the vicinity, very little of it can be used for crockery, and most of the clay used in the city's potteries is obtained from other states; some of it is imported from Europe. After 1872 a large number of skilled English pottery-workers settled in the city. The city's product of pottery, terra-cotta and fireclay increased from \$2,137,063 to \$4,105,200 from 1890 to 1900, and in the latter year almost equalled that of Trenton, N. J., the two cities together producing more than half (50.9%) of the total pottery product of the United States; in 1905 East Liverpool and Trenton together produced 42.1% of the total value of the country's pottery product. The municipality owns and operates its water-works. East Liverpool was settled in 1798, and was incorporated in 1834.

EAST LONDON, a town of the Cape province, South Africa, at the mouth of the Buffalo river, in 33° 1' S. 27° 55' E., 543 m. E.N.E. of Cape Town by sea and 666 m. S. of Johannesburg by rail. Pop. (1904) 25,220, of whom 14,674 were whites. The town is picturesquely situated on both sides of the river, which is spanned by a combined road and railway bridge. The railway terminus and business quarter are on the east side on the top of the cliffs, which rise 150 ft. above the river. In Oxford Street, the chief thoroughfare, is the town hall, a handsome building

erected in 1898. Higher up a number of churches and a school are grouped round Vincent Square, a large open space. In consequence of the excellent sea bathing, and the beauty of the river banks above the town, East London is the chief seaside holiday resort of the Cape province. The town is the entree of a rich agricultural district, including the Transkei, Basutoland and the south of Orange Free State, and the port of the Cape nearest Johannesburg. It ranks third among the ports of the province. The roadstead is exposed and insecure, but the inner harbour, constructed at a cost of over £2,000,000, is protected from all winds. A shifting sand bar lies at the mouth of the river, but the building of training walls and dredging have increased the minimum depth of water to 22 ft. From the east bank of the Buffalo a pier and from the west bank a breakwater project into the Indian Ocean, the entrance being 450 ft. wide, reduced between the training walls to 250 ft. There is extensive wharf accommodation on both sides of the river, and steamers of over 8000 tons can moor alongside. There is a patent slip capable of taking vessels of 1000 tons dead weight. An aerial steel ropeway from the river bank to the town greatly facilitates the delivery of cargo. The imports are chiefly textiles, hardware and provisions, the exports mainly wool and mohair. The rateable value of the town in 1908 was £4,108,000, and the municipal rate 1½ d.

East London owes its foundation to the necessities of the Kaffir war of 1846-1847. The British, requiring a port nearer the scene of war than those then existing, selected a site at the mouth of the Buffalo river, and in 1847 the first cargo of military stores was landed. A fort, named Glamorgan, was built, and the place permanently occupied. Around this military post grew up the town, known at first as Port Rex. Numbers of its inhabitants are descendants of German immigrants who settled in the district in 1857. The prosperity of the town dates from the era of railway and port development in the last decade of the 19th century. In 1875 the value of the exports was £131,803 and that of the imports £552,933. In 1904 the value of the exports was £1,165,938 and that of the imports £4,688,415. In 1907 the exports, notwithstanding a period of severe trade depression, were valued at £1,475,355, but the imports had fallen to £3,354,633.

EASTON, a city and the county-seat of Northampton county, Pennsylvania, U.S.A., at the confluence of the Lehigh river and Bushkill Creek with the Delaware, about 60 m. N. of Philadelphia. Pop. (1890) 14,481; (1900) 25,238, of whom 2135 were foreign-born; (1910 census) 28,523. Easton is served by the Central of New Jersey, the Lehigh Valley, the Lehigh & Hudson River and the Delaware, Lackawanna & Western railways, and is connected by canals with the anthracite coal region to the north-west and with Bristol, Pa. A bridge across the Delaware river connects it with Phillipsburg, New Jersey, which is served by the Pennsylvania railway. The city is built on rolling ground, commanding pleasant views of hill and river scenery. Many fine residences overlook city and country from the hillsides, and a Carnegie library is prominent among the public buildings. Lafayette College, a Presbyterian institution opened in 1832, is finely situated on a bluff north of the Bushkill and Delaware. The college provides the following courses of instruction: graduate, classical, Latin scientific, general scientific, civil engineering, electrical engineering, mining engineering and chemical; in 1908 it had 38 instructors and 442 students, 259 of whom were enrolled in the scientific and engineering courses. Overlooking the Bushkill is the Easton Cemetery, in which is the grave of George Taylor (1716-1781), a signer of the Declaration of Independence, with a monument of Italian marble to his memory. Among the city's manufactures are silk, hosiery and knit goods, flour, malt liquors, brick, tile, drills, lumber and planing mill products and organs; in 1905 the value of all the factory products was \$5,654,504, of which \$2,200,598, or 40.5%, was the value of the silk manufactures. Easton is the commercial centre of an important mining region, which produces, in particular, iron ore, soapstone, cement, slate and building stone. The municipality owns and operates an electric-lighting plant.

Easton was a garden spot of the Indians, and here, because they would not negotiate elsewhere, several important treaties were made between 1756 and 1764 during the French and Indian War. The place was laid out in 1752, and was made the county-seat of the newly erected county. It was incorporated as a borough in 1789, received a new borough charter in 1823, and in 1887 was chartered as a city. South Easton was annexed in 1898.

EAST ORANGE, a city of Essex county, New Jersey, U.S.A., in the north-eastern part of the state, adjoining the city of Newark, and about 12 m. W. of New York city. Pop. (1890) 13,282; (1900) 21,506, of whom 3950 were foreign-born and 1420 were negroes; (1910 census) 34,371. It is served by the Morris & Essex division of the Delaware, Lackawanna & Western railway and by the Orange branch of the Erie (the former having four stations—Ampere, Grove Street, East Orange and Brick Church), and is connected with Newark, Orange and West Orange by electric line. The city covers an area of about 4 sq. m., and has broad, well-paved streets, bordered with fine shade trees (under the jurisdiction of a "Shade Tree Commission"). It is primarily a residential suburb of New York and Newark, and has many beautiful homes; with Orange, West Orange and South Orange it forms virtually one community, popularly known as "the Oranges." The public school system is excellent, and the city has a Carnegie library (1903), with more than 22,000 volumes in 1907. Among the principal buildings are several attractive churches, the city hall, and the club-house of the Woman's Club of Orange. The principal manufactures of East Orange are electrical machinery, apparatus, and supplies (the factory of the Crocker-Wheeler Co. being here—in a part of the city known as "Ampere") and pharmaceutical materials. The total value of the city's factory products in 1905 was \$2,326,552. East Orange has a fine water-works system, which it owns and operates; the water supply is obtained from artesian wells at White Oaks Ridge, in the township of Milburn (about 10 m. from the city hall); thence the water is pumped to a steel reinforced reservoir (capacity 5,000,000 gallons) on the mountain back of South Orange. In 1863 the township of East Orange was separated from the township of Orange, which, in turn, had been separated from the township of Newark in 1806. An act of the New Jersey legislature in 1895 created the office of township president, with power of appointment and veto. Four years later East Orange was chartered as a city.

See H. Whittemore, *The Founders and Builders of the Oranges* (Newark, 1896).

EASTPORT, a city and port of entry of Washington county, Maine, U.S.A., co-extensive with Moose Island in Passamaquoddy Bay, about 190 m. E.N.E. of Portland. Pop. (1890) 4908; (1900) 5311 (1554 foreign-born); (1910) 4961. It is served by the Washington County railway, and by steamboat lines to Boston, Portland and Calais. It is the most eastern city of the United States, and is separated from the mainland by a narrow channel, which is spanned by a bridge. The harbour is well protected from the winds, and the tide, which rises and falls here about 25 ft., prevents it from being obstructed with ice. The city is built on ground sloping gently to the water's edge, and commands delightful views of the bay, in which there are several islands. Its principal industry is the canning of sardines; there are also clam canneries. Shoes, mustard, decorated tin, and shooks are manufactured, and fish and lobsters are shipped from here in the season. The city is the port of entry for the customs district of Passamaquoddy; in 1908 its imports were valued at \$904,961, and its exports at \$1,155,791. Eastport was first settled about 1782 by fishermen; it became a port of entry in 1790, was incorporated as a town in 1798, and was chartered as a city in 1893. It was a notorious place for smuggling under the Embargo Acts of 1807 and 1808. On the 11th of July 1814, during the war of 1812, it was taken by the British. As the British government claimed the islands of Passamaquoddy Bay under the treaty of 1783, the British forces retained possession of Eastport after the close of the war and held it under martial law until July 1818, when it was surrendered in accordance with the decision rendered in

November 1817 by commissioners appointed under Article IV. of the treaty of Ghent (1814), this decision awarding Moose Island, Dudley Island and Frederick Island to the United States and the other islands, including the Island of Grand Manan in the Bay of Fundy, to Great Britain.

EAST PROVIDENCE, a township of Providence county, Rhode Island, U.S.A., on the E. side of Providence river, opposite Providence. Pop. (1890) 8422; (1900) 12,138, of whom 2067 were foreign-born; (1910 census) 15,808. Area, 12½ sq. m. It is served by the New York, New Haven & Hartford railway. It has a rolling surface and contains several villages, one of which, known as Rumford, has important manufactories of chemicals and electrical supplies. South of this village, along the river bank, are several attractive summer resorts, Hunt's Mills, Silver Spring, Riverside, Vanity Fair, Kettle Point and Bullock's Point being prominent among them. In 1905 the factory products of the township were valued at \$5,035,288. The oyster trade is important. It was within the present limits of this township that Roger Williams established himself in the spring of 1636, until he learned that the place was within the jurisdiction of the Plymouth Colony. About 1644 it was settled by a company from Weymouth as a part of a town of Rehoboth. In 1812 Rehoboth was divided, and the west part was made the township of Seekonk. Finally, in 1861, it was decided that the west part of Seekonk belonged to Rhode Island, and in the following year that part was incorporated as the township of East Providence.

EAST PRUSSIA (*Ost-Preussen*), the easternmost province of the kingdom of Prussia, bounded on the N. by the Baltic, on the E. and S.W. by Russia and Russian Poland, and on the W. by the Prussian province of West Prussia. It has an area of 14,284 sq. m., and had, in 1905, a population of 2,025,741. It shares in the general characteristics of the great north German plain, but, though low, its surface is by no means absolutely flat, as the southern half is traversed by a low ridge or plateau, which attains a height of 1025 ft. at a point near the western boundary of the province. This plateau, here named the Prussian Scenplatte, is thickly sprinkled with small lakes, among which is the Spirding See, 46 sq. m. in extent and the largest inland lake in the Prussian monarchy. The coast is lined with low dunes or sandhills, in front of which lie the large littoral lakes or lagoons named the Frisches Haff and the Kurisches Haff. The first of these receives the waters of the Nogat and the Pregel, and the other those of the Memel or Niemen. East Prussia is the coldest part of Germany, its mean annual temperature being about 44° F., while the mean January temperature of Tilsit is only 25°. The rainfall is 24 in. per annum. About half the province is under tillage; 18% is occupied by forests, and about 23% by meadows and pastures. The most fertile soil is found in the valleys of the Pregel and the Memel, but the southern slopes of the Baltic plateau and the district to the north of the Memel consist in great part of sterile moor, sand and bog. The chief crops are rye, oats and potatoes, while flax is cultivated in the district of Ermeland, between the Passarge and the upper Alle. East Prussia is the headquarters of the horse-breeding of the country, and contains the principal government stud of Trakehnen; numerous cattle are also fattened on the rich pastures of the river-valleys. The extensive woods in the south part of the province harbour a few wolves and lynxes, and the elk is still preserved in the forest of Ibenhorst, near the Kurisches Haff. The fisheries in the lakes and haffs are of some importance; but the only mineral product of note is amber, which is found in the peninsula of Samland in greater abundance than in any other part of the world. Manufactures are almost confined to the principal towns, though linen-weaving is practised as a domestic industry. Commerce is facilitated by canals connecting the Memel and Pregel and also the principal lakes, but is somewhat hampered by the heavy dues exacted at the Russian frontier. A brisk foreign trade is carried on through the seaports of Königsberg, the capital of the province, and Memel, the exports consisting mainly of timber and grain.

The population of the province was in 1900 1,996,626, and

included 1,698,465 Protestants, 269,196 Roman Catholics and 13,877 Jews. The Roman Catholics are mainly confined to the district of Ermeland, in which the ordinary proportions of the confessions are completely reversed. The bulk of the inhabitants are of German blood, but there are above 400,000 Protestant Poles (Masurians or Masovians) in the south part of the province, and 175,000 Lithuanians in the north. As in other provinces where the Polish element is strong, East Prussia is somewhat below the general average of the kingdom in education. There is a university at Königsberg.

See Lohmeyer, *Geschichte von Ost-und West-Preussen* (Gotha, 1884); Brünneck, *Zur Geschichte des Kirchen-Patrimonats in Ost-und West-Preussen* (Berlin, 1902), and *Ost-Preussen, Land und Volk* (Stuttgart, 1901-1902).

EASTWICK, EDWARD BACKHOUSE (1814-1883), British Orientalist, was born in 1814, a member of an Anglo-Indian family. Educated at Charterhouse and at Oxford, he joined the Bombay infantry in 1836, but, owing to his talent for languages, was soon given a political post. In 1843 he translated the Persian *Kessaki Sanjan*, or *History of the Arrival of the Parsees in India*; and he wrote a *Life of Zoroaster*, a *Sindhi* vocabulary, and various papers in the transactions of the Bombay Asiatic Society. Compelled by ill-health to return to Europe, he went to Frankfurt, where he learned German and translated Schiller's *Revolt of the Netherlands* and Bopp's *Comparative Grammar*. In 1845 he was appointed professor of Hindustani at Haileybury College. Two years later he published a Hindustani grammar, and, in subsequent years, a new edition of the *Gulistan*, with a translation in prose and verse, also an edition with vocabulary of the Hindi translation by Lallú Lál of Chatur Chuf Mir's *Prem Sagr*, and translations of the *Bagh-o-Bahar*, and of the *Anvar-i-Suhaili* of Bidpál. In 1851 he was elected a Fellow of the Royal Society. In 1857-1858 he edited *The Autobiography of Lalúllah*. He also edited for the Bible Society the Book of Genesis in the Dakhani language. From 1860 to 1863 he was in Persia as secretary to the British Legation, publishing on his return *The Journal of a Diplomat*. In 1866 he became private secretary to the secretary of state for India, Lord Cranborne (afterwards marquess of Salisbury), and in 1867 went, as in 1864, on a government mission to Venezuela. On his return he wrote, at the request of Charles Dickens, for *All the Year Round*, "Sketches of Life in a South American Republic." From 1868 to 1874 he was M.P. for Penryn and Falmouth. In 1875 he received the degree of M.A. with the franchise from the university of Oxford, "as a slight recognition of distinguished services." At various times he wrote several of Murray's Indian hand-books. His last work was the *Kaisar-namah-i-Hind* ("the lay of the empress"), in two volumes (1878-1882). He died at Ventnor, Isle of Wight, on the 16th of July 1883.

EATON, DORMAN BRIDGMAN (1823-1890), American lawyer, was born at Hardwick, Vermont, on the 27th of June 1823. He graduated at the university of Vermont in 1848 and at the Harvard Law School in 1850, and in the latter year was admitted to the bar in New York city. There he became associated in practice with William Kent, the son of the great chancellor, an edition of whose *Commentaries* he assisted in editing. Eaton early became interested in municipal and civil service reform. He was conspicuous in the fight against Tweed and his followers, by one of whom he was assaulted; he required a long period of rest, and went to Europe, where he studied the workings of the civil service in various countries. From 1873 to 1875 he was a member of the first United States Civil Service Commission. In 1877, at the request of President Hayes, he made a careful study of the British civil service, and three years later published *Civil Service in Great Britain*. He drafted the Pendleton Civil Service Act of 1883, and later became a member of the new commission established by it. He resigned in 1885, but was almost immediately reappointed by President Cleveland, and served until 1886, editing the 3rd and 4th *Reports* of the commission. He was an organizer (1878) of the first society for the furtherance of civil service reform in New York, of the

National Civil Service Reform Association, and of the National Conference of the Unitarian Church (1865). He died in New York city on the 23rd of December 1899, leaving \$100,000 each to Harvard and Columbia universities for the establishments of professorships in government. He was a legal writer and editor, and a frequent contributor to the leading reviews. In addition to the works mentioned he published *Should Judges be Elected?* (1873), *The Independent Movement in New York* (1880), *Term and Tenure of Office* (1882), *The Spoils System and Civil Service Reform* (1882), *Problems of Police Legislation* (1895) and *The Government of Municipalities* (1899).

See the privately printed memorial volume, *Dorman B. Eaton*, 1823-1899 (New York, 1900).

EATON, MARGARET O'NEILL (1796-1879), better known as PEGGY O'NEILL, was the daughter of the keeper of a popular Washington tavern, and was noted for her beauty, wit and vivacity. About 1823, she married a purser in the United States navy, John B. Timberlake, who committed suicide while on service in the Mediterranean in 1828. In the following year she married John Henry Eaton (1790-1856), a Tennessee politician, at the time a member of the United States Senate. Senator Eaton was a close personal friend of President Jackson, who in 1829 appointed him secretary of war. This sudden elevation of Mrs Eaton into the cabinet social circle was resented by the wives of several of Jackson's secretaries, and charges were made against her of improper conduct with Eaton previous to her marriage to him. The refusal of the wives of the cabinet members to recognize the wife of his friend angered President Jackson, and he tried in vain to coerce them. Eventually, and partly for this reason, he almost completely reorganized his cabinet. The effect of the incident on the political fortunes of the vice-president, John C. Calhoun, whose wife was one of the recalcitrants, was perhaps most important. Partly on this account, Jackson's favour was transferred from Calhoun to Martin Van Buren, the secretary of state, who had taken Jackson's side in the quarrel and had shown marked attention to Mrs Eaton, and whose subsequent elevation to the vice-presidency and presidency through Jackson's favour is no doubt partly attributable to this incident. In 1836 Mrs Eaton accompanied her husband to Spain, where he was United States minister in 1836-1840. After the death of her husband she married a young Italian dancing-master, Antonio Buchignani, but soon obtained a divorce from him. She died in Washington on the 8th of November 1879.

See James Parton's *Life of Andrew Jackson* (New York, 1860).

EATON, THOPHILUS (c. 1590-1658), English colonial governor in America, was born at Stony Stratford, Buckinghamshire, about 1590. He was educated in Coventry, became a successful merchant, travelled widely throughout Europe, and for several years was the financial agent of Charles I. in Denmark. He subsequently settled in London, where he joined the Puritan congregation of the Rev. John Davenport, whom he had known since boyhood. The pressure upon the Puritans increasing, Eaton, who had been one of the original patentees of the Massachusetts Bay colony in 1629, determined to use his influence and fortune to establish an independent colony of which his pastor should be the head. In 1637 he emigrated with Davenport to Massachusetts, and in the following year (March 1638) he and Davenport founded New Haven. In October 1639 a form of government was adopted, based on the Mosaic Law, and Eaton was elected governor, a post which he continued to hold by annual re-election, first over New Haven alone, and after 1643 over the New Haven Colony or Jurisdiction, until his death at New Haven on the 7th of January 1658. His administration was embarrassed by constantly recurring disputes with the neighbouring Dutch settlements, especially after Stamford (Conn.) and Southold (Long Island) had entered the New Haven Jurisdiction, but his prudence and diplomacy prevented an actual outbreak of hostilities. He was prominent in the affairs of the New England Confederation, of which he was one of the founders (1643). In 1655 he and Davenport drew up the code of laws, popularly known as the "Connecticut Blue Laws," which were published

in London in 1856 under the title *New Haven's Settling in New England and some Laws for Government published for the Use of that Colony*.

A sketch of his life appears in Cotton Mather's *Magnalia* (London, 1702); see also J. B. Moore's "Memoir of Theophilus Eaton" in the *Collections of the New York Historical Society*, second series, vol. ii. (New York, 1849).

EATON, WILLIAM (1764-1811), American soldier, was born in Woodstock, Connecticut, on the 23rd of February 1764. As a boy he served for a short time in the Continental army. He was a school teacher for several years, graduated at Dartmouth College in 1790, was clerk of the lower house of the Vermont legislature in 1791-1792, and in 1792 re-entered the army as a captain, later serving against the Indians in Ohio and Georgia. In 1797 he was appointed consul to Tunis, where he arrived in February 1799. In March 1799, with the consuls to Tripoli and Algiers, he negotiated alterations in the treaty of 1797 with Tunis. He rendered great service to Danish merchantmen by buying on credit several Danish prizes in Tunis and turning them over to their original owners for the redemption of his notes. In 1803 he quarrelled with the Bey, was ordered from the country, and returned to the United States to urge American intervention for the restoration of Ahmet Karamanli to the throne of Tripoli, arguing that this would impress the Barbary States with the power of the United States. In 1804 he returned to the Mediterranean as United States naval agent to the Barbary States with Barron's fleet. On the 23rd of February 1805 he agreed with Ahmet that the United States should undertake to re-establish him in Tripoli, that the expenses of the expedition should be repaid to the United States by Ahmet, and that Eaton should be general and commander-in-chief of the land forces in Ahmet's campaign; as the secretary of the navy had given the entire matter into the hands of Commodore Barron, and as Barron and Tobias Lear (1767-1816), the United States consul-general at Algiers and a diplomatic agent to conduct negotiations, had been instructed to consider the advisability of making arrangements with the existing government in Tripoli, Eaton far exceeded his authority. On the 8th of March he started for Derna across the Libyan desert from the Arab's Tower, 40 m. W. of Alexandria, with a force of about 500 men, including a few Americans, about 40 Greeks and some Arab cavalry. In the march of nearly 600 m. the camel-drivers and the Arab chiefs repeatedly mutinied, and Ahmet Pasha once put himself at the head of the Arabs and ordered them to attack Eaton. Ahmet more than once wished to give up the expedition. There were practically no provisions for the latter part of the march. On the 27th of April with the assistance of three bombarding cruisers Eaton captured Derna—an exploit commemorated by Whittier's poem *Derna*. On the 13th of May and on the 10th of June he successfully withstood the attacks of Tripolitan forces sent to dislodge him. On the 12th of June he abandoned the town upon orders from Commodore Rodgers, for Lear had made peace (4th June) with Yussuf, the *de facto* Pasha of Tripoli. Eaton returned to the United States, and received a grant of 10,000 acres in Maine from the Massachusetts legislature. According to a deposition which he made in January 1807 he was approached by Aaron Burr (q.v.), who attempted to enlist him in his "conspiracy," and wished him to win over the marine corps and to sound Preble and Decatur. As he received from the government, soon after making this deposition, about \$10,000 to liquidate claims for his expense in Tripoli, which he had long pressed in vain, his good faith has been doubted. At Burr's trial at Richmond in 1807 Eaton was one of the witnesses, but his testimony was unimportant. In May 1807 he was elected a member of the Massachusetts House of Representatives, and served for one term. He died on the 1st of June 1811 in Birmingfield, Massachusetts.

See the anonymously published *Life of the Late Gen. William Eaton* (Brookfield, Massachusetts, 1813) by Charles Prentiss; C. C. Felton, "Life of William Eaton" in Sparks's *Library of American Biography*, vol. ix. (Boston, 1838); and Gardner W. Allen's *Our Navy and the Barbary Corsairs* (Boston, 1905).

EATON, WYATT (1849-1896), American portrait and figure painter, was born at Philipsburg, Canada, on the 6th of May 1849.

He was a pupil of the schools of the National Academy of Design, New York, and in 1872 went to Paris, where he studied in the *École des Beaux-Arts* under J. L. Gérôme. He made the acquaintance of J. F. Millet at Barbizon, and was also influenced by his friend Jules Bastien-Lepage. After his return to the United States in 1876 he became a teacher in Cooper Institute and opened a studio in New York city. He was one of the organizers (and the first secretary) of the Society of American Artists. Among his portraits are those of William Cullen Bryant and Timothy Cole, the wood engraver ("The Man with the Violin"). Eaton died at Newport, Rhode Island, on the 7th of June 1896.

EAU CLAIRE, a city and the county-seat of Eau Claire county, Wisconsin, U.S.A., on the Chippewa river, at the mouth of the Eau Claire, about 87 m. E. of St Paul. Pop. (1890) 17,415; (1900) 17,517, of whom 4996 were foreign-born; (1910 census) 18,310. It is served by the Chicago & North-Western, the Chicago, Milwaukee & St Paul, and the Wisconsin Central railways, and is connected by an electric line with Chippewa Falls (12 m. distant). The city has a Carnegie library with 17,300 volumes in 1908, a Federal building, county court house, normal school and insane asylum. It has abundant water-power, and is an important lumber manufacturing centre; among its other manufactures are flour, wooden-ware, agricultural machinery, saw-mill machinery, logging locomotives, wood pulp, paper, linen, mattresses, shoes and trunks. The total value of factory products in 1905 was \$3,607,558. The city is the principal wholesale and jobbing market for the prosperous Chippewa Valley. Eau Claire was first settled about 1847, and was chartered as a city in 1872; its growth dates from the development of the north-western lumber trade in the decade 1870-1880. In 1881 a serious strike necessitated the calling out of state militia for its suppression and the protection of property.

EAU DE COLOGNE (Ger. *Kölnisches Wasser*, "Cologne water"), a perfume, so named from the city of Cologne, where its manufacture was first established by an Italian, Johann (or Giovanni) Maria Farina (1685-1766), who settled at Cologne in 1709. The perfume gained a high reputation by 1766, and Farina associated himself with his nephew, to whose grandson the secret was ultimately imparted; the original perfume is still manufactured by members of this family under the name of the founder. The manufacture is, however, carried on at Cologne, and also in Italy, by other firms bearing the name Farina, and the scent has become part of the regular output of perfumers. The discovery has also been ascribed to a Paul de Feminis, who is supposed to have brought his recipe from Milan to Cologne, of which he became a citizen in 1690, and sold the perfume under the name *Eau admirable*, leaving the secret at his death to his nephew Johann Maria Farina. Certain of the Farinas claim to use his process. It was originally prepared by making an alcoholic infusion of certain flowers, pot-herbs, drugs and spices, distilling and then adding definite quantities of several vegetable essences. The purity and thorough blending of the ingredients are of the greatest importance. The original perfume is simulated and even excelled by artificial preparations. The oils of lemon, bergamot and orange are employed, together with the oils of neroli and rosemary in the better class. The common practice consists in dissolving the oils, in certain definite proportions based on experience, in pure alcohol and distilling, the distillate being diluted by rose-water.

EAUX-BONNES, a watering-place of south-western France, in the department of Basses-Pyrénées, 3½ m. S.E. of the small town of Laruns, the latter being 24 m. S. of Pau by rail. Pop. (1906) 610. Eaux-Bonnes is situated at a height of 2460 ft. at the entrance of a fine gorge, overlooking the confluence of two torrents, the Valentin and the Sourde. The village is well known for its sulphurous and saline mineral waters (first mentioned in the middle of the 14th century), which are beneficial in affections of the throat and lungs. They vary between 50° and 90° F. in temperature, and are used for drinking and bathing. There are two thermal establishments, a casino and fine promenades.

The watering-place of LES EAUX-CHAUDRES is 5 m. by road, south-west of Eaux-Bonnes, in a wild gorge on the Gave d'Ossau. The springs are sulphurous, varying in temperature from 52° to 97° F., and are used in cases of rheumatism, certain maladies of women, &c. The thermal establishment is a handsome marble building.

There is fine mountain scenery in the neighbourhood of both places, the Pic de Ger near Eaux-Bonnes, commanding an extensive view. The valley of Ossau, one of the most beautiful in the Pyrenees, before the Revolution formed a community which, though dependent on Béarn, had its own legal organization, manners and costumes, the last of which are still to be seen on holidays.

EAVES (not a plural form as is sometimes supposed, but singular; O. Eng. *efes*, in Mid. High Ger. *obse*, Gothic *ubiswa*, a porch; connected with "over"), in architecture, the projecting edge of a sloping roof, which overhangs the face of the wall so as to throw off the water.

EAVESDRIIP, or **EAVESDROP**, that width of ground around a house or building which receives the rain water dropping from the eaves. By an ancient Saxon law, a landowner was forbidden to erect any building at less than 2 ft. from the boundary of his land, and was thus prevented from injuring his neighbour's house or property by the dripping of water from his eaves. The law of Eavesdrip has had its equivalent in the Roman *stillicidium*, which prohibited building up to the very edge of an estate.

From the Saxon custom arose the term "eavesdropper," i.e. any one who stands within "the eavesdrop" of a house, hence one who pries into others' business or listens to secrets. At common law an eavesdropper was regarded as a common nuisance, and was presentable at the court leet, and indictable at the sheriff's tourn and punishable by fine and finding sureties for good behaviour. Though the offence of eavesdropping still exists at common law, there is no modern instance of a prosecution or indictment.

EBBW VALE, an urban district in the western parliamentary division of Monmouthshire, England, 21 m. N.W. of Newport on the Great Western, London & North-Western and Rhymney railways. Pop. (1891) 17,312; (1901) 20,994. It lies near the head of the valley of the river Ebbw, at an elevation of nearly 1000 ft., in a wild and mountainous mining district, which contains large collieries and important iron and steel works.

EBEL, HERMANN WILHELM (1820-1875), German philologist, was born at Berlin on the 10th of May 1820. He displayed in his early years a remarkable capacity for the study of languages, and at the same time a passionate fondness for music and poetry. At the age of sixteen he became a student at the university of Berlin, applying himself especially to philology, and attending the lectures of Böckh. Music continued to be the favourite occupation of his leisure hours, and he pursued the study of it under the direction of Marx. In the spring of 1838 he passed to the university of Halle, and there began to apply himself to comparative philology under Pott. Returning in the following year to his native city, he continued this study as a disciple of Bopp. He took his degree in 1842, and, after spending his year of probation at the French Gymnasium of Berlin, he resumed with great earnestness his language studies. About 1847 he began to study Old Persian. In 1852 he accepted a professorship at the Behem-Schwarzbach Institution at Filchne, which post he held for six years. It was during this period that his studies in the Old Slavic and Celtic languages began. In 1858 he removed to Schneidemühl, and there he discharged the duties of first professor for ten years. He was afterwards called to the chair of comparative philology at the university of Berlin. He died at Misdroy on the 10th of August 1875. The most important work of Dr Ebel in the field of Celtic philology is his revised edition of the *Grammatica Celtica* of Professor Zeuss, completed in 1871. This had been preceded by his treatises—*De verbis Britannici futura ac conjunctivo* (1866), and *De Zeussii curis positis in Grammatica Celtica* (1866). He made many learned contributions to Kühn's *Zeitschrift für vergleichende Sprachforschung*, and to A. Schleicher's *Beiträge zur vergleichenden*

Sprachforschung; and a selection of these contributions was translated into English by Sullivan, and published under the title of *Celtic Studies* (1863). Ebel contributed the Old Irish section to Schleicher's *Indogermanische Chrestomathie* (1869). Among his other works must be named *Die Lehnwörter der deutschen Sprache* (1856).

EBEL, JOHANN GOTTFRIED (1764-1830), the author of the first real guide-book to Switzerland, was born at Züllichau (Prussia). He became a medical man, visited Switzerland for the first time in 1790, and became so enamoured of it that he spent three years exploring the country and collecting all kinds of information relating to it. The result was the publication (Zürich, 1793) of his *Anleitung auf die nützlichste und genussvollste Art in der Schweiz zu reisen* (2 vols.), in which he gave a complete account of the country, the General Information sections being followed by an alphabetically arranged list of places, with descriptions. It at once superseded all other works of the kind, and was the best Swiss guide-book till the appearance of "Murray" (1838). It was particularly strong on the geological and historical sides. The second (1804-1805) and third (1809-1810) editions filled four volumes, but the following (the 8th appeared in 1843) were in a single volume. The work was translated into French in 1795 (many later editions) and into English (by 1818). Ebel also published a work (2 vols., Leipzig, 1798-1802) entitled *Schilderungen der Gebirgswälder der Schweiz*, which deals mainly with the pastoral cantons of Glarus and Appenzell. In 1801 he was naturalized a Swiss citizen, and settled down in Zürich. In 1808 he issued his chief geological work, *Über den Bau der Erde im Alpengebirge* (Zürich, 2 vols.). He took an active share in promoting all that could make his adopted country better known, e.g. Heinrich Keller's map (1813), the building of a hotel on the Rigi (1816), and the preparation of a panorama from that point (1823). From 1810 onwards he lived at Zürich, with the family of his friend, Conrad Escher von der Linth (1767-1823), the celebrated engineer. (W. A. B. C.)

EBER, PAUL (1511-1569), German theologian, was born at Kitzingen in Franconia, and was educated at Nuremberg and Wittenberg, where he became the close friend of Philip Melancthon. In 1541 he was appointed professor of Latin grammar at Wittenberg, and in 1557 professor of the Old Testament. His range of learning was wide, and he published a handbook of Jewish history, a historical calendar intended to supersede the Roman Saints' Calendar, and a revision of the Latin Old Testament. In the theological conflict of the time he played a large part, doing what he could to mediate between the extremists. From 1559 to the close of his life he was superintendent-general of the electorate of Saxony. He attained some fame as a hymn-writer, his best-known composition being "Wenn wir in höchsten Nöthen sein." He died at Wittenberg on the 10th of December 1569.

EBERBACH, a town of Germany, in the grand-duchy of Baden, romantically situated on the Neckar, at the foot of the Katzenbuckel, 19 m. E. of Heidelberg by the railway to Würzburg. Pop. (1900) 5857. It contains an Evangelical and a Roman Catholic church, a commercial and a technical school, and, in addition to manufacturing cigars, leather and cutlery, carries on by water an active trade in timber and wine. Eberbach was founded in 1227 by the German king Henry VII., who acquired the castle (the ruins of which overhang the town) from the bishop of Worms. It became an imperial town and passed later to the Palatinate.

See Wirth, *Geschichte der Stadt Eberbach* (Stuttgart, 1864).

EBERBACH, a famous Cistercian monastery of Germany, in the Prussian province of Hesse-Nassau, situated near Hattenheim in the Rheingau, 10 m. N.W. from Wiesbaden. Founded in 1116 by Archbishop Adalbert of Mainz, as a house of Augustinian canons regular, it was bestowed by him in 1131 upon the Benedictines, but was shortly afterwards repurchased and conferred upon the Cistercian order. The Romanesque church (consecrated in 1186) contains numerous interesting monuments and tombs, notable among them being those of the archbishop of Mainz,

Gerlach (d. 1371) and Adolph II. of Nassau (d. 1475). It was despoiled during the Thirty Years' War, was secularized in 1803, and now serves as a house of correction. Its cellars contain some of the finest vintages of the Rhine wines of the locality.

See Bär, *Diplomatische Geschichte der Abtei Eberbach* (Wiesb., 1851-1858 and 1886, 3 vols.), and Schäfer, *Die Abtei Eberbach im Mittelalter* (Berlin, 1901).

EBERHARD, surnamed **IM BART** (*Barbatus*), count and afterwards duke of Württemberg (1445-1496), was the second son of Louis I., count of Württemberg-Urach (d. 1450), and succeeded his elder brother Louis II. in 1457. His uncle Ulrich V., count of Württemberg-Stuttgart (d. 1480), acted as his guardian, but in 1459, assisted by Frederick I., elector palatine, he threw off this restraint, and undertook the government of the district of Urach as Count Eberhard V. He neglected his duties as a ruler and lived a reckless life until 1468, when he made a pilgrimage to Jerusalem. He visited Italy, became acquainted with some famous scholars, and in 1474 married Barbara di Gonzaga, daughter of Lodovico III., marquis of Mantua, a lady distinguished for her intellectual qualities. In 1482 he brought about the treaty of Münsingen with his cousin Eberhard VI., count of Württemberg-Stuttgart. By this treaty the districts of Urach and Stuttgart into which Württemberg had been divided in 1437 were again united, and for the future the county was declared indivisible, and the right of primogeniture established. The treaty led to some disturbances, but in 1492 the sanction of the nobles was secured for its provisions. In return for this Eberhard agreed to some limitations on the power of the count, and so in a sense founded the constitution of Württemberg. At the diet of Worms in 1495 the emperor Maximilian I. guaranteed the treaty, confirmed the possessions and prerogatives of the house of Württemberg, and raised Eberhard to the rank of duke. Eberhard, although a lover of peace, was one of the founders of the Swabian League in 1488, and assisted to release Maximilian, then king of the Romans, from his imprisonment at Bruges in the same year. He gave charters to the towns of Stuttgart and Tübingen, and introduced order into the convents of his land, some of which he secularized. He took a keen interest in the new learning, founded the university of Tübingen in 1476, befriended John Reuchlin, whom he made his private secretary, welcomed scholars to his court, and is said to have learned Latin in later life. In 1482 he again visited Italy and received the Golden Rose from Pope Sixtus IV. He won the esteem of the emperors Frederick III. and Maximilian I. on account of his wisdom and fidelity, and his people held him in high regard. His later years were mainly spent at Stuttgart, but he died at Tübingen on the 25th of February 1496, and in 1537 his ashes were placed in the choir of the Stiftskirche there. Eberhard left no children, and the succession passed to his cousin Eberhard, who became Duke Eberhard II.

See Röslein, *Leben Eberhards im Barte* (Tübingen, 1793); Bossert, *Eberhard im Bart* (Stuttgart, 1884).

EBERHARD, CHRISTIAN AUGUST GOTTLÖB (1769-1845), German miscellaneous writer, was born at Belzig, near Wittenberg, on the 12th of January 1769. He studied theology at Leipzig; but, a story he contributed to a periodical having proved successful, he devoted himself to literature. With the exception of *Harnschen und die Küchlein* (1822), a narrative poem in ten parts, and an epic on the Creation, *Der erste Mensch und die Erde* (1828), Eberhard's work was ephemeral in character and is now forgotten. He died at Dresden on the 13th of May 1845.

His collected works (*Gesammelte Schriften*) appeared in 20 volumes in 1830-1831.

EBERHARD, JOHANN AUGUSTUS (1739-1809), German theologian and philosopher, was born at Halberstadt in Lower Saxony, where his father was singing-master at the church of St Martin's, and teacher of the school of the same name. He studied theology at the university of Halle, and became tutor to the eldest son of the baron von der Horst, to whose family he attached himself for a number of years. In 1763 he was appointed con-rector of the school of St Martin's, and second preacher in the hospital church of the Holy Ghost; but he soon

afterwards resigned these offices and followed his patron to Berlin. There he met Nicolai and Moses Mendelssohn, with whom he formed a close friendship. In 1768 he became preacher or chaplain to the workhouse at Berlin and the neighbouring fishing village of Stralow. Here he wrote his *Neue Apologie des Sokrates* (1772), a work occasioned by an attack on the fifteenth chapter of Marmontel's *Belisarius* made by Peter Hofstede, a clergyman of Rotterdam, who maintained the patristic view that the virtues of the noblest pagans were only *splendida peccata*. Eberhard stated the arguments for the broader view with dignity, acuteness and learning, but the liberality of the reasoning gave great offence to the strictly orthodox divines, and is believed to have obstructed his preferment in the church.

In 1774 he was appointed to the living of Charlottenburg. A second volume of his *Apologie* appeared in 1778. In this he not only endeavoured to obviate some objections which were taken to the former part, but continued his inquiries into the doctrines of the Christian religion, religious toleration and the proper rules for interpreting the Scriptures. In 1778 he accepted the professorship of philosophy at Halle. As an academical teacher, however, he was unsuccessful. His powers as an original thinker were not equal to his learning and his literary gifts, as was shown in his opposition to the philosophy of Kant. In 1786 he was admitted a member of the Berlin Academy of Sciences; in 1805 the king of Prussia conferred upon him the honorary title of a privy-councillor. In 1808 he obtained the degree of doctor in divinity, which was given him as a reward for his theological writings. He died on the 6th of January 1809. He was master of the learned languages, spoke and wrote French with facility and correctness, and understood English, Italian and Dutch. He possessed a just and discriminating taste for the fine arts, and was a great lover of music.

Works.—*Neue Apologie des Sokrates*, &c. (2 vols., 1772-1778); *Allgemeine Theorie des Denkens und Empfindens*, &c. (Berlin, 1776), an essay which gained the prize assigned by the Royal Society of Berlin for that year; *Vom dem Begriff der Philosophie und ihren Theilen* (Berlin, 1778)—a short essay, in which he announced the plan of his lectures on being appointed to the professorship at Halle; *Lobschrift auf Herrn Johann Thunmann Prof. der Weltweisheit und Beredsamkeit auf der Universität zu Halle* (Halle, 1779); *Amyntor, eine Geschichte in Briefen* (Berlin, 1782)—written with the view of counteracting the influence of those sceptical and Epicurean principles in religion and morals then so prevalent in France, and rapidly spreading amongst the higher ranks in Germany; *Über die Zeichen der Aufklärung einer Nation*, &c. (Halle, 1783); *Theorie der schönen Künste und Wissenschaften*, &c. (Halle, 1783, 3rd ed. 1790); *Vermischte Schriften* (Halle, 1784); *Neue vermischte Schriften* (ib. 1786); *Allgemeine Geschichte der Philosophie*, &c. (Halle, 1788), 2d ed. with a continuation and chronological tables (1796); *Versuch einer allgemeinen-deutschen Synonymik* (Halle and Leipzig, 1795-1802, 6 vols., 4th ed. 1825-1835), long reckoned the best work on the synonymy of the German language (an abridgment of it was published by the author in one large volume, Halle, 1802); *Handbuch der Aesthetik* (Halle, 1803-1805, 2nd ed. 1807-1820). He also edited the *Philosophisches Magazin* (1788-1792) and the *Philosophisches Archiv* (1792-1795).

See F. Nicolai, *Gedächtnisschrift auf J. A. Eberhard* (Berlin and Stettin, 1810); also K. H. Jördens, *Lexicon deutscher Dichter und Prosaisten*.

EBERLIN, JOHANN ERNST (1702-1762), German musician and composer, was born in Bavaria, and became afterwards organist in the cathedral at Salzburg, where he died. Most of his compositions were for the church (oratorios, &c.), but he also wrote some important fugues, sonatas and preludes; and his pieces were at one time highly valued by Mozart.

EBERS, GEORG MORITZ (1837-1898), German Egyptologist and novelist, was born in Berlin on the 1st of March 1837. At Göttingen he studied jurisprudence, and at Berlin oriental languages and archaeology. Having made a special study of Egyptology, he became in 1865 *docent* in Egyptian language and antiquities at Jena, and in 1870 he was appointed professor in these subjects at Leipzig. He had made two scientific journeys to Egypt, and his first work of importance, *Ägypten und die Bücher Moses*, appeared in 1867-1868. In 1874 he edited the celebrated medical papyrus ("Papyrus Ebers") which he had discovered in Thebes (translation by H. Joachim, 1890). Ebers early conceived the idea of popularizing Egyptian lore by means of historical romances. *Eine ägyptische Königstochter* was

published in 1864, and obtained great success. His subsequent works of the same kind—*Uarda* (1877), *Homo sum* (1878), *Die Schwestern* (1880), *Der Kaiser* (1881), of which the scene is laid in Egypt at the time of Hadrian, *Serapis* (1885), *Die Nilbräut* (1887), and *Kleopatra* (1894), were also well received, and did much to make the public familiar with the discoveries of Egyptologists. Ebers also turned his attention to other fields of historical fiction—especially the 16th century (*Die Frau Bürgermeisterin*, 1882; *Die Gred*, 1887)—without, however, attaining the success of his Egyptian novels. Apart from their antiquarian and historical interest, Ebers's books have not a very high literary value. His other writings include a descriptive work on Egypt (*Ägypten in Wort und Bild*, 2nd ed., 1880), a guide to Egypt (1886) and a life (1885) of his old teacher, the Egyptologist Karl Richard Lepsius. The state of his health led him in 1889 to retire from his chair at Leipzig on a pension. He died at Tutzing in Bavaria, on the 7th of August 1898.

Ebers's *Gesammelte Werke* appeared in 25 vols. at Stuttgart (1893–1895). Many of his books have been translated into English. For his life see his *Die Geschichte meines Lebens* (Stuttgart, 1893); also R. Cosche, *G. Ebers, der Forscher und Dichter* (2nd ed., Leipzig, 1887).

EBERSWALDE, a town of Germany, in the kingdom of Prussia, 28 m. N.E. of Berlin by rail; on the Finow canal. Pop. (1905) 23,876. The town has a Roman Catholic and two Evangelical churches, a school of forestry, a gymnasium, a higher-grade girls' school and two schools of domestic economy. It possesses a mineral spring, which attracts numerous summer visitors, and has various industries, which include iron-founding and the making of horse-shoe nails, roofing material and bricks. A considerable trade is carried on in grain, wood and coals. In the immediate neighbourhood are one of the chief brass-foundries in Germany and an extensive government paper-mill, in which the paper for the notes of the imperial bank is manufactured.

Eberswalde received its municipal charter in 1257. It was taken and sacked during the Thirty Years' War. In 1747 Frederick the Great brought a colony of Thuringian cutlers to the town, but this branch of industry has entirely died out. About 4 m. to the north lies the old Cistercian monastery of Chorin, the fine Gothic church of which contains the tombs of several margraves of Brandenburg.

EBERT, FRIEDRICH ADOLF (1791–1834), German bibliographer, was born at Taucha, near Leipzig, on the 9th of July 1791, the son of a Lutheran pastor. At the age of fifteen he was appointed to a subordinate post in the municipal library of Leipzig. He studied theology for a short time at Leipzig, and afterwards philology at Wittenberg, where he graduated doctor in philosophy in 1812. While still a student he had already published, in 1811, a work on public libraries, and in 1812 another work entitled *Hierarchia in religionem ac literas commoda*. In 1813 he was attached to the Leipzig University library, and in 1814 was appointed secretary to the Royal library of Dresden. The same year he published *F. Taubmanns Leben und Verdienste*, and in 1819 *Torquato Tasso*, a translation from Pierre Louis Ginguéné with annotations. The rich resources open to him in the Dresden library enabled him to undertake the work on which his reputation chiefly rests, the *Allgemeines bibliographisches Lexikon*, the first volume of which appeared in 1821 and the second in 1830. This was the first work of the kind produced in Germany, and the most scientific published anywhere. From 1823 to 1825 Ebert was librarian to the duke of Brunswick at Wolfenbüttel, but returning to Dresden was made, in 1827, chief librarian of the Dresden Royal library. Among his other works are—*Die Bildung des Bibliothekars* (1820), *Geschichte und Beschreibung der königlichen öffentlichen Bibliothek in Dresden* (1822), *Zwei Handschriftenkunde* (1825–1827), and *Culturperioden des obersächsischen Mittelalters* (1825). Ebert was a contributor to various journals and took part in the editing of Ersch and Gruber's great encyclopaedia. He died at Dresden on the 13th of November 1834, in consequence of a fall from the ladder in his library.

See the article in *Ersch und Grubers Encyclopädie*, and that in the *Allg. deutsche Biog.* by his successor in the post of chief librarian in Dresden, Schnorr von Carolsfeld.

EBINGEN, a town of Germany, in the kingdom of Württemberg, on the Schmiecha, a left-hand tributary of the Danube, 22 m. S. of Tübingen and 37 m. W. of Ulm by rail. It manufactures velvet and cotton-velvet ("Manchester") goods, stockings, stays, hats, needles, tools, &c. There are also tanneries. Pop. 900.

EBIONITES (Heb. עֲבִיּוֹנִים, "poor men"), a name given to the ultra-Jewish party in the early Christian church. It is first met with in Irenaeus (*Adv. Haer.* i. 26. 2), who sheds no light on the origin of the Ebionites, but says that while they admit the world to have been made by the true God (in contrast to the Demiurge of the Gnostics), they held Cerinthian views on the person of Christ, used only the Gospel of Matthew (probably the Gospel according to the Hebrews—so Eusebius), and rejected Paul as an apostate from the Mosaic Law, to the customs and ordinances of which, including circumcision, they steadily adhered. A similar account is given by Hippolytus (*Haer.* vii. 35), who invents a founder named Ebion. Origen (*Contra Celsum*, v. 6r; *In Matt.* tom. xvi. 12) divides the Ebionites into two classes according to their acceptance or rejection of the virgin birth of Jesus, but says that all alike reject the Pauline epistles. This is confirmed by Eusebius, who adds that even those who admitted the virgin birth did not accept the pre-existence of Jesus as Logos and Sophia. They kept both the Jewish Sabbath and the Christian Lord's day, and held extreme millenarian ideas in which Jerusalem figured as the centre of the coming Messianic kingdom. Epiphanius with his customary confusion makes two separate sects, Ebionites and Nazarenes. Both names, however, refer to the same people! (the Jewish Christians of Syria), the latter going back to the designation of apostolic times (*Acts* xxiv. 5), and the former being the term usually applied to them in the ecclesiastical literature of the 2nd and 3rd centuries.

The origin of the Nazarenes or Ebionites as a distinct sect is very obscure, but may be dated with much likelihood from the edict of Hadrian which in 135 finally scattered the old church of Jerusalem. While Christians of the type of Aristo of Pella and Hegesippus, on the snapping of the old ties, were gradually assimilated to the great church outside, the more conservative section became more and more isolated and exclusive. "It may have been then that they called themselves the Poor Men, probably as claiming to be the true representatives of those who had been blessed in the Sermon on the Mount, but possibly adding to the name other associations." Out of touch with the main stream of the church they developed a new kind of pharisaism. Doctrinally they stood not so much for a theology as for a refusal of theology, and, rejecting the practical liberalism of Paul, became the natural heirs of those early Judaizers who had caused the apostle so much annoyance and trouble.

Though there is insufficient justification for dividing the Ebionites into two separate and distinct communities, labelled respectively Ebionites and Nazarenes, we have good evidence, not only that there were grades of Christological thought among them, but that a considerable section, at the end of the 2nd century and the beginning of the 3rd, exchanged their simple Judaistic creed for a strange blend of Essenism and Christianity. These are known as the Helxaites or Elchasaïtes, for they accepted as a revelation the "book of Elchasaï," and one Alcibiades of Apamea undertook a mission to Rome about 220 to propagate its teaching. It was claimed that Christ, as an angel 96 miles high, accompanied by the Holy Spirit, as a female angel of the same stature, had given the revelation to Elchasaï in the 3rd year of Trajan (A.D. 100), but the book was probably quite new in Alcibiades' time. It taught that Christ was an angel born of human parents, and had appeared both before (e.g. in Adam and Moses) and after this birth in Judea. His coming did not annul the Law, for he was merely a prophet and teacher; Paul was wrong and circumcision still necessary. Baptism must be repeated as a means of purification from sin, and proof against disease; the sinner immerses himself "in the name of the mighty

¹ So A. Harnack, *Hist. of Dogma*, i. 301, and F. J. A. Hort, *Judaistic Christianity*, p. 199. Th. Zahn and J. B. Lightfoot ("St. Paul and the Three," in *Commentary on Galatians*) maintain the distinction.

and most high God " invoking the " seven witnesses " (sky, water, the holy spirits, the angels of prayer, oil, salt and earth), and pledging himself to amendment. Abstinence from flesh was also enjoined, and a good deal of astrological fancy was interwoven with the doctrinal and practical teaching. It is highly probable, too, that from these Easene Ebionites there issued the fantastical and widely read " Clementine " literature (*Homilies* and *Recognitions*) of the 3rd century. Ebionite views lingered especially in the country east of the Jordan until they were absorbed by Islam in the 7th century.

In addition to the literature cited see R. C. Ottley, *The Doctrine of the Incarnation*, part iii. § ii.; W. Moeller, *Hist. of the Christian Church*, i. 99; art. in Herzog-Hauck, *Realencyclopädie*, s.v. " Ebioniten "; also CLEMENTINE LITERATURE.

EBNER-ESCHENBACH, MARIE, FRIEDRAU VON (1830-), Austrian novelist, was born at Zdislavč in Moravia, on the 13th of September 1830, the daughter of a Count Dubsky. She lost her mother in early infancy, but received a careful intellectual training from two stepmothers. In 1848 she married the Austrian captain, and subsequent field-marshal, Moritz von Ebner-Eschenbach, and resided first at Vienna, then at Klosterbruck, where her husband had a military charge, and after 1860 again at Vienna. The marriage was childless, and the talented wife sought consolation in literary work. In her endeavours she received assistance and encouragement from Franz Grillparzer and Freiherr von Münch-Bellinghausen. Her first essay was with the drama *Maria Stuart in Schottland*, which Philipp Eduard Devrient produced at the Karlsruhe theatre in 1860. After some other unsuccessful attempts in the field of drama, she found her true sphere in narrative. Commencing with *Die Prinzessin von Banasien* (1872), she graphically depicts in *Božena* (Stuttgart, 1876, 4th ed. 1890) and *Das Gemeindekind* (Berlin, 1887, 4th ed. 1900) the surroundings of her Moravian home, and in *Lotti, die Uhrmacherin* (Berlin, 1883, 4th ed. 1900), *Zwei Comtessen* (Berlin, 1885, 5th ed. 1898), *Unsühnbar* (1890, 5th ed. 1900) and *Glaubenslos?* (1893) the life of the Austrian aristocracy in town and country. She also published *Neue Erzählungen* (Berlin, 1881, 3rd ed. 1894), *Aphorismen* (Berlin, 1880, 4th ed. 1895) and *Parabeln, Märchen und Gedichte* (2nd ed., Berlin, 1892). Frau von Ebner-Eschenbach's elegance of style, her incisive wit and masterly depiction of character give her a foremost place among the German women-writers of her time. On the occasion of her seventieth birthday the university of Vienna conferred upon her the degree of doctor of philosophy, *honoris causa*.

An edition of Marie von Ebner-Eschenbach's *Gesammelte Schriften* began to appear in 1893 (Berlin). See A. Bettelheim, *Marie von Ebner-Eschenbachs biographische Blätter* (Berlin, 1900), and M. Necker, *Marie von Ebner-Eschenbach nach ihren Werken geschildert* (Berlin, 1900).

EBOLI (anc. *Eburum*), a town of Campania, Italy, in the province of Salerno, from which it is 16 m. E. by rail, situated 470 ft. above sea-level, on the S. edge of the hills overlooking the valley of the Sele. Pop. (1901) 9642 (town), 12,423 (commune). The sacristy of St Francesco contains two 14th-century pictures, one by Roberto da Oderisio of Naples. The ancient Eburum was a Lucanian city, mentioned only by Pliny and in inscriptions, not far distant from the Campanian border. It lay above the Via Popillia, which followed the line taken by the modern railway. Some scanty remains of its ancient polygonal walls may still be seen. (T. As.)

EBONY (Gr. *ἔβρον*), the wood of various species of trees of the genus *Diospyros* (natural order Ebenaceae), widely distributed in the tropical parts of the world. The best kinds are very heavy, are of a deep black, and consist of heart-wood only. On account of its colour, durability, hardness and susceptibility of polish, ebony is much used for cabinet work and inlaying, and for the manufacture of pianoforte-keys, knife-handles and turned articles. The best Indian and Ceylon ebony is furnished by *D. Ebenum*, a native of southern India and Ceylon, which grows in great abundance throughout the flat country west of Trincomalee. The tree is distinguished from others by the inferior width of its trunk, and its jet-black, charred-looking

bark, beneath which the wood is perfectly white until the heart is reached. The wood is stated to excel that obtained from *D. reticulata* of the Mauritius and all other varieties of ebony in the fineness and intensity of its dark colour. Although the centre of the tree alone is employed, reduced logs 1 to 3 ft. in diameter can readily be procured. Most of the East Indian ebony is yielded by the species *D. Melanosylon* (Coromandel ebony), a large tree attaining a height of 60 to 80 ft., and 8 to 10 ft. in circumference, with irregular rigid branches, and oblong or oblong-lanceolate leaves. The bark of the tree is astringent, and mixed with pepper is used in dysentery by the natives of India. The wood of *D. tomentosa*, a native of north Bengal, is black, hard and of great weight. *D. montana*, another Indian species, produces a yellowish-grey soft but durable wood. *D. quersita* is the tree from which is obtained the wood known in Ceylon by the name *Calamander*, derived by Pridham from the Sinhalee *kalumindrie*, black-flowing. Its closeness of grain, great hardness and fine hazel-brown colour, mottled and striped with black, render it a valuable material for veneering and furniture making. *D. Dendo*, a native of Angola, is a valuable timber tree, 25 to 35 ft. high, with a trunk 1 to 2 ft. in diameter. The heart-wood is very black and hard and is known as black ebony, also as billet-wood, and Gabun, Lagos, Calabar or Niger ebony. What is termed Jamaica or West Indian ebony, and also the green ebony of commerce, are produced by *Brya Ebenus*, a leguminous tree or shrub, having a trunk rarely more than 4 in. in diameter, flexible spiny branches, and orange-yellow, sweet-scented flowers. The heart-wood is rich dark brown in colour, heavier than water, exceedingly hard and capable of receiving a high polish.

From the book of Ezekiel (xxvii. 15) we learn that ebony was among the articles of merchandise brought to Tyre; and Herodotus states (iii. 97) that the Ethiopians every three years sent a tribute of 200 logs of it to Persia. Ebony was known to Virgil as a product of India (*Georg.* ii. 116), and was displayed by Pompey the Great in his Mithradatic triumph at Rome. By the ancients it was esteemed of equal value for durability with the cypress and cedar (see Pliny, *Nat. Hist.* xii. 9, xvi. 79). According to Solinus (*Polyhistor*, cap. lv. p. 353, Paris, 1621), it was employed by the kings of India for sceptres and images, also, on account of its supposed antagonism to poison, for drinking-cups. The hardness and black colour of the wood appear to have given rise to the tradition related by Pausanias, and alluded to by Southey in *Thalaba*, l. 22, that the ebony tree produced neither leaves nor fruit, and was never seen exposed to the sun.

EBRARD, JOHANNES HEINRICH AUGUST (1818-1888), German theologian, was born at Erlangen on the 18th of January 1818. He was educated in his native town and at Berlin, and after teaching in a private family became *Privatdocent* at Erlangen (1841) and then professor of theology at Zürich (1844). In 1847 he was appointed professor of theology at Erlangen, a chair which he resigned in 1861; in 1875 he became pastor of the French reformed church in the same city. As a critic Ebrard occupied a very moderate standpoint; as a writer his chief works were *Christliche Dogmatik* (2 vols., 1851), *Vorlesungen über praktische Theologie* (1864), *Apologetik* (1874-1875, Eng. trans. 1886). He also edited and completed H. Olshausen's commentary, himself writing the volumes on the Epistle to the Hebrews, the Johannine Epistles, and Revelation. In the department of belles-lettres he wrote a good deal under such pseudonyms as Christian Deutsch, Gottfried Flammberg and Sigmund Sturm. He died at Erlangen on the 23rd of July 1888.

EBRO (anc. *Iberus* or *Hiberus*), the only one of the five great rivers of the Iberian Peninsula (Tagus, Douro, Ebro, Guadalquivir, Guadiana) which flows into the Mediterranean. The Ebro rises at Fuentibre, a hamlet among the Cantabrian Mountains, in the province of Santander; at Reinosa, 4 m. east, it is joined on the right by the Hija, and thus gains considerably in volume. It flows generally east by south through a tortuous valley as far as Miranda de Ebro, passing through the celebrated Roman bridge known as La Horadada (" the perforated "), near Oña in Burgos. From Miranda it winds south-eastward through

the wide basin enclosed on the right by the highlands of Old Castile and western Aragon, and on the left by the Pyrenees. The chief cities on its banks are Logroño, Calahorra, Tudela, Saragossa and Caspe. Near Mora in Catalonia it forces a way through the coastal mountains, and, passing Tortosa, falls into the Mediterranean about 80 m. south-west of Barcelona, after forming by its delta a conspicuous projection on the otherwise regular coast line. In its length, approximately 465 m., the Ebro is inferior to the Tagus, Guadiana and Douro; it drains an area of nearly 32,000 sq. m. Its principal tributaries are—from the right hand the Jalon with its affluent the Jiloca, the Huerva, Aguas, Martín, Guadalope and Matarrana; from the left the Ega, Aragon, Arba, Gallego, and the Segre with its intricate system of confluent rivers. The Ebro and its tributaries have been utilized for irrigation since the Moorish conquest; the main stream becomes navigable by small boats about Tudela; but its value as a means of communication is almost neutralized by the obstacles in its channel, and seafaring vessels cannot proceed farther up than Tortosa. The great Imperial Canal, begun under the emperor Charles V. (1500-1558), proceeds along the right bank of the river from a point about 3 m. below Tudela, to El Burgo de Ebro, 5 m. below Saragossa; the irrigation canal of Tauste skirts the opposite bank for a shorter distance; and the San Carlos or New Canal affords direct communication between Amposta at the head of the delta and the harbour of Los Alfaques. From Miranda to Mora the Bilbao-Tarragona railway follows the course of the Ebro along the right bank.

EBROÏN (d. 681), Frankish "mayor of the palace," was a Neustrian, and wished to impose the authority of Neustria over Burgundy and Austrasia. In 656, at the moment of his accession to power, Sigebert III., the king of Austrasia, had just died, and the Austrasian mayor of the palace, Grimoald, was attempting to usurp the authority. The great nobles, however, appealed to the king of Neustria, Clovis II., and unity was re-established. But in spite of a very firm policy Ebroïn was unable to maintain this unity, and while Clotaire III., son of Clovis II., reigned in Neustria and Burgundy, he was obliged in 660 to give the Austrasians a special king, Childeric II., brother of Clotaire III., and a special mayor of the palace, Wulfoald. He endeavoured to maintain at any rate the union of Neustria and Burgundy, but the great Burgundian nobles wished to remain independent, and rose under St Leger (Leodegar), bishop of Autun, defeated Ebroïn, and interned him in the monastery of Luxeuil (670). A proclamation was then issued to the effect that each kingdom should keep its own laws and customs, that there should be no further interchange of functionaries between the kingdoms, and that no one should again set up a tyranny like that of Ebroïn. Soon, however, Leger was defeated by Wulfoald and the Austrasians, and was himself confined at Luxeuil in 673. In the same year, taking advantage of the general anarchy, Ebroïn and Leger left the cloister and soon found themselves once more face to face. Each looked for support to a different Merovingian king, Ebroïn even proclaiming a false Merovingian as sovereign. In this struggle Leger was vanquished; he was besieged in Autun, was forced to surrender and had his eyes put out, and, on the 12th of October 678, he was put to death after undergoing prolonged tortures. The church honours him as a saint. After his death Ebroïn became sole and absolute ruler of the Franks, imposing his authority over Burgundy and subduing the Austrasians, whom he defeated in 678 at Bois-du-Fay, near Laon. His triumph, however, was short-lived; he was assassinated in 681, the victim of a combined attack of his numerous enemies. He was a man of great energy, but all his actions seem to have been dictated by no higher motives than ambition and lust of power.

See *Liber historiae Francorum*, edited by B. Krusch, in *Mon. Germ. hist. script. rer. Merov.* vol. ii.; *Vita sancti Leodegarii*, by Ursinus, a monk of St Maixent (Migne, *Patr. Latina*, vol. xcvi.); "Vita metrica" in *Poëticæ Latiniæ veti Carolini*, vol. iii. (*Mon. Germ. hist.*); J. B. Pitra, *Histoire de Saint Leger* (Paris, 1846); and J. Friedrich, "Zur Gesch. des Hausmeiers Ebroïn," in the *Proceedings of the Academy of Munich* (1887, pp. 42-61). (C. Ff.)

EBURACUM, or **EBORACUM** (probably a later variant), the Roman name of York (q.v.) in England. Established about A.D.

75-80 as fortress of the Ninth legion and garrisoned (after the annihilation of that legion about A.D. 118) by the Sixth legion, it developed outside its walls a town of civil life, which later obtained Roman municipal rank and in the 4th century was the seat of a Christian bishop. The fortress and town were separated by the Ouse. On the left bank, where the minster stands, was the fortress, of which the walls can still be partly traced, and one corner (the so-called Multangular Tower) survives. The municipality occupied the right bank near the present railway station. The place was important for its garrison and as an administrative centre, and the town itself was prosperous, though probably never very large. The name is preserved in the abbreviated form Ebor in the official name of the archbishop of York, but the philological connexion between Eboracum and the modern name York is doubtful and has probably been complicated by Danish influence. (F. J. H.)

EÇA DE QUEIROZ, JOSÉ MARIA (1843-1900), Portuguese writer, was born at the northern fishing town of Povoa de Varzim, his father being a retired judge. He went through the university of Coimbra, and on taking his degree in law was appointed Administrador de Concelho at Leiria, but soon tired of the narrow mental atmosphere of the old cathedral town and left it. He accompanied the Conde de Rezende to Egypt, where he assisted at the opening of the Suez Canal, and to Palestine, and on his return settled down to journalism in Lisbon and began to evolve a style, at once magical and unique, which was to renovate his country's prose. Though he spent much of his days with the philosopher sonneteer Anthero de Quental, and the critic Jayme Batalha Reis, afterwards consul-general in London, he did not restrict his intimacy to men of letters, but frequented all kinds of society, acquiring a complete acquaintance with contemporary Portuguese life and manners. Entering the consular service in 1872, he went to Havana, and, after a tour in the United States, was transferred two years later to Newcastle-on-Tyne and in 1876 to Bristol. In 1888 he became Portuguese consul-general in Paris, and there died in 1900.

Queiroz made his literary début in 1870 by a sensational story, *The Mystery of the Cintra Road*, written in collaboration with the art critic Ramalho Ortigão, but the first publication which brought him fame was *The Forças*, a series of satirical and humorous sketches of various phases of social life, which, to quote the poet Guerra Junqueiro, contain "the epilepsy of talent." These essays, the joint production of the same partners, criticized and ridiculed the faults and foibles of every class in turn, mainly by a comparison with the French, for the education of Queiroz had made him a Frenchman in ideas and sympathies. His Brazilian friend, Eduardo Prado, bears witness that at this period French literature, especially Hugo's verse, and even French politics, interested Queiroz profoundly, while he altogether ignored the *belles-lettres* of his own country and its public affairs. This phase lasted for some years, and even when he travelled in the East he was inclined to see it with the eyes of Flaubert, though the publication of *The Relic* and that delightful prose poem *Sweet Miracle* afterwards showed that he had been directly impressed and deeply penetrated by its scenery, poetry and mysticism. The Franco-German War of 1870, however, by lowering the prestige of France, proved the herald of a national Portuguese revival, and had a great influence on Queiroz, as also had his friend Oliveira Martins (q.v.), the biographer of the patriot kings of the Avis dynasty. He founded the Portuguese Realist-Naturalist school, of which he remained for the rest of his life the chief exponent, by a powerful romance, *The Crime of Father Amaro*, written in 1871 at Leiria but only issued in 1875. Its appearance then led to a baseless charge that he had plagiarized *La Faute de l'Abbé Mowet*, and ill-informed critics began to name Queiroz the Portuguese Zola, though he clearly occupied an altogether different plane in the domain of art. During his stay in England he produced two masterpieces, *Cousin Basil* and *The Moais*, but they show no traces of English influence, nor again are they French in tone, for, living near to France, his disillusionment progressed and was completed when he went to Paris and had to live under the régime of the Third

Republic. Settling at Neuilly, the novelist became chronicler, critic, and letter-writer as well, and in all these capacities Queiroz displayed a spontaneity, power and artistic finish unequalled in the literature of his country since the death of Garrett. A bold draughtsman, he excelled in freshness of imagination and careful choice and collocation of words, while his warmth of colouring and brilliance of language speak of the south. Many of his pages descriptive of natural scenery, such for instance as the episode of the return to Tormes in *The City and the Mountains*, have taken rank as classic examples of Portuguese prose, while as a creator of characters he stood unsurpassed by any writer of his generation in the same field. He particularly loved to draw and judge the middle class, and he mocks at and chastises its hypocrisy and narrowness, its veneration of religion and culture, its triumphant lying, its self-satisfied propriety, its cruel egotism. But though he manifested a predilection for middle-class types, his portrait gallery comprises men and women of all social conditions. *The Maias*, his longest book, treats of *fidalgos*, while perhaps his most remarkable character study is of a servant, Juliana, in *Cousin Basil*. At least two of his books, this latter and *The Crime of Father Amaro*, are *chroniques scandaleuses* in their plots and episodes; these volumes, however, mark not only the high-water line of the Realist-Naturalist school in Portugal, but are in themselves, leaving aside all accidentals, creative achievements of a high order.

Though Queiroz was a keen satirist of the ills of society, his pages show hardly a trace of pessimism. *The City and the Mountains*, and in part *The Relic* also, reveal the apostle of Realism as an idealist and dreamer, a true representative of that Celtic tradition which survives in the race and has permeated the whole literature of Portugal. *The Mandarin*, a fantastic variation on the old theme of a man self-sold to Satan, and *The Illustrious House of Ramires*, are the only other writings of his that require mention, except *The Correspondence of Fradique Mendes*. In conjunction with Anthero de Quental and Jayme Batalha Reis, Queiroz invented under that name a smart man of the world who had something of himself and something of Eduardo Prado, and made him correspond on all sorts of subjects with imaginary friends and relatives to the delight of the public, many of whom saw in him a mysterious new writer whose identity they were eager to discover. These sparkling and humorous letters are an especial favourite with admirers of Queiroz, because they reveal so much of his very attractive personality, and perhaps the cleverest of the number, that on Pacheco, has received an English dress. In addition to his longer and more important works, Queiroz wrote a number of short stories, some of which have been printed in a volume under the title of *Contos*. The gems of this remarkable collection are perhaps *The Peculiarities of a Fair-haired Girl*, *A Lyric Poet*, *Jose Mathias*, *The Corpse*, and *Sweet Miracle*.

Most of his books have gone through many editions, and they are even more appreciated in the Brazils than in Portugal. It should be mentioned that the fourth edition of *Father Amaro* is entirely different in form and action from the first, the whole story having been re-written. One of Queiroz's romances and two of his short stories have been published in English. An unsatisfactory version of *Cousin Basil*, under the title *Dragon's Teeth*, appeared at Boston, U.S.A., in 1889, while *Sweet Miracle* has had three editions in England and one in America, and there is also a translation of *O Defunto (The Corpse)*, under the name of *Our Lady of the Pillar*.

An admirable critical study of the work of Queiroz will be found in *A Geração Nova—Os Novelistas*, by J. Pereira de Sampaio (*Bruto*), (Oporto, 1886). *The Revista moderna* of the 20th of November 1897 was entirely devoted to him. Senhor Batalha Reis gives interesting reminiscences of the novelist's early days in his preface to some prose fragments edited by him and named *Prosas Barbaras* (Oporto, 1903) (E. PR.)

ÉCARTÉ (Fr. for "separated," "discarded"), a game at cards of modern origin, probably first played in the Paris salons in the first quarter of the 19th century. It is a development of a very old card game called *la triomphe* or *French-ruff*. Écarté is generally played by two persons, but a pool of three may be formed, the player who is out taking the place of the loser, and the winner of two consecutive games winning the pool. At French écarté (but not at English) bystanders who are betting

may advise the players, but only by pointing to the cards they desire them to play, and the loser of the game goes out, one of the *restrants* taking his place, unless the loser is playing *la chouette*, i. e. playing single-handed against two, and taking all bets.

The small cards (from the two to the six, both inclusive) are removed from an ordinary pack. The players cut for deal, the highest having the choice. The king is the highest card, the ace ranking after the knave. The dealer gives five cards to his adversary, and five to himself, by two at a time to each and by three at a time to each, or vice versa. The eleventh card is turned up for trumps. If it is a king, the dealer scores one, at any time before the next deal. The non-dealer then looks at his cards. If satisfied with them he plays, and there is no discarding; if not satisfied he "proposes." The dealer may either accept or refuse. If he accepts, each player discards face downwards as many cards as he thinks fit, and fresh ones are given from the undealt cards or "stock," first to complete the non-dealer's hand to five, then to complete the dealer's. To ask for "a book" is to ask for five cards. Similarly a second proposal may be made, and so on, until one player is satisfied with his hand. If the dealer refuses, the hand is played without discarding. If the non-dealer announces that he holds the king of trumps, he scores one; and similarly, if the dealer holds the king and announces it, he scores one. The announcement must be made before playing one's first card, or if that card be the king, on playing it. The non-dealer, being satisfied with his hand, leads a card. The dealer plays a card to it, the two cards thus played forming a trick. The winner of the trick leads to the next, and so on. The second to play to a trick must follow suit if able, and must win the trick if he can.

The scores are for the king and for the majority of tricks. The player who wins three tricks scores one for the "point"; if he wins all five tricks, he scores two for the "vole." If the non-dealer plays without proposing, or the dealer refuses the first proposal, and fails to win three tricks, the adversary scores two, but no more even if he wins the vole. The game is five up. The points are conveniently marked with a three-card and a two-card, as at euchre. The three is put face upwards with the two face downwards on the top of it. When one or two or three points are scored the top card is moved so as to expose them. At four, one pip of the two-card is put under the other card. Games may be recorded similarly.

Hints to Players.—The following hints may be of service to beginners:—

Shuffle thoroughly after every deal.

Do not announce the king until in the act of playing your first card.

The hands which should be played without proposing, called *jeux de règle* (standard hands), ought to be thoroughly known. They are as follows:—

1. All hands with three or more trumps, whatever the other cards.
2. Hands with two trumps which contain also—
 - (a) Any three cards of one plain suit;
 - (b) Two cards of one plain suit, one being as high as a queen;
 - (c) Two small cards of one suit, the fifth card being a king of another suit;
 - (d) Three high cards of different suits.
3. Hands with one trump, which contain also—
 - (a) King, queen, knave of one suit, and a small card of another;
 - (b) Four cards of one suit headed by king;
 - (c) Three cards of one suit headed by queen, and queen of another suit.
4. Hands with no trump, which contain three queens or cards of equal value in different suits, e.g., four court cards.
5. Hands from which only two cards can be discarded without throwing a king or a trump.

Holding cards which make the point certain, propose. If you hold a *jeu de règle*, and one of the trumps is the king, propose, as your adversary cannot then take in the king.

When discarding, throw out all cards except trumps and kings.

If your adversary proposes you should accept, unless you are guarded in three suits (a queen being a sufficient guard), or in two suits with a trump, or in one suit with two trumps. Hence the rule not to discard two cards, unless holding the king of trumps, applies to the dealer.

The hands with which to refuse are the same as those with which to play without proposing, except as follows:—

1. Two trumps and three cards of one plain suit should not be played unless the plain suit is headed by a court card.

2. One trump and a tierce major is too weak, unless the fifth card is a court card. With similar hands weaker in the tierce major suit, accept unless the fifth card is a queen.

3. One trump and four cards of a plain suit is too weak to play.

4. One trump and two queens is too weak, unless both queens are singly guarded.

5. One trump, queen of one suit, and knave guarded of another should not be played unless the queen is also guarded, or the card of the fourth suit is a court card.

6. One trump, a king and a queen, both unguarded, should not be played, unless the fourth suit contains a card as high as an ace.

7. Four court cards without a trump are too weak to play, unless they are of three different suits.

Refuse with three queens, if two are singly guarded; otherwise, accept.

Lead from your guarded suit, and lead the highest.

If the strong suit led is not trumped, persevere with it, unless with king of trumps, or queen (king not having been announced), or knave ace, when lead a trump before continuing your suit.

You should not lead trumps at starting, unless you hold king or queen, knave, or knave ace, with court cards out of trumps.

The score has to be considered. If the dealer is at four, and the king is not in your hand nor turned up, play any cards without proposing which give an even chance of three tricks, e.g. a queen, a guarded knave, and a guarded ten. The same rule applies to the dealer's refusal.

At the adverse score of four, and king not being in hand or turned up, any hand with one trump should be played, unless the plain cards are very small and of different suits.

If the non-dealer plays without proposing when he is four to three, and the dealer holds the king he ought not to mark it. The same rule applies to the non-dealer after a refusal, if the dealer is four to three.

At the score of non-dealer three, dealer four, the dealer should refuse on moderate cards, as the player proposing at this score must have a very bad hand.

At four a forward game should not be played in trumps, as there is no advantage in winning the vole.

Laws of Écarté.—The following laws are abridged from the revised code adopted by the Turf Club:—A cut must consist of at least two cards. Card exposed in cutting, fresh cut. Order of distribution of cards, whether by three and two, or vice versa, once selected, dealer must not change it during game. Player announcing king when he has not got it, and playing a card without declaring error, adversary may correct score and have hand played over again. If offender wins point or vole that hand, he scores one less than he wins. Proposal, acceptance, or refusal made cannot be retracted. Cards discarded must not be looked at. Cards exposed in giving cards to non-dealer, he has option of taking them or of having next cards; dealer exposing his own cards, no penalty. Dealer turning up top card after giving cards, cannot refuse second discard. Dealer accepting when too few cards in stock to supply both, non-dealer may take cards, and dealer must play his hand. Card led in turn cannot be taken up again. Card played to a lead can only be taken up prior to another lead, to save revoke or to correct error of not winning trick. Card led out of turn may be taken up prior to its being played to. Player naming one suit and leading another, adversary has option of requiring suit named to be led. If offender has none, no penalty. Player abandoning hand, adversary is deemed to win remaining tricks, and scores accordingly. If a player revokes or does not win trick when he can do so, the adversary may correct score and have hand replayed.

(See *Académie des jeux* (various editions after the first quarter of the 19th century); *Hoyle's Games* (various editions about the same dates); Ch. Van-Tenac et Louis Delanoue, *Traité du jeu de l'écarté* (Paris, 1845; translated in Bohn's *Handbook of Games*, London, 1850); "Cavendish," *The Laws of Écarté, adopted by the Turf Club, with a Treatise on the Game* (London, 1878); *Pocket Guide to Écarté* ("Cavendish," 1897); Foster's *Encyclopaedia of Indoor Games* (1903).

ECBATANA (*Agbatana* in Aeschylus, *Hañmatāna* in Old Persian, written *Agamānu* by Nabonidos, and *Agamatānu* at Behistun, mod. *Hamādan*), the capital of Astyages (Istuvegu), which was taken by Cyrus in the sixth year of Nabonidos (549 B.C.). The Greeks supposed it to be the capital of Media, confusing the Manda, of whom Astyages was king, with the Madā or Medes of Media Atropatene, and ascribed its foundation to Deioicos (the *Daiukku* of the cuneiform inscriptions), who is said to have surrounded his palace in it with seven concentric walls of different colours. Under the Persian kings, Ecbatana, situated at the foot of Mount Elvend, became a summer residence; and was afterwards the capital of the Parthian kings. Sir H. Rawlinson attempted to prove that there was a second and older Ecbatana in Media Atropatene, on the site of the modern Takht-i-

Suleiman, midway between Hamadan and Tabriz (*J.R.G.S.* x. 1841), but the cuneiform texts imply that there was only one city of the name, and Takht-i-Suleiman is the Gazaca of classical geography. The Ecbatana at which Cambyses is said by Herodotus (iii. 64) to have died is probably a blunder for Hamath.

See Perrot and Chipiez, *History of Art in Persia* (Eng. trans., 1897); M. Dieulafoy, *L'Art antique de la Perse*, pt. i. (1884); J. de Morgan, *Mission scientifique en Perse*, ii. (1894). See **HAMADAN** and **PERSIA: Ancient History**, § v. 2. (A. H. S.)

ECCARD, JOHANN (1553-1611), German composer of church music, was born at Mühlhausen on the Unstrut, Prussia, in 1553. At the age of eighteen he went to Munich, where he became the pupil of Orlando Lasso. In his company Eccard is said to have visited Paris, but in 1574 we find him again at Mühlhausen, where he resided for four years, and edited, together with Johann von Burgk, his first master, a collection of sacred songs, called *Crepundia sacra Helmoldi* (1577). Soon afterwards he obtained an appointment as musician in the house of Jacob Fugger, the Augsburg banker. In 1583 he became assistant conductor, and in 1599 conductor, at Königsberg, to Georg Friedrich, margrave of Brandenburg-Anspach, the administrator of Prussia. In 1608 he was called by the elector Joachim Friedrich to Berlin as chief conductor, but this post he held only for three years, owing to his premature death at Königsberg in 1611. Eccard's works consist exclusively of vocal compositions, such as songs, sacred cantatas and chorales for four or five, and sometimes for seven, eight, or even nine voices. Their polyphonic structure is a marvel of art, and still excites the admiration of musicians. At the same time his works are instinct with a spirit of true religious feeling. His setting of the beautiful words "Ein feste Burg ist unser Gott" is still regarded by the Germans as their representative national hymn. Eccard and his school are inseparably connected with the history of the Reformation.

Of Eccard's songs a great many collections are extant; see K. G. A. von Winterfeld, *Der Evangelische Kirchengesang* (1843); Döring (*Choralkunde*, p. 47).

ECCELINO (or **EZZELINO**) **DA ROMANO** (1194-1250), Ghibelline leader, and supporter of the emperor Frederick II., was born on the 25th of April 1194. He belonged to a family descended from a German knight named Eccelin, who followed the emperor Conrad II. to Italy about 1036, and received the fief of Romano near Padua. Eccelin's grandson was Eccelino III., surnamed the Monk, who divided his lands between his two sons in 1223, and died in 1235. The elder of these two sons was Eccelino, who in early life began to take part in family and other feuds, and in 1226, at the head of a band of Ghibellines, seized Verona and became *podestà* of the city. He soon lost Verona, but regained it in 1230; and about this time came into relations with Frederick II., who in 1232 issued a charter confirming him in his possessions. In 1236 when besieged in Verona he was saved by the advance of the emperor, who in November of the same year took Vicenza and entrusted its government to Eccelino. In 1237 he obtained authority over Padua and Treviso; and on the 27th of November in that year he shared in the victory gained by the emperor over the Lombards at Cortenuova. In 1238 he married Frederick's natural daughter, Selvaggia; in 1239 was appointed imperial vicar of the march of Treviso; but in the same year was excommunicated by Pope Gregory IX. He was constantly engaged in increasing his possessions; was present at the siege of Parma in 1247, and after Frederick's death in 1250 he supported his son, the German king Conrad IV. His cruelties had, however, aroused general disgust, and in 1254 he was again excommunicated. In 1256 Pope Alexander IV. proclaimed a crusade against him, and a powerful league was soon formed under the leadership of Philip, archbishop of Ravenna. Padua was taken from Eccelino, but on the 1st of September 1258 he defeated his enemies at Torricella. He then made an attempt on Milan, and the rival forces met at Cassano on the 27th of September 1259, when Eccelino was wounded and taken prisoner. Enraged at his capture, he tore the bandages from his wounds, refused to take nourishment, and died at Soncino on the 7th of October 1259. In the following year his brother Albert was put to death, and the Romano family became

extinct. *Eccelino*, who is sometimes called the *tyrant*, acquired a terrible reputation on account of his cruelties, a reputation that won for him the immortality of inclusion in Dante's *Inferno*; but his unswerving loyalty to Frederick II. forms a marked contrast to the attitude of many of his contemporaries.

Eccelino is the subject of a novel by Cesare Cantu and of a drama by J. Eichendorff.

See J. M. Gittermann, *Eccelino da Romano* (Freiburg, 1890); S. Mitsis, *Storia d' Eccelino IV. da Romano* (Maddaloni, 1896); and F. Stieve, *Eccelino von Romano* (Leipzig, 1909).

ECCENTRIC (from Gr. *ék*, out of, and *στέρπος*, centre), literally "out from the centre," and thus used to connote generally any deviation from the normal. In astronomy the word denotes a circle round which a body revolves, but whose centre is displaced from the visible centre of motion. In the ancient astronomy the ellipses in which it is now known that the planets revolve around the sun could not be distinguished from circles, but the unequal angular motion due to ellipticity was observed. The theory of the eccentric was that the centre of the epicycle of each planet moved uniformly in a circle, the centre of which was displaced from that of the earth by an amount double the eccentricity of the actual ellipse, as the case is now understood. When measured around this imaginary centre, which is so situated on the major axis of the ellipse that the focus, or place of the real sun, is midway between it and the centre of the ellipse, the motion is approximately uniform. In engineering, an eccentric is a mechanical device for converting rotary into reciprocating motion (see **STEAM-ENGINE**). For eccentric angle see **ELLIPSE**.

ECCHELLENSIS (or **ECELLENSIS**), **ABRAHAM** (d. 1664), a learned Maronite, whose surname is derived from *Eckel* in Syria, where he was born towards the close of the 16th century. He was educated at the Maronite college in Rome, and, after taking his doctor's degree in theology and philosophy, returned for a time to his native land. He then became professor of Arabic and Syriac in the college of the Propaganda at Rome. Called to Paris in 1640 to assist Le Jay in the preparation of his polyglot Bible, he contributed to that work the Arabic and Latin versions of the book of Ruth and the Arabic version of the third book of Maccabees. In 1646 he was appointed professor of Syriac and Arabic at the Collège de France. Being invited by the Congregation of the Propaganda to take part in the preparation of an Arabic version of the Bible, *Ecchellensis* went again in 1652 or 1653 to Rome. He published several Latin translations of Arabic works, of which the most important was the *Chronicon Orientale* of Ibnar-Râhib (Paris, 1653), a history of the patriarchs of Alexandria. He was engaged in an interesting controversy with John Selden as to the historical grounds of episcopacy, in the course of which he published his *Eutychnus vindicatus, sive Responsio ad Seldeni Origines* (Rome, 1661). Conjointly with Giovanni Borelli he wrote a Latin translation of the 5th, 6th and 7th books of the *Comics* of Apollonius of Perga (1661). He died at Rome in 1664.

ECCLES, a municipal borough in the Eccles parliamentary division of Lancashire, England, 4 m. W. of Manchester, of which it forms practically a suburb. Pop. (1901) 34,369. It is served by the London & North-Western railway and by the Birkenhead railway (North-Western and Great Western joint). The Manchester Ship Canal passes through. The church of St Mary is believed to date from the 12th century, but has been enlarged and wholly restored in modern times. There are several handsome modern churches and chapels, a town hall, and numerous cotton mills, while silk-throwing and the manufacture of fustians and ginghams are also among the industries, and there are also large engine works. A peculiar form of cake is made here, taking name from the town, and has a wide reputation. Eccles was incorporated in 1892, and the corporation consists of a mayor, 6 aldermen and 18 councillors. The borough maintains the tramway service, &c., but water and gas are supplied from Manchester and Salford respectively. Area, 2057 acres.

Before the Reformation the monks of Whalley Abbey had a grange here at what is still called Monks' Hall; and in 1864 many thousands of silver pennies of Henry III. and John of

England and William I. of Scotland were discovered near the spot. Robert Ainsworth, the author of the Latin and English dictionary so long familiar to English students, was born at Eccles in 1660; and it was at the vicarage that William Huskisson expired on the 15th of September 1830 from injuries received at the opening of the Liverpool & Manchester railway. From early times "wakes" were held at Eccles, and bull-baiting, bear-baiting and cock-fighting were carried on. Under Elizabeth these festivals, which had become notoriously disorderly, were abolished, but were revived under James I., and maintained until late in the 19th century on public ground. The cockpit remained on the site of the present town hall. A celebration on private property still recalls these wakes.

ECCLESFIELD, a township in the Hallamshire parliamentary division of the West Riding of Yorkshire, England, 5 m. N. of Sheffield, on the Great Central and Midland railways. The church of St Mary is Perpendicular, with a central tower, and contains excellent woodwork. It formerly bore, and must have deserved, the familiar title of the "Minster of the Moors." Ecclesfield was the seat of a Benedictine priory, which passed to the Carthusians in the 14th century. Cutlery and tools are largely manufactured, and there are coal-mines, paper mills and iron and fire-clay works. After the inclusion within the county borough of Sheffield of part of the civil parish of Ecclesfield in 1901, the population was 18,324.

ECCLESHALL, a market town in the north-western parliamentary division of Staffordshire, England; 7 m. N.W. from Stafford, and 4 W. of Norton Bridge station on the London & North-Western main line. Pop. (1901) 3790. The church of the Holy Trinity, one of the most noteworthy in Staffordshire, is principally Early English, and has fine stained glass. Several bishops of Lichfield are buried here, as Eccleshall Castle was the episcopal residence from the 13th century until 1867. Of this the ancient remains include a picturesque tower and bridge. To the west on the borders of Shropshire is Blore Heath, the scene of a defeat of the Lancastrians by the Yorkists in 1459.

ECCLESIA (Gr. *ἐκκλησία*, from *ék*, out, and *καλέω*, to call), in ancient Athens, the general assembly of all the freemen of the state. In the primitive unorganized state the king was theoretically absolute, though his great nobles meeting in the Council (see **BOULE**) were no doubt able to influence him considerably. There is, however, no doubt that in the earliest times the free people, i.e. the fighting force of the state, were called together to ratify the decisions of the king, and that they were gradually able to enforce their wishes against those of the nobles. In Athens, as in Rome, where the Plebs succeeded in their demand for the codification of the laws (the Twelve Tables), it was no doubt owing to the growing power of the people meeting in the Agora that Draco was entrusted with the task of publishing a code of law and so putting an end to the arbitrary judicature of the aristocratic party. But there is no evidence that the Ecclesia had more than a *de facto* existence before Solon's reforms.

The precise powers which Solon gave the people are not known. It is clear that the executive power in the state (see **ARCHON**) was still vested in the Eupatrid class. It is obvious, therefore, that a moderate reformer would endeavour to give to the people some control over the magistracy. Now in speaking of the Thetes (the lowest of the four Solonian classes; see **OLON**), Aristotle's *Constitution of Athens* says that Solon gave them merely "a share in the Ecclesia and the Law Courts," and in the *Politics* we find that he gave them the right of electing the magistrates and receiving their accounts at the end of the official year. Thus it seems that the "mixed" character of Solon's constitution consisted in the fact that though the officials of the state were still necessarily Eupatrid, the Ecclesia elected those of the Eupatrids whom they could trust, and further had the right of criticizing their official actions. Secondly, all our accounts agree that Solon admitted the Thetes to the Ecclesia, thus recognizing them as citizens. Under Cleisthenes the Ecclesia remained the sovereign power, but the Council seems to have become to some extent a separate administrative body. The relation of Boule and Ecclesia in the Cleisthenic democracy was of the

great importance. The Ecclesia alone, a heterogeneous body of untrained citizens, could not have passed, nor even have drawn up intelligible measures; all the preliminary drafting was done by the small committee of the Boulê which was in session at any particular time. In the 5th century the functions of the Ecclesia and the popular courts of justice were vastly increased by the exigencies of empire. At the beginning of the 4th century B.C. the system of payment was introduced (see below). In 308 B.C. Demetrius of Phalerum curtailed the power of the Ecclesia by the institution of the *Nomophylaces* (Guardians of the Law), who prevented the Ecclesia from voting on an illegal or injurious motion. Under Roman rule the powers of the Ecclesia and the popular courts were much diminished, and after 48 B.C. (the franchise being frequently sold to any casual alien) the Demos (people) was of no importance. They still assembled to pass psephisms in the theatre and to elect strategi, and, under Hadrian, had some small judicial duties, but as a governing body the Ecclesia died when Athens became a *civitas libera* under Roman protection.

Constitution and Functions.—Throughout the period of Athenian greatness the Ecclesia was the sovereign power, not only in practice but also in theory. The assembly met in early times near the sanctuary of Aphrodite Pandemus (i.e. south of the Acropolis), but, in the 5th and 4th centuries, the regular place of meeting was the Pnyx. From the 5th century it met sometimes in the theatre, which in the 3rd century was the regular place. From Demosthenes we learn that in his time special meetings were held at Peiræus, and, in the last centuries B.C., meetings were held at Athens and Peiræus alternately. Certain meetings, however, for voting ostracism (q.v.) and on questions affecting individual status took place in the Agora. Meetings were (1) ordinary, (2) extraordinary, and (3) convened by special messengers (*κίρραι*, *σὺγγελητοὶ* and *κατάκλητοι*), these last being called when it was desirable that the country people should attend. At ordinary meetings the attendance was practically confined to Athenian residents. According to Aristotle there were four regular meetings in each prytany (see BOULÊ); probably only the first of these was called *κίρρα*. It is certain, however, that the four meetings did not fall on regular days, owing to the occurrence of feast days on which no meeting could take place. In the *κίρρα ἐκκλησία* of each month took place the *Epicheirotonia* (monthly inquiry) of the state officials, and if it proved unsatisfactory a trial before the Heliæa was arranged; the council reported on the general security and the corn-supply, and read out lists of vacant inheritances and unmarried heiresses. In the sixth prytany of each year at the *κίρρα ἐκκλησία* the question whether ostracism should take place that year was put to the vote. For all meetings it was usual that the Prytaneis should give five days' notice in the form of a *programma* (agenda). On occasions of sudden importance the herald of the council summoned the people with a trumpet, and sometimes special messengers were despatched to "bring in" the country people (*κατακαλέειν*).

After the archonship of Solon all Athenians over the age of eighteen were eligible to attend the assembly, save those who for some reason had suffered *atimia* (loss of civil rights). To prevent the presence of any disqualified persons, six *lexiarchs* with thirty assistants were present with the deme-rolls in their hands. These officers superintended the payment in the 4th century and probably the *toxotæ* (police) also, whose duty it was before the introduction of pay to drive the people out of the Agora into the Ecclesia with a rope steeped in red dye which they stretched out and used as a draw net (see Aristoph. *Acharn.* 22 and *Eccles.* 378). The introduction of pay, which belongs to the early years of the 4th century and by the *Constitution* (c. 41 *ad fin.*) is attributed to Agyrrhius, a statesman of the restored democracy, was a device to secure a larger attendance. The rate rose from one to two obols and then to three obols (Aristoph. *Eccles.* 300 sqq.), while at the time of Aristotle it was one and a half drachmas for the *κίρρα ἐκκλησία* and one drachma for other meetings. Probably those who were late did not receive payment.

Procedure.—The proceedings opened with formalities: the purification by the *peristiarchs*, who carried round slain sucking pigs; the curse against all who should deceive the people; the appointment (in the 4th century) of the *proedri* and their *epistates* (see BOULÊ); the report as to the weather-omens. The assembly was always dismissed if there were thunder, rain or an eclipse. These formalities over, the Prytaneis communicated the *probouleuma* of the council, without which the Ecclesia could not debate. This recommendation either submitted definite proposals or merely brought the agenda before the assembly. Its importance lay largely in the fact that it explained the business in hand, which otherwise must often have been beyond the grasp of a miscellaneous assembly. After the reading, a preliminary vote was taken as to whether the council's report should be accepted *en bloc*. If it was decided to discuss, the herald called upon people to speak. Any person, without distinction of age or position, might obtain leave to speak, but it seems probable that the man who had moved the recommendation previously in the council would advocate it in the assembly. The council was, therefore, a check on the assembly, but its powers were to some extent illusory, because any member of the assembly (1) might propose an amendment, (2) might draw up a new resolution founded on the principal motion, (3) might move the rejection of the motion and the substitution of another, (4) might bring in a motion asking the council for a recommendation on a particular matter, (5) might petition the council for leave to speak on a given matter to the assembly. Voting usually was by show of hands, but in special cases (ostracism, &c.) by ballot (i.e. by casting pebbles into one of two urns). The decision of the assembly was called a *psephism* and had absolute validity. These decisions were deposited in the Metroon where state documents were preserved; peculiarly important decrees were inscribed also on a column (*stèle*) erected on the Acropolis. It has been shown that the power of the council was far from sufficient. The real check on the vagaries of amateur legislators was the Graphê Paranomôn. Any man was at liberty to give notice that he would proceed against the mover of a given resolution either before or after the voting in the Ecclesia. A trial in a Heliastic court was then arranged, and the plaintiff had to prove that the resolution in question contravened an existing law. If this contention were upheld by the court, when the case was brought to it by the Thesmothetæ, the resolution was annulled, and the defendant had to appear in a new trial for the assessment of the penalty, which was usually a fine, rarely death. Three convictions under this law, however, involved a certain loss of rights; the loser could no longer move a resolution in the Ecclesia. After the lapse of a year the mover of a resolution could not be attacked. In the 4th century the Graphê Paranomôn took the place of Ostracism (q.v.). In the 5th century it was merely an arrangement whereby the people sitting as sworn juries ratified or annulled their own first decision in the Ecclesia.

Revision of Laws.—In the 4th century, the assembly annually, on the eleventh day of Hecatombæon (the first day of the official year), took a general vote on the laws, to decide whether revision was necessary. If the decision was in favour of alteration, it was open to any private citizen to put up notice of amendments. The Nomothetæ, a panel selected by the Prytaneis from the Heliæa, heard arguments for and against the changes proposed and voted accordingly. Against all new laws so passed, there lay the Graphê Paranomôn. Thus the Nomothetæ, not the Ecclesia, finally passed the law.

Judicial Functions.—The Ecclesia heard cases of Probolê and Eisangelia (see GREEK LAW). The Probolê was an action against sycophants and persons who had not kept their promises to the people, or had disturbed a public festival. The verdict went by show of hands, but no legal consequences ensued, if the plaintiff demanded punishment he had to go to the Heliæa which were not at all bound by the previous vote in the Ecclesia. Cases of Eisangelia in which the penalty exceeded the legal competence of the council came before the Ecclesia in the form of a *probouleuma*. To prevent vexatious accusations, it was

(at some date unknown) decided that the accuser who failed to obtain one-fifth of the votes should be fined 1000 drachmas (L40). (For the procedure in case of Ostracism see that article.)

Summary.—Thus it will be seen that the Ecclesia, with no formal organization, had absolute power save for the Graphē Paranomōn (which, therefore, constituted the dicasteries in one sense the sovereign power in the state). It dealt with all matters home and foreign. Every member could initiate legislation, and, as has been shown, the power of the council was merely formal. As against this it must be pointed out that it was by no means a representative assembly in practice. The phrase used to describe a very special assembly (*κατ'ἐλάχιστος ἐκκλησία*) shows that ordinarily the country members did not attend (*κἀρακαλεῖν* always involving the idea of motion from a distance towards Athens), and Thucydides says that 5000 was the maximum attendance, though it must be remembered that he is speaking of the time when the number of citizens had been much reduced owing to the plague and the Sicilian expedition. From this we understand the necessity of payment in the 4th century, although in that period the Ecclesia was supreme (*Constitution of Athens*, xli. 2). The functions of the Ecclesia thus differed in two fundamental respects from those which are in modern times associated with a popular assembly. (1) It did not exercise, at least in the period as to which we are best instructed, the power of law-making (*νομοθεσία*) in the strict sense. It must be remembered, however, in qualification of this statement that it possessed the power of passing *psēphismata* which would in many cases be regarded as law in the modern sense. (2) The Ecclesia was principally concerned with the supervision of administration. Much of what we regard as executive functions were discharged by the Ecclesia.

With this article compare those on SOLON; BOULE; AREOPAGUS; GREEK LAW, and, for other ancient popular assemblies, APELLA, COMITIA. See also A. H. J. Greenidge, *Handbook of Greek Constitutional History* (1896); Gilbert, *Greek Constitutional Antiquities* (trans. Brooks and Nicklin, 1895); Schömann, *De comitiis Atheniensium*; L. Schmidt, "De Atheniensis republicae indole democratica" in *Ind. Lect.* (Marburg, 1865); J. W. Headlam, *Election by Lot at Athens* (Cambridge, 1891). See also the histories of Greece by Meyer, Busolt, Grote, Evelyn Abbott, and J. E. Sandys' edition of the *Constitution of Athens* (1892); for a comparative study, E. A. Freeman, *Comparative Politics*. (J. M. M.)

ECCLESIASTES (Heb. *נְבוֹנִי*, *Kohélet*, "Kohélet"; Sept. *ἐκκλησιαστής*; Jerome *concionator*), one of the Wisdom Books of the Old Testament (see WISDOM LITERATURE). The book, as it stands, is a collection of the discourses, observations and aphorisms of a sage called Kohélet, a term the precise meaning of which is not certain. The Greek *ecclesiastes* means one who takes part in the deliberations of an assembly (*ecclesia*), a debater or speaker in an assembly (Plato, *Gorgias*, 452 E), and this is the general sense of the Hebrew word. Its form (singular feminine) has been supposed to be the adoption or imitation of the Arabic employment of a fem. sing. as the designation of a high official person, as is the case in the title *caliph* (whence the rendering in the margin of the Revised Version, "Great orator"); but the adoption of an Arabic idiom is not probable. This usage is not Hebrew; it is not found either in the Old Testament or in the later (Mishnaic) Hebrew. The form may have been suggested by that of the Hebrew word for "wisdom." *Kohélet*, however, is employed in the book not as a title of wisdom (for "wisdom" is never the speaker), but as the independent name of the sage. It is intended to represent him as a member of an assembly (*Kahal*)—not the Jewish congregation, but a body of students or inquirers, such as is referred to in xii. 9-11, a sort of collegium, of which he was the head; and as instructor of this body he gives his criticism of life. The author begins, indeed, with identifying his sage with King Solomon (i. 12-ii. 11, 12b); but he soon abandons this literary device, and speaks in his own name. The rendering "preacher" has a misleading connotation.

In the book as we have it there is no orderly exposition of a theory; it rather has the appearance of a collection of remarks jotted down by a pupil (somewhat after the manner of Xenophon's *Memorabilia*), or of extracts from a sage's notebook. It

is, however, characterized throughout (except in some scribal additions) by a definite thought, and pervaded by a definite tone of feeling. The keynote is given in the classic phrase with which the discussion opens and with which it closes: "Vanity of vanities (*i.e.* absolute vanity), all¹ is vanity!" Life, says the author, has nothing of permanent value to offer. His attitude is one not of bitterness but of calm hopelessness, with an occasional tinge of disgust or contempt. He fancies that he has tried or observed everything in human experience, and his deliberate conclusion is that nothing is worth doing. He believes in an all-powerful but indifferent God, and is himself an observer of society, standing aloof from its passions and ambitions, and interested only in pointing out their emptiness.

This general view is set forth in a number of particular observations.

1. His fundamental proposition is that there is a fixed, unchangeable order in the world, a reign of inflexible law (i. 4-11, iii. 1-11, 14, 15, vii. 13, viii. 5-9): natural phenomena, such as sunrise and sunset, recur regularly; for everything in human experience a time has been set; birth and death, building up and destroying, laughing and weeping, silence and speech, love and hate, war and peace, are to be regarded not as utterances of a living, self-directing world, but as incidents in the work of a vast machine that rolls on for ever; there is an endless repetition—nothing is new, nothing is lost; if one thinks he has found something new, inquiry shows that it was in existence long ago; God, the author of all, seeks out the past in order to make it once more present; it is impossible to add to or take from the content of the world, impossible to change the nature of things, to effect any radical betterment of life; the result is unspeakable weariness—a depressing series of sights and sounds. No goal or purpose is discoverable in this eternal round; if the sun rises and goes on his journey through the sky, it is merely to come back to the place where he rose; rivers flow for ever into the sea without filling it. To what end was the world created? It is impossible to say. Such is Kohélet's view of life, and it is obvious that such a conception of an aimless cosmos is thoroughly non-Jewish, if we may judge Jewish thought by the great body of the extant literature.

2. Further, says Kohélet, man is impelled to study the world, but under the condition that he shall never comprehend it (iii. 11, vii. 23, 24, viii. 16, 17). As to the meaning of the Hebrew term *olam* in iii. 11, there are various opinions, but "world" appears to be the rendering favoured by the connexion: "God has made everything beautiful in its time, and has put the *olam* into men's minds, yet so that they cannot understand His work": the *olam*, the sum of phenomena, is God's work. The word is not found in this sense elsewhere in the Old Testament, but it so occurs in the Mishna (*Pirke Aboth*, iv. 7), and the vocabulary of Ecclesiastes is admittedly similar to that of the Mishna. Only here in the Old Testament does it stand as a simple isolated noun; elsewhere it is the definition of a noun (in "everlasting covenant," &c.), or it is preceded by a preposition, in the phrases "for ever," "of old," or it stands alone (sing. or plur.) in the same adverbial sense, "for ever." The word means first a remote point in past or future, then a future point without limit of time, then a period of history, and finally the world considered as a mass of human experiences (cf. *olam*). The renderings "eternity" and "future" in the present passage are unsatisfactory; the former has an inappropriate metaphysical connotation, and yields no distinct sense; the latter does not suit the connexion, though there is reference to the future elsewhere (ix. 1). God, the text here declares, has made the world an object of man's thought, yet so that man can never find out the work that God has done (iii. 11). The reference seems to be not so much to the variety and complexity of phenomena as to the impossibility of constructing them rationally or in such a way that man may foresee and provide for his future. Man is in the clutches of fate (ix. 11, 12); there is no observable relation between exertion and result in life: the race is not to the swift nor the battle to the strong;

¹ The Hebrew has the definite article, "the whole," *כֹּל*.

success does not attend wisdom, knowledge and skill; men are like fish taken in a net or birds caught in a snare.

3 Human life, Koheleth declares, is unsatisfying. He inquired, he says, into everything that is done by men under the sun (i. 12-16): God has inflicted on men a restless desire for movement and work,¹ yet life is but a catalogue of fruitless struggles. He gives a number of illustrations. In his character of king he tried all the bodily pleasures of life (ii. 1-11): he had houses, vineyards, gardens, parks, ponds, forests, servants, flocks and herds, treasures of gold and silver, singers, wives; all these he set himself to enjoy in a rational way—indeed, he found a certain pleasure in carrying out his designs, but, when all was done, he surveyed it only to see that it was weary and unprofitable. Dropping the rôle of Solomon and speaking as an observer of life, the author declares (iv. 4) that the struggle for success is the result of rivalry among men, which has no worthy outcome. The securing of riches is a fallacious achievement, for often wealth perishes by some accident (v. 13 f.), or its possessor is unable to enjoy it (vi. 1-30), or he has no one to whom to leave it, and he cannot keep it—naked man comes into the world, naked he goes out. He does not consider the possibility of deriving enjoyment from wealth by helping the poor or encouraging learning (this latter, indeed, he looks on as vanity), and in general he recognizes no obligation on the part of a man to his fellows. A noteworthy survival of an old belief is found in vi. 3: though a man have the great good fortune to live long and to have many children, yet, if he have not proper burial the blank darkness of an untimely birth is better than he: this latter is merely the negation of existence; the former, it appears to be held, is positive misfortune, the loss of a desirable place in Sheol, though elsewhere (ix. 5) existence in Sheol is represented as the negation of real life. It is not necessary to suppose that the writer has here any particular case in mind.

If wealth be thus a vain thing, yet a sage might be supposed to find satisfaction in wisdom, that is, practical good sense and sagacity; but this also the author puts aside as bringing no lasting advantage, since a wise man must finally give up the fruit of his wisdom to someone else, who may be a fool, and in any case the final result for both fools and wise men is the same—both are forgotten (ii. 12-23). A particular instance is mentioned (ix. 13-15) of a beleaguered city saved by a wise man; but the man happened to be poor, and no one remembered him. The whole constitution of society, in fact, seems to the sage a lamentable thing: the poor are oppressed, the earth is full of their cries, and there is no helper (iv. 1); strange social upheavals may be seen: the poor² set in high places, the rich cast down, slaves on horseback, princes on foot (x. 5-7). He permits himself a sweeping generalization (vii. 25-28): human beings as a rule are bad: one may occasionally find a good man, never a good woman—woman is a snare and a curse. He (or an editor) adds (vii. 29) that this condition of things is due to social development: man was created upright (Gen. i. 27; Enoch lxix. 11), but in the course of history has introduced corrupting complications into life.

4. The natural outcome of these experiences of the author is that he cannot recognize a moral government of the world. He finds, like Job, that there are good men who die prematurely notwithstanding their goodness, and bad men who live long notwithstanding their badness (vii. 15), though long life, it is assumed, is one of the great blessings of man's lot; and in general there is no moral discrimination in the fortunes of men (viii. 14, ix. 2).

5. There is no sacredness or dignity in man or in human life: man has no pre-eminence over beasts, seeing that he and they have the same final fate, die and pass into the dust, and no one knows what becomes of the spirit, whether in man's case it goes up to heaven, and in the case of beasts goes down into Sheol—

¹ In fact, he suggests, a curse, as in Gen. iii. 17-19, though with a wider sweep than that passage has in mind.

² The text has "folly," but the parallelism and v. 7 point to social, not intellectual, conditions, and a slight change (פּוֹר for לְבוֹשׁ) gives the sense "poor."

death is practically the end-all; and so poor a thing is life that the dead are to be considered more fortunate than the living, and more to be envied than either class is he who never came into existence (iv. 2, 3). It is a special grievance that the wicked when they die are buried with pomp and ceremony, while men who have acted well are forgotten³ in the city (viii. 10).

6. That the author does not believe in a happy or active future life appears in the passage (iv. 2, 3) quoted above. The old Hebrew view of the future excluded from Sheol the common activities of life and also the worship of the national god (Isa. xxxviii. 18); he goes even beyond this in his conception of the blankness of existence in the underworld. The living, he says, at least know that they shall die, but the dead know nothing—the memory of them, their love, hate and envy, perishes, they have no reward, no part in earthly life (ix. 5, 6); there is absolutely no knowledge and no work in Sheol (ix. 10). His conclusion is that men should do now with all their might what they have to do; the future of man's vital part, the spirit, is wholly uncertain.

7. His conception of God is in accord with these views. God for him is the creator and ruler of the world, but hardly more; he is the master of a vast machine that grinds out human destinies without sympathy with man and without visible regard for what man deems justice—a being to be acknowledged as lord, not one to be loved. There can thus be no social contact between man and God, no communion of soul, no enthusiasm of service. Moral conduct is to be regulated not by divine law (of this nothing is said) but by human experience. The author's theism is cold, spiritless, without influence on life.

If now the question be asked what purpose or aim a man can have, seeing that there is nothing of permanent value in human work, an answer is given which recurs, like a refrain, from the beginning to the end of the book, and appears to be from the hand of the original author: after every description of the vanity of things comes the injunction to enjoy such pleasures as may fall to one's lot (ii. 24, 25, iii. 12, 13, 22, v. 18, 19, viii. 15, ix. 7-10, xi. 7-xii. 7). Elsewhere (ii.), it is true, it is said that there is no lasting satisfaction in pleasure; but the sage may mean to point out that, though there is no permanent outcome to life, it is the part of common-sense to enjoy what one has. The opportunity and the power to enjoy are represented as being the gift of God; but this statement is not out of accord with the author's general position, which is distinctly theistic. All the passages just cited, except the last (xi. 7-xii. 7), are simple and plain, but the bearing of the last is obscured by interpolations. Obviously the purpose of the paragraph is to point out the wisdom of enjoying life in the time of youth while the physical powers are fresh and strong, and the impotency of old age has not yet crept in. Omitting xi. 8c, 9b, 10b, xii. 1a, the passage will read: "Life is pleasant in the bright sunshine—however long a man may live, he must be cheerful always, only remembering that dark days will come. Let the young man enjoy all the pleasures of youth, putting away everything painful, before the time comes when his bodily powers decay and he can enjoy nothing." To relieve the apparent Epicureanism of this passage, an editor has inserted reminders of the vanity of youthful pleasures, and admonitions to remember God and His judgment. The author, however, does not recommend dissipation, and does not mean to introduce a religious motive—he offers simply a counsel of prudence. The exhortation to remember the Creator in the days of youth, though it is to be retained in the margin as a pious editorial addition, here interrupts the line of thought. In xii. 1a some critics propose to substitute for "remember thy Creator" the expression of xi. 9, "let thy heart cheer thee"; but the repetition is improbable. Others would read: "remember thy cistern" (Bickell), or "thy well" (Haupt), that is, thy wife. The wife is so called in Prov. v. 15-19 in an elaborate poetical figure (the wife as a source of bodily pleasure), in which the reference is clear from the context; but there is no authority, in the Old Testament or in other literature of this period, for

³ The Septuagint has less well: "They (the wicked) are praised in the city."

taking the term as a simple prose designation of a wife. Nor would this reference to the wife be appropriate in the connexion, since the writer's purpose is simply to urge men to enjoy life while they can. The paragraph (and the original book) concludes with a sustained and impressive figure, in which the failing body of the old man is compared to a house falling into decay: first, the bodily organs (xii. 3, 4a); the keepers of the house (the arms and hands) tremble, the strong men (the legs and perhaps the backbone) are bent, the grinding women (the teeth) cease to work, those that look out of the windows (the eyes) are darkened, the street-doors are shut, the sound of the mill being low (apparently a summary statement of the preceding details: communication with the outer world through the senses is cut off, the performance of bodily functions being feeble); the rest of v. 4 may refer to the old man's inability to make or hear music: in the house there is no sound of birds¹ or of singers, there are none of the artistic delights of a well-to-do household; further (v. 5a) the inmates of the house fear dangers from all powerful things and persons (the old man is afraid of everything), the almond tree blossoms (perhaps the hair turns white). The two next clauses are obscure.² Then comes the end: man goes to his everlasting home; the dust (the body) returns to the earth whence it came (Gen. ii. 7), and the breath of life, breathed by God into the body, returns to him who gave it. This last clause does not affirm the immortality of the soul; it is simply an explanation of what becomes of the vital principle (the "breath of life" of Gen. ii. 7); its positive assertion is not in accord with the doubt expressed in iii. 21 ("who knows whether the spirit of man goes upward?"), and it seems to be from another hand than that of the author of the original book.

There are other sayings in the book that appear to be at variance with its fundamental thought. Wisdom is praised in a number of passages (iv. 13, vii. 5, 11, 12, 19, viii. 1, ix. 16, 17, x. 2, 3), though it is elsewhere denounced as worthless. It may be said that the author, while denying that wisdom (practical sagacity and level-headedness) can give permanent satisfaction, yet admits its practical value in the conduct of life. This may be so; but it would be strange if a writer who could say, "in much wisdom is much grief," should deliberately laud wisdom. The question is not of great importance and may be left undecided. It may be added that there is in the book a number of aphorisms about fools (v. 3[4], vi. 5, 6, x. 1-3, 12-15) quite in the style of the book of Proverbs, some of them contrasting the wise man and the fool; these appear to be the insertions of an editor. Further, it may be concluded with reasonable certainty that the passages that affirm a moral government of the world are additions by pious editors who wished to bring the book into harmony with the orthodox thought of the time. Such assertions as those of ii. 26 (God gives joy to him who pleases him, and makes the sinner toil to lay up for the latter), viii. 12 (it shall be well with those that fear God, but not with the wicked), xii. 13 f. (man's duty is simply to obey the commands of God, for God will bring everything into judgment) are irreconcilable with the oft-repeated statement that there is no difference in the earthly lots of the righteous and the wicked, and no ethical life after death.

Many practical admonitions and homely aphorisms are scattered through the book: iv. 5, quiet is a blessing; iv. 9-12, two are better than one; iv. 17 (Eng. v. 1), be reverent in visiting the house of God (the temple and the connected buildings)—

¹The clause is obscure; literally "he (or, one) rises at (?) the voice of the bird," usually understood to refer to the old man's inability to sleep in the morning; but this is not a universal trait of old age, and besides, a reference to affairs in the house is to be expected; the Hebrew construction also is of doubtful correctness. A change of the Hebrew text seems necessary; possibly we should read "הוֹרֵא" "low is the voice," instead of "הוֹרֵא" "he rises up at the voice."

²The second is perhaps to be read: "the caper-berry blooms" (white hair); usually "the caper-berry loses its appetizing power"; Eng. Auth. Vcrs. "desire shall fail." For the meaning of the word *abyma* ("caper-berry," not "desire" or "poverty"), see art. by G. F. Moore in *Journ. of Bibl. Lit.* x. 1 (Boston, Mass., 1891).

to listen (to the service of song or the reading of Scripture) is better than to offer a foolish (thoughtless) sacrifice; v. 1 (2), be sparing of words in addressing God; v. 1-5 (2-6), pay your vows—do not say to the priest's messenger that you made a mistake; vii. 2-4, sorrow is better than mirth; vii. 16-18, be not over-righteous (over-attentive to details of ritual and convention) or over-wicked (flagrantly neglectful of established beliefs and customs); here "righteous" and "wicked" appear to be technical terms designating two parties in the Jewish world of the 2nd and 1st centuries B.C., the observers and the non-observers of the Jewish ritual law; these parties represent in a general way the Pharisees and the Sadducees; viii. 2-4, x. 20, it is well to obey kings and to be cautious in speaking about them, for there are talebearers everywhere; vii. 20, no man is free from sin; vii. 21, do not listen to all that you may overhear, lest you hear yourself ill spoken of; ix. 4, a living dog is better than a dead lion; xi. 1-6, show prudence and decision in business; do not set all your goods on one venture; act promptly and hope for the best. At the close of the book (xii. 9-12) there are two observations that appear to be editorial recommendations and cautions. First, Koboeth is endorsed as an industrious, discriminating and instructive writer. Possibly this is in reply to objections that had been made to what he had written. There follows an obscure passage (v. 11) which seems to be meant as a commendation of the teaching of the sages in general: their words are said to be like gods (inciting to action) and like nails driven in a building (giving firmness to character); they issue from masters of assemblies,³ heads of academies (but not of the Sanhedrin). The succeeding clause "they are given from one shepherd" may refer to a collection or revision by one authoritative person, but its relevancy is not obvious. The "shepherd" cannot be God (Gen. xlix. 24; Ps. xxiii. 1); the poetical use of the word would not be appropriate here. The clause is possibly a gloss, a comment on the preceding expression. A caution against certain books is added (v. 12), probably works then considered harmful (perhaps philosophic treatises), of which, however, nothing further is known.

Composition of the Book.—If the analysis given above is correct, the book is not a unit; it contains passages mutually contradictory and not harmonizable. Various attempts have been made to establish its unity. The hypothesis of "two voices" is now generally abandoned; there is no indication of a debate, of affirmations and responses. A more plausible theory is that the author is an honest thinker, a keen observer and critic of life, who sees that the world is full of miseries and unsolved problems, regards as futile the attempts of his time to demonstrate an ethically active future life, and, recognizing a divine author of all, holds that the only wise course for men is to abandon the attempt to get full satisfaction out of the struggle for pleasure, riches and wisdom, and to content themselves with making the best of what they have. This conception of him is largely true, as is pointed out above, but it does not harmonize the contradictions of the book, the discrepancies between the piety of some passages and the emotional indifference toward God shown in others. Other of the Biblical Wisdom books (Job, Proverbs) are compilations—why not this? It is not necessary to multiply authors, as is done, for example, by Siegfried, who supposes four principal writers (a pessimistic philosopher, an Epicurean glossator, a sage who upholds the value of wisdom, and an orthodox editor) besides a number of annotators; it is sufficient to assume that several conservative scribes have made short additions to the original work. Nor is it worth while to attempt a logical or symmetrical arrangement of the material. It has been surmised (by Bickell) that the sheets of the original codex became disarranged and were rearranged incorrectly; by other critics portions of the book are transferred

³This is the Talmudic understanding of the Hebrew expression [Jerus. Sanhed. 10, 28a, cf. Sanhed. 12a; see *Eclus.* xxxix. 2]. There is no good authority for the renderings "collectors of maxims," "collections of maxims."

⁴It is not certain that the codex form was in use in Palestine or in Egypt as early as the 2nd or the 1st century B.C.

hither and thither; in all cases the critic is guided in these changes by what he conceives to have been the original form of the book. But it is more probable that we have it in the form in which it grew up—a series of observations by the original author with interspersed editorial remarks; and it is better to preserve the existing form as giving a record of the process of growth.

Date.—As to the date of the book, though there are still differences of opinion among scholars, there is a gradual approach to a consensus. The Solomonic authorship has long since been given up: the historical setting of the work and its atmosphere—the silent assumption of monotheism and monogamy, the non-national tone, the attitude towards kings and people, the picture of a complicated social life, the strain of philosophic reflection—are wholly at variance with what is known of the 10th century B.C. and with the Hebrew literature down to the 5th or 4th century B.C. The introduction of Solomon, the ideal of wisdom, is a literary device of the later time, and probably deceived nobody. The decisive considerations for the determination of the date are the language, the historical background and the thought. The language belongs to the post-classical period of Hebrew. The numerous Aramaicisms point to a time certainly not earlier than the 4th century B.C., and probably (though the history of the penetration of Aramaic into Hebrew speech is not definitely known) not earlier than the 3rd century. More than this, there are many resemblances between the dialect of Koheleth and that of Mishna. Not only are new words employed, and old words in new significations, but the grammatical structure has a modern stamp—some phrases have the appearance of having been translated out of Aramaic into Hebrew. By about the beginning of our era the Jews had given up Hebrew and wrote in Aramaic; the process of expulsion had been going on, doubtless, for some time; but comparison with the later extant literature (*Chronicles*, the Hebrew *Ecclesiasticus* or *Ben-Sira*, *Esther*) makes it improbable that such Hebrew as that of Koheleth would have been written earlier than the 2nd century B.C. (for details see Driver's *Introduction*). The general historical situation, also, presupposed or referred to, is that of the period from the year 200 B.C. to the beginning of our era; in particular, the familiar references to kings as a part of the social system, and to social dislocations (servants and princes changing places, x. 7), suggest the troublous time of the later Greek and the Maccabean rulers, of which the history of Josephus gives a good picture.

The conception of the world and of human life as controlled by natural law, a naturalistic cosmos, is alien not only to the prophetic and liturgical Hebrew literature but also to Hebrew thought in general. Whether borrowed or not, it must be late; and its resemblance to Greek ideas suggests Greek influence. The supposition of such influence is favoured by some critics (Tyler, Plumptre, Palm, Siegfried, Cheyne in his *Jewish Religious Life after the Exile*, and others), rejected by some (Zeller, Renan, Kleinert and others). This disagreement comes largely from the attempts made to find definitely expressed Greek philosophical dogmas in the book; such formulas it has not, but the general air of Greek reflection seems unmistakable. The scepticism of Koheleth differs from that of Job in quality and scope: it is deliberate and calm, not wrung out by personal suffering; and it relates to the whole course and constitution of nature, not merely to the injustices of fortune. Such a conception has a Greek tinge, and would be found in Jewish circles, probably, not before the 2nd century B.C.

A precise indication of date has been sought in certain supposed references or allusions to historical facts. The mention of persons who do not sacrifice or take oaths (ix. 2) is held by some to point to the Essenes; if this be so, it is not chronologically precise, since we have not the means of determining the beginning of the movement of thought that issued in Essenism. So also the coincidences of thought with *Ben-Sira* (*Ecclesiasticus*) are not decisive: cf. lii. 14 with *B.S.* xviii. 6; v. 2-6 (3-7) with *B.S.* xxiv. 1-7; vii. 10 with *B.S.* xxxvii. 14; x. 8 with *B.S.* xxvii. 260; xi. 10 with *B.S.* xxx. 21; xii. 10, 11 with *B.S.* xxxix. 2 ff.;

xii. 13 with *B.S.* xliii. 27; if there be borrowing in these passages, it is not clear on which side it lies; and it is not certain that there is borrowing—the thoughts may have been taken independently by the two authors from the same source. In any case, since *Ben-Sira* belongs to about 180 B.C., the date of Koheleth, so far as these coincidences indicate it, would not be far from 200 B.C. The contrast made in x. 16 f. between a king who is a boy and one who is of noble birth may allude to historical persons. The antithesis is not exact; we expect either "boy and mature man" or "low-born and high-born." The "child" might be Antiochus V. (164 B.C.), or Ptolemy V., Epiphanes (204 B.C.), but the reference is too general to be decisive. The text of the obscure passage iv. 13-16 is in bad condition, and it is only by considerable changes that a clear meaning can be got from it. The two personages—the "old and foolish king" and the "poor and wise youth"—have been supposed (by Winckler) to be Antiochus Epiphanes (175-164 B.C.) and Demetrius (162-150 B.C.), or (by Haupt) Antiochus and the impostor Alexander Balas (150-146 B.C.), or (by others) Demetrius and Alexander; in favour of Alexander as the "youth" it may be said that he was of obscure origin, was at first popular, and was later abandoned by his friends. Such identifications, however, do not fix the date of the book precisely; the author may have referred to events that happened before his time. The reign of Herod, a period of despotism and terror, and of strife between Jewish religious parties, is preferred by some scholars (Grätz, Cheyne and others) as best answering to the social situation depicted in the book, while still others (as Renan) decide for the reign of Alexander Jannæus (104-78 B.C.). The data are not numerous and distinct enough to settle the question beyond determining general limits: for reasons given above the book can hardly have been composed before about 200 B.C., and if, as is probable, a Septuagint translation of it was made (though the present Septuagint text shows the influence of Aquila), it is to be put earlier than 50 A.C. Probably also, its different parts are of different dates.

Of the author nothing is known beyond the obvious fact that he was a man of wide observation and philosophic thought, of the Sadducean type in religion, but non-Jewish in his attitude toward life. He was, doubtless, a man of high standing, but neither a king nor a high-priest, certainly not the apostate priest Alcimus (1 Macc. vii. ix.); nor was he necessarily a physician—there are no details in ch. xii. or elsewhere that any man of good intelligence might not know. The book is written in prose, some of which is rhythmical, with bits of verse here and there: thus i. 2-11 is balanced prose, 12-14 plain prose, 15 a couplet, i. 16-ii. 25 simple prose, vii. contains a number of poetical aphorisms, and so on. Some of the verses are apparently from the author, some from editors.

The fortunes of the book are not known in detail, but it is clear that its merciless criticism of life and its literary charm made it popular, while its scepticism excited the apprehensions of pious conservatives. Possibly the *Wisdom of Solomon* (c. 50 B.C.) was written partly as a reply to it. The claim of sacredness made for it was warmly contested by some Jewish scholars. In spite of the relief afforded by orthodox additions, it was urged that its Epicurean sentiments contradicted the Torah and favoured heresy. Finally, by some process of reasoning not fully recorded, the difficulties were set aside and the book was received into the sacred canon; Jerome (on Eccl. xii. 13, 14) declares that the decisive fact was the orthodox statement at the end of the book: the one important thing is to fear God and keep His commandments. The probability is that the book had received the stamp of popular approbation before the end of the 1st century of our era, and the leading men did not dare to reject it. It is not certain that it is quoted in the New Testament, but it appears to be included in Josephus' list of sacred books.

LITERATURE.—For the older works see Zöckler (in Lange's *Comm.*); for Jewish commentaries see Zedner, *Cat. of Heb. books in Libry. of Brit. Mus.* (1867), and for the history of the interpretations, C. D. Ginsburg, *Koheleth* (1861). *Introductions* of A. Kuenen, S. R. Driver, Cornhill, König. Articles in Herzog-Hauck, *Realencycl.* (by F. Kleinert); Hastings, *Dict. Bible* (by A. S. Peake); T. K. Cheyne.

Encycl. Bibl. (by A. B. Davidson); *Jew. Encycl.* (by D. S. Margoliouth). Commentaries: F. Hitzig (1847); C. D. Ginsburg (1861); H. Grätz (1871); Tyler (1874); Delitzsch (1875); E. H. Plumptre (1881); C. H. H. Wright (1883); Nowack, revision of Hitzig (1883); Volck (in Strack u. Zöckler's *Kursgef. Komm.*, 1889); Wildboer (in Marti's *Kurzer Hand-Komm.*, 1898); C. Siegfried (in W. Nowack's *Handkomm.*, 1898); Coort (in *De Oude Test.*, 1899). Other works: C. Taylor, *Dirge of Koh.* (1873); Wünsche, *Midrash on Koh.* (in his *Bidkoth rabbin.*, 1880); E. Kennan, *L'Ecclesiaste* (1882); Bickell, *Der Prediger* (1884) and *Kohel-Untersuchungen* (1886); Engl. by E. J. Dillon, *Scriptures of Old Test.*, 1893; Schäffer, *Das Buch Koh. nach d. Ausg. d. Weissen d. Talmuds*, &c. (1884); A. Palm, *Koh. u. d. nach-aholter. Philosophie* (1885); and *Die Koh.-Lit.* (1886); E. Pfeiderer, *Die Phil. d. Herablit.*, &c. (1886); Cheyne, *Job and Solomon* (1887) and *Jew. Relig. Life*, &c. (1898); W. Euringer, *Der Masorah d. Koh.* (1890); W. T. Davison, *Wisdom-Lit. of Old Test.* (1894); H. Winkler, in his *Allortier. Forschungen* (1898); J. F. Genung, *Words of Koh.* (Boston, Mass., 1904); P. Haupt, *Ecclesiastes* (Baltimore, 1905). The rabbinical discussions of the book are mentioned in *Shabbath*, 30b; *Megilla*, 7a; *Eduyoth*, v. 3; *Mishna Yadaim*, iii. 5, iv. 6; *Midrash Koheleth* (on xi. 9), *Aboth d' Rab. Nathan*, i.

ECCLESIASTICAL COMMISSIONERS, in England, a body corporate, whose full title is "Ecclesiastical and Church Estates Commissioners for England," invested with very important powers, under the operation of which extensive changes have been made in the distribution of the revenues of the Established Church. Their appointment was one of the results of the vigorous movements for the reform of public institutions which followed the Reform Act of 1832. In 1835 two commissions were appointed "to consider the state of the several dioceses of England and Wales, with reference to the amount of their revenues and the more equal distribution of episcopal duties, and the prevention of the necessity of attaching by commendam to bishops certain benefices with cure of souls; and to consider also the state of the several cathedral and collegiate churches in England and Wales, with a view to the suggestion of such measures as might render them conducive to the efficiency of the established church, and to provide for the best mode of providing for the cure of souls, with special reference to the residence of the clergy on their respective benefices." And it was enacted by an act of 1835 that during the existence of the commission the profits of dignities and benefices without cure of souls becoming vacant should be paid over to the treasurer of Queen Anne's Bounty. In consequence of the recommendation of these commissioners, a permanent commission was appointed by the Ecclesiastical Commissioners Act 1836 for the purpose of preparing and laying before the king in council such schemes as should appear to them to be best adapted for carrying into effect the alterations suggested in the report of the original commission and recited in the act. The new commission was constituted a corporation with power to purchase and hold lands for the purposes of the act, notwithstanding the statutes of mortmain. The first members of the commission were the two archbishops and three bishops, the lord chancellor and the principal officers of state, and three laymen named in the act.

The constitution of the commission was amended by the Ecclesiastical Commissioners Act 1840 and subsequent acts, and now consists of the two archbishops, all the bishops, the deans of Canterbury, St Paul's and Westminster, the lord chancellor, the lord president of the council, the first lord of the treasury, the chancellor of the exchequer, the home secretary, the lord chief justice, the master of the rolls, two judges of the admiralty division, and certain laymen appointed by the crown and by the archbishop of Canterbury. The lay commissioners are required to be "members of the Church of England, and to subscribe a declaration to that effect." The crown also appoints two laymen as church estates commissioners, and the archbishop of Canterbury one. These three are the joint treasurers of the commission, and constitute, along with two members appointed by the commission, the church estates committee, charged with all business relating to the sale, purchase, exchange, letting or management of any lands, tithes or hereditaments. The commission has power to make inquiries and examine witnesses on oath. Five commissioners are a quorum for the transaction of business, provided two of them are church estates commissioners; two

ecclesiastical commissioners at least must be present at any proceeding under the common seal, and if only two are present they can demand its postponement to a subsequent meeting. The schemes of the commission having, after due notice to persons affected thereby, been laid before the king in council, may be ratified by orders, specifying the times when they shall take effect, and such orders when published in the *London Gazette* have the same force and effect as acts of parliament.

The recommendations of the commission recited in the act of 1836 are too numerous to be given here. They include an extensive rearrangement of the dioceses, equalization of episcopal income, providing residences, &c. By the act of 1840 the fourth report of the original commissioners, dealing chiefly with cathedral and collegiate churches, was carried into effect, a large number of canopies being suspended, and insecure benefices and dignities suppressed.

The emoluments of these suppressed or suspended offices, and the surplus income of the episcopal sees, constitute the fund at the disposal of the commissioners. By an act of 1860, on the avoidance of any bishopric or archbishopric, all the land and emoluments of the see, except the patronage and lands attached to houses of residence, become, by order in council, vested in the commissioners, who may, however, reassign to the see so much of the land as may be sufficient to secure the net annual income named for it by statute or order. All the profits and emoluments of the suspended canopies, &c., pass over to the commissioners, as well as the separate estates of those deaneries and canopies which are not suspended. Out of this fund the expenses of the commission are to be paid, and the residue is to be devoted to increasing the efficiency of the church by the augmentation of the smaller bishoprics and of poor livings, the endowment of new churches, and employment of additional ministers.

The substitution of one central corporation for the many local and independent corporations of the church, so far at least as the management of property is concerned, was a constitutional change of great importance, and the effect of it undoubtedly was to correct the anomalous distribution of ecclesiastical revenues by equalizing incomes and abolishing sinecures. At the same time it was regarded as having made a serious breach in the legal theory of ecclesiastical property. "The important principle," says Cripps, "on which the inviolability of the church establishment depends, that the church generally possesses no property as a corporation, or which is applicable to general purposes, but that such particular ecclesiastical corporation, whether aggregate or sole, has its property separate, distinct and inalienable, according to the intention of the original endowment, was given up without an effort to defend it" (*Law Relating to the Church and Clergy*, p. 46).

ECCLESIASTICAL JURISDICTION. This phrase in its primary sense imports not jurisdiction over ecclesiastics, but jurisdiction exercised by ecclesiastics over other ecclesiastics and over the laity. "Jurisdiction" is a word borrowed from the jurists which has acquired a wide extension in theology, wherein, for example, it is frequently used in contradistinction to "order," to express the right to administer sacraments as something superadded to the power to celebrate them. So it is used to express the territorial or other limits of ecclesiastical, executive or legislative authority. Here it is used, in the limited sense defined by an American Court, as "the authority by which judicial officers take cognizance of and decide causes."

Such authority in the minds of lay Roman lawyers who first used this word "jurisdiction" was essentially temporal in its origin and in its sphere. The Christian Church transferred the notion to the spiritual domain as part of the general idea of a Kingdom of God correlative, on the spiritual side of man upon earth, to the powers, also ordained of God, who had dominion over his temporal estate (see CANON LAW). As the Church in the earliest ages had executive and legislative power in its own spiritual sphere, so also it had "judicial officers," "taking cognizance of and deciding causes." Only before its union with the State, its power in this direction, as in others, was merely over the spirits of men. Coercive temporal authority over their bodies or estates could only be given by concession from the temporal prince. Moreover, even spiritual authority over members of the Church, i.e. baptized persons, could not be exclusively claimed as of right by the Church tribunals, if the subject matter of the cause were purely temporal. On the other hand, it is clear that all the faithful were subject to these courts (when acting within their own sphere), and that, in the earliest times, no distinction was made in this respect between clergy and laity.

The fundamental principle of ecclesiastical jurisdiction with its

Origin of ecclesiastical jurisdiction.

"sanction" of excommunication will be found in Christ's words in Matt. xviii. 15-18. A very early example of criminal spiritual jurisdiction exercised by St Paul is found in the case of the incestuous Corinthian (1 Cor. v.). We find later the same apostle exercising like jurisdiction in the cause of Hymenaeus and Alexander (1 Tim. i. 20). After the time of the Apostles, we find this criminal jurisdiction exercised by the bishops individually over their respective "subjects"—doubtless with the advice of their presbyters according to the precept of St Ignatius (c. 110). As neighbouring dioceses coalesced into "provinces" and provinces into larger districts (corresponding to the civil "dioceses" of the later Roman Empire), the provincial synods of bishops and the synods of the larger districts acquired a criminal jurisdiction, still purely spiritual, of their own. At first this was "original" and mainly (although not exclusively) over bishops (of the province or larger district). The beginnings of an appellate jurisdiction in the cases of clerics and laymen may be traced before the conversion of the Empire. The bishop over whom the synod of neighbouring bishops had exercised jurisdiction had no formal right of appeal; but sometimes bishops in other parts of the Church would refuse to acknowledge the local synodical sentence and would communicate with a bishop whom they deemed unjustly deposed. The theory, as expressed in legal phrase by St Cyprian in the 3rd century, was that the apostolic power of delegated sovereignty from the Lord, alike legislative and judicial, was held in joint-tenancy by the whole body of Catholic bishops. In both capacities, however, a certain undefined pre-eminence was conceded to the occupants of "Apostolic" sees, i.e. sees traditionally founded by Apostles, or of sees with a special secular position.

Even before the edict of Milan, at least as early as the latter half of the 3rd century, the spiritual sentences of deposition from office had sometimes indirect temporal consequences recognized by the secular courts. The classical example is the case of Paul of Samosata, bishop of Antioch. It would seem that, in the intervals of persecution, some rights of property were recognized in the Christian Church and its officers; although the Church was an illegal society. After some previous abortive trials, Paul of Samosata was deposed and excommunicated, in 269, by a great synod of the Antiochene district. Paul, notwithstanding his deposition, kept possession of the episcopal residence. The local church sought recovery of it before the tribunals of the Empire. The judicial authorities requested a rescript from the emperor Aurelian for the decision of the cause. Aurelian referred the matter to the bishop of Rome and the bishops of Italy, who gave their award in favour of the Antiochene Church.

Side by side with this which we may call criminal jurisdiction—none the less real or coercive because its sanctions were purely spiritual—there grew up a quasi-jurisdiction in causes entirely temporal, based upon the free consent of the parties to accept the arbitration of the bishop. This system had also its roots in the New Testament (see Matt. xviii. 15-17 and 1 Cor. vi. 1-8). In the matter of criminal jurisdiction we paused for a moment at the edict of Milan; but we may at once trace this second or civil branch of episcopal judicature or quasi-judicature down as far as the reign of Charlemagne, when it underwent a fundamental change, and became, if either litigant once chose, no longer a matter of consent but of right.

Constantine decreed that judgment in causes might be passed by bishops when litigants preferred their adjudication to that of the secular courts (see his epistle to the Numidian bishops and *Cod. Theodos. Tit. de Episcopis*). The episcopal judgment was to be equivalent to that of the emperor and irreversible, and the civil authorities were to see to its execution. Saints Ambrose and Augustine both spent days in deciding temporal causes. Honorius, in the West, at the end of the 4th century, made a constitution providing that if any desired to litigate before the bishops they should not be forbidden, but that in civil matters the prelates should render judgment in the manner of arbitrators by consent (*Cod. 1, Tit. iv.*). Where the faithful had had recourse to the bishop, no appeal was to be allowed, and the judges were

to command execution of the episcopal decree. A quarter of a century later, however, Valentinian III. in the West expressly provided that bishops were not to be permitted to be judges (that is, of course, in temporal causes), save by the consent of the parties. This legislation was, substantially, adopted by Justinian.

On the revival of the Western Empire, however, Charlemagne, in the beginning of the 9th century, under the mistaken belief that he was following the authority of Constantine I. and Theodosius I, took a great step forward, by which the bishop ceased to be a mere legally indicated arbitrator by consent in secular causes, and became a real judge. By a capitulary he provided that either litigant, without the consent of the other party, and not only at the beginning of a suit but at any time during its continuance, might take the cause from lay cognizance and transfer it to the bishop's tribunal. He re-enacted the prohibition of appeal.

It should be remembered that, from the latter part of the 3rd century, the leading bishops had generally been trained in secular learning. St Cyprian, St Ambrose and St Augustine, St Paulinus of Nola and St John Chrysostom had practised law as teachers or advocates. St Ambrose and St Paulinus had even held high administrative and judicial offices.

To return to the evolution of ecclesiastical jurisdiction from the time of Constantine. With the "Nicene period" came a great development on the criminal side. A system begins to be formed, and the secular arm supports the decrees of the Church. The first trace of system is in the limited right of appeal given by the first oecumenical council of Nicaea and its provision that episcopal sentences or those of provincial synods on appeal were to be recognized throughout the world. The fifth canon provides that those, whether clerics or laymen, who are cut off from communion in any particular province are not to be admitted thereto elsewhere. Still examination must be had whether persons have been expelled from the congregation by any episcopal small-mindedness (*μακροψυχία*), or contentious spirit, or such-like harshness (*ἀσπλα*). That this may be conveniently inquired into, synods are to be held, three in every year, in each province, and questions of this kind examined. There is to be no "stay of execution"; the episcopal sentence is to prevail until the provincial synod otherwise decide. It will be noticed that as yet no provision is made for appeals by bishops from provincial synods sitting in first instance.

The edicts of Milan had only admitted the Christian Church among the number of lawful religions; but the tendency (except in the time of Julian) was towards making it the only lawful religion. Hence the practice, immediately after Nicaea I., of superadding banishment by the emperor to synodical condemnation. The dogmatic decrees of Nicaea I. were at once enforced in this temporal manner. On the other hand, the Arian reaction at court worked its objects (see Pusey, *Councils of the Church*) by using the criminal spiritual jurisdiction of synods against the Catholics—often packing the synods for the purpose. The acts of councils of this age are full of the trials of bishops not only for heresy but for immorality and common law crimes. The accusations are frequently unfounded; but the trials are already conducted in a certain regular forensic form. The secular authorities follow the precedent of Nicaea I. and intervene to supplement the spiritual sentence by administrative penalties. Sometimes an imperial officer of high rank (as, e.g. a "count") is present at the synod; as an assessor to maintain order and advise upon points of procedure. Leading examples may be found in the various prosecutions of St Athanasius, in whose case also there is the germ of an appeal, *tanquam ad absurdum*. It has been contended that, according to later and more formulated jurisprudence, such an appeal would have lain, since the trial at Tyre was not concerned with purely spiritual matters (see the case in Hefele, *Councils, in loc.*).

The trial of St Athanasius led to extensions of the right of appeal. This was favoured by the development of the greater sees into positions of great administrative dignity, shortly to be called "patriarchal." A synod was held at Rome, attended

Temporal
jurisdiction
of the
Church.

Roman
empire
Area Con-
stantine.

by bishops from various regions, which reversed the original judgment of the synod of Tyre which had condemned Athanasius. A much larger synod at Antioch, gathered only from the East, on the other hand, confirmed that judgment. This last synod did something to systematize the criminal procedure of the Church, and its legislation has been always received.

This legislation marks another step forward. Deposition of a bishop by a synod, or of a priest or deacon by his bishop, is to take effect even pending an appeal, and a cleric continuing his functions after sentence in first instance is to lose all right of appeal. The appeal given by Nicaea I. to clerics and laymen from episcopal excommunications is extended. The synod may restore them if convinced of the justice of their cause (and not merely in cases of *ἀνόμια*). A bishop may appeal to a great assembly of bishops. Any bishop, priest or deacon "importuning" the emperor, instead of exerting his right of appeal to synods, is to lose all right of appeal and never to be restored or pardoned. If a provincial synod be divided as to the guilt of a bishop, the metropolitan is to convene bishops from the neighbouring provinces to decide the cause jointly with the bishops of the original province.

A few years later, in 347, the council of Sardica, a council of practically the whole West save Africa, reversed Tyre and acquitted St Athanasius after a full judicial inquiry. This council endeavoured to set up a system of appeals in the case of bishops, in which the see of Rome was made to play a great part. "Out of honour to the memory of St Peter," a condemned bishop may ask the intervention of Rome. If this be done, the synod of first instance is to send letters to Julius, bishop of Rome. If that prelate think the cause should be heard again, he is to appoint judges; if otherwise, the original judgment is to be confirmed. Pending appeal, the appellant's see is not to be filled up. The judges appointed by the bishop of Rome to hear the appeal are to be from the neighbouring provinces. The appellant may, however, request that bishop to send priests from his side to sit with the synod of appeal. If such priests are sent, they are to preside in the court of appeal. These canons were always repudiated in the East, and when, sixty years afterwards, they were, for the first time, heard of in Africa, they were repudiated there also.

A rescript of Gratian in 378 empowered the bishop of Rome to judge bishops with the assistance of six or seven other bishops or, in the case of a metropolitan, of fifteen comprovincial bishops. A bishop refusing to come to Rome was to be brought there by the civil power. The rescript, however, was not incorporated in the Codes and perhaps was only a temporary measure.

The tendency to give pre-eminence to Rome appears again in an imperial letter to St Flavian, who, in the judgment of the East, was bishop of Antioch, but who was rejected by the West and Egypt, summoning him to Rome to be there judged by the bishops of the imperial city—a summons which St Flavian did not obey (Tillemont, *Mém. Eccl.*). In Africa in the beginning of the 5th century Apiarius, a priest who had been deposed by the bishop of Sicca for immorality, and whose deposition had been affirmed by the "provincial synod," instead of further appealing to a general synod of Africa, carried his appeal to Pope Zosimus. The pope received the appeal, absolved him and restored him to the rank of priest, and sent a bishop and two priests as legates to Africa with instructions to them to hear the cause of Apiarius anew and for execution of their sentence to crave the prefect's aid; moreover, they were to summon the bishop of Sicca to Rome and to excommunicate him, unless he should amend those things which the legates deemed wrong. The upshot of a long conflict was that the papal claim to entertain appeals from Africa by priests and deacons was rejected by the African bishops, who in their final synodical epistle also repudiate in terms any right of appeal by African bishops to "parts beyond the seas" (see Hefele, *Councils*, bk. viii.).

The story of the administrative development of the Church in the 5th century is mainly the story of the final emergence and constitution of the great "patriarchates," as authorities superior to metropolitans and provincial synods. In consequence of the

occupants of the thrones of Constantinople and Alexandria falling successively into opposite heresies, the question arose how "patriarchs" were to be judged. In both cases, as it seems, an attempt was made by the bishop of Rome to depose the erring patriarch by his authority as primate of Christendom, acting in concert with a Western synod. In both cases, apparently, an oecumenical synod ignored the Roman deposition and judged the alleged offences of the respective patriarchs in first and last instance. The third and fourth oecumenical synods (Ephesus, 431; Chalcedon, 451) were primarily tribunals for the trials of Nestorius and Dioscorus; it was secondarily that they became organs of the universal episcopate for the definition of the faith, or legislative assemblies for the enactment of canons. Nothing is more remarkable than their minute care as to observance of rules of procedure. In both cases, imperial assessors were appointed. At Ephesus the Count Candidian was commissioned to maintain order, but took little part in the proceedings. At Chalcedon, on the other hand, the imperial commissioners decided points of order, kept the synod to the question, took the votes and adjourned the court. But the synod alone judged and pronounced sentence. No oecumenical synod has tried a patriarch of Old Rome while yet in the flesh. The fifth oecumenical council came nearest to so doing, in the case of Vigilius. That pope, although in Constantinople, refused to attend the sittings of the council. He was cited three times, in the canonical manner, and upon not appearing was threatened in the third session with anathema (Hefele, *Councils*, sect. 268 *ad fin.*). He was not, however, charged with direct heresy, as were Nestorius and Dioscorus, and the synod seems to have hesitated to deal stringently with the primate of Christendom. In the seventh session it accepted the suggestion of Justinian, merely to order the name of Vigilius to be removed from the liturgical prayers, at the same time expressing its desire to maintain unity with the see of Old Rome (Hefele, sect. 273). After the council, Justinian banished the pope to Egypt, and afterwards to an island, until he accepted the council, which he ultimately did (*ib.* 276). The sixth oecumenical synod decreed that the dead pope Honorius should be "cast out from the holy Catholic Church of God" and anathematized, a sentence approved by the reigning pope Leo II. and affirmed by the seventh oecumenical synod in 787.

The constitution of the patriarchal system resulted in the recognition of a certain right of appeal to Rome from the larger part of the West. Britain remained outside that jurisdiction, the Celtic churches of the British islands, after those islands were abandoned by the Empire, pursuing a course of their own. In the East, Constantinople, from its principality, acquired special administrative pre-eminence, naturally followed, as in the case of "old Rome," by judicial pre-eminence. An example of this is found in the ninth canon of Chalcedon, which also illustrates the enforcement upon a clerical plaintiff in dispute with a brother cleric of that recourse to the arbitration of their ecclesiastical superior already mentioned. The canon provides that any clerk having a complaint against another clerk must not pass by his own bishop and turn to secular tribunals, but first lay bare his cause before him, so that by the sentence of the bishop himself the dispute may be settled by arbitrators acceptable to both parties. Any one acting against these provisions shall be subject to canonical penalties. If any clerk have a complaint against his own bishop, he shall have his cause adjudicated upon by the synod of the province. But if a bishop or clerk have a difference with the metropolitan of his province let him bring it before the exarch of the "diocese" (*i.e.* the larger district answering to the civil "diocese"), or before the royal see of Constantinople, who shall do justice upon it. An "exarch" means properly a superior metropolitan having several provinces under him. In the next century Justinian (*Nov.* 123, c. 22) put the other patriarchates on the same footing as Constantinople. In c. 21 he gives either plaintiff or defendant an appeal within ten days to the secular judge of the locality from the bishop's judgment. If there be no appeal, that judge is to give execution to the episcopal award. The growth of a special "original" jurisdiction at Constantinople, which perhaps

developed earlier than the corresponding institution at Rome, may be traced to the fact that bishops from all parts were constantly in Constantinople. The bishop of Constantinople, even before he became properly "patriarch," would often assemble a synod from these visiting bishops, which acquired the technical name of *συνδος ἐπιθουαία*, the synod of sojourners. This synod frequently decided questions belonging to other patriarchates.

The criminal jurisdiction thus exercised was generally speaking unlimited. It must be remembered that the *forum externum* of the ecclesiastical jurisdiction, in the sense in which we now use the phrase, of a judge deciding causes, was not then clearly marked off from the *forum internum*, or what afterwards came to be called the "tribunal of penance" (see Van Espen, *Jus ecc. univ.* pars iii. tit. iv. c. 1). Ecclesiastical proceedings by way of prosecution are called "criminal," but they are primarily *pro salute animae*; whereas temporal criminal proceedings are primarily for the protection of the state and its citizens. Hence a Christian might be first punished in the civil courts and then put to public penance by the ecclesiastical jurisdiction, or vice versa: an apparently double system of punishment which the medieval Church, when the *forum externum* had become quite separated from the *forum internum*, sometimes repudiated (see Maitland, *English Canon Law*, 138, 139, 144).

Theodosius began the system of giving secular authority to Church tribunals. Thus, in 376, L. 23 *Cod. Theodos. de. Episcopis, &c.*, subjected clerics for small offences pertaining to the observances of religion to bishops and synods. In 390, L. 1 *Cod. de Religione* provides that, when it is a matter of religion, it becomes the bishop to judge. A rescript of Constantius, in 355, inserted in *Cod. Theod. lxi. de Epis. Ecc. et Cler.*, excluded bishops from accusations before secular judges and commanded such accusations to be speedily brought before the tribunal of other bishops. This law was probably only intended to be of a temporary character. Then comes the law of Gratian already noticed. Then, in 390, a law of Honorius (*Cod. Theod. l. 1 de Religione*): "As often as it concerns religion, it is meet that the bishops should judge, but other causes which belong to ordinary jurisdiction or to public law are to be heard in the ordinary courts (*legibus oportet audiri*)." L. 3 *de Epis. Jud.*, at the end of the Theodosian Code, seems spurious (see the comment of Gothofredus *in loco*). But a constitution of Honorius in 412 (*Cod. Theod. l. xli. de Epis. Ecc. et Cler.*) provides that clerics are not to be accused except before the bishop. Bishops, priests, deacons, and every other "minister of the Christian law" of inferior degree, are taken from secular jurisdiction in criminal cases. The words are quite general; but it has been contended that they apply only to crimes of an ecclesiastical character (see Gothofredus *in loc.*; Van Espen, pars iii. tit. iii. c. 1, 10). In 425 a constitution of Theodosius II. provides that a recent decree of the usurper John should be disregarded and that clerks whom he had brought before secular judges should be reserved for the episcopal jurisdictions, "since it is not lawful to subject the ministers of the divine office to the arbitrament of temporal powers." Justinian has a clearer perception of the demarcation between the spheres of spiritual and temporal law. The 83rd Novell provides that if the offence be ecclesiastical, needing ecclesiastical correction, the bishop shall take cognizance of it. The 123rd Novell (c. 21) provides that if a clerk be accused of a secular crime he shall be accused before his bishop, who may depose him from his office and order, and then the competent judge may take him and deal with him according to the laws. If the prosecutor have first brought him before the civil judge, the evidence is to be sent to the bishop, and the latter, if he thinks the crime has been committed, may deprive him of his office and order, and the judge shall apply to him the proper legal punishment. But if the bishop think the evidence insufficient, the affair shall be referred to the emperor, by way of appeal both from bishop and judge. If the cause be ecclesiastical, the civil judges are to take no part in the inquiry. The law includes with clerics, monks, deaconesses, nuns, ascetics; and the word "clerics" covered persons in minor orders, down to doorkeepers.

It will be noticed that Justinian supposes that the prosecutor may begin the proceedings before the civil judge. A constitution of Alexius Comnenus I. seems to send him to the special forum of the accused.

Certain enactments of later Saxon times in England have been sometimes spoken of as though they united together the temporal and spiritual jurisdictions into one mixed tribunal deriving its authority from the State. In the latter part of the 10th century, laws of Edgar provided that the bishop should be at the county court and also the alderman, and that there each of them should put in use both God's laws and the world's law (Johnson's *English Canons*, i. 411). This probably was, as Johnson suggests, that the bishop might enforce secular laws by ecclesiastical censure and the alderman ecclesiastical laws with secular punishment. But the two jurisdictions were kept separate; for by another law of Edgar (*Leges Edg. c. v.*) it was provided that "in the most august assembly the bishop and alderman should be present, and the one should interpret to the people the law of God, the other the laws of men." Edgar, in a speech to St Dunstan and the bishops in synod (in 969), said, "I hold in my hands the sword of Constantine, you that of Peter. Let us join right hands and unite sword to sword" (Hardouin, *Conc. tom. vi. p. 1, col. 675*). The juxtaposition of the judicatures may, however, have led to some confusion between them.

As to appeals the mixed council of Cliff at Hoo (747) said they should go to the synod of the province. The only appeal to Rome in Saxon times was that of St Wilfrid, bishop of York, who appealed from the division of his see and his deposition for refusing to consent to it, and was heard in a Roman synod under the presidency of Pope Agatho. The synod found him unlawfully deposed and ordered his restoration. Upon his return to England, the Roman judgment was refused recognition and he was for a time imprisoned. Ten years later he was recalled to York, but refusing to consent to the division of his see was again deposed and again appealed to Rome. The appeal was heard at great length, in a synod of 703 under John VI., deputies from the archbishop of Canterbury being present. St Wilfrid was justified and was sent back to his see, with papal letters to the kings of Northumbria and Mercia. The Roman decree was again disregarded. At the council of "Nid" he was reconciled to the other bishops of the province, but not restored. In the end he was brought back to York, but not to the undivided see. The details of the case will be found in Wilkins, *Concilia*, in Mansi, *Concilia*, under the various councils named, and in Haddan & Stubbs, *Councils and Ecd. Documents*, vol. iii.

The penalties which the spiritual court could inflict, in the period between the edict of Milan and c. 854, were properly excommunication whether generally or as exclusion from the sacraments for a term of months or years or till the day of death and (in the case of clerics) suspension or deposition. Gradually, however, doubtless by way of commutation of excommunication and of penance, temporal penalties were added, as scourging, banishment, seclusion in a monastery, fines. It is difficult to say how far some of these temporal penalties were penitential only or how far they could be inflicted *in impios*. But the secular arm, from the time of Niceæ I., was in the habit of aiding spiritual decrees, as by banishing deposed bishops, and gradually by other ways, even with laymen. Scourging (although it had been a well-known punishment of the synagogue) was at first forbidden. Can. 25 (26) of the Apostolic Canons imposes deposition on any bishop, priest or deacon striking the delinquent faithful. In Africa, however, a contrary practice early sprang up (see St Augustine, *Epist. clix. ad Marcellum d. cxxxiii.*). The small council of Vannes in Brittany in 465 made it an alternative punishment for clerks convicted of drunkenness (Can. 13). Canon 13 of the first council of Orleans, which has been cited in this matter, seems to have no application. St Gregory the Great seems to assume that scourging and seclusion in a monastery are in the discretion of episcopal tribunals (see *Epistles*, lib. ii. ep. 11, 40, 42, 44, 45; lib. vii. ep. 11, 67; lib. xii. ep. 31, c. 4). The 16th council of Toledo

Anglo-Saxons courts.

Penalties inflicted by ecclesiastical courts.

(in 693) has been cited as if it visited certain very great sinners with scourging as an ecclesiastical punishment. In fact, it only approves the punishment as ordered by the Visigothic laws. An alleged decree of a council of Autun in 670 is part of a code of discipline for monasteries (see authorities cited by Hefele, *Councils*, sect. 290, towards the end). Banishment does not seem to have been inflicted by the spiritual court *in invitum*. Seclusion in a monastery seems first to have been used by the civil power in aid of the spiritual. The fifth canon of the council of Macon, in 584, forbids clergy to dress like laymen and imposes a penalty of thirty days' imprisonment on bread and water; but this may be merely penitential. There is little evidence of the imposition of fines as ecclesiastical penalties; but there are references to the practice in the epistles of St Gregory the Great, notably in his instructions to St Augustine. Gregory III. copies from St Gregory I. Probably these also were by way of penance. Isolated examples in the early middle ages of metropolitans dealing with their suffragan bishops by imprisonment in chains were extra-canonical abuses, connected with the perversion of Church law which treated the metropolitan (who originally was merely convener of the provincial synod and its representative during the intervals of sessions) as the feudal "lord" of his comprovincials.

With the later 9th century we enter upon a new epoch, and by the time of Gregory VII., in the 11th century, the tribunals have fallen into the hands of a regular class of canonists who are in fact professional church-lawyers in orders. The changes due to the adoption of the False Decretals by Nicholas I. and the application of their principles by Hildebrand (afterwards Gregory VII.) are discussed in the article CANON LAW. The later medieval system, thus inaugurated, may be considered (1) in its hierarchy, (2) in the subject matter of its jurisdiction, (3) in its penalties.

1. (a) It is a system of courts. Much that had been done by bishops, *sine strepitu forensi et figura iudicii*, is now done in the course of regular judicial procedure. Again, the court takes the place of the synod. The diocesan synod ceases to have judicial work. The court of the metropolitan takes the place of the provincial synod, except possibly for the trial of bishops, and even this becomes doubtful.

(b) At first the bishop was the only judge in the diocesan court and he always remains a judge. But just as the king appoints judges to hear *placita coram rege ipso*, and the feudal lord appoints his seneschal or steward, so the bishop appoints his official.

(c) The archdeacon acquires a concurrent ordinary jurisdiction with the bishop (see ARCHDEACON). For some time it was considered that he was a mere office-holder dependent on the will of the bishop with a jurisdiction merely "vicarial"; but by the 13th century it was settled that he held a "benefice" and that his jurisdiction over causes was ordinary and independent of the bishop (Van Espen, *pars i. tit. xii. c. 1*; Fournier, *Les Officialités au moyen âge*, p. 134). It was partly in order to counterpoise the power of archdeacons that bishops created officials (Fournier, p. 8). Archdeacons in course of time created officials who presided in court in their stead. The extent of jurisdiction of archdeacons depended much upon local customs. In England the custom was generally in their favour. Ordinarily, the appeal from an archdeacon or his official lay to the court of the bishop; but by custom the appeal might be to the court of the metropolitan. The Constitutions of Clarendon, in 1164, made the appeal from the court of the archdeacon lie to the court of the bishop.

(d) The official of the bishop might be his official principal, who was his *alter ego*, or a special officer for a particular locality (*officialis foraneus*). The latter was treated as a mere delegate, from whom an appeal could be made to the bishop. The former had one consistory with the bishop, so that appeals from him had to be made to the court of the metropolitan. How far the official principal had jurisdiction in criminal matters by virtue of his office, how far it was usual to add this jurisdiction by special commission, and what were the respective limits of his office and that of the vicar-general, are questions of some nicety. The emphasis in Italy was on the vicar-general (*Secl. de officio Vicarii*). In the Low Countries, France and England the jurisdiction of the official principal was wider (Van Espen,

pars i. tit. xii. cc. 4, 5; Fournier, p. 21). But he could not try criminal matters unless specially committed to him (Lyndwood, *Provinciale*, lib. ii. tit. 1). Later in England it became usual to appoint one man to the two offices and to call him chancellor, a word perhaps borrowed from cathedral chapters, and not in use for a diocesan officer till the time of Henry VIII. or later (see CHANCELLOR). In Ireland the title, till the church was disestablished, was vicar-general.

The importance of distinguishing the normal functions of an official principal and a vicar-general lies in this: that it was gradually established that as a king should not hear causes but commit them to his judges, so a bishop should not hear causes but appoint an official to hear them (see Ridley, *View of the Civil and Ecl. Law*; Ayliffe, *Parergon juris ecclesiastici*, p. 167; Godolphin, *Abridgement of the Laws Ecclesiastical*, p. 8). The "parlements" of France were constantly insisting on the independence and irremovability of the official (Fournier, p. 219). But jurisdiction which was not necessarily incident to the office of the official principal, that is to say voluntary jurisdiction, such as the granting of licences and institution to benefices, and criminal jurisdiction over clerks (and probably over laymen), the bishop could reserve to himself. Reservations of this nature are made in many English patents of chancellors and were held good in *R. v. Tristram*, 1902, 1 K.B. 816.

(e) The ecclesiastical and temporal courts are kept distinct. The charter of William the Conqueror abrogated the laws of Edgar. No bishop or archdeacon "shall any longer hold pleas in the Hundred concerning episcopal law nor draw a cause which concerns the rule of such to the judgment of men of the world" (Stubbs, *Select Charters*, part iii.). In France, where the bishop was a temporal baron, his feudal and his spiritual courts were kept by distinct officers (Fournier, p. 2).

(f) From the bishop, or his official, appeal lay to the metropolitan, who again could hear causes by his official. The Constitutions of Clarendon recognize this appeal (c. viii.).

(g) An appeal lay from the court of the metropolitan to that of the primate. There were many disputes as to the existence of these primates (see Maitland, *Canon Law in the Church of England*, p. 121). In England the dispute between Canterbury and York was settled by making them both primates, giving Canterbury the further honour of being primate of all England. In France the primatial sees and the course of appeals to them were well established (Fournier, p. 219).

(h) Several attempts were made by metropolitans and their officials to take causes arising in the dioceses of their comprovincials in the first instance and not by way of appeal. The officials of primates in their turn made similar attempts. After long struggles this was hindered, in France by the bull *Romana* (Fournier, p. 218), in England by the Bill of Citations, 23 Henry VIII. c. 9, and Canon 94 of the Canons of 1603. The preamble of the "Bill of Citations" is eloquent as to the mischief which it is framed to prevent. There are, however, a few cases in which the metropolitan is still allowed to cite in the first instance. One of them was in cases of "perplexity." "Perplexity" arose where the suffragans "could not owing to the geographical limitations of their competence do full justice" (Maitland, pp. 118-119). Such was the case of probate where notable goods of the deceased lay in more than one diocese. Hence the origin of the "prerogative court" of Canterbury (cf. Van Espen, *pars i. tit. xix.*; and for Spain, Covarruvias, *Pract. Quæst. c. 9*).

(i) Gradually there grew up a mass of peculiar and exempt jurisdictions (Ayliffe, pp. 417, 418; Phillimore, *Ecl. Law*, pp. 214, 927; de Maillane, *Dict. du droit canonique*, s.v. "Exemptions"). Exempt jurisdictions began with the monasteries and were matter of vehement discussion in the later middle ages. There were no true exemptions before the 11th century (Van Espen, *pars iii. tit. xii.*). Peculiar or special jurisdiction, equal to that of the bishop, was given to deans and chapters over the cathedral precincts and in places where they had corporate property (see *Parham v. Temple*, 3 Phil. Ecc. R. 22). Sometimes it was given to deans alone or to prebendaries in the parishes whence they derived their prebends. Where the archdeacon

had a jurisdiction co-ordinate with the bishop, it was called a peculiar. The metropolitans had peculiars within the dioceses of their comprovincials wherever they had residences or manors, and some whose origin is uncertain, e.g. that of the fifteen parishes in the deanery of the Arches. The official administering justice for the metropolitan was usually called a dean. From a peculiar jurisdiction ranking as episcopal the appeal lay to the court of the metropolitan. As to metropolitan peculiars, the metropolitan might give an appeal from the dean to his regular official principal. Thus, in Canterbury there was an appeal from the dean of Arches to the official principal of the Arches court. When peculiars were abolished (*vide infra*) the dean of Arches disappeared, and his title, in the 19th century, was erroneously given to the official principal. On peculiars in Spain cf. Covarrubias, *Works*, tit. i. p. 410. The French parlements, after the middle ages, discouraged them. In exempt convents the head of the monastery or priory exercised jurisdiction subject to an appeal to the pope.

(j) It is said that originally a metropolitan had only one official principal, who, like the metropolitan himself, acted both for the diocese and province. Fournier (p. 219) says that in France it was not till the 17th century that there grew up a custom of having different officials for the metropolitan, one for him as bishop, a second as metropolitan, and even a third as primate, with an appeal from one to the other, and that it was an abuse due to the parlements which strove to make the official independent of the bishop. In England there has been, for a long time, a separate diocesan court of Canterbury held before the "commissary." The word is significant as showing that there was something special and restricted about the position. In York there are two courts, one called the consistory for the diocese, the other called the chancery for the province. But the same person was often official of both courts.

(k) In England the Constitutions of Clarendon added a provision for appeal to the king, "and if the archbishop shall have failed in doing justice recourse is to be had in the last resort (*postremo*) to our lord the king, that by his writ the controversy may be ended in the court of the archbishop; because there must be no further process without the assent of our lord the king." The last words were an attempt to limit further appeal to Rome. It will be observed that the king does not hear the cause or adjudicate upon it. He merely corrects slackness or lack of doing justice (*Si archiepiscopus defecerit in justitia exhibenda*) and by his writ (*precepto*) directs the controversy to be determined in the metropolitan's court. As bishop Stubbs says (*Report of Eccl. Comm.* vol. i. *Hist. App.* i): "The appeal to the king is merely a provision for a rehearing before the archbishop, such failure to do justice being not so much applicable to an unfair decision as to the delays or refusal to proceed common at that time" (cf. Joyce, *The Sword and the Keys*, 2nd ed. pp. 19-20). The *recursus ad principem*, in some form or other of appeal or application to the sovereign or his lay judges, was at the end of the middle ages well known over western Europe. This recourse in England sometimes took the form of the appeal to the king given by the Constitutions of Clarendon, just mentioned, and later by the acts of Henry VIII.; sometimes that of suing for writs of *prohibition* or *mandamus*, which were granted by the king's judges, either to restrain excess of jurisdiction, or to compel the spiritual judge to exercise jurisdiction in cases where it seemed to the temporal court that he was failing in his duty. The *appellatio tanquam ab abusu* (*appel comme d'abus*) in France was an application of a like nature. Such an appeal lay even in cases where there was a refusal to exercise voluntary jurisdiction (de Maillane, *Dictionnaire du droit canonique*, tit. "Abus" cf. tit. "Appel"). This writer traces their origin to the 14th century; but the procedure does not seem to have become regularized or common till the reigns of Louis XII. or Francis I. (cf. *Dict. eccl.*, Paris, 1765, tit. "Abus" and "Appel comme d'abus"). On the *recursus ad principem* and the practice of "cassation" in Belgium, Germany and Spain, cf. Van Espen's treatise under this title (*Works*, vol. iv.) and *Jus eccl. univ.* pars iii. tit. x. c. 4. Louis XIV. forbid

the parlements to give judgment themselves in causes upon an *appel comme d'abus*. They had to declare the proceedings null and abusive and command the court Christian to render right judgment (Edict of 1695, arts. 34, 36, cited in Gaudry, *Traité de la législation des cultes*, Paris, 1854, tom. i. pp. 368, 369).

In Catalonia "Pragmatics," letters from the prince, issued to restrain jurisdiction assumed by ecclesiastical judges contrary to the customs of the principality. Thus in 1368 Peter III. evoked to the royal court a prosecution for abduction pending before the archbishop of Tarragona, declaring that the archbishop and the official were incompetent to judge noblemen. See this and other instances collected in *Usages y demas derechos de Cataluña*, by Vives y Cebría (Barcelona, 1835), tom. iv. p. 157 et seq.

(l) Lastly there was the appeal to the patriarchs, i.e. in the West to Rome. The distinguishing feature of this appeal was that the rule of the other appeals did not apply to it. In the regular course of those appeals an appellant could not leap the intermediate stages; but he could at any stage go to this final appeal, *omisso medio*, as it was technically called (see *de appell. c. Dilect.* iii. for general rule, and c. 3 *de appell.* in 6 for different rule in case of the pope, and authorities cited in Van Espen, pars iii. tit. x. c. 2, 5). Van Espen says: "The whole right of appeal to the Roman pontiff *omisso medio* had undoubtedly its origin in this principle, that the Roman pontiff is ordinary of ordinaries, or, in other words, has immediate episcopal authority in all particular churches, and this principle had its own beginning from the False Decretals."

Appeals to Rome lay from interlocutory as well as final judgments. Causes could even be evoked to Rome before any judgment and there heard in first instance (Van Espen, pars iii. tit. x. c. 1, 8).

There was an alleged original jurisdiction of the pope, which he exercised sometimes by permanent legates, whom Gregory VII. and his successors established in the chief countries of Europe, and to whom were committed the legislative executive and judicial powers of the spiritual "prince" in the districts assigned to them. These Clement IV. likened to "pro-consuls" and declared to have "ordinary" jurisdiction; because they had jurisdiction over every kind of cause, without any special delegation, in a certain defined area or province (c. ii. *de Officio Legatis* in 6). They were expressed to have not merely appellate but original jurisdiction over causes (iii. c. i. *de Officio Legatis*). The occupants of certain sees by a kind of prescription became legates without special appointment, *legati nati*, as in the case of Canterbury. In the 13th century Archbishop Peckham, says Maitland (p. 117), as archbishop, "asserted for himself and his official (1) a general right to entertain in the first instance complaints made against his suffragans' subjects, and (2) a general right to hear appeals *omisso medio*." It was, for the time, determined that the archbishop might himself, in virtue of his legatine authority, entertain complaints from other dioceses in first instance, but that this legatine jurisdiction was not included in the ordinary jurisdiction of his official principal, even if the archbishop had so willed it in his commission. In fact, however, the official did before the end of the later medieval period get the same power as the archbishop (Maitland, pp. 118-120; cf. Lyndwood, lib. v. tit. 1), till it was taken from him by the Bill of Citations.

After legates came special delegates appointed by the pope to hear a particular cause. It was the general practice to appoint two or three to sit together (Van Espen, pars iii. tit. v. c. 2, 37). These might sub-delegate the whole cause or any part of it as they pleased, *ibid.* 9-18. Dr Maitland (essay on "The Universal Ordinary") thinks, but without very much foundation, that great numbers especially of the more important causes were tried before these delegates; although the records have largely perished, since they were the records of courts which were dissolved as soon as their single cause had been decided. These courts were convenient, since it was the custom to appoint delegates resident in the neighbourhood, and the power of sub-delegation, general or limited, simplified questions of distance. In Belgium causes

appealed to Rome had to be committed to local delegates (Van Espen, pars iii. tit. v. c. 3, tit. x. c. 2).

There could be an appeal from these delegates to the pope and from the pope himself to the pope "better informed" (Van Espen, pars iii. tit. x. c. 2, 12, 13). So personal had the system of jurisdiction become that even the trials of bishops ceased to be necessarily conciliar. Generally they were reserved to the pope (Van Espen, pars iii. tit. iii. c. 5, 17-19); but in England the archbishop, either in synod, or with some of his provincial bishops concurring, tried and deposed bishops (see case of Bishop Peacock and the other cases cited in *Read v. Bishop of Lincoln*, 14 P.D. 148, and Phillimore, *Ecc. Law*, pp. 66 et seq.).

(m) The jurisdiction of a bishop *sede vacante* passed, by general law, to the dean and chapter; but in England the metropolitans became "guardians" of the spiritualities and exercised original jurisdiction through the vacant diocese (Phillimore, pp. 62-63), except in the case of Durham, and with a peculiar arrangement as to Lincoln.

If the metropolitan see were vacant the jurisdiction was exercised by the dean and chapter through an official (Rothery, *Return of Cases before Delegates*, Nos. 4, 5). As to France see Fournier, p. 294.

(n) Officials, even of bishops and metropolitans, need not be in holy orders, though Bishop Stubbs in his paper in the *Report of the Commission on Ecclesiastical Courts* seems to say so. They had to be clerics, that is, to have received the tonsure. Even papal delegates might be simple clerks (Van Espen, pars iii. tit. v. c. 2, 20).

It came, however, to be the practice to impose some restrictions, as on clerks twice married. Thus Archbishop Chichele provided that no clerk married or bigamous (that is, having had two wives in succession) should exercise spiritual jurisdiction (see Lyndwood, lib. iii. tit. 3). Abroad unsuccessful attempts were made by local councils to enact that officials and vicars-general should be in holy orders (Hefele on Councils of Tortosa in 1429 and Sixth of Milan in 1582). These councils, as will be seen, are late.

(o) With or without the concurrence and goodwill of the national Church, restrictions were imposed by the State on the papal jurisdiction, whether original or appellate. In England the Constitutions of Clarendon (by chap. viii.) prohibited appeals to the pope; but after the murder of St Thomas of Canterbury Henry II. had to promise not to enforce them. The statutes 38 Edw. III. st. 2, 13 Rich. II. st. 2, c. 2, and 16 Rich. II. c. 5 forbid such appeals; but it is suggested that notwithstanding the generality of their language they refer only to cases of temporal cognizance. Cases upon the execution of these statutes are collected in Stillfleet, *On Ecclesiastical Jurisdiction*, p. 189; Gibson, *Codex*, 83. Obstacles were placed in the way of appeals to the pope *omisso medio*. Thus when a writ of *significavit* issued on the mandate of a bishop, an appeal to Rome availed not to stay execution; but if there were an appeal to the archbishop it was otherwise. It therefore became the custom to lodge a double appeal: one to the archbishop "for defence," and the other to the pope as the real appeal ("Hostiensis," *Super Decret.* ii. fol. 169; cf. Owen, *Institutes of Canon Law*, 1884, pt. i. c. 19, 5).

There seems to have been no machinery for assisting the original or appellate jurisdiction of the pope by secular process,—by *significavit* or otherwise.

The matrimonial cause between Henry VIII. and Catharine of Aragon was the most famous English cause tried by delegates under the "original" jurisdiction of the pope, and was ultimately "evoked" to Rome. The foreseen adverse termination of this long-drawn cause led to Henry's legislation.

When the temporal courts interferred to prevent excess of jurisdiction, they did so by prohibiting the ecclesiastical court from trying and the suitor from suing in that court. The pope could not be effectively prohibited, and no instance is recorded of a prohibition to papal delegates. But suitors have been prohibited from appealing to the pope (see per Willes, J., in *Mayor of London v. Cox*, L.R. 2 H.L. 280). Whatever may have been

the law, it is certain that, notwithstanding the statutes of Edw. III. and Rich. II., appeals to Rome and original trials by papal delegates did go on, perhaps with the king's licence; for the statute 24 Hen. VIII. c. 12 recites that the hearing of appeals was an usurpation by the pope and a grievous abuse, and proceeds to take away the appeal in matrimonial, testamentary and tithe causes, and to hinder by forbidding citation and process from Rome, all original hearings also. The statute 25 Hen. VIII. c. 19 follows this up by taking away appeals in all other subjects of ecclesiastical jurisdiction.

In 1438 the council of Basel took away all papal original jurisdiction (save in certain reserved cases—of which *infra*), evocation of causes to Rome, appeals to Rome *omisso medio*, and appeals to Rome altogether in many causes. Such appeals when permissible, except the "greater," were to be tried by delegates on the spot (31st Session; Mansi, *Concilia, in loco*). These proceedings at Basel were regarded at Rome as of no effect. Nevertheless this decree and others were adopted by a French national council at Bourges and promulgated by the king as a "Pragmatic Sanction" (Migne, *Dict. du droit canonique*, "Pragmatique Sanction"). The parlements registered the Sanction and the effect was permanent in France. Louis XI. and Charles VIII. sought to revoke it; but both parlements and states-general refused to recognize the revoking decrees. In 1499 Louis XII. ordered the Pragmatic to be inviolably observed. The parlements thereupon condemned several private persons for obtaining bulls from Rome. In 1516 a Concordat between Leo X. and Francis I. settled all these questions in the sense of the Pragmatic, substantially according to the Basel canon. All causes, except the "greater," were to be terminated in the country where the proper cognizance would lie (Migne, *op. cit.* "Concordat"). By this Concordat, by an ordinance of Francis I. in 1539, by two or three other royal edicts, and (above all) by the practice of the parlements, explanatory of this legislation, and their *arrêts*, the conflict of secular and ecclesiastical jurisdictions was settled until the Revolution (Migne, *ubi sup.*). "Greater causes" came in France to be restricted to criminal prosecutions of bishops. Even in these the original jurisdiction of the pope was taken away. In first instance they were tried by the provincial synod. Thence there was appeal to the pope (de Maillane, *op. cit. s.v.* "Causes majeures"; *Dict. ecd.*, Paris, 1765, *s.v.* "Cause"). The only original jurisdiction left to the pope was in the case of the matrimonial causes of princes. But they could only be heard on the spot by judges delegate. Examples are the causes of Louis XII. and Jeanne of France in 1498, and of Henry IV. and Marguerite of Valois in 1599 (Migne, *op. cit. s.v.* "Causes"). The prohibition of papal interference was enforced if necessary by the *appel comme d'abus* (*vide supra*). Out of respect for the pope this appeal was not brought against his decrees but against their execution (*Dict. ecd.*, Paris, 1765, *s.v.* "Abus").

Spain appears to have permitted and recognized appeals to the pope. A royal writ of the 16th century cited by Covarruvias (c. xxxv.) prohibits execution of the sentence of a Spanish court Christian pending an appeal to the pope.

2. The subject matter over which the ecclesiastical courts had jurisdiction was no longer purely "criminal" with a civil quasi-jurisdiction by way of arbitration. In the later middle ages these courts had jurisdiction over most questions, except indeed the then most important ones, those relating to real property. This civil jurisdiction was sometimes concurrent with that of the secular courts, sometimes exclusive. For England it may be thus classified:—

(a) *Matrimonial*.—This arose naturally from the sacred character of Christian marriage. This jurisdiction was exclusive. From it followed the right of the courts Christian to pronounce upon questions of legitimacy. Upon this right an inroad was early made, in consequence of the question of legitimation by subsequent marriage. In the 12th century the Church's rule, that subsequent marriage did legitimize previous issue, was settled (c. 6, x. 4, 17). The king's judges then began to ask the ordinary the specific question whether A. B. was born before

Civil
jurisdiction.

or after his parents' marriage. After the inconclusive proceedings at the realm-council of Merton (1236), when spiritual and temporal lords took opposite views, the king's judges went a step further and thenceforward submitted this particular question to a jury. All other questions of legitimacy arising in the king's courts were still sent for trial to the bishop and concluded by his certificate (see Pollock and Maitland, *Hist. Eng. Law before Edward I.* vol. i. 105-106; Maitland, *ubi supra*, pp. 53-56).

(b) *Testamentary and in regard to succession from intestates.*—Real property was not the subject of will or testament in the mediæval period. But as to personal property, the jurisdiction of the courts Christian became exclusive in England. The Church, East and West, had long asserted a right to supervise those legacies which were devoted to pious uses, a right recognized by Justinian (*Cod.* l. 3. 46). The bishop or, failing him, the metropolitan, was to see such legacies properly paid and applied and might appoint persons to administer the funds (Pollock and Maitland, *op. cit.* ii. 330). This right and duty became a jurisdiction in all testamentary causes. Intestacy was regarded with the greatest horror, because of the danger to the intestate's soul from a death without a fitting part given to pious uses (Maine, *Ancient Law*, ed. 1906, note by Pollock, p. 230; cf. Pollock and Maitland, *op. cit.* ii. 354). Hence came the jurisdiction of the ordinary in intestacy, for the peace of the soul of the departed. This head of ecclesiastical jurisdiction was in England not transferred to the secular court till 1857.

(c) *Church Lands.*—If undoubtedly held in *frankalmoign* or "free alms," by a "spiritual" tenure only, the claim of jurisdiction for the ecclesiastical *forum* seems to have been at first conceded. But the Constitutions of Clarendon (c. 9) reserved the preliminary question, of "frankalmoign" or not, for a jury in the king's court. Then, if the tenure were found free alms, the plea was to be heard in the court Christian. From the 13th century, however, inclusive, the king's courts insisted on their exclusive jurisdiction in regard to all realty, temporal or "spiritual" (Pollock and Maitland, *op. cit.* i. 106).

(d) *Title to present to and possession of benefices.*—As to the title to present to benefices, the courts Christian at one time had concurrent jurisdiction with the temporal courts. "Advowsons" were, however, looked upon as a species of "real" property in England, and therefore the king's court early claimed exclusive jurisdiction in disputes where the title to present was involved. The Constitutions of Clarendon provided that these causes should be heard only in the king's court (c. 1). This rule was applied even where both litigants were "spiritual." In the 13th century abbots see each other in the royal court for advowsons (Selden Soc. *Select Civil Pleas*, i. pl. 245). In 1231, in such a suit, the bishop of London accepts wager of battle (Pollock and Maitland, *op. cit.* i. 105). In cases, however, where the title to present was not in question, but the fitness of the clerk presented, or, in cases of election to benefices, the validity of the election, there was jurisdiction in the courts Christian.

(e) *The recovery of tithes and church dues*, including in England church rates levied to repair or improve churches and churchyards.

(f) Questions concerning *fabrics, ornaments, ritual and ceremonial* of churches.

(g) *Administration of pious gifts and revenues given to prelates or convents.*—Their right application could be effectively enforced only in the courts Christian; until the rise in England of the equitable jurisdiction of the court of chancery and the development of the doctrine of "uses" at the end of the middle ages.

(h) *Enforcement of contractual promises made by oath or pledge of faith.*—The breaking of such a promissory oath was called "perjury" (as in classical Latin and in Shakespeare), contrary to modern usage, which confines the word to false evidence before a court of justice. In regard to the execution of these promises, the jurisdiction of the ecclesiastical courts was possibly traversed by c. 15 of the Constitutions of Clarendon; but allowed by the statute 13 Edw. I. st. 4. As just intimated,

besides the enforcement of the promise, the "perjury" was treated as an ecclesiastical crime.

The *criminal jurisdiction of courts Christian over laymen* included, besides these "perjuries," (a) *all sexual offences* not punishable on indictment; (b) *Defamation of character* (the king's courts came in time to limit this to such defamation as could not be made the subject of a temporal action); (c) *Offences by laymen against clerks* (i.e. against all "tensured" persons, *supra*); (d) *Offences in regard to holy places*—"brawling" and such like; (e) *Heresy, schism, apostasy, witchcraft*.

In regard to "clerks," there was (1) all the criminal jurisdiction which existed over laymen, and (2) criminal jurisdiction in regard to professional misconduct. Concerning "felonious" clerks the great questions discussed were whether the courts Christian had exclusive jurisdiction or the king's court, or whether there was a concurrent jurisdiction. The subject was dealt with in the Constitutions of Clarendon, formally revoked after the murder of St Thomas of Canterbury. In the 13th century it was recognized that a "clerk" for felony was subject only to ecclesiastical trial and punishment; punishment which might involve lifelong imprisonment. For "misdemeanours," as yet unimportant, he had no exemption from secular jurisdiction (Pollock and Maitland, *op. cit.* ch. iv.). At some indeterminate later period, the "clerk" was tried for felony by a jury in the king's court and then "pleaded his clergy," after conviction there, and was remitted to the ordinary for ecclesiastical punishment. "Clerks" for the purpose of "benefit of clergy" included not only persons in minor orders, but all "religious" persons, i.e. monks, friars, nuns, &c. Later the custom arose of taking "clerk" to include any "literate," even if not in orders or "religious" (cf. Stephen, *Hist. Crim. Law*, i. 461). The statute 4 Hen. VII. c. 13 took away benefit of clergy, if claimed a second time, from persons not "within orders," in certain bad cases. 4 Hen. VIII. c. 2 (a temporary act) took away "clergy," in certain heinous crimes, from all persons not in "holy" orders. This statute was partly renewed by 22 Hen. VIII. c. 13. Other changes were introduced by 23 Hen. VIII. c. 1 and later acts. In time, "benefit of clergy" became entirely diverted from its original objects.

In France, till 1329, there seems to have been no clear line of demarcation between secular and ecclesiastical jurisdictions. Beaumanoir (*Coutume de Beauvoisis*, ch. xi., cited Gaudry, *op. cit.* i. 22) had laid down the principle that spiritual justice should meddle only with spiritual things. In the year named the secular courts complained to the king, Philip of Valois, of the encroachments of the courts Christian. The "cause" was solemnly argued before that monarch, who decided to leave things as they were (Migne, *Dict. du droit canon.*, s.v. "Officialités"). In 1371 Charles V. forbade spiritual courts to take cognizance of "real" and "possessory" actions even in regard to clerks (Migne, *loc. cit.*; cf. Gaudry, *ubi sup.*). From this period the parlements began the procedure which, after the Pragmatic Sanction of Charles VII., in 1438 took regular shape as the *appel comme d'abus* (*supra*; Migne, *loc. cit.*). Testamentary causes at first were subject to the concurrent jurisdiction of the spiritual and secular courts. After the 14th century, the latter had exclusive jurisdiction (Van Espen, *op. cit.* lib. iii. tit. ii. cc. 2, 15, 16). In regard to *marriage* the secular jurists distinguished between the civil contract and the sacrament, for purposes of separating the jurisdiction (*Dict. ecd.*, Paris, 1765, s.v. "Mariage"). The voluntary jurisdiction as regards dispensations was kept for the Church. The contentious jurisdiction of the courts Christian was confined to promises of marriage, nullity of marriage caused by "diriment" impediments only, validity or invalidity of the sacrament, divorce *a thero* (*ibid.*). Questions in regard to the *property in a benefice* were for the courts Christian; in regard to its *possession*, for the king's courts. But if a "possessory" action had been brought in the latter, a subsequent suit in the courts spiritual for the property was deemed "abusive" and restrained (*ib.*, s.v. "Pétitoire"). *Breach of faith or of promise confirmed by oath* was matter for the court Christian (Fournier, pp. 95, 99, 109, 125). This

branch of jurisdiction was larger and more freely used than in England (cf. Pollock and Maitland, *op. cit.*, as to Normandy). The only other remaining civil jurisdiction of the ecclesiastical courts was in *personal actions where clerks were defendants* (Migne, *op. cit.*, s.v. "Officialités," Fournier, pp. 65-125); or, after the 14th century, where both parties were clerks. In regard to crimes delictis (*délits*) were divided into classes for purposes of jurisdiction. Clerks were punishable only in the court Christian, except in cases of grave crimes such as murder, mutilation (Fournier, p. 72), and cases called "royal cases" (*vide infra*). Laymen were punishable in the court Christian for the *délits* following: injury to sacred or religious places, sacrilege, heresy (except where it was a "royal case"), sorcery, magic, blasphemy (also punishable in the secular court), adultery, simony, usury and infractions of the truce of God (Fournier, pp. 90-93). What were called "privileged delicts" were judged in the case of the clergy conjointly by the spiritual judge and the king's judge. Bishops had no exemption (*Dict. eccl.*, s.v. "Délits," "Cas privilégié," "Causes majeures"). "Royal cases" included such crimes as touched the prince, as all forms of treason; or the dignity of his officers; or the public safety. In this class were also included such heresies as troubled the state, as by forbidden assemblies, or by teaching prohibited doctrine. Among these heresies were reckoned idolatry, atheism, Protestantism, relapse (*ib. et* "Cas royaux," "Hérésie"). These were of exclusive royal jurisdiction as against both spiritual courts and the courts of feudal lords. A similar claim was made by Pombal for Portugal (*vide infra*).

The parlements, in order to have a ready means of enforcing all these restrictions by *appel comme d'abus*, compelled the bishops to appoint officials, Frenchmen, graduates, and (as it seems) "seculars" (*Dict. eccl.*, Paris, 1765, s.v. "Official"). This last qualification was disputed (see Fevret, *Traité de l'abus*).

3. *Punishments*.—Ecclesiastical sanctions were divided into *punishments* (*poenae*), either purely temporal in character or else of a mixed spiritual and temporal character, and *censures* (*censores*), purely spiritual and remedial (see Van Espen, pars iii. tit. xl. cc. 1, 3; Phillimore, *Ecclesiastical Law*, p. 1064). In the book last cited *censores* and *poenae* are classed together as "censures" (which is the modern use).

Poenae.—(a) *Fines* sprang from the older custom of directing alms by way of penance in the infernal forum (Van Espen, *ubi sup.* c. 1, 5-10). They were to be applied to pious uses. (b) *Reclusion* in a monastery continued from former period, and might be either temporary or perpetual (*loc. cit.* 17-19). (c) *Imprisonment*, in the bishop's prison, might be in chains, or on bread and water, and temporary or perpetual. In its severer forms it was only inflicted for more atrocious crimes which the secular law would have punished with death (*loc. cit.* 21-27). The act 23 Henry VIII. c. 11 made special provision for convicted clerks who broke out of the prisons of the ordinary. (d) *Fustigation*, as in former period, was hardly an ecclesiastical punishment. If given, it was to be of a paternal character (*loc. cit.* 39-45). Punishments of a mixed nature were: (e) *Suspension* either from office alone or from office and benefice; (f) *Deprivation* of benefice; (g) *Deposition* or *Degradation* (a more solemn and ceremonial form) from the ministry; (h) *Irregularity*—not always a punishment—a state of incapacity to be ordained, or, being ordained, to execute the ministry; this might result from some defect of mind and body, but was also incurred by some grave offences.

Censures were as follows: (i) *Suspension* from attending divine offices or *ab ingressu ecclesiae*, more appropriate for a layman. A clerk in like case might be suspended from office. (j) *Interdict* was another form of partial or total suspension from the benefit of the rites and sacraments of the Church. An interdict might be personal or local (see INTERDICT). (k) *Excommunication* was either greater or less. The greater separated entirely from the Church. It might be pronounced under anathema. The less deprived of participation in the sacraments, and made a clerk incapable of taking a benefice.

On the European continent the courts Christian often carried

out their decrees by their own apparitors who could levy pecuniary penalties on a defendant's goods (Van Espen, pars iii. tit. ix. c. 4). They could arrest and imprison. In England, except in the peculiar case of imprisonment pending trial for heresy, or in the case of a clerk convicted of crime, these things could not be. The sentence of the court Christian had in all other cases to be enforced by the secular arm. Early in Henry II.'s time it had become the custom of England for the court Christian to "signify" its sentence of excommunication to the king and to demand from him a writ of *significavit* to the sheriff, to imprison the person excommunicated. The writ apparently issued for no court inferior to the bishop's, unless upon the bishop's request. In some sense the king's writ of *significavit* was discretionary; but its issue could be enforced by excommunication or interdict.

In the cases of heresy, apostasy and sorcery, the spiritual courts sought the aid of the secular jurisdiction to superadd the punishment of death. Incurable offenders on these matters were "left" to the secular power, to be corrected with due "animadversion." This provision of the fourth Lateran Council in 1215 was always interpreted to mean death (see Van Espen, *Observ. in Conc. Lat. IV. Canonos*, and the decree in the *Sex. ut inquisitionis negotium*; and, as to English law and practice, Maitland, *op. cit.*, Essay vi., and pp. 161, 176; 2 Hen. IV. c. 15; Fitzherbert, *Natura brevium*, 269; 2 Hen. V. st. 1, c. 7). The "capital" punishment was generally (always in England) by burning. Burning was an English punishment for some secular offences.

The Concordat with Francis I. by which the pope gave up the right of hearing appeals from France was not many years before the legislation of Henry VIII. in England. Both monarchs proceeded on the same lines; but Francis I. got the pope's consent: Henry VIII. acted *in irritum*, and in time went rather further.

The Statute of Appeals (24 Hen. VIII. c. 12) takes away appeals to Rome in causes testamentary and matrimonial and in regard to right of tithes, oblations and obventions. *Ecclesiastical jurisdiction in England.* A final appeal is given to the archbishop of the particular province; but in causes touching the king a final appeal is given to the Upper House of Convocation of the province. The statute is aimed at appeals; but the words used in it concerning "citations and all other processes" are wide enough to take away also the "original" jurisdiction of the pope. No appeal was yet given to the crown. Canterbury, York, Armagh, Dublin, Cashel and Tuam are put in the place of Rome. The English and Irish provinces are treated as self-contained. All ends there.

The "Act of Submission of the Clergy" (25 Hen. VIII. c. 19) took away all appeals to Rome and gave a further appeal, "for lack of justice," from the several courts of the archbishops to the king in chancery. Thence a commission was to issue to persons named therein to determine the appeal definitely. This was copied from the then existent practice in admiralty appeals and was the origin of the so-called court of delegates. It is a moot question whether this statute took away the appeal to the Upper Houses of the various convocations in causes wherein the king was concerned (see *Gorham v. Bishop of Exeter*, 15 Q.B. 52; *Ex parte Bishop of Exeter*, 10 C.B. 102; *Re Gorham v. Bishop of Exeter*, 5 Exch. 630). 37 Hen. VIII. c. 17 provided that married laymen might be judges of the courts Christian if they were doctors of civil law, created in any university. This qualification even was considered unnecessary in Charles I.'s time (*Cro. Car.* 258). Canon 127 of 1603 provided that the judges must be learned in the civil and ecclesiastical laws and at least masters of arts or bachelors of laws. Canon Law as a study had been practically prohibited at the universities since 1536 (Merriman, *Thomas Cromwell*, i. 142-143; *Cal. State Papers*, vol. ix. p. xxxix. 117; Owen, *Institutes of Canon Law*, viii.). The substitution of "civilians," rather than common lawyers, for canonists (civilians, hitherto, not an important body in England) had important consequences (see Maitland, *op. cit.* 92 et seq.).

Henry VIII. had exercised his jurisdiction as Supreme Head through a vicar-general. Edward VI. exercised original

jurisdiction in spiritual causes by delegated commissions (see Archdeacon Hale, *Precedents in Criminal Cases*, p. xviii.). Unless the king was to be regarded as an ecclesiastical person, they were not properly ecclesiastical courts; although spiritual persons might sit in them, for they sat only as royal commissioners. The same point has been taken by large bodies of clergy and laity in regard to the court of final appeal created by 25 Hen. VIII. c. 19 and its present successor the judicial committee of Privy Council (*infra: Rep. Com. Ecc. Discipline*, pp. 9, 94 et seq.). At any rate the "original" jurisdiction claimed for the monarch personally and his delegates, under Henry VIII. and Edward VI., has not permanently remained. In theory, Hooker's contentions have been conceded that "kings cannot in their own proper persons decide questions about matters of faith and Christian religion" and that "they have not ordinary spiritual power" (*Ecc. Pol.* vii. 8, 1, 6; cf. XXXIX. *Articles*, Art. 37).

Under Henry VIII. a system began of making certain crimes, which previously had been only of spiritual cognizance, felonies (25 Hen. VIII. c. 6), excluding thereby spiritual jurisdiction (Stephen, *Hist. Crim. Law*, ii. 429). Bigamy (in its modern sense) was thus made felony (1 Jac. I. c. 11). In this reign and the next, temporal courts were sometimes given jurisdiction over purely spiritual offences. A trace of this remains in 1 Edw. VI. c. 1 (still on the statute book; Stephen, *Hist. Crim. Law*, ii. 439). Other traces occur in the Acts of Uniformity, which make offences of depraving the Book of Common Prayer triable at Assizes (between 23 Eliz. c. 1 and 7 & 8 Vict. c. 102—also at Sessions) as well as in the courts Christian.

During Edward VI.'s time the courts Christian seem practically to have ceased to exercise criminal jurisdiction (Hale, *Precedents in Criminal Cases*, p. xlix.). But they sat again for this purpose under Mary and Elizabeth and (save between 1640 and 1661) continued regular criminal sessions till towards the end of the 17th century as continuously and constantly as the king's courts (*op. cit.*).

The "ordinary" ecclesiastical tribunals of the later middle ages still subsist in England, at least as regards the laity. This is hardly the case elsewhere in the Western Church, though some exceptions are noted below. Nevertheless, their exercise of criminal jurisdiction over the laity is now in practice suspended; although in law it subsists (see Stephen, *Hist. Crim. Law*; *Roy v. Sherwood*, 1 Curt. R. 193; 1 Moore P.C.R. 363; the observations of Kelly, C.B., in *Mordaunt v. Moncrieffe*, L.R. 2 Sc. & Div. 381, and of Lord Coleridge in *Marin v. Mackonochie*, L.R. 4 Q.B.D. 770, and, on the other hand, of Lord Penzance in *Phillimore v. Mackon*, L.R. 1 P.D. 486). Theoretically still, in cases of sexual immorality, penance may be imposed. Monitions to amend may be decreed and be enforced by *significavit* and writ *de consummatione capiendo*, or by excommunication with imprisonment not to exceed six months (53 Geo. III. c. 127). The tribunals thus subsisting are the courts of the bishop and archbishop, the latter sometimes called the court of appeal of the province. Peculiar jurisdictions have been gradually taken away under the operation of the acts establishing the ecclesiastical commissioners. The appeal given to delegates appointed by the crown has been transferred, first by 2 & 3 Will. IV. c. 92 to the privy council, and then by 3 & 4 Will. IV. c. 41 to the judicial committee of the privy council. Bishops may now be summoned as assessors by 39 & 40 Vict. c. 59.

There was in the time of Elizabeth, James I. and Charles I. a "Court of High Commission" with jurisdiction over laity and clergy, based on 1 Eliz. c. 1 s. 15, which was reckoned as an ecclesiastical judicature (5 R. 1, *Cawdrey's case*) concurrent with the ordinary court Christian. It was created by virtue of the royal supremacy, and was taken away by 16 Car. I. c. 11. As to its history see Stephen, *Hist. Crim. Law*, ii. 414-428.

In regard to clerical offences, 3 & 4 Vict. c. 86 (the "Church Discipline Act") creates new tribunals; and first a commission of inquiry appointed by the bishop of five persons, of whom the vicar-general, or an archdeacon, or a rural dean of the diocese must be one. If they report a *prima facie* case, the bishop may (with the consent of parties) proceed to sentence. In the absence

of such consent, the bishop may hear the cause with three assessors, of whom one shall be a barrister of seven years' standing and another the dean of the cathedral, or one of the archdeacons, or the chancellor. This court is called the "consistory" court, but is not the old consistory. Both these tribunals are new. But the bishop may instead send the cause, in first instance, to the old provincial court, to which appeal lies, if it be not so sent.

The Public Worship Regulation Act (37 & 38 Vict. c. 85) gave criminal jurisdiction over benefited clerks (concurrent with that of the tribunal under 3 & 4 Vict. c. 86) to the judge under the act in matters of the fabric, ornaments, furniture and decorations of churches, and the conduct of divine service, rites and ceremonies. The "judge" under the act is to be a barrister of ten years' standing, or an ex-judge of a superior secular court, appointed by the archbishops of Canterbury and York, with the approval of the crown, or, if they fail to appoint, by the crown. Proceedings under this act are to be deemed to be taken in the appropriate ancient ecclesiastical courts (*Green v. Lord Penzance*, 6 A. C. 657). The judge under this act became (upon vacancies occurring) *ex officio* official principal of the arches court of Canterbury and of the chancery court of York. This provision caused grave doubts to be entertained as to the canonical position of this statutory official principal.

Finally, the Clergy Discipline Act 1892 (55 & 56 Vict. c. 33) creates yet a new court of first instance for the trial of clerical offences against morality in the shape of a consistory court, which is not the old court of that name, but is to comprehend the chancellor and five assessors (three clergymen and two laymen chosen from a prescribed list), with equal power with the chancellor on questions of fact. In many instances the conviction of a temporal court is made conclusive on the bishop without further trial. In regard to moral offences, jurisdiction under this act is exclusive. But it only applies to clerks holding preferment. Under all these three acts there is a final appeal to the judicial committee of the privy council.

None of these acts applies to the trial of bishops, who are left to the old jurisdictions, or whatever may be held to be the old jurisdictions (with that of the Roman See eliminated). As to suffragan bishops in the province of Canterbury, see *Read v. Bishop of Lincoln*, 13 P.D. 221, 14 P.D. 88. (On general questions see Phillimore, *Ecc. Law*, 65, 73.) Despite the bishop of Lincoln's case, the law is in some uncertainty.

Dilapidations are now not made matters of suit before the court, but of administrative action by the bishop.

The subject matter of ecclesiastical jurisdiction has been gradually reduced in England, &c., by various causes. (1) The taking away of all matrimonial, testamentary and *ab intestato* jurisdiction by 20 & 21 Vict. c. 77 (testamentary, &c., England), c. 79 (testamentary, &c., Ireland), c. 85 (matrimonial, England); 33 & 34 Vict. c. 110 (matrimonial, Ireland). Matrimonial jurisdiction was taken from the bishop of Sodor and Man in 1884. (2) Since 6 & 7 Will. IV. c. 71, tithes has become, except in a few rare cases, tithes rent charge, and its recovery has been entirely an operation of secular law. Most kinds of offerings are now recoverable in secular courts. (3) Administration of pious gifts has passed to the court of chancery. (4) The enforcement of contractual promises has long been abandoned by the courts Christian themselves. (5) Church rates can no longer be enforced by suit (31 & 32 Vict. c. 109). (6) *Defamation* was taken away in England by 18 & 19 Vict. c. 41, and in Ireland by 23 & 24 Vict. c. 32. (7) Laymen can no longer be tried in the spiritual courts for offences against clerks. (8) The jurisdiction for "brawling" in church, &c., is taken away by 23 & 24 Vict. c. 32 in the case of the laity. In the case of persons in holy orders there is a concurrent jurisdiction of the two tribunals (*Valancy v. Fletcher*, 1897, 1 Q.B. 265). This was an offence very frequently prosecuted in the courts Christian (see A. J. Stephens, *Ecclesiastical Statutes*, i. 336).

The existing ecclesiastical jurisdiction in England is therefore now confined to the following points. (1) Discipline of the clergy. (2) Discipline of the laity in respect of sexual offences

as already stated. (3) Control of lay office-bearers, churchwardens, sidesmen, organists, parish clerks, sextons. (4) Protection of the fabrics of churches, of churchyards, ornaments, fittings, &c., sanctioning by licence or faculty any additions or alterations, and preventing or punishing unauthorized dealings by proceedings on the criminal side of the courts. (5) Claims by individuals to particular seats in church or special places of sepulture. (6) Rare cases of personal or special tithes, offerings or pensions claimed by incumbents or benefices. In the Isle of Man and the Channel Islands courts Christian have now jurisdiction substantially as in England. In Jersey and in Guernsey there are courts of first instance with appeal to the bishop of Winchester. Ecclesiastical jurisdiction in Ireland was as in England till the Irish Church was disestablished in 1869 by 32 & 33 Vict. c. 42.

The position of a disestablished or an unestablished Church is comparatively modern, and has given rise to new jural conceptions. These Churches are *collegia licita* and come within the liberty of association so freely conceded in modern times. The relations of their bishops, priests or other ministers and lay office-bearers *inter se* and to their lay folk depend upon contract; and these contracts will be enforced by the ordinary courts of law. A consensual ecclesiastical jurisdiction is thus created, which has to this extent temporal sanction. *In foro conscientie* spiritual censures canonically imposed are as binding and ecclesiastical jurisdiction is as powerful as ever.

Into the British-settled colonies no bishops were sent till 1787; and consequently there were no regular courts Christian. The bishop of London was treated as the diocesan bishop of the colonists in North America; and in order to provide for testamentary and matrimonial jurisdiction it was usual in the letters patent appointing the governor of a colony to name him ordinary. In New York state there is still a court called the surrogates court, surrogate being the regular name for a deputy ecclesiastical judge. In Lower Canada, by treaty, the Roman Catholic Church remained established.

Throughout the United States, whatever may have been the position in some of them before their independence, the Church has now no position recognized by the State, but is just a body of believers whose relations are governed by contract and with whom ecclesiastical jurisdiction is consensual.

The position is the same now through all the British colonies (except, as already mentioned, Lower Canada or Quebec). From 1787 onwards, colonial bishops and metropolitans were appointed by letters patent which purported to give them jurisdiction for disciplinary purposes. But a series of cases, of which the most remarkable was that *Re the Bishop of Natal* (3 Moore P.C. N.S. A.D. 1864), decided that in colonies possessing self-governing legislatures such letters patent were of no value; and soon after the crown ceased to issue them, even for crown colonies.

In India the metropolitan of Calcutta and the bishops of Madras and Bombay have some very limited jurisdiction which is conferred by letters patent under the authority of the statutes 53 Geo. III. c. 155 and 3 & 4 Will. IV. c. 85. But the other Indian bishops have no position recognized by the State and no jurisdiction, except consensual.

The Church had the same jurisdiction in Scotland, and exercised it through similar courts to those which she had in England and France, till about 1570. As late as 1566 Archbishop Hamilton of Glasgow, upon his appointment, had restitution of his jurisdiction in the probate of testaments and other matters (Keith, *History of the Scottish Bishops*, Edinburgh, 1824, p. 38). There was an interval of uncertainty, with at any rate titular bishops, till 1592. Then parliament enacted a new system of Church courts which, though to some extent in its turn superseded by the revival of episcopacy under James VI., was revived or ratified by the act of 1600, c. 7, and stands to this day. It is a Presbyterian system, and the Scottish Episcopal Church is a disestablished and voluntary body since 1690.

Ecclesiastical jurisdiction in Scotland.

The Presbyterian courts thus created are arranged in ascending order:—

(a) *Kirk Session* consists of the minister of the parish and the "ruling elders" (who are elected by the session). It has cognizance of scandalous offences by laymen and punishes them by deprivation of religious privileges. It does not judge ministers (Brodie-Innes, *Comparative Principles of the Laws of England and Scotland*, 1903, p. 144).

(b) The *Presbytery* has jurisdiction, partly appellate and partly original, over a number of parishes. There are now eighty-four presbyteries. These courts consist of every parochial minister or professor of divinity of any university within the limits, and of an elder commissioned from every kirk session. A minister is elected to preside as moderator. These courts judge ministers in first instance for scandalous conduct. As civil courts they judge in first instance all questions connected with glebes and the erection and repair of churches and manses. They regulate matters concerning public worship and ordinances, and have appellate jurisdiction from the kirk session.

(c) The *Provincial Synod* consists of a union of three or more presbyteries with the same members. There are now sixteen. They meet twice a year to hear appeals from presbyteries. No appeal can go direct to the General Assembly, *omnisso medio*, unless the presbytery have so expressly directed, or unless there be no meeting of synod after the decision of the presbytery before the meeting of General Assembly.

(d) The *General Assembly* is the supreme ecclesiastical court of this system. It meets annually. The king's "lord high commissioner" attends the sittings; but does not intervene or take part in the court's decisions. The court consists of ministers and elders, elected from the presbyteries in specified proportions, and of commissioners from the four universities, the city of Edinburgh and the royal burghs. The Presbyterian Church in India sends one minister and one elder. The whole Assembly consists of 371 ministers and 333 elders. The jurisdiction is entirely appellate. The Assembly appoints a commission to exercise some of its functions during the intervals of its session. To this commission may be referred the cognizance of particular matters.

Questions of *patronage* now (by 37 & 38 Vict. c. 82) belong to the Church courts; but not questions of *lapse* or *stipend*. Seats, seat rents, pews, the union and disjunction of parishes and formation of district parishes are of secular jurisdiction. Questions of tithes (or "teinds") and ministers' stipends were referred to commissioners by acts of the Scots parliaments beginning in 1607. The commissioners of teinds became a species of ecclesiastical court. By Scots act of 1707, c. 9, their powers were transferred to the judges of the court of session, who now constitute a "teind court" (Brodie-Innes, *op. cit.* pp. 138, 139). Matrimonial matters and those relating to wills and succession (called in Scotland "consistorial" causes) were in 1563 taken from the old bishops' courts and given to "commissaries" appointed by the crown with an appeal to the court of session, which by act 1609, c. 6, was declared the king's great consistory. They have remained matters of secular jurisdiction.

The Scots ecclesiastical courts are entitled to the assistance of the secular courts to carry out their jurisdiction by "due assistance." Within the limits of their jurisdiction they are supreme. But if a court go outside its jurisdiction, or refuse to exercise powers conferred on it by law, the civil court may "reduce" (*i.e.* set aside) the sentence and award damages to the party aggrieved.

With the Reformation in the 16th century, Church courts properly speaking disappeared from the non-episcopal religious communities which were established in Holland, in the Protestant states of Switzerland and of Germany, and in the then non-episcopal countries of Denmark and Norway.

Discipline over ministers and other office-bearers was exercised by administrative methods in the form of trials before consistories or synods. To this extent ecclesiastical jurisdiction is still exercised in these countries. Consistories and synods have

Protestant consistorial European states.

exercised discipline of a penitential kind over their lay members; but in later times their censures have generally ceased to carry temporal consequences. Ecclesiastical jurisdiction on the civil side for the trial of causes soon disappeared. Heresy has been treated as a crime to be tried in and punished by the ordinary courts of the country, as in the cases of Servetus (*q.v.*) and Grotius (*q.v.*).

For the episcopal churches of Sweden and Finland the first constitution or "Church order" was formed in 1571. It provided for the visitation of the clergy by the bishop, and for the power of the clergy to exclude their lay folk from the Holy Communion, subject to appeal to the bishop. Both minor and major excommunication had been in use, and for a long time public penance was required. The procedure underwent great modification in 1686; but public penance was not taken away till 1855, and then confession and absolution by the priest in the presence of witnesses was still required. Civil jurisdiction in causes appears to have been given up early (Cornelius, *Spenska Kirkaus Historia*, Upsala, 1875, pp. 146, 186, 180, 285).

Over the rest of western continental Europe and in the colonies of Spain, Portugal and France, ecclesiastical jurisdiction remained generally in the state which we have already described till near the end of the 18th century. The council of Trent took away the jurisdiction of archdeacons in marriage questions. The testamentary jurisdiction disappeared (as already stated) in France. Disputed cases of contract were more often tried in the secular courts. Recourse to the secular prince by way of *appel comme d'abus*, or otherwise, became more frequent and met with greater encouragement. Kings began to insist upon trying ecclesiastics for treason or other political crimes in secular courts. So under the advice of his minister (the marquis of Pombal), King Joseph of Portugal in 1759-1760 claimed that the pope should give him permission to try in all cases clerics accused of treason, and was not content with the limited permission given to try and execute, if guilty, the Jesuits then accused of conspiring his death (*Life of Pombal*, by Count de Carnota, 1871, pp. 128, 141). But there was no sudden change in the position of the courts Christian till the French Revolution.

In France a law of the Revolution (September 1790) purported to suppress all ecclesiastical jurisdictions. On the re-establishing of the Catholic religion on the basis of the new Concordat, promulgated 18 Germinal, year X. (April 8, 1802), no express provision was made for ecclesiastical jurisdictions; but several bishops did create new ecclesiastical tribunals, "officialities" (Migne, *Dict. de droit canon.*, s.v.). The government in some cases recognized these tribunals as capable of judging ecclesiastical causes (Migne, *ubi sup.*). In 1810 the diocesan official of Paris entertained the cause between Napoleon and Josephine, and pronounced a decree of nullity (Migne, *ubi sup.* s.v. "Causes"). Such litigation as still continued before the spiritual forum was, however, confined (save in the case of the matrimonial questions of princes) to the professional conduct of the clergy.

Such neighbouring countries as were conquered by France or revolutionized after her pattern took the same course of suppressing their ecclesiastical jurisdictions. After 1814, some of these jurisdictions were revived. But the matter is now determined for all countries which have adopted codes, whether after the pattern of the Code Napoléon or otherwise. These countries have created a hierarchy of temporal courts competent to deal with every matter of which law takes cognizance, and a penal code which embraces and deals with all crimes or delicts which the state recognizes as offences. Hence, even in countries where the Roman Church is established, such as Belgium, Italy, the Catholic states of Germany and cantons of Switzerland, most of the Latin republics of America, and the province of Quebec, and *a fortiori* where this Church is not established, there is now no discipline over the laity, except penitential, and no jurisdiction exercised in civil suits, except possibly the matrimonial questions of princes (of which there was an example in the case of the reigning prince of Monaco). In Spain causes of nullity and divorce *a thoro*, in Portugal causes of nullity between

Catholics, are still for the court Christian. In Peru, the old ecclesiastical matrimonial jurisdiction substantially remains (Lehr, *Le Mariage dans les principaux pays*, 1899, arts. 362, 797, 772, 781). Otherwise these three countries are Code countries. In Austria, the ancient ecclesiastical jurisdiction was taken away by various acts of legislation from 1781 to 1856; even voluntary jurisdiction as to dispensations. The Concordat of 1856 and consequent legislation restored matrimonial jurisdiction to the courts Christian over marriages between Roman Catholics. In 1868 this was taken away. The Austrian bishops, however, maintain their tribunals for spiritual purposes, and insist that such things as divorce *a vinculo* must be granted by their authority (Aichner, *Compendium juris ecclesiastici*, pp. 551-553).

By consent and submission of her members, the Roman Church decides *in foro conscientiae* questions of marriage, betrothal and legitimacy everywhere; but no temporal consequences follow except in Spain, Portugal and Peru.

The position in France was the same as that in Belgium, Italy, &c., till 1906, when the Church ceased to be established. The only Latin countries in which conflict has not arisen appear to be the principality of Andorra and the republic of San Marino (Giron y Areas, *Situación jurídica de la Iglesia Católica*, Madrid, 1905, p. 173 et seq.).

Even as to the discipline of the Roman clergy it is only in certain limited cases that one can speak of ecclesiastical jurisdiction. Bishops and benefited incumbents (*curés*) must be regularly tried; and where the Church is established the canonical courts are recognized. But the majority of parishes are served by mere *desservants* or *vicaires*, who have no rights and can be recalled and dismissed by mere administrative order without trial (Migne, *ubi sup.* s.v. "Inamovibilité," "Desservants").

The Napoleonic legislation re-established the *appel comme d'abus* ("Articles organiques," art. 6). The recourse was now to the council of state (see Migne, *ubi supra*, "Officialité"). But the revocation of a *desservant*, and the forbidding him the execution of his ministry in the diocese, was not a case in which the council of state would interfere (Migne, *ubi sup.* "Appel comme d'abus," "Conseil d'état").

In those provinces of the Anglican communion where the Church is not established by the state, the tendency is not to attempt any external discipline over the laity; but on the other hand to exercise consensual jurisdiction over the clergy and office-bearers through courts nearly modelled on the old canonical patterns.

In the Roman communion, on the other hand, both where the Church is established and where it is not, the tendency is to reduce the status of *curé* to that of *desservant*, and to deal with all members of the priestly or lower orders by administrative methods. This practice obtains in all missionary countries, e.g. Ireland and also in Belgium (S. B. Smith, *Elements of Ecclesiastical Law*, New York, i. 197 et seq.; p. 403 et seq.; Tauber, *Manuel de juris canonique*, Sabarice, 1904, p. 277). In the United States, the 3rd plenary council of Baltimore in 1884 provided that one rector out of ten should be irremovable (Smith, *op. cit.* i. 107, 419). In England there are few Roman "benefices" (E. Taunton, *Law of the Church*, London, 1906, s.v. "Benefice"). A *desservant* has an informal appeal, by way of recourse, to the metropolitan and ultimately to the pope (Smith, *op. cit.* p. 201). The bishop's "official" is now universally called his vicar-general (except in France, where sometimes an *official* is appointed *eo nomine*), and generally exercises both voluntary and contentious jurisdiction (*op. cit.* i. 377). As of old, he must be at least tonsured and without a wife living. At the Vatican Council, a desire was expressed that he should be a priest (14). He should be a doctor in theology or a licentiate in canon law (*ib. p.* 378). Whether a bishop is bound to appoint a vicar-general is still disputed (*ib. p.* 380; cf. *supra*; contra, Bouix, *Inst. Juris Canon. De Judic.* i. 405). In 1831 the pope enacted that in all the dioceses of the then Pontifical States, the court of first instance for the criminal-causes of ecclesiastics should consist of the ordinary and four other judges. In the diocese of Rome

Roman
Catholic
countries.

Jurisdiction
in
Anglican
countries.

Modern
jurisdiction
of
Church
of
Rome.

the court of the cardinal vicar-general consists of such vicar-general and four other prelates (Smith, *ubi supra*). In the Roman communion in England and the United States, there are commissions of investigation appointed to hear in first instance the criminal causes of clerics. They consist of five, or at least three, priests nominated by the bishop in and with the advice of the diocesan synod. In the United States, since 1884, the bishop presides on these commissions. They report their opinions to the bishop, who passes final sentence (*ib. ii. 129-131*). "Exemptions" now include all the regular religious orders, *i. e.* those orders which have solemn vows. Over the members of these orders their superiors have jurisdiction and not the bishop. Otherwise if they live out of their monastery, or even within that enclosure so notoriously offend as to cause scandal. In the first case, they may be punished by the ordinary of the place, acting as delegate of the pope without special appointment (*Conc. Trid. Sess. vi. c. 3*). In the second case, the bishop may require the superior to punish within a certain time and to certify the punishment to him; in default he himself may punish (*Conc. Trid. Sess. xxv. c. 14, cf. Smith, op. cit. i. 204-206*). So, regulars having cure of souls are subject to the jurisdiction of the bishop in matters pertaining thereto (*ib. p. 206*). The exemption of regular religious orders may be extended to religious societies without solemn vows by special concession of the pope, as in the case of the Passionists and Redemptorists (*ib. p. 205; Sanguineti, Juris ecc. inst., Rome, 1890, pp. 393, 394*). Appeal lies, in nearly all cases, to the metropolitan (Smith, *op. cit. pp. 219-223*). Metropolitans usually now have a metropolitan tribunal distinct from their diocesan court (*ib. ii. 141*), but constructed on the same lines, with the metropolitan as judge and his vicar-general as vice-judge. In some "missionary" dioceses, the metropolitan, *qua* metropolitan, has a separate commission of investigation, to try the criminal causes of clerics, sentence being passed by himself or his vicar-general (*ib. p. 142*).

The next step in the hierarchy, that of "primates" (*supra*), has "in the present state of the Church" ceased to exist for our purpose (Sanguineti, *op. cit. p. 334*), as a result of Tridentine legislation. The only appellate jurisdiction from the metropolitans is the Roman See. To it also lies a direct appeal from the court of first instance, *omnis medio* (Smith, *op. cit. i. 224*). The pope's immediate and original jurisdiction in every diocese is now expressly affirmed by the Vatican Council (*ib. p. 239*). That original jurisdiction he reserves exclusively to himself in *causis majoribus* (*ib. pp. 249-250*). These are (1) causes relating to elections, translations and deprivations of, and criminal prosecutions against, bishops, and (2) the matrimonial cases of princes (Taunton, *op. cit. s. v. "Cause"*).

In the Eastern Church, the early system of ecclesiastical judicature long continued. But a sacred character was ascribed to the emperors. They are "anointed lords like the bishops" (Balsamon, in *Conc. Ancyr. Can. xii.*, representing the view of the 12th and 13th centuries). Bishops were often deposed by administrative order of the emperor; synods being expected afterwards to confirm, or rather accept, such order. The germ of this dealing with a *major causa* may be found in the practice of the Arian emperors in the 4th century. The cause of Ignatius and Photius was dealt with in the 9th century by various synods; those in the East agreeing with the emperor's view for the time being, while those in the West acted with the pope. (The details are in Mansi, *Conc. in locis*, and in Hefele, *Conc. in locis*, more briefly. They are summarized in Landon, *Manual of Councils, s. v. "Constantinople," "Rome,"* and in E. S. Foulkes, *Manual of Ecclesiastical History, s. v. "Century IX."*) Since these transactions patriarchs have been deposed by the Byzantine emperors; and the Turkish sultans since the 15th century have assumed to exercise the same prerogative.

The spiritual courts in the East have permanently acquired jurisdiction in the matrimonial causes of baptized persons; the Mahommedan governments allowing to Christians a personal law of their own. The patriarch of Constantinople is enabled

to exercise an extensive criminal jurisdiction over Christians (Neale, *Hist. of the Eastern Church, i. 30, 31*).

The empire of Russia has in the matter of ecclesiastical jurisdiction partly developed into other forms, partly systematized 4th century and later Byzantine rules. The provincial system does not exist; or it may be said that all Russia is one province. An exception should be made in the case of Georgia, which is governed by an "exarch," with three suffragans under him. In the remainder of the empire the titles of metropolitan, save in the case of the metropolitan of all Russia, and of archbishop, were and are purely honorary, and their holders have merely a diocesan jurisdiction (see Mouravieff, *History of the Russian Church*, translated Blackmore, 1842, translator's notes at pp. 370, 390, 416 et seq.). So in Egypt the bishop or "pope" (afterwards patriarch) of Alexandria was the only true metropolitan (Neale, *History of the Eastern Church*, Gen. Intro. vol. i. p. 111). The metropolitan of Russia from the time of the conversion (A. D. 988) settled at Kiev, and his province was part of the patriarchate of Constantinople, and appeals lay to Constantinople. Many such appeals were taken, notably in the case of Leon, bishop of Rostov (Mouravieff, *op. cit. p. 38*). The metropolitanical see was for a short time transferred to Vladimir and then finally to Moscow (Mouravieff, *chs. iv., v.*). After the taking of Constantinople in 1452, the Russian metropolitans were always chosen and consecrated in Russia, appeals ceased, and Moscow became *de facto* autocephalous (Joyce, *ubi sup. p. 379*; Mouravieff, *op. cit. p. 126*). The tsar Theodore in 1587 exercised the power of the Byzantine emperors by deposing the metropolitan, Dionysius Grammaticus (Mouravieff, p. 125). In 1587 the see of Moscow was raised to patriarchal rank with the consent of Constantinople, and the subsequent concurrence of Alexandria, Antioch and Jerusalem (*ib. c. vi.*). Moscow became the final court, in theory, as it had long been in practice. Certain religious houses, however, had their own final tribunals and were "peculiar," exempt from any diocesan or patriarchal jurisdiction for at least all causes relating to Church property (*ib. p. 131*).

The subject matter of ecclesiastical jurisdiction in Russia during the whole patriarchal period included matrimonial and testamentary causes, inheritance and sacrilege, and many questions concerning the Church domains and Church property, as well as spiritual offences of clergy and laity (*ib.*). The bishops had consistorial courts; the patriarchs, chanceries and consistories (*ib.*). Bishops were judged in synod (see, *e. g.* the case of the archbishop of Polotsk in 1622, *ib. p. 179*) and only lawfully judged in synod (*ib. p. 215*).

Clerks and the dependants of the metropolitan (afterwards the patriarch) appear to have been immune from secular jurisdiction, except in the case of crimes against life, from the time of Ivan the Terrible (*ib. pp. 180-181*). The tsar Michael, in the earlier 17th century, confirmed these immunities in the case of the clergy of the patriarch's own diocese, but provided that in country places belonging to his diocese, monasteries, churches and lands should be judged in secular matters by the Court of the Great Palace, theoretically held before the tsar himself (*ib. p. 181*). This tsar limited the "peculiar" monasteries to three, and gave the patriarch jurisdiction over them (*ib.*). The next tsar, Alexis, however, by his code instituted a "Monastery Court," which was a secular tribunal composed of laymen, to judge in civil suits against spiritual persons, and in matters arising out of their manors and properties (*ib. p. 193*). This court was not in operation during the time when the patriarch Nikon was *de facto* in effect first minister; but upon his decline exercised its full jurisdiction (*ib. p. 216*). Nikon was himself tried for abdicating his see, causing disorder in the realm, oppression and violence, first before a synod of Moscow composed of his suffragans and some Greek bishops, and afterwards before another synod in which sat the patriarchs of Alexandria and Antioch, the metropolitans of Servia and Georgia, the archbishops of Sinai and Wallachia, and the metropolitans of Nice, Amasis, Iconium, Trebizond, Varna and Scio, besides the Russian bishops. This synod in 1667 deposed Nikon, degraded him from holy orders, and sentenced him to perpetual penance in a monastery (*ib. pp. 220-232*). The next tsar, Theodore,

qu, ~~ground~~ the secular monastery court," and directed that all suits against spiritual persons should proceed only in the patriarchal "court of requests" (*ib.* p. 264). There was, however, a species of *appel comme d'abus*. Causes could be evoked to the tsar himself, "when any partiality of the judges in any affair in which they themselves were interested was discovered" (*ib.*).

The old system was swept away by Peter the Great, who settled ecclesiastical jurisdiction substantially on its present basis. The patriarchate was abolished and its jurisdiction transferred by a council at St Petersburg in 1721 to a Holy Governing Synod. The change was approved by the four patriarchs of the East in 1723 (*ib.* chs. xv.-xvii.). Peter permanently transferred to the secular *forum* the testamentary jurisdiction and that concerning inheritance, as also questions of "sacrilege" (*ib.* p. 264). As the result of a long series of legislation, beginning with him and ending with Catherine II., all church property of every kind was transferred to secular administration, allowances, according to fixed scales, being made for ministers, monks and fabrics (*op. cit.* translator's appendix i. p. 413 et seq.). There remain to the spiritual courts in Russia the purely ecclesiastical discipline of clerks and laity and matrimonial causes.

The court of first instance is the "consistorial court" of the bishop. This consists of a small body of ecclesiastics. Its decisions must be confirmed by the bishop (*op. cit.* translator's appendix ii. pp. 422-423). In the more important causes, as divorce (*i.e.* *a vinculo*), it only gives a provisional decision, which is reported by the bishop, with his own opinion, for final judgment, to the Most Holy Governing Synod.

The governing synod is the final court of appeal. It consists of a small number of bishops and priests nominated by the tsar, and is assisted by a "procurator," who is a layman, who explains to it the limits of its jurisdiction and serves as the medium of communication between it and the autocrat and secular authorities. It deals with the secular crimes of spiritual persons, if of importance and if not capital (these last being reserved for the secular *forum*), and with heresy and schism. It is the only court which can try bishops or decree divorce. The tsar formally confirms its judgments; but sometimes reduces penalties in the exercise of the prerogative of mercy (see Mouravieff, *op. cit.* ch. xvii. translator's app. ii.).

The governing synod now sits at St Petersburg, but appoints delegated commissions, with a portion of its jurisdiction, in Moscow and Georgia. The latter commission is presided over by the "exarch" (*supra*).

Since the War of Independence, the kingdom of Greece has been ecclesiastically organized after the model of Russia, as one autocephalous "province," separated from its old patriarchate of Constantinople, with an honorary metropolitan and honorary archbishops (Neale, *op. cit.* Gen. Intro. vol. i.). The Holy Synod possesses the metropolitan jurisdiction. It sits at Athens. The metropolitan of Athens is president, and there are four other members appointed by the government in annual rotation from the senior bishops. There is attached to it a government commissioner, with no vote, but affixing his signature to the synodical judgments (Joyce, *op. cit.* p. 35).

The subject matter of the jurisdiction of Hellenic courts Christian seems to be confined to strictly spiritual discipline, mainly in regard to the professional misconduct of the clergy. Imprisonment may be inflicted in these last cases (*ib.*). All matrimonial causes are heard by the secular tribunals (Lehr, *op. cit.* sec. 587).

The bishop's consistorial court, consisting of himself and four priests, has a limited jurisdiction in first instance. Such a court can only suspend for seven days unless with the sanction of the Holy Synod (Joyce, *op. cit.*).

The Holy Synod can only inflict temporary suspension, or imprisonment for fifteen days, unless with the sanction of the King's ministry. Deprivation, or imprisonment for more than two months, requires the approval of the king (*ib.*). The king or the ministry do not, however, rehear the cause by way of appeal, but merely restrain severity of sentence (*ib.*).

The Church of Cyprus has been autocephalous since at any rate

the oecumenical synod of Ephesus in 431. The episcopate now consists of an archbishop and three suffragans (Hackett, *Orthodox Church in Cyprus*, 1901, ch. v. et *passim*). The final court is the island synod, which consists of the archbishop, his suffragans and four dignified priests. It has original and exclusive cognizance of causes of deposition of bishops (*op. cit.* pp. 260, 262).

Each bishop is assisted by at least two officers with judicial or quasi-judicial powers, the "archimandrite" who adjudicates upon causes of revenue and the archdeacon who adjudicates on questions between deacons (*op. cit.* pp. 272-273). The "exarch" of the archbishop, who is a dignitary but not a bishop, has a seat in the provincial synod.

In the Balkan States, the system—inherited from Byzantine and Turkish times—of ecclesiastical jurisdictions prevails, except that they are now autocephalous, and independent of the patriarch of Constantinople. Matrimonial causes in Servia are of ecclesiastical cognizance (Lehr, *op. cit.* sect. 901).

AUTHORITIES.—St Augustine, *Epistles*; *Codex Theodosianus*, edited by Th. Mommsen and P. M. Meyer (1905); *Code and Novells of Emperor Justinian*, ed. J. G. Hohofredus (1665); T. Balsamon, *In Conc. Ancyr.* in the *Corpus juris canonici* (1870-1881); "Hosiensis" *Super Decretum*; W. Lyndwood, *Provinciale* (Oxford, 1679); Sir A. Fitzherbert, *Natura brevium* (1534); Sir T. Ridley, *View of the Civile and Ecclesiastical Law* (1607); J. Ayliffe, *Parergon juris ecclesiastici* (1726); J. Godolphin, *Abridgement of the Laws Ecclesiastical* (London, 1687); E. Gibson, *Codex juris ecclesiastici* (Oxford, 1761); D. Covarruvias, *Opera omnia* (Antwerp, 1638); Jean Hardouin, *Concilia* (1715); J. D. Mansi, *Concilia* (1750-1798); E. Stillingfleet, *Ecclesiastical Jurisdiction* (1704); L. S. le Nain de Tillemont, *Mémoires pour servir à l'histoire ecclésiastique* (1701-1712); P. T. Durand de Maillane, *Dictionnaire du droit canonique* (1761); *Dictionnaire ecclésiastique et canonique*, par une société de religieux (Paris, 1765); Z. B. van Espen, *Jus ecclesiasticum universum* (Louvain, 1720); *De recursu ad Principem, observationes in Concilium Lateranense iv.*; L. Thomassin, *Vetus et nova disciplina ecc.* (1705-1706); W. Beveridge, *Synodicon* (Oxford, 1672); J. A. S. da Carnota, *Life of Pombal* (1843); J. P. Migne, *Dictionnaire de droit canon.* (Paris, 1844); R. Keitt, *History of the Scottish Bishops* (Edinburgh, 1824); P. N. Vives y Cebrás, *Usages y demas derechos de Cataluña* (1832); C. A. Cornelius, *Svenska kyrkans Historia* (Upsala, 1875); Mouravieff, *History of the Russian Church* (trans. Blackmore, 1842); Foulkes, *Manual of Ecclesiastical History* (1851); E. H. Landon, *Manual of Councils of the Church* (1891); W. H. Hale, *Precedents in Criminal Cases* (London, 1847); E. B. Pusey, *Councils of the Church* (Oxford, 1857); C. J. von Heele, *Conciliengeschichte* (Freiburg, 1855-1890); M. Gaudry, *Traité de la législation des cultes* (Paris, 1854); W. Stubbs, *Select Charters* (Oxford, 1895); A. W. Haddon and W. Stubbs, *Councils and Ecclesiastical Documents* (Oxford, 1869); A. J. Stephens, *Ecclesiastical Statutes* (1845); H. C. Rothery, *Return of Cases before Delegates* (1864); J. W. Joyce, *The Sword and the Keys* (2nd ed., 1881); *Report of Ecclesiastical Courts Commission* (1888); P. Fourrier, *Les Officialités au moyen âge* (1880); S. B. Smith, *Elements of Ecclesiastical Law* (New York, 1889-1890); S. Sanguinetti, *Juris ecc. inst.* (Rome, 1890); J. F. Stephen, *History of the Criminal Law of England* (London, 1883); Pollock and Maitland, *History of English Law before Edward I.* (1898); F. W. Maitland, *Roman Canon Law in the Church of England* (1898); R. Owen, *Canon Law* (1884); Sir R. J. Phillimore, *Ecclesiastical Law* (2nd ed., 1895); J. W. Brodrick, *Comparative Principles of the Laws of England and Scotland* (1903); R. B. Merriman, *Life and Letters of Thomas Cromwell* (1902); S. Achiner, *Comparative juris ecclesiasticus* (8th ed., Brixen, 1905, especially in regard to Austro-Hungarian Empire); J. Hackett, *History of the Orthodox Church in Cyprus* (1901); Tauber, *Manuale juris canonici* (1906); E. L. Tauntun, *Law of the Church* (London, 1906); *Report of Royal Commission on Ecclesiastical Discipline* (1906). (W. G. F. F.)

ECCLESIASTICAL LAW, in its broadest sense, the sum of the authoritative rules governing the Christian Church, whether in its internal polity or in its relations with the secular power. Since there are various churches, widely differing alike in their principles and practice, it follows that a like difference exists in their ecclesiastical law, which is the outcome of their corporate consciousness as modified by their several relations to the secular authority. At the outset a distinction must be made between churches which are "established" and those that are "free." The ecclesiastical laws of the latter are, like the rules of a private society or club, the concern of the members of the church only, and come under the purview of the state only in so far as they come in conflict with the secular law (e.g. polygamy among the Mormons, or violation of the trust-deeds under which

the property of a church is held). In the case of "established" Churches, on the other hand, whatever the varying principle on which the system is based, or the difference in its practical application, the essential conditions are that the ecclesiastical law is also the law of the land, the decisions of the church courts being enforced by the civil power. This holds good both of the Roman Catholic Church, wherever this is recognized as the "state religion," of the Oriental Churches, whether closely identified with the state itself (as in Russia), or endowed with powers over particular nationalities within the state (as in the Ottoman empire), and of the various Protestant Churches established in Great Britain and on the continent of Europe.

Writers on the theory of ecclesiastical law, moreover, draw a fundamental distinction between that of the Church of Rome and that of the Protestant national or territorial Churches. This distinction is due to the claim of the Roman Catholic Church to be the *only* Church, her laws being thus of universal obligation; whereas the laws of the various established Protestant Churches are valid—at least so far as legal obligation is concerned—only within the limits of the countries in which they are established. The practical effects of this distinction have been, and still are, of enormous importance. The Roman Catholic Church, even when recognized as the state religion, is nowhere "established" in the sense of being identified with the state, but is rather an *imperium in imperio* which negotiates on equal terms with the state, the results being embodied in concordats (*q.v.*) between the state and the pope as head of the Church. The concordats are of the nature of truces in the perennial conflict between the spiritual and secular powers, and imply in principle no surrender of the claims of the one to those of the other. Where the Roman Catholic Church is not recognized as a state religion, as in the United States or in the British Islands, she is in the position of a "free Church," her jurisdiction is only *in foro conscientiae*, and her ecclesiastical laws have no validity from the point of view of the state. On the other hand, the root principle of the ecclesiastical law of the established Protestant Churches is the rejection of alien jurisdiction and the assertion of the supremacy of the state. The theory underlying this may vary. The sovereign may be regarded, as in the case of the Russian emperor or of the English kings from the Reformation to the Revolution, as the vicar of God in all causes spiritual as well as temporal within his realm. As the first fervent belief in the divine right of kings faded, however, a new basis had to be discovered for a relation between the spiritual and temporal powers against which Rome had never ceased to protest. This was found in the so-called "collegial" theory of Church government (*Kollegial-system*), which assumed a sort of tacit concordat between the state and the religious community, by which the latter vests in the former the right to exercise a certain part of the *jus in sacra* properly inherent in the Church (see PUFENDORF, SAMUEL). This had great and lasting effects on the development of the theory of Protestant ecclesiastical law on the continent of Europe. In England, on the other hand, owing to the peculiar character of the Reformation there and of the Church that was its outcome, no theory of the ecclesiastical law is conceivable that would be satisfactory at once to lawyers and to all schools of opinion within the Church. This has been abundantly proved by the attitude of increasing opposition assumed by the clergy, under the influence of the Tractarian movement, towards the civil power in matters ecclesiastical, an attitude impossible to justify on any accepted theory of the Establishment (see below).

Protestant ecclesiastical law, then, is distinguished from that of the Roman Catholic Church (1) by being more limited in its scope, (2) by having for its authoritative source, not the Church only or even mainly, but the Church in more or less complete union with or subordination to the State, the latter being considered, equally with the Church, as an organ of the will of God. The ecclesiastical law of the Church of Rome, on the other hand, whatever its origin, is now valid only in so far as it has the sanction of the authority of the Holy See. And here it must be noted that the "canon law" is not identical with the "ecclesiastical law" of the Roman Catholic Church. By the canon law

is meant, substantially, the contents of the *Corpus juris canonici*, which have been largely superseded or added to by, e.g. the canons of the council of Trent and the Vatican decrees. The long projected codification of the whole of the ecclesiastical law of the Church of Rome, a work of gigantic labour, was not taken in hand until the pontificate of Pius X. (See also CANON LAW and ECCLESIASTICAL JURISDICTION.)

The ecclesiastical law of England is in complete dependence upon the authority of the state. The Church of England cannot be said, from a legal point of view, to have a corporate existence or even a representative assembly. The Convocation of York and the Convocation of Canterbury are provincial assemblies possessing no legislative or judicial authority; even such purely ecclesiastical questions as may be formally commended to their attention by "letters of business" from the crown can only be finally settled by act of parliament. The ecclesiastical courts are for the most part officered by laymen, whose subordination to the archbishops and bishops is purely formal, and the final court of appeal is the Judicial Committee of the Privy Council. In like manner changes in the ecclesiastical law are made directly by parliament in the ordinary course of legislation, and in point of fact a very large portion of the existing ecclesiastical law consists of acts of parliament.

The sources of the ecclesiastical law of England are thus described by Dr. Richard Burn (*The Ecclesiastical Law*, 9th ed., 1842):—"The ecclesiastical law of England is compounded of these four main ingredients—the civil law, the canon law, the common law, and the statute law. And from these, digested in their proper rank and subordination, to draw out one uniform law of the church is the purport of this book. When these laws do interfere and cross each other, the order of preference is this:—'The civil law submitteth to the canon law; both of these to the common law; and all three to the statute law. So that from any one or more of these, without all of them together, or from all of them together without attending to their comparative obligation, it is not possible to exhibit any distinct prospect of the English ecclesiastical constitution.' Under the head of statute law Burn includes 'the Thirty-nine Articles of Religion, agreed upon in Convocation in the year 1562; and in like manner the Rubric of the Book of Common Prayer, which, being both of them established by Acts of Parliament, are to be esteemed as part of the statute law.'"

The first principle of the ecclesiastical law in England is the assertion of the supremacy of the crown, which in the present state of the constitution means the same thing as the supremacy of parliament. This principle has been maintained ever since the Reformation. Before the Reformation the ecclesiastical supremacy of the pope was recognized, with certain limitations, in England, and the Church itself had some pretensions to ecclesiastical freedom. The freedom of the Church is, in fact, one of the standing provisions of those charters on which the English constitution was based. The first provision of *Magna Carta* is *quod ecclesia Anglicana libera sit*. By the various enactments of the period of the Reformation the whole constitutional position of the Church, not merely with reference to the pope but with reference to the state, was definitely fixed. The legislative power of convocation was held to extend to the clergy only, and even to that extent required the sanction and assent of the crown. The common law courts controlled the jurisdiction of the ecclesiastical courts, claiming to have "the exposition of such statutes or acts of parliament as concern either the extent of the jurisdiction of these courts or the matters depending before them. And therefore if these courts either refuse to allow these acts of parliament, or expound them in any other sense than is truly and properly the exposition of them, the king's great courts of common law may prohibit and control them."

The design of constructing a code of ecclesiastical laws was entertained during the period of the Reformation, but never carried into effect. It is alluded to in various statutes of the reign of Henry VIII., who obtained power to appoint a commission to examine the old ecclesiastical laws, with a view of deciding which ought to be kept and which ought to be abolished;

and in the meantime it was enacted that "such canons, institutions, ordinances, synodal or provincial or other ecclesiastical laws or jurisdictions spiritual as be yet accustomed and used here in the Church of England, which necessarily and conveniently are requisite to be put in use and execution for the time, not being repugnant, contrariant, or derogatory to the laws or statutes of the realm, nor to the prerogatives of the royal crown of the same, or any of them, shall be occupied, exercised, and put in use for the time with this realm" (35 Henry VIII. c. 26, 25 c. 19, 27 c. 8).

The work was actually undertaken and finished in the reign of Edward VI. by a sub-committee of eight persons, under the name of the *Reformatio legum ecclesiasticarum*, which, however, never obtained the royal assent. Although the powers of the 25 Henry VIII. c. 1 were revived by the 1 Elizabeth c. 1, the scheme was never executed, and the ecclesiastical laws remained on the footing assigned to them in that statute—so much of the old ecclesiastical laws might be used as had been actually in use, and was not repugnant to the laws of the realm.

The statement is, indeed, made by Sir R. Phillimore (*Ecclesiastical Law*, 2nd ed., 1895) that the "Church of England has at all times, before and since the Reformation, claimed the right of an independent Church in an independent kingdom, to be governed by the laws which she has deemed it expedient to adopt." This position can only be accepted if it is confined, as the authorities cited for it are confined, to the resistance of interference from abroad. If it mean that the Church, as distinguished from the kingdom, has claimed to be governed by laws of her own making, all that can be said is that the claim has been singularly unsuccessful. From the time of the Reformation no change has been made in the law of the Church which has not been made by the king and parliament, sometimes indirectly, as by confirming the resolutions of convocation, but for the most part by statute. The list of statutes cited in Sir R. Phillimore's *Ecclesiastical Law* fills eleven pages. It is only by a legal fiction akin to the "collegial" theory mentioned above, that the Church can be said to have deemed it expedient to adopt these laws.

The terms on which the Church Establishment of Ireland was abolished, by the Irish Council Act of 1869, may be mentioned. By sect. 20 the present ecclesiastical law was made binding on the members for the time being of the Church, "as if they had mutually contracted and agreed to abide by and observe the same"; and by section 21 it was enacted that the ecclesiastical courts should cease after the 1st of January 1871, and that the ecclesiastical laws of Ireland, except so far as relates to matrimonial causes and matters, should cease to exist as law. (See also ENGLAND, CHURCH OF; ESTABLISHMENT; &c.)

AUTHORITIES.—The number of works on ecclesiastical law is very great, and it must suffice here to mention a few of the more conspicuous modern ones: Ferdinand Walter, *Lehrbuch des Kirchenrechts aller christlichen Konfessionen* (14th ed., Bonn, 1871); G. Phillips, *Kirchenrecht*, Bde. i.-vii. (Regensburg, 1845-1872) incomplete; the text-book by Cardinal Hergenröther (q.v.); P. Hinschius, *Kirchenrecht der Katholiken und Protestanten in Deutschland*, 6 Bde. (Berlin, 1869 sqq.). only the Catholic part, a masterly and detailed survey of the ecclesiastical law, finished: Sir Robert Phillimore, *Ecc. Law of the Church of England* (2nd ed., edited by Sir Walter Phillimore, 2 vols., London, 1895). For further references see CANON LAW, and the article "Kirchenrecht" in Herzog-Hauck, *Realencyclopädie* (ed. Leipzig, 1901).

ECCLESIASTICUS (abbreviated to *Eclus.*), the alternative title given in the English Bible to the apocryphal book otherwise called "The Wisdom of Jesus the son of Sirach." The Latin word *ecclesiasticus* is, properly speaking, not a name, but an epithet meaning "churchly," so that it would serve as a designation of any book which was read in church or received ecclesiastical sanction, but in practice *Ecclesiasticus* has become a by-name for the Wisdom of Sirach. The true name of the book appears in the authorities in a variety of forms, the variation affecting both the author's name and the description of his book. The writer's full name is given in 1. 27 (Heb. text) as "Simeon the son of Jeshua (i.e. Jesus) the son of Eleazar the son of Sira." In the Greek text this name appears as "Jesus son of Sirach

Eleazar" (probably a corruption of the Hebrew reading), and the epithet "of Jerusalem" is added, the translator himself being resident in Egypt. The whole name is shortened sometimes to "Son of Sira," *Ben Sira* in Hebrew, *Bar Sira* in Aramaic, and sometimes (as in the title prefixed in the Greek cod. B) to *Sirach*. The work is variously described as the *Words* (Heb. text), the *Book* (Talmud), the *Proverbs* (Jerome), or the *Wisdom of the son of Sira* (or *Sirach*).

Of the date of the book we have only one certain indication. It was translated by a person who says that he "came into Egypt in the 38th year of Euergetes the king" (Ptolemy VII.), i.e. in 132 B.C., and that he executed the work some time later. The translator believed that the writer of the original was his own grandfather (or ancestor, *πάππος*). It is therefore reasonable to suppose that the book was composed not later than the first half of the 2nd century B.C., or (if we give the looser meaning to *πάππος*) even before the beginning of the century. Arguments for a pre-Maccabean date may be derived (a) from the fact that the book contains apparently no reference to the Maccabean struggles, (b) from the eulogy of the priestly house of Zadok which fell into disrepute during these wars for independence.

In the Jewish Church *Ecclesiasticus* hovered on the border of the canon; in the Christian Church it crossed and recrossed the border. The book contains much which attracted and also much which repelled Jewish feeling, and it appears that it was necessary to pronounce against its canonicity. In the Talmud (*Sanhedrin* 100 b) Rabbi Joseph says that it is forbidden to read (i.e. in the synagogue) the book of ben Sira, and further that "if our masters had not hidden the book (i.e. declared it uncanonical), we might interpret the good things which are in it" (Schechter, *J. Q. Review*, iii. 601-602). In the Christian Church it was largely used by Clement of Alexandria (c. A.D. 200) and by St Augustine. The lists of the Hebrew canon, however, given by Melito (c. A.D. 180) and by Origen (c. A.D. 230) rightly exclude *Ecclesiasticus*, and Jerome (c. A.D. 390-400) writes: "Let the Church read these two volumes (Wisdom of Solomon and *Ecclesiasticus*) for the instruction of the people, not for establishing the authority of the dogmas of the Church" (*Praefatio in libros Solomonis*). In the chief MS. of the Septuagint, cod. B, *Ecclesiasticus* comes between Wisdom and Esther, no distinction being drawn between canonical and uncanonical. In the Vulgate it immediately precedes Isaiah. The council of Trent declared this book and the rest of the books reckoned in the Thirty-nine Articles as apocryphal to be canonical.

The text of the book raises intricate problems which are still far from solution. The original Hebrew (rediscovered in fragments and published between 1896 and 1900) has come down to us in a mutilated and corrupt form. The beginning as far as iii. 7 is lost. There is a gap from xvi. 26 to xxx. 11. There are marginal readings which show that two different recensions existed once in Hebrew. The Greek version exists in two forms—(a) that preserved in cod. B and in the other uncial MSS., (b) that preserved in the cursive codex 248 (Holmes and Parsons). The former has a somewhat briefer text, the latter agrees more closely with the Hebrew text. The majority of Greek cursives agree generally with the Latin Vulgate, and offer the fuller text in a corrupt form. The Syriac (Peshitta) version is paraphrastic, but on the whole it follows the Hebrew text. Owing to the mutilation of the Hebrew by the accidents of time the Greek version retains its place as the chief authority for the text, and references by chapter and verse are usually made to it.

Bickell and D. S. Margolouth have supposed that the Hebrew text preserved in the fragments is not original, but a retranslation from the Greek or the Syriac or both. This view has not commended itself to the majority of scholars, but there is at least a residuum of truth in it. The Hebrew text, as we have it, has a history of progressive corruption behind it, and its readings can often be emended from the Septuagint, e.g. xxxvii. 11 (read בְּיָמָיו for the meaningless בְּיָמָיו). The Hebrew marginal readings occasionally seem to be translations from the Greek or Syriac, e.g. xxxviii. 4 (וְעַתָּה for ἐν τῷ ἑσπέρῳ). More frequently, however, strange readings of the Greek and Syriac

are to be explained as corruptions of our present Hebrew. Substantially our Hebrew must be pronounced original.

The restoration of a satisfactory text is beyond our hopes. Even before the Christian era the book existed in two recensions, for we cannot doubt, after reading the Greek translator's preface, that the translator amplified and paraphrased the text before him. It is probable that at least one considerable omission must be laid to his charge, for the hymn preserved in the Hebrew text after ch. li. 12 is almost certainly original. Ancient translators allowed themselves much liberty in their work, and Ecclesiasticus possessed no reputation for canonicity in the 2nd century B.C. to serve as a protection for its text. Much, however, may be done towards improving two of the recensions which now lie before us. The incomplete Hebrew text exists in four different MSS.; and the study of the peculiarities of these had already proved fruitful. The Syriac text, made without doubt from the Hebrew, though often paraphrastic is often suggestive. The Greek translation, made within a century or half-century of the writing of the book, must possess great value for the criticism of the Hebrew text. The work of restoring true Hebrew readings may proceed with more confidence now that we have considerable portions of the Hebrew text to serve as a model. For the restoration of the Greek text we have, besides many Greek MSS., uncial and cursive, the old Latin, the Syro-Hexaplar, the Armenian, Sahidic and Ethiopic versions, as well as a considerable number of quotations in the Greek and Latin Fathers. Each of the two recensions of the Greek must, however, be separately studied, before any restoration of the original Greek text can be attempted.

The uncertainty of the text has affected both English versions unfavourably. The Authorized Version, following the corrupt cursives, is often wrong. The Revised Version, on the other hand, in following the uncial MSS. sometimes departs from the Hebrew, while the Authorized Version with the cursives agrees with it. Thus the Revised Version (with codd. *m*, A, B, C) omits the whole of iii. 19, which the Authorized Version retains, but for the clause, "Mysteriarevealedunto themeck," the Authorized Version has the support of the Hebrew, Syriac and cod. 248. Sometimes both versions go astray in places in which the Hebrew text recommends itself as original by its vigour; e.g. in vii. 26, where the Hebrew is,

Hast thou a wife? abominate her not.
Hast thou a hated wife? trust not in her.

Again in ch. xxxviii. the Hebrew text in at least two interesting passages shows its superiority over the text which underlies both English versions.

Hebrew.

Revised Version (similarly Authorized Version).

ver. 1.	Acquaint thyself with a physician before thou have need of him.	Honour a physician according to thy need of him with the honours due unto him.
ver. 15.	He that sinneth against his Maker will behave himself proudly against a physician.	He that sinneth before his Maker, let him fall into the hands of the physician.

In the second instance, while the Hebrew says that the man who rebels against his Heavenly Benefactor will *a fortiori* rebel against a human benefactor, the Greek text gives a cynical turn to the verse, "Let the man who rebels against his true benefactor be punished through the tender mercies of a quack." The Hebrew text is probably superior also in xlv. 1, the opening words of the eulogy of the Fathers: "Let me now praise favoured men," *i.e.* men in whom God's grace was shown. The Hebrew phrase is "men of grace," as in v. 10. The Greek text of v. 1, "famous men," seems to be nothing but a loose paraphrase, suggested by v. 2, "The Lord manifested in them great glory."

In character and contents Ecclesiasticus resembles the book of Proverbs. It consists mainly of maxims which may be described in turn as moral, utilitarian and secular. Occasionally the author attacks prevalent religious opinions, e.g. the denial of free-will (xv. 11-20), or the assertion of God's indifference towards men's actions (xxv. 12-19). Occasionally, again, Ben Sira

touches the highest themes, and speaks of the nature of God: "He is All" (xliii. 27); "He is One from everlasting" (xlii. 21, Heb. text); "The mercy of the Lord is upon all flesh" (xviii. 13). Though the book is imitative and secondary in character it contains several passages of force and beauty, e.g. ch. ii. (how to fear the Lord); xv. 11-20 (on free-will); xxiv. 1-22 (the song of wisdom); xli. 15-25 (praise of the works of the Lord); xlv. 1-15 (the well-known praise of famous men). Many detached sayings scattered throughout the book show a depth of insight, or a practical shrewdness, or again a power of concise speech, which stamps them on the memory. A few examples out of many may be cited. "Call no man blessed before his death" (xi. 28); "He that toucheth pitch shall be defiled" (xiii. 1); "He hath not given any man licence to sin" (xv. 20); "Man cheriseth anger against man; and doth he seek healing from the Lord?" (xxviii. 3); "Mercy is seasonable . . . as clouds of rain" (xxiv. 20); "All things are double one against another: and he hath made nothing imperfect" (xlii. 24, the motto of Butler's *Analogy*); "Work your work before the time cometh, and in his time he will give you your reward" (li. 30). In spite, however, of the words just quoted it cannot be said that Ben Sira preaches a hopeful religion. Though he says, "Renew thy signs, and repeat thy wonders . . . Fill Sion with thy majesty and thy Temple with thy glory" (xxvi. 6, 14 [19], Heb. text), he does not look for a Messiah. Of the resurrection of the dead or of the immortality of the soul there is no word, not even in xli. 1-4, where the author exhorts men not to fear death. Like the Psalmist (Ps. lxxxviii. 10, 11) he asks, "Who shall give praise to the Most High in the grave?" In his maxims of life he shows a somewhat frigid and narrow mind. He is a pessimist as regards women; "From a woman was the beginning of sin; and because of her we all die" (xv. 24). He does not believe in home-spun wisdom; "How shall he become wise that holdeth the plough?" (xxxviii. 25). Artificers are not expected to pray like the wise man; "In the handywork of their craft is their prayer" (v. 34). Merchants are expected to cheat; "Sin will thrust itself in between buying and selling" (xxvii. 2).

BIBLIOGRAPHY—The literature of Ecclesiasticus has grown very considerably since the discovery of the first Hebrew fragment in 1896. A useful summary of it is found at the end of Israel Levi's article, "Sirach," in the *Jewish Encyclopedia*. Eberhard Nestle's article in Hastings's *Dictionary of the Bible* is important for its bibliographical information as well as in other respects. A complete edition of the Hebrew fragments in colotype facsimile was published jointly by the Oxford and Cambridge Presses in 1901. J. H. A. Hart's edition of cod. 248 throws much light on some of the problems of this book. It contains a fresh collation of all the chief authorities (Heb., Syr., Hex., Lat. and Gr.) for the text, together with a complete textual commentary.

The account given in the *Synopsis* attributed to Athanasius (Migne, P.G. iv. 375-384) has an interest of its own. The beginning is given in the Authorized Version as "A prologue made by an uncertain author."

ECGBERT, or **ECGERHT** (d. 839), king of the West Saxons, succeeded to the throne in 802 on the death of Beorhtic. It is said that at an earlier period in his life he had been driven out for three years by Offa and Beorhtic. The accession of Ecgbert seems to have brought about an invasion by Æthelmund, earl of the Hwicce, who was defeated by Weostan, earl of Wiltshire. In 815 Ecgbert ravaged the whole of the territories of the West Welsh, which probably at this time did not include much more than Cornwall. The next important occurrence in the reign was the defeat of Beornwulf of Mercia at a place called Ellandun in 825. After this victory Kent, Surrey, Sussex and Essex submitted to Wessex; while the East Anglians, who slew Beornwulf shortly afterwards, acknowledged Ecgbert as overlord. In 829 the king conquered Mercia, and Northumbria accepted him as overlord. In 830 he led a successful expedition against the Welsh. In 836 he was defeated by the Danes, but in 838 he won a battle against them and their allies the West Welsh at Hingston Down in Cornwall. Ecgbert died in 839, after a reign of thirty-seven years, and was succeeded by his son Æthelwulf. A somewhat difficult question has arisen as to the parentage of Ecgbert. Under the year 825 the Chronicle states

that in his eastern conquests Ecgbert recovered what had been the rightful property of his kin. The father of Ecgbert was called Ealhmund, and we find an Ealhmund, king in Kent, mentioned in a charter dated 784, who is identified with Ecgbert's father in a late addition to the Chronicle under the date 784. It is possible, however, that the Chronicle in 825 refers to some claim through Ine of Wessex from whose brother Ingeld Ecgbert was descended.

See *Anglo-Saxon Chronicle*, edited by Earle and Plummer (Oxford, 1899); W. de G. Birch, *Cartularium Saxonicum* (London, 1885-1893). Also a paper by Sir H. H. Howorth in *Numismatic Chronicle*, third series, vol. xx, pp. 66-87 (reprinted separately, London, 1900), where attention is called to the peculiar dating of several of Ecgbert's charters, and the view is put forward that he remained abroad considerably later than the date given by the Chronicle for his accession. On the other hand a charter in Birch, *Cart. Sax.*, purporting to date from 799, contains the curious statement that peace was made between Coenwulf and Ecgbert in that year.

ECGBERT, or **ECGBERT** (d. 766), archbishop of York, was made bishop of that see in 734 by Coelwulf, king of Northumbria, succeeding Wilfrid II. on the latter's resignation. The pall was sent him in 735 and he became the first northern archbishop after Paulinus. He was the brother of Eadberht, who ruled Northumbria 737-758. He was the recipient of the famous letter of Bede, dealing with the evils arising from spurious monasteries. Ecgbert himself wrote a *Dialogus Ecclesiasticæ Institutionis*, a *Penitentiale* and a *Pontifical*. He was a correspondent of St Boniface, who asks him to support his censure of Æthelald of Mercia.

See Bede, *Continuatio*, sub. ann. 732, 735, 766, and *Epistola ad Egbertum* (Plummer, Oxford, 1896); *Chronicle*, sub. ann. 734, 735, 738, 766 (Earle and Plummer, Oxford, 1899); Haddan and Stubbs, *Councils and Ecclesiastical Documents* (Oxford, 1869-1878), iii. 403-431; *Proceedings of Surtees Society* (Durham, 1853).

ECGRITH (d. 685), king of Northumbria, succeeded his father Oswio in 671. He was married to Æthelthryth, daughter of Anna of East Anglia, who, however, took the veil shortly after Ecgrith's accession, a step which possibly led to his long quarrel with Wilfrid archbishop of York. Ecgrith married a second wife, Eormenburg, before 678, the year in which he expelled Wilfrid from his kingdom. Early in his reign he defeated the Picts who had risen in revolt. Between 671 and 675 Ecgrith defeated Wulfhere of Mercia and seized Lindsey. In 679, however, he was defeated by Æthelred of Mercia, who had married his sister Osthryth, on the river Trent. Ecgrith's brother Ælfwine was killed in the battle, and the province of Lindsey was given up when peace was restored at the intervention of Theodore of Canterbury. In 684 Ecgrith sent an expedition to Ireland under his general Berht, which seems to have been unsuccessful. In 685, against the advice of Cuthbert, he led a force against the Picts under his cousin Burde, son of Bile, who was lured by a feigned flight into their mountain fastnesses, and slain at Nechtanesmere (now Dunnichen) in Forfarshire. Bede dates the beginning of the decline of Northumbria from his death. He was succeeded by his brother Aldfrith.

See Eddius, *Vita Wilfridi* (Raine, *Historians of Church of York*, Rolls, Series, London, 1878-1894), 19, 20, 24, 34, 39, 44; Bede, *Hist. Eccl.* (Plummer, Oxford, 1896), iii. 24, iv. 3, 12, 13, 18, 19, 21, 26.

EGONINE, in chemistry, $C_8H_{15}NO_3$, a cycloheptane derivative with a nitrogen bridge. It is obtained by hydrolysing cocaine with acids or alkalis, and crystallizes with one molecule of water, the crystals melting at 198° to 199° C. It is laevo-rotatory, and on warming with alkalis gives iso-ecgonine, which is dextro-rotatory. It is a tertiary base, and has also the properties of an acid and an alcohol. When boiled with caustic baryta it gives methylamine. It is the carboxylic acid corresponding to tropine, for it yields the same products on oxidation, and by treatment with phosphorus pentachloride is converted into anhydroecgonine, $C_8H_{13}NO_3$, which, when heated to 280° C. with hydrochloric acid, splits out carbon dioxide and yields tropidine, $C_8H_{13}N$. Anhydroecgonine melts at 235° C., and has an acid and a basic character. It is an unsaturated compound, and on oxidation with potassium permanganate gives succinic acid. It is apparently a tropidine monocarboxylic acid, for on exhaustive methylation it yields cycloheptatriene-1-3-5-carboxylic acid-7.

Sodium in amyl alcohol solution reduces it to hydroecgonidine $C_8H_{17}NO_3$, while moderate oxidation by potassium permanganate converts it into *norecgonine*. The presence of the heptamethylene ring in these compounds is shown by the production of suberone by the exhaustive methylation, &c., of hydroecgonidine ethyl ester (see **POLYMETHYLENES** and **TROPINE**). The above compounds may be represented as:

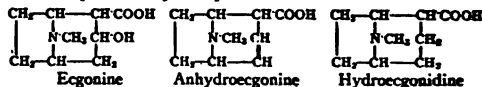

ECHEGARAY Y EIZAGUIRRE, JOSÉ (1833-), Spanish mathematician, statesman and dramatist, was born at Madrid in March 1833, and was educated at the grammar school of Murcia, whence he proceeded to the Escuela de Caminos at the capital. His exemplary diligence and unusual mathematical capacity were soon noticed. In 1853 he passed out at the head of the list of engineers, and, after a brief practical experience at Almería and Granada, was appointed professor of pure and applied mathematics in the school where he had lately been a pupil. His *Problemas de geometría analítica* (1865) and *Teorías modernas de la física unida de las fuerzas materiales* (1867) are said to be esteemed by competent judges. He became a member of the Society of Political Economy, helped to found *La Revista*, and took a prominent part in propagating Free Trade doctrines in the press and on the platform. He was clearly marked out for office, and when the popular movement of 1868 overthrew the monarchy, he resigned his post for a place in the revolutionary cabinet. Between 1867 and 1874 he acted as minister of education and of finance; upon the restoration of the Bourbon dynasty he withdrew from politics, and won a new reputation as a dramatist.

As early as 1867 he wrote *La Hija natural*, which was rejected, and remained unknown till 1877, when it appeared with the title of *Para tal culpa tal pena*. Another play, *La Última Noche*, also written in 1867, was produced in 1875; but in the latter year Echegary was already accepted as the successful author of *El Libro talonario*, played at the Teatro de Apolo on the 18th of February 1874, under the transparent pseudonym of Jorge Hayaseca. Later in the same year Echegary won a popular triumph with *La Esposa del vencedor*, in which the good and bad qualities—the clever stagecraft and unbridled extravagance—of his later work are clearly noticeable. From 1874 onwards he wrote, with varying success, a prodigious number of plays. Among the most favourable specimens of his talent may be mentioned *En el puño de la espada* (1875); *O locura o santidad* (1877), which has been translated into Swedish and Italian; *En el seno de la muerte* (1879), of which there exists an admirable German version by Fastenrath. *El gran Galeoto* (1881), perhaps the best of Echegary's plays in conception and execution, has been translated into several languages, and still holds the stage. The humorous proverb, *¿Piensa mal y acertadas?* exemplifies the author's limitations, but the attempt is interesting as an instance of ambitious versatility. His susceptibility to new ideas is illustrated in such pieces as *Mariano* (1892), *Mancha que limpia* (1895), *El Hijo de Don Juan* (1892), and *El Loco Dios* (1900): these indicate a close study of Ibsen, and *El Loco Dios* more especially might be taken for an unintentional parody of Ibsen's symbolism.

Echegary succeeded to the literary inheritance of López de Ayala and of Tamayo y Baus; and though he possesses neither the poetic imagination of the first nor the instinctive tact of the second, it is impossible to deny that he has reached a larger audience than either. Not merely in Spain, but in every land where Spanish is spoken, and in cities as remote from Madrid as Munich and Stockholm, he has met with an appreciation incomparably beyond that accorded to any other Spanish dramatist of recent years. But it would be more than usually rash to prophesy that this exceptional popularity will endure. There have been signs of a reaction in Spain itself, and Echegary's return to politics in 1905 was significant enough. He applies

his mathematics to the drama; no writer excels him in artful construction, in the arrangement of dramatic scenes, in mere theatrical technique, in the focusing of attention on his chief personages. These are valuable gifts in their way, and Echeagaray has, moreover, a powerful, gloomy imagination, which is momentarily impressive. In the drawing of character, in the invention of felicitous phrase, in the contrivance of verbal music, he is deficient. He alternates between the use of verse and prose; and his hesitancy in choosing a medium of expression is amply justified, for the writer's prose is not more distinguished than his verse. These serious shortcomings may explain the diminution of his vogue in Spain; they will certainly tell against him in the estimate of posterity.

(J. F. K.)

ÉCHELON (Fr. from *échelle*, ladder), in military tactics, a formation of troops in which each body of troops is retired on, but not behind, the flank of the next in front, the position of the whole thus resembling the steps of a staircase. To form échelon from line, the parts of the line move off, each direct to its front, in succession, so that when the formation is completed the rightmost body, for example, is farthest advanced, the one originally next on its left is to the left rear, a third is to the left rear of the second, and so on. The word is also used more loosely to express successive lines, irrespective of distances and relative positions, e.g. the "second échelon of ammunition supply," which is fully a day's march behind the first.

ECHIDNA, or PORCUPINE ANT-EATER (*Echidna aculeata*), one of the few species of Monotremata, the lowest subclass of Mammalia, forming the family Echidnidae. It is a native of Australia, where it chiefly abounds in New South Wales, inhabiting rocky and mountainous districts, where it burrows among the loose sand, or hides itself in crevices of rocks. In size and appearance it bears a considerable resemblance to the hedgehog, its upper surface being covered over with strong spines directed backwards, and on the back inwards, so as to cross each other on the middle line. The spines in the neighbourhood of the tail form a tuft sufficient to hide that almost rudimentary organ. The head is produced into a long tubular snout, covered with skin for the greater part of its length. The opening of the mouth is small, and from it the echidna puts forth its long slender tongue, lubricated with a viscous secretion, by means of which it seizes the ants and other insects on which it feeds. It has no teeth. Its legs are short and strong, and form, with its broad feet and large solid nails, powerful burrowing organs. In common with the other monotremes, the male echidna has its heel provided with a sharp hollow spur, connected with a secretory gland, and with muscles capable of pressing the secretion from the gland into the spur. It is a nocturnal or crepuscular animal, generally sleeping during the day, but showing considerable activity by night. When attacked it seeks to escape either by rolling itself into a ball, its erect spines proving a formidable barrier to its capture, or by burrowing into the sand, which its powerful limbs enable it to do with great celerity. "The only mode of carrying the creature," writes G. Bennett (*Gatherings of a Naturalist in Australasia*), "is by one of the hind legs; its powerful resistance and the sharpness of the spines will soon oblige the captor, attempting to seize it by any other part of the body, to relinquish his hold." In a younger stage of their development, however, the young are carried in a temporary abdominal pouch, to which they are transferred after hatching, and into which open the mammary glands. The echidnas are exceedingly restless in confinement, and constantly endeavour by burrowing to effect their escape. From the quantity of sand and mud always found in the alimentary canal of these animals, it is supposed that these ingredients must be necessary to the proper digestion of their insect food.

There are two varieties of this species, the Port Moresby echidna and the hairy echidna. The last-mentioned is found in south-eastern New Guinea, Australia and Tasmania. In all the spines are mixed with hair; in the Tasmanian race they are nearly hidden by the long harsh fur. Of the three-clawed echidnas (*Proechidna*) confined to New Guinea there are two species, Bruijn's echidna (*P. bruijnii*), discovered in 1877 in the

mountains on the north-east coast at an elevation of 3500 ft., and the black-spined echidna (*P. nigroaculeata*) of larger size—the type specimen measuring 31 in., as against 24 in.—with shorter claws.

ECHINODERMA.¹ The *ἐχινόδερμα*, or "urchin-skinned" animals, have long been a favourite subject of study with the collectors of sea-animals or of fossils, since the lime deposited in their skins forms hard tests or shells readily preserved in the cabinet. These were described during the 18th and first half of the 19th centuries by many eminent naturalists, such as J. T. Klein, J. H. Linck, C. Linnæus, N. G. Leske, J. S. Miller, L. v. Buch, E. Desor and L. Agassiz; but it was the researches of Johannes Müller (1840–1850) that formed the groundwork of scientific conceptions of the group, proving it one of the great phyla of the animal kingdom. The anatomists and embryologists of the next quarter of a century confirmed rather than expanded the views of Müller. Thus, about 1875, the distinction of Echinoderms from such radiate animals as jelly-fish and corals (see COLELTERA), by their possession of a body-cavity ("coelom") distinct from the gut, was fully realized; while their severance from the worms (especially Gephyrea), with which some Echinoderms were long confused, had been necessitated by the recognition in all of a radial symmetry, impressed on the original bilateral symmetry of the larva through the growth of a special division of the coelom, known as the "hydrocoel," and giving rise to a set of water-bearing canals—the water-vascular or ambulacral system. There was also sufficient comprehension of the differences between the main classes of Echinoderms—the sea-urchins or Echinoidea, the starfish or Asteroidea, the brittle-stars and their allies known as Ophuroidea, the worm-like Holothurians, the feather-stars and sea-lilies called Crinoidea, with their extinct relatives the sac-like Cystoidea, the bud-formed Blastoidea, and the flattened Ecdrioasteroidea—while within the larger of these classes, such as Echinoidea and Crinoidea, fair working classifications had been established. But the study that should elucidate the fundamental similarities or homologies between the several classes, and should suggest the relations of the Echinoderma to other phyla, had scarcely begun. Indeed, the time was not ripe for such discussions, still less for the tracing of lines of descent and their embodiment in a genealogical classification. Since then exploring expeditions have made known a host of new genera, often exhibiting unfamiliar types of structure.

Among these the abyssal starfish and holothurians described by W. P. Sladen and H. Théel respectively, in the Report of the "Challenger" Expedition, are most notable. The sea-urchins, ophiuroids and crinoids also have yielded many important novelties to A. Agassiz ("Challenger," "Blake," and "Albatross" Expeditions), T. Lyman ("Challenger"), Sladen ("Astrophora," *Ann. Mag. Nat. Hist.*, 1879), F. J. Bell (numerous papers in *Ann. Mag. Nat. Hist.* and in *Proc. Zool. Soc.*), E. Perrier ("Travailleur" and "Talisman," Cape Horn and Monaco Expeditions), P. H. Carpenter ("Challenger" Reports), and others. The anatomical researches of these authors, as well as those of S. Lovén ("On Pouteriasia" and "Echinologica," published by the Swedish Academy of Science), H. Ludwig (*Morphologische Studien*, Leipzig, 1877–1882), O. Hamann (*Histologie der Echinodermen*, Jena, 1883–1886), L. Cuenot ("Études morphologiques," *Arch. Biol.*, 1891, and papers therein referred to), P. M. Duncan ("Revision of the Echinoidea," *Journ. Linn. Soc.*, 1890), H. Prouho ("Sur Dorocidaris," *Arch. Zool. Exper.*, 1888), and many more, need only be mentioned to recall the great advance that has been made. In physiology may be instanced W. B. Carpenter's proof of the nervous nature of the chambered organ and axial cords of crinoids (*Proc. Roy. Soc.*, 1884), the researches of H. Durham (*Quart. Journ. Micr. Sci.*, 1891) and others into the wandering cells of the body-cavity, and the study of the deposition of the skeletal substance ("stereom") by Théel (in *Festschrift für Lilljeborg*, 1896). Knowledge of the development has been enormously extended by numerous embryologists, e.g. Ludwig (*op. cit.*), E. W. MacBride ("Asterina gibbosa," *Quart. Journ. Micr. Sci.*, 1896), H. Bury (*Quart. Journ. Micr. Sci.*, 1889, 1895), Seeliger (on "Antedon," *Zool. Jahrb.*, 1893), S. Goto ("Asterias pallida," *Journ. Coll. Sci. Japan*, 1896), C. Grave ("Ophiura," *Mem. Johns Hopkins*

¹ Sometimes called "Echinodermata," a Greek name meaning "sea-urchin-skins," which was invented by J. T. Klein (1734) to denote the tests of the Echini or sea-urchins; its later use for the animals themselves, or for the whole phylum, was an error in both history and etymology.

Univ., 1899). Théel ("Echinocyamus," *Nov. Act. Soc. Sci. Upsala*, 1892), R. Semon ("Synapta," *Jena. Zeitschr.*, 1888), and Lovén (*opp. cit.*); and though the theories based thereon may have been fantastic and contradictory, we are now near the time when the results can be co-ordinated and some agreement reached. But the scattered details of comparative anatomy are capable of manifold arrangement, while the palimpsest of individual development is not merely fragmentary, but often has the fragments misplaced. The morphologist may propose classifications, and the embryologist may erect genealogical trees, but all schemes which do not agree with the direct evidence of fossils must be abandoned; and it is this evidence, above all, that gained enormously in volume and in value during the last quarter of the 19th century. The Silurian crinoids and cystids of Sweden have been illustrated in N. P. Sibelius's *Iconographia Crinoideorum* (1878); the Palaeozoic crinoids and cystids of Bohemia are dealt with in J. Barrande's *Système silurien* (1887 and 1899); P. H. Carpenter published important papers on fossil crinoids in the *Journal of the Geological Society*, on Cystidea in that of the Linnean Society, 1891 and, together with R. Etheridge, jun., compiled the large *Catalogue of Blastoida in the British Museum*, 1886; O. Jaekel, in addition to valuable studies on crinoids and cystids appearing in the *Zeitschrift of the German Geological Society*, has published the first volume of *Die Stammesgeschichte der Felmatozoen* (Berlin, 1899), a richly suggestive work; the Mesozoic Echinoderms of France, Switzerland and Portugal have been made known by P. de Loriol, G. H. Cotteau, J. Lambert, V. Gauthier and others (see *Paléontologie française, Mém. Soc. paléontol. de la Suisse, Trabalhos Comm. Geol. Portugal*, &c.); a beautiful and interesting Devonian fauna from Bundenbach has been described by O. Follmann, Jaekel, and especially B. Stürtz (see *Verhandl. nat. Vereins preuss. Rheinlande, Paläont. Abhandl.*, and *Palaeontographica*); while the multitude of North American palaeozoic crinoids has been attacked by C. Wachsmuth and F. Springer in the *Proceedings* (1879, 1881, 1885, 1886), of the Philadelphia Academy and the *Memoirs* (1897) of the Harvard Museum.

The vast mass of material made known by these and many other distinguished writers has to be included in our classification, and that classification itself must be controlled by the story it reveals. Thus it is that a change, characteristic of modern systematic zoology, is affecting the subdivisions of the classes. It is not long since the main lines of division corresponded roughly to gaps in geological history: the orders were Palaeocrinoidea and Neocrinoidea, Palechinoidea and Euechinoidea, Palaeasteroidea and Euasteroidea, and so forth. Or divisions were based upon certain modifications of structure which, as we now see, affected assemblages of diverse affinity: thus both Blastoida and Euechinoidea were divided into Regularia and Irregularia; the Holothuroidea into Pneumophora and Apneumona; and Crinoids were discussed under the heads "stalked" and "unstalked." The barriers between these groups may be regarded as horizontal planes cutting across the branches of the ascending tree of life at levels determined chiefly by our ignorance; as knowledge increases, and as the conception of a genealogical classification gains acceptance, they are being replaced by vertical partitions which separate branch from branch. The changes may be appreciated by comparing the systematic synopses at the end of this article with the classification adopted in 1877 in the 6th edition of the *Ency. Brit.* (vol. vii.), or in any zoological text-book contemporary therewith. In the present stage of our knowledge these minor divisions are the really important ones. For, whereas to one brilliant suggestion of far-reaching homology another can always be opposed, by the detailed comparison of individual growth-stages in carefully selected series of fossils, and by the minute application to these of the principle that individual history repeats race history, it actually is possible to unfold lines of descent that do not admit of doubt. The gradual linking up of these will manifest the true genealogy of each class, and reconstruct its ancestral forms by proof instead of conjecture. The problem of the interrelations of the classes will thus be reduced to its simplest terms, and even questions as to the nature of the primitive Echinoderm and its affinity to the ancestors of other phyla may become more than exercises for the ingenuity of youth. Work has been and is being done by the laborious methods here alluded to, and though the diversity of opinion as to the broader groupings of classification is still restricted only by the number of writers, we can point to an ever-increasing body of assured knowledge on which all are agreed. Unfortunately such allusion to these disconnected certainties as alone might be introduced here, would be too brief

for comprehension, and we are forced to select a few of the broader hypotheses for a treatment that may seem dogmatic and prejudiced.

Calycinal Theory.—The theory which had most influence on the conceptions of Echinoderms in the two concluding decades of the 19th century was that of Lovén, elaborated by F. H. Carpenter, Sladen and others. This, which may be called the *calycinal theory*,

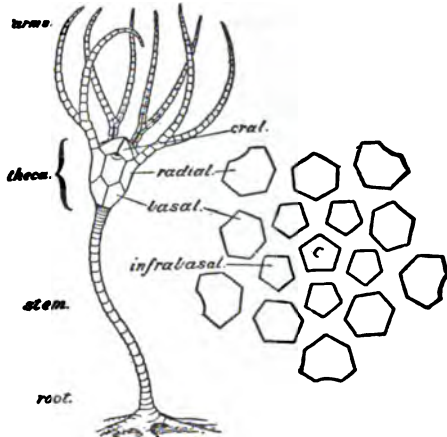

FIG. 1.—Diagram of a simple form of Crinoid, with five arms, each forking once; the one nearest the observer is removed to expose the tegmen of five orals. This crinoid has only two circlets of plates in the cup, but the cup analysed in the adjoining diagram has in addition infra-basals and a centrale C.

will be appreciated by comparing the structure of a simple crinoid with that of some other types. A crinoid reduced to its simplest elements consists of three principal portions—(i.) a theca or test enclosing the viscera; (ii.) five arms stretching upwards or outwards from the theca, sometimes single, sometimes branching; (iii.) a stem stretching downwards from the theca and attaching it to the sea-floor (see fig. 1). That part of the theca below the origins of the free arms is called the "dorsal cup"; the ventral part above the origins of the arms, serving as cover to the cup, is known as the "tegmen." All these parts are supported by plates or ossicles of crystalline carbonate of lime. The cup, in its simplest form, consists of two circlets of five plates. Each plate of the upper circlet supports an arm, and is called a "radial"; the plates of the lower circlet, the "basals," rest on the stem and alternate with those of the upper circlet, i.e. are interradial in position. Some crinoids have yet another circlet below these, the constituent plates of which are called "infra-basals," and are situated radially. The tegmen in most primitive forms, as well as in the embryonic stages of the living *Anidodon* (fig. 2), consists of five large triangular plates, alternating with the radials, and called "orals," because they roof over the mouth.

In addition to these three or four circlets of plates, two other elements were once supposed essential to the ideal crinoid: the dorso-central and the oro-central. The former term was applied to a flattened plate observed in the embryonic stage of a single genus (*Anidodon*) at that end of the stem attached to the sea-floor, and comparable to the foot of a wine-glass (fig. 2). In some crinoids which have no trace of a stem (e.g. *Marsupites*) a pentagonal plate is found at the bottom of the cup, where the stem would naturally have arisen ("centrale" in fig. 1); and since it was believed that the stem always grew by addition of ossicles immediately below the infra-basals, it was inferred that this pentagonal plate was the centro-dorsal in its primitive position, as though the wine-glass had been evolved from a tumbler by pulling the bottom out to form the foot. The oro-central was, it must be admitted, a theoretical conception due to a desire for symmetry, and was not confirmed by anything



FIG. 2.—An early stage in the development of *Anidodon*, showing the foot-plate or "dorso-central" fp at the end of the stem cal. Some of the thecal plates, infra-basals I.B., basals B, and orals O are forming around the body-cavities r.p.c. and l.p.c.; p is the water-pore. (After Seeliger.)

better than some erroneous observations on certain fossils, which were supposed to show a plate at the oral pole between the five orals; but this plate, so far as it exists at all, is now known to be nothing but an oral shifted in position. The theory was that all the plates just described, and more particularly those of the cup, which were termed "the calycinal system," could be traced, not merely in all crinoids, but in all Echinoderms, whether fixed forms such as cystids and blastoids, or free forms such as ophiuroids and echinoids, even—with the eye of faith—in holothurians. It was admitted that these elements might atrophy, or be displaced, or be otherwise obscured; but their complete and symmetrical disposition was regarded as typical and original. Thus the genera exhibiting it were regarded as primitive, and those orders and classes in which it was least obscured were supposed to approach most nearly the ancestral Echinoderm. Every one knows that an "apical system," composed of two circlets known as "genitals" or "basals" and "oculars" or "radials," occurs round the aboral pole of echinoids (fig. 3, A), and

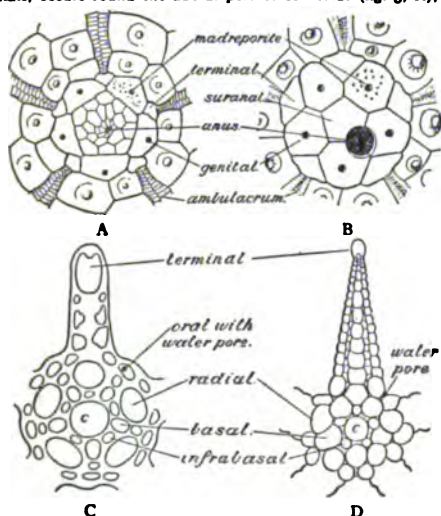

FIG. 3.—Supposed calycinal systems of free-moving Echinoderms. A, regular sea-urchin (*Cidaris*); B, sea-urchin with a suranal plate (*Salenia*); C, developing ophiurid (*Amphipura*); D, young starfish (*Zoroaster*).

that a few genera (e.g. *Salenia*, fig. 3, B) possess a sub-central plate (the "suranal"), which might be identified with the centro-dorsal. It is also the case that many asterids (fig. 3, D) and ophiuroids (fig. 3, C) have a similar arrangement of plates on the dorsal (i.e. aboral) surface of the disk. Accepting the homology of these apical systems with the calycinal system, the theory would regard the aboral pole of a sea-urchin or starfish as corresponding in everything, except its relations to the sea-floor, with the aboral pole of a fixed echinoderm.

The theory has been vigorously opposed, notably by Semon (*op. cit.*), who saw in the holothurians a nearer approach to the ancestral form than was furnished by any calcylate echinoderm, and by the Sarasins, who derived the echinoids from the holothurians through forms with flexible tests (*Echinothuridae*, which, however, are now known to be specialized in this respect). The support that appeared to be given to the theory by the presence of supposed calycinal plates in the embryo of echinoids and asteroids has been, in the opinion of many, undermined by E. W. MacBride (*op. cit.*), who has insisted that in the fixed stage of the developing starfish, *Asterina*, the relations of these plates to the stem are quite different from those which they bear in the developing and adult crinoid. But, however correct the observations and the homologies of MacBride may be, they do not, as Bury (*op. cit.*) has well pointed out, afford sufficient grounds for his inference that the abaxial (i.e. aboral) poles of starfish and crinoids are not comparable with one another, and that all conclusions based on the supposed homology of the dorso-central of echinoids and asteroids with that of crinoids are incorrect. Bury himself, however, has inflicted a severe blow on the theory by his proof that the so-called oculars of Echinoidea, which were supposed to represent the radials, are homologous with the "terminals" (i.e. the plates at the tips of the rays) in Asteroidea and Ophiuroidea, and therefore not homologous with the radially disposed plates often seen around the aboral pole of those animals. For, if these radial constituents of the supposed apical system in an ophiurid have really some other origin,

why can we not say the same of the supposed basals? Indeed, Bury is constrained to admit that the view of Semon and others may be correct, and that these so-called calycinal systems may not be heirlooms from a calcylate ancestor, but may have been independently developed in the various classes owing to the action of similar causes. That this view must be correct is urged by students of fossils. Palaeontology lends no support to the idea that the dorso-central is a primitive element; it exists in none of the early echinoids, and the suranal of *Saleniidae* arises from the minor plates around the anus. There is no reason to suppose that the central apical plate of certain free-swimming crinoids has any more to do with the distal foot-plate of the larval *Antedon* stem than has the so-called centro-dorsal of *Antedon* itself, which is nothing but the compressed proximal end of the stem. As for the supposed basals of Echinoidea, Asteroidea and Ophiuroidea, they are scarcely to be distinguished among the ten or more small plates that surround the anus of *Bothriocidaris*, which is the oldest and probably the most ancestral of fossil sea-urchins (fig. 5). A calycinal system may be quite apparent in the later Ophiuroidea and in a few Asteroidea, but there is no trace of it in the older Palaeozoic types, unless we are to transfer the appellation to the terminals. Those plates are perhaps constant throughout sea-urchins and starfish (though it would puzzle any one to detect them in certain Silurian echinoids), and they may be traced in some of the fixed echinoderms; but there is no proof that they represent the radials of a simple crinoid, and there are certainly many cystids in which no such plates existed. Lovén and M. Neumayr adduced the Triassic sea-urchin *Tiarechinus*, in which the apical system forms half of the test, as an argument for the origin of Echinoidea from an ancestor in which the apical system was of great importance; but a genus appearing so late in time, in an isolated sea, under conditions that dwarfed the other echinoid dwellers therein, cannot seriously be thought to elucidate the origin of pre-Silurian Echinoidea, and the recent discovery of an intermediate form suggests that we have here nothing but degenerate descendants of a well-known Palaeozoic family (*Lepidocentridae*). But to pursue the tale of isolated instances would be wearisome. The calycinal theory is not merely an assertion of certain homologies, a few of which might be disputed without affecting the rest; it governs our whole conception of the echinoderms, because it implies their descent from a calcylate ancestor—not a "crinoid-phantom," that bogey of the Sarasins, but a form with definite plates subject to a quinquedradial arrangement, with which its internal organs must likewise have been correlated. To this ingenious and plausible theory the revelations of the rocks are more and more believed to be opposed.

Pentactaea Theory.—In opposition to the calycinal theory has been the *Pentactaea* theory of R. Semon. There have always been many zoologists prepared to ascribe an ancestral character to the holothurians. The absence of an apical system of plates; the fact that radial symmetry has not affected the generative organs, as it has in all other recent classes; the well-developed muscles of the body-wall, supposed to be directly inherited from some worm-like ancestor; the presence on the inner walls of the body in the family *Synaptidae* of ciliated funnels, which have been rashly compared to the excretory organs (nephridia) of many worms; the outgrowth from the rectum in other genera of caeca (Cuvierian organs and respiratory trees), which recall the anal glands of the Gephyrean worms; the absence of podia (tube-feet) in many genera, and even of the radial water-vessels in *Synaptidae*; the absence of that peculiar structure known in other echinoderms by the names "axial organ" or "ovoid gland" &c.; the simpler form of the larva—all these features have, for good reason or bad, been regarded as primitive. Some of the more striking of these features are confined to *Synaptidae*; in that family too the absence of the radial water-vessels from the adult is correlated with continuity of the circular muscle-layer, while the gut runs almost straight from the anterior mouth to the posterior anus. Early in the life-history of *Synapta* occurs a stage with five tentacles around the mouth, and into these pass canals from the water-ring, the radial canals to the body-wall making a subsequent, and only temporary, appearance (fig. 4). Semon called this stage the *Pentactula*, and supposed that, in its early history, the class had passed through a similar stage, which he called the *Pentactaea*, and regarded as the ancestor of all Echinoderms. It has since been proved that the five tentacles with their canals are interradial, so that one can scarcely look on the *Pentactula* as a primitive stage, while the apparent simplicity of the *Synaptidae*, at least as compared with other holothurians, is now believed to be the result of regressive



FIG. 4.—The *Pentactula* stage in the development of *Synapta*.

T, The five interradial tentacles.
M, The water-pore, leading by the stone-canal *stc* to the water-ring, from which hangs a Polian vesicle *pb*.
oc, Supposed otocysts.
m, Longitudinal muscles.
sk, Calcareous spicules.
St, Stomach.
After Semon.)

It has since been proved that the five tentacles with their canals are interradial, so that one can scarcely look on the *Pentactula* as a primitive stage, while the apparent simplicity of the *Synaptidae*, at least as compared with other holothurians, is now believed to be the result of regressive

changes. The *Pentactaea*, at all events as it sprang from the brain of Semon, must pass to the limbo of mythological ancestors.

Pelmatozoic Theory.—The rejection of the calycinal and *Pentactaea* theories need not scatter our conceptions of Echinoderm structure back into the chaos from which they seemed to have emerged. The idea of a calyculate ancestor, though by no means connoting fixation, turned men's minds in the direction of the fixed forms, simply because in them the calyx was best developed. The *Pentactaea* again suggested a search for some primitive type in which quinquerradiata symmetry was exhibited in circumoral appendages, but had not affected the nervous, water-vascular, muscular or skeletal systems to any great extent, and the generative organs none at all. Study of the earliest larval stages has always led to the conclusion that the Echinoderms must have descended from some freely-moving form with a bilateral symmetry, and, connecting this with the ideas just mentioned, we reach the conception that this supposed bilateral ancestor (or *Dipleurula*) may have become fixed, and may have gradually acquired a radial symmetry in consequence of its sedentary mode of life. The different extent of quinquerradiata symmetry in the different classes would thus depend on the period at which they diverged from the sedentary stock. The tracing of this history, and the explanation of the general characters of Echinoderms and of the differentiating features of the classes in accordance therewith, constitutes the *Pelmatozoic theory*.

The word "Pelmatozoa" literally means "stalked animals," but the name is now used to denote all Cystidea, Blastoidea, Crinoidea and Edrioasteroidea, as opposed to the other classes, which may be called Eleutherozoa. Many Pelmatozoa have, it is true, no stalk, while some are freely-moving, but all agree in the possession of certain characters obviously connected with a fixed mode of life. Thus, the mouth is central and turned away from the sea-floor; the animal does not seize its food by tentacles, limbs or jaws, neither does it move in search of it, but a series of ciliated grooves which radiate from the mouth sweep along currents of water, in the eddies of which minute food-particles are caught up and carried down into the gut; the undigested food is driven out through an anus which is on the upper or oral side of the theca, but as far distant as practicable from the mouth and ciliated grooves. Such characters are found in any primitive, sedentary group. More peculiarly Echinoderm features, in which the Pelmatozoan nature is manifest, are the enclosing of the viscera in a calcified and plated theca, for protection against those enemies from which a fixed animal cannot flee; the development, at the aboral pole of this theca, of a motor nerve-centre giving off branches to the stroma connecting the various plates of the theca and of its brachial, anal, and columnar extensions, and thus coordinating the movements of the whole skeleton; the absence of suckers from the podia, which, when present, are respiratory, not locomotor, in function. There are other features of most, if not all, Pelmatozoa that appear to be due to a fixed existence; but those are also found in the Eleutherozoa. The Pelmatozoic theory thus regards the Pelmatozoa as the more ancestral forms, and the Pelmatozoan stage as one that must have been passed through by all Echinoderms during their evolution from the *Dipleurula*. It might be possible to prove the origin of all classes from Pelmatozoa, without thereby explaining the origin of such fundamental features as radial symmetry, the developmental metamorphosis, and the position that affects both gut and body-cavities, during that process; but the acceptance of a *Dipleurula* as the common ancestor necessitates an explanation of these features. Such an explanation is an integral part of the Pelmatozoic theory, but is provided by no other.

The evidence for the Pelmatozoic theory is supplied by palaeontology, embryology, the comparative anatomy of the classes, and a consideration of other phyla. Palaeontology, so far as it goes, is a sure guide, but some of the oldest fossiliferous rocks yield remains of distinctly differentiated crinoidea, asteroids and echinoids, so that the problem is not solved merely by collecting fossils. Two lines of argument appear fruitful. First, a comparison of the relative numbers of the representatives of the various classes at different epochs; according to this they may be placed in the following order, with the oldest first: Cystidea, Crinoidea, Blastoidea, Asteroidea, Ophiuroidea, Echinoidea. As for Holothuroidea, the fossil evidence allows us to say no more than that the class existed in early Carboniferous times, if not before. The second method is to work out by slow and sure steps the lines of descent of the different families, orders, and classes, and so either to arrive at the ancestral form of each class, or to plot out the curve of evolution, which may then legitimately be projected into "the dark backward and abysm of time." In this way the many highly modified orders of Cystidea may be traced back to a simple, many-plated ancestor with little or no radiate symmetry (see below). All the complicated structures of Blastoidea are evolved from a fairly simple type, which in its turn is linked on to one of the cystid orders. That the crinoidea are all deducible from some such simple form as that above described under the head "calycinal theory" is now generally admitted. Although, in the extreme correlation of the radial food-grooves, nerves, water-vessels, and so forth, with a radiate symmetry of the theca, such a type differs from the Cystidea, while in the possession of jointed processes from the radial plates, bearing the grooves and the various body-systems outwards from the theca, it differs from all other Echinoderms, nevertheless ancient forms are known which, if they

are not themselves the actual links, suggest how the crinoid type may have been evolved from some of the more regular cystida. The fourth class of Pelmatozoa—the Edrioasteroidea—differs from the others in the structure of its ambulacra. As in all Pelmatozoa these seem to have borne ciliated food-grooves protected by movable covering-plates (fig. 11). Beneath each food-groove was a radial water-vessel and probably a nerve and blood-vessel, all which structures passed either between certain regularly arranged thecal plates, or along a furrow floored by those plates, which were then in two alternating series. The important and distinctive feature is the presence of pores between the flooring-plates, on either side of the groove; and these, we cannot doubt, served for the passage of podia. Thus in a highly developed edrioasteroid, such as *Edrioaster* itself (fig. 11), there was a true ambulacrum, apparently constructed like that of a starfish, but differing in the possession of a ciliated food-groove protected by covering-plates. The simpler forms of Edrioasteroidea, with their more sac-like body and undifferentiated plates, may well have been derived from early Cystidea of yet simpler structure, and there seems no reason to follow Jaekel in regarding the class as itself the more primitive. Turning to fossil Asteroidea, we find the earlier ophiurids scarcely distinguishable from the asteroids, while in the alternation of the ambulacra, which undoubtedly correspond to the flooring-plates of *Edrioaster*, both groups approach the Pelmatozoan type. These facts have been expressed by Surtz in his names Encrinasteria and Ophio-encrinasteria. There is no difficulty in deducing the highly differentiated asteroids and ophiurids of a later day from these simpler types. The evolution of the modern Echinoderms from their Palaeozoic ancestors is also well understood, but in this case the ancestral form to which the palaeontologist is led does not at first sight present many resemblances to the Pelmatozoa. It is, however, characterized by simplicity of structure, and a short description of it will serve to clear the problem from unnecessary difficulties. *Bothriocidaris* (fig. 5), a small echinoid

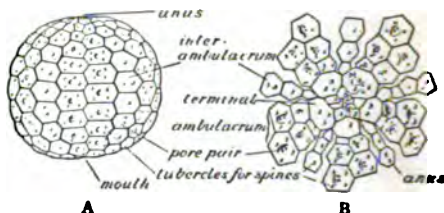

FIG. 5.—*Bothriocidaris globulus*. A, from the side; B, the plates around the aboral pole. (After Jaekel.) The short spines which were attached to the tubercles are not drawn.

from the Ordovician rocks of Estonia, is in essential structure just the form demanded by comparative palaeontology to make a starting-point. It is spheroidal, with the mouth and anus at opposite poles; there are five ambulacra, and the ambulacral plates are large, simple and alternating, each being pierced by two podial pores which lie in a small oval depression; the ambulacra next the mouth form a closed ring of ten plates; the interambulacra lie in single columns between the ambulacra, and are separated from the mouth-area by the proximal ambulacra just mentioned, and sometimes by the second set of ambulacra also; the ambulacra end in the five ocular or terminals, which meet in a ring around the anal area and have no podial pores, but one of them serves as a madreporite; within this ring is a star-shaped area filled with minute irregular plates, none of which can safely be selected as the homologues of the so-called basals or genitals of later forms; within the ring of ambulacra around the mouth are five somewhat pointed plates, which Jaekel regards as teeth, but which can scarcely be homologous with the interradially placed teeth of later echinoids, since they are radial in position; small spines are present, especially around the podial pores. The position of the pores near the centre of the ambulacra in *Bothriocidaris* need not be regarded as primitive, since other early Palaeozoic genera, not to mention the young of living forms, show that the podia originally passed out between the plates, and were only gradually surrounded by their substance; thus the original structure of the echinoid ambulacra differed from that of the early asteroid in the position of the radial vessels and nerves, which here lie beneath the plates instead of outside them. To this point we shall recur; palaeontology, though it suggests a clue, does not furnish an actual link either between Echinoidea and Asteroidea, or between those classes and Pelmatozoa.

The argument from embryology leads further back. First, as already mentioned, it outlines the general features of the *Dipleurula*; secondly, it indicates the way in which this free-moving form became fixed, and how its internal organs were modified in consequence; but when we seek, thirdly, for light on the relations of the classes, we find the features of the adult coming in so rapidly that such intermediate stages as may have existed are either squeezed out or profoundly modified. The difficulty of rearing the larvae in an

aquarium towards the close of the metamorphosis may account for the slight information available concerning the stages that immediately follow the embryonic. Another difficulty is due to the fact that the types studied, and especially the crinoid *Asterion*, are highly specialized, so that some of the embryonic features are not really primitive as regards the class, but only as regards each particular genus. Thus inferences from embryonic development need to be checked by palaeontology, and supplemented by comparison of the anatomy of other living genera.

Minute anatomical research has also aided to establish the Pelmatozoic theory by the gradual recognition in other classes of features formerly supposed to be confined to Pelmatozoa. Thus the elements of the Pelmatozoan ventral groove are now detected in so different a structure as the echinoid ambulacrum, while an aboral nervous system, the diminished representative of that in crinoids, has been traced in all Eleutherozoa except Holothurians. The broader theories of modern zoology might seem to have little bearing on the Echinoderma, for it is not long since the study of these animals was compared to a landlocked sea undisturbed by such storms as rage around the origin of the Vertebrata. This, however, is no more the case. The conception of the *Dipleurula* derives its chief weight from the fact that it is comparable to the early larval forms of other primitive coelomate animals, such as *Balanoglossus*, *Phoronis*, *Chaetognatha*, *Brachiopoda* and *Bryozoa*. So too the explanation of radial symmetry and torsion of organs as due to a Pelmatozoic mode of life finds confirmation in many other phyla. Instead of discussing all these questions separately, with the details necessary for an adequate presentation of the argument, we shall now sketch the history of the Echinoderms in accordance with the Pelmatozoic theory. Such a sketch must pass lightly over debatable ground, and must consist largely of suggestions still in need of confirmation; but if it serves as a frame into which more precise and more detailed statements may be fitted as they come to the ken of the reader, its object will be attained.

Evolution of the Echinoderms.—It is reasonable to suppose that the Coelomata—animals in which the body-cavity is divided into a gut passing from mouth to anus and a hollow (coelom) surrounding it—were derived from the simpler Coelentera, in which the primitive body-cavity (archenteron) is not so divided, and has only one aperture serving as both mouth and anus. We may, with Sedgwick, suppose the coelom to have originated by the enlargement and separation of pouches that pressed outwards from the archenteron into the thickened body-wall (such structures as the genital pouches of some Coelentera, not yet shut off from the rest of the cavity), and they would probably have been four in number and radially disposed about the central cavity. The evolution of this cavity into a gut is foreshadowed in some Coelentera by the elliptical shape of the aperture, and by the development at its ends of a ciliated channel along which food is swept; we have only to suppose the approximation of the sides of the ellipse and their eventual fusion, to complete the transformation of the radially symmetrical Coelenterate into a bilaterally symmetrical Coelomate with mouth and anus at opposite ends of the long axis. We further suppose that of the four coelomic pouches one was in front of the mouth, one behind the anus, and one on each side. Such an animal, if it ever existed, probably lived near the surface of the sea, and even here it may have changed its medusoid mode of locomotion for one in the direction of its mouth. Thus the bilateral symmetry would have been accentuated, and the organism shaped more definitely into three segments, namely (1) a preoral segment or lobe, containing the anterior coelomic cavity; (2) a middle segment, containing the gut, and the two middle coelomic cavities; (3) a posterior segment, containing the posterior coelomic cavity, which, however, owing to the backward prolongation of the anus, became divided into two—a right and left posterior coelom. Each of these cavities presumably excreted waste products to the exterior by a pore. There was probably a nervous area, with a tuft of cilia, at the anterior end; while, at all events in forms that remained pelagic, the ciliated nervous tracts of the rest of the body may be supposed to have become arranged in bands around the body-segments. Such a form as this is roughly represented to-day by the *Actinotrocha* larva of *Phoronis*, the importance of which has been brought out by Masterman. But only slight modifications are required to produce the *Tornaria* larva of the Enteropneusta and other larvae, including the special type that is inferred from the *Dipleurula* larval stages of recent forms to have characterized

the ancestor of the Echinoderms. We cannot enter here into all the details of comparison between these larval forms; amid much that is hypothetical a few homologies are widely accepted, and the preceding account will show the kind of relation that the Echinoderms bear to other animals, including what are now usually regarded as the ancestors of the Chordata (to which back-boned animals belong), as well as the nature of the evidence that their study has been, or may be, made to yield. How the hypothetical *Dipleurula* became an Echinoderm, and how the primitive Echinoderms diverged in structure so as to form the various classes, are questions to which an answer is attempted in the following paragraphs:—

Confining our attention to that form of *Dipleurula* (fig. 6) which, it is supposed, gave rise to the Echinoderms, we infer from embry-

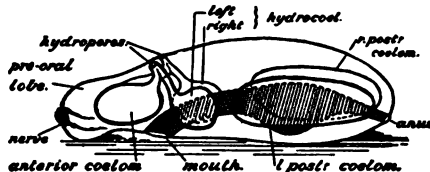

FIG. 6.—Diagrammatic reconstruction of *Dipleurula*. The creature is represented crawling on the sea-floor, but it may equally well have been a floating animal. The ciliated bands are not drawn.

logical data that its special features were as follow:—The anterior coelomic cavity was wholly or partially divided, and from each half a duct led to the exterior, opening at a pore near the middle line of the back. The middle cavities were smaller, and the ducts from them came to unite with those from the anterior cavities, and no longer opened directly to the exterior; whether these cavities were already specialized as water-sacs cannot be asserted, but they certainly had become so at a slightly later stage. The posterior cavities were the largest, but what had become of their original opening to the exterior is uncertain. The genital products were derived from the lining of the coelomic cavities, but it would not be safe to say that any particular region was as yet specialized for generation. The epithelium of the outer surface was probably ciliated, and a portion of it in the preoral lobe differentiated as a sense-organ, with longer cilia and underlying nerve-centre, from which two nerves ran back below the ventral surface. Into the space between the walls of the coelom and the outer body-wall, originally filled with jelly, definite cells now wandered, chiefly derived from the coelomic walls. Some of these cells produced muscles and connective tissue; others absorbed and removed waste products, iron salts, calcium carbonate and the like, and so were ready to be utilized for the deposition of pigment or of skeletal substance. In some of these respects the *Dipleurula* may have diverged from the ancestor of Enteropneusta and of other animals, but it could not as yet have been recognized as echinodermal by a zoologist, for it presented none of the structural peculiarities of the modern adult echinoderm.

Now ensued the great event that originated the phylum—the discovery of the sea-floor. This being apprehended by the sensory

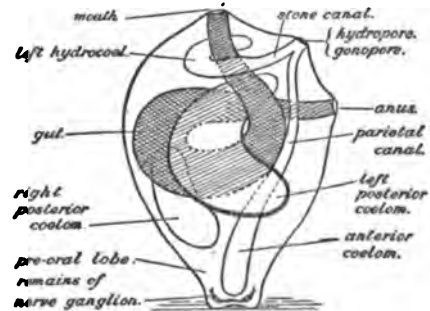

FIG. 7.—Diagrammatic reconstruction of primitive Pelmatozoön, seen from the side. The plates of the test are not drawn; their probable appearance may be gathered from fig. 8.

anterior end, it was by that end that the *Dipleurula* attached itself; not, however, by the pole, since that would have interfered at once with the sensory organ, but a little to one side, the right

side being the one chosen for a reason we cannot now fathom; it may be that fixation was facilitated by the presence of the pore on that side, and by the utilization of the excretion from it as a cement. The first result was that which is always seen to follow in such cases—the passage of the mouth towards the upper surface (fig. 7). As it passed up along the left side, the gut caught hold of the left water-sac and pulled it upwards, curving it in the process; this being attached to the left duct from the anterior body-cavity, this structure with its water-pore was also pulled up, and the pore came to lie between mouth and anus. The forward portion of the anterior coelom shared in the constriction and elongation of the preoral lobe; but its hinder portion was dragged up along with the water-pore and formed a canal lying along the outer wall (the parietal canal). As the gut coiled, it pressed inwards the middle of the left posterior coelom of the *Dipleurula*, and drew the whole towards the mouth, while the corresponding cavity on the right was pressed down by the stomach towards the fixed end of the animal and became involved in the elongation of that region. These changes, which may still be traced in the development of *Auleton*, resulted in the primitive Pelmatozoön (fig. 7), represented in the rocks by such a genus as *Aristocystis* (fig. 8). The



FIG. 8.—*Aristocystis bohemicus*; side-view of the theca. The internal structure may be gathered from fig. 7.

narrow end. On the broad upper surface are four openings, that nearest the centre being the mouth, which is slit-like, and that nearest the periphery being the anus. The two other openings are minute, and placed between those two; one close to the mouth is almost certainly the water-pore, while that nearer the anus is regarded as a genital aperture. Which of the coelomic cavities this last is connected with is uncertain, for there is considerable doubt as to the origin of the genital glands in the embryonic development of recent echinoderms. It seems clear, however, that there was but a single duct and a single bunch of reproductive cells, as in the holothurians, though perhaps bifurcate, as in some of those animals. The line between mouth and anus, along which these openings are situate, corresponds with the plane of union between the two horns of the curved left posterior coelom, the united walls of which form the "dorsal mesentery." Since this must have, on our theory, enclosed the parietal canal from the anterior coelom, it is possible that the genital products were developed from the lining cells of that cavity, and that the genital pore was nothing but its original pore not yet united with that from the water-sac. The concrescence of these pores can be traced in other cystids; but as the genital organs became affected by radial symmetry the original function of the duct was lost, and the reproductive elements escaped to the exterior in another way.



FIG. 9.—*Fungocystis varisima*, in which the thecal plates bordering the food-grooves are not yet regularly arranged. The brachioles are not drawn. much to stretch over the theca as to be raised away from it on relatively larger brachioles, arising close around the mouth (fig. 10).

These two types are, in the main, correlated with two gradual differentiations in the minute structure of the thecal plates. Originally the calcareous substance of the plates (stereom) was pierced by irregular canals, more or less vertical, and containing strands of the soft tissue (stroma) that deposited the stereom, as well as spaces filled with fluid. In the former group (fig. 9) these canals became connected in pairs (diplopores) still perpendicular to the surface, and this structure, combined with that of the grooves, characterizes the order—Diploporita. In the latter group (fig. 10) the canals, that is to say, the stroma-strands, came to lie parallel to the surface and to cross the sutures between the plates, which were thus more flexibly and more strongly united; since the canals

crossing each suture naturally occupy a rhombic area, the order is called Rhombifera. At first the grooves were three, one proceeding from each end of the mouth-slit, and the third in a direction opposed to the anus; with reference to the Pelmatozoan structure, the anal side may be termed posterior, and this groove anterior. Eventually each lateral groove forked, so that there were five grooves. These gradually impressed themselves on the theca and influenced the arrangement of the internal organs: it is fairly safe to assume that nerves, blood-vessels and branches from the water-sac stretched out along with these grooves, each system starting from a ring around the gullet. At last a quinquediate symmetry influenced the plates of the theca, partly through the development of a plate at the end of each groove (terminal), partly through plates at the aboral pole of the theca (basals and infrabasals) arising in response to mechanical pressure, but soon intimately connected with the cords of an aboral nervous system. Before the latter plates arose, the stem had developed by the elongation and constriction of the fixed end of the theca, the gradual regularization of the plates involved, and their coalescence into rings. The crinoid type was differentiated by the extension of the food-grooves and associated organs along radial outgrowths from the theca itself. These constituted the arms (brachia), and five definite radial plates of the theca were specialized for their support. These radials may be homologous with the terminals already mentioned, but this is neither necessary nor certain. In this development of brachial extensions of the theca the genital organs were involved, and their ripe products formed at the ends

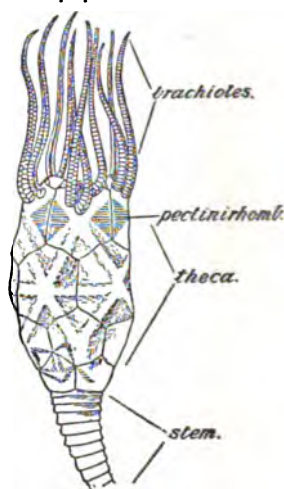

FIG. 10.—*Chirocrinus alter*, one of the Rhombifera, showing the reduced number and regular arrangement of the thecal plates, and the concentration of the brachioles. (Adapted from Jackel.)

no longer needed for the collection of food, closed over, and are still traceable as ciliated canals overlying the radial nerves. At the same time the thecal plates degenerated into spicules. The Edrioasteroidea followed a different line from that of the cystids above mentioned and their descendants. The theca became sessile, and in its later developments much flattened (fig. 11). Mouth, water-pore and anus remained as in *Aristocystis*, but the five ciliated grooves radiated from the mouth between the thecal plates rather than over them, and were, as usual, protected by covering-plates. The important feature was the extension of radial canals from the water-sac along these grooves, with branches passing between the flooring-plates of the grooves (fig. 12, A). The resemblance of the flooring-plates to the ambulacral ossicles of a starfish is so exact that one can explain it only by supposing similar relations of the water-canals and their branches (podia). On the thinly plated under surface of well-preserved specimens of *Edrioaster* are seen five interradial swellings (fig. 11, B). These are likely to have been produced by the ripe genital glands, which may have extruded their products directly through the membranous integument of the under side. No other way out for them is apparent, and it is clear that *Edrioaster* was not permanently and solidly fixed to the sea-floor.

Now comes a great change, unfortunately difficult to follow whether in the fossils or in the modern embryos. We suppose some such form as *Edrioaster*, which appears to have lived near the shore, to have been repeatedly overturned by waves. Those that were able to accommodate themselves to this topsy-turvy

existence, by taking food in directly through the mouth, survived, and their podia gradually specialized as sucking feet. Such a form as this, when once its covering-plates had atrophied, would be a

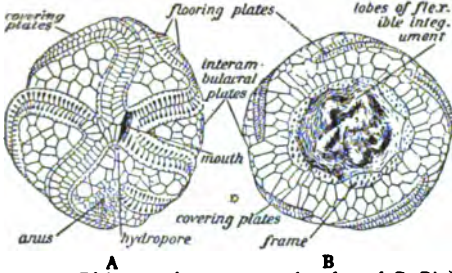

FIG. 11.—*Edrioaster*. A, upper or oral surface of *E. Bigsbyi*, with the covering-plates on the anterior and left posterior food-grooves, but removed from the others, which show only the flooring-plates, between which are pores; B, under surface of *E. Buchianus*, with covering-plates on right posterior and right anterior food-grooves (left hand in the drawing). The * denotes the position of the anal interradial.

starfish without more ado (fig. 12, B); but the sea-urchins present a more difficult problem, on which *Bothriocidaris* sheds no light. An Upper Silurian echinoid, however, *Palaeodiscus*, is believed by W. J. Sollas and W. K. Spencer to have had in its ambulacra an inner as well as an outer series of plates. If this be correct, the only change from *Edrioaster*, as regards the ambulacra, was that in *Palaeodiscus* the covering-plates could no longer open, but closed permanently over the whole groove, while the podia issued through slits between them. In more typical echinoids the covering-plates alone remained to form the ordinary ambulacral plates, while the flooring-plates disappeared, the canals and other organs remaining as before. In any case we have to admit a closure of the integument over the ciliated groove (fig. 12, D, e) just as in holothurians, since this is necessitated by anatomical evidence. The genital organs in both Asteroidea and Echinoidea would retain the interradial position they first assumed in *Edrioaster*; and in Echinoidea their primitive temporary openings to the exterior were converted into definite pores, correlated with five interradially placed plates at the aboral pole. The anus also naturally moved to this superior and

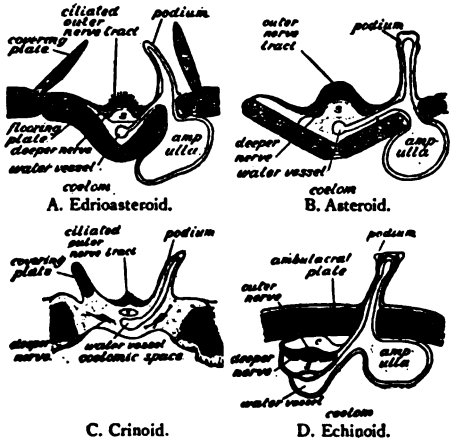

FIG. 12.—Diagrammatic sections across the ambulacra of A, C, PELMATOZOA, and B, D, ELEUTHEROZOA, placed in the same position for comparison. S, Blood-spaces, of which the homology is still uncertain.

aboral position. In the Echinoidea the water-canals and associated structures, ending in the terminal plates, stretched right up to these genital plates; but in the Asteroidea they never reached the aboral surface, so that the terminals have always been separated from the aboral pole by a number of plates.

Analysis of Echinoderm Characters.—Regarding the Echinoderms as a whole in the light of the foregoing account, we may

give the following analytic summary of the characters that distinguish them from other coelomate animals:—

They live in salt or brackish water: a primitive bilateral symmetry is still manifest in the right and left divisions of the coelom; the middle coelomic cavities are primitively transformed into two hydrocoele communicating with the exterior indirectly through a duct or ducts of the anterior coelom; stereom, composed of crystalline carbonate of lime, is, with few exceptions, deposited by special amoebocytes in the meshes of a mesodermal stroma, chiefly in the integument; reproductive cells are derived from the endothelium, apparently of the anterior coelom; total segmentation of the ovum produces a coeloblastula and gastrula by invagination; mesenchyme is formed in the segmentation cavity by migration of cells, chiefly from the hypoblast. Known Echinoderms show the following features, imagined to be due to an ancestral pelmatozoic stage:—Increase in the coelomic cavities of the left side, and atrophy of those on the right; the dextral coil of the gut, recognizable in all classes, though often obscured; an incomplete secondary bilateralism about the plane including the main axis and the water-pore or its successor, the madreporite, often obscured by one or other of various tertiary bilateralisms; the change of the hydrocoel into a circumoral, arcuate or ring canal; development through a free-swimming, bilaterally symmetrical, ciliated larva, of which in many cases only a portion is transformed into the adult Echinoderm (where care of the brood has secondarily arisen, this larva is not developed). All living, and most extinct, Echinoderms show the following features, almost certainly due to an ancestral pelmatozoic stage:—An incomplete radial symmetry, of which five is usually the dominant number, is superimposed on the secondary bilateralism, owing to the outgrowth from the mouth region of one unpaired and two paired ciliated grooves; these have a floor of nervous epithelium, and are accompanied by subjacent radial canals from the water-ring, giving off lateral podia and thus forming ambulacra, and by periaesmal system of canals apparently growing out from coelomic cavities. All living Echinoderms have a lacunar, haemal system of diverse origin; this, the ambulacral system, and the coelomic cavities, contain a fluid holding albumen in solution and carrying numerous amoebocytes, which are developed in special lymph-glands and are capable of wandering through all tissues. The Echinoderms may be divided into seven classes, whose probable relations are thus indicated:—

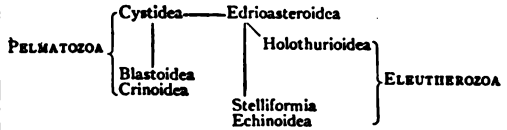

Brief systematic accounts of these classes follow:—
Grade A. PELMATOZOA.—Echinoderms with the viscera enclosed in a calcified and plated theca, of which the oral surface is uppermost, and which is usually attached, either temporarily or permanently, by the aboral surface. Food brought to the mouth by a subjective system of ciliated grooves, radiating from the mouth either between the plates of the theca (endothecal), or over the theca (epithecal), or along processes from the theca (exothecal: arms, pinnules, etc.), or, in part, and as a secondary development, below the theca (hypothecal). Anus usually in the upper or oral half of the theca, and never aboral. An aborally-placed motor nerve-centre gives off branches to the stroma connecting the various plates of the theca and of its brachial, anal and columnar extensions, and thus co-ordinates the movements of the whole skeleton. The circum-oesophageal water-ring communicates indirectly with the exterior; the podia, when present, are respiratory, not locomotor, in function.

Class I. CYSTIDEA.—Pelmatozoa in which radial polymeric symmetry of the theca is developed either not at all or in complete correlation with the radial symmetry of the ambulacra (such as obtains in Blastoida and Crinoidea); in which extensions of the food-grooves are exothecal or epithecal or both combined, but neither endothecal nor pierced by podia (as in some Edrioasteroidea). All Palaeozoic.

This class shows much greater diversity of organization than any other, and the classifications proposed by recent writers, such as E. Haeckel, O. Jaekel and F. A. Bather, start from such different points of view that no discussion of them can be attempted here. Following the narrative given above, we recognize a primitive group—Amphoridea—represented by *Aristocystis* (fig. 8). From this are derived the orders Diploporita (fig. 9) and Rhombifera (fig. 10) and the class Edrioasteroidea, all which have already been described as steps in the evolution of the phylum. But there were also side-branches leading nowhere, and therefore placed in separate orders—Aporita and Carpoidea.

Order 1. Amphoridea.—Radial symmetry has affected neither food-grooves nor thecal plates; nor, probably, nerves, ambulacral vessels, nor gonads. Canals or folds when present in the stereom are irregular. Families: Aristocystidae (fig. 8); Eocystidae.

Order 2. *Carpoides*.—Theca compressed in the oro-anal plane and a bilateral symmetry thus induced, affecting the food-grooves and, usually, the thecal plates and stem. Food-grooves in part epithelial and may be continued on one or two exothecal processes. No pores or folds in the stereom. Families: Anomalocystidae, Dendrocystidae. These correspond to Jaekel's *Carpoides* Heterostelea; he also includes, as *Eustelea*, our *Comarocystidae* and *Malocystidae*.

Order 3. *Rhombifera*.—Radial symmetry affects the food-grooves and, in the more advanced families, the thecal plates; probably also the nerves and ambulacral vessels, but not the gonads. The food-grooves are exothecal, i.e. are stretched out from the theca on jointed skeletal processes (brachioles). These either are close to the mouth or are removed from it upon a series of ambulacral or sub-ambulacral plates not derived immediately from thecal plates, or are separated from the oral centre by hypothecal passages passing beneath tegmental plates. The stereom and stroma become arranged in folds and strands at right angles to the sutures of the thecal plates; in higher forms the stereom-folds are in part specialized as pectini-rhombae. Families: Echinospiridae; Comarocystidae; Macrocyttellidae; Tiaracrinidae; Malocystidae; Glyptocystidae, with sub-fam. Echinocrininae, Callocystinae, Glyptocystinae, of which examples are *Chaeirocristus* (fig. 10) and *Cyrtoblastus* from which Jaekel deduces the blastoids; Caryocrinidae.

Order 4. *Aporia*.—Pentamerous symmetry affects the food-grooves and thecal plates; probably also the nerves and ambulacral vessels, but not the gonads. Food-grooves exothecal and circumoral. The stereom shows no trace of canals, folds, rhombs or diplopores. Family: Cryptocrinidae.

Order 5. *Diploporia*.—Radial symmetry affects the food-grooves, and by degrees the thecal plates connected therewith, but not the interradial thecal plates; probably also the nerves and ambulacral vessels, but not the gonads. The food-grooves are epithelial, i.e. are extended over the thecal plates themselves without intermediate flooring; they are also prolonged on exothecal brachioles, which line the epithelial grooves. The stereom of the thecal plates may be thrown into folds, but the mesostroma does not so much tend to lie in strands traversing the sutures, nor are pectini-rhombae or pore-rhombae developed; diplopores are always present in the mesostereom, but often restricted to definite tracts or plates, especially in higher forms. Families: Sphaerocrinidae; Glyptospiridae, e.g. *Fungocystis* (fig. 9); Proctocrinidae; Mesocystidae; Comphocystidae. The Proctocrinidae lead up to *Protoblastoids*, in which the theca is ovoid, sometimes prolonged into a stem, the plates differentiated into (a) smooth, regular, depressed interambulacral, (b) transversely elongate, brachioliiferous adambulacral, to which the diplopores, which lie at right angles to the main food-groove, are confined. This leads almost without a break to the Protoblastoidea.

Class II. BLASTOIDEA.—Pelmatozoa in which five (by atrophy four) epithelial ciliated grooves, lying on a lancet-shaped plate (? always), radiate from a central peristome between five interradial deltoid plates, and are edged by alternating side-plates bearing brachioles, to which side-branches pass from the grooves. Grooves and peristome protected by small plates, which can open over the grooves. The generative organs and coelom probably did not send extensions along the rays into the brachioles; but apparently nerves from the aboral centre, after passing through the thecal plates, met in a circumoral ring, from which branches passed into the plate under each main food-groove, and thence supplied the brachioles. The thecal plates, however irregular in some species, always show defined basals and a distinct plate ("radial") at the end of each ambulacrum; they are in all cases so far affected by pentamerous symmetry that their sutures never cross the ambulacra. All Paleozoic.

Division A. *Protoblastoidea*.—Blastoidea without inter-ambulacral groups of hydropore-folds hanging into the thecal cavity. Families: Astroblastidae, Blastoidocrinidae. The former might be placed with *Diploporia*, were it not for a greater intimacy of correlation between ambulacral and thecal structures than is found in *Cystidea* as here defined. They form a link between the Proctocrinidae and—

Division B. *Eublastoidea*.—Blastoidea in which the thecal plates have assumed a definite number and position in 3 circlets, as follows: 3 basals, 2 large and 1 small; 5 radials, often fork-shaped, forming a closed circlet; 5 deltoids, inter-radial in position, supported on the shoulders or processes of the radials, and often surrounding the peristome with their oral ends. The stereom of the radials and deltoids on each side of the ambulacra is thrown into folds, running across the radio-deltoid sutures, and hanging down into the thecal cavity as a Eublastoid, respiratory organs (hydropires).



FIG. 13.—A Eublastoid, respiratory organs (hydropires).

These are the forms to which the name Blastoidea is usually restricted. They have been divided into Regulars and Irregulars, but it seems possible to group them according to three series or lines of descent, thus:—

Series a. *Codonoblastida*.—Families: Docasteridae, Pentremitidae (fig. 13).

Series b. *Troostoblastida*.—Families: Troostocrinidae, Eleuthero-crinidae.

Series c. *Gronatoblastida*.—Families: Nucleocrinidae, Orbitremitidae, Pentephyllidae, Zygorcinidae.

Class III. CRINOIDEA.—Pelmatozoa in which epithelial extensions of the food-grooves, ambulacral, superficial oral nervous system, blood-vascular and water-vascular systems, coelom and genital system are continued exothecally upon jointed outgrowths of the abactinal thecal plates (*brachia*), carrying with them extensions of the abactinal nerve-system. The number of these processes is primitively and normally five, but may become less by atrophy. The brachia rise from a corresponding number of thecal plates, "radials (RR)." Below these is always a circlet, or traces of a circlet, of plates alternating with the radials, i.e. interradial, and called "basals (BB)." Through all modifications, which are numerous and vastly divergent, these elements persist. A circlet of radially situate infrabasals (IBB) may also be present. Below BB or IBB there follows a stem, which, however, may be atrophied or totally lost (see fig. 1).

The classification here adopted is that of F. A. Bather (1899), which departs from that of Wachsmuth and Springer mainly in the separation of forms with infrabasals or traces thereof from those in which basals only are present. These two series also differ from each other in the relations of the abactinal nerve-system. O. Jaekel (1894) has divided the crinoids into the orders Cladocrinoidea and Pentacrinoida, the former being the *Camerata* of Wachsmuth and Springer (*Monocyclica Camerata*, *Adunata* and *Dicyclica Camerata* of the present classification), and the latter comprising all the rest, in which the arms are either free or only loosely incorporated in the dorsal cup. In minor points there is fair agreement between the American, German and British authors. The families are extinct, except when the contrary is stated.

Sub-class I. *Monocyclica*.—Crinoidea in which the base consists of BB only, the aboral prolongations of the chambered organ being interradial; new columnals are introduced at the extreme proximal end of the stem.

Order 1. *Monocyclica Inadunata*.—*Monocyclica* in which the dorsal cup is confined to the patina and occasional intercalated anal; such ambulacral or interambulacral as enter the tegmen remain supra-tegmental and not rigidly united. Families: Hybocrinidae, Stephanocrinidae, Heterocrinidae, Calceocrinidae, Fusocrinidae, Zophocrinidae, Harpocrinidae, Alagecrinidae, Symbatocrinidae, Belomocrinidae, Plicatocrinidae, Hyocrinidae (recent), Saecocrinidae.

Order 2. *Adunata*.—*Monocyclica* with dorsal cup primitively confined to the patina and an occasional single anal; tegmen solid; portions of the proximal brachials and their ambulacral tend to be rigidly incorporated in the theca. Arms fork once to thrice, and bear pinnales on each or on every other brachial. BB fused to 3, 2 or 1. (*Euladocrinus* and *Acrocrinidae* offer peculiar exceptions to this diagnosis.) Families: Platycrinidae, Hexacrinidae, Acrocrinidae.

Order 3. *Monocyclica Camerata*.—*Monocyclica* in which the first, and often the succeeding, orders of brachials are incorporated by interbrachials in the dorsal cup, while the corresponding ambulacral are either incorporated in, or pressed below, the tegmen by inter-ambulacral; all thecal plates united by suture, somewhat loose in the earliest forms, but speedily becoming close, and producing a rigid theca; mouth and tegmental food-grooves closed; arms pinnaled.

Sub-order I. *Melocrinoidea*.—RR in contact all round; first brachial usually quadrangular. Families: Glyptocrinidae, Melocrinidae, Patellicrinidae, Clonocrinidae, Eucalyptocrinidae, Dolatocrinidae.

Sub-order ii. *Balocrinoidea*.—RR separated by a heptagonal anal; first brachial usually quadrangular. Families: Tanaocrinidae, Xenocrinidae, Carpoocrinidae, Barrandocrinidae, Coelocrinidae, Batocrinidae, Periechocrinidae.

Sub-order iii. *Actinocrinoidea*.—RR separated by a hexagonal anal; first brachial usually hexagonal. Families: Actinocrinidae, Amphorocrinidae.

Sub-class II. *Dicyclica*.—Crinoidea in which the base consists of BB and IBB, the latter being liable to atrophy or fusion with the proximal, but the aboral prolongations of the chambered organ are always radial; new columnals may or may not be introduced at the proximal end of the stem.

Order 1. *Dicyclica Inadunata*.—*Dicyclica* in which the dorsal cup primitively is confined to the patina and occasional intercalated anal, and no other plates ever occur between RR (Grade: Distincta); Br may be incorporated in the cup, with or without iBr, but never rigidly, and their corresponding ambulacral remain supra-tegmental (Grade: Articulata); new columnals are introduced at the extreme proximal end of the stem.

Sub-order I. *Cyathocrinoidea*.—Tegmen stout with conspicuous orals. Families: Carabocrinidae, Palaocrinidae, Eusprocrinidae, Sphaerocrinidae, Cyathocrinidae, Petalocrinidae, Crotalocrinidae, Codiacrinidae, Cupressocrinidae, Gastrocrinidae.

Sub-order ii. *Dendrocrinoidea*.—Tegmen thin, flexible, with inconspicuous orals. Families: Dendrocrinidae, Botryocrinidae, Lophocrinidae, Scaphocrinidae, Scytaalocrinidae, Graphocrinidae, Cromyocrinidae, Encrinidae (preceding families are *Distincta*; the rest *Articulata*), Pentacrinidae, including the recent *Isocrinus* (fig. 14), Uintacrinidae, Marsupitidae, Bathycrinidae (recent).

Order 2. *Flexibilia*.—Dicyclica in which proximal brachials are incorporated in the dorsal cup, either by their own sides, or by interbrachials, or by a finely plated skin, but never rigidly; plates may occur between RR. Tegmen flexible, with distinct ambulacra and numerous small interambulacra; mouth and food-grooves remain supra-teminal and open. Top columnal a persistent proximale, often fusing with IBB, which are frequently atrophied in the adult.

All the Palaeozoic representatives have non-pinnulate arms, while the Mesozoic and later forms have them pinnulate. There are other points of difference, so that it is not certain whether the latter really descended from the former. But assuming such a relationship we arrange them in two grades.

Grade a. *Impinnata*.—Families: Ichthyocrinidae, Sagenocrinidae, and Taxocrinidae, perhaps capable of further division.

Grade b. *Pinnata*.—Families: Apocrinidae with the recent *Calamocrinus*, Bourguetocrinidae with recent *Rhizocrinus*, Antedonidae, Atelecrinidae, Actinometridae, Thaumatoocrinidae (these four recent families include free-moving forms with atrophied stem, probably derived from different ancestors), Eugeniocrinidae, Holopodiidae (recent), Eudesiocrinidae.

Order 3. *Dicyclica Cameraata*.—Dicyclica in which the first, and usually the second, orders of brachials are incorporated in the dorsal cup by interbrachials, at first loosely, but afterwards by close suture. IBB always the primitive 5. An anal plate always rests on the posterior basal; mouth and tegmental food-grooves closed; arms pinnulate. Families:

Reteocrinidae, Dimero-crinidae, Lampterocrinidae, Rhodocrinidae, Cleiocrinidae.

Class IV. EDRIOASTEROIDEA.—PELMATOZOA

in which the theca is composed of an indefinite number of irregular plates, some of which are variously differentiated in different genera; with no subvective skeletal appendages, but with central mouth, from which there radiate through the theca five unbranched ambulacra, composed of a double series of alternating plates (covering-plates), sometimes supported by an outer series of larger alternating plates (side-plates or flooring-plates). In some forms at least, pores between (not through) the ambulacral elements, or between them and the thecal plates, seem to have permitted the passage of extensions from the periradial water-vessels. Anus in posterior interradial, on oral surface, closed by valvular pyramid. Hydropore (usually, if not always, present) between mouth and anus. Families: Agelacriniidae, Cyathocystidae, Edrioasteridae, Steganoblastidae. All Palaeozoic. The structure and importance of *Edrioaster* have been discussed above (figs. 11, 12).

FIG. 14.—A living Pentacrinid, *Isocrinus asteria*; the first specimen found, after Guettard's figure published in 1761.

Grade B. ELEUTHEROZOA.—Echinoderma in which the theca, which may be but slightly or not at all calcified, is not attached by any portion of its surface, but is usually placed with the oral surface downwards or in the direction of forward locomotion. Food is not conveyed by a subvective system of ciliated grooves, but is taken in directly by the mouth. The anus when present is typically aboral, and approaches the mouth only in a few specialized forms. The aboral nervous system, if indeed it be present at all, is very slightly developed. The circumoesophageal water-ring may lose its connexion with the exterior medium; the podia (absent only in some exceptional forms) may be locomotor, respiratory or sensory in function, but usually are locomotor tube-feet.

The classes of the Eleutherozoa probably arose independently from different branches of the Pelmatozoan stem. The precise relation is not clear, but the order in which they are here placed is believed to be from the more primitive to the more specialized.

Class I. HOLOTHURIODEA.—Eleutherozoa normally elongate along

the oro-anal axis, which axis and the dorsal hydropore lie in the sagittal plane of a secondary bilateral symmetry. The calcareous skeleton, which may be entirely absent, is usually in the form of minute spicules, sometimes of small irregular plates with no trace of a calycinal or apical system; to these is added a ring of pieces radiately arranged round the oesophagus. Ambulacral appendages take the form of: (1) circumoral tentacles, (2) sucking-feet, (3) papillae; of these (1) alone is always present. The gonads are not radiately disposed.

The comparative anatomy of living forms, combined with the evolutionary hypothesis sketched above, suggests that the early holothurians possessed the following characters: subvective grooves entirely closed; 5 radial canals, proceeding from the water-ring, gave off branches furnished with ampullae to the podia on each side of them, the 10 anterior podia being changed into cylindrical tentacles; the transverse muscles of the body-wall formed a circular layer, probably interrupted at the radii (though Ludwig believes the contrary); longitudinal muscles as paired radial bands, without those special retractors for withdrawing the anterior part of the body which occur in many recent forms; a hydropore connected with the water-ring by a canal in the dorsal mesentery; a gonopore behind the hydropore connected by a single duct with a bunch of genital pouches on each side of the mesentery; gut dextrally coiled, with a simple blood-vascular system, and with an enlargement at the anus for respiration, this eventually producing branched caeca called "respiratory trees"; skeleton reduced to a ring of 5 radial and 5 interradial plates round the gullet, and small plates, with a hexagonally meshed network, dispersed through the integument. Such a form gave rise to descendants differing *inter se* as regards the suppression of the radial canals and of the podia, the form of the tentacles, and the development of respiratory trees. These anatomical facts are represented in the following classification by H. Ludwig:—

Order 1. *Actinopoda*.—Radial canals supplying tentacles and podia.

A. With respiratory trees.

- (a) With podia . . . Fam. 1, Holothuriidae.
- (b) Without podia . . . Fam. 4, Cucumariidae.
- Fam. 5, Molpadiidae.

B. Without respiratory trees.

- (a) With podia . . . Fam. 2, Elpidiidae.
 - (b) Without podia . . . Fam. 3, Pelagothuriidae.
- radial canals nor podia.
Fam. Synaptidae.

Order 2. *Paractinopoda*.—Neither Tentacles supplied from circular canal. It is admitted, however, that this scheme does not represent the probable descent or relationship of the views of Ludwig himself, of H. Ostergren, and especially of R. Perrier, suggests the following as a more natural if less obvious arrangement.

Order 1. *Aspidochirota*.—Tentacles more or less peltate; calcareous ring when present simple and radially symmetrical; no retractors; stone-canal often opens to exterior; genital tubes sometimes restricted to left side in consequence of altered position of gut (Fig. 15.) Families: Elpidiidae (deep-sea forms, with sub-famm. Synallactinae, Deimatinae, Elpidiinae, Psychropotinae), Holothuriidae (shallow water), Pelagothuriidae (pelagic).

Order 2. *Dendrochirota*.—Tentacles simple or branched, never peltate; calcareous ring well developed, often bilaterally symmetrical; retractor muscles usually present; stone-canal opens internally; genital tubes in right and left tufts.

Sub-order i. *Apoda*.—No tube-feet or papillae, but tentacular ampullae more or less developed. Mostly burrowers. Families: Synaptidae (sub-famm. Synaptinae, Chirodotinae, Myriotrochinae), Molpadiidae.

Sub-order ii. *Eupoda*.—Tube-feet present, but tentacular ampullae rudimentary or absent. Families: Cucumariidae (climbers and crawlers), Rhopalodiniidae (burrowers).

Class II. STELLIFORMIA (=ASTEROIDEA *sensu lato*).—Eleutherozoa with a depressed stellate body composed of a central disk, whence radiate five or more rays; this radiate symmetry affects all the systems of organs, including the genital. The radial water-vessels lie in grooves on the ventral side of flooring-plates (usually called "ambulacra"); they and their podia are limited to the oral surface of the body and their extremities are separated from the



FIG. 15.—An Aspidochirote Holothurian of the family Holothuriidae, showing the mouth surrounded by tentacles, the anus at the other end of the body, and three of the rows of podia.

apical plates by a stretch of dorsal integument containing skeletal elements; the opening of the water-vascular system (madreporite) is not connected with a definite apical plate or system of plates.

The starfish, brittle-stars and their allies (see STARFISH) have for the last fifty years usually been divided into two classes—Asteroida and Ophiuroidea, each equivalent to the Holothurioida or Echinoidea. Recently, however, some authors, e.g. Gregory, have attempted to show that these classes cannot be distinguished. It is true that some specialized forms, such as the *Brisingiada* among starfish, *Astrophisura* and *Ophioteris* among ophiurans, contravene the usual diagnoses; but this neither obscures their systematic position, nor does it alter the fact that since early Palaeozoic times these two great groups of stellate echinoderms have evolved along separate lines. If then we place these groups in a single class, it is not on account of a few anomalous genera, but because the characters set forth above sharply distinguish them from all other echinoderms, and because we have good reason to believe that the ophiurans did not arise independently but have descended from primitive starfish. For that class Bell's name *Stelliformia* is selected since it avoids both confusion and barbarism.

Subclass I. Asteroidea.—Stelliformia in which the ambulacral groove always remains open and the podia serve as tube-feet (fig. 12, B); the rays as a rule pass gradually into the disk, and contain both genital glands and caecal extensions of the digestive system; an anus usually present; respiration is by tubular extensions from the body-cavity (papulae); skeletal appendages, in addition to small spines, are either small grasping organs (pedicellariae), or clumped spines (paxillae), or branched spines bearing a membrane.

No existing classification of the Asteroidea is satisfactory even for the recent forms, still less when the older fossils are considered. A separation of the latter as Palasterida, because of their alternating ambulacra, from the recent Euausterida with opposite ambulacra, is now discarded and an attempt made to arrange the Palasterida in divisions originally established for Euausterida. Those divisions fall under three schemes. C. Vigier has divided the starfish into: *Astries ambulacrales*, with plates of ambulacral origin prominent in the mouth-skeleton, pedicellariae stalked, and straight or crossed, podial pores usually quadriserial; *Astries adambulacrales*, with adambulacra prominent in the mouth-skeleton, pedicellariae sessile, and forcipiform or valvular, podial pores usually biserial. Perrier, at first laying greater stress on the nature of the pedicellariae and afterwards on the form of the mouth-skeleton, has gradually perfected a scheme of five orders: (1) *Forcipulata*, with pedicellariae stalked, and straight or crossed; (2) *Spinulosa*, with pedicellariae sessile and forcipiform; (3) *Velata*, with membraniferous spines; (4) *Paxillosa*, pedicellariae represented by an ossicle of the test and the spines covering it, the whole forming a paxilla; (5) *Valvata* or *Granulosa*, with pedicellariae sessile and valvular or salt-crystal shaped. A more widely accepted scheme is that of W. P. Sladen, who divided the Euausterida into two orders: (1) *Phanerozoonia*, with marginals large and highly developed, the supero-marginals and infero-marginals contiguous, with papulae confined to the dorsal surface, with ambulacra well spaced and usually broad, adambulacra prominent in the mouth-skeleton, with pedicellariae sessile; (2) *Cryptozonia*, with marginals inconspicuous and somewhat atrophied in the adult, the supero-marginals separated from the infero-marginals by intercalated plates, with papulae distributed over the whole body, with ambulacra crowded and narrow, either ambulacra or adambulacra prominent in the mouth-skeleton, with pedicellariae stalked or sessile.

We give here a list of the families separated into Sladen's orders and grouped under Perrier's divisions, extinct families being marked †.

1. *Phanerozoonia*.—Unclassed Fam., † Palaeasteridae, † Palaeasterinidae, † Taenasteridae, † Aspidozomatidae. *Paxillosa*,

Luidiidae, Astropectinidae (fig. 16), Archasteridae restr. Verrill, Porcellanasteridae, Chaetasteridae. *Valvata*, Benthoptectinidae, Gonioplectinidae, Plutonasteridae, Odontasteridae, Pentagonasteridae, Antheneidae, Pentacerotidae, Gymnasteridae. *Spinulosa*, Poranidae, Asterinidae.

2. *Cryptozonia*.—Unclassed Fam., † Sturtzasteridae (= Palaeocomidae Greg.), † Lepidasteridae, † Tropidasteridae. *Valvata*, Linckidae restr. Perr. *Spinulosa*, Echinasteridae, Scelerasteridae (fig. 17), Korethrastridae. *Velata*, † Palasteridae, Pterasteridae, Pythonasteridae, Myxasteridae. *Forcipulata*, Stich-

asteridae, Zoroasteridae (fig. 3, D), Heliasteridae, Pedicellasteridae, Asteridae, Brisingidae.

Subclass II. Ophiuroidea.—Stelliformia in which the ambulacral groove, though open in the oldest forms, soon becomes closed, while the podia cease to serve as tube-feet; the rays as a rule spring



FIG. 17.—A Cryptozoan Asterid, *Solaster papposus*, from the upper or dorsal surface.

abruptly from the disk and contain neither genital glands nor digestive caeca; no anus; respiration may be through clefts at the bases of the rays, but not by papulae; skeletal appendages confined to spines, usually of simple structure.

There is as yet no satisfactory classification of the Ophiuroidea into orders expressing lines of descent; even as regards families, leading writers are at variance. The following scheme is based on the attempts of E. Haeckel, F. J. Bell, J. W. Gregory, B. Stürtz, J. O. E. Perrier, and A. E. Verrill. Extinct families marked †.

Grade A. *Palophisurae*.—Ambulacra not yet forming complete vertebrae; plates of disk not yet specialized into mouth, radial or genital shields.

Stage a. *Allostichia* (= Lysophiuridae).—Ambulacra alternating and unfused, groove uncovered by ventral arm-plates. Families:

† Protasteridae, † Protophiuridae.

Stage b. *Zygotichia*.—Ambulacra opposite and, except in Ophiuridae, fused; ventral arm-plates developed in some. Families: † Ophiuridae, † Lapworthiidae, † Furcasteridae, † Palastropectinidae, † Eoluididae, † Palaeophiomyxidae.

Grade B. *Colophiuridae*.—Ambulacral pairs fused to form vertebrae with definite articular surfaces; mouth, radial and genital shields developed, though not all need be present in any one form.

Order 1. *Strophophiuridae*.—Rays simple and capable of coiling, since the vertebrae articulate by a ball-and-socket joint; arm-plates incompletely developed. Families: † Onychasteridae, Ophiohelidae, Ophiocolleidae, Ophiomyxidae, Hemieuryalidae, Astrophiuridae; unclassified genera, e.g. *Ophioteris*, *Ophiosciasma*, *Ophiogeron*.

Order 2. *Zygophiuridae*.—Rays simple and prevented from coiling by processes on the vertebral joints (fig. 18); dorsal, ventral and lateral arm-plates present.

Suborder i. *Brachyophiuridae*.—Spines short, simple, pointing towards the end of the arm. Families: Pectinuridae (= Ophiodermatidae), Ophioplepididae.

Suborder ii. *Nectophiuridae*.—Spines may be variously elaborated and are set more at right angles to the arm-axia. Families: Amphiuridae, Ophiacanthidae, Ophiocomidae, Ophiothrichidae.

Order 3. *Cladophiuridae* (= Euryalae). Rays simple or branched, capable of coiling, since the vertebrae articulate by surfaces of hour-glass shape; ventral arm-plates, and often the others, much reduced; spines reduced or absent. Families: Euryalidae, Gorgonocephalidae, Astrochelidae, Astrochemidae, Astronychiidae.

The Silurian genera *Eucaldis* and *Euktemon* have the rays greatly reduced and merged in the disk, so that the ambulacra are unseen. There are a few large dorsal, lateral and ventral arm-plates, and at the angles of the latter emerge huge podia with a granular or plated skin. There are five prominent mouth-shields and a separate madreporite on the ventral surface. These genera attained the Colophiuran grade in respect of external plating, but it is unlikely



FIG. 16.—Section across the arm-skeleton of a Phanerozoan Asterid, *Astropecten*. a, Ambulacral plates. b, Adambulacral plates. c and d, Inferior and superior lateral plates. e, Dorsal plates with paxillae. Certain supra-ambulacral plates, which also exist, are not shown.

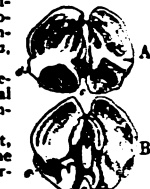

FIG. 18.—A vertebral arm-ossicle (fused ambulacra) of a Zygophiuran, *Ophioplectes*. A, Proximal joint-face. B, Distal joint-face. c, Ventral groove, where lies the water-vessel, from which branches pass through the ossicle, emerging as podia at e and e'.

that they or their ancestors had acquired even the Streptophiuran type of vertebra. Sollas has separated them as an order *Ophiocistia*.

Class III. ECHINOIDEA.—Eleutherozoa with a test of roughly circular, subpentagonal or elliptical outline, spheroidal, domed or flattened, of primary pentameric symmetry affecting all systems of organs except the gut. The radial water-vessels lie within the test through which their podia pass (fig. 12, D); the ambulacra thus formed are continuous from the peristome to the apical system of plates; the hypopore is connected with a definite plate of that system, and thus marks a secondary bilateral symmetry. An anus is present either within the apical system (endocyclic, fig. 3, A and B), or outside it in an interradial (exocyclic, fig. 19, 7), thus initiating yet another bilateral symmetry. Skeletal appendages are spines (radioles), pedicellariae, and, in some forms, minute sense-organs called sphaeridia.

The echinoids or sea-urchins (see SEA-URCHIN) may be grouped under the following orders, here named in the sequence of their appearance in the rocks.

Order 1. Bothriocidaroida.—Ambulacra simple, each with two pores vertically superposed, 2 columns to each ambulacrum; interambulacra multituberculate, in 1 column, none passing on to or resorbed by the peristome; mouth central, jaws unknown, no external gills or sphaeridia; anus aboral, endocyclic. Sole genus *Bothriocidaris* (fig. 3), Ordovician.

Order 2. Melonitoida.—Ambulacra simple, each with two pores horizontally juxtaposed, in 2 to 18 columns; interambulacra granulate with occasional tubercles, in 3 to 11 columns, not more than one row passing on to the peristome; mouth central, with jaws, no external gills or sphaeridia; anus aboral, endocyclic. Families: Palaechinidae (fig. 19, 1), Melonitidae and Lepidesthidae, Silurian to Carboniferous.

Order 3. Cystocidaroida.—Ambulacra simple, each with one or two pores, which sometimes pass between rather than through the plates, in 2 columns; interambulacra, uni- or multi-tuberculate, in numerous (say 10 or more) columns, none passing on to peristome; mouth central with jaws, no external gills or sphaeridia; position of anus doubtful, acyclic, i.e. no apical system so far as known. Include only *Echinocystis*, *Palaeodiscus* and (?) *Myriastiches*, all Upper Silurian.

Order 4. Cidaroida.—Ambulacra simple, each with two pores horizontally juxtaposed, in 2 columns; interambulacra unituberculate, in 2 to 11 columns, may pass on to the peristome; anus aboral, endocyclic. Families: Lepidocentridae and Archaeocidaridae (fig. 19, 2), Devonian and Carboniferous; Cidaridae (fig. 19, 3, 4), Permian to present; Diplocidaridae and Tiarachinidae, Mesozoic.

Order 5. Diademoida.—Ambulacra generally compound, with two pores obliquely juxtaposed, in 2 columns as in all subsequent orders; interambulacra usually with large radioles surrounded by smaller ones, as in Cidaroida, in 2 columns as in all subsequent orders, only one plate resorbed; mouth central, with jaws and external gills, sphaeridia present; anus aboral endocyclic. J. W. Gregory divides this into four suborders, each representing a distinct evolutionary series; i. *Calycina*, Saleniidae (fig. 19, 5) and Archaeoleniidae; ii. *Arbacia*, Hemicerididae and Arbaciidae; iii. *Diadema*, Orthopsidae, Diademataidae, Diploporidae, Pedinidae,

gills and sphaeridia; anus exocyclic. Families: Pygasteridae, Discoidiidae, Galeritidae, Concolypidae; Jurassic to Recent.

Order 7. Spatanoida.—Ambulacra simple, with two pores juxtaposed, dorsal podia respiratory; interambulacra bearing numerous small spines, none resorbed; mouth central or shifted forwards, with no jaws or external gills, sphaeridia numerous; anus exocyclic. As the mouth moves forward and the anus downward, the posterior interambulacra between them are enlarged and strengthened so as to form a sternum. The order may therefore be divided into: (i.) *Asterata*, Famm. Echinonidae, Nucleolitidae and Cassidulidae (fig. 19, 8); (ii.) *Sternata*, Famm. Collyritidae (fig. 19, 6), Echinocorytidae, Spatangidae (fig. 19, 7), Palaeostomidae, and Pourtalesidae; Jurassic to Recent.

Order 8. Clypeastroida.—Ambulacra simple or compound, with two pores juxtaposed, dorsal podia respiratory; interambulacra multi-tuberculate, none resorbed; mouth central with flattened unequal jaws, reduced external gills, and few sphaeridia; anus exocyclic. Families: Fibulariidae, Laganidae, Scutellidae, Clypeastroidae; Cretaceous to Recent.

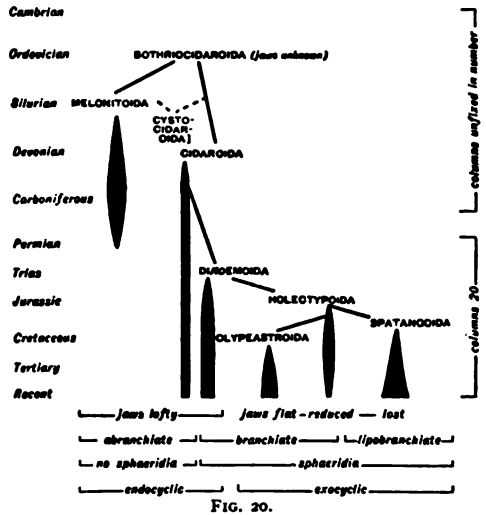

FIG. 20.

The probable relationship of these orders is shown in the annexed table. Here the *Cystocidaroida* occupy an isolated position. It is, however, quite possible that *Echinocystis* may some day be referred to the *Cidaroida*, and *Palaeodiscus* to the *Melonitoida*. This would leave the Echinoid scheme remarkably simple, with the *Melonitoida* and *Cidaroida* as divergent branches from an ancestor like *Bothriocidaris*; but while the former branch soon decayed, the latter continues to flourish at the present day. To take the Echinoida now living, and to divide them into Endocyclia and Exocyclia, Branchiate and Abranchiate, Gnathostomata and Atelostomata, is easy and convenient; or again to distinguish as Palaechinoida those pre-Jurassic genera which do not conform to the fixed type of twenty vertical columns found in the later Euechinoida, is to express an interesting fact; but all such divisions obscure the true relationships, and the corresponding terms should be recognized as descriptive rather than classificatory.

AUTHORITIES.—In addition to the works referred to at the beginning of the article, the following deal with the general subject: Bather, Gregory and Goodrich, "Echinoderm," in Lankester's *Treatise on Zoology* (London, 1906); F. J. Bell, *Catalogue of the British Echinoderms in the British Museum* (London, 1892); P. H. Carpenter, "Notes on Echinoderm Morphology," *Quart. Journ. Micr. Sci.*, 1878-1887; Y. Delage and E. Hérouard, *Traité de zoologie concrète*, iii., *Echinodermes* (Paris, 1904); A. Lang, *Text-Book of Comparative Anatomy*, trans., part ii. (London, 1896); Ludwig and Hamann, "Echinodermes," in *Bronn's Klassen und Ordnungen des Tierreiches* (Leipzig, 1889), in progress; M. Neumayr, *Die Stamme des Tierreiches* (Wien, 1889); P. B. and C. F. Sarasin, "Über die Anatomie der Echinothuriden und die Phylogenie der Echinodermes," *Ergebnisse naturw. Forsch. auf Ceylon*, Bd. i Hft 3 (Wiesbaden, 1888); R. Semon, "Die Homologien innerhalb des Echinodermenstammes," *Morph. Jahrb.* (1889); W. P. Sladen, "Homologies of the Primary Larval Plates in the Test of Branchiate Echinodermes," *Quart. Journ. Micr. Sci.*, 1884; K. A. v. Zittel, *Handbuch der . . . Paläozoologie*, i, pp. 308-560 (München, 1899); also *Grundzüge*, translated and revised by C. R. Eastman as *Text-*

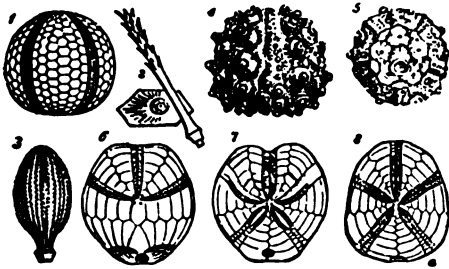

FIG. 19.—Denuded tests of some fossil Echinoids.

- 1, *Palaeochinus*; Carboniferous.
- 2, A plate and radiole of *Archaeocidaris*; Carboniferous.
- 3, A radiole of *Cidaris*; Jurassic.
- 4, *Hemicidaris*; Mid. Jurassic.
- 5, *Salenia*; Cretaceous.
- 6, *Dysaster*; Jurassic.
- 7, *Enallaster*; Cretaceous.
- 8, *Calopygus*; Cretaceous.

Cyphosomatidae, and Echinothuridae; iv. *Echinina*, Temnopleuridae, Triplechinidae, Strongylocentrotidae and Echinometridae. The order is Triassic to Recent.

Order 6. Holeclypeoida.—Ambulacra sometimes compound, with one or two pores to a plate, some dorsal podia begin to assume respiratory function; interambulacra multi-tuberculate, none resorbed; mouth central, with jaws weak or wanting, with external

Book of Palaeontology (New York and London, 1899). The larger treatises here mentioned contain very full bibliographies, and a complete analytical index to the annual literature of the Echinoderma has for many years been published in the *Zoological Record* (London). (F. A. B.)

ECHINUS (Gr. for "hedge-hog" or "sea-urchin"), in architecture, the convex moulding which supports the abacus of the Doric column. The term is sometimes given to the *ovolo* of the Ionic capital, especially when curved with the egg-and-tongue enrichment. The origin of this use of the word in architecture, which comes down from ancient times, is uncertain.

ECHIUROIDEA (Gr. *tyxos*, adder, and *obpá*, tail), the zoological name for a small group of marine animals which show in their larval life-history a certain degree of segmentation, and are therefore grouped by some authorities as Annelids. Formerly, together with the Sipunculoidea and Priapulidea, they made up the class Gephyrea, but on the ground that they retain in the adult a large preoral lobe (the proboscis), that they have anal vesicles, that their anus is terminal, that setae are found, and finally that they are segmented in the larval stage, they have been removed from the class, which by the proposed further separation of the Priapulidea on account of their unique renal and reproductive organs, has practically ceased to exist.

Echiuroids are animals of moderate size, varying roughly from one to six or seven centimetres in length, exclusive of the proboscis. This organ is capable of very considerable extension, and may attain a length in *Bonellia viridis* of about a metre and a half (fig. 1). It is grooved ventrally and ciliated.

At its attachment to the body the groove sinks into the mouth. In *Bonellia* the proboscis is forked at its free end, but in the other genera it is short and unforked. The body is somewhat sausage-shaped, with the anus at the posterior extremity, surrounded in *Echiurus* by a single or double ring of setae. The skin is usually wrinkled, and in *B. viridis*, *Thalassema lankesteri*, *Th. baronii*, *Hamingia arctica*, and in the larva of many species, is of a lively green

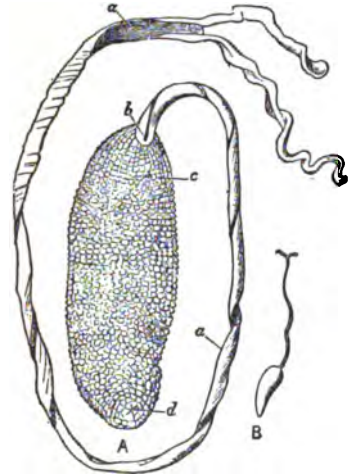

FIG. 1.—A, *Bonellia viridis*, Rol., ♀; B, B. colour. A pair of fuliginosa. Both natural size. a, grooved proboscis; b, mouth; c, ventral hooks; d, curved bristles.

project from the body a short distance behind the mouth, and are moved by special muscles; they are of use in helping the animal to move slowly about, and they take a large share in the burrowing movements (C. B. Wilson, *Biol. Bull.*, 1900), for some species tunnel in the mud and sand and form more or less permanent burrows, the walls of which are strengthened by mucus secreted from the skin. The openings of the burrows become silted up, leaving, however, a small aperture through which the proboscis is extruded. This organ carefully searches the neighbourhood for particles of food. When these are found the grooved proboscis folds its walls inwards, and the cilia pass the particles down the tube thus formed to the mouth. Echiuroids also move by extending the proboscis, which takes hold of some fixed object, and, then contracting, draws the body forwards. Recently it has been shown that *Echiurus* swims freely

at night-time, using for locomotion both the proboscis and the contraction of the muscles of its body-wall. The motion is described as "gyratory," and the anterior end is always carried foremost. Those species which do not burrow usually conceal themselves in crevices of the rocks or under stones, or at times in empty Mollusc or Echinid shells. They are occasionally used by fishermen for bait.

Anatomy (fig. 2).—A thin cuticle covers the epidermis, which contains mucus-secreting glands. Beneath the epidermis is a layer

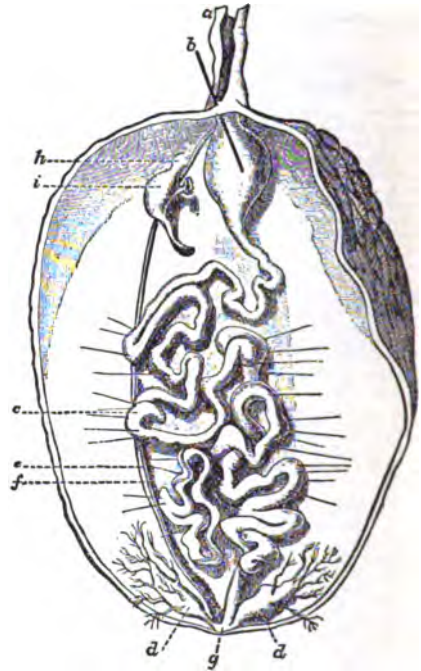

FIG. 2.—Female *Bonellia viridis*, Rol. Opened along the left side.

a, Proboscis cut short. f, Ovary borne on ventral vessel running parallel with c.
b, Bristle passing through the mouth into the pharynx. g, Position of anus. Nephridium.
c, Coiled intestine. h, Position of external opening of Nephridium—the line points towards, but does not reach, the internal opening.
d, Anal tufts or vesicles.
e, Ventral nerve cord.

of circular muscles, then a layer of longitudinal, and finally in some cases a layer of oblique muscle-fibres. The inner face of this muscular skin is lined by a layer of epithelium. The coelomic body-cavity is spacious. It does not extend into the proboscis, which is a solid organ traversed by the nervous and vascular rings, but otherwise largely built up of muscle fibres and connective tissue. Many sense-cells lie in the epidermis. The ciliated ventral groove of the proboscis leads at its base into the simple mouth, which gives access to the thin-walled alimentary canal. This is longer than the body, and to tuck it away it is looped from side to side. The loops are supported by strands of connective tissue, which in some species are united so as to form a dorsal mesentery, whilst traces of a ventral mesentery are met with anteriorly and posteriorly (H. L. Jameson, *Zool. Jahrb. Anat.*, 1899). The alimentary canal is divisible into fore-gut, mid-gut and hind-gut, and the first-named can be further divided into pharynx, oesophagus, gizzard and crop, mainly on histological grounds. The mid-gut is characterized by the presence of a ciliated groove, from which arises the collateral intestine or siphon, a second tube which rejoins the alimentary canal lower down. Similar collateral intestines are familiar in the Echinida and certain Polychaets (Capitellidae). The rectum receives the openings of a pair of very characteristic organs, the anal vesicles. Each consists of a branching tube, the tips of whose twigs terminate in minute ciliated funnels.

The anal vesicles are thought to be excretory; whether this be so or not, they undoubtedly have some influence on the amount of fluid found in the coelom. The coelomic fluid contains as a rule both amoeboid and rounded corpuscles, and, when ripe, the products of the gonads. A closed system of vessels, usually called the vascular system, is present. There are, however, no capillaries connected with this, and it is confined to certain portions of the body. It can possess few of the functions usually associated with a vascular system, and its main use is probably to assist in the expansion of the proboscis. The system consists of the following parts:—A dorsal vessel applied to the alimentary canal is continued anteriorly into a median vessel, which traverses the proboscis to its tip. Here the vessel splits, and each half returns along the lateral edge of the proboscis; they reunite around the oesophagus and form a single ventral vessel, which lies above the ventral nerve-cord. The ventral vessel, which ends solidly behind, sends off a branch which forms a ring around the intestine and opens into the posterior extremity of the dorsal vessel. In *Echiurus* and *Thalassema* the same vessel forms a ring round a stout muscle, which connects the bases of the two ventral setae before passing to surround the intestine. Amoeboid corpuscles float in the fluid contents. The nephridia vary in number from a single one in *Bonellia* to three pairs in many species of *Thalassema*. Their external openings are ventral, and on the same level as the ciliated funnel-shaped nephrostomes. The posterior wall of the organ is produced into a long blind sac, which is lined by secretory cells. The nervous system is a single ventral cord, which starts from a circum-oesophageal ring. This ring is involved in the growth of the proboscis, and is drawn out with it. Thus there is a lateral nerve near each edge of the proboscis which unites with its fellow dorsally above the oesophagus at the tip of the proboscis, and ventrally beneath the oesophagus, where they fuse to form the ventral nerve-cord. There are no specialized ganglia, but ganglion-cells are scattered uniformly along the nerve-cords. The ventral cord gives off rings, which

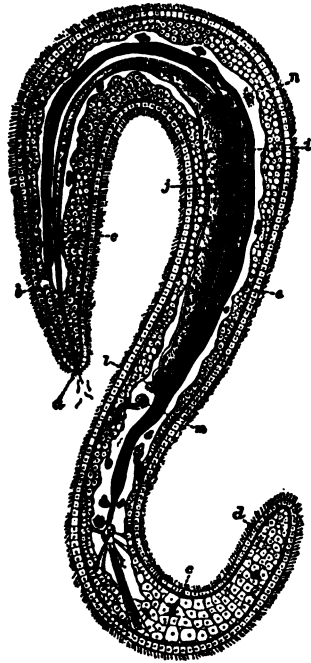

FIG. 3.—Adult male, *Bonellia viridis*, Rol. The original was 1.5 mm. long. The nervous system is not shown. (After Selenka.)

- a, Generative pore with spermatozoa coming out.
- b, Anterior blind end of intestine attached to the parenchymatous tissue by muscular strands.
- c, Green wandering cells containing chlorophyll.
- d, Parenchymatous connective tissue.
- e, Epidermis.
- f, Intestine.
- g, Vas deferens.
- h, Internal opening of vas deferens.
- i, The left anal vesicle.
- m, Spermatozoa in the body-cavity.

run into the skin at regular intervals. The reproductive cells are modified coelomic cells, which lie on the ventral vessel. They escape into the coelomic fluid and there develop. When mature they leave the body through the nephridia. *Bonellia* and *Hamingia* are very interesting examples of sexual dimorphism. The female has the normal Echiuroid structure, but the male is reduced to a minute, flattened, planarian-like organism, which passes its life usually in the company of two or three others in a special recess of the nephridia of the female. Its structure may be gathered by a reference to fig. 3.

Larva.—The larva is a typical trochophore, which, although of a temporary character, shows a distinct segmentation of the mesoblast, of the nervous system, and of the ciliated and pigmented structures in the skin, resembling that of Chaetopoda. The preoral lobe persists

as the proboscis. The sexes of the larvae are not determinable in the early stages, but when a certain growth has been reached in *Bonellia* the males seek the proboscis of the adult females, and passing into the mouth undergo there the transformation into the planarian-like parasite which is the fully-formed male. This now creeps along the body of the female and takes up its home in her nephridia.

Classification and Distribution.—The Echiuroida consists of the following genera:—(1) *Bonellia* (Rol.), with four species, widely distributed, but inhabiting the temperate and warmer waters of each hemisphere. (2) *Echiurus* (Guérin-Ménéville), with four species. This genus reaches from the Arctic waters of both hemispheres into the cooler temperate regions. (3) *Hamingia* (Kor. and Dan.), with one species, which has been taken in the Arctic Sea and the Hardanger Fjord. (4) *Saccosoma* (Kor. and Dan.) was described from a single specimen dredged about half-way between Iceland and Norway. (5) *Thalassema* (Gaertner, Lamarck), with twenty-one species. This genus is in the main a denizen of the warmer waters of the globe. Sixteen species are found only in tropical or subtropical seas, three species are Mediterranean (*Mt. Stal. Neapel*, 1899), whilst three species are from the eastern Atlantic, where the temperature is modified by the Gulf Stream (Shiple; see Willey's *Zoological Results*, part iii. 1899; *Proc. Zool. Soc. Lond.*, 1898, 1899; and *Cambridge Natural History*, ii.). The following are found in the British area:—*E. pallasi* Guérin-Ménéville), *Th. neptuni* (Gaertner), and *Th. lankesteri* (Herdman, *Q.J.M.S.*, 1898).

Affinities.—The occurrence of trochophere larva and the temporary segmentation of the body have led to the belief that the Echiuroids are more nearly allied to the Annelida than to any other phylum. This view is strengthened by certain anatomical and histological resemblances to the genus *Sternaspis*, which in one species, *S. spinosa*, is said to carry a bifid proboscis resembling that of the Echiuroids. (A. E. S.)

ECHMIADZIN, or ITSMIADZIN, a monastery of Russian Transcaucasia, in the government of Erivan, the seat of the Catholicos or primate of the Armenian church. It is situated close to the village of Vagarshapat, in the plain of the Aras, 2840 ft. above the sea, 12 m. W. of Erivan and 40 N. of Mount Ararat. The monastery comprises a pretty extensive complex of buildings, and is surrounded by brick walls 30 ft. high, which with their loopholes and towers present the appearance of a fortress. Its architectural character has been considerably impaired by additions and alterations in modern Russian style. On the western side of the quadrangle is the residence of the primate, on the south the refectory (1730-1735), on the east the lodgings for the monks, and on the north the cells. The cathedral is a small but fine cruciform building with a Byzantine cupola at the intersection. Its foundation is ascribed to St Gregory the Illuminator in 302. Of special interest is the porch, built of red porphyry, and profusely adorned with sculptured designs somewhat of a Gothic character. The interior is decorated with Persian frescoes of flowers, birds and scroll-work. It is here that the Catholicos confers episcopal consecration by the sacred hand (relic) of St Gregory; and here every seven years he prepares with great solemnity the holy oil which is to be used throughout the churches of the Armenian communion. Outside of the main entrance are the alabaster tombs of the primates Alexander I. (1714), Alexander II. (1755), Daniel (1806) and Narses (1857), and a white marble monument, erected by the English East India Company to mark the resting-place of Sir John Macdonald Kinnear, who died at Tabriz in 1830, while on an embassy to the Persian court. The library of the monastery is a rich storehouse of Armenian literature (see *Brosset's Catalogue de la bibliothèque d'Elchmiadzin*, St Petersburg, 1840). Among the more remarkable manuscripts are a copy of the gospels dating from the 10th or 11th century, and three bibles of the 13th century. A type-foundry, a printing-press and a bookbinding establishment are maintained by the monks who supply religious and educational works for their co-religionists.

To the east of the monastery is a modern college and seminary. Half a mile to the east stand the churches of St Ripsime and St Gaiana, two of the early martyrs of Armenian Christianity; the latter is the burial-place of those primates who are not

deemed worthy of interment beside the cathedral. From a distance the three churches form a fairly striking group, and accordingly the Turkish name for Echmiadsin is Uch-Kilisi, or the Three Churches. The town of Vagarshapat dates from the 6th century B.C.; it takes its name from King Vagarsh (Vologases), who in the 2nd century A.D. chose it as his residence and surrounded it with walls. Here the apostle of Armenia, St Gregory the Illuminator, erected a church in 309 and with it the primacy was associated. In 344 Vagarshapat ceased to be the Armenian capital, and in the 5th century the patriarchal seat was removed to Dvin, and then to Ani. The monastery was founded by Narses II., who ruled 524-533; and a restoration was effected in 618. The present name of the monastery was adopted instead of Vagarshapat in the 10th century. At length in 1441 the primate George brought back the see to the original site. (P. A. K.; J. T. Bz.)

ECHO (Gr. ἠχώ), in Greek mythology, one of the Oreades or mountain nymphs, the personification of the acoustical phenomenon known by this name. She was beloved by Pan, but rejected his advances. Thereupon the angry god drove the shepherds of the district mad; they tore Echo in pieces, and scattered her limbs broadcast, which still remain the gift of song (Longus iii. 23). According to Ovid (*Metam.* iii. 356-401), Echo by her incessant talking having prevented Juno from surprising Jupiter with the Nymphs, Juno changed her into an "echo"—a being who could not speak till she was spoken to, and then could only repeat the last words of the speaker. While in this condition she fell in love with Narcissus, and in grief at her unrequited affection wasted away until nothing remained but her voice and bones, which were changed into rocks. The legends of Echo are of late, probably Alexandrian, origin, and she is first personified in Euripides.

In acoustics an "echo" is a return of sound from a reflecting surface. See SOUND: *Reflection*.

See F. Wieseler, *Die Nymphen Echo* (1854), and *Narkissos* (1856); P. Decharme in Daremberg and Saglio's *Dictionnaire des antiquités*.

ECHTERNACH, a town in the grand duchy of Luxemburg, on the Sûre, close to the Prussian frontier. Pop. (1905) 3484. It is the oldest town in Luxemburg, and was the centre from which the English Saint Willibrord converted the people to Christianity in the 7th century. There are the Benedictine abbey, the hospital almshouse, which is said to be the oldest hospital in Europe except the Hôtel-Dieu in Paris, and the church of St Peter and St Paul. The Benedictine abbey has been greatly shorn of its original dimensions, but the basilica remains a fair monument of Romano-Gothic art. The church of St Peter and St Paul stands on an isolated mound, and for the ascent sixty steps have been built in the side, and these are well worn by the tread of numerous pilgrims who come in each succeeding year. The interior of the church is curious more than imposing, and is specially noteworthy only for its gloom. Under the altar, and below a white marble effigy of himself, lies Saint Willibrord.

Echternach is famous, however, in particular for the dancing procession held on Whit-Tuesday every year. The origin of this festival is uncertain, but it dates at least from the 13th century and was probably instituted during an outbreak of cholera. Nowadays it is an occasion of pilgrimage, among Germans and Belgians as well as Luxemburgers, for all sick persons, but especially for the epileptic and those suffering from St Vitus' dance. The ceremony is interesting, and the Roman Catholic Church lends all its ritual to make it more imposing. The archbishop of Trier attends to represent Germany, and the bishop of Luxemburg figures for the grand duchy. There is a religious ceremony on the Prussian side of the bridge over the Sûre, and when it is over the congregation cross into the duchy to join the procession, partly religious, partly popular, through the streets of the town. The religious procession, carrying cross and banners and attended by three hundred singers, comes first, chanting St Willibrord's hymn. Next comes a band of miscellaneous instruments playing as a rule the old German air "Adam had seven sons;" and then follow the dancers. Many of these are young and full of life and health and dance for

amusement, but many others are old or feeble and dance in the hope of recovery or of escaping from some trouble, but on all alike the conditions of the dance are incumbent. There are three steps forward and two back; five steps are thus taken to make one in advance. This becomes especially trying at the flight of steps mounting to the little church where the procession ends in front of the shrine of the great saint. There are sixty steps, but it takes three hundred to reach the top for the final time. It is said that those who fall from age or weariness have to be dragged out of the way by onlookers or they would be trampled to death by the succeeding waves of dancers. The procession, although it covers a distance of less than a mile, is said to take as much as five hours in its accomplishment. In olden days the abbey was the goal of the procession, and King William I. of the Netherlands—great-grandfather of Queen Wilhelmina—changed the day from Tuesday to Sunday so that a working day should not be lost. This reform did not answer, and the ancient order was restored. Some critics see in the dancing procession of Echternach merely the survival of the spring dance of the heathen races, but at any rate it invests the little town with an interest and importance that would otherwise be lacking.

ECHUCA, a borough of the county of Rodney, Victoria, Australia, 156 m. by rail N. of Melbourne. Pop. (1901) 4075. It is situated on the river Murray, across which it is connected by bridge with Moama, on the New South Wales side, whence a railway runs to Deniliquin. The town is the terminus of the Murray River railway and the entrepot of the overland intercolonial trade; it has large wool stores, saw-mills, coach factories, breweries and soap-works. The rich agricultural district is noted for its vineyards.

ÉCİJA, a town of southern Spain, in the province of Seville; on the Cadiz-Cordova railway and the left bank of the river Genil. Pop. (1900) 24,372. The river, thus far navigable, is here crossed by a fine old bridge; and the antiquity of the town betrays itself by the irregularity of its arrangement, by its walls and gateways, and by its numerous inscriptions and other relics. Its chief buildings include no fewer than twenty convents, mostly secularized. The principal square is surrounded with pillared porticoes, and has a fountain in the centre; and along the river bank there runs a fine promenade, planted with poplar trees and adorned with statues. From an early period the shoemakers of Ecija have been in high repute throughout Spain; woollen cloth, flannel, linen and silks are also manufactured. The vicinity is fertile in corn and wine, and cotton is cultivated. The heat is so great that the spot has acquired the sobriquet of *El Sarten*, or the "Frying-pan" of Andalusia. Ecija, called *Estija* by the Arabs, is the ancient *Astigi*, which was raised to the rank of a Roman colony with the title of *Augusta Firma*. According to Pliny and Pomponius Mela, who both wrote in the 1st century A.D., it was the rival of Cordova and Seville. If local tradition may be believed, it was visited by the apostle Paul, who converted his hostess Santa Xantippa; and, according to one version of his life, it was the see of the famous St Crispin (q.v.) in the 3rd century.

ECK, JOHANN MAIER (1486-1543), German theologian, the most indefatigable and important opponent of Martin Luther, was born on the 13th of November 1486 at Eck in Swabia, from which place he derived his additional surname, which he himself, after 1505, always modified into Eckius or Eccius, i.e. "of Eck." His father, Michael Maier, was a peasant and bailiff (*Ammann*) of the village. The boy's education was undertaken by his uncle Martin Maier, parish priest at Rotenburg on the Neckar, who sent him at the age of twelve to the university of Heidelberg, and subsequently to those of Tübingen, Cologne and Freiburg in the Breisgau. His academic career was so rapidly successful that at the age of twenty-four he was already doctor and professor of theology. During this period he was distinguished for his opposition to the scholastic philosophy; and, though he did not go to all lengths with the "modernists" (*Moderni*) of his day, his first work—*Logices exercitamenta* (1507)—was distinctly on their side. This attitude

brought him into conflict with the senate of the university, a conflict which Eck's masterful temper, increased by an extreme self-confidence perhaps natural in one so young and so successful, did not serve to allay. His position in Freiburg becoming intolerable, he accepted in 1510 an invitation from the duke of Bavaria to fill the theological chair at Ingolstadt, where he was destined for thirty years to exercise a profound influence as teacher and vice-chancellor (*Prokanzler*).

A ducal commission, appointed to find a means for ending the interminable strife between the rival academic parties, entrusted Eck with the preparation of fresh commentaries on Aristotle and Petrus Hispanus. He had a marvellous capacity for work, and between 1516 and 1520, in addition to all his other duties, he published commentaries on the *Summulae* of Petrus Hispanus, and on the *Dialectics*, *Physics* and lesser scientific works of Aristotle, which became the text-books of the university. During these early years Eck was still reckoned among the "modernists," and his commentaries are inspired with much of the scientific spirit of the New Learning. His aim, however, had been to find a *via media* between the old and new; his temper was essentially conservative, his imagination held captive by the splendid traditions of the medieval church, and he had no sympathy with the revolutionary attitude of the Reformers. Personal ambition, too, a desire to be conspicuous in the great world of affairs, may have helped to throw him into public opposition to Luther. He had won laurels in a public disputation at Augsburg in 1514, when he had defended the lawfulness of putting out capital at interest; again at Bologna in 1515, on the same subject and on the question of predestination; and these triumphs had been repeated at Vienna in 1516. By these successes he gained the patronage of the Fuggers, and found himself fairly launched as the recognized apologist of the established order in church and state. Distinguished humanists might sneer at him as "a garrulous sophist"; but from this time his ambition was not only to be the greatest scientific authority in Germany but also the champion of the papacy and of the traditional church order. The first-fruits of this new resolve were a quite gratuitous attack on his old friend, the distinguished humanist and jurist Ulrich Zasius (1461-1536), for a doctrine proclaimed ten years before, and a simultaneous assault on Erasmus's *Annotationes in Novum Testamentum*.

It is, however, by his controversy with Luther and the other reformers that Eck is best remembered. Luther, who had some personal acquaintance with Eck, sent him in 1517 copies of his celebrated 95 theses. Eck made no public reply; but in 1518 he circulated, privately at first, his *Obelisci*, in which Luther was branded as a Hussite. Luther entrusted his defence to Carlstadt, who, besides answering the insinuations of Eck in 400 distinct theses, declared his readiness to meet him in a public disputation. The challenge was accepted, and the disputation took place at Leipzig in June and July 1519. On June 27 and 28 and on July 1 and 3 Eck disputed with Carlstadt on the subjects of grace, free will and good works, ably defending the Roman Semipelagian standpoint. From July 4 to 14 he engaged with Luther on the absolute supremacy of the papacy, purgatory, penance, &c., showing a brilliant display of patristic and conciliar learning against the reformer's appeals to Scripture. The arbitrators declined to give a verdict, but the general impression was that victory rested with Eck. He did, indeed, succeed in making Luther admit that there was some truth in the Hussite opinions and declare himself against the pope, but this success only embittered his animosity against his opponents, and from that time his whole efforts were devoted to Luther's overthrow. He induced the universities of Cologne and Louvain to condemn the reformer's writings, but failed to enlist the German princes, and in January 1520 went to Rome to obtain strict regulations against those whom he called "Lutherans." He was created a protonotary apostolic, and in July returned to Germany, as papal nuncio, with the celebrated bull *Exsurge Domine* directed against Luther's writings. He now believed himself in a position to crush not only the Lutheran heretics, but also his humanist critics. The effect of the publication of the bull, however,

soon undeceived him. Bishops, universities and humanists were at one in denunciation of the outrage; and as for the attitude of the people, Eck was glad to escape from Saxony with a whole skin. In his wrath he appealed to force, and his *Epistola ad Carolum V.* (February 18, 1521) called on the emperor to take measures against Luther, a demand soon to be responded to in the edict of Worms. In 1521 and 1522 Eck was again in Rome, reporting on the results of his nunciature. On his return from his second visit he was the prime mover in the promulgation of the Bavarian religious edict of 1522, which practically established the senate of the university of Ingolstadt as a tribunal of the Inquisition, and led to years of persecution. In return for this action of the duke, who had at first been opposed to the policy of repression, Eck obtained for him, during a third visit to Rome in 1523, valuable ecclesiastical concessions. Meanwhile he continued unabated in his zeal against the reformers, publishing eight considerable works between 1522 and 1526.

His controversial ardour was, indeed, somewhat damped by Luther's refusal to answer his arguments, and with a view to earning fresh laurels he turned his attention to Switzerland and the Zwinglians. At Baden-in-Aargau in May and June 1526 a public disputation on the doctrine of transubstantiation was held, in which Eck and Thomas Murner were pitted against Johann Oecolampadius. Though Eck claimed the victory in argument, the only result was to strengthen the Swiss in their memorial view of the Lord's Supper, and so to diverge them further from Luther. At the Augsburg diet in 1530 Eck was charged by Charles-V. to draw up, in concert with twenty other theologians, the refutation of the Protestant Confession, but was obliged to rewrite it five times before it suited the emperor. He was at the colloquy of Worms in 1540 and at the diet of Regensburg (Ratisbon) in 1541. At Worms he showed some signs of a willingness to compromise, but at Regensburg his old violence reasserted itself in opposing all efforts at reconciliation and persuading the Catholic princes to reject the Interim.

Eck died at Ingolstadt on the 10th of February 1543, fighting to the last and worn out before his time. He was undoubtedly the most conspicuous champion produced by the old religion in the age of the Reformation, but his great gifts were marred by greater faults. His vast learning was the result of a powerful memory and unwearied industry, and he lacked the creative imagination necessary to mould this material into new forms. He was a powerful debater, but his victories were those of a dialectician rather than a convincing reasoner, and in him depth of insight and conviction were ill replaced by the controversial violence characteristic of the age. Moreover, even after discounting the bias of his enemies, there is evidence to prove that his championship of the Church was not the outcome of his zeal for Christianity; for he was notoriously drunken, unchaste, avaricious and almost insanely ambitious. His chief work was *De primatu Petri* (1519); his *Enchiridion locorum communium adversus Lutherum* ran through 46 editions between 1525 and 1576. In 1530-1535 he published a collection of his writings against Luther, *Opera contra Ludwicum*, in 4 vols.

See T. Wiedemann, *Dr Johann Eck* (Regensburg, 1865).

ECKERMANN, JOHANN PETER (1792-1854), German poet and author, best known owing to his association with Goethe, was born at Winsen in Hanover on the 21st of September 1792, of humble parentage, and was brought up in penury and privation. After serving as a volunteer in the War of Liberation (1813-1814), he obtained a secretarial appointment under the war department at Hanover. In 1817, although twenty-five years of age, he was enabled to attend the gymnasium of Hanover and afterwards the university of Göttingen, which, however, after one year's residence as a student of law, he left in 1822. His acquaintance with Goethe began in the following year, when he sent to him the manuscript of his *Beiräge zur Poesie* (1823). Soon afterwards he went to Weimar, where he supported himself as a private tutor. For several years he also instructed the son of the grand duke. In 1830 he travelled in Italy with Goethe's son. In 1838 he was given the title of grand-ducal councillor and appointed librarian to the grand-duchess. Eckermann is chiefly remembered

for his important contributions to the knowledge of the great poet contained in his *Conversations with Goethe* (1836-1848). To Eckermann Goethe entrusted the publication of his *Nachgelassene Schriften* (posthumous works) (1832-1833). He was also joint-editor with Friedrich Wilhelm Riemer (1774-1845) of the complete edition of Goethe's works in 40 vols. (1839-1840). He died at Weimar on the 3rd of December 1854.

Eckermann's *Gespräche mit Goethe* (vols. I. and II. 1836; vol. III. 1848; 7th ed., Leipzig, 1899; best edition by L. Geiger, Leipzig, 1902) have been translated into almost all the European languages, not excepting Turkish. (English translations by Margaret Fuller, Boston, 1839, and John Gifford, London, 1850.) Besides this work and the *Beiträge zur Poesie*, Eckermann published a volume of poems (*Gedichte*, 1838), which are of little value. See J. P. Eckermann's *Nachlass*, herausgegeben von E. Tewes, vol. I. (1905), and an article by R. M. Meyer in the *Goethe-Jahrbuch*, xvii. (1896).

ECKERNFÖRDE, a town of Germany, in the Prussian province of Schleswig-Holstein, on a fjord of the Baltic, 20 m. by rail N.W. from Kiel. Pop. (1905) 7088. It has a good harbour, fishing, trade in agricultural products, and manufactures of tobacco, salt and iron goods. There are a technical school of building and a Protestant teachers' seminary. Eckernförde is mentioned as far back as 1197. It was taken by Christian IV. of Denmark in 1628 from the Imperial troops. In 1813 the Danes were defeated here, while in 1849 the harbour was the scene of the blowing up of the Danish line-of-battle ship "Christian VIII." and of the surrender of the frigate "Gefion" after an engagement with the German shore batteries. The place lost most of its trade after the union with Germany in 1864, and suffered severely from a sea-flood in 1872. In the immediate neighbourhood is the village of Borby, much frequented for sea-bathing.

ECKERSBERG, KRISTOFFER (1783-1853), Danish painter, was born in south Jutland. He became successively the pupil of Nikolaj Abildgaard and of J. L. David. From 1810 to 1813 he lived at Paris under the direction of the latter, and then proceeded, as an independent artist, to Rome, where he worked until 1816 in close fellowship with Thorwaldsen. His paintings from this period—"The Spartan Boy," "Bacchus and Ariadne" and "Ulysses"—testify to the influence of the great sculptor over the art of Eckersberg. Returning to Copenhagen, he found himself easily able to take the first place among the Danish painters of his time, and his portraits especially were in extreme popularity. It is claimed for Eckersberg by the native critics that "he created a Danish colour," that is to say, he was the first painter who threw off conventional tones and the pseudo-classical landscape, in exchange for the clear atmosphere and natural outlines of Danish scenery. But Denmark has no heroic landscape, and Eckersberg in losing the golden commonplaces scarcely succeeds in being delightful. His landscapes, however, are pure and true, while in his figure-pieces he is almost invariably conventional and old-fashioned. He was president of the Danish Academy of Fine Arts in Charlottenburg.

ECKHART, JOHANNES ["Meister Eckhart"] (? 1260-? 1327), German philosopher, the first of the great speculative mystics. Extremely little is known of his life; the date and place of his birth are equally uncertain. According to some accounts, he was a native of Strassburg, with which he was afterwards closely connected; according to others, he was born in Saxony, or at Hochheim near Gotha. Trithemius, one of the best authorities, speaks of him merely as "Teutonicus." 1260 has frequently been given as the date of his birth; it was in all probability some years earlier, for we know that he was advanced in age at the time of his death, about 1327. He appears to have entered the Dominican order, and to have acted for some time as professor at one of the colleges in Paris. His reputation for learning was very high, and in 1302 he was summoned to Rome by Boniface VIII., to assist in the controversy then being carried on with Philip of France. From Boniface he received the degree of doctor. In 1304 he became provincial of his order for Saxony, and in 1307 was vicar-general for Bohemia. In both provinces he was distinguished for his practical reforms and for his power in preaching. Towards 1325 we hear of him as preaching with great effect

¹ The name is variously spelled: Ekehart, Eckart, Eckhard.

at Cologne, where he gathered round him a numerous band of followers. Before this time, and in all probability at Strassburg, where he appears to have been for some years, he had come in contact with the Beghards (see BROUINES) and Brethren of the Free Spirit, whose fundamental notions he may, indeed, be said to have systematized and expounded in the highest form to which they could attain. In 1327 the opponents of the Beghards laid hold of certain propositions contained in Eckhart's works, and he was summoned before the Inquisition at Cologne. The history of this accusation is by no means clear. Eckhart appears, however, to have made a conditional recantation—that is, he professed to disavow whatever in his writings could be shown to be erroneous. Further appeal, perhaps at his own request, was made to Pope John XXII., and in 1329 a bill was published condemning certain propositions extracted from Eckhart's works. But before its publication Eckhart was dead. The exact date of his death is unknown. Of his writings, several of which are enumerated by Trithemius; there remain only the sermons and a few tractates. Till the middle of the 19th century the majority of these were attributed to Johann Tauler, and it is only from Pfeiffer's careful edition (*Deutsche Mystiker d. XIV. Jahrhunderts*, vol. II., 1857) that one has been able to gather a true idea of Eckhart's activity. From his works it is evident that he was deeply learned in all the philosophy of the time. He was a thorough Aristotelian, but by preference appears to have been drawn towards the mystical writings of the Neoplatonists and the pseudo-Dionysius. His style is unsystematic, brief and abounding in symbolical expression. His manner of thinking is clear, calm and logical, and he has certainly given the most complete exposition of what may be called Christian pantheism.

Eckhart has been called the first of the speculative mystics. In his theories the element of mystical speculation for the first time comes to the front as all-important. By its means the church doctrines are made intelligible to the many, and from it the church dogmas receive their true significance. It was but natural that he should diverge more and more widely from the traditional doctrine, so that at length the relation between his teaching and that of the church appeared to be one of opposition rather than of reconciliation. Eckhart is in truth the first who attempted with perfect freedom and logical consistency to give a speculative basis to religious doctrines. The two most important points in his, as in all mystical theories, are first, his doctrine of the divine nature, and second, his explanation of the relation between God and human thought. (See MYSTICISM.)

For the German writings of Eckhart see F. Pfeiffer, *Deutsche Mystiker*, vol. II. (Leipzig, 1857), and F. Janssen, *Meister Eckhart und seine Jünger* (Freiburg, 1895); for the Latin works, H. Denifle in *Archiv f. Litt. und Kirchengeschichte d. Mittelalters*, II. (1886), pp. 417-652, and v. (1889), pp. 349-364; German translations by G. Landauer, *Meister Eckharts mystische Schriften* (Berlin, 1903), and Büttner (Leipzig, 1903, foll.). See also A. Lanson, *Meister Eckhart der Mystiker* (1868); H. L. Martensen, *Meister Eckhart* (1842); J. Bach, *Meister Eckhart der Vater der deutschen Spiritualität* (1864); C. Ullmann, *Reformatoren vor der Reformation* (1842); W. Preger, *Geschichte d. deutschen Mystik*, I. (1874); and "Ein neuer Traktat M. Eckharts und d. Grundzüge der Eckhartischen Theosophie" in *Zeitschr. f. hist. Phil.* (1864), pp. 163 foll.; A. Bullinger, *Das Christentum im Lichte der deutschen Philos.* (Dillingen, 1895); H. Delacroix, *Le Mysticisme spéculatif en Allemagne au XIV^e siècle* (Paris, 1900); E. Kramm, *Meister Eckhart im Lichte der Deutschen Funde* (Bonh., 1889); R. Langenber, *Über die Verhältnisse Meister Eckharts zur niederdeutschen Mystik* (Göttingen, 1896); W. Schopf, *Meister Eckhart* (Leipzig, 1889); A. Jundt, *Hist. du panthéisme populaire au moyen âge* (Paris, 1875); art. in Herzog-Hauck, *Realencyclopädie* (S. M. Deutsch); R. M. Jones, *Mystical Religion* (1909).

ECKHEL, JOSEPH HILARIUS (1737-1798), Austrian numismatist, was born at Enzersfeld in lower Austria, 1737. His father was farm-steward to Count Zinzendorf, and he received his early education at the Jesuits' College, Vienna, where at the age of fourteen he was admitted into the order. He devoted himself to antiquities and numismatics. After being engaged as professor of poetry and rhetoric, first at Steyer and afterwards at Vienna, he was appointed in 1777 keeper of the cabinet of coins at the Jesuits' College, and in the same year he went to Italy for the purpose of personal inspection and study of antiquities and coins. At Florence he was employed to arrange the collection of

the grand duke of Tuscany; and the first-fruits of his study of this and other collections appeared in his *Numi veteres anecdoti*, published in 1775. On the dissolution of the order of Jesuits in 1773, Eckhel was appointed by the empress Maria Theresa professor of antiquities and numismatics at the university of Vienna, and this post he held for twenty-four years. He was in the following year made keeper of the imperial cabinet of coins, and in 1799 appeared his *Catalogus Vindobonensis numorum veterum*. Eckhel's great work is the *Doctrina numorum veterum*, in 8 vols., the first of which was published in 1792, and the last in 1798. The author's rich learning, comprehensive grasp of his subject, admirable order and precision of statement in this masterpiece drew from Heyne enthusiastic praise, and the acknowledgment that Eckhel, as the Coryphaeus of numismatists, had, out of the mass of previously loose and confused facts, constituted a true science. A volume of *Addenda*, prepared by Steinbichel from Eckhel's papers after his death, was published in 1826. Among his other works are—*Choix de pierres gravées du Cabinet Impérial des Antiques* (1788), a useful school-book on coins entitled *Kurzgefasstes Anfangsgründe zur allen Numismatik* (1787), of which a French version enlarged by Jacob appeared in 1825, &c. Eckhel died at Vienna on the 16th of May 1798.

ECKMÜHL, or **ЕССАМЪЛ**, a village of Germany, in the kingdom of Bavaria, on the Grosse Laaber, 13 m. S.E. of Regensburg by the railway to Munich. It is famous as the scene of a battle fought here on the 22nd of April 1809, between the French, Bavarians and Württembergers under Napoleon, and the Austrians under the Archduke Charles, which resulted in the defeat of the latter. Napoleon, in recognition of Marshal Davout's great share in the victory, conferred on him the title of prince of Eckmühl. For an account of this action and those of Abensberg and Landshut see NAPOLEONIC CAMPAIGNS.

ECLÉCTICISM (from Gr. ἐκλέγω, I select), a term used specially in philosophy and theology for a composite system of thought made up of views borrowed from various other systems. Where the characteristic doctrines of a philosophy are not thus merely adopted, but are the modified products of a blending of the systems from which it takes its rise, the philosophy is not properly eclectic. Eclecticism always tends to spring up after a period of vigorous constructive speculation, especially in the later stages of a controversy between thinkers of pre-eminent ability. Their respective followers, and more especially cultured laymen, lacking the capacity for original work, seeking for a solution in some kind of compromise, and possibly failing to grasp the essentials of the controversy, take refuge in a combination of those elements in the opposing systems which seem to afford a sound practical theory. Since these combinations have often been as illogical as facile, "eclecticism" has generally acquired a somewhat contemptuous significance. At the same time, the essence of eclecticism is the refusal to follow blindly one set of formulæ and conventions, coupled with a determination to recognize and select from all sources those elements which are good or true in the abstract, or in practical affairs most useful *ad hoc*. Theoretically, therefore, eclecticism is a perfectly sound method, and the contemptuous significance which the word has acquired is due partly to the fact that many eclectics have been intellectual trimmers, sceptics or dilettanti, and partly to mere partisanship. On the other hand, eclecticism in the sphere of abstract thought is open to this main objection that, in so far as every philosophic system is, at least in theory, an integral whole, the combination of principles from hostile theories must result in an incoherent patchwork. Thus it might be argued that there can be no logical combination of elements from Christian ethics, with its divine sanction, and purely intuitional or evolutionary ethical theories, where the sanction is essentially different in quality. It is in practical affairs that the eclectic or undogmatic spirit is most valuable, and also least dangerous. In the 2nd century B.C. a remarkable tendency toward eclecticism began to manifest itself. The longing to arrive at the one explanation of all things, which had inspired the older philosophers, became less earnest; the belief, indeed, that any such explanation was attainable began to fail. Thus men came

to adopt from all systems the doctrines which best pleased them. In Panaetius we find one of the earliest examples of the modification of Stoicism by the eclectic spirit; about the same time the same spirit displayed itself among the Peripatetics. In Rome philosophy never became more than a secondary pursuit; naturally, therefore, the Roman thinkers were for the most part eclectic. Of this tendency Cicero is the most striking illustration—his philosophical works consisting of an aggregation, with little or no blending, of doctrines borrowed from Stoicism, Peripateticism, and the scepticism of the Middle Academy.

In the last stage of Greek philosophy the eclectic spirit produced remarkable results outside the philosophies of those properly called eclectics. Thinkers chose their doctrines from many sources—from the venerated teaching of Aristotle and Plato, from that of the Pythagoreans and of the Stoics, from the old Greek mythology, and from the Jewish and other Oriental systems. Yet it must be observed that Neoplatonism, Gnosticism, and the other systems which are grouped under the name Alexandrian, were not truly eclectic, consisting, as they did, not of a mere syncretism of Greek and Oriental thought, but of a mutual modification of the two. It is true that several of the Neoplatonists professed to accept all the teaching both of Plato and of Aristotle, whereas, in fact, they arbitrarily interpreted Aristotle so as to make him agree with Plato, and Plato so as to make his teachings consistent with the Oriental doctrines which they had adopted, in the same manner as the schoolmen attempted to reconcile Aristotle with the doctrines of the church. Among the early Christians, Clement of Alexandria, Origen and Synesius were eclectics in philosophy.

The eclectics of modern philosophy are too numerous to name. Of Italian philosophers the eclectics form a large proportion. Among the German we may mention Wolf and his followers, as well as Mendelssohn, J. A. Eberhard, Ernst Platner, and to some extent Schelling, whom, however, it would be incorrect to describe as merely an eclectic. In the first place, his speculations were largely original; and in the second place, it is not so much that his views of any time were borrowed from a number of philosophers, as that his thinking was influenced first by one philosopher, then by another.

In the 19th century the term "eclectic" came to be applied specially to a number of French philosophers who differed considerably from one another. Of these the earliest were Pierre Paul Royer-Collard, who was mainly a follower of Thomas Reid, and Maine de Biran; but the name is still more appropriately given to the school of which the most distinguished members are Victor Cousin, Théodore Jouffroy, J. P. Damiron, Barthélemy St Hilaire, C. F. M. de Rémusat, Adolphe Garnier and Ravaisson-Mollien. Cousin, whose views varied considerably at different periods of his life, not only adopted freely what pleased him in the doctrines of Pierre Laromiguière, Royer-Collard and Maine de Biran, of Kant; Schelling and Hegel, and of the ancient philosophies, but expressly maintained that the eclectic is the only method now open to the philosopher, whose function thus resolves itself into critical selection and nothing more. "Each system," he asserted, "is not false, but incomplete, and in reuniting all incomplete systems, we should have a complete philosophy, adequate to the totality of consciousness." This assumes that every philosophical truth is already contained somewhere in the existing systems. If, however, as it would surely be rash to deny, there still remains philosophical truth undiscovered, but discoverable by human intelligence, it is evident that eclecticism is not the only philosophy. Eclecticism gained great popularity, and partly owing to Cousin's position as minister of public instruction, became the authorized system in the chief seats of learning in France, where it has given a most remarkable impulse to the study of the history of philosophy.

ECLIPSE (Gr. ἐκλείψω, falling out of place, failing), the complete or partial obscuration of one heavenly body by the shadow of another, or of the disk of the sun by the interposition of the moon; then called an eclipse of the sun. Eclipses are of three classes: those of the sun, as just defined; those of the moon, produced by its passage through the

shadow of the earth, and those of the satellites of other planets, produced by their passage through the shadow of their primary. Jupiter (*q.v.*) is the only planet of whose satellites the eclipses can be observed, unless under very rare circumstances.

The geometrical conditions of an eclipse of the sun or moon are shown in fig. 1, which represents the earth E as casting its shadow towards C, and the moon M between the earth and sun as throwing



FIG. 1.

its shadow towards some part of the earth and eclipsing the sun. The dark conical regions are those within which the sun is entirely hidden from sight. This portion of the shadow is called the *umbra*. Around the umbra is an enveloping shaded cone with its vertices directly towards the sun. To an observer within this region the sun is partly hidden from view. As the apparent path of the moon may pass to the north or south of the line joining the earth and sun, the axis of its shadow may pass to the north or south of the earth, and not meet it at all. An eclipse of the sun is called *central* when the shadow axis strikes any part of the earth; partial when only the penumbra falls upon the earth. It is evident that an eclipse can be seen as central only at those points of the earth's surface over which the axis of the shadow passes.

A central eclipse is *total* when the umbra actually reaches the earth; *annular* when it does not. These two cases are shown in figs. 2 and 3. In the first of these the sun is entirely hidden

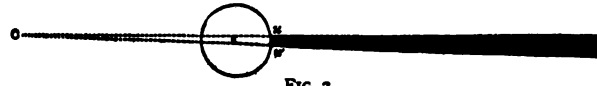

FIG. 2.

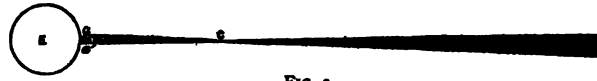

FIG. 3.

within the region *uw'*. In fig. 3 within the region *os'* the apparent diameter of the sun is slightly greater than that of the moon, and at the moment of greatest eclipse a narrow ring of sunlight is seen surrounding the dark body of the moon.

We shall treat the subject in the following sections:—

- I. Phenomena of Eclipses of the Sun and conclusions derived from their observation.
- II. Eclipses of the Moon.
- III. The Laws and Cycles of recurrences of Eclipses of the Sun and Moon.
- IV. Chronological list of remarkable eclipses of the Sun, past and future, to the end of the 20th century.
- V. Description of the methods of computing eclipses.

I. Phenomena of Eclipses of the Sun.

While an eclipse of the sun, whether partial, annular or total, is in progress, no striking phenomena are to be noted until, in the case of total eclipses, the moment of the total phase approaches. It will, however, be noticed that as the moon advances on the solar disk the sharply defined and ragged edge of the moon's disk contrasts strongly with the soft and uniform outline of the sun's limb. As the total phase approaches, the phenomenon known as *shadow bands* may sometimes be seen. These consist of seeming vague and rapidly moving wave-like alternations of light and shade flitting over any white surface illuminated by the sun's rays immediately before and after the total phase. They are probably due to a flickering of the light from the thin crescent, produced by the undulations of the air, in the same way that the twinkling of the stars is produced. The rapid progressive motion sometimes assigned to them may be regarded as the natural result of an optical illusion. A few seconds before the commence-

ment of the total phase the red light of the chromosphere becomes visible, and will be seen most distinctly as continuations of the solar crescent at its two ends. Owing to the inequalities of the lunar surface, the diminution of the solar crescent does not go on with perfect uniformity, but, just before the last moment, what remains of it is generally broken up into separate portions of light, which, magnified and diffused by the irradiation of the telescope,

present the phenomenon long celebrated under the name of "Baily's beads." These were so called because minutely and vividly described by Francis Baily as he observed them during the annular eclipse of May 15, 1836, when he compared them to a string of bright beads, irregular in size and distance from each other. The disappearance of the last bead is commonly taken as the beginning of totality. An arc of the chromosphere will then be visible for a few seconds at and on each side of the point of disappearance, the length and duration of which will depend on the apparent diameter of the moon as compared with that of the sun, being greater in length and longer seen as the excess of diameter of the moon is less. The red prominences may now generally be seen here and there around the whole disk of the moon, while the effulgence of soft light called the corona surrounds it on all sides. Before the invention of the spectroscope, observers of total eclipses could do little more than describe in detail the varying phenomena presented by the prominences and the corona. Drawings of the latter showed it to have the appearance of rays surrounding the dark disk of the moon, quite similar to the glory depicted by the old painters around the head of a saint. The discrepancies between the outlines as thus pictured, not only at different times, but by different observers at the same time and place, are such as to show that little reliance can be placed on the details represented by hand drawings.

During the eclipse of July 8, 1842, the shadow of the moon passed from Perpignan, France, through Milan and Vienna, over Russia and Central Asia, to the Pacific Ocean. Very detailed physical observations were made, but none which need be specially mentioned in the present connexion.

The eclipse of July 28, 1851, was total in Scandinavia and Russia. It was observed in the former region by many astronomers, among them Sir George B. Airy and W. R. Dawes. It was specially noteworthy for the first attempt to photograph such a phenomenon. A daguerreotype clearly showing the protuberances was taken by Berkowski at the Observatory of Königsberg. An attempt by G. A. Majocchi to daguerreotype the corona was a failure. Photographs of the eclipse of July 18, 1860, were taken by Padre Angelo Secchi and Warren De La Rue, which showed the prominences well, and proved that they were progressively obscured by the edge of the advancing moon. It was thus shown that they were solar appendages, and did not belong to the moon, as had sometimes been supposed. The corona was barely visible on De La Rue's plates, but those of Secchi showed it, with its rifts and the bases of the tall coronal wings, to about 15' from the sun's limb. The sketches taken at this eclipse proved that the corona extended in some regions 1° from the sun's limb. As the sensitiveness of photographic plates has increased, they have gradually been wholly relied upon for information respecting the corona, so that at the present time naked-eye descriptions are regarded as of little or no scientific value. Owing to the great contrast between the brilliancy of the coronal light at its base and its increasing faintness as it extends farther from the sun, no one photograph will bring out all the corona. An exposure of one or two seconds is ample to show the details of inner corona to the best advantage, while longer exposures give greater extent of the brighter portions. The most extended streamers are very little brighter than the sky, and must be photographed with long exposures.

The first application of the spectroscope to the phenomenon was made during the total solar eclipse of August 18, 1868, by P. J. C. Janssen and other observers in India. By them was made the capital discovery that the red solar prominences give a spectrum of bright lines, and are therefore immense masses of incandescent gases, chiefly hydrogen and the vapours of calcium and helium. Janssen also found that this bright-line spectrum could be followed after the eclipse was over, and, in fact, could be observed at any time when the air was sufficiently transparent. By one of those remarkable coincidences which frequently occur in the history of science, this last discovery was made independently by Sir Norman Lockyer in England before the news of Janssen's success had reached him. It was afterwards found that, by giving great dispersing power to the spectroscope, the prominences could be observed in a wide slit, in their true form. At this eclipse the spectrum of the corona was also observed, and was supposed to be continuous, while polariscopic observation by Lieutenant Campbell showed it polarized in planes passing through the sun's centre. The conclusion from these two observations was that the light was composed, at least in great part, of reflected sunlight.

At the total eclipse of August 7, 1869, it was independently found by Professors C. A. Young of Princeton and W. Harkness of Washington that the continuous spectrum of the corona was crossed by a bright line in the green, which was long supposed to be coincident with 1474 of Kirchhoff's scale. This coincidence is, however, now found not to be real, and the line cannot be identified with that of any terrestrial substance. The name "coronium" has therefore been given to the supposed gas which forms it. It is now known that 1474 is a double line, one component of which is produced by iron, while the other is of unknown origin. The wave-length of the principal component is 5317, while that of the coronal line was found at the eclipses of 1896 and 1898 to be 5303.

The eclipse of December 28, 1870, passed over the southwestern corner of Spain, Gibraltar, Oran and Sicily. It is memorable for the discovery by Young of the "reversing layer" of the solar atmosphere. This term is now applied to a shallow stratum resting immediately upon the photosphere, the absorption of which produces the principal dark lines of the solar spectrum, but which, being incandescent, gives a spectrum of bright lines by its own light when the light of the sun is cut off. This layer is much thinner than the chromosphere, and may be considered to form the base of the latter. Owing to its thinness, the phenomenon of the reversed bright lines is almost instantaneous in its nature, and can be observed for a period exceeding one or two seconds only near the edge of the shadow-path, where the moon advances but little beyond the solar limb. Near the central line it is little more than a flash, thus giving rise to the term "flash-spectrum." Young also at this eclipse saw bright hydrogen lines when his spectroscope was directed to the centre of the dark disk of the moon. This can only be attributed to the reflection of the light of the prominences and chromosphere from the atmosphere between us and the moon. The coronal light as observed in the spectroscope may thus be regarded as a mixture of true coronal light with chromospheric light reflected from the air, and it is therefore probable that the H and K (calcium) lines of the coronal spectrum are not true coronal lines, but chromospheric.

At the eclipse of December 12, 1871, visible in India and Australia, Janssen observed, as he supposed, some of the dark lines of the solar spectrum in the continuous spectrum of the corona, especially D, δ and G. This would show that an important part of the coronal light is due to reflected sunshine. This feature of the spectrum, however, is doubtful in the most recent photographs under the best conditions. At this eclipse the remarkable observation was also made by Colonel John Herschel and Colonel J. F. Tennant that the characteristic line of the coronal spectrum is as bright in the dark rifts of the corona as elsewhere. This would show that the gas coronium does not form the streamers of the corona, but is spherical in form and distributed uniformly about the sun. Photographs were also

taken on wet plates by a party in Java and by the parties of Lord Lindsay (at Baikul, India) and of Colonel Tennant (at Dodabetta). The Baikul and Dodabetta photographs were of small size (moon's diameter = $\frac{1}{4}$ in.), but of excellent definition. A searching study was made of them by A. C. Ranyard and W. H. Wesley (*Memoirs R.A.S.* vol. xli., 1879), and for the first time a satisfactory representation of the corona was obtained. The drawings in the volume quoted show its polar rays, wings, interlacing filaments and rifts as they are now known to be, as well as the forms and details of the prominences.

The eclipse of April 16, 1874, was observed in South Africa by E. J. Stone, H.M. astronomer at the Cape, who traced the coronal line about 30' (430,000 m.) from the sun's limb. The visual corona was seen to extend in places some 90' from the limb.

The eclipse of April 6, 1875, was observed in Siam by Sir J. Norman Lockyer and Professor Arthur Schuster. Their photographs showed the calcium and hydrogen lines in the prominence spectrum.

The eclipse of July 29, 1878, was observed by many astronomers in the United States along a line extending from Wyoming to Texas. A number of the stations were at high altitudes (up to 14,000 ft.), and the sky was generally very clear. The visible corona extended on both sides of the sun along the ecliptic for immense distances—at least twelve lunar diameters, about eleven million miles. Photographs taken by the parties of Professors A. Hall and W. Harkness gave the details of the inner corona and of the polar rays, showing the filamentous character of the corona, especially at its base in the polar regions. A photograph taken by the party of Professor E. S. Holden showed the outer corona to a distance of 50' from the moon's limb. The bright-line spectrum of the corona was excessively faint and, as the solar activity (measured by sun-spot frequency) was near a minimum, it was concluded that the brilliancy of the coronium line varied in the sun-spot period, a conclusion which subsequent eclipse observations seem to have verified. It is not yet certain that the other coronal spectrum lines vary in the same way.

The eclipse of May 17, 1882, was observed in Egypt. On the photographs of the corona the image of a bright comet was found, the first instance of the sort. (A faint comet was found on the plates of the Lick Observatory eclipse expedition to Chile in 1893.) The slitless spectroscope showed the green line (coronium) and D₂ (helium) in the coronal spectrum.

The eclipse of May 6, 1883, was observed from a small coral atoll in the South Pacific Ocean by parties from America, England, France, Austria and Italy. A thorough search was made by Holden (with a 6 in. telescope) for an intra-Mercurial planet, without success, during an unusually long totality (5 m. 23 s.). J. Palisa also searched for such a planet. Janssen again reported the presence of dark lines in the coronal spectrum. "White" prominences were seen by P. Tacchini.

The eclipse of August 29, 1886, was observed in the West Indies. The English photographs of the corona, taken with a slitless spectroscope, show the hydrogen lines as well as K and f. Tacchini devoted his attention to the spectra of the prominences, and showed that their upper portions contained no hydrogen lines, but only the H and K lines of calcium. He also observed a very extensive "white" prominence. It was shown on the photographs of the corona, but could not be seen in the H α line with the spectroscope. It has been suggested by Professor G. E. Hale that the colour of a "white" prominence may be due to the fact that the H and K lines (calcium) are of their normal intensity, while the less refrangible prominence lines are, from some unknown cause, comparatively faint. It is known that the intensity of such lines does, in fact, vary, though it is not yet certain that the "white" prominences are produced in this way. The subject is one demanding further observation. High prominences are generally "white" at their summits, "red" at their bases. The Harvard College Observatory photographs show the corona out to 90' from the moon's limb, though no detail is visible beyond 60'. W. H. Pickering made a series of photographic photometric measures of the corona, some of which are given

below, together with results deduced by Holden from the eclipses of January and December 1889:—

	August 1886.	January 1889.	December 1889.
Intrinsic actinic brilliancy of the brightest parts of the corona	0.031	0.079	0.029
Do. of the polar rays		0.053	0.016
Do. of the sky near the sun	0.0007	0.0050	0.0009
Ratio of intrinsic brilliancy of the brightest parts of the corona to that of the sky (actinic)	44 to 1	16 to 1	32 to 1
Magnitude of the faintest star shown on the eclipse negatives		2.3	

The results in the first and third columns are derived from plates taken in a very humid climate, and are not very different.

The eclipse of August 19, 1887, was total in Japan and Russia, but cloudy weather prevented successful observations except in Siberia and eastern Russia.

The eclipse of January 1, 1889, was observed in California and Nevada by many American astronomers. The photographs of the corona, especially those by Charoppin and E. E. Barnard, show a wealth of detail. Those of Barnard, of the Lick Observatory party, were studied by Holden, and exhibited the fact that rays, like the "polar-rays," extended all round the sun, instead of being confined to the polar regions only. The outer corona was registered out to 100' from the moon's limb on Charoppin's negatives, to 130' on those of Lowden and Ireland. On other plates the outline of the moon is visible projected on the corona before totality began. The spectrum of the corona showed few bright lines besides those of coronium and hydrogen.

The eclipse of December 22, 1889, was observed in Cayenne, S. America, by a party from the Lick Observatory under rather unfavourable conditions. Expeditions sent to Africa were baffled by cloudy weather. Father Stephen Joseph Perry observed at Salute Islands, French Guiana, and obtained some photographs of value. The effort cost him his life, for he died of malarial fever five days after the eclipse.

The eclipse of April 16, 1893, was observed by British and French parties in Africa and Brazil, and by Professor J. M. Schaeberle of the Lick Observatory in Chile. The Chile photographs of the corona were taken with a lens of 40 ft. focus, and are extremely fine. They show a faint comet near the sun. No great extensions to the corona were shown on any of the negatives, or seen visually, though they were specially looked for by British parties. The neighbourhood of the sun was carefully examined by G. Bigourdan without finding any planet. The spectrum of the corona was the usual one. The following lines were photographed in slitless spectroscopes, and undoubtedly belong to the corona: W. L. 3987; 4086; 4217; 4231; 4240; 4280; 4486; 5303 (the last number is the wave-length of the green coronium line). All of these have been seen in slit spectroscopes also. It is possible that two lines observed by Young in 1869, namely, W. L. (Ångström) 5450 and 5570, should be added to the list of undoubted coronal lines. It is not likely that helium or hydrogen or calcium vapour forms part of the corona. The wave-lengths of some 700 lines belonging to the chromosphere and prominences were determined by the British parties.

The eclipse of August 9, 1896, was total in Norway, Novaya Zemlya and Japan. The day was very unfavourable as to weather, but good photographs of the corona were obtained by Russian parties in Siberia and Lapland. Shackleton, in Novaya Zemlya, with a prismatic camera obtained a photograph of the reversing-layer at the beginning of totality. This photograph completely confirms Young's discovery, and shows the prominent Fraunhofer lines bright, the bright lines of the chromosphere spectrum being especially conspicuous.

At the solar eclipse of January 22, 1898, the shadow of the moon traversed India from the western coast to the Himalaya. The duration of totality was about 2 m. The eclipse was very fully observed, more than 100 negatives of the corona being secured. The equatorial extension of the visible corona was short and faint, and the invisible (spectroscopic) corona was also very

faint. The spectrum of the reversing-layer was successfully photographed; one set of negatives shows the polarization of one of the longest streamers of the corona, and proves the presence of dust particles reflecting solar light. The bright-line spectrum of hydrogen in the chromosphere was followed to the thirtieth point of the series, and the wave-lengths were shown to agree closely with Balmer's formula (see SPECTROSCOPY). The wave-length of coronium was found to be 5303 (not 5317 as previously supposed), and the brightness of the corona was measured. E. W. Maunder made the curious observation of coronal matter enveloping a prominence in the form of a hood.

Observations of the eclipse of May 28, 1900, were favoured in a remarkable degree by the absence of clouds. The photographs of the corona obtained by W. W. Campbell extended four diameters of the sun on the west side. The sun's edge was photographed with an objective-prism spectrograph composed of two 60° prisms in front of a telescope of 2 in. aperture and 60 in. focus. A fine photograph, 6 in. long, of the bright- and dark-line spectra of the sun's edge at the end of totality was thus obtained. It shows 600 bright lines sharply in focus besides the dark-line spectrum, to which the bright lines gave way as the sun reappeared. The coronal material radiating the green light was found to be markedly heaped up in the sun-spot regions. No dark lines were found in the spectrum of the inner corona. G. E. Hale and E. B. Frost also photographed the combined bright- and dark-line spectra of the solar cusps at the instants before and after totality. On one photograph showing no dark lines 70 bright lines could be measured between 4070 and 4340. On another were 70 bright lines between H β and H γ . On a third were 266 bright lines between 4026 and 4381, and some dark lines. These lines show a marked dissimilarity from the solar spectrum. (S. N.)

The eclipse of May 18, 1901, was observable in Mauritius with 3½ minutes of totality, and in Sumatra with 6½ minutes. Unfortunately there was cloudy weather in Sumatra, which at some stations prevented observations entirely and at others neutralized the advantages promised by the long duration of totality. Thus spectroscopic observations for the detection of motion of the corona, for which the long totality gave a special opportunity, failed owing to cloud; and the search for intra-Mercurial planets had only a negative result, though stars down to magnitude 8.3 were photographed on the plates. But though no particular step in advance was taken, successful records of the eclipse were obtained, which will enable comparison to be made with other eclipses and will contribute their share to the discussion of the whole series. These include photographs of the corona, showing that it was of the sun-spot minimum type, and available for measures of its brightness; photographs of the spectra of the chromosphere and corona which are of the same general character as those obtained at previous eclipses; photographs showing the polarization of the corona, available for quantitative measures of polarization at different points. Photographs of the spectrum of the outer corona taken by the Lick Observatory party show a strong Fraunhofer dark-line spectrum, consistent with the view that the light is reflected sunlight. At Mauritius there was no cloud, but the definition was poor. Successful photographs of the corona were obtained for comparison with those taken in Sumatra one and a half hours later, but nothing of great interest was revealed by the comparison.

The eclipse of August 30, 1905, offered a duration of 3½ minutes in Spain, the track running from Labrador through Spain to North Africa, and affording excellent opportunities for observers, who flocked to the central line in great numbers. Unfortunately it was cloudy in Labrador, so that the special advantages of the long line of possible stations were lost. Exceptionally good weather conditions were enjoyed in Algeria and Tunisia, and full advantage was taken of them by H. F. Newell, C. Trépiéd and others at Guelma, by the party from Greenwich and G. Bigourdan at Stax. That G. Newell's spectroscopic photographs for rotation of the corona again gave no result is a clear indication of the faintness of the corona at 3' from the limb; but F. W. Dyson at Stax obtained two new lines at 5536 and 5517 in the spectrum

of the corona; and a very large number of photographs of the corona (including many in polarized light on several different plans), of its spectrum, and of the spectrum of the chromosphere, were obtained by the various parties, which will afford copious material for discussion. Newall also obtained a polarized spectrum of the corona. Altogether no less than eighty stations were occupied. There were English, American, Russian and German observers in Egypt; English and French in Algeria and Tunisia; English in Majorca; observers of almost all nationalities in Spain; and English and American in Labrador. In Egypt the weather was bright, though the sun was low; in Majorca and Spain there were local clouds. Consequently many observations, in addition to those in Labrador, were lost, notably the special spectroscopic observations undertaken by Evershed on the northern limit of totality, and the observations of radiation undertaken by H. L. Callendar. A search for intra-Mercurial planets was conducted on an elaborate plan, with similar batteries of telescopes, in Egypt, Spain and Labrador, by three parties from the Lick Observatory, but the examination of the plates showed nothing noteworthy. Pending discussion of the greater part of the material, some interesting preliminary results were published in 1906 by the French observers. C. E. H. Bourget and Montangerand conclude that there is a marked division of the chromosphere into two regions or shells, a lower or "reversing-layer," extending only 1" from the limb, and a chromospheric layer extending to 3" or 4"; and that the coronal light contains less blue and violet, but more green and yellow, than sunlight; while Fabry, by visual methods, obtained measures of the total and intrinsic intensity of the light from the corona closely confirming recent photographic observations, finding the total brightness about equal to that of the full moon, and the intrinsic brightness at 5' from the limb about one quarter of that of the full moon. (H. H. T.)

II. Eclipses of the Moon.

The physical phenomena attending eclipses of the moon are no longer of a high order of interest either to the layman or scientific observer. A brief statement of them and their causes will therefore be sufficient. An observer watching such an eclipse from the moon would see the earth, which has nearly four times the apparent diameter of the sun, impinging on the sun's disk and slowly hiding it. The phenomenon would be quite similar to that of an eclipse of the sun seen from the earth, until the sun was completely covered. During the progress of this partial eclipse the moon would be passing into the earth's penumbra. As the moment of total obscuration approached, a red band of light would rapidly form in the neighbourhood of the disappearing limb of the sun, and gradually extend around the earth. This would arise from the refraction of the sun's light by the earth's atmosphere, and the absorption of its blue rays. When the light of the sun was completely hidden, a reddish ring of great brilliancy would, owing to this cause, surround the entire dark body of the earth during the period of the total eclipse.

The aspect of the moon, as seen from the earth, corresponds to this view from the moon. The fading of the moon's light, due to its entrance into the penumbra, is scarcely noticeable without direct photometric determination until near the beginning of the total phase. Then, as the limb of the moon approaches the earth's shadow, it begins to darken. When only a small portion has entered into the shadow, that portion is completely hidden. But, as the total phase approaches, the part of the moon's disk immersed in the penumbra becomes visible by a reddish coppery light—that of the sun refracted through the lower parts of the earth's atmosphere. The brightness of this illumination is different in different eclipses, a circumstance which may be attributed to the greater or less degree of cloudiness in those regions of the earth's atmosphere through which the light of the sun passes in order to reach the moon. Its colour is due to absorption in passing through the earth's atmosphere.

III. Laws and Cycles of Recurrences of Eclipses of the Sun and Moon.

It has been known since remote antiquity that eclipses occur

in cycles. These cycles are known now to be determined principally by the motion of the moon's node and the relations between the revolutions of the earth round the sun and the moon round the earth.

Owing to the inclination of the moon's orbit to the plane of the ecliptic, an eclipse of the sun can occur only when the conjunction of the sun and moon takes place within about 16° of one of the nodes of the moon's orbit. The ^{Eclipse seasons} eclipse can be total only within about 11° of the node.

An eclipse of the moon can occur only when the line sun-moon-earth makes an angle less than about 11° with the line of nodes; and the eclipse can be total only within about 8° of the node, the average limiting distances varying 1° or 2° according to the circumstances. These conditions being understood, the cycles of recurrence of eclipses of either kind can be worked out geometrically from the mean motions of the sun, moon, node and perigee by the aid of geometric conceptions shown in their simplest form in fig. 4. Here E is the earth, at the centre of a circle representing the mean orbit of the moon around it.

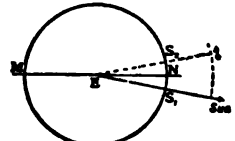

FIG. 4.

MN is the line of nodes which is moving in the retrograde direction from N towards S₁, at a rate of about 19.3° in a year, making a complete revolution in 18.6 years. Let the sun at the moment of some new moon be in the line ES₁, continued. If the angle NES₁ is less than 16° there will probably be an eclipse of the sun, which may be central if the angle is less than 11°. Let the next new moon take place in the line ES₂ a month later. The mean value of the angle S₁ES₂ is about 30°, but as the node N has moved towards S₁ about 1.4° during the interval, the sum of the angles NES₁ and NES₂ will be somewhat greater than S₁ES₂, by about 1.6°. The result is that if these two angles are nearly equal there may be two small partial eclipses of the sun, after which no more can occur until, by the annual revolution of the earth, the direction of the sun approaches the opposite line of nodes EM, nearly six months later. The result is that there are in the course of any one year two "eclipse seasons" each of about one month in duration, in which at least one eclipse of the sun, or possibly two small partial eclipses, may occur. One eclipse of the moon will generally, but not always, occur during a season.

Owing to the retrograde motion of the node the direction ES of the sun returns to the node at the end of about 347 days, so that a third eclipse season may commence before the end of a year. In this way there is a possible but very rare maximum of five eclipses of the sun in a year. Owing to the motion of the line of nodes each eclipse season occurs about 19 days earlier in the year than it did the year before. Another conclusion from the greater eclipse limit for the sun than for the moon is that in the long run eclipses of the sun, as regards the earth generally, occur oftener than those of the moon. But as any eclipse of the sun is visible only from a limited region of the earth's surface, while one of the moon may be seen from an entire hemisphere, more eclipses of the moon are visible at any one place than of the sun.

If, starting with a conjunction along some line ES₁, we mark by radial lines from E the successive conjunctions year after year, we shall find that at the end of 18 years and about 11 days the 23rd conjunction will fall once more very near the line ES₁, the angle NES₁ being about 24' greater than before. Successive eclipses will then occur very nearly in the same order as they did 18 years and 11 days before. This period of recurrence has been known from remote antiquity and is called the *Saros*. What is most remarkable in this period is that in addition to the distance from the node being nearly the same as before, the longitude of the sun increases by only 11° and the distance of the moon from its perigee has changed less than 3". The result of this approach to coincidence is that the recurring eclipse will generally be of the same kind—total, annular or partial—through a number of successive periods.

To see the law of recurrence of corresponding eclipses in the successive periods let us suppose the line of conjunction ES₁ to be that at which there is a very small eclipse, visible only in high northern or southern latitudes. At the end of 18 years 11 days a second eclipse will occur along a line nearly half a degree nearer EN, the line of nodes. The successive eclipses will occur at the same interval through about ten periods, or 180 years, when the line of conjunction will pass within 11° of EN. Then the eclipse will be central, whether annular or total depending on circumstances: in the first one the central lines will pass only over the polar regions; but in successive eclipses of the series it will pass nearer and nearer to the equator until the conjunction line coincides with the node. The path of centrality will then cross in the equatorial region. During 22 or 23 more recurrences the path will continually approach to the opposite pole and finally leave the earth entirely. The entire number of central eclipses in any one series will generally be about forty-five. Then a series of continually diminishing partial eclipses will go on for about ten periods more. The whole series of eclipses will therefore extend through about sixty-five periods; and interval of time of about twelve hundred years.

Another remarkable eclipse period recurs at the end of 358 lunations. At the end of this period the line of mean conjunction ES₁ falls so near its former position relative to the node that we find each central eclipse visible in our time to be one of an unbroken series extending from the earliest historic times to the present, at intervals equal to the length of the period. The recurring eclipses in this period do not, however, have the remarkable similarity of those belonging to the Saros, but may differ to any extent, owing to the different positions of the line of conjunction with respect to the moon's perigee. Moreover, they recur alternately at the ascending and descending node. The length of the period is 10,571.95 days, or 29 Julian years less 20.3 days. Hence 18 periods make 521 years, so that at the end of this time each eclipse recurs on or about the same day of the year. As an example of this series, starting from the eclipse of Nineveh, June 15, 763 B.C., recorded on the Assyrian tablets, we find eclipses on May 27, 734 B.C., May 7, 705 B.C., and so on in an unbroken series to 1843, 1872 and 1901, the last being the 93rd of the series. Those at the ends of the 521-year intervals occurred on June 15, O.S., of each of the years 763, 242 B.C., A.D. 280, 801, 1322 and 1843. As the lunar perigee moves through 242.4° in a period, the eclipses will vary from total to annular, but at the end of 3 periods the perigee is only 7.1° in advance of its original position relative to the node. Hence in a series including every third eclipse the eclipses will be of the same character through a thousand years or more. Thus the eclipses of 1467, 1554, 1640, 1727, 1814, 1901, 1988, &c., are total.

IV. Chronological Lists of Eclipses of the Sun.

The following is a brief chronological enumeration of those total eclipses of the sun which are of interest, either from their historic celebrity or the nature of the conclusions derived from them. In numbering the years before the Christian era the astronomical nomenclature is used, in which the number of the year is one less than that used by the chronologists. The Chinese eclipses are passed over,

Notable eclipses.

owing to the generally doubtful character of the records pertaining to them.

—1069 June 20 and —1062 July 31; total eclipses recorded at Babylon.

—762, June 14; a total eclipse recorded at Nineveh. Computation from the modern tables shows that the path of totality passed about 100 m. or more north of Nineveh.

—647, April 6; total eclipse at or near Thasos, mentioned by Archilochus.

—584, May 28; the celebrated eclipse of Thales. For an account of this eclipse see THALES.

—556, May 19, the eclipse of Larissa. The modern tables show that the eclipse was not total at Larissa, and the connexion of the classical record with the eclipse is doubtful.

—430, August 3; eclipse mentioned by Thucydides, but not total by the tables.

—399, June 21; eclipse of Ennius. Totality occurred immediately after sunset at Rome. The identity of this eclipse is doubtful.

—309, August 14; eclipse of Agathocles. This eclipse would be one of the most valuable for testing the tables of the moon, but for an uncertainty as to the location of Agathocles, who, at the time of the occurrence, was at sea on a voyage from Syracuse to Carthage.

F. K. Ginzel (*Spezieller Kanon der Finsternisse*) has collected a great number of passages from classical authors supposed to refer to eclipses of the sun or moon, but the difficulty of identifying the phenomenon is frequently such as to justify great doubt as to the conclusions. In a few cases no eclipse corresponding to the description can be found by our modern table to have occurred, and in others the latitude of interpretation and the uncertainty of the date are so wide that the eclipse cannot be identified.

Of medieval eclipses we mention only the dates of those visible in England, referring for details to the works mentioned in the bibliography. The letter C following a date shows that the eclipse is mentioned in the Anglo-Saxon Chronicles. The dates in question are:—

A.D. 538, February 15, C. (partial).	A.D. 878, October 29, C.
540, June 12, C. (partial).	885, June 15.
594, July 23.	1023, January 24.
603, August 12.	1133, August 1, C.
639, September 3.	1140, March 20, C.
664, May 1, C.	1185, May 1, C.
733, August 14 (annular).	1191, June 23, C. (annular).
764, June 4 (annular).	1330, July 16.

Besides these, the tables show that the shadow of the moon passed over some part of the British Islands on 1424, June 26; 1433, June 17; 1598, March 6; 1652, April 8; 1715, May 2; 1724, May 22. Of these the eclipse of 1715 is notable for the careful observations made in England, and published by Halley in the *Philosophical Transactions*. The next dates are 1927, June 29, when a barely total eclipse will be seen soon after sunrise in the northern counties near the Scottish border, and 1990, August 11, when the moon's shadow will graze England at Land's End.

We give below, in tabular form, a list of the principal total eclipses during the 19th and 20th centuries, omitting a few visible only in the extreme polar regions, and some others of which the duration is very short. The first column gives the civil date of the point on the earth's surface at which the eclipse is central at noon. The next two columns give the position of this point to the nearest degree. The fourth column shows the Greenwich astronomical time of conjunction in longitude. The next column gives the duration of the total phase at the noon-point; this is sometimes 0.1' less than the absolutely greatest duration at any point. Next is given the node near which the eclipse occurs; and then the number in the Saros. Corresponding eclipses at intervals of 18 y. 11 d. have the same number, and occur near the same node of the noon, which is indicated in the next column.

Date at Noon-Point.	Point where Central at Noon.		Greenwich M.T. of conjunction in Longitude.			Duration of Totality.	Node.	Series.	Regions Swept by Shadow.
	Lat.	Long.	d.	h.	m.				
1803, Feb. 21	11 S.	136 W.	21	9	20	4.2	Asc.	1	Pacific Ocean, Mexico.
1803, Aug. 5	38 S.	66 W.	5	4	6	1.2	Desc.	2	Pacific Ocean, Chile, Argentina.
1806, June 16	42 N.	66 W.	16	4	22	4.6	Desc.	3	New England, Atlantic, Africa.
1807, Nov. 29	11 N.	2 E.	28	23	48	1.4	Asc.	4	Central Africa, Aroelia.
1810, April 4	12 N.	154 E.	3	13	41	Ann.	5	Pacific Ocean, Borneo.	
1811, Mar. 24	39 S.	26 W.	24	2	19	3.4	Desc.	6	South Atlantic to and across South Africa.
1814, July 17	31 N.	84 E.	16	18	33	6.6	Asc.	7	Africa, Central Asia, China.
1815, July 6	88 N.	175 W.	6	11	52	3.2	Asc.	8	Polar Regions, Western Siberia.
1816, Nov. 19	43 N.	30 E.	18	22	9	1.8	Desc.	9	Eastern Europe, Central Asia.
1817, Nov. 9	7 S.	149 E.	8	13	53	4.7	Desc.	10	Burma, Pacific Ocean.

Date at Noon-Point	Point where Central at Noon.		Greenwich M.T. of conjunction in Longitude.			Duration of Totality.	Node.	Series.	Regions Swept by Shadow.
	Lat.	Long.	d.	h.	m.				
1821, Mar. 4	8 S.	96 E.	3	17	50	4-3	Asc.	1	Indian and Pacific Oceans.
1822, Aug. 16	36 S.	176 W.	16	11	22	1-4	Desc.	2	Australia, Pacific Ocean.
1824, June 26	47 N.	175 W.	26	11	43	4-4	Desc.	3	Pacific Ocean, Japan, China.
1825, Dec. 9	9 N.	127 W.	9	8	27	1-5	Asc.	4	Pacific Ocean, Mexico.
1828, April 14	18 N.	39 E.	13	21	24	0-3	Desc.	5	Northern Africa, India.
1829, April 3	32 S.	129 W.	3	10	24	4-1	Desc.	6	South Pacific Ocean.
1832, July 27	24 N.	28 W.	27	2	2	6-8	Asc.	7	West Indies and across Central Africa.
1833, July 17	78 N.	76 E.	16	19	16	3-5	Asc.	8	North-eastern Asia and Polar Regions
1834, Nov. 30	40 N.	101 W.	30	6	48	1-9	Desc.	9	Southern and Western United States.
1835, Nov. 20	10 S.	20 E.	19	22	31	4-6	Desc.	10	Central Africa, Madagascar.
1839, Mar. 15	6 S.	31 W.	15	2	14	4-4	Asc.	1	South America, Africa, Egypt.
1840, Aug. 27	34 S.	72 E.	26	18	45	1-6	Desc.	2	Africa, Madagascar, Indian Ocean.
1842, July 8	51 N.	77 E.	7	19	2	4-1	Desc.	3	Spain, France, Russia to China, and Pacific Ocean.
1843, Dec. 21	8 N.	102 E.	20	17	10	1-6	Asc.	4	Indian and North Pacific Oceans and India.
1846, April 25	25 N.	75 W.	25	4	49	0-9	Desc.	5	Mexico, West Indies, Africa.
1847, April 15	24 S.	90 E.	14	18	22	4-7	Desc.	6	Indian Ocean, Australia.
1850, Aug. 7	18 N.	142 W.	7	9	34	6-8	Asc.	7	Pacific Ocean.
1851, July 28	70 N.	34 W.	28	2	41	3-7	Asc.	8	Scandinavia, Russia and North America.
1852, Dec. 11	37 N.	127 E.	10	15	32	2-0	Desc.	9	China, Pacific Ocean.
1857, Mar. 25	4 S.	155 W.	25	10	30	4-5	Asc.	1	Pacific Ocean, Mexico.
1858, Sept. 7	33 S.	41 W.	7	2	16	1-7	Desc.	2	Peru, South Brazil, Uruguay.
1860, July 18	56 N.	31 W.	18	2	21	3-7	Desc.	3	British America, France, Egypt.
1861, Dec. 31	9 N.	29 W.	31	1	55	1-8	Asc.	4	Caribbean Sea to North Africa.
1864, May 6	32 N.	173 E.	5	12	14	1-4	Desc.	5	Pacific Ocean.
1865, April 25	16 S.	30 W.	25	2	13	5-3	Desc.	6	Brazil to Central Africa.
1868, Aug. 18	10 N.	103 E.	17	17	12	6-8	Asc.	7	India to Pacific Ocean.
1869, Aug. 7	61 N.	145 W.	7	10	8	3-8	Asc.	8	United States and Alaska.
1870, Dec. 22	36 N.	5 W.	22	0	19	2-1	Desc.	9	Gibraltar, Northern Africa, Sicily.
1871, Dec. 12	2 S.	118 E.	11	16	2	4-4	Desc.	10	Southern India, Northern Australia.
1875, April 6	2 S.	88 E.	5	18	36	4-7	Asc.	1	Indian Ocean, Siam, Pacific.
1876, Sept. 17	33 S.	156 W.	17	9	54	1-8	Desc.	2	Pacific Ocean.
1878, July 29	60 N.	139 W.	29	9	40	3-2	Desc.	3	United States and Canada.
1880, Jan. 11	10 N.	160 W.	11	10	40	2-1	Asc.	4	Pacific Ocean, California.
1882, May 17	39 N.	63 E.	16	19	34	1-8	Desc.	5	Egypt, Central Asia, China.
1883, May 6	3 N.	147 W.	6	9	58	6-0	Desc.	6	Pacific Ocean, Caroline Islands.
1886, Aug. 29	9 S.	14 W.	29	0	54	6-6	Asc.	7	South America, Central Africa.
1887, Aug. 19	53 N.	102 E.	18	17	39	3-8	Asc.	8	Northern Europe, Siberia, Japan.
1889, Jan. 1	37 N.	138 W.	1	9	8	2-2	Desc.	9	Central Africa, British America.
1889, Dec. 22	12 S.	13 W.	22	0	52	4-2	Desc.	10	Central Africa and South America.
1893, April 16	1 S.	37 W.	16	2	35	4-8	Asc.	1	Venezuela to West Africa.
1894, Sept. 29	34 S.	86 E.	28	17	43	1-8	Desc.	2	East Africa, Indian Ocean.
1896, Aug. 9	65 N.	112 E.	8	17	2	2-7	Desc.	3	North Europe, Siberia, Japan.
1898, Jan. 22	13 N.	69 E.	21	19	24	2-3	Asc.	4	East Africa, India, China.
1900, May 28	45 N.	45 W.	28	2	50	2-1	Desc.	5	United States, Spain, North Africa.
1901, May 18	2 S.	97 E.	17	17	38	6-5	Desc.	6	Sumatra, Borneo.
1904, Sept. 9	5 S.	133 W.	9	8	43	6-4	Asc.	7	Pacific Ocean.
1905, Aug. 30	45 N.	12 W.	30	1	13	3-8	Asc.	8	Canada, Spain, North Africa.
1907, Jan. 14	39 N.	89 E.	13	17	57	2-3	Desc.	9	Russia, Central Asia.
1908, Jan. 3	12 S.	145 W.	3	9	44	4-2	Desc.	10	Pacific Ocean.
1911, April 28	1 S.	155 W.	28	10	26	5-0	Asc.	1	Australia, Polynesia.
1912, Oct. 10	35 S.	33 W.	10	1	41	1-8	Desc.	2	Colombia, Ecuador, Brazil.
1914, Aug. 21	71 N.	2 E.	21	0	27	2-1	Desc.	3	Scandinavia, Russia, Asia Minor.
1916, Feb. 3	16 N.	62 W.	3	4	6	2-5	Asc.	4	Pacific Ocean, Venezuela, West Indies.
1918, June 8	51 N.	152 W.	8	10	3	2-4	Desc.	5	British Columbia, United States.
1919, May 29	4 N.	18 W.	29	1	12	6-9	Desc.	6	Peru, Brazil, Central Africa.
1922, Sept. 21	12 S.	106 E.	20	16	38	6-1	Asc.	7	East Africa, Australia.
1923, Sept. 10	38 N.	128 W.	10	8	53	3-6	Asc.	8	California, Mexico, Central America.
1925, Jan. 24	42 N.	44 W.	24	2	46	2-4	Desc.	9	United States.
1926, Jan. 14	10 S.	82 E.	13	18	35	4-2	Desc.	10	East Africa, Sumatra, Philippines.
1927, June 29	78 N.	86 E.	28	18	32	0-7	Asc.	11	England, Scotland, Scandinavia.
1929, May 9	1 S.	86 W.	8	18	8	5-1	Asc.	1	Sumatra, Malacca, Philippines.
1930, Oct. 21	36 S.	153 W.	21	9	47	1-9	Desc.	2	Pacific Ocean, Patagonia.
1932, Aug. 31	78 N.	109 W.	31	7	55	2-7	Desc.	3	Canada.
1934, Feb. 14	19 N.	168 E.	13	12	44	2-5	Asc.	4	Borneo, Celebes.
1936, June 18	56 N.	101 E.	18	17	15	2-7	Desc.	5	Greece to Central Asia and Japan.
1937, June 8	10 N.	131 W.	8	8	43	7-1	Desc.	6	Pacific Ocean, Peru.
1940, Oct. 1	19 S.	16 W.	1	0	42	5-7	Asc.	7	Colombia, Brazil, South Africa.
1941, Sept. 21	30 N.	114 E.	20	16	39	3-3	Asc.	8	Central Asia, China, Pacific Ocean.
1943, Feb. 4	47 N.	176 W.	4	11	31	2-5	Desc.	9	China, Alaska.
1947, May 20	2 S.	25 W.	20	1	44	5-2	Asc.	1	Argentina, Paraguay, Central Africa.
1948, Nov. 1	37 S.	82 E.	31	18	3	1-9	Desc.	2	Central Africa, Congo.
1952, Feb. 25	22 N.	39 E.	24	21	17	3-0	Asc.	4	Nubia, Persia, Siberia.
1954, June 30	62 N.	5 W.	30	0	27	2-5	Desc.	5	Canada, Scandinavia, Russia, Persia.
1955, June 20	15 N.	117 E.	19	16	12	7-3	Desc.	6	Ceylon, Siam, Philippines.
1958, Oct. 12	26 S.	139 W.	12	8	52	5-2	Asc.	7	Chile, Argentina.
1959, Oct. 2	23 N.	6 W.	2	0	32	3-0	Asc.	8	Canaries, Central Africa.
1961, Feb. 15	53 N.	53 E.	14	20	11	2-6	Desc.	9	France, Italy, Austria, Siberia.
1962, Feb. 5	4 S.	179 E.	4	12	11	4-1	Desc.	10	New Guinea.
1963, July 20	62 N.	126 W.	20	8	43	1-5	Asc.	11	Alaska, Hudson's Bay Territory.
1965, May 30	4 S.	137 W.	30	9	14	5-3	Asc.	1	Pacific Ocean.
1966, Nov. 12	38 S.	43 W.	12	2	27	1-9	Desc.	2	Bolivia, Argentina, Brazil.
1970, Mar. 7	25 N.	88 W.	7	5	43	3-3	Asc.	4	Mexico, Georgia, ? Florida.

Date at Noon-Point.	Point where Central at Noon.		Greenwich M.T. of conjunction in Longitude.			Duration of Totality.	Node.	Series.	Regions Swept by Shadow.
	Lat.	Long.	d.	h.	m.				
1972, July 10	67 N.	111 W.	10	7	40	2-7	Desc.	5	North-East Asia, North-East America and Atlantic Ocean.
1973, June 30	19 N.	6 E.	29	23	39	7-2	Desc.	6	South America, Africa and Atlantic Ocean.
1974, June 20	32 S.	107 E.	19	16	56	5-3	Desc.	12	South-West Australia and Indian Ocean.
1976, Oct. 23	31 S.	95 E.	22	17	10	4-9	Asc.	7	Africa, Australia, Indian and Pacific Oceans.
1977, Oct. 12	16 N.	127 W.	12	8	31	2-8	Asc.	8	Venezuela, Pacific Ocean.
1979, Feb. 26	61 N.	77 W.	26	4	47	2-7	Desc.	9	United States, British America, Pacific Ocean, N. Polar Sea
1980, Feb. 16	1 N.	48 E.	15	20	52	4-3	Desc.	10	Africa, Atlantic and Indian Oceans, and India.
1981, July 31	54 N.	127 E.	30	15	53	2-2	Asc.	11	Pacific Ocean, Asia.
1983, June 11	7 S.	111 E.	10	16	38	5-4	Asc.	1	Java, Atlantic Ocean.
1984, Nov. 22	39 S.	170 W.	22	10	58	2-1	Desc.	2	Pacific Ocean, Patagonia.
1987, Mar. 29	17 S.	6 W.	29	0	45	0-3	Asc.	13	Atlantic, Equatorial Africa.
1988, Mar. 18	28 N.	146 E.	17	14	3	4-0	Asc.	4	Indian and Pacific Oceans, Sumatra.
1990, July 22	72 N.	142 E.	21	14	54	2-6	Desc.	4	Finland, North Atlantic.
1991, July 11	22 N.	105 W.	11	7	6	7-1	Desc.	5	Pacific Ocean, Hawaii, Central America.
1992, June 30	26 S.	5 W.	30	7	19	5-4	Desc.	12	South Atlantic.
1994, Nov. 3	36 S.	31 W.	3	1	36	4-6	Asc.	7	Pacific Ocean, South America.
1995, Oct. 24	10 N.	110 E.	23	16	37	2-4	Asc.	8	Pacific and Indian Oceans.
1997, Mar. 9	71 N.	154 E.	8	13	16	2-8	Desc.	9	North-East Asia, Arctic Sea.
1998, Feb. 26	6 N.	81 W.	26	5	27	4-4	Desc.	10	Pacific and Atlantic Oceans, Central America.
1999, Aug. 11	46 N.	18 E.	10	23	8	2-6	Asc.	11	Central and Southern Europe touching England.

Recurrence of Remarkable Eclipses.

From the propriety of the Saros it follows that eclipses remarkable for their duration, or other circumstances depending on the relative positions of the sun and moon, occur at intervals of one saros (18 y. 11 d.). Of interest in this connexion is the recurrence of total eclipses remarkable for their duration. The absolute maximum duration of a total eclipse is about $7^{\circ} 30'$; but no actual eclipse can be expected to reach this duration. Those which will come nearest to the maximum during the next 500 years belong to the series numbered 4 and 6 and in the list which precedes. These occurring in the years 1937, 1955, &c., will ultimately fall little more than $20'$ below the maximum. But the series 4, though not now remarkable in this respect, will become so in the future, reaching in the eclipse of June 25, 2150, a duration of about $7^{\circ} 15'$ and on July 5, 2168, a duration of $7^{\circ} 28'$, the longest in human history. The first of these will pass over the Pacific Ocean; the second over the southern part of the Indian Ocean near Madras.

All the national annual Ephemerides contain elements of the eclipses of the sun occurring during the year. Those of England, America and France also give maps showing the path of the central line, if any, over the earth's surface; the lines of eclipse beginning and ending at sunrise, &c., and the outlines of the shadow from hour to hour. By the aid of the latter the time at which an eclipse begins or ends at any point can be determined by inspection or measurement within a few minutes.

V. Methods of computing Eclipses of the Sun.

The complete computation of the circumstances of an eclipse *ab initio* requires three distinct processes. The geocentric positions of the sun and moon have first to be computed from the tables of the motions of those bodies. The second step is to compute certain elements of the eclipse from these geocentric positions. The third step is from these elements to compute the circumstances of the eclipse for the earth generally or for any given place on its surface. The national Astronomical Ephemerides, or "Nautical Almanacs," give in full the geocentric positions of the sun and moon from at least the early part of the 19th century to an epoch three years in advance of the date of publication. It is therefore unnecessary to undertake the first part of the computation except for dates outside the limits of the published ephemerides, and for many years to come even this computation will be unnecessary, because tables giving the elements of eclipses from the earliest historic periods up to the 22nd century have been published by T. Ritter von Oppolzer and by Simon Newcomb. We shall therefore confine ourselves to a statement of the eclipse problem and of the principles on which such tables rest.

Two systems of eclipse elements are now adopted in the ephemerides and tables; the one, that of F. W. Bessel, is used in the English, American and French ephemerides, the other—P. A. Hansen's—in the German and in the eclipse tables of T. Ritter von Oppolzer. The two have in common certain geometric constructions. The fundamental axis of reference in both systems is the line passing through the centres of the sun and moon; this is the common axis of the shadow cones, which envelop simultaneously the sun and moon as shown in figs. 1, 2, 3. The surface of one of these cones, that of the umbra, is tangent to both bodies externally. This cone comes to a point at a distance from the moon nearly equal to that of the earth. Within it the sun is wholly hidden by the moon. Outside the umbral cone is that of the penumbra, within which the sun is partially hidden by the moon. The geometric condition that the two bodies shall appear in contact, or that the eclipse shall begin or end at a certain moment, is that the surface of one of these cones shall pass through the place of the observer at that moment. Let a plane, which we call the fundamental plane, pass through the centre of the earth perpendicular to the shadow axis. On this plane the centre of the earth is taken as an origin of rectangular co-ordinates. The axis of Z is perpendicular to the plane, and therefore parallel to the shadow axis; that of Y and X lie in the plane. In these fundamental constructions the two methods coincide. They differ in the direction of the axis of Y and X in the fundamental plane. In Bessel's method, which we shall first describe, the intersection of the plane of the earth's equator with the fundamental plane is taken as the axis of X. The axis of Y is perpendicular to it, the positive direction being towards the north. The Besselian elements of an eclipse are then: x, y , the co-ordinates of the shadow axis on the fundamental plane; d , the declination of that point in which the shadow axis intersects the celestial sphere; μ , the Greenwich hour angle of this point; l , the radius of the circle, in which the penumbral or outer cone intersects the fundamental plane; and f , the radius of the circle, in which the inner or umbral cone intersects this plane, taken positively when the vertex of the cone does not reach the plane, so that the axis must be produced, and negatively when the vertex is beyond the plane.

Hansen's method differs from that of Bessel in that the ecliptic is taken as the fundamental plane instead of the equator. The axis of X on the fundamental plane is parallel to the plane of the ecliptic; that of Y perpendicular to it. The other elements are nearly the same in the two theories. As to their relative advantages, it may be remarked that Hansen's co-ordinates follow most simply from the data of the tables, and are necessarily used in eclipse tables, but that the subsequent computation is simpler by Bessel's method.

Several problems are involved in the complete computation

of an eclipse from the elements. First, from the values of the latter at a given moment to determine the point, if any, at which the shadow-axis intersects the surface of the earth, and the respective outlines of the umbra and penumbra on that surface. Within the umbral curve the eclipse is annular or total; outside of it and within the penumbral curve the eclipse is partial at the given moment. The penumbral line is marked from hour to hour on the maps given annually in the American Ephemeris. Second, a series of positions of the central point through the course of an eclipse gives us the path of the central point along the surface of the earth, and the envelopes of the penumbral and umbral curves just described are boundaries within which a total, annular or partial eclipse will be visible. In particular, we have a certain definite point on the earth's surface on which the edge of the shadow first impinges; this impingement necessarily takes place at sunrise. Then passing from this point, we have a series of points on the surface at which the elements of the shadow-cone are in succession tangent to the earth's surface. At all these points the eclipse begins at sunrise until a certain limit is reached, after which, following the successive elements, it ends at sunrise. At the limiting point the rim of the moon merely grazes that of the sun at sunrise, so that we may say that the eclipse both begins and ends at that time. Of course the points we have described are also found at the ending of the eclipse. There is a certain moment at which the shadow-axis leaves the earth at a certain point, and a series of moments when, the elements of the penumbral cone being tangent to the earth's surface, the eclipse is ending at sunset. Three cases may arise in studying the passage of the outlines of the shadow over the earth. It may be that all the elements of the penumbral cone intersect the earth. In this case we shall have both a northern and a southern limit of partial eclipse. In the second case there will be no limit on the one side except that of the eclipse beginning or ending at sunrise or sunset. Or it may happen, as the third case, that the shadow-axis does not intersect the earth at all; the eclipse will then not be central at any point, but at most only partial.

The third problem is, from the same data, to find the circumstances of an eclipse at a given place—especially the times of beginning and ending, or the relative positions of the sun and moon at a given moment. Reference to the formulæ for all these problems will be given in the bibliography of the subject.

AUTHORITIES.—The richest mine of information respecting eclipses of the sun and moon is T. R. von Oppolzer's "Kanon der Finsternisse," published by the Vienna Academy of Sciences in the 52nd volume of its *Denkschriften* (Vienna, 1887). It contains elements of all eclipses both of the sun and moon, from 1207 B.C. to A.D. 2161, a period of more than thirty centuries. Appended to the tables is a series of charts showing the paths of all central eclipses visible in the northern hemisphere during the period covered by the table. The points of the path at which the eclipse occurs, at sunrise, noon and sunset, are laid down with precision, but the intermediate points are frequently in error by several hundred miles, as they were not calculated, but projected simply by drawing a circle through the three points just mentioned. For this reason we cannot infer from them that an eclipse was total at any given place. The correct path can, however, be readily computed from the tables given in the work. Eduard Mahler's memoir, "Die centralen Sonnenfinsternisse des 20. Jahrhunderts" (*Denkschriften*, Vienna Academy, vol. xlix.), gives more exact paths of the central eclipses of the 20th century, but no maps. General tables for computing eclipses are Oppolzer's "Syzzygientafeln für den Mond" (*Publications of the Astronomische Gesellschaft*, xvi.), and Newcomb's, in *Publications of the American Ephemeris*, vol. i. part i. Of these, Oppolzer's are constructed with greater numerical accuracy and detail, while Newcomb's are founded on more recent astronomical data, and are preferable for computing ancient eclipses. F. K. Ginzel's *Spezieller Kanon der Sonnen- und Mondfinsternisse* (Berlin, 1899) contains, besides the historical researches already mentioned, maps of the paths of central eclipses visible in the lands of classical antiquity from 900 B.C. to A.D. 500, but computed with imperfect astronomical data. Maguire, "Monthly Notices," R.A.S. xiv. and xlv., has mapped the total solar eclipses visible in the British Islands from 878 to 1724. General papers of interest on the same subject have been published by Rev. S. J. Johnson. A résumé of all the observations on the physical phenomena of total solar eclipses up to 1878, by A. C. Ranyard, is to be found in *Memoirs of the Royal Astronomical Society*, vol. xli. A very copious development of the computation of eclipses by Bessel's method is found in W. Chauvenet's *Spherical*

and *Practical Astronomy*, vol. i. *The Theory of Eclipses*, by R. Buchanan (Philadelphia, 1904), treats the subject yet more fully. Hansen's method is developed in the *Abhandlungen* of the Leipzig Academy of Sciences, vol. vi. (Math.-Phys. Klasse, vol. iv.). The formulæ of computation by this method are found in the introductions to Oppolzer's two works cited above. (S. N.)

ECLIPTIC, in astronomy. The plane of the ecliptic is that plane in or near which the centre of gravity of the earth and moon revolves round the sun. The ecliptic itself is the great circle in which this plane meets the celestial sphere. It is also defined, but not with absolute rigour, as the apparent path described by the sun around the celestial sphere as the earth performs its annual revolution. Owing to the action of the moon on the earth, as it performs its monthly revolution in an orbit slightly inclined to the ecliptic, the centre of the earth itself deviates from the plane of the ecliptic in a period equal to that of the nodal revolution of the moon. The deviation is extremely slight, its maximum amount ranging between 0.5" and 0.6". Owing to the action of the planets, especially Venus and Jupiter, on the earth, the centre of gravity of the earth and moon deviates by a yet minuter amount, generally one or two tenths of a second, from the plane of the ecliptic proper. Owing to the action of the planets, the position of the ecliptic is subject to a slow secular variation amounting, during our time, to nearly 47" per century. The rate of this motion is slowly diminishing.

The obliquity of the ecliptic is the angle which its plane makes with that of the equator. Its mean value is now about 23° 27'. The motion of the ecliptic produces a secular variation in the obliquity which is now diminishing by an amount nearly equal to the entire motion of the ecliptic itself. The laws of motion of the ecliptic and equator are stated in the article **PRECESSION OF THE EQUINOXES**.

Attempts have been made by Laplace and his successors to fix certain limits within which the obliquity of the ecliptic shall always be confined. The results thus derived are, however, based on imperfect formulæ. When the problem is considered in a rigorous form, it is found that no absolute limits can be set. It can, however, be shown that the obliquity cannot vary more than two or three degrees within a million of years of our epoch.

The formula for the obliquity of the ecliptic, as derived from the laws of motion of it and of the equator, may be developed in a series proceeding according to the ascending powers of the time as follows: we put T, the time from 1900, reckoned in solar centuries as a unit. Then,

Obliquity = 23° 27' 31.68" - 46.837" T - 0.0085" T² + 0.0017" T³.
From this expression is derived the value of the obliquity at various epochs given in the following table. The left-hand portion of this table gives the values for intervals of 500 years from 2000 B.C. to A.D. 2500 as computed from modern data. For dates more than three or four centuries before or after 1850 the result is necessarily uncertain by one or more tenths of a minute, and is therefore only given to 0.1".

B.C. 2000: obl. = 23° 55.5'	A.D. 1700: obl. = 23° 28' 41.91"
1500 " = 23 52.3	1750 " = 23 28 18.51
1000 " = 23 48.9	1800 " = 23 27 55.10
500 " = 23 45.4	1850 " = 23 27 31.68
0 " = 23 41.7	1900 " = 23 27 8.26
A.D. 500 " = 23 38.0	1950 " = 23 26 44.84
1000 " = 23 34.1	2000 " = 23 26 21.41
1500 " = 23 30.3	2050 " = 23 25 57.99
2000 " = 23 26.4	2100 " = 23 25 34.56
2500 " = 23 22.5	(S. N.)

ECLOGITE (from Gr. *εκλογή*, a selection), in petrology, a typical member of a small group of metamorphic rocks of special interest on account of the variety of minerals they contain and their microscopic structures and geological relationships. Typically they consist of pale green or nearly colourless augite (omphacite), green hornblende and pink garnet. Quartz also is usually present in these rocks, but feldspar is rare. The augite is mostly a variety of diopside and is only occasionally idiomorphic. The garnet sometimes forms good dodecahedra, but may occur as rounded grains, and encloses quartz, rutile, kyanite, and other minerals very frequently. The hornblende is usually pale green and feebly dichroic, but, in some eclogites which are allied to garnet-amphibolites, it is of dark brown colour. Among the commoner accessory minerals are kyanite (of blue or greyish-blue tints), rutile, biotite, epidote and zoisite, sphene, iron oxides, &c.

pyrites. The rutile is invariably in small brown prisms; the kyanite forms bladed crystals, with perfect cleavage; felspar, if present, belongs to basic varieties rich in lime. Other minerals which have been found in eclogites are bronzite, olivine and glaucophane. The last mentioned is a bright blue variety of hornblende with striking pleochroism. The eclogites in their chemical composition show close affinities to gabbros; they often exhibit relationships in the field which show that they were primarily intrusive rocks of igneous origin, and occasionally contact alteration can be traced in the adjacent schists. Examples are known in Saxony, Bavaria, Carinthia, Austria, Norway. A few eclogites also occur in the north-west highlands of Scotland. Glaucophane-eclogites have been met with in Italy and the Pennine Alps. Specimens of rock allied to eclogite have been found in the diamantiferous peridotite breccias of South Africa (the so-called "blue ground"), and this has given rise to the theory that these are the parent masses from which the Kimberley diamonds have come. (J. S. F.)

ECLOGUE, a short pastoral dialogue in verse. The word is conjectured to be derived from the Greek verb *ἐκλογέω*, to choose. An eclogue, perhaps, in its primary signification was a selected piece. Another more fantastic derivation traces it to *αἶγ*, goat, and *λόγος*, speech, and makes it a conversation of shepherds. The idea of dialogue, however, is not necessary for an eclogue, which is often not to be distinguished from the idyll. The grammarians, in giving this title to Virgil's pastoral conversations (*Bucolica*), tended to make the term "eclogue" apply exclusively to dialogue, and this has in fact been the result of the success of Virgil's work. Latin eclogues were also written by Calpurnius Siculus and by Nemesianus. In modern literature the term has lost any distinctive character which it may have possessed among the Romans; it is merged in the general notion of pastoral poetry. The French "Égloues" of J. R. de Segrais (1624-1701) were long famous, and those of the Spanish poet Garcilasso de La Vega (1503-1536) are still admired.

See also **BUCOLICS**; **PASTORAL**.

ECONOMIC ENTOMOLOGY, the name given to the study of insects based on their relation to man, his domestic animals and his crops, and, in the case of those that are injurious, of the practical methods by which they can be prevented from doing harm, or be destroyed when present. In Great Britain little attention is paid to this important branch of agricultural science, but in America and the British colonies the case is different. Nearly every state in America has its official economic entomologists, and nearly every one of the British crown colonies is provided with one or more able men who help the agricultural community to battle against the insect pests. Most, if not all, of the important knowledge of remedies comes from America, where this subject reaches the highest perfection; even the life-histories of some of the British pests have been traced out in the United States and British colonies more completely than at home, from the creatures that have been introduced from Europe.

Some idea of the importance of this subject may be gained from the following figures. The estimated loss by the vine *Phylloxera* in the Gironde alone was £32,000,000; for all the French wine districts £100,000,000 would not cover the damage. It has been stated on good evidence that a loss of £7,000,000 per annum was caused by the attack of the ox warble fly on cattle in England alone. In a single season Aberdeenshire suffered nearly £90,000 worth of damage owing to the ravages of the diamond back moth on the root crops; in New York state the codling moth caused a loss of \$3,000,000 to apple-growers. Yet these figures are nothing compared to the losses due to scale insects, locusts and other pests.

The most able exponent of this subject in Great Britain was John Curtis, whose treatise on *Farm Insects*, published in 1860, is still the standard British work dealing with the insect foes of corn, roots, grass and stored corn. The most important works dealing with fruit and other pests come from the pens of Saunders, Lintner, Riley, Slingerland and others in America and Canada, and from Taschenberg, Lampa, Reuter and Kollar in Europe, and from French, Froggatt and Tryon in Australia. It was not until the last quarter of the 19th century that any real advance was made in the study of economic entomology. Among the early writings, besides the book

of Curtis, there may also be mentioned a still useful little publication by Pohl and Kollar, entitled *Insects Injurious to Gardeners, Foresters and Farmers*, published in 1837, and Taschenberg's *Praktische Insektenkunde*. American literature began as far back as 1788, when a report on the Hessian fly was issued by Sir Joseph Banks; in 1817 Say began his writings; while in 1856 Asa Fitch started his report on the "Noxious Insects of New York." Since that date the literature has largely increased. Among the most important reports, &c., may be mentioned those of C. V. Riley, published by the U.S. Department of Agriculture, extending from 1878 to his death, in which is embodied an enormous amount of valuable matter. At his death the work fell to Professor L. O. Howard, who constantly issues brochures of equal value in the form of Bulletins of the U.S. Department of Agriculture. The chief writings of J. A. Lintner extend from 1882 to 1898, in yearly parts, under the title of *Reports on the Injurious Insects of the State of New York*. Another author whose writings rank high on this subject is M. V. Slingerland, whose investigations are published by Cornell University. Among other Americans who have largely increased the literature and knowledge must be mentioned F. M. Webster and E. P. Felt. In 1883 appeared a work on fruit pests by William Saunders, which mainly applies to the American continent; and another small book on the same subject was published in 1898 by Miss Ormerod, dealing with the British pests. In Australia Tryon published a work on the *Insect and Fungus Enemies of Queensland* in 1899. Many other papers and reports are being issued from Australia, notably by Froggatt in New South Wales. At the Cape excellent works and papers are prepared and issued by the government entomologist, Dr Lounsbury, under the auspices of the Agricultural Department; while from India we have Cotes's *Notes on Economic Entomology*, published by the Indian Museum in 1888, and other works, especially on tea pests.

Injurious insects occur among the following orders: *Coleoptera*, *Hymenoptera*, *Lepidoptera*, *Diptera*, *Hemiptera* (both *heteroptera* and *homoptera*), *Orthoptera*, *Neuroptera* and *Thysanoptera*. The order *Aptra* also contains a few injurious species.

Among the *Coleoptera* or beetles there is a group of world-wide pests, the *Elateridae* or click beetles, the adults of the various "wireworms." The insects in the larval or wireworm stage attack the roots of plants, eating them away below the ground. The eggs deposited by the beetle in the ground develop into yellowish-brown wire-like grubs with six legs on the first three segments and a ventral prominence on the anal segment. The life of these subterranean pests differs in the various species; some undoubtedly (*Agriotes lineatum*) live for three or four years, during the greater part of which time they gnaw away at the roots of plants, carrying wholesale destruction before them. When mature they pass deep into the ground and pupate, appearing after a few months as the click beetles (fig. 1). Most crops are

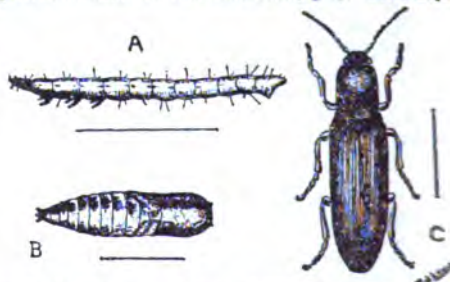

FIG. 1.—A, Wireworm; B, pupa of Click Beetle; C, adult Click Beetle (*Agriotes lineatum*).

attacked by them, but they are particularly destructive to wheat and other cereals. With such subterranean pests little can be done beyond rolling the land to keep it firm, and thus preventing them from moving rapidly from plant to plant. A few crops, such as mustard, seem deleterious to them. By growing mustard and ploughing it in green the ground is made obnoxious to the wireworms, and may even be cleared of them. For root-feeders, bisulphide of carbon injected into the soil is of particular value. One ounce injected about 2 ft. from an apple tree on two sides has been found to destroy all the ground form of the woolly aphis. In garden cultivation it is most useful for wireworm, used at the rate of 1 ounce to every 4 sq. yds. It kills all root pests.

In Great Britain the flea beetles (*Halticidae*) are one of the most serious enemies; one of these, the turnip flea (*Phyllotreta nemorum*), has in some years, notably 1881, caused more than £500,000 loss in England and Scotland alone by eating the young seedling turnips, cabbage and other *Cruciferae*. In some years three or four sowings have to be made before a "plant" is produced, enormous loss in labour and cost of seed alone being thus involved. These beetles, characterized by their skipping movements and enlarged hind femora, also attack the hop (*Haltica concinna*), the vine in America (*Graploderia chalybea*, Illig.), and numerous other species of plants, being especially harmful to seedlings and young growth. Soaking the seed in strong-smelling substances, such as paraffin and turpentine, has been found efficacious, and in some districts paraffin sprayed over the seedlings has been practised with decided success. This oil generally acts as an excellent preventive of this and other insect attacks.

In all climates fruit and forest trees suffer from weevils or *Curculionidae*. The plum curculio (*Conotrachelus nenuphar*, Herbst) in America causes endless harm in plum orchards; curculios in Australia ravage the vines and fruit trees (*Orthorhinus klugii*, Schon, and *Leptops hopei*, Bohm, &c.). In Europe a number of "long-snouted" beetles, such as the raspberry weevils (*Otiorynchus picipes*), the apple blossom weevil (*Anthonomus pomorum*), attack fruit; others, as the "corn weevils" (*Calandra oryzae* and *C. granaria*), attack stored rice and corn; while others produce swollen patches on roots (*Ceutorhynchus sulcicollis*), &c. All these *Curculionidae* are very timid creatures, falling to the ground at the least shock. This habit can be used as a means of killing them, by placing boards or sacks covered with tar below the trees, which are then gently shaken. As many of these beetles are nocturnal, this trapping should take place at night. Larval "weevils" mostly feed on the roots of plants, but some, such as the nut weevil (*Balaninus nucum*), live as larvae inside fruit. Seeds of various plants are also attacked by weevils of the family *Bruchidae*, especially beans and peas. These seed-feeders may be killed in the seeds by subjecting them to the fumes of bisulphide of carbon. The corn weevils (*Calandra granaria* and *C. oryzae*) are now found all over the world, in many cases rendering whole cargoes of corn useless.

The most important Hymenopterous pests are the sawflies or *Tenthredinidae*, which in their larval stage attack almost all vegetation. The larvae of these are usually spoken of as "false caterpillars," on account of their resemblance to the larvae of a moth. They are most ravenous feeders, stripping bushes and trees completely of their foliage, and even fruit. Sawfly larvae can at once be recognized by the curious positions they assume, and by the number of pro-legs, which exceeds ten. The female lays her eggs in a slit made by means of her "saw-like" ovipositor in the leaf or fruit of a tree. The pupae in most of these pests are found in an earthen cocoon beneath the ground, or in some cases above ground (*Lophyrus pini*). One species, the slugworm (*Eriocampa limacina*), is common to Europe and America; the larva is a curious slug-like creature, found on the upper surface of the leaves of the pear and cherry, which secretes a slimy coating from its skin. Currant and gooseberry are also attacked by sawfly larvae (*Nematus ribesii* and *N. ventricosus*) both in Europe and America. Other species attack the stalks of grasses and corn (*Cephus pygmaeus*). Forest trees also suffer from their ravages, especially the conifers (*Lophyrus pini*). Another group of Hymenoptera occasionally causes much harm in fir plantations, namely, the *Stricidae* or wood-wasps, whose larvae burrow into the trunks of the trees and thus kill them. For all exposed sawfly larvae hellebore washes are most fatal, but they must not be used over ripe or ripening fruit, as the hellebore is poisonous.

The order Diptera contains a host of serious pests. These two-winged insects attack all kinds of plants, and also animals in their larval stage. Many of the adults are bloodsuckers (*Tabanidae*, *Culicidae*, &c.); others are parasitic in their larval stage (*Oestridae*, &c.). The best-known dipterous pests are the Hessian fly (*Cecidomyia destructor*), the pear midge (*Diplosis pyriwora*), the fruit flies (*Tephritis Tyroni* of Queensland and

Halterophora capitata or the Mediterranean fruit fly), the onion fly (*Phorbia cepetorum*), and numerous corn pests, such as the gout fly (*Chlorops laeniopus*) and the frit fly (*Oscinia friti*). Animals suffer from the ravages of bot flies (*Oestridae*) and gad flies (*Tabanidae*); while the tsetse disease is due to the tsetse fly (*Glossina morsitans*), carrying the protozoa that cause the disease from one horse to another. Other flies act as disease-carriers, including the mosquitoes (*Anopheles*), which not only carry malarial germs, but also form a secondary host for these parasites. Hundreds of acres of wheat are lost annually in America by the ravages of the Hessian fly; the fruit flies of Australia and South Africa cause much loss to orange and citron growers, often making it necessary to cover the trees in muslin tents for protection. Of animal pests the ox warbles (*Hypoderma lineato* and *H. bovis*) are the most important (see fig. 2). The "bots" or larvae of these flies live under the skin of cattle, producing large swollen lumps—"warbles"—in which the "bots" mature (fig. 2). These parasites damage the hide,

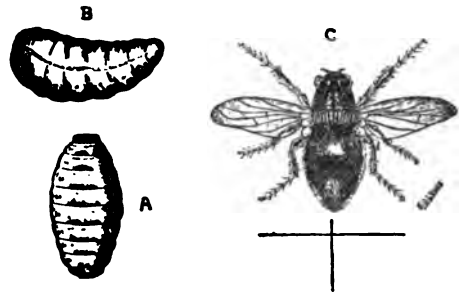

FIG. 2.—A, Ox Bot Maggot; B, puparium; C, Ox Warble Fly (*Hypoderma bovis*).

set up inflammation, and cause immense loss to farmers, herdsmen and butchers. The universal attack that has been made upon this pest has, however, largely decreased its numbers. In America cattle suffer much from the horn fly (*Haematobia serrata*). The dipterous garden pests, such as the onion fly, carrot fly and celery fly, can best be kept in check by the use of paraffin emulsions and the treatment of the soil with gas-lime after the crop is lifted. Cereal pests can only be treated by general cleanliness and good farming, and of course they are largely kept down by the rotation of crops.

Lepidopterous enemies are numerous all over the world. Fruit suffers much from the larvae of the *Geometridae*, the so-called "looper-larvae" or "canker-worms." Of these geometers the winter moth (*Cheimatobia brumata*) is one of the chief culprits in Europe (fig. 3). The females in this moth and in others allied to it are wingless. These insects pass the pupal stage in the ground, and reach the boughs to lay their eggs by crawling up the trunks of the trees. To check them, "grease-banding" round the trees has been adopted; but as many other pests eat the leafage, it is best to kill all at once by spraying with arsenical poisons. Among other notable Lepidopterous pests are the "surface larvae" or cutworms (*Agrotis spp.*), the caterpillars of various Noctuae; the codling moth (*Carpocapsa pomonella*), which causes the maggot in apples, has now become a universal pest, having spread from Europe to America and to most of the British Colonies. In many years quite half the apple crop is lost in England owing to the larvae destroying the fruit. Sugar-canes suffer from the sugarcane borer (*Diatioa sacchari*) in the West Indies, tobacco from the larvae of hawk moths (*Sphinxidae*) in America; corn and grass from various Lepidopterous pests all over the world. Nor are stored goods exempt, for much loss annually takes



FIG. 3.—Looper-larva of Winter Moth (*Cheimatobia brumata*).

place in corn and flour from the presence of the larvae of the Mediterranean flour moth (*Ephesia kühniella*); while furs and clothes are often ruined by the clothes moth (*Tinea trapezella*).

By far the most destructive insects in warm climates belong to the Hemiptera, especially to the *Coccidae* or scale insects. All fruit and forest trees suffer from these curious insects, which in the female sex always remain apterous and apodal and live attached to the bark, leaf and fruit. hidden beneath variously formed scale-like coverings. The male scales differ in form from the female; the adult male is winged, and is rarely seen. The female lays her eggs beneath the scaly covering, from which hatch out little active six-legged larvae, which wander about and soon begin to form a new scale. The *Coccidae* can, and mainly do, breed asexually (parthenogenetically). One of the most important is the San José scale (*Aspidiotus perniciosus*), which in warm climates attacks all fruit and many other trees, which, if unmolested, it will soon kill (fig. 4). These scales breed very rapidly; Howard states one may give rise to a progeny of 3,216,080,400 in one year. Other scale insects of note are the cosmopolitan mussel scale (*Mytilaspis pomorum*) and the Australian *Icerya purchasi*. The former attacks apple and pear; the latter, which selects orange and citron, was introduced into America from Australia, and carried ruin before it in some orange districts until its natural enemy, the lady-bird beetle, *Vedalia cardinalis*, was also imported.

After the *Coccidae* the next most important insects economically are the plant lice or *Aphididae*. These breed with great rapidity under favourable conditions: one by the end of the year will be accountable, according to Linnaeus, for the enormous number of a quintillion of its species. Aphides are born, as a rule, alive, and the young soon commence to reproduce again. Their food consists mainly of the sap obtained from the leaves and blossom of plants, but some also live on the roots of plants (*Phylloxera vastatrix* and *Schisonoura lanigera*). Aphides often ruin whole crops of fruit, corn, hops, &c., by sucking out the sap, and not only check growth, but may even entail the death of the plant. Reproduction is mainly asexual, the females producing living young without the agency of a male. Males in nearly all species appear once a year, when the last female generation, the ovigerous generation, is fertilized, and a few large ova are produced to carry on the continuity of the species over the winter. Some aphides live only on one species of plant, others on two or more plants. An example of the latter is seen in the hop aphid

in patches from old apple trees, where the insects live in the rough bark and form cankered growths both above and below ground. Aphides are provided with a mealy skin, which does not allow water to be attached to it, and thus insecticides for destroying them contain soft soap, which fixes the solution to the skin; paraffin is added to corrode the skin, and the

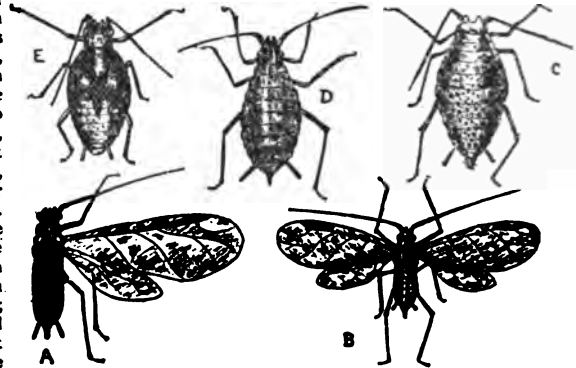

FIG. 5.—The Hop Aphid (*Phorodon humuli*). A, Winged female; B, winged male; C, ovigerous wingless female; D, viviparous wingless female from plum; E, pupal stage.

soft soap blocks up the breathing pores and so produces asphyxiation.

Amongst *Orthoptera* we find many noxious insects, notably the locusts, which travel in vast cloud-like armies, clearing the whole country before them of all vegetable life. The most destructive locust is the migratory locust (*Locusta migratoria*), which causes wholesale destruction in the East. Large pits are dug across the line of advance of these great insect armies to stop them when in the larval or wingless stage, and even huge bonfires are lighted to check their flight when adult. So dense are these "locust clouds" that they sometimes quite darken the air. The commonest and most widely distributed migratory locust is *Pachysylus cinerascens*. The mole cricket (*Cryllotalpa vulgaris*) and various cockroaches (*Blattidae*) are also amongst the pests found in this order.

Of *Neuroptera* there are but few injurious species, and many, such as the lace wing flies (*Hemerobiidae*), are beneficial.

The Treatment of Insect Pests.—One of the most important ways of keeping insect pests in check is by "spraying" or "washing." This method has made great advances in recent years. All the pioneer work has been done in America; in fact, until the South-Eastern Agricultural College undertook the elucidation of this subject, little was known of it in England except by a few growers. The results and history of this essential method of treatment are embodied in Professor Lodemann's work on the *Spraying of Plants*, 1896. In this treatment we have to bear in mind what the entomologist teaches us, that is, the nature, habits and structure of the pest.

For insects provided with a biting mouth, which take nourishment from the whole leaf, shoot or fruit, the poisonous washes used are chiefly arsenical. The two most useful arsenical sprays are Paris green and arsenate of lead. To make the former, mix 1 oz. of the Paris green with 15 gallons of soft water, and add 2 oz. of lime and a small quantity of agricultural treacle; the latter is prepared by dissolving 3 oz. of acetate of lead in a little water, then 1 oz. of arsenate of soda in water and mixing the two well together, and adding the whole to 16 gallons of soft water; to this is added a small quantity of coarse treacle. For piercing-mouthed pests like *Aphides* no wash is of use unless it contains a basis of soft soap. This soft-soap wash kills by contact, and may be prepared in the following way:—Dissolve 6 to 8 lb of the best soft soap in boiling soft water and while still hot (but of course taken off the fire) add 1 gallon of

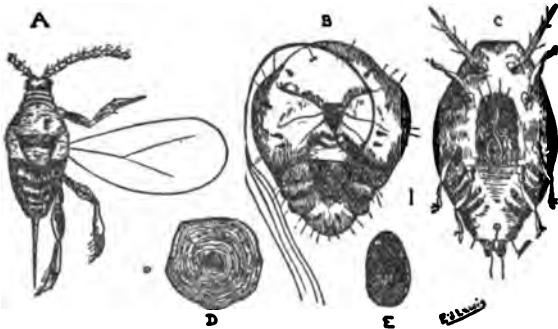

FIG. 4.—San José Scale (*Aspidiotus perniciosus*). A, Male scale insect; B, female; C, larva; D, female scale; E, male scale.

(*Phorodon humuli*), which passes the winter and lives on the sloe and damson in the egg stage until the middle of May or later, and then flies off to the hops, where it causes endless harm all the summer (fig. 5); it flies back to the prunes to lay its eggs when the hops are ripe. Another aphid of importance is the woolly aphid (*Schisonoura lanigera*) of the apple and pear: it secretes tufts of white flocculent wool often to be seen hanging

paraffin oil and churn well together with a force-pump; the whole may then be mixed with 100 gallons of soft water. The oil readily separates from the water, and thus a perfect emulsion is not obtained; this difficulty has been solved by Mr Cousin's paraffin naphthalene wash, which is patented, but can be made for private use. It is prepared as follows:—Soft soap, 6 lb dissolved in 1 quart of water; naphthalene, 10 oz. mixed with $\frac{1}{2}$ pint of paraffin; the whole is mixed together. When required for use, 1 lb of the compound is dissolved in 5 to 10 gallons of warm water.

These two washes are essential to the well-being of every orchard in all climates. Not only can we now destroy larval and adult insects, but we can also attack them in the egg stage by the use of a caustic alkali wash during the winter; besides destroying the eggs of such pests as the *Psyllidae*, red spider, and some aphides, this also removes the vegetal encumbrances which shelter numerous other insect pests during the cold part of the year. Caustic alkali wash is prepared by dissolving 1 lb of crude potash and 1 lb of caustic soda in soft water, mixing the two solutions together, adding to them $\frac{1}{2}$ lb of soft soap, and diluting with 10 gallons of soft water when required for use. Another approved insecticide for scale insects is resin wash, which acts in two ways: first, corroding the soft scales, and second, fixing the harder scales to stop the egress of the hexapod larvae. It is prepared as follows:—First crush 8 lb of resin in a sack, and then place the resin in warm water and boil in a cauldron until thoroughly dissolved, then melt 10 lb of caustic soda in enough warm water to keep it liquid, and mix with the dissolved resin; keep stirring until the mixture assumes a clear coffee-colour, and for ten minutes afterwards; then add enough warm water to bring the whole up to 25 gallons, and well stir. Bottle this off, and when required for use dilute with three times its bulk of warm soft water, and spray over the trees in the early spring just before the buds burst. For mites (*Acari*) sulphur is the essential ingredient of a spray. Liver of sulphur has been found to be the best form, especially when mixed with a paraffin emulsion. Bud mites (*Phytoptidae*, fig. 6) are of course not affected. Sulphur wash is made by adding to every 10 gallons of warm paraffin emulsion or paraffin-naphthalene-emulsion 7 oz. of liver of sulphur, and stirring until the sulphur is well mixed. This is applied as an ordinary spray. Nursery stock should always be treated to kill scale, aphids and other pests which it may carry, by the gas treatment, particularly in the case of stock imported from a foreign climate. This treatment, both out of doors and under glass, is carried out as follows:—Cover the plants in bulk with a light gas-tight cloth, or put them in a special fumigating house, and then place 1 oz. of cyanide of potassium in lumps in a dish with water beneath the covering, and then pour 1 oz. of sulphuric acid over it (being careful not to inhale the poisonous fumes) for every 1000 cub. ft. of space beneath the cover. The gas generated, prussic acid, should be left to work for at least an hour before the stock is removed, when all forms of animal life will be destroyed.

For spraying, proper instruments must be used, by means of which the liquid is sent out over the plants in as fine a mist as possible. Numerous pumps and nozzles are now made by which this end is attained. Both horse and hand machines are employed, the former for hops and large orchards, the latter for bush fruit and gardens. In America, where trees in parks as well as orchards and gardens are treated, steam-power is sometimes used. Among the most important sprayers are the Strawon horse sprayers and

strength through the nozzle, and so to the exterior, as a fine mist; every part of the plant is thus affected.

Beneficial Insects have also to be considered in economic entomology. They are of two kinds—(1) those that help to keep down an excess of other insects by acting either as parasites

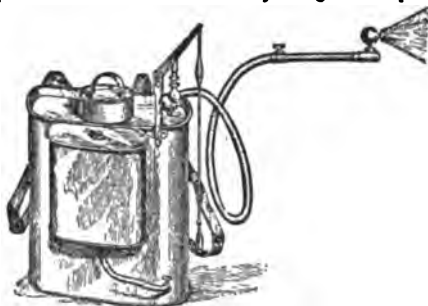

FIG. 7.—Knapsack Sprayer for Liquid Insecticides.

or by being insectivorous in habit; and (2) insects of economic value, such as the bee and silkworm. Amongst the most important friends to the farmer and gardener are the Hymenopterous families of ichneumon flies (*Ichneumonidae* and *Braconidae*); the Dipterous families *Syrphidae* and *Tachinidae*; the Coleopterous families *Coccinellidae* and *Carabidae*; and the Neuropterous *Hemeroptidae*, or lace-wing flies. Ichneumon flies lay their eggs either in the larvae or ova of other insects, and the parasites destroy their host. In this way the Hessian fly is doubtless kept in check in Europe, and the aphides meet with serious hindrance to their increase. If a number of plant-lice are examined, a few will be found looking like little pearls; these are the dried skins of those that have been killed by *Ichneumonidae*. The *Syrphidae*, or hover flies, are almost exclusively aphid-feeders in their larval stage. *Tachina* flies attack lepidopterous larvae. One of the most notable examples of the use of insect allies is the case of the Australian lady-bird, *Vedalia cardinalis*, which, in common with all lady-birds, feeds off *Aphidae* and *Coccidae*. The *Icerya* scale (*Icerya purchasi*) imported into America ruined the orange groves, but its enemy, the *Vedalia*, was also imported from Australia, and counteracted its abnormal increase with such great results that the crippled orange groves are now once more profitable. (F. V. T.)

ECONOMICS (from the Gr. οἶκος, *oikos*, sc. *oikn*, from *oikos*, a house, and *nomos*, rule,—the "art of household management"), the general term, with its synonym "political economy," for the science or study of wealth (welfare) and its production, applicable either to the individual, the family, the State, or in the widest sense, the world. How far the same considerations apply to all these spheres is one of the problems of economic thought in its widest sense. The term "economy" (*oikn*) by itself, which should strictly mean the art of applying money (or wealth) wisely, has commonly come to mean the art of saving money, or spending as little as possible. In practice the study of "political" economy is mainly devoted to the sphere of the State; the welfare of the individual as a member of the State, and of the State in its relation to the world, being internal aspects of the prosperity of the State itself. Economics thus includes the discussion of all the numerous factors which make life profitable, whether to the nation or to the business, or to the individual man. It may be conceived either as an historical science (What principles have in fact paid?), or as an abstract science (What are the true principles which must pay, presupposing an ideal?). Economists at different times have studied both aspects, according to their lights, and influenced by historical conditions of philosophic thought. A text-book on economics necessarily deals, therefore, with the whole subject in a manner which need not here be followed, since separate articles are devoted in this work to the biographies of writers on economics, and also to the principal economic

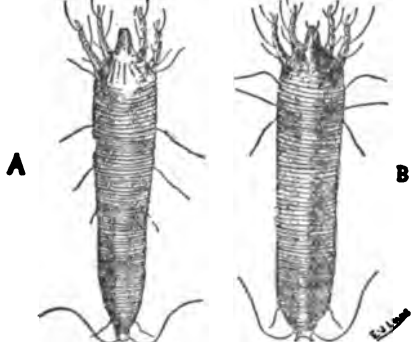

FIG. 6.—Bud Mites (*Phytoptidae*). A, Curren Bud Mite (*Phytoptus rufis*); B, Nut Bud Mite (*P. aellanae*).

the smaller *Eclair* and *Notus* knapsack pumps, carried on the back (fig. 7). The nozzles for "mistifying" the wash most in use are known as the Vermorel and Riley's, which can be fitted to any length of tubing, so as to reach any height, and can be turned in any direction. The pumps in the machine keep the insecticide constantly mixed, and at the same time force the wash with great

questions involved, under their own headings. In this article we propose therefore to confine ourselves to discussing the character and subject-matter of the science, indicating its relation to other sciences, and explaining the methods by which economists reach their conclusions.

We understand by economics the science which investigates the manner in which nations or other larger or smaller communities, and their individual members, obtain food, clothing, shelter and whatever else is considered desirable or necessary for the maintenance and improvement of the conditions of life. It is thus the study of the life of communities with special reference to one side of their activity. It necessarily involves the scientific examination of the structure and organization of the community or communities in question; their history, their customs, laws and institutions; and the relations between their members, in so far as they affect or are affected by this department of their activity.

At the root of all economic investigation lies the conception of the standard of life of the community. By this expression we do not mean an ideal mode of living, but the habits and requirements of life generally current in a community or grade of society at a given period. The standard of life of the ordinary well-to-do middle class in England, for example, includes not only food, clothing and shelter of a kind different in many respects from that of a similar class in other countries and of other classes in England, but a highly complicated mechanism, both public and private, for ministering to these primary needs, habits of social intercourse, educational and sanitary organization, recreative arrangements and many other elements. Many influences operating for a long period of time on the character and the environment of a class go to determine its standard of life. In a modern industrial community it is possible to express this standard fairly accurately for the purposes of economic investigation in terms of money (*q.s.*). But it is doubtful whether the most complete investigation would ever enable us to include all the elements of the standard of life in a money estimate. The character, tastes and capacity for management of different individuals and groups differ so widely that equal incomes do not necessarily imply identity of standard. In the investigation of past times, the incommensurate elements of well-being are so numerous that merely money estimates are frequently misleading. The conception of the standard of life involves also some estimate of the efforts and sacrifices people are prepared to make to obtain it; of their ideals and character; of the relative strength of the different motives which usually determine their conduct. But no carefully devised calculus can take the place of insight, observation and experience. The economist should be a man of wide sympathies and practical sagacity, in close touch with men of different grades, and, if possible, experienced in affairs.

It is evident that no permanent classification is possible of what is or is not of economic significance. No general rules, applicable to all times, can be laid down as to what phenomena must be examined or what may be neglected in economic inquiry. The different departments of human activity are organically connected, and all facts relating to the life of a community have a near or remote economic significance. For short historical periods, indeed, many phenomena are so remotely connected with the ordinary business of life that we may ignore them. But at any moment special causes may bring into the field of economic inquiry whole departments of life which have hitherto been legitimately ignored. In times past, biblical exegesis, religious ideals, and ecclesiastical organization, the purely political aims of statesmen, chance combinations of party politics and the intrigues of diplomatists, class prejudice, social conventions, apparently sudden changes of economic policy, capricious changes of fashion—all these causes and many others have exerted a direct and immediate influence on the economic life of the community. In our own day we have had many illustrations of the manner in which special circumstances may at once bring an almost unnoticed series of scientific investigations into direct and vital relation with the business world. The economist must, therefore,

not only be prepared to take account of the physical features of the world, the general structure and organization of the industry and commerce of different states, the character of their administration and other important causes of economic change. He must be in touch with the actual life of the community he is studying, and cultivate "that openness and alertness of the mind, that sensitiveness of the judgment, which can rapidly grasp the significance of at first sight unrelated discoveries or events."

Some people are of opinion that the factors to be taken account of in economic investigation are so numerous that progress on these lines is impossible. It would certainly be impossible if we had to begin *de novo* to construct the whole fabric of economic science. But, as we shall see, it is no more necessary to do this in the world of science than it is in the world of business or politics. There is in existence a vast store of accumulated knowledge, and few, if any, departments of economics have been left quite unilluminated by the researches of former generations. Progress is the result of adaptation rather than reconstruction. It must be remembered also that economic work in modern times is carried on by consciously or unconsciously associated effort, and although it must always require high qualities of judgment, capacity and energy, many of the difficulties which at first sight appear so insuperable give way when they are attacked. In some ways also the study of highly developed organizations like the modern industrial state is simpler than that of earlier forms of society.

In the earliest times for which we have abundant material the economic life of England had already reached in certain directions a high degree of complexity. Even in the rural districts, manorial records reveal the existence of a great variety of classes and groups of persons engaged in the performance of economic functions. The lord of the manor with his officials and retainers, the peasantry bound to him by ties of personal dependence and mutual rights and obligations, constituted a little world, in which we can watch the play of motives and passions not so dissimilar as we are sometimes led to believe from those of the great modern world. In many a country district the gradations of social rank were more continuous, the opportunities of intercourse more frequent, and the capacity for organization greater than in modern times. The manorial accounts were kept with precision and detail, and we are told that a skilled official could estimate to the utmost farthing the value of the services due from the villein to his lord. The manor was indeed self-sufficient and independent in the sense that it could furnish everything required by the majority of the inhabitants, and that over the greater part of rural England production was not carried on with a view to a distant market. But in the earliest times the manor was subjected to external influences of great importance. Vast areas of the country were in fact under the single control of a territorial lord or an ecclesiastical foundation. Every manor composing these great fefs was likely to be affected by the policy or the character of the administration of the feudal lord, and he, again, by the policy or the difficulties, the strength or the weakness, of the central government. Foreign trade and foreign intercourse were undeveloped, but their influence was in historical times never entirely absent, while the influence of Roman law and the Christian Church constantly tended to modify the manorial organization. In the towns the division of labour had proceeded much further than in the rural districts, and there were in existence organized bodies, such as the Gild Merchant and the crafts, whose functions were primarily economic. But one of the most striking characteristics of town life in the middle ages was the manner in which municipal and industrial privileges and responsibilities were interwoven. In modern times the artisan, however well trained, efficient and painstaking he may be, does not, in virtue of these qualities, enjoy any municipal or political privileges. By means of his trade union, co-operative society or club he may gain some experience in the management of men and business, and in so far as the want of a sufficient income does not constitute an insuperable difficulty, he may share in the public life of the country. But in his character as

Character
of subject-
matter.

Ancient
and
modern
conditions
in
England.

artisan he enjoys no municipal or political privileges. In the middle ages this differentiation of the industrial, municipal and political life had not taken place, and in order to understand the working of at first sight purely economic regulations it is necessary to make a close study of the functions of local government. But this, after all, does not carry us very far. From the very nature of the records in which we study the town life of the middle ages, it follows that we obtain from them only a one-sided view. No one knows what proportion of the industrial population was included in the organized guilds, or how complete was the control exercised by these bodies over their members. Elaborate regulations were in force, but no one knows how elastic they were in practice. Medieval Englishmen were particularly apt to put their aspirations into a legal form, and then rest satisfied with their achievement. The number of regulations is scarcely to be regarded as a test of their administrative success. Further, as the country became more consolidated and the central government extended its authority over economic affairs, new regulations came into force, new organs of government appeared, which were sometimes in conflict, sometimes in harmony, with the existing system, and it becomes for a time far more difficult to obtain a clear view of the actual working of economic institutions. Thus the study of the economic life of the middle ages is one of the most complicated subjects which can engage the attention of man. It is impossible to carry the process of isolation very far. The different threads of social activity are so closely interwoven that we cannot follow any one for very long without forming wrong impressions, and it becomes necessary to turn back and study others which seemed at first sight unrelated to the subject of our investigations. Under an apparently uniform and stable system of social regulation there was much variation and movement, the significance of which it is impossible to estimate. Materials for forming such an estimate no doubt exist, but before doing so we have to study in infinite detail a vast number of separate manors, municipalities or other separate economic areas. This involves great industry on the part of many scientific workers. Meanwhile we can illustrate the economic life of the middle ages, describe its main features, indicate the more important measures of public policy and draw attention to some of the main lines of development.

It is only as we approach more modern times that the conditions of economic study are realized and economic science, as we understand it, becomes possible. Those conditions are: (i.) the life of the state or other community or communities we are studying must be so differentiated that we can isolate those functions which are wholly or predominantly economic. The "separation of employments" is not only a condition of economic efficiency; it was necessary before we could have an economic science. (ii.) We must be in a position so far to understand and estimate the character and motives of different classes and groups in these communities that we can rightly interpret their action. This condition cannot be realized without great difficulty, for "economic motives" are very different in different periods, nations and classes, and even for short periods of time in the same country are modified by the influence of other motives of an entirely different order. In studying the economic history of the 18th century, for example, it is not enough to assume with Defoe that "gain is the design of merchandise." We have to be saturated, as it were, with 18th-century influences, so that we can realize the conditions in which industry and trade were carried on, before we can rightly explain the course of development. In our own day labour disputes, to take another example, can scarcely ever be resolved into a question of merely pecuniary gain or loss. The significance of the amount of money involved varies greatly for different trades, and can only be understood by reference to the character and habits of the people concerned. But questions of sentiment, shop-feeling and trade customs invariably play an important part. (iii.) Economics can never lead to anything but hypothetical results unless we not only realize that we must "take account of" other than the purely economic factors, but also give due weight and significance to

these factors. No explanation of the industrial situation in Germany, for example, would be intelligible or satisfactory even from the economic point of view which ignored the significance of the political conditions which Germans have to deal with. So, again, it is impossible to make a useful comparative estimate of the advantages and disadvantages of the transport systems of England, the United States and Germany, unless we keep constantly in view the very different geographical, military and political conditions which these systems have to satisfy. (iv.) Sufficient information must be available to enable us to test the validity of our hypotheses and conclusions. Whatever "method" of economic investigation we employ, we must at every stage see how far our reasoning is borne out by the actual experience of life. This obvious condition of scientific inquiry is very far from being completely realized even at the present time. It implies the existence of a well-trained class engaged in the work of collecting information, and much organization both by the state and private bodies. These four conditions can be reduced to two. The community we are studying must have reached such a stage of development that its economic functions and those immediately cognate to them form a well-defined group, and adequate means must be available so that we can, as it were, watch the performance of these functions and test our hypotheses and conclusions by observation and experience.

It is easy to understand, therefore, why we trace the beginnings of economics, so far as England is concerned, in the 16th century, and why the application of strict scientific tests in this subject of human study has become possible only in comparatively recent times. Medieval economics was little more than a casuistical system of elaborate and somewhat artificial rules of conduct. From the close of the middle ages until the middle of the 18th century thousands of pamphlets and other works on economic questions were published, but the vast majority of the writers have little or no scientific importance. Their works frequently contain information given nowhere else, and throw much light on the state of opinion in the age in which they wrote. It is also possible to find in them many anticipations of the views of the economists of later times; but such statements were as a rule generated merely by the heat of controversy on some measure or event of practical importance, and when the controversy died down were seldom regarded or incorporated in a scientific system. Trade bias, personal impressions and guess-work took the place of scientific method. This was inevitable in the absence of trustworthy information on an adequate scale, and from the immediately practical aims of the writers. But from the end of the 17th century economics has been definitely recognized as a subject of scientific study.

In modern times the conditions which have made economic science possible have also made it necessary. While it is impossible to give a strictly economic interpretation of the earlier history of nations, economic interests govern the life and determine the policy of modern states that other forces, like those of religion and politics, seem to play only a subsidiary part, modifying here and there the view which is taken of particular questions, but not changing in any important degree the general course of their development. This may be, in the historical sense, merely a passing phase of human progress, due to the rapid extension of the industrial revolution to all the civilized and many of the uncivilized nations of the world, bringing in its train the consolidation of large areas, a similarity of conditions within them, and amongst peoples and governments a great increase in the strength of economic motives. When the world has settled down to the new conditions, if it ever does so, we may be confronted with problems similar to those which our forefathers had to solve. But, for the time, if we know the economic interests of nations, classes and individuals, we can tell with more accuracy than ever before how in the long run they will act. Public policy therefore requires the closest possible study of the economic forces which are moulding the destinies of the great nations of the world. In most civilized countries except England this is recognized, and adequate provision is made for the study

of economic science. But the subject is not only of immediate concern to the state in its corporate and public capacity. The neglect of it in the domain of private business can now only lead to disastrous results. To quote from a useful work (*National Education: a Symposium, 1901*), "the commercial supremacy of England was due to a variety of causes, of which superior intelligence, in the ordinary business sense, was not the most important. Her insular position, continuity of political development and freedom from domestic broils played an important part in bringing about a steady and continuous growth of industry and manufactures for several generations before the modern era. The great wars of the 18th and the beginning of the 19th century, which arrested the growth of continental nations, gave England the control of the markets of the world. When peace was restored, England enjoyed something in the nature of a monopoly. The competition of France ceased for a time to be an important factor. What is now the German empire was a mere congeries of small states, waging perpetual tariff wars upon each other. In the old Prussian provinces alone there were fifty-three different customs frontiers, and German manufactures could not develop until the growth of the Zollverein brought with it commercial consolidation, internal freedom and greater homogeneity of economic conditions. The industries of the United States were in their infancy. Thus the productive power of England was unrivalled, and her manufactures and business men, under a régime rapidly approximating to complete freedom of trade, could reap the full advantages to be derived from the possession of great national resources and production by machinery. Commercial supremacy required not so much highly trained intelligence amongst manufacturers and merchants as keen business instinct and a certain rude energy. In the last generation all that has changed, and the change is of a permanent character. The struggle of the future must inevitably be between a number of great nations, more or less equally well equipped, carrying on production by the same general methods, each one trying to strengthen its industrial and commercial position by the adoption of the most highly developed machinery, and all the methods suggested by scientific research, policy or experience. Under these conditions, it is no longer possible for the individual merchant, or for small groups of merchants, to acquaint themselves, by personal experience alone, with more than a fractional part of the causes which affect the business in which they are engaged. The spread of the modern industrial system has brought with it the modern state, with its millions of consumers, its vast area, its innumerable activities, its complicated code of industrial and commercial law. At the same time, the revolution in the means of transport and communication has destroyed, or is tending to destroy, local markets, and closely interwoven all the business of the world. Events in the most distant countries, industrial and commercial movements at first sight unrelated to the concerns of the individual merchant, now exert a direct and immediate influence upon his interests. The technical training of the factory or the office, the experience of business, the discharge of practical duties, necessary as they are, do not infallibly open the mind to the large issues of the modern business world, and can never confer the detailed acquaintance with facts and principles which lie outside the daily routine of the individual, but are none the less of vital importance." Economics, therefore, under modern conditions, is not only a subject which may usefully occupy the attention of a leisured class of scientific men. It should form part of the training of educated men of all classes, on grounds of public policy and administrative and business efficiency.

The relations between economics and other sciences cannot be stated in a very general form. They vary for different periods, and are not the same for all branches of economics. There is no subject of human study which may not be at some time or other of economic significance, and anything which affects the character, the ideals or the environment of man may make it necessary to modify our assumptions and our reasoning with regard to his conduct in economic affairs. But if the economist,

while studying one side of man's activities, must also cultivate all other branches of human learning, it is obvious that no substantial progress can be made. The economist frankly assumes the reality of the existing world and takes men as they are, or as they have been if he is studying past times. His assumptions are based upon ordinary observation and experience, and are usually accurate in proportion to his practical shrewdness and sagacity, so that he is not interested in the speculative flights of philosophy, except in so far as they influence or have influenced conduct. In times past, and to a less extent in our own day, philosophical conceptions have formed the basis of great systems of politics and economics. The historical relations between philosophy and economics are of great importance in tracing the development of the latter, and have done much to determine its present form. But the modern conception of society or the state owes more to biology than philosophy, and actual research has destroyed more frequently than it has justified the assumptions of the older philosophical school. Experimental psychology may in course of time have an important bearing on economics, but the older science cannot be said to be of much significance except in its historical aspects. Ethics is in much the same position. That is, it is possible to conceive of an ethical science which would extend considerably our knowledge of economic affairs, but no important new principle or original discovery, relevant to economic investigation, has come from that quarter in recent years, and at present ethics has more to learn from economics than the latter has from ethics. It is in the adaptation of biological conceptions and methods, in the positive contributions of jurisprudence, law and history, in the rigorous application, where possible, of quantitative tests, that the explanation of the present position of economics is to be found. Mathematics has influenced the form and the terminology of the science, and has sometimes been useful in analysis; but mathematical methods of reasoning, in their application to economics, while possessing a certain fascination, are of very doubtful utility.

There is no method of investigation which is peculiarly economic or of which economics has the monopoly. In every age economists have applied the methods ordinarily in use amongst scientific men. There would probably have been no controversy at all on this subject but for the fact that economics was elaborated into systematic form, and made the basis of practical measures of the greatest importance, long before the remarkable development in the 19th century of historical research, experimental science and biology. The application of the *a priori* method in economics was an accident, due to its association with other subjects and the general backwardness of other sciences rather than an exceptional and peculiar character in the subject-matter of the science itself. The methods applied to economics in the 18th and the early part of the 19th century were no more invented with a special view to that subject than the principles of early railway legislation, in the domain of practical policy, were devised with a special view to what was then a new means of transport. As a matter of fact, discussions of method and the criticism of hypotheses and assumptions are very rarely found in early economic works. It is only by reference to the prevailing ideas in philosophy and politics that we can discover what was in the minds of their authors. The growth of a science is much like the growth of a constitution. It proceeds by adaptation and precedent. The scientific and historical movement of the 19th century was revolutionary in character. When it began to affect economics, many people were afraid that the whole fabric of science would be destroyed and the practical gains it had achieved, jeopardized. These fears were justified, in so far as those who entertained them shut their eyes to everything new and assumed an attitude of no compromise. Where the newer methods were assimilated, the position of economics was strengthened and its practical utility increased. General discussion of method, however, is rarely profitable. In all branches of economics, even in what is called the pure theory, there is an implied reference to certain historical or existing conditions of a more or less

Relations
between
economics
and other
sciences.

Method of
economic
investigation.

definite character; to the established order of an organized state or other community, at a stage of development which in its main features can be recognized. In all economic investigation assumptions must be made, but we must see that they are legitimate in view of the actual life and character of the community or communities which are the subject of investigation. In common with other sciences, economics makes use of "abstractions"; but if for some problems we employ symbolic processes of reasoning, we must keep clearly in view the limits of their significance, and neither endow the symbols with attributes they can never possess, nor lose sight of the realities behind them. Every hypothesis must be tested by an appeal to the facts of life, and modified or abandoned if it will not bear examination, unless we are convinced on genuine evidence that it may for a time be employed as a useful approximation, without prejudice to the later stages of the investigation we are conducting.

We shall best illustrate the character and method of economic reasoning by examples, and for that purpose let us take first of all a purely historical problem, namely, the effect on the wage-earners of the wages clauses of the Statute of Apprenticeship (1563). It is at once obvious that we are dealing not with an abstract scheme of regulation in a hypothetical world, but with an act of parliament nominally in force for two hundred and fifty years, and applicable to a great variety of trades whose organization and history can be ascertained. The conclusions we reach may or may not modify any opinions we have formed as to the manner in which wages are determined under modern conditions. For the time being such opinions are irrelevant to the question we are investigating, and the less they are in our minds the better. There is no reason why we should apply to this particular act a different method of inquiry from that we should apply to any other of the numerous acts, of more or less economic importance, passed in the same session of parliament. The first step is to see whether there is a *prima facie* case for inquiry, for many acts of parliament have been passed which have never come into operation at all, or have been administered only for a short time on too limited a scale to have important or lasting results. The justices were authorized to fix wages at the Easter quarter sessions. Did they exercise their powers? To answer this question we must collect the wages assessments sanctioned by the magistrates. This is a perfectly simple and straightforward operation, involving nothing more than familiarity with records and industry in going through them. Without having recourse to any elaborate process of economic reasoning, by confining our attention to one simple question, namely, what happened, we can establish conclusions of the greatest interest to economic historians and, further, define the problem we have to investigate. We can show, for example: (1) that the Statute of Apprenticeship did not stand alone; it was one of a long series of similar measures, beginning more than two centuries before, which in their turn join on to the municipal and gild regulations of the middle ages; one of an important group of statutes, more or less closely interwoven throughout their history, administered by local authorities whose functions had grown largely in connexion with this legislation and the gradual differentiation of the trades and callings to which it related. (2) That wages were regulated with much greater frequency during the reigns of Elizabeth, James I. and Charles I. than at any later period. (3) That they were regulated in some counties and not in others. (4) That in the counties and towns where they were regulated the action of the magistrates was in general spasmodic, and rarely continuous for a long series of years. (5) That the magistrates used their powers sometimes to raise wages, sometimes to force them down. (6) That the local variations of wages and prices were what we should call excessive, so that the standard of comfort in one district was very different from that of others. (7) That the wages assessments group themselves round certain short periods, coincident in many instances with high prices, increase of poverty, and other causes of exceptional action. (8) That what we may call, with the above limitations, the effective period of the act terminates with the outbreak of the Civil War. (9) That

subsequent to that period organic changes in the industries affected, coupled with the incompetence of parliament to adapt the old legislation to new conditions, and the growing acceptance of the doctrine of *laissez faire*, brought about a general disuse of the statute, though isolated attempts to enforce it were made and new acts applicable to certain trades were passed in the 18th century. (10) For more than one hundred years before the repeal of the act, trade unions and other forms of voluntary association amongst wage-earners, combinations amongst employers, collective agreements, customary regulations, were established in many of the important trades of the country. But these conclusions, after all, suggest more difficulties than they remove, for they show that our inquiry, instead of presenting certain well-marked features which can be readily dealt with, has to be split up into a number of highly specialized studies: the investigation of rates of wages, prices and the standard of comfort in different localities, bye-industries, regularity of employment, the organization of particular trades, the economic functions of local authorities, apprenticeship and a host of other subjects. Moreover, all these subjects hang together, so that it seems impossible to come to a decision about one of them without knowing all about the others.

It is a comparatively simple thing to state the question to which we want an answer, but extremely difficult to define the exact nature of the evidence which will constitute a good answer; easy enough to say we must try hypothesis after hypothesis, and test each one by an appeal to the facts, but a man may easily spend his life in this sort of thing and still leave to his descendants nothing more than a legacy of rejected hypotheses. Every volume of records we look through contains a mass of detailed information on the economic life of England in the period we are studying. How much of it is relevant to the subject of inquiry? What is to be the principle of selection? How shall we determine the relative weight and importance of different kinds of relevant evidence? As in modern problems, so in those of past times, a man requires for success qualities quite distinct from those conferred by merely academic training and the use of scientific methods. A correct sense of proportion and the faculty of seizing upon the dominant factors in an historical problem are the result partly of the possession of certain natural gifts in which many individuals and some nations are conspicuously wanting, partly of general knowledge of the working of the economic and political institutions of the period we are studying, partly of what takes the place of practical experience in relation to modern problems, namely, detailed acquaintance with different kinds of original sources and the historical imagination by which we can realize the life and the ideals of past generations. These qualities are required all the more because, in order to make any further progress with such an inquiry as we have suggested, we have deliberately to make use of abstraction as an instrument of investigation.

Let us see how this will work out. Suppose we have selected one of the numerous subsidiary problems suggested by the general inquiry, and obtained such full and complete information about one particular industry that we can tabulate the wages of the workers for a long series of years. We may do the same for other industries, some of them coming under the Statute of Apprenticeship, others not. If all the industries belong to one economic area over which, so far as we can tell from general statistics of wages and prices, and other information, fairly homogeneous conditions prevailed, we may be able to reach some useful conclusions as to the operation of the act. But it would be absurd to suppose that we could reach those conclusions by simple reference to the trades themselves. We cannot assume that the fluctuations in wages were due to the action or inaction of magistrates without the most careful examination of the other influences affecting the trades. In economic affairs the argument *post hoc propter hoc* never leads to the whole truth, and is frequently quite misleading. We cannot suppose that the policy of the Merchant Adventurers' Company had nothing to do with the woollen industry; that the export trade in woollen cloth was quite independent of the

An illustration of economic method.

The plan of a general theory.

foreign exchanges and international trade relations in those times; that the effect on wages of the state of the currency, the influx of new silver, the character of the harvests, and many other influences can be conveniently ignored. In studying, therefore, such an apparently simple question as the effect of an act of parliament on wages in a small group of trades we want a general theory which we can use as a kind of index of the factors we have to consider.

Assuming that we have in our minds this safeguard against loose thinking and neglect of important factors, the investigation of the special problems arising out of the general inquiry resolves itself into a careful definition of each problem we wish to deal with, and the collection, tabulation and interpretation of the evidence. In most cases the interpretation of the facts is far from obvious, and we have to try several hypotheses before we reach one which will bear the strain of a critical examination in the light of further evidence. But at this stage in historical investigation it is generally the want of evidence of a sufficiently complete and continuous character, rather than difficulties of method, which forces us to leave the problem unsolved. It is, for instance, practically impossible to obtain reliable evidence as to the regularity of employment in any industry in the 17th century, and the best approximations and devices we can invent are very poor substitutes for what we really want. For this reason economic work must continue to play an important part in business history. But every genuine attempt to overcome its difficulties brings us into closer touch with the period we are examining; and though we may not be able to throw our conclusions into the form of large generalizations, we shall get to know something of the operation of the forces which determined the economic future of England; understand more clearly than our forefathers did, for we have more information than they could command, and a fuller appreciation of the issues, the broad features of English development, and be in a position to judge fairly well of the measures they adopted in their time. By comparing England with other countries we may be able in the distant future to reach conclusions of some generality as to the laws of growth, maturity and decay of industrial nations. But like the early statisticians of the 17th century, economic historians are the "beginners of an art not yet polished, which time may bring to more perfection."

When we come to exclusively modern questions, there is no reason or necessity for a fundamental change of method. We cannot suppose that there occurred, at or about the commencement of the 19th century, a breach of historical continuity of such a character that institutions, customs, laws and social conventions were suddenly swept away, the bonds of society loosened, and the state and people of England dissolved into an aggregate of competing individuals. The adoption of machinery gradually revolutionized the methods of production; but in the first instance only certain industries were affected, and those not at the same time or in the same degree; old laws grown obsolete were repealed, but other laws affecting wage-earners and employers took their place, more complicated and elaborate than the Elizabethan code. Trade unions, so far from disappearing, were legalized, gathered strength from the changes in industrial organization, and nowhere became so powerful as in the most progressive industries; while other forms of combination appeared, incomparably stronger, for good or evil, than those of earlier times. But while we recognize these facts, we must not suppose that we have to study the action of men as though they were all enrolled in organized associations, or covered by stringent laws which were always obeyed. There has never been in the history of English industry such licence as we find in certain directions in the earlier part of the 19th century.

It is not in the decay of combination and monopoly or in the growth of competition that we must look for the distinctive characteristics of modern problems. A 17th-century monopoly was a very weak and ineffective instrument compared with a modern syndicate; the Statute of Apprenticeship was

certainly not so widely enforced as the "common rules" of trade unions; and many of the regulations of past times, which look so complicated to modern eyes, were conditions of free enterprise rather than restraints upon it. It is due to the influence of the *laissez faire* doctrine that we regard law and regulation as a restraint on liberty. As a maxim for guidance in public affairs, *laissez faire* was genuinely relevant at the end of the 18th and the beginning of the 19th century, when the Statute Book was cumbered with vexatious and obsolete laws. As an explanation of what has taken place in later years, or of the actual economic life of the present day, it is ludicrously inadequate. Competition, in the sense in which the word is still used in many economic works, is merely a special case of the struggle for survival, and, from its limitation, does not go far towards explaining the actual working of modern institutions. To buy in the cheapest market and sell in the dearest; to secure cheapness by lowering the expenses of production; to adopt the less expensive rather than the more expensive method of obtaining a given result—these and other maxims are as old as human society. Competition, in the Darwinian sense, is characteristic not only of modern industrial states, but of all living organisms; and in the narrower sense of the "higgling of the market" is found on the Stock Exchange, in the markets of old towns, in medieval fairs and Oriental bazaars. In modern countries it takes myriads of forms, from the sweating of parasitic trades to the organization of scientific research. Economic motives, again, are as varied as the forms of competition, and their development is coeval with that of human society. They have to be interpreted in every age in relation to the state of society, the other motives or ideals with which they are associated, the kind of action they inspire, and the means through which they operate. Apparently the same economic motives have led in the same age and in the same nation to monopoly and individual enterprise, protection and free trade, law and anarchy. In our own time they have inspired both the formation of trade combinations and attempts to break them up, hostility to all forms of state interference and a belief in collectivism.

The conditions which are peculiar to the modern world are the large numbers we have to deal with, the vast and fairly homogeneous areas in which justice is administered and property secured, and the enormously increased facilities for transport and communication. These conditions are of course not independent of each other, and they have brought in their train many consequences, some good and some bad. But they supply the bases for that general theory which, as we have seen, is indispensable in economic investigation. From the standpoint of general theory economic movements assume an impersonal character and economic forces operate like the forces of nature. Although economic motives have become more complex, they have just as much and no more to do with general economic reasoning and analysis than the causes of death with the normal expectation of life, or domestic ideals with the birth-rate. So far as we have anything to do with psychology at all, it is the psychology of crowds and not of individuals which we have to consider. If we study the economy of a village, the idiosyncrasies of every individual in it are of importance. If the village is replaced by a large area, inhabited by millions, with modern facilities of communication, it is a matter of observation and experience that for the purposes of general reasoning the idiosyncrasies of individuals may be neglected. Whether such large numbers have the character of the "economic man" of the early economists matters very little. All the assumptions we require are furnished by observation of people in the mass and the larger generalizations of statistics. Thus we can construct a kind of envelope of theory, which, by careful testing as we proceed, can be made to indicate in a general manner the reactions of one part of the activities of the economic world upon the others, and the interdependence of the several parts. From its very nature this general theory can never correspond strictly to the actual life and movement of any given state. It is useful and necessary, and plays somewhat the same part in economic

Difficulties due to want of evidence.

The investigation of modern questions.

The distinctive features of modern problems.

investigation as ton-mile statistics do in the administration of a railway. To express in any language or to illustrate by any images, from a purely objective standpoint, the infinitely complicated movements of the actual world, is a task far beyond human capacity.

With the aid of this general theory the methods we have sketched in relation to historical problems apply with greater force to the special problems of modern times, and are rewarded with results more accurate, more fruitful, more relevant to difficulties which all civilized nations have to face, than those of historical research. To many minds the interest and usefulness of economics depend entirely on the application of these methods, for it is the actual working of economic institutions about which the statesman, the publicist, the business man and the artisan wish to know. Under the conditions we have described, many of the most interesting problems of our own time, when they are once defined, resolve themselves into statistical inquiries. But in most cases such an inquiry cannot be successfully carried out by a mere statistician. Definite economic problems can very rarely be dealt with by merely quantitative methods. In the tabulation and interpretation of statistical evidence, as in its collection, it is scarcely possible to overrate the importance of wide knowledge and experience. There is another very important instrument of investigation which can be used in our own time, but cannot be employed in historical research. Historical documents, however detailed, rarely show all the factors we have to deal with or fully explain a given situation. No sane person would suppose that the minutes of a modern legislative body explain the steps by which legislation has been passed, or the issues really involved. The ostensible cause of a modern labour dispute is frequently not the real or the most important cause. In modern problems we can watch the economic machine actually at work, cross-examine our witnesses, see that delicate interplay of passions and interests which cannot be set down or described in a document, and acquire a certain sense of touch in relation to the questions at issue which manuscripts and records cannot impart. We can therefore substitute sound diagnosis for guess-work more frequently in modern than in historical problems.

What then, it may be asked, becomes of the "old Political Economy"? Of what possible use are the works of the so-called classical writers, except in relation to the history of economics and the practical influence of theory in past times? If we take the mere popular view of what is meant by the "old Political Economy," that is, that a generation or so ago economics was comprised in a neatly rounded set of general propositions,

The "old political economy."

universally accepted, which could be set forth in a text-book and learnt like the multiplication table, it is not incumbent on the present generation to define its attitude at all. In this sense of the words, there was no faith delivered to our fathers which we are under any obligation to guard or even explain. If by the "old Political Economy" we mean the methods and conclusions of certain great writers, who stood head and shoulders above their contemporaries and determined the general character of economic science, we are still under no obligation to define the attitude of the present generation with regard to them. The fact that Adam Smith, with the meagre materials of the 18th century at his disposal, saw his way to important generalizations which later research has established on a firm basis, may enhance greatly the reputation of Adam Smith, but does not strengthen the generalizations. They stand or fall by the strength of the evidence for or against them. In the history of economics or the biography of Ricardo it is of interest to show that he anticipated later writers, or that his analysis bears the test of modern criticism; but no economist is under any obligation to defend Ricardo's reputation, nor is the fact that a doctrine is included in his works to be taken as a demonstration of its truth. The appeal to authority cannot be permitted in economics any more than in chemistry, physics or astronomy. But the cases stated above suggest more or less false issues. There has been no revolution in economic science, and is not likely to be any. The

question we have really to determine is how we can make the best use of the accumulated knowledge of past generations, and to do that we must look more closely into the economic science of the 19th century.

Any one who has taken the trouble to trace the history of one of the modern schools of economists, or of any branch of economic science, knows how difficult it is to say when it began. "Anticipations" of method and doctrine can generally be found by the diligent investigator in the economic literature of his own or a foreign country. So that cross-sections of the stream of economic thought will reveal the existence, at different times, in varying proportions and at different stages of development, of most of the modern "schools." Again, the classification of an economic bibliography at once shows how varied has been the character of economic investigation, ranging from the most abstract speculation on the one hand to almost technical studies of particular trades on the other. Of the great army of writers who flourished in the first half of the 19th century some were closely identified with the utilitarian school, and the majority were influenced in a greater or less degree by the prevailing ideas of that school. Others, however, were hostile to it. In many works, such as those of a statistical or historical character, there are frequently to be found passages which could have been written in no other period, but are only of the nature of ejaculations and do not affect the argument. In stating the position of economics during this time we cannot ignore all writers, except those who belonged to one group, however eminent that group may have been, simply because they did not represent the dominant ideas of the period, and exercised no immediate and direct influence on the movement of economic thought. We must include the pioneers of the historical school, the economic historians, the socialists, the statisticians, and others whose contributions to economics are now appreciated, and without whose labours the science as we know it now would have been impossible. If we take this broadly historical view of the progress of economics, it is obvious that even in England there was no general agreement, during the 19th century, as to the methods most appropriate to economic investigation.

Suppose, now, we ignore the writers who were inaugurating new methods, investigating special problems, or laboriously collecting facts, and concentrate attention on the dominant school, with its long series of writers from Adam Smith to John Stuart Mill. It is the work of these writers which people have in mind when they speak of the "old Political Economy." There are several quite distinct questions we can ask with regard to them. That they must be studied closely by every one who wishes to follow the history of economics goes without saying. That they must be studied by the economic historian is equally clear, owing to their practical influence and the fact that they furnished the theoretical bases of much of the economic policy of the 19th century. This is true whether their method is good or bad, whether their conclusions are true or false. It is not so easy to determine their relevance and usefulness in relation to distinctively modern problems, or to indicate within what limits their work is of permanent value, and we can only deal with these questions in their more general aspects.

It must be clear to every observer that the economists of the classical period, with the one exception of Adam Smith, will speedily share the fate of nearly all scientific writers. They will be forgotten, and their books will not be read. Adam Smith's *Wealth of Nations*, if it has ever been, has long ceased to be a scientific text-book. Whether a modern economist accepts his views or not is of no importance. There is probably not a single chapter in the *Wealth of Nations* which would be thoroughly endorsed by any living economist. But the reputation of the book and its author is quite independent of considerations of this kind. The *Wealth of Nations* is one of the great books of the world, many of the sayings of which are likely to be more frequently quoted in the future than they have been in the 19th century. Malthus is already an author whose name is probably more widely known than that of any other economist, but whose works are rarely read, and studied only by a small proportion of

the few people who write books on the history of economic theory. Of economic students, many are unaware of the fact that he wrote any other book than the *Essay on the Principle of Population*, and what is of permanent importance in that work is contained in the generalization which it suggested to Darwin. Moreover, modern economists, while accepting in the main the general tenor of Malthus's theory of population, would not agree with his statement of it. Like Malthus, Ricardo owes his reputation very largely to the theory associated with his name, though it has long ceased to be stated precisely in the terms he employed. But there are very few people in the world who have made a careful study of his works; and although his theory of rent has a wide and increasing application in economics, it is not comparable in general scientific importance with Malthus's theory of population. It is already impossible to take J. S. Mill's *Principles of Political Economy* as a text-book. Important as it was for thirty or forty years, it will soon be as little read as M'Culloch's *Principles*. For the rest of the economists of this period, it is difficult to see how they can escape oblivion. When the generation whose economic training was based upon J. S. Mill has died out, the relevance of the "old Political Economy" is not likely to be a question of any interest to ordinary educated men and women, or even to the great mass of economic students.

The explanation of this decay of interest does not lie upon the surface. It is frequently supposed that the influence of the "old Political Economy" has been gradually undermined by the attacks of the historical school. But great as the achievements of this school have been, it has not developed any scientific machinery which can take the place of theory in economic investigation. If our view is correct that, broadly speaking, the two ways of regarding economic questions are complementary rather than mutually exclusive, there does not seem to be any reason why the growth of the historical school should have been destructive of the "old Political Economy" if it had been well founded. The use of the historical method has, in fact, raised more reputations than it has destroyed, because by keeping carefully in view the conditions in which economic works have been written, it has shown that many theories hastily condemned as unsound by *a priori* critics had much to be said for them at the time when they were propounded. This observation is true not only of old-world writers like the Mercantilists, but also of Ricardian economics. No one is concerned to prove that the Ricardian economics applies to the manorial system, and it is generally supposed at any rate that the world has been approximating more and more nearly during the last century to the conditions assumed in most of the reasoning of that school. On the principles we have explained, therefore, the Ricardian economics should supply just that body of general theory which is required in the investigation of modern economic problems, and the reputation of at any rate the leading writers should be as great as ever. It would be of immense advantage from a scientific point of view if this could be taken for granted, if for a time the work of the classical economists could be considered final so far as it goes, and for the purposes of investigation regarded as the theoretical counterpart of the modern industrial system. This assumption, however, has been made quite impossible, not by the historical school, but by the criticism and analysis of economists in the direct line of the Ricardian succession.

Modern economic criticism and analysis has destroyed the authority of the "old Political Economy" as a scientific system. The assumptions, the definitions, the reasoning, the conclusions of the classical writers have been ruthlessly overhauled. Defects in their arguments have been exposed to view by those who are most concerned to defend their reputation. Writers with none of the prejudices of the historical school, but with the cold and remorseless regard for logic of the purely objective critic, have pointed out serious inconsistencies here, the omission of important factors there, until very little of the "old Political Economy" is left unscathed. In fact, there never was a scientific system at all. What was mistaken for it was fashioned in the heat of controversy by men whose interests were practical rather than scientific, who could not write correct English, and revealed in

their reasoning the usual fallacies of the merely practical man. So the "old Political Economy" lies shattered. It is useless to suppose that this destructive criticism from within can be neutralized by generously sprinkling the pages of the classical writers with interpretation clauses. This may serve to show that the ideals of our youth were not without justification; but the younger generation, which does not care about our ideals, and looks to the future rather than the past, will not read annotated editions of old books, however eminent their authors. If the Ricardian school of economists had been merely philosophers, or even a group like the French physiocrats, this state of things might be regarded with equanimity. We might assume that criticism and analysis had separated the wheat from the chaff in their writings, that everything of permanent value had probably been preserved and incorporated in the works of later economists. But the character of much of their work makes this assumption impossible. It is, in fact, quite true that many of them were more interested in practical aims than in the advancement of economic science. We may talk of the assumptions implicitly involved in Ricardo's works. In reality we do not know what those assumptions were; we only know what assumptions we should make in order to reach the same conclusions, and they may be very different from "the mind of Ricardo." Ricardo's works, in fact, do not explain a theoretical system, but contain the matured reflections, more or less closely reasoned, of a man of great mental power looking out on the world as it appeared to a business man experienced in affairs. The conclusions of such a work are of wider significance than the assumptions we attribute to the author would warrant. They are not expressed in terms which satisfy our canons of scientific accuracy. Dissected sentence by sentence, the book may be shown to be a mass of inconsistencies. If it has the misfortune to be systematized by an enthusiastic but dull and incompetent disciple, it may appear even absurd. But after all the misinterpretation of contemporaries and the destructive criticism of later times, the book as a whole leaves upon us an impression of peculiar strength and charm, and imparts a sense of the relations of things truer, because less mechanical, than the laboured reasoning of smaller men. Such is the character of much of the work of Ricardo and some of his contemporaries. We think that the decay of interest in these writers involves a real loss, and that students of modern problems may do worse than read Ricardo and his school. Some of the criticism of their works, necessary and useful as it has been, will probably be corrected later on by that breadth of view and sense of proportion which has enabled us to appreciate justly the achievements of lesser men in more remote times. But rehabilitation in accordance with the canons of historical justice will not restore the lost influence of the Ricardian school. Their achievements in the 19th century will be fully acknowledged, but the relevance of their work to the problems of the 20th century will be admitted less than at the present time.

In a subject like economics it must always be very difficult to decide how far a departure from the traditional form and expression of its main doctrines is necessary or desirable. No one who is really experienced in economic investigation cares to emphasize the originality, still less the revolutionary character of his own work. It is much more likely than not that some principle which for the moment seems new, some distinction which we may flatter ourselves has not been observed before, has been pointed out over and over again by previous writers, although, owing to special circumstances, it may not have received the notice it deserved. Economics is therefore, on the whole, an intensely conservative science, in which new truths are cautiously admitted or incorporated merely as extensions or qualifications of those enunciated by previous writers. This procedure has its advantages, but it may easily become dangerous by destroying the influence of the science it is meant to preserve. It is not unlike the procedure of the canonists and casuists of the middle ages with regard to the doctrine of usury, by which the doctrine was to all appearances preserved intact while in reality it was stripped of all its

Ricardo's
assumptions.

Economist
a conservative
school.

original meaning by innumerable distinctions "over-curious and precise." In the same way the doctrines of the classical economists may be adapted by interpretation clauses and qualifications the exact force of which cannot be tested or explained, so that we do not know whether the original proposition is to be considered substantially correct or not. The result will be that while the doctrines are apparently being brought into closer correspondence with the facts of life, they will in reality be made quite useless for practical purposes or economic investigation. It is easier to point out the danger than to suggest how it should be met. The position we have described is no doubt partly due to the unsettlement of economic opinion and the hostile criticism of old-established doctrines which has characterized the last generation. Or it may be the result of economic agnosticism, combined with unwillingness to cut adrift from old moorings. Whatever the cause, the complete restatement of economic theory, which some heroic persons demand, is clearly impossible, except on conditions not likely to be realized in the immediate future. The span of life is limited; the work requires an extensive knowledge of the economic literature of several countries and the general features of all the important departments of modern economic activity. In general theory special studies by other men cannot play the same part as they do in historical and statistical work. In historical and statistical investigation, or in special studies of particular subjects, it is possible, given the pecuniary means, to organize a whole army of skilled assistants, and with ordinary care to combine the results of their separate efforts. In general theory the inverse rule seems to prevail. There the unity of conception and aim, the firm grip of all the different lines of argument and their relation to each other, which are required, can only be given by a single brain. But no one individual can do original work over the whole field. He is lucky if he can throw new light on a few old propositions. For the rest, he can only, with the utmost caution, adopt the suggestions of other minds as qualifications of old doctrines, never feeling quite sure that he is right in doing so. A complete restatement could only be undertaken by a group of men, trained in much the same conditions, accustomed to think and work together, each one engaged on a special department, but all acting under the control of one master-mind. This is largely a question of the organization of economic studies, and it is of the greatest importance that, if possible, such an effort should be made to present in a connected form the best results of modern criticism and analysis.

Economics is unlike many other sciences in the fact that its claim to recognition must be based upon its practical utility, on its relevance to the actual life of the economic world, on its ability to unravel the social and economic difficulties of each generation, and to contribute to the progress of nations. The very effectiveness of modern criticism and analysis, which has brought great gains in almost all branches of economic theory, has made the science more difficult as a subject of ordinary study. The extensions, the changes or the qualifications, of old doctrines, which at any rate in the works of responsible writers are rarely made without good if not always sufficient reason, have modified very considerably the whole science, and weakened the confidence of ordinary educated men in its conclusions. In the case of many subjects this would matter very little, but in that of economics, which touches the ordinary life of the community at so many points, it is of great importance, especially at a time like the present, when economic questions determine the policy of great nations. The "economic man" of the earlier writers, with his aversion from labour and his desire of the present enjoyment of costly indulgences, has been abandoned by their successors, with the result that in the opinion of many good people altruistic sentiment may be allowed to run wild over the whole domain of economics. The "economic man" has, on the other hand, been succeeded by another creation almost as monstrous, if his lineaments are to be supposed to be those of the ordinary individual—a man, that is, who regulates his life in accordance with Gossen's Law of Satiation, and whose main passion is to

discover a money measure of his motives. It is extremely important to consider how far the economic conceptions based upon this view of the action of men in the ordinary business of life—such, for example, as the doctrine of marginal utility—depend for their truth and relevance on the fact that in economics we are dealing with large aggregates. The earlier writers generally assumed perfect mobility of labour and capital. No economist would deliberately make that assumption now unless he were dealing with some purely theoretical problem, for the solution of which it was legitimate at some stage in the reasoning. Many of the questions of the greatest practical importance at the present time, such as the competition between old and new methods of manufacturing commodities substantially the same in kind, and equally useful to the great body of consumers, arise largely from the immobility of capital or labour, or both of them. But it is obvious that if the assumption of perfect mobility is invalid, there is scarcely any economic doctrine identified with the earlier writers which may not require modification, in what degree it is impossible to say without very careful investigation. Much suggestive work on this subject of a general character is incorporated in economic books of the present day, but there is room for a whole series of careful monographs on a question of such fundamental importance. The same may be said of another subject, too frequently neglected by earlier writers, to which due significance has been given in the best recent work, namely, time in relation to value. It would perhaps be too much to say that the full consideration of this point has revolutionized the theory of value, but it has certainly created what seems almost a new science in close contact with the actual life of the modern world.

Some doctrines of the earlier economists, such as the Wages Fund Theory, are now practically abandoned, though it may be said that they contained a certain amount of truth. Others, which were considered of fundamental importance, owe their position in modern economics and the form in which they are stated to the "tradition of the elders." If they could, by some happy chance, have been left for discovery by modern economists, they would without doubt have received different treatment, to the great advantage of economic science. Such a doctrine is the so-called Law of Diminishing Returns, which Mill considered "the most important proposition in Political Economy." "Unless this one matter," he says, "be thoroughly understood, it is to no purpose proceeding any further in our inquiry." "Were the law different, nearly all the phenomena of the production and distribution of wealth would be other than they are." On the other hand, Thorold Rogers, not to speak of earlier objectors, described the law as a "dismal and absurd theorem." The opinions of present-day economists appear to fluctuate between these two extremes. The law may apparently be "a general rule" or "a tendency" which is liable to be "checked," or a particular case of the law of the conservation of energy. If we go to Mill to discover what it is, we find that "it is not pretended that the law of diminishing return was operative from the beginning of society; and though some political economists may have believed it to come into operation earlier than it does, it begins quite early enough to support the conclusions they founded on it." "It comes into operation at a certain and not very advanced stage in the progress of agriculture." But this very important stage in the history of a nation is not defined or clearly illustrated. We are told that we can see "the law at work underneath the more superficial agencies on which attention fixes itself"; it "undergoes temporary suspension," which may last indefinitely; and "there is another agency, in habitual antagonism" to it, namely, "the progress of civilization," which may include every kind of human improvement. Mill apparently is not content with the confusion between "law" and "agency" or "force," but opposes the one to the other. He is constantly speaking in terms which imply the conquering of one law by another, a habit from which his successors have not freed themselves; and the theory of natural processes which appears to have satisfied him, was that when two forces come into operation there is a partial or complete suspension of one by the

Some recent developments of economic theory.

other. In modern economics "fertility" has no very definite meaning. It may mean what is ordinarily understood by the word—climate, rainfall, railway rates or anything else except "indestructible powers of the soil." To speak of "additional labour and capital" without reference to the kind and quality of the labour and capital, and the manner in which they are employed, organized and directed, throws very little light on agriculture. Every improvement involves, from a quantitative point of view, more or less of capital or of labour, so that it is the "antagonizing" influences, which are nearly all qualitative, which appear to be really important. It is therefore extraordinarily difficult at present to know what happens, or rather what would happen if it were not prevented, when a country reaches "the stage of diminishing returns"; what precisely it is which comes into operation, for obviously the diminishing returns are the results, not the cause; or how commodities "obey" a law which is always "suspended." Possibly the present generation of English industrial history will furnish many illustrations of the law of diminishing returns. We can only say that it requires investigation and restatement.

Closely related to the law of diminishing returns is the Theory of Rent. No economic doctrine so well illustrates the achievements and the defects of modern economic analysis. Ricardo's statement of the theory left upon the world an impression, not wholly just, of singular clearness. He employed the theory with wonderful success in unravelling the problems of his time. Its importance has not been seriously, or at any rate successfully, called in question. Treated at first as a doctrine peculiarly applicable to land, with a certain controverted relevance to other natural agents, it has been so extended that there is scarcely any subject of economic study in which we may not expect to find adaptations or analogies, so that Ricardo seemed to have discovered the key of economic knowledge. But it was discovered that there were no "indestructible powers of the soil"; that the fertility of land in a country like England is almost entirely the result of improvement at some time or other; that "advantage of situation" includes very much more than the words in their literal sense imply; that both "fertility" and "advantage of situation" include many kinds of differential advantage; that in some circumstances rent does not enter into the price of agricultural and other produce, and that in others it does. Moreover, the study of the theory of rent has had a very great influence on all branches of economics by destroying the notion that it is possible to draw sharp lines of distinction, or deal with economic conceptions as though they were entirely independent categories. That modern economic analysis is incomparably more accurate than that of earlier times there can be no question. But the net result of the development of the doctrine of rent is that all problems in which this factor appears, and they embrace the whole range of economic theory, must apparently be treated on their merits. In its modern form the doctrine is far too general to be serviceable without the closest scrutiny of all the facts relating to the particular case to which it is applied. To deal adequately with the numerous extensions or qualifications of these and other doctrines in the hands of modern economists would involve us in an attempt to do what we have already said is impossible except on conditions not at present realized. It is clear that in the interests of general economic theory we require a vast number of special studies before an adequate restatement can be undertaken.

It must be clearly recognized that the functions of economic science in the present requirements of the world cannot possibly be discharged by treatises on economic theory. The relations between general theory and special studies conducted on the lines we have indicated have completely changed. General theory never has been, and in the nature of things never can be, the actual reflex of the life and movement of the economic world. It never has been, and never can be, more than an indication of the kind of thing which might be expected in a purely hypothetical world. When the aim of the man of affairs and the hypothesis of the economist was unrestricted competition, and

measures were being adopted to realize it, general theory such as the classical economists provided was perhaps a sufficiently trustworthy guide for practical statesmen and men of business. If only people can be got to believe in them, a few abstract principles are quite enough to destroy an institution which it has taken centuries to create. But a new institution cannot be made on the same terms. The modern industrial system has brought with it an immense variety of practical problems which nations must solve on pain of industrial and commercial ruin. For these problems we want, not a few old-established general principles which no one seriously calls in question, but genuine constructive and organizing capacity, aided by scientific and detailed knowledge of particular institutions, industries and classes. Just as the historical school grew up along with the greatest constructive achievement of the 19th century, namely, the consolidation of Germany, so the application to modern problems of the methods of that school has been called forth by the constructive needs of the present generation. We have already shown how these methods, in their turn, require the aid of general theory, but not of a general theory which tries to do their work. In fact, every attempt to make it do so must inevitably fail. How can such a huge mass of general propositions as are necessarily included in a system of economics ever be thoroughly tested by an appeal to facts? If they are not so tested, the general theory will remain a general theory, of no practical use in itself, until the end of time. If they are to be tested, an indefinitely large number of special studies must be made, for which the original materials must be collected and examined. That is, original investigation of special problems has to be carried out on a more gigantic scale than any economist of the historical school ever dreamt of or the world requires, with the certain knowledge that at the end of it all the general theory will not correspond with the facts of life. For there is all the difference in the world between using a body of general theory as an indication of the factors to be considered in the study of a special problem, and undertaking special studies with a view to testing the general theory. If the necessary limitations of general economic theory are recognized, most of the difficulties we have noticed disappear. Now that the "industrial revolution" has extended practically all over the world, so that we have several countries carrying on production by modern methods, it is easily possible to sketch the main features of industrial and commercial organization at the present time, to describe the banking and currency systems of the principal nations, their means of transport and communication, their systems of commercial law and finance, and their commercial policy. It is true that at present very little work of this kind has been done in England, but innumerable books, many of them about England, have been written by thoroughly competent economists, in French, German and other languages. So that no great amount of original work is required for a reliable account of those general features of the modern system which should form the introduction to economics. The general theory which we require should be sketched in firm and clear outline, leaving the detailed qualifications of broad principles to special studies, where they can be dealt with if it is necessary or desirable, and examined by statistical and other tests. For such a general theory there is ample material in the economic literature of all civilized countries. It is of the utmost importance that the economic terms, which are also, though in many cases with an entirely different meaning, the terms of business and commerce, should as far as possible be used in their common and ordinary English sense: that they should correspond in meaning with the same words when used in description, in law, accountancy and ordinary business. This is no doubt a difficult matter. But some change in this direction is necessary both in the interests of the science itself and of its practical utility. All the materials for investigation, all the facts and figures from which illustrations are drawn, all methods of keeping accounts in England, assume the ordinary English tongue. There are few if any conceptions in economics which cannot be expressed in it without depleting the ordinary vocabulary. At present the language of economics is for the ordinary Englishman

Relations between general economics and special studies.

like a foreign language of exceptional difficulty, because he is constantly meeting with words which suggest to his mind a whole world of associations quite different from those with which economic theory has clothed them. The refinements of economic analysis, as distinguished from its broader achievements, should be reserved for special studies, in which a technical scientific terminology, specially devised, can be used without danger of misconception. But in a subject like economics obscurity and an awkward terminology are not marks of scientific merit.

Economic studies should be as relevant to existing needs as those of engineering and other applied sciences. The scientific study of practical problems and difficulties is (generally speaking, and with honourable exceptions) far more advanced in almost every civilized country than it is in England, where the limited scale upon which such work is carried on, the indifference of statesmen, officials and business men, and the incapacity of the public to understand the close relation between scientific study and practical success, contrast very unfavourably with the state of affairs in Germany or the United States. The backwardness of economic science has been an index of the danger threatening the industrial and commercial supremacy of the United Kingdom. There are very few questions of public or commercial importance upon which the best and most recent investigations are to be found amongst English works. This would matter very little, perhaps, if Englishmen had a firm belief, established by actual experience, in the soundness of their policy, the present security of their position, and the sufficiency of their methods to strengthen or maintain it. But this is very far from being the case. If we take, for example, the corner-stone of the British commercial system in the 19th century, namely, the policy of "free trade" (*q.v.*), the public do not now read the economic works which supplied the theoretical basis of that policy, and, indeed, would not be convinced by them. The great men of the period, Cobden and Bright, are merely historical figures.

Long before his death, Bright's references in public speeches to the achievements of the Anti-Corn Law League were received with respectful impatience, and Peel's famous speech on the repeal of the corn laws would not convince the German Reichstag or a modern House of Commons. The result is that free trade had become by the end of the 19th century in the main an old habit, for which the ordinary English manufacturer could give no very reasonable explanation, whatever may be its influence in commerce and public affairs. The doctrine of free trade only prevailed in so far as it could be restated in terms which had a direct relevance to the existing position of England and existing conditions of international trade. And it was directly challenged by the representatives of Mr Chamberlain's school of Imperialist thought (see CHAMBERLAIN, JOSEPH). It thus became the work of economic science ruthlessly to analyse the existing situation, explain the issues involved in the commercial policy of different countries, and point out the alternative methods of dealing with present difficulties, with their probable results.

The commercial policy of a state is merely the reflex of its system of public finance (see *e.g.* ENGLISH FINANCE). The absence of conviction in regard to British commercial policy naturally had its counterpart in the attitude of many men to the financial system of the country. The eulogies showered upon it in the past were no longer considered adequate. The great increase in recent years in British military and naval expenditure, made necessary by the exceptional demands of a state of war and the great development of foreign powers, was partly responsible for the new difficulties; partly it was due to the great extension of the functions of the state during the latter part of the 19th century. The former causes may be considered partly permanent, partly temporary; but those of a permanent character are likely to increase in force, and those of a temporary character will leave

Commerce and Finance.
a deposit in the shape of an addition to the normal expenditure of the central government. The extension of government functions appeared much more likely to continue than to be checked. Normal expenditure might therefore be calculated to rise rather than fall. In spite of the vast increase in national wealth, it was found a matter of

increasing difficulty to meet a comparatively slight strain without recourse to measures of a highly controversial character; and the search for new sources of revenue (as in 1909) at once raised, in an acute form, questions of national commercial policy and the relations between the United Kingdom and the colonies.

The development of the powers of the central government has been less than that of the functions of local governing authorities. This, again, is a movement much more likely to extend than to be checked. Local governing authorities now discharge economic functions of enormous importance and complexity, involving sums of money larger than sufficed to run important states a generation ago. The scientific study of the economics of local administration is, however, in its infancy, and requires to be taken up in earnest by economists. These questions of commercial policy and local government are closely bound up with the scientific study of the transport system. Although the British Empire contains within itself every known species of railway enterprise, the study of railways and other means of transport, and their relation to the business, the commerce and the social life of the country, is deplorably backward. It is obvious that no inquiry into commercial policy, or into such social questions as the housing of the poor, can be effective unless this deficiency is remedied.

The whole social and political fabric of the British Empire depends upon the efficiency of its industrial system. On this subject many monographs and larger works have been published in recent years, but dealing rather with such questions as trade unionism, co-operation and factory legislation, than the structure and organization of particular industries, or the causes and the results of the formation of the great combinations, peculiarly characteristic of the United States, but not wanting in England, which are amongst the most striking economic phenomena of modern times.

These are some of the questions which must absorb the energies of the rising generation of economists. The claim of economics for recognition as a science and as a subject of study must be based on its relevance to the actual life of the economic world, on its ability to unravel the practical difficulties of each generation, and so contribute to the progress of nations.

LITERATURE.—See also FREE TRADE; PROTECTION; TARIFF; COMMERCIAL TREATIES; TRUSTS; MONEY; FINANCE; &c. The bibliography of economics as a whole would include a history of all the writers on the subject, and is beyond our scope here; see the numerous articles on economic subjects throughout this work. The article by Dr J. K. Ingram in the ninth edition of the *Encyclopædia Britannica* is still a valuable historical account. It is only possible to mention here a few of the more recent text-books. The most important general work published in English is Marshall's *Principles of Economics*, vol. 1. (1st edition, 1890; 4th edition, 1908). J. Shield Nicholson's *Principles of Political Economy* (3 vols.) not only gives a survey of economic principles since Mill's time, but contains much suggestive and original work. The writer of this article is much indebted to the works of Schmoller, particularly his *Grundriss der allgemeinen Volkswirtschaftslehre* (1900), and Adolph Wagner, particularly his *Grundlegung der politischen Ökonomie*. On the history of economic theory, Cannan's *History of the Theories of Production and Distribution* (1776-1848) is an admirable criticism, from a purely objective standpoint, of the works of the English classical writers. The most important English works published in recent years on general English economic history are W. Cunningham's *Growth of Industry and Commerce*, and W. J. Ashley's *Economic History*, while Vinogradoff's *Villainage in England and The Growth of the Manor*, as well as Mitland's *Domestic Studies*, are of great importance to the student of early economic institutions. D'Avenel's *Histoire économique de la propriété, &c.* (1200-1800) is a monumental work on the history of prices in France. Other books dealing with special subjects are likely to take a very high place in economic literature. We may mention particularly Charles Booth's *Life and Labour of the People in London*, B. S. Rowntree's *Poverty*, Sidney and Beatrice Webb's *History of Trade Unionism and Industrial Democracy*, and Dr Arthur Shadwell's *Industrial Efficiency* (1906). These books are generally regarded as typical of the best English work of recent years in economic investigation. We may also mention Schloss's *Methods of Industrial Remuneration*, a most important contribution to the study of the wages question; C. F. Bastable's works on *International Trade and Public Finance*; George Clare on the *Money Market and the Foreign Exchanges*; and A. T. Hadley's *Economics: An Account of the Relations between Private Property and Public Welfare* (1896). Studies of particular questions both concrete and theoretical, in foreign languages are too numerous

to specify, and much of the best modern work is to be found in economic periodicals. (W. A. S. H.)

ECONOMY, a township and a village of Beaver county, Pennsylvania, U.S.A., on the E. bank of the Ohio river, 17 m. N.W. of Pittsburg. Pop. of township (1900) 1062; (1910) 860. The village is served by the Pennsylvania system. It was owned until 1904, when it was sold to a land company, by the Harmony Society (see COMMUNISM), commonly called the Economites, Harmonists or Rappists. The founder, George Rapp, after living with his would-be primitive Christian followers at Harmony, Butler county, Pennsylvania, in 1803-1814, and in 1815-1824 in New Harmony (q.v.), Indiana, which he then sold to Robert Owen, settled here in 1824 and rapidly built up a village, in which each family received a house and garden. The culture of silk, flax, grapes (for wine-making) and fruits and cereals in general, and the manufacture of flour and of woollen, flannel and cotton fabrics, were carried on under a rule requiring every adult to labour 12 or 14 hours each day in field or mill. Celibacy had been adopted in 1807 as the rule of the community. New members were received after a half-year's probation, and members who left received their original investment. Three hundred thus separated from Rapp in 1833, with \$105,000 as their share of the communal property, to build the millennial kingdom of New Jerusalem at Phillipsburg (now Monaca), Beaver county, Pennsylvania, under the lead of Bernhard Müller, who had come to Economy in 1831 as a fellow religionist, and was called Count Maximilian de Leon (or Prolé); in 1833 Leon went, with his followers, to Louisiana, and established a religious colony 6 m. from Natchitoches. After his death his wife until 1871 was head of a similar community at Germantown in Webster parish. The Harmonists at Economy flourished under the rule of a tradesman, R. L. Baker, or Romelius Langenbacher, after the death of Rapp in 1847, and during the Civil War had about \$500,000 buried away. Their numbers were for a time kept up by the addition of fresh converts, but the employés who were not Harmonists soon greatly outnumbered the members of the community, the basis of which was always religious. Baker died in 1868, and his successor, John Henrici, in 1892, when John S. Duss became first trustee. In 1907 there were only two or three members in the society. In 1851 the township of Harmony was set apart from Economy.

See Morris Hillquit, *History of Socialism in the United States* (New York, 1903); William A. Hinds, *American Communities* (revised edition, Chicago, 1902); John L. Bole, *The Harmony Society* (Philadelphia, 1904); Charles Nordhoff, *The Communist Societies of the United States* (New York, 1875); and among several excellent monographs in German, Karl Knortz, 1892, *Die christlich-kommunistische Kolonie der Rappisten* (Leipzig, 1892), and J. Hanno Deiler, *Eine vergessene deutsche Kolonie: eine Stimme zur Verteidigung des Grafen de Leon* (New Orleans, 1900).

ECONOMY, a word ranging in application from the careful thrift of an individual to the systematic arrangement of an organization. It is derived from the Gr. *oikonomia*, the management (*stéueiv*, to control) of an *oikos* or house, extended in meaning to the administration of a state. Of its original sense, the art or science of managing a household, the expression "domestic economy" survives, but the principal use in this sense is confined to the thrifty management of the financial resources of a household or of an individual. It is thus used as equivalent to "saving," not only of money, but of time, labour or effort, and, generally, of the least expenditure of means to attain a required end. It is on the principle of "economy" that many phonetic changes occur in the development of languages, and, in aesthetics, the name has been applied to a principle or law that effects are pleasant in proportion to the smallness of the effort made, and of the means taken to produce the result. The phrase "economy of truth" is due to an individual application of the use, in patristic theology, of the word *oikonomia* for the careful presentation of such doctrine as would be applicable to the hearer (see J. H. Newman, *History of the Arians of the 4th Century*). "Economy" is also used in theology in such expressions as "Mosaic" or "Christian economy" as a synonym of "dispensation," for the administration of the world

by God at particular times or for particular races. From the meaning of organization or administration of a house or state the word is applied more widely to the ordered arrangement of any organized body, and is equivalent almost to "system"; thus the "economy" of nature or of animal or plant life may be spoken of. The most common use, however, of the word is that of "political economy," the science dealing with the production, distribution and consumption of wealth (see ECONOMICS).

ECSTASY (Gr. *ἔκστασις*, from *ἔξω*, put out of its place, alter), a term applied to a morbid mental condition, in which the mind is entirely absorbed in the contemplation of one dominant idea or object, and loses for the time its normal self-control. With this there is commonly associated the prevalence of some strong emotion, which manifests itself in various ways, and with varying degrees of intensity. This state resembles in many points that of catalepsy (q.v.), but differs from it sufficiently to constitute it a separate affection. The patient in ecstasy may lie in a fixed position like the cataleptic, apparently quite unconscious, yet, on awaking, there is a distinct recollection of visions perceived during this period. More frequently there is violent emotional excitement which may find expression in impassioned utterances, and in extravagant bodily movements and gesticulations. Ecstasy usually presents itself as a kind of temporary religious insanity, and has frequently appeared as an epidemic. It is well illustrated in the celebrated examples of the dancing epidemics of Germany and Italy in the middle ages, and the *Convulsionnaires* of St Medard at the grave of the Abbé Paris in the early part of the 18th century, and in more recent times has been witnessed during periods of religious revivalism. (See also INSANITY and NEUROPATHOLOGY.)

ECTOSPORA, a homogeneous and natural division of Protozoan parasites included under the Sporozoa; they comprise the three orders, Gregarines, Coccidia and Haemosporidia. The defining character of the Ectospora is that the spore-mother-cells (sporoblasts) are formed at the periphery of the parent-individual (sporont); we may, however, go further, and say that the formation of all the different reproductive elements is uniformly peripheral or exogenous. Two other very general features are (a) that the individual trophozoite is uninuclear, and (b) that growth and trophic activity are finished before the multiplicative or reproductive phase sets in.

There is now little doubt that the Ectospora possess a flagellate ancestry. The principal facts in favour of this view are as follows: the actual ontogenetic connexion known to exist between certain Haemoflagellates and certain Haemosporidia (see TRYPANOSOMES); the possession by many Coccidia of biflagellar microgametes (male elements), whose general structure greatly resembles that of a Heteromastigine Flagellate; the possession by various parasitic Flagellates (e.g. *Herpetomonas*) of an attached, resting phase, when the parasites become gregariniform, which strongly suggests the attached phase of many young, growing Gregarines; the typical gregarinoid and euglenoid movements of Gregarines and of the germs or other stages of Coccidia and Haemosporidia, which are quite comparable with the contractile and metabolic movements of Flagellates; and, lastly, the exogenous type of reproduction, which is easily derivable from the multiple division of certain Haemoflagellates, and this, in turn, from the typical binary longitudinal fission of a Flagellate.

ECUADOR (officially *La República del Ecuador*), a republic of South America, bounded N. and N.E. by Colombia, S.E. and S. by Peru, and W. by the Pacific Ocean. Its boundary lines with Colombia and Peru were in 1909 still unsettled, large areas of territory being claimed by all three republics. Under an agreement of the 15th of December 1894, the disputes were to be decided by the Spanish sovereign as arbitrator, but nothing was accomplished. On the 5th of November 1904, Colombia and Ecuador agreed to submit their dispute to the German emperor, and a convention of the 12th of September 1905 between Colombia and Peru established a *modus vivendi* for the settlement of their conflicting claims, in which Ecuador is likewise interested. The maps of Ecuador, which are very defective, usually describe its territory as

extending eastward to the Brazilian frontier, but as Peru is in actual occupation of the region east of Huiririma-chico, on the Napo river, $3\frac{1}{2}$ degrees west of that frontier, those maps cannot be considered correct. The Trans-Andine territory occupied by Ecuador is a wedge-shaped area between the Coca and Napo,

the Andes enclosing highly fertile valleys, and by low, isolated ranges between the larger river courses, and traversed by large rivers flowing into the Napo and Marañon. This region has been only partially explored, and but little is known of the large areas lying between the navigable rivers.

The Inter-Andine or plateau region lies in and between the two great mountain chains which cross the greater part of the republic between and almost parallel with the 78th and 79th meridians. The eastern chain is known as the Andes of Ecuador, or the Cordillera Oriental, and the western as the Cordillera Occidental (Western Cordillera). Starting from the confused grouping on the southern frontier of the two great chains and some transverse ranges, they run nearly north by east to the Colombian frontier where another "knot" or junction occurs. The summits of the western range form a line of noteworthy regularity, but those of the eastern form a broken irregular line of varying distances from the first. The elevated plateaus between the two great chains, which is about 300 m. long and 20 to 30 m. wide, is divided into three great shallow basins or plains by the transverse ridges or *paramos* of Tiupullo and Amay. These are known as the Quito, Ambato and Cuenca basins. South of the latter is the irregular and deeply broken Loja basin, which can hardly be considered a part of the great Ecuador plateau. The three great basins, which are broken and subdivided by mountainous spurs and ridges, descend gradually toward the south, the Quito plain having an average elevation of 9500 ft. above the sea, Ambato 8900, and Cuenca 7800. They are also characterized by the increasing aridity of the plateau from north to south, the Quito plain being



fertile and well covered with vegetation, and the Ambato and Cuenca plains being barren and desolate except in some favoured localities. The volcanic character of the region is likewise responsible for large areas of barren surfaces. Rising from this elevated plateau, along its eastern and western margins are the Cordilleras with their principal summits culminating far above the line of perpetual snow, which in this region is about 15,750 ft. above the sea. These summits are remarkable, not only for their great height, but also for their apparent symmetrical arrangement in parallel lines, sometimes in pairs facing each other across this cyclopean passage. Nowhere in the world can there be found another such assemblage of snow-clad peaks, several of which are active volcanoes. There are 22 of them grouped around these central plains almost within sight of each other. The western chain has the distinction of having the highest summit, the eastern the greatest number of high summits and the highest average elevation. From the time of Humboldt's visit to this remarkable region down to the present time there have been many diverse calculations of the height of these peaks, but with a considerable variation. It is estimated that there was a considerable decrease in the elevation of this part of the Andes during the past century, Quito having sunk 26 ft. in 122 years, Pichincha 218 ft. in the same time, and the farm of Antisana, where Humboldt resided for a time, 165 ft. in 64 years. At the same time Cotopaxi and Sangay, the two active volcanoes, have actually increased in elevation since the measurement of La Condamine in 1742. These changes in elevation, if correct, are due to seismic disturbances, a cause that may be partially responsible for the varying computations of the heights of these well-known peaks. Among modern investigators are W. Reiss and A. Stübel (1871-1873), and Edward Whymper (1880), whose measurements of the principal summits were—

Physical Geography.—The surface of Ecuador may be divided into three distinct regions: the Cis-Andine lying between the Western Cordillera and the coast; the Inter-Andine, which includes the two great mountain chains crossing the republic with the elevated plateau lying between; and the Trans-Andine, lying east of the Andes in the great Amazon valley. The first part consists of an alluvial, low-lying plain formed in great part by the detritus brought down by the mountain streams. It is irregular in form and is broken by isolated elevations and spurs from the Cordillera. Large areas are still subject to annual inundations in the rainy season, and the lower river courses are bordered with swamps. This is the most fertile and productive part of Ecuador, especially on the higher lands near the Cordillera. The Trans-Andine region is similar to the neighbouring territories of the upper Amazon basin occupied by Colombia, Brazil and Peru—a great forest-covered plain descending gently toward the east, broken on its western margin by short spurs from

the Andes enclosing highly fertile valleys, and by low, isolated ranges between the larger river courses, and traversed by large rivers flowing into the Napo and Marañon. This region has been only partially explored, and but little is known of the large areas lying between the navigable rivers.

Eastern Cordillera.

Western Cordillera.

	Ft.		Ft.
Cayambe . (W.)	19,186	Cotacachi . (W.)	16,301
Sara-Urcu . "	15,502	Mojanda . (W. & S.)	14,088
Antisana . "	19,335	Pichincha . (R.)	15,918
Sincholagua . (R. & S.)	16,265	Atacazo . (R. & S.)	14,892
Rumibagui . "	15,607	El Corazon	
Cotopaxi . (W.)	19,613	(Chamalan). (W.)	15,871
Tungurahua . (R. & S.)	16,690	Illinza . (R. & S.)	17,405
Altar (Capac-Urcu) . "	17,730	Carahuairazo . (W.)	16,515
Sangay . "	17,464	Chimborazo . "	20,498

The Imbabura volcano, celebrated for its destructive eruptions of mud and water, stands midway between the two ranges at the northern end of the plateau, and belongs to the transverse ridge of knot (*nudo*) which unites them. It is the most northern of the higher peaks of Ecuador, with the exception of Cotacachi, and possibly of Chile on the Colombian frontier, and reaches the elevation of 15,033 ft. Ibarra on the northern flanks of the volcano has suffered severely from its eruptions. The name is derived from *imba*, fish, and *burra*, mother, and is said to have originated from the quantities of a fish called "preñadilla" (*Pseudodus cynodon*) discharged from its crater during one of its eruptions—a phenomenon which, after a searching investigation, was discredited by Wagner. Cayambe, or Cayembí, the second highest peak of the Ecuadorian Andes, has a noteworthy distinction of standing very nearly on the equator. Its base covers a large area, and its square top, rising far above the snow-line, is one of the sights of Quito. Antisana is crowned with a double dome, and is described as an extinct volcano, though Humboldt saw smoke issuing from it in 1802. On its western side is the famous *hacienda* (farm) of Antisana, 13,306 ft. above the sea, where Humboldt resided for several months in 1802. Sara-Urcu stands south-east of Antisana in a densely forested region, drenched with rain and only slightly explored. Sincholagua and Rumiñahui are the next two peaks, going southward, and then the unrivalled cone of Cotopaxi (q.v.)—the highest active volcano in the world—from whose summit smoke curls upward unceasingly.

Llanganati or Cerro Hermoso is chiefly known through the tradition that the treasures of the Incas were buried in a lake on its slopes. It consists of a group of summits, the highest being credited with 17,843 ft. Tunguragua, or Tungurahua, has a cone-shaped summit like that of Cotopaxi, with a slope of 38°. It rises from a plain somewhat lower than the neighbouring central plateau and stands free from the surrounding elevations, except on the south, which give it an exceptionally imposing appearance. Among its characteristic features is a cataract fed by melting snows, which descends 1500 ft. in three leaps, and an enormous basaltic lava-stream which crosses the face of the mountain in a north-easterly direction. Its most notable eruption was in 1777. It has been sometimes classed among the extinct volcanoes, but smoke has been seen issuing from it at different dates, and a violent eruption occurred on January 12, 1886. The fertile cultivated valley of Baños, with its thermal springs, lies at the base of Tunguragua, which F. Hassaurek describes as "the most beautiful of all the snow peaks in the country." The next in line is El Altar, which the natives call Capac-Urcu ("king mountain"), whose broken cone and impressive outlines make it one of the most attractive mountains of Ecuador. Its summit comprises a group of eight snow-clad peaks, and its crater is surrounded by a steep and jagged wall of rocks. There is a tradition that this mountain was once higher than Chimborazo, but a series of eruptions caused the cone to fall in and reduced its summit to its present altitude and broken appearance. Altar has shown no signs of activity since the discovery of America. Sangay, or Sangai, the next and last large volcano to the south, is in a state of frequent eruption, however, and is known as one of the most restless volcanoes of the world. Since the Spanish conquest it has been in a state of uninterrupted activity, but no damage has been done, because there are no civilized settlements in its immediate vicinity. Though of great interest to scientific investigators because of its unceasing activity, and of its peculiar position in the Andean system, and because of the difficult and dangerous country by which it is surrounded, Sangay has been but rarely visited by European travellers. Its eruptions are not on a grand scale, but small outbursts of lava and explosions of steam occur at frequent intervals, and at longer intervals more violent explosions in which the molten rock is thrown 2000 ft. above its summit, and ashes are carried away as far as the streets of Guayaquil.

Turning to the Cordillera Occidental and taking the principal peaks in order from south to north, the first to claim attention is Chimborazo (from *Chimpu-rasa*, "mountain of snow"), the highest summit of Ecuador, and once believed to be the culminating point of the Andes. Humboldt, who unsuccessfully attempted its ascent in 1802, gives its elevation as 21,423 ft., Reiss and Stübel as 20,703, and Whymper as 20,498. It stands 76 m. north-east of Guayaquil, and, according to Spruce, rises majestically from the valley of the Guayas, on the west, without a "positive break from the summit down to the plain." This, however, is erroneous, for Whymper located a detached range running parallel with the Cordillera on the west, for a distance of 65 m. with the Chimbo valley between them. The magnitude of its mass is imposing from almost any point of view, but it can be most fully appreciated from its western or Pacific side, where its base is covered with forest up to the snow-line, above which its pure white cone rises another 5000 ft. An unobstructed view of the great mountain is rarely obtained, however, because of the mists and clouds which cover its cone. Its summits were reached for the first time in 1880 by Edward Whymper, all previous attempts having failed. It is considered to be an extinct volcano because it makes the plumb-line deviate only 7" to 8", from which it is deduced that the mountain is hollow. Moreover, the calcined matter resembling white sand which covers its sides below the snow-line, extensive beds of lava, and the issue of streams of hot water from its northern side, seem to confirm the deduction that

Chimborazo is an extinct volcano. Immediately north of Chimborazo, and separated from it by only a narrow valley, are the lower triple summits of Carahuairazo, or Carguairazo (which the natives call *Chimborazo-embra*, "Chimborazo's wife"), whose hollow cone collapsed in 1698 during a great earthquake, and left the jagged rim which adds so much to its present picturesque appearance. Mr Whymper's measurement is for the middle peak. Quirotoa, still farther north, is supposed to have suffered a similar catastrophe. Its hollow summit, 13,510 ft. above sea-level, now contains a large lake. Iliniza, which stands west by north of Cotopaxi, has two pyramidal peaks, and is one of the most interesting mountains of the Ecuadorian group. It stands at the western end of the Tupullo ridge, and overlooks the Quito basin to the north-east. The French academician Bouguer, who was chief of the scientific commission sent to Ecuador in 1736 to measure a degree of the meridian on the equator, made a trigonometrical measurement of Iliniza, and Wagner ascended to within 800 ft. of its summit in 1859. The geological structure of the mountain furnishes no evidence of volcanic activity. Chamalari, which the Spaniards called El Corazon from its heart-shaped appearance, is similarly destitute of a crater. It overlooks the Quito basin and has been ascended many times. Among the earlier explorers to reach its summit were Bouguer and La Condamine, Humboldt and Bonpland, and José Córdas, the Granadian naturalist. Atacazo is an extinct volcano, with nothing noteworthy in its appearance and history. Pichincha, its famous neighbour, is apparently of later origin, according to Wagner, and of slightly lower elevation. Perhaps no Ecuadorian volcano is better known than Pichincha, the "boiling mountain," because of its destructive eruptions and its proximity to the city of Quito. Its summit comprises three groups of rocky peaks, of which the most westerly, Rucu-Pichincha (Old Pichincha), contains the crater, a funnel-shaped basin 2400 ft. deep and about 1500 ft. wide at the bottom, whose walls in places rise perpendicularly and in others at an angle of 20°.

The exterior of the cone has an angle of 30°. Bouguer and La Condamine were the first to reach its brink in 1742, after which Humboldt made the ascent in 1802, Boussingault at Hall in 1831, García Moreno and Sebastian Wise in 1844 and 1845 (descending into the crater for the first time), García Moreno and Jameson in 1857, Farrand and Hassaurek in 1862, Orton in 1867, and Whymper in 1880. Farrand spent more than a week in the crater trying to get some good photographic views, and Orton has given a graphic description of his experiences in the same place. He found that the real cone of eruption was an irregular heap 250 ft. in height and 800 ft. in diameter, containing about 70 vents. The temperature of the vapour within the fumarole was 184°, and water boiled at 189°. There have been five eruptions of Pichincha since the Spanish conquest—in 1539, 1566, 1575, 1587 and 1660. The second covered Quito 3 ft. deep with ashes and stones, but the last three were considered as the most destructive to that city. The last happily broke down the western side of the crater, which, it is believed, will ensure the city against harm in any subsequent eruption. Since the earthquake of August 1867 Pichincha has sent forth dense masses of black smoke and great quantities of fine sand. Cotacachi is a double-peaked mountain, rising from an extremely rough country. It was ascended by Whymper in 1880. All the higher summits of Ecuador have true glaciers, the largest being found on Antisana, Cayambe and Chimborazo. Whymper located and named no less than eleven on Chimborazo, and counted twelve on Cayambe.

There are two distinct hydrographic systems in Ecuador—the streams that flow south-eastward to the Marañón, or Amazon, and those which flow westward to the Pacific. The southern part of the great central plateau is arid and has a very light rainfall, it has no streams, therefore, except from melting snows, and the higher elevations which receive the impact of the easterly winds. Farther north the rainfall becomes heavier, the plateau is covered with vegetation, and a considerable number of small rivers flow westward through the Cordillera to the Pacific. The Eastern Cordillera, or Andes, forms the water-parting between the two systems. The largest of the eastward-flowing rivers is the Napo, which rises in the eastern defiles of Cotopaxi and Sincholagua—the principal source being the Rio del Valle, which traverses the Valle Vicioso. It at first flows south by east, and at the village of Napo is 1450 ft. above sea-level, at the mouth of the Coca 858 ft., at the mouth of the Aguaciro 586 ft., 500 at the mouth of the Curaray, and 385 at its junction with the Marañón. Orton estimates its current at Napo in the month of November as 6 m. an hour; in the next 80 m. the river falls 350 ft. and produces a fine series of rapids; and from Santa Rosa downwards the rate is not less than 4 m. an hour. Its breadth at Napo is only 120 ft., but at Coca it has widened to 1500 ft., and at its mouth to nearly 1 m. Like most of the large Amazon tributaries, its discharge into the Marañón is through several distinct channels. The Napo is navigable for steamboats for some distance above the mouth of the Coca, and thence for canoes as far as the Cando cataract, 3332 ft. above the sea. Its total length is 920 m. The principal tributaries of the Napo are the Coca and Aguaciro from the north, and the Curaray from the south. The Coca rises on the eastern slopes of the Andes near Cayambe and the Guamaní range, and flows eastward near the equator to San Rafael (about 76° 30' W. long.), where it turns sharply southward to a junction with the Napo in about lat. 1° S., long. 76° W. The

Coca forms the provisional boundary line between Ecuador and Colombia from its source to the Napo. The Aguarico also rises on the eastern slopes of the Andes north of Cayambe and flows south-eastward to a junction with the Napo in about long. 75° W., its length being roughly estimated at 400 m. Little is known of its course, or of the country through which it flows, which is provisionally occupied by Colombia. The Curaray has its sources in the defiles of the Cerros de Llanganati, and flows south-eastward to the Napo, its length being estimated at 490 m. Its lower course is sluggish, where its waters are made unpalatable by a reddish slime. The Napo and its tributaries are celebrated in the early history of South America as the route by which Gonzalo Pizarro and Orellana first reached the Amazon, and it was afterwards the principal route by which the early expeditions across the continent at this point connected the Andean Plateau with the Amazon. The other rivers which flow through the Oriente territory of Ecuador into the Marañon are the Tigre, Pastaza, Morona and Santiago. The Tigre, of which little was known until a recent date, is formed by the confluence of the Cunambo and Huiyuivacu, whose sources are on the eastern slopes of the Andes near those of the Curaray. Its length below this confluence is 416 m., into which are received 109 tributaries, the largest of which are the Pucacuro and Corrientes. The Tigre is navigable at all stages up to the Cunambo confluence, and promises to afford one of the most valuable river routes in Ecuador. It enters the Marañon very near the 74th meridian. The Pastaza, or Pastassa, unlike the rivers already described, has its source on the central plateau west of the principal chain of the Andes, within the shadow of Cotopaxi, and breaks through the Cordillera to the north of Tunguragua. After flowing southward along the base of the high Andes for a short distance and receiving a number of torrents from the snowclad heights, it turns south-eastward across the plain and enters the Marañon about 70 m. above the mouth of the Huallaga. The stream is known as the Patate down to its junction with the Chambo, near Baños, and is not called Pastaza until the Agyoan falls are passed. It was navigated by Don Pedro Maldonado as early as 1741, and is navigable for steamboats of 2 to 4 ft. draft up to the mouth of the Huasaga (about 124 m.) in times of high water, and for canoes nearly 200 m. farther. The Pastaza, however, is subject to irresistible floods caused by the sudden rising of the mountain torrents on its upper course, especially the Toro, which sweep down with such fury that navigation on the river is practically impossible. The shallowness of the lower stream, where the current is sluggish, is probably due to the great quantities of silt brought down by these floods. Many of the rivers of eastern Ecuador are subject to similar floods from the Andean slopes, which have cut away broad, deep channels, through the adjacent plains, leaving long, narrow ridges between their courses which the natives call *cuchillas*. The Morona is formed by the confluence of the Manhuasita and Cangaima about 310 m. above its mouth, and is freely navigable for small steamboats to that point. The two confluent just mentioned have their sources in the Andes, and flow for some distance across the plain before uniting to form the Morona. Both are navigable for considerable distances. The Morona follows a very tortuous course before entering the Marañon, at long. 70° W., and receives a large number of affluents, one of which serves as the outlet for Lake Rimachuma, in Peruvian territory. Very little is definitely known of the affluents of the Morona, Pastaza and Tigre, as the territory through which they run has been but slightly explored. The Santiago, which enters the Marañon near the Pongo de Manseriche, is formed by the confluence of the Paute, which rises in the province of Azuay, and the Zamora, which has its source among the mountains of Loja. According to Alexander Garland (*Peru in 1900*), the rivers of eastern Ecuador are navigable at low water for steamers of 2 to 4 ft. draft for an aggregate distance of 1593 m., as follows:—

	Miles.
Napo, to the mouth of the Aguarico	559
Curaray, up to Canonaco	286
Tigre, up to Cunambo-Huiyuivacu confluence	416
Pastaza	31
Morona, up to the Rarayacu	211

These same rivers are navigable at high water for steamers of 193 ft. draft for an aggregate distance of 1330 m., including 68 m. of the Aguarico, and for steamers of 2 to 4 ft. draft for an additional 733 m. The last aggregate includes an extension of 93 m. on the Pastaza, 99 on the Morona, 186 on the Napo, and the balance on the Manhuasita, Cangaima, Pucacuro, Corrientes, Cunambo and Huiyuivacu.

On the western versant of the Andes of Ecuador there are three river systems of considerable size—the Mira, the Esmeraldas and the Guayas. The sources of the first—the Rioblanco, Pisco and Puntal—are to be found on the northern slopes of the transverse ridge which culminates in the Imbabura volcano. Its course is north and north-west to the Colombian frontier, thence westward and north-west to the Pacific, breaking through the Western Cordillera on its way. It forms the boundary line for some distance between Ecuador and Colombia, but near its mouth where the river turns northward Colombia has taken possession of the left bank and all the territory covered by its large delta. Its principal tribu-

aries on the left are the San Pedro, Paramba, Cachiayacu, Chachavi and Canumbi, and on the right the San Juan, Caiquer and Nulpe. The delta channels of the Mira are navigable, being tributary to the Colombian port of Tumaco. The Esmeraldas drains all that part of the central plateau lying between the transverse ridge of Tipulullo on the south and the Imbabura ridge on the north, together with the western slopes of the Cordillera between Iliniza and Cotacachi, and a considerable part of the lower plain. It is formed by the confluence of the Quininde and Toachi with the Guailabamba between 40 and 50 m. above its mouth, and discharges into the Pacific in lat. 1° N., long. 79° 40' W., through a narrow and precipitous gorge. The volume and current of the river is sufficient to freshen the sea 2 m. from the coast. The Guailabamba is the larger and more important tributary, and should be considered the main stream. It rises in the Chillo valley in the vicinity of Cayambe, and flows across the northern end of the central plateau, breaking through the Western Cordillera between Cotacachi and Pichincha. One of its plateau tributaries, Rio Pedregal, rises on the slopes of Cotopaxi and is celebrated for its three beautiful cascades, the highest of which is about 220 ft. The Toachi and Quininde have their sources on the western slopes of the Cordillera. The Guayas or Guayaquil river is in part an estuary extending northward from the Gulf of Guayaquil, bordered by mangrove swamps and mud banks formed by the silt brought down from the neighbouring mountains. All the bordering country on both sides is of the same description, and for a long distance inland extensive areas of swampy country are submerged during the rainy season. Above the mouth of the Daule the river is known as the Bodegas, which in turn is formed by the confluence of the Babahoyo and the Vinces. The Guayas also receives a large tributary from the east called the Yaguachi. All these streams are navigable on their lower courses, regular steamboat communication being maintained on the Guayas and Bodegas to a river port of the latter name, 80 m. above Guayaquil, and for 40 m. on the Daule. The navigable channels of all the rivers are computed at 200 m. The drainage basin of the Guayas, according to Theodor Wolf, covers an area of 14,000 sq. m., and includes the greater part of the lower plain and the western slopes of the Cordillera Occidental as far north as Iliniza. The Babahoyo, which is the main stream, has its sources on the slopes of Chimborazo, the Daule on the Sandomio ridge in the latitude of Pichincha, the Yaguachi on the south-eastern slopes of Chimborazo, whence it flows southward for a considerable distance before breaking through the Cordillera to the western plain. The Guayas is one of the most interesting and varied of the South American river systems, and is of great economic importance to Ecuador. In addition to these three river systems, there are a large number of short streams on the coast flowing into the Pacific and Gulf of Guayaquil, only two of which have any special importance in the present undeveloped state of the country. These are the Santiago, which drains several fertile valleys in northern Esmeraldas and western Carchi, and whose outlet is connected with some navigable tide-water channels, including the Pailon basin and the Carques, or Caracas, on which is located the village of Bahía de Carques (lat. 0° 34' S., the nearest port to the city of Quito).

There are a considerable number of small lakes in Ecuador, but no large ones. These are of two classes—those of the bowl-like valleys and extinct craters of the mountainous region, and the annual overflow of the rivers. It is impossible to say how many of the latter there may be, for much of the territory where they are found is unexplored. They are usually shallow and malarial. Among the upland lakes, there are some of special interest because of their position and historical association. The Yaguar-cocha ("lake of blood"), in the province of Imbabura, near Ibarra, which is only 1½ m. in circumference, is celebrated for the tradition that Huayna-Capac, one of the great conquerors of the Inca dynasty, defeated an army of rebellious Carranquis on its shores, and threw so many of their bleeding corpses into it as to turn its waters to the colour of blood. On the south-east skirt of Cotacachi, 10,200 ft. above the sea, is the beautiful little Cuy-cocha, which originated, it is believed, through the falling in of the mountain's sides. There are two others of apparently the same origin on the north-west slopes of the Mojanda volcano, but they are less attractive because of their gloomy surroundings. In the deep valley between the mountains of Imbabura and Mojanda is the lake of San Pablo, 8848 ft. above the sea. It is one of the largest of its class, being about 5 m. in circumference, and is situated in an exceptionally fertile region. It drains through the Peguico into the Rio Blanco, a tributary of the Mira. Other well-known lakes of the plateau region are Quiroto, about 4600 ft. in diameter; Colta, east of Riobamba, and Colay, south of the same place. Among the many thermal springs throughout the Andean districts, the best known are at Belermons and San Pedro del Tingo, north-east of Quito; at Cachillacta, in the district of Nanegal; at Timbugpoyo, near Latacunga; at Baños (5906 ft. elevation), near the foot of Tunguragua; and on the slopes of Rumifaguí and Chimborazo.

The coast of Ecuador extends from about lat. 1° 20' N. to the vicinity of the Boca Jambeli on the southern shore of the Gulf of Guayaquil, in lat. 3° 14' S., and has an outward curve. Its more prominent headlands are Punta Galera, Cabo Pasado, Cabo de San Lorenzo and La Puntilla, or Santa Elena

Point. The bays on this coast are commonly broad indentations, and the rivers discharging into them are generally obstructed by bars. The small ports along the coast, therefore, do not afford much protection to shipping. The most northern of these bays is the Ancon de Sardinias, lying south of the Mira delta. The head of the bay is fringed with islands and reefs, behind which is the mouth of the Santiago river, Pova Harbour, San Lorenzo Bay, Pailon basin and a network of navigable channels, all of which are difficult of access. The small ports of La Tola and Pailon are located on these waters. The port of Esmeraldas, near the mouth of the Esmeraldas river, is located near the southern entrance to this bay. As the mouth of the river is obstructed by a bar and its current is swift, the anchorage is outside in an open roadstead, only slightly protected on the south. Farther south is the broad Bay of Manta, with a small port of the same name at its southern extremity. The most frequented port on this part of the coast is that of Bahía de Caráquez, at the mouth of the Caráquez, or Caracas river, which is also obstructed by a bar. There is a fertile, productive country back of this port, and it is the objective point of a road from Quito. Immediately north of the Gulf of Guayaquil is the Bay of Santa Elena, with a small port of the same name, which has a good, well-sheltered anchorage and is the landing-place of the West Coast cable. The Gulf of Guayaquil, which lies between the Ecuadorean and Peruvian coasts, is the largest gulf on the Pacific coast of South America between Panama and Chile. Its mouth is 140 m. wide between La Puntilla on the north and Cabo Blanco on the south, and it penetrates the land eastward, with a slight curve northward at its head, for a distance of about 100 m., terminating in the Guayas estuary or river, on which is located the port of Guayaquil. The upper end of the bay and its northern shores are fringed with swamps through which numerous estuaries penetrate for some distance inland. Immediately west of the Guayas river the Estero Salado, which comprises a great many shallow tide-water channels, or bayous, penetrates as far inland as Guayaquil, but is used only by canoes. The upper end of the gulf is filling up with the silt brought down from the Cordillera. It is divided midway by the large island of Puna, at the eastern end of which is the anchorage for steamers too large to ascend the Guayas. The steamship channel passes between this island and the Peruvian coast, and is known as the Jambeli channel. The passage north of Puna Island is known as the Morro channel, but its entrance is obstructed by shoals and it is considered dangerous for shipping. A small port in the Jambeli channel, on the south-east shore of the gulf, is that of Puerto Bolívar, or Puerto Huaila, the shipping port for the town of Machala and the Zaruma mining region.

There are few islands off the coast of Ecuador, and only one of any considerable size—that of Puna in the Gulf of Guayaquil, which is 29 m. long from north-east to south-west and 8 to 14 m. wide.

Islands. It lies in the north-east part of the gulf, and is separated from the Ecuadorean mainland by the Morro channel, and from the southern mainland by the wider and deeper Jambeli channel. There is a low, mountainous ridge, called the Zampo Palo, running through it, and its eastern shores have some moderately high bluffs; otherwise the island is low and swampy, and its shores, except the eastern end, are fringed with mud banks. The island is densely wooded (in marked contrast with the opposite Peruvian shore), and is considered unhealthy throughout the greater part. It has a population of 200, chiefly centred in the village of Puna, at its north-east extremity, which is a shipping port and health resort for the city of Guayaquil. Puna Island is celebrated for its connexion with Pizarro's invasion of Peru in 1531. It is said that it had a considerable population at that time, and that the natives resisted the invaders so vigorously that it cost six months to reduce them. Midway in the outer part of the Gulf of Guayaquil is Amortajada or Santa Clara island, whose resemblance to a shrouded corpse suggested the name which it bears. It lies 12 m. south-west of Puna island and 80 m. from Guayaquil. It rises to a considerable elevation, and carries a light 256 ft. above sea-level. There are some low, swampy islands, or mud flats, covered with mangrove thickets, in the lower Guayas river, but they are uninhabited and of no importance. North of the Gulf of Guayaquil there are only two small islands on the coast of more than local interest. The first of these is Salango, in lat. 1° 25' S., which is 2 m. in circumference and rises to a height of 524 ft. It is richly wooded, and has a well-sheltered anchorage much frequented by whalers in search of water and fresh provisions. The next is La Plata, in lat. 1° 16' S., which rises to a height of 790 ft., and has a deep anchorage on its eastern side where Drake is said to have anchored in 1579 to divide the spoils of the Spanish treasure ship "Cacafuego." The Galapagos Islands (*q.v.*) belong to the republic of Ecuador, and form a part of the province of Guayas.

Geology.—The great longitudinal depression which lies between the eastern and the western branches of the Andes is also the boundary between the ancient rocks of the east and the Mesozoic

beds which form the greater part of the west of the country. The Eastern Cordillera is composed of gneiss, mica and chlorite schist and other crystalline rocks of ancient date; the Western Cordillera, on the other hand, is formed of porphyritic eruptive rocks of Mesozoic age, together with sedimentary deposits containing Cretaceous fossils. Most of the country between the Andes and the sea is covered by Tertiary and Quaternary beds; but the range of hills which runs north-west from Guayaquil is formed of Cretaceous and porphyritic rocks similar to those of the Andes. In the intra-andine depression, between the East and West Cordilleras, recent deposits with plant remains occur near Loja, and to the north-east of Cuenca is a sandstone containing mercury ores, somewhat similar to that of Peru. Farther north nearly the whole of the depression is filled with lavas, tuffs and agglomerates, derived from the Tertiary and recent volcanoes which form the most striking feature of the Andes of Ecuador. These volcanoes are most numerous in the northern half of the country, and they stand indifferently upon the folded Mesozoic beds of the Western Cordillera (e.g. Chimborazo, Ilinza, Pichincha), the ancient rocks of the Eastern Cordillera (Altar, Tunguragua, Cotopaxi, Antisana), or the floor of the great depression between them. The lavas and ashes are for the most part andesitic.

Climate.—Climatic conditions in Ecuador are very largely contingent on altitude, and the transition from one climate to another is a matter of only a few hours' journey. Although the equator crosses the northern part of the republic, only 15 m. north of the city of Quito, a very considerable part of its area has the temperature of the temperate zone, and snow-crowned summits are to be seen every day in the year from its great central plateau. In addition to the climatic changes due to altitude, there are others caused by local arid conditions, by volcanic influences and by the influence of mountain ranges on the temperature and rainfall of certain districts. These influences are not general; on the contrary, they often affect very limited areas. For instance, Guayaquil has a hot humid climate and mangrove swamps line the shores of Guayas down to the gulf; at Santa Elena, about 60 m. due west, arid conditions prevail and vegetation is scanty and dwarfed; at Salango island, 50 m. north of Santa Elena, there is an abundance of moisture and vegetation is luxuriant; 33 m. farther north, at Manta, the country is a desert; and at Atacames bay, 135 m. north of Manta, the rainfall and vegetation are again favourable. On the plateau similar conditions prevail. There is no great display of arboreal vegetation anywhere except in the valleys and lower passes where the rainfall is abundant, but in general terms it may be said that the rainfall and vegetation which characterize the Quito basin soon disappear as one proceeds southward, and are substituted by arid conditions. Even here there are local modifications, as at Ambato, where a shallow depression, surrounded by barren, dust-covered ridges exposed to cold winds, is celebrated for its warm, equable climate and its fruit. It is to be noted that the Gulf of Guayaquil separates the humid, forest-covered coastal plain of Ecuador from the arid, barren coast of Peru, the two regions being widely dissimilar. The mean annual temperature, on this plain, according to an official publication, is 82.4° F., and the range is from 66° to 95°. The heat is modified at many points on the coast, however, by the cold Humboldt current which sweeps up the west coast of South America from the Antarctic seas. The year is divided into a wet and dry season—the former running from December to June, and the latter from July to December. The rainy season, or *invierno*, is broken by a short period of dry weather, called the *veranillo* (little summer), shortly after the December solstice; otherwise it rains every day, the streams overflow, land traffic is suspended, and the air is drenched with moisture and becomes oppressive and pestiferous. The dry season, which is called the *verano*, or summer, is also broken by a short rainy spell called the *inviernillo* (little winter) or "cordón de San Francisco," which follows the September equinox. Apart from these the two seasons are sometimes broken by cloudless skies in winter, and a drizzling mist, called the *garúa*, in summer. In the inter-andine region the variations in temperature are frequent and the averages comparatively low. An official estimate gives the mean annual temperature as 64° to 68° between 6000 and 11,000 ft. In Quito the mean annual temperature is 58.8°, the diurnal variation 10°, the annual maximum 70°, and the annual minimum 45°. Other returns give the mean annual temperature at 55°. It is said that pulmonary tuberculosis is unknown in these altitudes, though it is common in the coast districts. Catarrhal complaints are common, however, and leprosy is widely prevalent, it being necessary to maintain three large hospitals for lepers. In the higher altitudes there are wide variations in the snow-fall and intensity of the cold even on the same mountain. The line of permanent snow is much higher on the plateau side in both ranges, the precipitation being greater on the outer sides—those facing the forested lowlands—and the terrestrial radiation being greater from the barren surfaces of the plateau. In some instances the difference in the elevation of the snow-line has been found to be fully 1000 ft. Moreover, no two summits seem to retain the snow permanently at the same altitude. For instance, in 1880 Whympfer found permanent snow on Cotacachi at 14,500 ft., while near by Imbabura was bare to its summit (15,033 ft.); Antisana was permanently covered at 16,000 ft., and near by Sara-Urcu, which is drenched with rains and mists from the Amazon valley

¹ See J. Siermiardzki, "Geologische Reisenotizen aus Ecuador," *Neues Jahrb. f. Min., Beil. Band iv.* (1886, pp. 195-227, pl. vii.); Th. Wolf, *Geografía y geología del Ecuador, publicada por orden del Supremo Gobierno de la República* (Leipzig, 1892); W. Reiss and A. Stübel, *Reisen in Süd-America. Das Hochgebirge der Republik Ecuador* (Berlin, 1892-1902).

all the year round, at 14,000 ft.; *Sincholagua* had large beds of permanent snow at 15,300 ft., Cotopaxi was permanently covered at 15,500 ft. on its western side, Corazon had daily snowstorms down to 14,500 ft., but no permanent beds of snow on its east side (elevation 15,871 ft.); and Chimborazo had deep snow at 15,600 ft. on its north-east and south sides in June-July. The eastern range was found to receive the heaviest snowfall. The elevation at which human residence is possible seems to be unusually high in Ecuador. Many of the towns and villages of central Ecuador lie at altitudes ranging from 8606 ft. (Ambato) to 9839 ft. (Machachi). The capital city of Quito is 9343 ft. above the sea, and is celebrated for its agreeable temperature and also for its healthiness in spite of prevailing unsanitary conditions. Above these towns are a number of farms and herdsmen's habitations, where men live the whole or a part of the year with less discomfort from low temperature than is experienced in northern Europe and northern United States. According to Whympfer, the *tambo* of Chuquiopuquio, at the foot of Chimborazo, is 11,704 ft., and the *hacienda* of Pedregal, near Iliniza, 11,629 ft., both being permanently occupied. The *hacienda* of Antisana, 13,306 ft., and the herdsmen's hut of Cunayaco on Chimborazo, 13,396 ft., are occupied only for a part of the year. The highest elevations are generally covered with ice and snow, and glaciers, according to Whympfer, are to be found upon no less than nine of the culminating peaks, and possibly upon two or three more. These serve to modify the temperatures of the plateau, which is swept by cold winds at all seasons of the year. The prevailing wind is that of the north-east and south-east trade winds, broken and modified on the plateau and western lowlands by mountain barriers. Westerly and north-west winds are sometimes experienced, but are not permanent.

Flora.—The flora of the Quito basin has been well studied by various European botanists, more especially by Dr William Jameson (1796-1873) of the university of Quito, who began the preparation of a synopsis of the Ecuadorian flora in 1864-1865 (*Synopsis plantarum Quituensium*, 2 vols., Quito, 1865). The flora of the forested lowlands on both sides of the Andes has not been studied and described so fully. From the Pacific coast upon to the height of about 3000 to 4000 ft. the vegetation is distinctively tropical, including among its economic products cacao, cotton, sugar, tobacco, rice, maize, yucca (also known as casava and mandioca), peanuts, bananas, sweet potatoes, yams, arracacha (*Conium macbatsum*, H. B. K., or *Arracacha esculenta*), indigo, rubber (*Castilloa*), ivory-nuts, cinchona and bread-fruits. Most of these become rare at 3000 ft., but a few, like sugar-cane, are cultivated as high as 8000 ft. The alluvial valley of the Guayas, above Guayaquil, is celebrated for the richness of its vegetation, which, in fruit alone, includes cacao, coffee, coco-nuts, pine-apples, oranges, lemons, guayavas (*Psidium pomiferum*), guavas (*Inga spectabilis*), shaddock (or grape-fruit), pomegranates, apricots, chirimoyas (*Annona Chirimolia*), granadillas (*Passiflora quadrangularis*), paltas (*Cecropia gratisima*, otherwise known as "alligator pears"), tunas (*Cactus*), mangoes (*Mangifera Indica*), pacayas (*Prosopis dulcis*), aji (Chile pepper), and many others of less importance. Besides rubber, the forests produce a great variety of cabinet and construction woods, ivory-nuts (from the "tagua" palm, *Phytelephas macrocarpa*), "toquilla" fibre (*Carludovica palmata*) for the manufacture of so-called Panama hats, cabbage palms, several species of cinchona, vanilla and dyewoods. Among the large trees which are valued for their timber are redwood (*Humiria balsamifera*), Brazil-wood, algarrobo, palo de cruz (*Jacquinia ruscifolia*), guaiacum or holy wood, rosewood, cedar and walnut. From 6000 to 10,000 ft. above the sea, the indigenous species include the potato, maize, oca (*Oxalis tuberosa*), and quinoa (*Chenopodium quinoa*), and the exotic species, wheat, barley, oats, alfalfa (*Medicago sativa*), and most of the fruits and vegetables of the northern temperate zone. Wheat does not form a head below 4500 ft., nor ripen above 10,500. The larger forest trees are rarely seen above 10,000 ft., and even then only on the outer slopes of the Cordilleras. The *Escallonia myrtilloides*, however, is found at an elevation of 13,000 ft., and the shrubby *Befaria* 400 or 500 ft. higher. A characteristic growth of the open plateau and upland valleys is the cabulla, cabaya, or magney (*Agave americana*), whose fibre is much used by the natives in the manufacture of cordage, sandals (*alparrizas*) and other useful articles. In the treeless region lying between 11,600 and 13,800, or in other places between 12,000 and 14,000 ft., the similarity of the vegetation to that of the corresponding European region; according to Wagner, is especially striking. On the *paramos* of Chimborazo, Pichincha, Iliniza, &c., the relation of characteristic genera to those identical with genera in the Alpine flora of Europe is as 5 to 4; and the botanist might almost suppose himself in the Upper Engadine. Of the flora of the highest Andes, Whympfer found 42 species, of various orders, above 16,000 ft., almost all of which were from Antisana and Chimborazo; 12 genera of mosses were found above 15,000 ft., and 59 species of flowering plants above 14,000 ft., of which 35 species came from above 15,000 and 20 species from above 16,000 ft. The highest specimen obtained was a lichen (*Lecanora subfusca*, L.) on the south side of Chimborazo, 18,400 ft. above sea-level. Mosses (*Grimmia*) were found on Chimborazo at 16,660 ft., ferns (*Polypodium pycnolepis*, Kze.) at 14,900, and specimens of *Gentiana rupicola*, H. B. K., *Achyrophorum quituense*, Sz. Bip., *Cuculium nitale*, H. B. K., at 16,300; *Phyllactis inconspicua*,

Wedd., at 16,600, *Astragalus geminiflorus*, H. B. K., at 14-15,000, *Geranium diffusum*, H. B. K., at 16,000, *Malvastrum phyllanthos*, Ass Gray, at 16,500, *Draba obovata*, Benth., at 16,660, and *Ranunculus praemorsus*, Kth., at 16,500—all on Chimborazo. *Fuchsia lasensis*, H. B. K., was found on the slope of Sara-Uru at 12,779 ft., and currant bushes (*Ribes glandulosum*, R. & P.), on Chimborazo, at 14,000. On the eastern slopes of the Andes, where the rainfall is continuous throughout the year and the atmosphere is surcharged with moisture, the forest growth is phenomenal. It is similar to that of the Colombian and Peruvian *montanae*, modified, if at all, by the excessive humidity which prevails in this region.

Fauna.—The fauna of Ecuador is comparatively poor in mammalia, but the birds and still more the insects are very numerous. The Quadrumanae are represented by a large number of species, the eastern forests being very much like the other parts of the great Amazonian basin in this respect. The Carnivora include the puma (*Felis concolor*), jaguar (*F. onca*), ocelot (*F. grisea*), bear (*Ursus ornatus*), fox, weasel and otter. A small deer and, in southern Ecuador, the llama (*Auchenia*) with its allied species, the alpaca, guanaco and vicuña, represent the ruminants. The rodents are numerous and include most, if not all, of the Amazonian species—the capybara (*Hydrochoerus capybara*), cavia (*C. aerea*), paca (*Coelogenys paca*) and cutia (*Dasyprocta aguti*), all amphibious and having an extensive range. Tapirs are to be found in the eastern forests, the peccary in more open woodlands, and the opossum in nearly every part of the country. Cattle, horses, asses, sheep and swine were introduced by the Spaniards, and thrive well in some of the provinces. Excellent horses are reared in the uplands, as well as mules and cattle, the pasturage on the mountain slopes being good, and alfalfa being grown in abundance in many districts. The Reptilia include countless numbers of alligators in the Guayas and its tributaries and in the tide-water channels of many of the smaller rivers; many species of lizards, of which Mr Whympfer found three in the Quito basin; snakes of every description from the huge anaconda of the Amazon region down to the beautifully marked coral snake; and a great variety of frogs and toads. Bats also are very numerous, especially in the eastern forest region, where the vampire bat is a serious obstacle to permanent settlement. The avifauna of Ecuador is distinguished for the great variety of its genera and species, among which are many peculiar to the Amazon valley, and others to the colder uplands. Among the Amazon species may be mentioned the parrot, macaw (*Macrocercus*), toucan (*Ramphastos*), curassow (*Cras*), penelope, trogon, and horned screamer (*Palmadusa cornuta*). There are also herons, ibises, storks and cranes, including the great black-headed white crane, *Mycteria americana*, which ranges from northern Argentina to Colombia. One species of ibis, the *Theristicus caudatus*, is to be found, it is said, only on the slopes of Antisana. Species of the pheasant and partridge are not uncommon, and the "guacharo" (*Steatornis caripensis*), once believed to inhabit Venezuela only, is found in Ecuador also. The Raptors are well represented by a large number of genera and species, which include the condor, eagle, vulture, falcon, hawk and owl. The condor (*Sarcocathartes gryphus*) is commonly found between the elevations of 6000 and 16,000 ft., rarely, if ever, descending to the lowland plains or rising above the lower peaks. It preys upon the smaller animals and inflicts much loss upon stock farmers through the destruction of calves, lambs, &c., but it very rarely ventures to attack man or any of the larger animals. The eagle common to Ecuador is the *Morphnus laeniatius*, and possibly the *M. guianensis* on the eastern slopes of the Andes. The harrier-eagle (*Herpethosia cachinnans*) is also to be found throughout this part of the continent. An eagle with buzzard-like habits, the *Leucopertis plumbea*, is likewise common in Ecuador. Among the vultures the turkey-buzzard group (*Rhino-gryphus* or *Cathartes*), including the *R. aurus*, *burrovianus* and *perniger*, is common everywhere. The carrion crow, or black vulture (*Cathartus atris*), is also common to every part of the country, and is the general scavenger. The carrion hawks are represented by the *Polyborus thorax*, popularly called the "caracara" and the *Phalacrocorax carolinensis*, the falcons by the *Aesalon columbarius*; and the kites by the *Gampsonus swainsoni*. The Ecuadorian owl is the *Bubo nigrescens*. An interesting species of the song birds is popularly known as the "flautero" (flute-bird), which inhabits the eastern forests. Its notes are marvellous imitations of "the most mellow, sweet-sounding flute," but the singer itself, according to Mr Simon, is "a very insignificant-looking little, greyish-coloured bird," which "always dies in captivity." The most interesting group of the smaller birds is that of the humming-birds, of which the number and variety is astonishing. Some of these have a very wide range, while others are apparently limited to a small district, or to a certain altitude. The best-known fish of Ecuador is the insignificant *Pimelodus cyclopus*, the only fish found in the streams and lakes of the plateau region. Its fame rests on Humboldt's publication of the tradition that great numbers of this tiny fish had been thrown out during the eruptions of Imbabura and other volcanoes. Mr Whympfer's explanation of the phenomenon is that the fish are scattered over the land by the sudden overflow during volcanic eruptions of the rivers and lakes which they inhabit. The rivers of the eastern plains are probably stocked with the fish found in the Amazon. On the coast, the Ancon de Sardinas bay is so named from the multitude of small fish (*sardinas*) which inhabit its

waters. Elsewhere there are no fisheries of importance, except those of the Galapagos Islands.

The insect inhabitants of Ecuador, like the birds, include a large number of genera and species, but no complete entomological survey of the country has ever been made, and our knowledge in this respect is insufficient to warrant a detailed description. In one ascent of Pichincha in 1880, Mr Whympcr collected 21 species of beetles, all new to science, between 12,000 and 15,600 ft. elevation. On Cotacapi, at elevations of 13,000 to 15,800 ft., 18 species of the genus *Colpodes* were collected, of which 16 were new. This may be considered a fair illustration of the situation in Ecuador so far as natural history exploration is concerned. Of the Machachi basin, near Quito, which he calls a "zoologist's paradise," Mr Whympcr writes (*Travels among the Great Andes of the Equator*): "Butterflies above, below and around; now here, now there, by many turns and twists displaying the brilliant tessellation of their under-sides. . . May-flies and dragon-flies danced in the sunlight; lizards darted across the paths; and legions of spiders pervaded the grass, many very beautiful—frosted—silver backs, or curious, like the saltigrades, who took a few steps and then gave a leap. There were crickets in infinite numbers; and flies innumerable, from slim daddy-long-legs to ponderous, black, hairy fellows known to science as *Dejeaniae*; hymenopterous insects in profusion, including our old friend the bishop of Ambato (possibly *Diatis*), in company with another formidable stinger, with chrome antennae, called by the natives 'the Devil'; and occasional *Phasmas* (caballo de palo) crawling painfully about, like animated twigs." This description refers to a fertile sub-tropical oasis on the partially barren plateau; below in the forested lowlands, where tropical conditions prevail, the numbers and varieties are many times greater. The Coleoptera are especially numerous; Mr Whympcr took home with him 206 species which had been identified and described up to 1892, most of them from the uplands and most of them new to science. The total number of species in Ecuador is roughly estimated to be 8000. The Hymenoptera are also numerous, but less so than the Lepidoptera, with which the mountain slopes and sunny, open spaces seem to be literally covered. Of moths alone Mr Whympcr took away with him specimens representing no less than 23 genera, with a probable addition of 13 genera more among his undescribed specimens, the largest of which (an *Erebos odora*) was $7\frac{1}{2}$ in. across the wings. Among the Diptera, which includes a very wide range of genera and species, are some of a highly troublesome character, though on the whole, Mr Whympcr did not find the flies and mosquitoes so. His explorations, however, did not extend to the eastern region, where the mosquitoes are usually described by travellers as extremely troublesome. Sand-flies are common, and in the eastern forests the tiny *pium* fly (*Trombidium*, sp.?) is a veritable pest. Of the insects which infest dwellings and prey upon their human inmates, such as fleas, bed-bugs, roaches, &c., Ecuador has more than a bountiful supply. Lice-eating is a widely prevalent habit among the Indians and mestizos, and demonstrates how numerous these parasites are among the people. A good illustration of the prevalence of house-infesting animals and insects is given by Mr Whympcr (*op. cit.* p. 391), who made a collection of 50 different specimens of the vermin which infested his bedroom in Guayaquil.

Population.—The indigenous population of Ecuador was originally composed of two distinct races—the Quitus and Caras, the former being the older, and the latter presumably of Quichua origin. The Caras, according to tradition, entered the country from the coast, and had thoroughly established themselves there long before the conquest by the Inca rulers Tupac-Yupanqui and his son Huayna-Capac. This conquest was comparatively easy because the Caras spoke a dialect of the same language, and were not greatly unlike their conquerors in manners and customs. The present Indian population of Ecuador, excepting those of the trans-Andean region, may be considered as descendants of these two races. They are subjected to incredible abuses under Spanish colonial rule, their numbers being reduced to a fraction of the former population, and even yet they are subjected to a kind of debt-bondage which is slavery in all but the name. Notwithstanding all this they still represent from two-thirds to three-fourths of the actual population of Ecuador. East of the Andes the forests are inhabited by tribes of what are termed "aucas" or "infieles" (infidels)—Indians who are independent of both church and political control. Missions have been established among some of the tribes, but their influence reaches only a small part of the wild inhabitants of this extensive region.

The principal tribes are the Quijos or Canelos, who are settled about the headwaters of the Napo, on the eastern slopes of the Andes, and are in great part grouped about the missions; the Jivaros who inhabit the valley of the Pastaza; the Zaparos who occupy the forest region between the Pastaza and Napo; the Piojes of the middle Napo, and eastward to the

Putumayo; and the Iquitos and Mazanes of the lower Napo and Tigre, chiefly in territory occupied by Peru. The Jivaros are the best known of these tribes because of their successful resistance to the Spanish invaders. They are still independent of political control, live in permanent settlements, till the soil (producing Indian corn, beans, yucca and plantains), and have developed some rude manufactures. The Zaparos are less homogeneous, some of their hordes living in a state of complete savagery. They are classified with the Guarani of Brazil, whom they resemble in many particulars. The Piojes live in permanent communities and cultivate the soil. The total number of "aucas" or uncivilized Indians in the republic has been estimated at about 200,000, but this estimate covered a larger area than Ecuador actually occupies and is evidently too high. Their settlements are usually small and very much scattered, and their aggregate number is evidently much under the earlier estimates. An official estimate given to Mr Whympcr in 1880, however, places the population of Oriente (the eastern territory) at 80,000, which is probably more nearly correct.

No general census has ever been taken in Ecuador, and estimates are little better than vague conjectures. One of these estimates, that published by P. F. Cevallos for 1880, which has been generally accepted, gave the total population as 1,272,761, and these figures have been used with but slight changes for various later estimates. A later official estimate appeared in 1900 in *La République de l'Équateur et sa participation à l'Exposition Universelle de 1900*, which gives for the provinces practically the same figures as those of Cevallos, and at the same time assumes the total for the whole republic to be 1,500,000. The white population is estimated at 100,000 to 120,000, which probably includes many of mixed ancestry, and the mixed bloods at 300,000 to 450,000. The tendency is for the *mestizo* who dwells in Indian communities to revert to the Indian type, and it is probable that the larger estimate is nearer the truth. On the other hand *mestizos* who live among the whites and form new alliances with them eventually class themselves as whites wherever their social condition has been improved. As a rule, the *mestizos* of Ecuador are ignorant, indolent and non-progressive. As in Colombia they are the artisans and small traders and the Indians are the farm labourers. The land is held by a few proprietors, and caste sentiment is strong among those who claim unmixed European descent; consequently the *mestizos* have limited opportunities to improve their condition.

The whites form an exclusive governing caste, as in Chile. The territory of the republic is divided among a very few of them, and its government is in their hands.

In the hot seaboard districts there are a small number of negroes, and a somewhat larger number of their crosses with the other two races. The majority of these are to be found in the northern provinces. There are comparatively few negroes and mulattoes on the colder plateaus. Villavicencio estimated their numbers at 783; pure negroes and 36,592 mixed bloods, which is probably not far from the correct totals.

The foreign population is small, the total being estimated at about 6000, of which 5000 are natives of the neighbouring Latin republics, 700 Europeans and Americans, and 300 Chinese.

Territorial Divisions and Towns.—The republic is divided into 15 provinces and one territory. The Galapagos Islands were declared a dependency of the province of Guayas in 1885, but are practically independent and constitute a second territory under the administration of a *jefe territorial* appointed by the national executive.

The official estimate (*La République de l'Équateur et sa participation à l'Exposition Universelle de 1900*) gives the data for the provinces and their capitals, which are shown on the next page.

These population figures are very nearly the same as those given by Cevallos for 1880. If the population of the Oriente be taken as 80,000, the aggregate is very nearly the same. The population of the provincial capitals is in some cases over-estimated, especially for Guayaquil and Quito, neither of which could have had 50,000 at the date of this estimate. The population of Quito in May 1906 was 50,841, of which 1365 were foreigners. As for the areas of the provinces the figures need not be questioned except those for the Oriente territory, which are much too large for the region actually

Provinces.	Area.	Population.	Capital.	Population.
	sq. m.			
Carchi . . .	1495	40,000	Tulcan	5,000
Imbabura . .	2416	68,000	Ibarra	5,000
Pichincha . .	6219	205,000	Quito	80,000
Leon	2595	109,600	Latacunga	12,000
Tunguragua .	1686	103,000	Ambato	8,000
Chimborazo .	2990	122,000	Riobamba	12,000
Bolivar . . .	1260	43,000	Guaranda	6,000
Cafiar	1519	64,000	Azogues	4,000
Azuay	3874	132,400	Cuenca	30,000
Loja	3707	66,000	Loja	10,000
El Oro	2340	32,600	Machala	3,200
Guayas	8216	98,100	Guayaquil	60,000
Los Rios . . .	2296	32,800	Babahoyo	3,000
Manabi	7893	64,100	Portoviejo	5,000
Esmeraldas .	5465	14,600	Esmeraldas	6,000
Oriente (ter.)	unknown			
Galapagos Is.	2865	2,000		

produced on the lower slopes of the Cordilleras and is of excellent quality. The production is small, but would be increased at remunerative prices. During the American civil war the planters of Ecuador entered largely into the production of cotton, which at that time yielded large profits, but the industry has declined to very insignificant proportions since then because of inability to compete with the lower cost of production in the United States. The output of sugar and tobacco is small, but could be largely increased, as the conditions of soil and climate are favourable. Much of the sugar-cane produced is turned into rum, which is consumed in the country. The tobacco grown is of excellent quality. Efforts have been made to promote the cultivation of indigo, but without much success. On the uplands, wheat, Indian corn, oats, barley, potatoes and vegetables of many kinds are successfully cultivated, but wholly for home consumption. The vine is successfully grown in the warm upland valleys, both for its fruit and for the production of wine. The staple foods for the common people are potatoes on the plateau (which are chiefly consumed in the form of *locro*, or potato-soup) and yucca- or cassava-meal in the warmer regions. Although cattle and horses were not known before the Spanish conquest, they have become since then important products of the country. The best grazing lands are on the lower elevations west of the Cordilleras in certain districts of the plateau and on the slopes of some of the higher Andes, as on Chimborazo and Antisana. Horses and mules are reared for export on a small scale, and sheep for their wool, which is used in home manufactures.

described by Ecuador, and for the Galapagos Islands which are occupied by competent authorities as 2400 sq. m. The population of these islands was 400 (principally convicts) on Chatham Island in 1901, about 115 on Albemarle and 3 on Charles Island in 1903. Besides the provincial capitals already noted, there are no large and important towns in the country. The largest of the smaller towns is probably Iipijapa, in the province of Manabí, which is the centre of the Panama hat industry and had in 1900 an estimated population of 6000, nearly all Indians.

Communications.—The first railway to be completed in Ecuador was the line between Guayaquil and Quito, 290 m. in length, the last section of which was formally opened at Quito on the 25th of June 1908. It belongs to an American company, and had been under construction for many years. Lines from Puerto Bolívar to Machala, province of El Oro, and another from Bahía de Caráquez to Chone, were under construction in 1908. Several lines were also projected, two to penetrate the Ecuadorian mountains. There is only one highway in the country on which vehicles can be used, the paved road extending southward from Quito 115 m. on the Guayaquil route, which was begun by Garcia Moreno but has been allowed to fall into neglect. Other roads have been projected to the coast and one to the eastern territory. The ordinary roads are rough mule-tracks. These are difficult at all times, and in the rainy season are quite impassable. On the Pacific lowlands the rivers Guayas, Daule, Vinces and Yaguachi have about 200 m. of navigable channels in the rainy season, and are used for the transportation of produce and merchandise. There are also several short river channels along the coast which are used by planters for the same purpose. A great part of the country, however, is still compelled to use the most primitive means of communication—mule paths, fords in the smaller streams in the dry season, and rude suspension bridges across deep gorges and swift mountain torrents. The latter are usually constructed from the tough fibre of the *Agave americana* and consist of one or more cables. When of one cable, called the *torandia*, the passenger and his luggage are drawn across in a rude kind of basket suspended from it; but when two or more cables are used, transverse sticks of bamboo and reeds are laid upon them, forming a rude prototype of the regular suspension bridge. Such a bridge is called a *chimbo-chaca*, and is very hazardous for an unpractised foot. In 1907 there were 2564 m. of telegraph lines in operation, connecting Quito with all the principal towns. The national capital is connected with the submarine cable at Santa Elena (via Guayaquil) and at Tumaco, in Colombia. Guayaquil is provided with tramway and telephone lines. These public services are under the general supervision of the Minister of Public Instruction, Posts and Telegraphs.

Commerce.—Ecuador has no merchant marine beyond a few small vessels engaged in the coastwise traffic, some eighteen or twenty river steamers on the Guayas and its tributaries, and a number of steam launches, towboats and various descriptions of barges engaged in the transportation of produce and goods on the rivers. The ocean-going foreign trade of the country is carried wholly in foreign vessels, for the regular lines of which Guayaquil is a principal port of call. Less frequent calls are made at Esmeraldas and some of the other small ports on the coast, of which there are nine in all. Most of these are difficult of access and their trade is unimportant. The total trade of the republic in 1905, according to returns published by the Guayaquil Chamber of Commerce, amounted to only £3,429,955, of which £1,573,389 (15,733,891 sucres) were credited to imports, and £1,856,566 (18,565,668 sucres) to exports. Of these totals, all but £1,27,532 of the imports and £41,679 of the exports passed through the port of Guayaquil. The great poverty of the people has been a serious obstacle to the development of a larger commerce.

Agriculture.—The agricultural industries on which the export trade depends are almost wholly restricted to the western lowlands, and include cacao, coffee, cotton, sugar, tobacco, rice, yucca and sweet potatoes. The Guayas basin and the district about Machala are celebrated for their cacao, and produce about one-third of the world's supply. It is the staple product of the country. Coffee is

produced on the lower slopes of the Cordilleras and is of excellent quality. The production is small, but would be increased at remunerative prices. During the American civil war the planters of Ecuador entered largely into the production of cotton, which at that time yielded large profits, but the industry has declined to very insignificant proportions since then because of inability to compete with the lower cost of production in the United States. The output of sugar and tobacco is small, but could be largely increased, as the conditions of soil and climate are favourable. Much of the sugar-cane produced is turned into rum, which is consumed in the country. The tobacco grown is of excellent quality. Efforts have been made to promote the cultivation of indigo, but without much success. On the uplands, wheat, Indian corn, oats, barley, potatoes and vegetables of many kinds are successfully cultivated, but wholly for home consumption. The vine is successfully grown in the warm upland valleys, both for its fruit and for the production of wine. The staple foods for the common people are potatoes on the plateau (which are chiefly consumed in the form of *locro*, or potato-soup) and yucca- or cassava-meal in the warmer regions. Although cattle and horses were not known before the Spanish conquest, they have become since then important products of the country. The best grazing lands are on the lower elevations west of the Cordilleras in certain districts of the plateau and on the slopes of some of the higher Andes, as on Chimborazo and Antisana. Horses and mules are reared for export on a small scale, and sheep for their wool, which is used in home manufactures.

Forest Products.—The forest and other natural products include rubber, cinchona bark, ivory-nuts, mocora and toquilla fibre for the manufacture of hats, hammocks, &c., cayaba fibre for shoes and cordage, vegetable wool (*Bombax sebba*), gansa-parilla, vanilla, cochineal, cabinet woods, fruit, resins, &c. The original source of the Peruvian bark of commerce, the *Cinchona calisaya*, is completely exhausted, and the "red bark" derived from *C. succubra*, is now the principal source of supply from Ecuador. Guaranda is the centre of the industry, but bark gatherers are to be found everywhere in the forest regions. The rubber-gathering industry is comparatively new. The product is derived from the *Castilloa elastica*, the *Hemec* not being found west of the Andes.

Minerals.—The mineral resources are much inferior to those of Colombia and Peru. Gold is found in the province of El Oro, where the great Zaruma and other companies have opened a number of mines. It is also found in the provinces of Loja, Esmeraldas, and in the river-beds along the eastern slopes of the Andes. Quicksilver has been mined at Azogues, in the province of Cafiar, and is also to be found in Azuay. Iron ores and lead are credited to several provinces, and platinum has been found in Esmeraldas, where emerald mines have been worked ever since the Spanish conquest. Coal of good quality has been found in Azuay and at other points, and petroleum is known to exist in several localities. Salt springs near Riobamba and at Salinas, in Imbabura, have long been used by the natives in the manufacture of salt.

Manufactures.—The manufacturing industries are chiefly of a primitive character and have been developed to meet local necessities. There are some cotton factories and sugar mills provided with modern machinery, but the cotton and woollen cloths of the country are commonly coarse and manufactured in the most primitive manner. Some of these goods are sent into southern Colombia, but they are chiefly made for the local market. Hats and hammocks are made from the fibres of the mocora and toquilla palms, and sandals from the fibre of the *Agave americana*. The hats are an article of export, and are known abroad as Panama hats. Hand-made laces of admirable workmanship are made in some localities, especially on the plateau about Quito. Among other manufactures, all for the home market, may be mentioned: flour-mills, sugar refineries, rum distilleries, breweries, chocolate factories, a candle factory, saw-mills and tanneries.

Government.—Constitutionally, the government of Ecuador is that of a centralized republic, whose powers are defined by a written constitution and whose chief organs are an executive consisting of a president and vice-president, and a national congress consisting of two houses, a senate and a chamber of deputies. Revolutionary changes, however, have been very frequent in Ecuador, and no less than eleven constitutions were adopted between 1830 and 1909.

The constitution adopted in 1906 succeeded that of 1884 (amended in 1887 and 1897), and its terms may be given here, subject to what may be regarded as the extra-constitutional powers vested in the executive. Executive power is vested in a president and vice-president elected for periods of four years by a direct vote of the people. (Under the constitution of 1884 the official terms of these two officers were not wholly synchronous, the vice-president's term beginning with the president's third year.) These officials cannot be re-elected to succeed themselves. The president, whose salary is 12,000 sucres per annum, has a limited veto power, and may convene extraordinary sessions of Congress for a specified purpose, but he has no further authority over that body. He appoints the diplomatic and consular representatives of the republic and the governors of the provinces, exercises a limited control over the administration of

justice and public instruction through the appointment of officials, and is chief of the small military force maintained by the republic. The construction of railways with public funds and under government supervision also places him at the head of a very important public service. The president is assisted by a cabinet of five ministers:—foreign relations and justice; interior and public works; finance; war; public instruction, posts and telegraphs—all of whom may be impeached by congress. The executive authority is also partially exercised by a council of state composed of 15 members, including the five cabinet ministers, of which the vice-president is *ex-officio* president. The council has important advisory functions, and must be consulted by the president on every important measure or appointment. The provinces are administered by governors chosen by the national executive; the departments by *jefes políticos* (political chiefs); and the municipalities by *tenientes políticos* (political lieutenants). The Galapagos Islands are under a *jefe territorial* (territorial chief), Chatham Island being a penal colony and governed by special laws.

The congressional organization is similar to that of the majority of South American states. The senate is composed of 32 members (2 from each province) elected for two years, one-half the number being renewed each two years. The chamber is composed of 42 deputies, who are elected by the provinces for a period of two years, on a basis of one representative for each 30,000 inhabitants and one supplementary representative for an additional 15,000. A senator must be at least 35 years of age, and a deputy 25. The elections are direct, and members of both houses may be re-elected. The immunities of legislators begin 30 days before the opening session of congress, and terminate 30 days after its dissolution. Congress meets at Quito on the 10th of August, and remains in session for a period of 60 days, but its sessions may be extended or extraordinary sessions called for specified purposes. The right of suffrage is restricted to literate male adults.

The judicial branch of the government is composed of a supreme court, located at Quito, consisting of 5 judges and a fiscal (public prosecutor) appointed by the executive; six superior courts (in Quito, Guayaquil, Cuenca, Riobamba, Loja and Portoviejo) with a total of 9 judges; a *Tribunal de Cuentas* of seven members at Quito; and various municipal courts, or *alcaldes*, in the chief towns of the departments. There are civil courts of first and second instance in the larger towns, and consular courts in Quito, Guayaquil and Cuenca with jurisdiction in commercial cases. There are also police commissaries in the departments and justices of the peace in the municipalities, the latter having jurisdiction in civil cases where the amount involved does not exceed 200 sucres. The laws of Ecuador are based on the old Spanish laws and procedure, and include civil, criminal and commercial codes.

Army.—The army, according to an official report of 1900, consisted of 4 battalions of infantry (about 3600 strong), 3 brigades of artillery (1362), and 2 regiments of cavalry (468), in all, about 5520 men, rank and file. In 1908 this force was reported to comprise 4350 men. The national guard is composed of three classes: actives—all enrolled citizens of 20 to 38 years; auxiliaries—enrolled citizens of 38 to 44 years; and passives—enrolled citizens of 44 to 50 years. These were estimated at 95,329 men. There is a military school at Quito and a naval school at Guayaquil.

Education.—Although primary instruction is free, and is obligatory for children of 6 to 12 years, a considerable part of the population is unprovided with schools and is indifferent in regard to them. An official report for 1900 gives the number of primary schools as 1297, and the number of pupils in attendance as about 80,000. The secondary schools numbered 37, with 371 teachers and about 4500 pupils. Higher instruction includes the technical and professional schools with the three universities of Quito, Guayaquil and Cuenca, and 6 schools of "trades and professions" (*artes y oficios*) in as many provinces. The old University of Quito has a staff of 32 professors divided into 5 faculties: Philosophy and Belles-Lettres, Law, Medicine, Physical and Natural Sciences and Mathematics. There are also in Quito a school of agriculture, astronomical observatory, botanical garden, museum and national printing office, all apparently under the supervision of the University.

Church.—According to the constitution of 1884, "the religion of the Republic is the Roman Catholic Apostolic, and all others are excluded." The only opposition which the Church has ever had to encounter has been from the "liberal" element within itself, and thus has arisen, seemingly from political motives, a desire to restrict clerical influence in political affairs. This influence has been exercised to an extreme in Ecuador, so much so, in fact, that its government at times was more nearly a theocracy than a republic. The growth of liberalism finally began to produce results. In 1889 the tithes from which the Church revenues had been derived were abolished, and a tax of 3 per mil. on real estate was substituted. In 1902 a signal victory was won in a law permitting civil marriage, but in 1904 a social revolution was effected by legislation, which placed the Church under State control, forbade the foundation of new religious orders and admission into the country of new religious communities, and provided that the members of the episcopate must be citizens of Ecuador. The six higher dignitaries of the Church are an archbishop at Quito, and six suffragan bishops at Cuenca, Loja, Ibarra, Riobamba, Guayaquil and Manabí.

Finance.—The revenues of the republic are derived from import and export duties, liquor, tobacco and stamp taxes, inheritance tax, salt, gunpowder and playing cards monopolies, consular charges, and sundry miscellaneous receipts, including those from posts, telegraphs and railways. Up to 1907 the customs duties were increased by surtaxes amounting at that time to 100%. The minister of finance proposed to abolish these surtaxes and double all the rates of duties involved. On exports, however, all the duties were to be abolished except those on cacao, coffee, hides, rubber, tagua (ivory nuts), hat fibre, hammock fibre and tobacco. For 1907 the revenues were £1,424,770 and the expenditures £1,383,122.

On the 10th of October 1906, when the report of the provisional government created by the revolution of the preceding January presented its financial report to a national assembly, the total obligations of the country were stated to be:—

	Sucres.
Railway bonds, 12,282,000 sucres gold at 107% premium	25,423,740
Banco del Ecuador, advances	3,000,000
Banco Comercial y Agrícola, idem	2,400,000
Internal debt	739,575
Condor bonds	757,000
French Finance Corporation	587,000
Total	33,207,315
In £ sterling at 10 sucres per £	3,320,731

The foreign debt of the republic, which in 1898 stood at £693,160 in bonds, was assumed by the Guayaquil & Quito Railway Co. under contracts of 1897, 1898, 1899 and 1900, the government guaranteeing interest on the sum of £2,520,000 railway mortgage bonds for 33 years and recognizing the external debt at 35% of its face value. This debt originated in 1830, when Ecuador seceded from the Colombian confederacy and was charged with 21½% of the indebtedness of the three states. In 1855 the amount was fixed at £1,824,000, and in 1892 it was converted into a new consolidated debt of £750,000. Payments of interest and amortization had been very irregular, and its transfer to a foreign company as the price of a railway concession put an end to a transaction which had been a serious discredit to the country. The amount outstanding on the 31st of December 1907 was 10,808,000 sucres (£1,080,800). It should be said that the difficulties in regard to this debt arose from a feeling in Ecuador that the part assigned to it in 1830 was much too large, and that it was contracted almost wholly for the benefit of the two northern provinces, Colombia and Venezuela.

Money and Measures.—Under the law of 1898, which came into effect on the 4th of June 1900, gold is made the monetary standard in Ecuador, the legal tender of silver being limited to 10 sucres, and banks of issue being required to hold at least one-half their metallic reserves in gold coin. Previously there had been much confusion in the circulating medium because of the depreciated value of the Quito currency in comparison with that of Guayaquil, but the new law has corrected the anomaly and has given a simple and uniform medium for the whole country. The coinage under the law of 1898 consists of the gold *condor*, of 10 sucres, which weighs 8.136 grams, contains 7.3224 grams of fine gold, and is equal to the English pound sterling in value; the silver *sucré*, of 100 centavos, equivalent to 24d. in value; and smaller coins of silver, nickel and copper, the denominations being decimal parts of the sucré. The sucré received its name from the portrait of General Sucré engraved on the coin, and is legal tender up to 10 sucres. The paper money circulation consists of the issues of two Guayaquil banks—the Banco del Ecuador, and the Banco Comercial y Agrícola, whose united issues on June 30th, 1906, amounted to 7,414,140 sucres (£741,414). The Bank of Quito at one time issued notes which, according to Whymper, were not current at and worth in Riobamba, but it does not appear that this bank is authorized to issue its notes under the new law. The metallic money nominally in circulation on the 30th of June 1906, amounted to 2,587,667 sucres gold and 2,522,802 sucres silver. Although the metric system was adopted in 1856, the old Spanish weights and measures—the quintal, libra, vara and fanega—are still in use, the quintal being equivalent to about 101 lb.

Antiquities.—Throughout Ecuador there are still considerable remains of the architectural and artistic skill of the ante-European period. At Cañar, to the north-east of Cuenca, stands the Incapirca, a circular rampart of finely hewn stone, enclosing an open area with a roofless but well-preserved building in the centre; not far off is the Inca-chungana, a very much smaller enclosure, probably the remains of a pavilion; and in the same neighbourhood the image of the sun and a small cabinet are carved on the face of a rock called Inti-huacá. On one of the hills running from Pichincha to the Esmeraldas there are remains at Palatamba of a temple and a conical tower, the buttresses of a bridge composed of stone and bitumen, portions of a great causeway, and numerous tombs from which mummies and plates of silver have been obtained. At Mantuataqui similar sepulchral mounds, called *tolas*, may be seen, as well as traces of military structures. On the plain of Callo, near Cotopaxi, at a height of 8658 ft., the ruins of an Incaial palace, Pachusala, are utilized by the *haciendas*; and a conical hill at its side is supposed to

be of artificial construction. The remains of another fortress and palace are preserved at Pomallacta, and in the neighbouring pueblo of Achupallas an ancient temple of the sun now serves as parish church. In many localities, especially in Imbabura, pottery and various objects are found belonging to the pre-Colombian period, among which five and six rayed stars (*casco-lles*) are very numerous.
(A. J. L.)

History.—The territory of the republic of Ecuador, when first it becomes dimly visible in the grey dawn of American history, appears to be inhabited by upwards of fifty independent tribes, among which the Quitus seem to hold the most important position. About A.D. 280 a foreign tribe is said to have forced their way inland up the valley of the Esmeraldas; and the kingdom which they founded at Quito lasted for about 1200 years, and was gradually extended, both by war and alliance, over many of the neighbouring dominions. In 1460, during the reign of the fourteenth *Caran Shyri*, or king of the Caran nation, Hualcopo Duchisela, the conquest of Quito was undertaken by Tupac Yupanqui, the Inca of Peru; and his ambitious schemes were, not long after his death, successfully carried out by his son Huayna-Capac, who inflicted a decisive defeat on the Quitonians in the battle of Hatuntaqui, and secured his position by marrying Pacha, the daughter of the late Shyri. By his will the conqueror left the kingdom of Quito to Atahualpa, his son by this alliance; while the Peruvian throne was assigned to Huascar, an elder son by his Peruvian consort. War soon broke out between the two kingdoms, owing to Huascar's pretensions to supremacy over his brother; but it ended in the defeat and imprisonment of the usurper, and the establishment of Atahualpa as master both of Quito and Cuzco. The fortunate monarch, however, had not long to enjoy his success; for Pizarro and his Spaniards were already at the door, and by 1533 the fate of the country was sealed. As soon as the confusions and rivalries of the first occupation were suppressed, the recent kingdom of Quito was made a presidency of the Spanish viceroyalty of Peru, and no change of importance took place till 1710. In that year it was attached to the viceroyalty of Santa Fé; but it was restored to Peru in 1722. When, towards the close of the century, the desire for independence began to manifest itself throughout the Spanish colonies of South America, Quito did not remain altogether indifferent. The Quitonian doctor Eugenio Espejo, and his fellow-citizen Don Juan Pio Montufar, entered into hearty co-operation with Naríño and Zea, the leaders of the revolutionary movement at Santa Fé; and it was at Espejo's suggestion that the political association called the *Escuela de Concordia* was instituted at Quito. It was not till 1809, however, that the Quitonians made a real attempt to throw off the Spanish yoke; and both on that occasion and in 1812 the royal general succeeded in crushing the insurrection. In 1820 the people of Guayaquil took up the cry of liberty; and in spite of several defeats they continued the contest, till at length, under Antonio José de Sucre, who had been sent to their assistance by Bolívar, and reinforced by a Peruvian contingent under Andres de Santa Cruz, they gained a complete victory on May 22, 1822, in a battle fought on the side of Mount Pichincha, at a height of 10,200 ft. above the sea. Two days after, the Spanish president of Quito, Don Melchor de Aymeric, capitulated, and the independence of the country was secured. A political union was at once effected with New Granada and Venezuela on the basis of the republican constitution instituted at Cucuta in July 1821—the triple confederation taking the name of Colombia.

A disagreement with Peru in 1828 resulted in the invasion of Ecuador and the temporary occupation of Cuenca and Guayaquil by Peruvian forces; but peace was restored in the following year after the Ecuadorian victory at Tarqui. In the early part of 1830 a separation was effected from the Colombian federation, and the country was proclaimed an independent republic. General Juan José Flores was the first president, and in spite of many difficulties, both domestic and foreign, he managed to maintain a powerful position in the state for about 15 years. Succeeded in 1835 by Vicente Rocafuerte, he regained the presidency in 1839, and was elected for the third time in 1843; but shortly afterwards he accepted the title of *generalísimo* and a

sum of 20,000 pesos, and left the country to his rivals. One of the most important measures of his second presidency was the establishment of peace and friendship with Spain. Roca, who next attained to power, effected a temporary settlement with Colombia, concluded a convention with England against the slave trade, and made a commercial treaty with Belgium. Diego Noboa, elected in 1850 after a period of great confusion, recalled the Jesuits, produced a rupture with New Granada by receiving conservative refugees, and thus brought about his own deposition and exile. The democratic Urbina now became practically dictator, and as the attempt of Flores to reinstate Noboa proved a total failure, he was quickly succeeded in 1856 by General Francisco Robles, who, among other progressive measures, secured the adoption of the French system of coinage, weights and measures. He abdicated in 1859 and left the country, after refusing to ratify the treaty with Peru, by which the defender of Guayaquil had obtained the raising of the siege. Dr Gabriel García Moreno, professor of chemistry, the recognized leader of the conservative party at Quito, was ultimately elected by the national convention of 1861. Distrust in his policy, however, was excited by the publication of some of his private correspondence, in which he spoke favourably of a French protectorate, and the army which he sent under Flores to resist the encroachments of Mosquera, the president of New Granada, was completely routed. His first resignation in 1864 was refused; but the despotic acts by which he sought to establish a dictatorship only embittered his opponents, and in September 1865 he retired from office. While he had endeavoured to develop the material resources of the country, he had at the same time introduced retrograde measures in regard to religion and education. The principal event in the short presidency of his successor, Gerónimo Carrion (May 1865–Nov. 1867), was the alliance with Chile and Peru against Spain, and the banishment of all Spanish subjects. Several important changes were made by congress in the period between his resignation and the election of Xavier Espinosa, January 1868: the power of the president to imprison persons regarded as dangerous to public order was annulled; and the immediate naturalization of Bolivians, Chilians, Peruvians and Colombians was authorized. Espinosa had hardly entered on his office when, in August 1868, the country was visited by an earthquake, in which 30,000 people are said to have perished throughout South America. The public buildings of Quito were laid in ruins; and Ibarra, Otavalo, Cotacachi and several other towns were completely destroyed. Next year a revolution at Quito, under Moreno, brought Espinosa's presidency to a close; and though the national convention appointed Carvajal to the vacant office, Moreno succeeded in securing his own election in 1870 for a term of six years. His policy had undergone no alteration since 1865: the same persistent endeavour was made to establish a religious despotism, in which the supremacy of the president should be subordinate only to the higher supremacy of the clergy.

President Moreno was eventually assassinated at Quito, in August 1875, and Dr Borrero was elected to the presidency, but his tenure of power was short. A revolution headed by General Veintemilla, the Radical leader, then military commandant at Guayaquil, broke out in 1876, and on the 14th of December of that year the government forces under General Aparicio were completely routed at Galte. Veintemilla was proclaimed president, and in 1877 was duly elected by the cortes. He altered the constitution in a more Liberal direction, and struck various blows at the Clerical party, among other things abolishing the concordat with Rome. In 1878 Veintemilla caused himself to be declared elected as president for a term of four years. At the expiration of this period the president assumed dictatorial powers and remained in office as chief of the executive. This action on the part of General Veintemilla led to a union between the Clericals and Moderate Liberals, and resulted in a popular rising throughout the republic, ending in his defeat and overthrow. His power was first restricted to Guayaquil and Esmeraldas, and finally General Rinaldo Flores drove him from Guayaquil, and Veintemilla fled (July 1883) to Peru. Dr Plácido Caamaño was then called upon to take charge temporarily, and on the 17th of

February 1884 was definitely elected for the presidential period terminating in 1888. Several revolutionary outbreaks occurred during the Casamafo administration, but were successfully suppressed. In 1888 Dr Antonio Flores succeeded Casamafo, the four years following being passed in peaceful conditions. In 1892 Dr Luis Cordero was elected, his administration again plunging the country into an epoch of internal disturbance.

The cause of the troubles under President Cordero was the assistance lent by Ecuador to Chile in the matter of the sale of the cruiser *Esmeralda* to the Japanese government in 1894, in the middle of the Japanese-Chinese War. The government of Chile arranged the sale of the *Esmeralda*, but wished to be free from all danger of international complications in the affair. To this end the transfer of the vessel was made to Ecuador, and she proceeded to Ecuadorian waters. On arriving at the Galapagos Islands the flag of Ecuador was replaced by that of Japan and the vessel handed over to the representatives of that nation sent for the purpose. When the part played by President Cordero in this transaction became known, an outburst of popular indignation occurred. An insurrection, headed by General Eloy Alfaro, followed; and after desultory skirmishing extending over a period of nearly a year the government forces were finally routed, President Cordero abandoning his office and escaping from the country.

General Alfaro then assumed dictatorial powers as supreme chief of the nation, continuing in this capacity until the 6th of February 1897, on which date he was declared to be elected president of the republic. A series of revolutionary movements against the administration of President Alfaro occurred in the course of the next few years. Many of these risings were due to the intrigues of the Church party, and in view of these circumstances President Alfaro curtailed the influence of the clergy in several directions. On the 31st of August 1901 General Alfaro peacefully handed over the presidency to his elected successor, General Leonidas Plaza.

General Plaza continued the anticlerical policy of his predecessor. Civil marriage and divorce were introduced, and in 1904 all religions were placed on a position of equality in the eye of the law, and the foundation of new monasteries and convents was forbidden. The final year of Plaza's tenure of office was marked by a still stronger measure, all the property of the church being declared to be national property, and let to the highest bidders. In 1905 the Opposition made an effort to effect a change of policy, and were successful in obtaining the election of Lizaro Garcia, a well-to-do merchant and a director of the Banco Commercial y Agrícola. General Alfaro, however, appealed to arms, ejected Garcia from office, and made himself ruler with practically dictatorial powers.

The more recent history of Ecuador would not be complete without a reference to the work of Mr Archer Harman (b. 1860), an American railway builder and financier whose connexion with the construction of the Guayaquil and Quito railway began in 1867. To his personal energy and enterprise, as manager of the railway company, was largely due the continued prosecution of this difficult engineering undertaking, in connexion with which he was responsible for a thorough reconstruction of Ecuador finance. He thus came to exercise a powerful influence on the internal progress of the country.

See C. E. Akers, *History of South America, 1854-1904* (London, 1904); H. W. Bates, *Central and South America* (London, 1882); Pedro F. Cevallos, *Resumen de la historia del Ecuador* (Guayaquil, 1886); Hans Meyer, *In den Hoch-Anden von Ecuador* (Berlin 1907); A. H. Keane, *Stanford's Compendium*, vol. 1. (1904); W. Reiss and A. Stübel, *Das Hochgebirge der Republik Ecuador* (Berlin, 1892-1898); Edward Whymper, *Travels amongst the Great Andes of the Ecuador* (London, 1892); F. Wolf, *Geografía y geología del Ecuador* (Leipzig, 1892); A. Stübel, *Skizzen aus Ecuador* (Berlin, 1886); *Die Vulkanberge von Ecuador* (Berlin, 1897); *Handbook of Ecuador* (Bureau of the American Republics, Washington, 1892); *The World's Work*, vol. ii, pp. 1271-1277; *Engineering News* (New York), vol. 52, pp. 117-119; *Bulletin of Internal Bureau of American Republics* for July 1900, p. 26; and for August 1908, pp. 280-282; *Thirty-fifth Annual Report of the Council of Foreign Bondholders*, pp. 115, 117.

ECZEMA (Gr. *ἐκζέμα*, a cutaneous eruption), one of the most common and important of all skin diseases, consisting of a catarrhal inflammation of the skin originating without visible external irritation, and characterized in some stage of its evolution by a serous exudation. This definition excludes all those forms of inflammation of the skin (dermatitis), which though they may be identical in course and manifestation are yet caused by chemical or mechanical irritants. For an attack of eczema two conditions are necessary: a predisposition or special irritability of the skin, and a directly exciting cause. The first of these conditions is usually inherited or depends on some underlying constitutional state. Thus any organic lesion which may produce oedema and malnutrition of the cutis and epidermis as in kidney diseases, any condition of imperfect metabolism as in dyspepsia or malnutrition, or seborrhoea, may be the predisposing cause. Another influence that has received increasing attention from skin specialists is that of any nervous shock or prolonged mental strain. A "chill" is followed in most people by an ordinary cold, but in some by an attack of eczema. Again, it may be caused by reflex nervous irritation from the uterus, stomach, &c. In some women it always accompanies menstruation, and in others pregnancy. It is of common occurrence in infancy, being attributed by some specialists to dentition, but by others to seborrhoea. Also there is an undoubted relationship between eczema and certain forms of functional neurosis, of which perhaps asthma is the most striking illustration, some physicians considering the latter trouble to be eczema of the bronchial tubes. Sufferers from rheumatism and gout are also specially prone to eczema, though the exact relationship is a much disputed point. There are yet other cases that are undoubtedly microbic, but the micro-organism cannot produce the lesion unless the soil is suitable. As a rule it is not contagious, though when complicated by micro-organisms it may be auto-inoculable, or more rarely inoculable from one patient to another. Except between the ages of ten and twenty years when menstruation is becoming established, and again at the menopause, males are more liable to be attacked than females. In old age the sex influence is lost.

An attack of eczema is usually described as acute or chronic, but the only distinction lies in the greater or less intensity of the inflammation at the time of description: it has nothing to do with the length of time that the disease has lasted. The illness usually begins with a feeling of itching and burning at the site of the lesion. The skin becomes covered with an erythematous blush, on which numerous tiny vesicles form. Swelling, heat, redness and tension are all present. The vesicles grow larger, run together, and either burst or are broken by the patient's scratching, a clear fluid exuding which stiffens linen. The discharge does not dry up at once, but continues to erude—hence the name of "weeping eczema" when this is a prominent symptom. In mild cases the symptoms begin to subside in a few days, the exudation growing less and scales and scabs forming, under which new skin is formed. But where the attack is more acute fresh crops of vesicles spring up and the process repeats itself. In some cases papules are the predominant lesions, but in others, especially when the face is attacked, the erythematous condition is more marked. A severe attack of eczema is usually accompanied by some slight constitutional disturbance, but the general health seldom suffers appreciably, unless, as occasionally, the itching is so bad as to make sleep impossible. The irritation and local heat may be out of all proportion to visible changes in the skin, and in neurotic patients the nervous excitement may be extreme. The attack may centre itself on any part of the body, but there are certain places where it more usually begins, such as the bends of the elbows, the backs of the knees and the groins; the groove behind the ears, the scalp, the palms or the soles, and the breasts of women. According to its position the form of the eczema is somewhat modified. On the front of the legs and arms, from the uniform redness it exhibits in these positions, it is known as eczema rubrum. On the scalp it is generally of the seborrhoeic type, and in children, especially when pediculi are present, it will become pustular from microbic infection. On the palms and soles it brings about a thickening

of the epidermis which leads to the formation of cracks, and is hence called *eczema rimosum*.

The disease can best be treated by a combination of internal and external remedies. Internally, when the inflammation is acute, nothing is so good as antimony, since this relieves the arterial tension and thus reduces the local inflammation. But this must never be given when the patient is suffering from depression. In other cases, especially for babies and children, small doses of calomel are very beneficial; strychnine, phosphorus and ergot are all useful at times. When nervous excitement is marked it must be treated with sedatives. Arsenic and iron are both contraindicated in this disease, since they increase blood formation and hence stimulate the eczematous process. Internal treatment is always best when combined with local treatment, but as a preliminary to this all crusts and scales must first be removed to allow the remedy free access to the disease. Locally the aim is (1) to overcome any source of irritation, (2) to protect the inflamed surface from the air and from microbic infection, and (3) to relieve the itching. The diet should be simple but nourishing, and all hygienic precautions must be taken.

EDAM, a town of Holland in the province of North Holland, close to the *Zuider Zee*, about 13 m. N.N.E. of Amsterdam by steam tramway. It is connected with the *Zuider Zee* by a fine canal protected by a large sea-lock (1828), and has regular steam-boat communication in various directions. Pop. (1900) 6444. The many quaint old brick houses form the chief feature of interest in the town. The façades are frequently adorned with carvings and inscriptions, one of which records the legend of the capture of a siren in 1403, who lived for some time among the people of Edam, but escaped again to the sea. The Great Church of St Nicholas, probably founded in the 14th century, was largely rebuilt after a fire in 1602, which, originating in the church, destroyed nearly the whole town. It contains some fine stained glass and carved woodwork of this period. The Little Church (15th century) was demolished in 1883, except for a portion of the nave and the old tower and steeple, from which the bells curiously project. The town hall dates from 1737, and there is a museum founded in 1895. Edam has some trade in timber, while shipbuilding, rope-spinning and salt-boiling are also carried on. It gives its name to the description of "sweet-milk cheese" (*soetemelks kaas*) made throughout North Holland, which is familiar on account of its round shape and red rind.

Edam took its name and origin from the dam built on the little river *Ye* which joined the great *Purmer lake* close by. Free access to the *Zuider Zee* was obtained by the construction of a new dock in 1357, in which year the town also received civic rights from William V. of Bavaria, count of Holland. Owing to the danger of the extension of the *Purmer* and *Beemster lakes*, Philip II. of Spain caused a sluice to be built into the dock in 1567. In the next century Edam was a great shipbuilding centre, and nearly the whole of Admiral de *Ruyter's* fleet was built here; but in the same century the harbour began to get blocked up, and the importance and industrial activity of the city slowly waned.

EDDA, the title given to two very remarkable collections of old Icelandic literature. Of these only one bears that title from antiquity; the other is called *Edda* by a comparatively modern misnomer. The word is unknown to any ancient northern language, and is first met with in *Rígsþula*, a fragmentary poem at the end of *Codex Wormianus*, dated about 1200, where it is introduced as the name or title of a great-grandmother. From the 14th to the 17th century, this word—but no one has formed a reasonable conjecture why—was used to signify the technical laws of Icelandic court metre, *Eddu regia*, and "Never to have seen *Edda*" was a modest apology for ignorance of the highest poetic art. The only work known by this name to the ancients was the miscellaneous group of writings put together by *Snorri Sturlason* (q.v.; 1178-1241), the greatest name in old Scandinavian literature. It is believed that the *Edda*, as he left it, was completed about 1222. Whether he gave this name to the work is doubtful; the title first occurs in the *Upsala Codex*, transcribed about fifty years after his death. The collection

of *Snorri* is now known as the *Prose* or *Younger Edda*, the title of the *Elder Edda* being given to a book of ancient mythological poems, discovered by the Icelandic bishop of *Skálholt*, *Brynjulf Sveinsson*, in 1643, and erroneously named by him the *Edda of Saemund*.

1. The *Prose Edda*, properly known as *Edda Snorra Sturlasonar*, was arranged and modified by *Snorri*, but actually composed, as has been conjectured, between the years 1140 and 1160. It is divided into five parts, the Preface or *Formáli*, *Gylfaginning*, *Bragaraefer*, *Skáldskaparmál* and *Háttatal*. The preface bears a very modern character, and simply gives a history of the world from Adam and Eve, in accordance with the Christian tradition. *Gylfaginning*, or the Delusion of *Gylfi*, on the other hand, is the most precious compendium which we possess of the mythological system of the ancient inhabitants of Scandinavia. Commencing with the adventures of a mythical king *Gylfi* and the giants *Gefion*, and the miraculous formation of the island of *Zealand*, it tells us that the *Aesir*, led by *Odin*, invaded *Svitthjod* or *Sweden*, the land of *Gylfi*, and settled there. It is from the *Ynglingasaga* and from the *Gylfaginning* that we gain all the information we possess about the conquering deities or heroes who set their stamp upon the religion of the North. Advancing from the *Black Sea* northwards through *Russia*, and westward through *Esthonia*, the *Aesir* seem to have overrun the south lands of *Scandinavia*, not as a horde but as an immigrant aristocracy. The *Eddaic* version, however, of the history of the gods is not so circumstantial as that in the *Ynglingasaga*; it is, on the other hand, distinguished by an exquisite simplicity and archaic force of style, which give an entirely classical character to its mythical legends of *Odin* and of *Loki*. The *Gylfaginning* is written in prose, with brief poetic insertions. The *Bragaraefer*, or sayings of *Bragi*, are further legends of the deities, attributed to *Bragi*, the god of poetry, or to a poet of the same name. The *Skáldskaparmál*, or Art of Poetry, commonly called *Skálda*, contains the instructions given by *Bragi* to *Aegir*, and consists of the rules and theories of ancient verse, exemplified in copious extracts from *Eyvindr Skáldaspillir* and other eminent Icelandic poets. The word *Skáldskapr* refers to the form rather than the substance of verse, and this treatise is almost solely technical in character. It is by far the largest of the sections of the *Edda* of *Snorri*, and comprises not only extracts but some long poems, notably the *Thorsdrapa* of *Eilifr Guðrúnarson* and the *Haustlaug* of *Thjóðólfr*. The fifth section of the *Edda*, the *Háttatal*, or Number of Metres, is a running technical commentary on the text of *Snorri's* three poems written in honour of *Haakon*, king of *Norway*. Affixed to some MS. of the *Younger Edda* are a list of poets, and a number of philological treatises and grammatical studies. These belong, however, to a later period than the life of *Snorri Sturlason*.

The three oldest MSS. of the *prose Edda* all belong to the beginning of the 14th century. The *Wurm MS.* was sent to *Ole Wurm* in 1628; the *Codex Regius* was discovered by the indefatigable bishop *Brynjulf Sveinsson* in 1640. The most important, however, of these MSS. is the *Upsala Codex*, an octavo volume written probably about the year 1300. There have been several good editions of the *Edda Snorra Sturlasonar*, of which perhaps the best is that published by the *Arne-Magnæan Society* in *Copenhagen* in 1848-1852, in two vols., edited by a group of scholars under the direction of *Jón Sigurdsson*. There are English translations by *T. Percy*, *Northern Antiquities*, from the French by *P. H. Mallet* (1770); by *G. Webbe Dasent* (*Stockholm*, 1842); by *R. B. Anderson* (*Chicago*, 1886).

2. The *Elder Edda*, *Poetic Edda* or *Saemundar Edda hins fróða* was entirely unknown until about 1643, when it came into the hands of *Brynjulf Sveinsson*, who, puzzled to classify it, gave it the title of *Edda Saemundi multiscii*. *Saemund Sigfusson*, who was thus credited with the collection of these poems, was a scion of the royal house of *Norway*, and lived from about 1055 to 1132 in *Iceland*. The poems themselves date in all probability from the 10th and 11th centuries, and are many of them only fragments of longer heroic chants now otherwise entirely lost. They treat of mythical and religious legends of an early Scandinavian civilization, and are composed in the simplest and most archaic forms of Icelandic verse. The author of no one of them is mentioned. It is evident that they were collected from oral tradition; and the fact that the same story is occasionally

repeated, in varied form, and that some of the poems themselves bear internal evidence of being more ancient than others, proves that the present collection is only a gathering made early in the middle ages, long after the composition of the pieces, and in no critical spirit. Sophus Bugge, indeed, one of the greatest authorities, absolutely rejects the name of Saemund, and is of opinion that the poetic *Edda*, as we at present hold it, dates from about 1240. There is no doubt that it was collected in Iceland, and by an Icelander.

The most remarkable and the most ancient of the poems in this priceless collection is that with which it commences, the *Völuspá*, or prophecy of the *Völva* or Sibyl. In this chant we listen to an inspired prophetess, "seated on her high seat, and addressing Odin, while the gods listen to her words."

She sings of the world before the gods were made, of the coming and the meeting of the Aesir, of the origin of the giants, dwarfs and men, of the happy beginning of all things, and the sad ending that shall be in the chaos of Ragnarök. The latter part of the poem is understood to be a kind of necromancy—according to Vigfusson, "the raising of a dead *völva*"; but the mystical language of the whole, its abrupt transitions and terse condensations, and above all the extinct and mysterious cosmology, an acquaintance with which it presupposes, make the exact interpretation of the *Völuspá* extremely difficult. The charm and solemn beauty of the style, however, are irresistible, and we are constrained to listen and revere as if we were the auditors of some fugal music devised in honour of a primal and long-buried deity. The melodies of this earliest Icelandic verse, elaborate in their extreme and severe simplicity, are wholly rhythmical and alliterative, and return upon themselves like a solemn incantation. *Hávamál*, the Lesson of the High One, or Odin, follows next; this contains proverbs and wise saws, and a series of stories, some of them comical, told by Odin against himself. The *Valfrúðnismál*, or Lesson of Valfrúðnir, is written in the same mystical vein as *Völuspá*; in it the giant who gives his name to the poem is visited by Odin in disguise, and is questioned by him about the cosmogony and chronology of the Norse religion. *Grimnismál*, or the Sayings of The Hooded One, which is partly in prose, is a story of Odin's imprisonment and torture by King Geirrod. *För Skirnir*, or the Journey of Skirnir, *Harbarðsljóð*, or the Lay of Hoarbeard, *Hymiskviða*, or the Song of Hymir, and *Aegisdrekka*, or the Brewing of Aegir, are poems, frequently composed as dialogue, containing legends of the gods, some of which are so ludicrous that it has been suggested that they were intentionally burlesque. *Thrymskviða*, or the Song of Thrym, possesses far more poetic interest; it recounts in language of singular force and directness how Thor lost his hammer, stolen by Thrym the giant, how the latter refused to give it up unless the goddess Freyia was given him in marriage, and how Thor, dressed in women's raiment, personated Freyia, and, slaying Thrym, recovered his hammer. *Alvismál*, or the Wisdom of Allwise, is actually a philological exercise under the semblance of a dialogue between Thor and Alvis the dwarf. In *Vegtamskviða*, or the Song of Vegtam, Odin questions a *völva* with regard to the meaning of the sinister dreams of Balder. *Rígsmál*, or more properly *Rígsþula*, records how the god Heimdal, disguised as a man called Ríg, wandered by the sea-shore, where he met the original dwarf pair, Ai and Edda, to whom he gave the power of child-bearing, and thence sprung the whole race of thralls; then he went on and met with Afí and Amma, and made them the parents of the race of churls; then he proceeded until he came to Fáfir and Moðir, to whom he gave Jarl, the first of free men, whom he himself brought up, teaching him to shoot and snare, and to use the sword and runes. It is much to be lamented that of this most characteristic and picturesque poem we possess only a fragment. In *Hyndluljóð*, the Lay of Hyndla, the goddess Freyia rides to question the *völva* Hyndla with regard to the ancestry of her young paramour Ottar; a very fine quarrel ensues between the prophetess and her visitor. With this poem, the first or wholly mythological portion of the collection closes. What follows is heroic and pseudo-historic. The *Völundarkviða*, or Song of Völundr, is

engaged with the adventures of Völundr, the smith-king, during his stay with Nidud, king of Sweden. Völundr, identical with the Anglo-Saxon Wieland and the German Wieland (O.H.G. *Wielant*), is sometimes confused with Odin, the master-smith. This poem contains the beautiful figure of Svanhvít, the swan-maiden, who stays seven winters with Völundr, and then, yearning for her fatherland, flies away home through the dark forest. *Helgakviða*, *Hiorvarts sonar*, the Song of Helgi, the Son of Hiorvart, which is largely in prose, celebrates the wooing by Helgi of Svava, who, like Atalanta, ends by loving the man with whom she has fought in battle. Two Songs of Helgi the Hunding's Bane, *Helgakviða Hundingsbana*, open the long and very important series of lays relating to the two heroic families of the *Völsungs* and the *Níblungs*. Including the poems just mentioned, there are about twenty distinct pieces in the poetic *Edda* which deal more or less directly with this chain of stories. It is hardly necessary to give the titles of these poems here in detail, especially as they are, in their present form, manifestly only fragments of a great poetic saga, possibly the earliest coherent form of the story so universal among the Teutonic peoples. We happily possess a somewhat later prose version of this lost poem in the *Völsungasaga*, where the story is completely worked out. In many places the prose of the *Völsungasaga* follows the verse of the Eddaic fragments with the greatest precision, often making use of the very same expressions. At the same time there are poems in the *Edda* which the author of the saga does not seem to have seen. But if we compare the central portions of the myth, namely Sigurd's conversation with Fafnir, the death of Regin, the speech of the birds and the meeting with the Valkyrie, we are struck with the extreme fidelity of the prose romancer to his poetic precursors in the *Sigurðarkviða Fafnissbana*; in passing on to the death of Sigurd, we perceive that the version in the *Völsungasaga* must be based upon a poem now entirely lost. Of the origin of the myth and its independent development in medieval Germany, this is not the place for discussion (see NIBELUNGENLIED). Suffice to say that in no modernized or Germanized form does the legend attain such an exquisite colouring of heroic poetry as in these earliest fragments of Icelandic song. A very curious poem, in some MSS. attributed directly to Saemund, is the Song of the Sun, *Sólarkviða*, which forms a kind of appendix to the poetic *Edda*. In this the spirit of a dead father addresses his living son, and exhorts him, with maxims that resemble those of *Hávamál*, to righteousness of life. The tone of the poem is strangely confused between Christianity and Paganism, and it has been assumed to be the composition of a writer in the act of transition between the old creed and the new. It may, however, not impossibly, be altogether spurious as a poem of great antiquity, and may merely be the production of some Icelandic monk, anxious to imitate the Eddaic form and spirit. Finally *Forspjallsljóð*, or the Preamble, formerly known as the Song of Odin's Raven, is an extremely obscure fragment, of which little is understood, although infinite scholarship has been expended on it. With this the poetic *Edda* closes.

The principal MS. of this *Edda* is the Codex Regius in the royal library at Copenhagen, written continuously, without regard to prose or verse, on 45 vellum leaves. This is that found by Bishop Brynjulf. Another valuable fragment exists in the Arne-Magnæan collection in the University of Copenhagen, consisting of four sheets, 22 leaves in all. These are the only MSS. older than the 17th century which contain a collection of the ancient mythico-heroic lays, but fragments occur in various other works, and especially in the *Edda of Snorri*. It is believed to have been written between 1260 and 1280. The poetic *Edda* was translated into English verse by Amos Cottle in 1797; the poet Gray produced a version of the *Vegtamskviða*; but the first good translation of the whole was that published by Benjamin Thorpe in 1866. An excellent edition of the Icelandic text has been prepared by Th. Möbius, but the standard of the original orthography will be found in the admirable edition of Sophus Bugge, *Norraen Fornkvæði*, published at Christiania in 1867.

The Eddaic poems were rearranged, on a system of their own which differs entirely from that of the early MSS., by Gudbrand Vigfusson and F. York Powell, in their *Corpus poeticarum boreale* (Oxford, 1883). This is a collection, not of *Edda* only but of all existing fragments of the vast lyrical literature of ancient Iceland. It supplies a prose translation. (E. G.)

EDDIUS (ÆDDI), a Kentish choirmaster, summoned by Wilfrid (c. 634-709), bishop of York, to help in organizing church services in Northumbria. He wrote the *Life* of his patron, and this biography of St Wilfrid is the earliest extant historical work compiled by an Anglo-Saxon author. He is a strong partisan and very credulous, but the *Vita Wilfridi* is nevertheless invaluable for the period it treats. Its date is little after the first decade of the 8th century, and it was used by Bede in compiling his *Historia*.

See Eddius, *Vita Wilfridi* (Raine, *Historians of Church of York*, London, 1879-1894), 14; Bede, *Hist. Eccl.* (Plummer, Oxford, 1896), iii. 2.

EDELINCK, GERARD (1649-1707), Flemish copper-plate engraver, was born at Antwerp. The rudiments of the art, which he was to carry to a higher pitch of excellence than it had previously reached, he acquired in his native town under the engraver Cornelisz Galle. But he was not long in reaching the limits of his master's attainments; and then he went to Paris to improve himself under the teaching of De Poilly. This master likewise had soon done all he could to help him onwards, and Edelinck ultimately took the first rank among line engravers. His excellence was generally acknowledged; and having become known to Louis XIV. he was appointed, on the recommendation of Le Brun, teacher at the academy established at the Gobelins for the training of workers in tapestry. He was also entrusted with the execution of several important works. In 1677 he was admitted member of the Paris Academy of Painting and Sculpture. The work of this great engraver constitutes an epoch in the art. His prints number more than four hundred.

Edelinck stands above and apart from his predecessors and contemporaries in that he excelled, not in some one respect, but in all respects,—that while one engraver attained excellence in correct form, and another in rendering light and shade, and others in giving colour to their prints and the texture of surfaces, he, as supreme master of the burin, possessed and displayed all these separate qualities, in so complete a harmony that the eye is not attracted by any one of them in particular, but rests in the satisfying whole. Edelinck was the first to break through the custom of making prints square, and to execute them in the lozenge shape. Among his most famous works are a "Holy Family," after Raphael; a "Penitent Magdalene," after Charles le Brun; "Alexander at the Tent of Darius," after Le Brun; a "Combat of Four Knights," after Leonardo da Vinci; "Christ surrounded with Angels"; "St Louis praying"; and "St Charles Borromeo before a crucifix,"—the last three after Le Brun. Edelinck was especially good as an engraver of portraits, and executed prints of many of the most eminent persons of his time. Among these are those of Le Brun, Rigaud, Philippe de Champagne (which the engraver thought his best), Santeuil, La Fontaine, Colbert, John Dryden, Descartes, &c. He died at Paris in 1707. His younger brother John, and his son Nicholas, were also engravers, but did not attain to his excellence.

EDELWEISS, known botanically as *Leontopodium alpinum*, a member of the family *Compositae*, a native of the Alps of Central Europe. It is a small herb reaching about 6 in. high, with narrow white woolly leaves, and terminal flower-heads enveloped in woolly bracts. The woolly covering enables the plant to thrive in the exposed situations in which it is found, by protecting it from cold and from drying up through excessive loss of moisture. It is grown in Britain as a rock-plant.

EDEN, SIR ASHLEY (1831-1887), Anglo-Indian official and diplomatist, third son of Robert John Eden, third Lord Auckland and bishop of Bath and Wells, was born on the 13th of November 1831, and was educated at Rugby, Winchester and the East India Company's college at Haileybury, entering the Indian civil service in 1852. In 1855 he gained distinction as assistant to the special commissioner for the suppression of the Santal rising, and in 1860 was appointed secretary to the Bengal government with an *ex officio* seat on the legislative council, a position he held for eleven years. In 1861 he negotiated, as

political agent, a treaty with the raja of Sikkim. His success led to his being sent on a similar mission to Bhutan in 1863; but, being unaccompanied by any armed force, his demands were rejected and he was forced under circumstances of personal insult to come to an arrangement highly favourable to the Bhutias. The result was the repudiation of the treaty by the Indian government and the declaration of war against Bhutan. In 1871 Eden became the first civilian governor of British Burma, which post he held until his appointment in 1877 as lieutenant-governor of Bengal. In 1878 he was made a K.C.S.I., and in 1882 resigned the lieutenant-governorship and returned to England on his appointment to the council of the secretary of state for India, of which he remained a member till his death on the 8th of July 1887. The success of his administration of Bengal was attested by the statue erected in his honour at Calcutta after his retirement.

EDEN, the name of the region in which, according to the Hebrew paradise-tradition in its present form, God planted a garden (or park), wherein he put the man whom he had formed (Gen. ii. 8). Research into primitive beliefs, guided by the comparative method, leads to the view that the "garden" was originally a celestial locality (see **PARADISE**), and we cannot therefore be surprised if, now that paradise has been brought down to earth, the geographical details given in the Bible are rather difficult to work into a consistent picture. The fantastic geography of the (Indian) *Vishnu Purana* and the (Iranian) *Bundahish* will, in this case, be a striking parallel.

Let us now take the details of Eden as they occur. In Gen. ii. 8 we read that the garden lay "in Eden eastward," where "eastward" is generally taken to mean "in the east of the earth." This, however, seems inconsistent with Isa. xiv. 13, where the "mountain of God," which corresponds (see Ezek. xxviii. 13, 14 and the article **ADAM**) to the "garden in Eden," is said to have been "in the uttermost parts of the north" (so R.V.). The former statement ("eastward") suits Babylonia, where Friedrich Delitzsch¹ places Eden; the latter does not. We are further told (v. 10) that "a river went out from Eden to water the garden," and that "from thence it parted itself (?), and became four heads (?)," which is commonly understood to mean that the river was so large that, soon after leaving the garden ("from thence" is all that the text says), it could still supply four considerable streams (the text says, not "streams," but "heads," *i.e.* perhaps "beginnings" or "starting-points"). In vv. 11-14 the names of four rivers are given, but in spite of the descriptive supplements attached to three of them, only that one which has no supplement can be identified with much probability. In fact, Pērāth may without any obvious difficulty be "Euphrates," except in Jer. xiii., where a more southerly stream seems indicated, but to the identification of "Hiddekel" with "Tigris" (Babylonian Diglat) the presence of the initial *Hi* in the Hebrew is an objection. Now as to "Pishon" and "Gihon." If a moderately early tradition may be trusted, the "Gihon" is another name for the "Shihor," which was either in or beside "Mizraim" (=Egypt) or Mizrim (=the North Arabian Muḥit), and indeed according to most scholars means the Nile in Jer. ii. 18, where the Septuagint substitutes for it Gēōn, *i.e.* Gihon. For "Pishon" few plausible suggestions have been made; it is not, however, a hopeless problem from the point of view which recognizes Eden in Arabia.

For details of the interesting descriptive supplements of the names Pishon, Gihon, and Hiddekel, on which there is much difference of opinion, it must suffice to refer to the *Encyclopaedia Biblica* and Hasting's *Dictionary of the Bible*. We must, however, mention a widely held explanation of the name *Eden*. Plausible as it is to interpret this name as "delight"—indeed, the Septuagint translates in Gen. iii. 23 f. ὁ παράδεισος τῆς ἡμετέρας—this cannot have been the original meaning. Hence Delitzsch (*Wo lag das Paradies?* p. 70) suggested that "Eden" might be a Hebraized form of the Babylonian *ēdinu*, "field, plain, desert." But whereas Delitzsch takes "Eden" to be the entire plain of

¹ *Wo lag das Paradies?* p. 66. A Sumerian name of Babylon was Tin-ter, "dwelling of life." Cf. Bābili, Bābili, "gate of God."

Babylonia, Hommel thinks that it is rather the plain about the sacred city of Eridu. It is the latter scholar to whom the "Arabian theory" of Paradise in its best-known form is due. The rivers (apart from Pêrâth, "Euphrates") he locates in northern and central Arabia, the "Cush" and "Asshur" of Genesis being, according to him, central Arabia and Edom respectively (*Ancient Hebrew Traditions*, pp. 314-316; *Aufsätze u. Abhandlungen*, iii. 281-284, 335-339). These rivers, in short, become Arabian wadis, on which see *Hast. D.B. i. 132a* (foot). Cheyne, on the other hand, rejects the Babylonian explanation of Eden as = "field, plain," on the ground that "Eden" was originally regarded as a mountainous tract.

See further Driver, *Book of Genesis* (1904), pp. 57-60; *Ency. Bib.* "Paradise"; and the commentaries of Gunkel (2d ed., 1902), and Cheyne (1907). (T. K. C.)

EDENBRIDGE, a market town in the south-western parliamentary division of Kent, England, 26 m. S.S.E. of London, on the South-Eastern & Chatham, and the London, Brighton & South Coast railways. Pop. (1901) 2546. It is pleasantly situated on the river Eden, an affluent of the Medway, in a valley between the Ragstone Hills and the Forest Ridges. The church of St Peter and St Paul is principally perpendicular. The town, which has considerable agricultural trade, possesses a chalybeate spring, but this is little used. Two miles from the town is Hever Castle, a beautiful moated mansion dating from the 15th and 16th centuries, but occupying the site of an earlier structure. This was rebuilt by Sir Geoffrey Boleyn, whose grandson, Sir Thomas, was father of Anne, second wife of Henry VIII., who here spent much of her life before her marriage, and was visited several times by the king. There is a chapel of her family in the fine parish church of Hever. Not far distant is the modern Chiddingstone Castle, on an ancient site. A block of sandstone in the park is called the "chiding stone," tradition asserting it to be a prehistoric seat of judgment.

EDEN HALL, LUCK OF, an old painted drinking goblet preserved at Eden Hall, Cumberland, the seat of the Musgrave family. It is of enamelled or painted glass and is believed to date from the 10th century. It is of fair size and has the letters I.H.S. on the top. Round the vase is the famous verse given below. A legend involving the fortunes of the Musgraves attaches to this cup. In the grounds of Eden Hall is a spring called St Cuthbert's Well, and the story is that one of the earliest of the Musgraves surprised the fairies feasting and making merry round the well. He snatched at the goblet from which the Fairy King was drinking and made off with it. The fairies pursued him to his castle, but failed to catch him. The Fairy King acknowledged his defeat and gave the cup as a prize to Musgrave, but warned him that the gift carried with it a condition:—

"When this cup shall break or fall,
Farewell the luck of Eden Hall."

There are variants of this legend, but substantially they agree. Possessed of the lucky cup the knight of Musgrave is said to have at once prospered in a love-suit which had till then gone against him. There is a curious poem on the cup called "The Drinking Match at Eden Hall," by Philip, duke of Wharton, a parody on the ballad of Chevy Chase. This is reprinted in full in Edward Walford's *Tales of Great Families* (1877, vol. 11), under the heading, "The witty Duke of Wharton." In Longfellow's famous poem the goblet is represented as having been broken.

EDENKOBEN, a town of Germany, in the Bavarian Palatinate, 6 m. N. from Landau, on the railway to Weissenburg. Pop. 5300. It has a Roman Catholic and a Protestant church, several high-grade schools and a sulphur-spring. Its industries comprise linen- and damask-weaving, ironworks, and the manufacture of machinery, furniture and cigars. It has also a considerable trade in wine.

EDENTATA, the name assigned by Cuvier to an order of placental mammals apparently typified by the South American anteater, but likewise including the sloths and armadillos of the same country, and the Old World aard-varks and pangolins. Only the anteaters and pangolins are absolutely without teeth (Lat. *e*, out, *dens*, tooth), and the name is strictly applicable

only to those two groups; but in all the existing representatives of the order teeth are absent from the front of the jaws, while the cheek-teeth are devoid of roots and of enamel, and only very exceptionally have deciduous predecessors. Practically this is all the definition that can be given to the assemblage, which is possibly an artificial one. It may be mentioned, however, that there is not infrequently a separate coracoid bone.

Edentates may be divided into three distinct sections or suborders, firstly the Xenarthra, or Edentata Vera, of America, secondly the Tubulidentia, represented by the African aard-varks, and thirdly the Pholidota, which includes only the pangolins common to Africa and Asia. The Xenarthra are essentially a South and Central American group, some of the members of which have effected an entrance into North America. The three families by which they are now represented are widely sundered, both as regards habits and structure; but two of them—the sloths and the anteaters—are intimately connected by means of the extinct ground-sloths. As regards the presumed relationship of the Old World to the New World types, it is noteworthy that in the early Tertiary deposits of France and Germany are found certain fossil remains apparently referable to armadillos, aard-varks and pangolins, some of the armadillos coming very close to South American forms. This assemblage of three groups of edentates in the countries fringing northern Africa is suggestive that the latter continent may have been the original home of the group, which reached South America by means of a direct land connexion.

Xenarthra.—The typical American edentates, or Xenarthra, are characterized by the circumstance that the last dorsal and all the lumbar vertebrae carry additional articular facets, or abnormal articulations (xenarthral). Teeth may be absent or present, and when developed either all similar (homoeodont) or to some extent differentiated. The bodily covering may take the form either of coarse hairs, or of bony plates, with a larger or smaller intermixture of hairs.

Of the three existing families of this group, the first is that of the *Bradypodidae*, or sloths, characterized by the presence of five pairs of upper and four of lower teeth, the normally-formed tongue and the rudimentary tail. The species are arboreal and feed on leaves; all being confined to the forests of tropical America. Externally sloths are clothed with long coarse, crisp hair; the head is short and rounded, and the external ears inconspicuous. The teeth are subcylindrical, of persistent

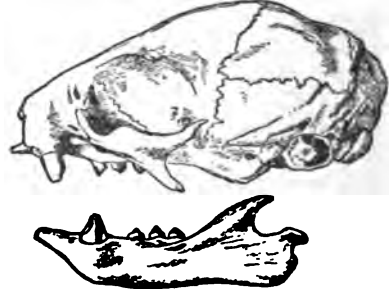

FIG. 1.—Skull of Unau or Two-toed Sloth (*Choloepus didactylus*).

growth, consisting of a central axis of vasodentine, with a thin investment of hard dentine, and a thick outer coating of cement; without any succession. Fore-limbs greatly longer than the hind-limbs; the extremities terminating in narrow, curved feet; with the digits never exceeding three in number, and encased for nearly their whole length in a common integument, and armed with long, strong claws. Stomach complex. No caecum. Placenta deciduate and dome-like, composed of an aggregation of numerous discoidal lobes.

A remarkable feature connected with sloths is the development of a green colour in their hair, due to the growth of an alga-

According to Dr W. G. Ridewood, in the three-toed sloth the hair is invested with a thick extra-cortical layer. "The hair has a tendency to crack in a transverse direction, and in the cracks there come to lodge unicellular algae, to which Kühn has given the name *Pleurococcus bradypsi*. The moisture of the climate in which *Bradypus* lives enables the alga to live and propagate in this curious position, and the sloth acquires a general green tint which must render it very difficult to distinguish as it hangs among the green foliage." In the two-toed sloth, on the other hand, the bulk of the hair is composed of an outer coat, or cortex, which is longitudinally fluted or grooved, the grooves being filled with strands of extra-cortex in which flourishes an alga (*Pleurococcus choleopi*) distinct from the one infesting the hairs of the three-toed species. Of quite a different type are the hairs of the extinct ground-sloths (see MYLONON), which are smooth and solid, Dr Ridewood rejecting the idea that they were originally coated with a cortex that has disappeared.

The typical genus *Bradypus* is represented by the various species of al, or three-toed sloth, in which none of the teeth project greatly beyond the others; the first in the upper jaw is much smaller than any of the others, while the first in the lower jaw is broad and compressed, and the grinding surfaces of all are much cupped. Vertebrae: C 9, D and L 20 (of which 15 to 17 bear ribs), S 6, Ca 11. All the species present the peculiarity of possessing nine cervical vertebrae; but the ninth, and sometimes the eighth, bears a pair of short movable ribs. The fore-limbs are considerably longer than the hind-legs, and the bones of the fore-arm are complete, free and capable of pronation and supination. The fore-feet are long, very narrow, habitually curved and terminate in three pointed curved claws, in close apposition to each other; they are, in fact, incapable of being divaricated, so that the foot is reduced to the condition of a triple hook, fit only for the function of suspension from the boughs of trees. The hind-foot closely resembles the fore-foot in general structure and mode of use, and has the sole habitually turned inwards so that it cannot be applied to the ground in walking. The tongue is short and soft, and the stomach large and complex, bearing some resemblance to that of ruminants. The windpipe or trachea has the remarkable peculiarity—not unfrequent among birds and reptiles—of being folded on itself before it reaches the lungs. The two teats are pectoral in position. The premaxilla is rudimentary and loosely attached to the maxilla. Except in *B. torquatus*, there is no perforation in the lower end of the humerus. Some of the species are covered uniformly with a grey or greyish-brown coat; others have a dark collar of elongated hairs around the shoulders (*B. torquatus*); some have the hair of the face shorter than that of the rest of the head and neck; and others have a remarkable-looking patch of soft, short hair on the back between the shoulders, consisting, when best marked, of a median stripe of glossy black, bordered on each side by bright orange, yellow or white. There are also structural differences in the skulls, as in the amount of inflation of the pterygoid bones. The habits of all are apparently alike. They are natives of Guiana, Brazil and Peru, and two species (*B. infuscatus* and *B. castaneiceps*) extend north of the Isthmus of Panama as far as Nicaragua. Of the former of these a specimen in captivity uttered a shrill sound like a monkey when forcibly pulled away from the tree to which it was holding.

In the species of unau, or two-toed sloth, *Choloepus*, the front tooth in both jaws is separated by an interval from the others, and is large and caniniform, wearing to a sharp bevelled edge against the opposing tooth, the upper shutting in front of the lower when the mouth is closed, unlike true canines. Vertebrae: C 6 or 7, D 23-24, L 3, S 7-8, Ca 4-6. One species (*C. didactylus*) has the ordinary number of vertebrae in the neck; but an otherwise closely allied form (*C. hoffmanni*) has but six. The tail is very rudimentary. The fore-feet generally resemble those of *Bradypus*, but there are only two functional digits, with claws; these answering to the second and third of the typical five-toed limb. The structure of the hind-limb generally resembles that of *Bradypus*, the appellation "two-toed" referring only to the anterior limb, for in the foot the three middle toes are functionally

developed and of nearly equal size. The premaxilla is well developed, and firmly attached to the maxilla; and there is always a perforation, or foramen, on the inner side of the lower end of the humerus. *C. didactylus*, which has been longest known, and is commonly called by the native name of unau, inhabits the forests of Brazil. *C. hoffmanni* has a more northern geographical range, extending from Ecuador through Panama to Costa Rica. Its voice, which is seldom heard, is like the bleat of a sheep; and if the animal is seized it snorts violently. Both species are very variable in external coloration (see SLORR).

The second family is that of the anteaters, *Myrmecophagidae*, distinguished from the last by the absence of teeth, the elongated tongue and the long tail. The long and slender head has a tubular mouth, with a small terminal aperture through which the worm-like tongue, covered with the sticky secretion of the enormous submaxillary salivary glands, is rapidly protruded in feeding, and withdrawn again with the adhering particles of food which are then sucked into the gullet. In the foot the third toe is greatly developed, and has a long sickle-like claw; the others are reduced or suppressed. The hind-foot has four or five subequal digits with claws. The long tail is sometimes prehensile. Placenta dome-like or discoidal. Externally the body is covered with hair. Anteaters feed exclusively on animal substances, mostly insects. One species is terrestrial, the others arboreal; none burrow in the ground. They are all inhabitants of tropical America. In the typical genus *Myrmecophaga* the skull is remarkably elongated and narrow, with its upper surface smooth and cylindrical. Anteriorly the face is produced into a long tubular rostrum, rounded above and flattened below, with terminal nostrils, and composed of the mesethmoid (ossified for more than half its length), the vomer, the maxillae, and the long and narrow nasal bones the premaxillae being extremely short and confined to the margin of the nostrils. The zygomatic arch is incomplete, the rod-like jugal only articulating with the maxilla in front, and not reaching the short zygomatic process of the squamosal. The lachrymal foramen is in front of the margin of the orbit. There are no post-orbital processes to the frontals or any other demarcation between the orbits and the temporal fossae. Palate extremely elongated, and produced backwards as far as the level of the external auditory meatus by the meeting in the middle line of the largely developed pterygoids. The glenoid fossa for the lower jaw, a shallow oval facet, with its long diameter from before backwards. Lower jaw long and slender, with an exceedingly short symphysis, no distinct coronoid process, and a slightly elevated, elongated, flattened, condylar articular surface. Vertebrae: C 7, D 15-16, L 3-2, S 6, Ca 31. Clavicles rudimentary. In the fore-foot the first digit is very slender, the second also slender, with compressed phalanges of nearly equal length, but the third is immensely developed, though its first phalanx is extremely short, while the terminal one is so long that the entire length of the digit exceeds that of the second. The fourth has a long and rather slender metacarpal, and three phalanges diminishing in size, the terminal phalanx being very stout. The fifth has the metacarpal nearly as long, but not so stout as the fourth, and followed by two small phalanges, the last rudimentary and conical. Claws are developed upon all but the fifth. In walking the toes are kept bent, with their points turned upwards and inwards, the weight being supported on a pad over the end of the fifth digit, and the upper surfaces of the third and fourth digits. The hind feet are short and rather broad, with five subequal claws, the fourth rather longest, the first shortest; the whole sole is placed on the ground in walking. Body rather compressed, clothed with long, coarse hair. Tail about as long as the body, and covered with very long hair; not prehensile. Ears small, oval, erect. Eyes very small. Stomach consisting of a sub-globular, thin-walled, cardiac portion, and a muscular pyloric gizzard with dense epithelial lining. No ileocolic valve; but a short, wide, ill-defined caecum. The two teats are pectoral.

The tamandua anteaters (*Tamandua*, or *Uroleptes*), of which several species (or races) are now recognized, are smaller animals than the last, in which the head is much less elongated, the fur

short and bristly, and the tail, tapering, prehensile, with the under side throughout, and the whole of the terminal portion naked and scaly. The stomach is similar to that of *Myrmeecophaga*,



FIG. 2.—*Tamandua* Anteater (*Tamandua tetradactyla*).

but with the muscular pyloric gizzard less strongly developed. There is a distinct ileocolic valve and short globular caecum. The fore-foot has a very large claw on the third toe, moderate-sized claws on the second and fourth, a minute one on the first, and none on the fifth, which is entirely concealed within the skin. The hind-foot has five subequal claws. Vertebrae: C 7, D 17, L 2, S 5, Ca 37. There are very rudimentary clavicles.

The last representative of the family is the tiny golden-haired pigmy or two-toed anteater, *Cyclopes* (or *Cyclopus*) *didactylus*, in which the skull is much shorter even than in the preceding genus, and arched considerably in the longitudinal direction. It differs from that of the other members of the family mainly in the long canal for the posterior nostrils not being closed by bone below, as the greater part of the palatines and the pterygoids do not meet in the middle line. The lower jaw has a prominent, narrow, recurved coronoid, and a well-developed angular process, and is strongly decurved in front. Vertebrae: C 7, D 16, L 2, S 4, Ca 40. Ribs remarkably broad and flat. Clavicles well developed. Fore-foot remarkably modified, having the third digit greatly developed at the expense of all the others; it has a short stout metacarpal and but two phalanges, of which the terminal one is large, compressed, pointed and much curved, with a strong hook-like claw. The second digit has the same number of phalanges, and bears a claw, but is much more slender than the third. The fourth is represented only by the metacarpal, and one nailless phalange, the first and fifth only by rudimentary metacarpals. The hind-foot is also modified into a climbing organ, the first toe being rudimentary and consisting of a metatarsal and one phalange concealed beneath the skin, but the other four toes subequal and much curved, with long, pointed, compressed claws. The tuberosity of the heel-bone or calcaneum is directed towards the sole, and parallel with it and extending to about double its length is a greatly elongated sesamoid ossicle. These together support a prominent cushion to which the nails are opposed in climbing. Stomach pyriform, with muscular walls, but no distinct gizzard-like portion. The commencement of the colon provided with two small caeca, narrow at the base, but rather dilated at their terminal blind ends, and communicating with the general cavity by very minute apertures. Tail longer than the body, tapering, bare on the under surface and prehensile. Fur soft and silky.

The third and last existing family of the Xenarthra is that of the armadillos, or *Dasypodidae*, in which there are at least seven pairs of teeth in each jaw, while the tongue is normal, the tail generally long, and the body covered with an armour of bony plates overlain by horny scales. All the species are terrestrial, and insectivorous or more or less omnivorous.

The union of the numerous polygonal bony shields on the back and sides forms a hard shield, usually consisting of an anterior (scapular) and posterior (pelvic) solid portion (which overhang on each side the parts of the body they respectively cover, forming chambers into which the limbs are withdrawn),

and a variable number of rings between, connected by soft flexible skin so as to allow of curvature of the body. The top of the head has also a similar shield, and the tail is usually enclosed in bony rings or plates. The outer or exposed surfaces of the limbs are protected by irregular bony plates, not united at their margins; but the skin of the inner surface of the limbs and under side of the body is soft and more or less clothed with hair. Hairs also in many species project through apertures between the bony plates of the back. The bony plates are covered by a layer of horny epidermis. Teeth numerous, simple, of persistent growth and usually without milk predecessors. Zygomatic arch of skull complete. Cervical vertebrae with extremely short, broad and depressed bodies; the first free, but the second and third, and often several of the others united together both by their bodies and arches. Clavicles well developed. A third trochanter on the femur. Tibia and fibula united at their lower extremities. Fore-feet with strongly developed, curved claws, adapted for digging and scratching, three, four or five in number. Hind-feet plantigrade, with five toes, all provided with nails. Tongue long, pointed and extensile, though to a less degree than in the anteaters. Submaxillary glands largely developed. Stomach simple. Placenta discoidal and deciduate.

The typical genus *Dasypus*, with several others, represents the subfamily *Dasypodinae*, which usually have all five toes developed and with nails, though the first and fifth may be suppressed. The first and second are long and slender, with the normal number and relative length of phalanges, the others stout, with short broad metacarpals, and the phalanges reduced in length and generally in number by coalescence; the terminal phalange of the third being large, that of the others gradually diminishing to the fifth. *Dasypus* has the most normal form of fore-foot, but the modifications developed in all the others (culminating in *Tolypeutes*) are foreshadowed. Ears wide apart. Teats, one pair, pectoral. In *Dasypus* the teeth are $\frac{1}{2}$ or $\frac{3}{4}$, of which the first in the upper jaw is usually implanted in the premaxillary bone. The series extends posteriorly some distance behind the anterior root of the zygoma, almost level with the hind edge of the palate. The teeth are large, subcylindrical, slightly compressed, diminishing in size towards each end of the series; the anterior two in the lower jaw smaller and more compressed than the others. Cranial portion of the skull broad and depressed, facial portion triangular, broad in front and depressed. Auditory bulla completely ossified, perforated on the inner side by the carotid canal, and continued externally into an elongated bony meatus auditorius, with its aperture directed upwards and backwards. (In all the other genera of *Dasypodinae* the tympanic bone is a mere half-ring, loosely attached to the cranium.) Lower jaw with a high ascending branch, broad transversely placed condyle, and high slender coronoid process. Vertebrae: C 7, D 11-12, L 3, S 8, Ca 17-18. Head broad and flat above, with the muzzle obtusely pointed. Ears of moderate size or rather small, placed laterally far apart. Body broad and depressed. Armour with six or seven movable bands between the scapular and pelvic shields. Tail shorter than the body, tapering, covered with plates forming distinct rings near the base. Fore-feet with five toes; the first much more slender than the others, and with a smaller ungual phalange and nail; the second, though the longest, also slender. The third, fourth and fifth gradually diminishing in length, all armed with strong, slightly curved compressed claws, sloping from an elevated, rounded inner border to a sharp, outer and inferior edge. The hind-foot is rather short, and has all five toes armed with stout, compressed, slightly curved, obtusely pointed claws—the third the longest, the second nearly equal to it, the fourth the next, the first and fifth shorter and nearly equal.

To this genus belongs one of the best-known species of the group, the six-banded armadillo or encoubert (*D. sexcinctus*) of Brazil and Paraguay; a very similar species, *D. villosus*, the hairy armadillo, replacing it south of the Rio Plata. There are also two small species, *D. vellerosus* and *D. minutus*, from the Argentine Republic and North Patagonia; the latter, which differs from the other three in having no tooth implanted in the

premaxillary bone and is often referred to a genus apart, as *Zedonius*.

In *Tatusia* (*Cabassous* or *Lysurus*) the teeth are $\frac{3}{3}$ or $\frac{5}{5}$, of moderate size and subcylindrical: the most posterior placed a little way behind the anterior root of the zygoma, but far from the hinder margin of the palate. Skull somewhat elongated, much constricted behind the orbits, and immediately in front of the constriction considerably dilated. Lower jaw slender, with the coronoid process small and sharp pointed, sometimes obsolete. Vertebrae: C 7, D 12-13, L 5, S 10, Ca 18. Head broad behind. Ears rather large and rounded, wide apart. Movable bands of armour 12-13. Tail considerably shorter than the body, and slender, covered with nearly naked skin, with a few small, scattered, bony plates, chiefly on the under surface and near the apex. On the fore-feet the first and second toes are long and slender, with small claws and the normal number of phalanges. The other toes have but two phalanges; the third has an immense sickle-like claw; the fourth and fifth similar but smaller claws. The hind-feet are comparatively small, with five toes, and small, triangular, blunt nails; the third longest, the first shortest. The best-known species of this genus, the tatouay or cabassou, *T. unicinctus*, is, after *Priodon gigas*, the largest of the group. It is found, though not abundantly, in Surinam, Brazil and Paraguay. Others, such as *T. hispidus* and *T. lugubris*, have been described.

In the giant armadillo (*Priodon gigas*) the teeth are variable in number, and generally differ on the two sides of each jaw, being usually from 20 to 25 on each side above and below, so that as many as a hundred may be present altogether; but as life advances the anterior teeth fall out, and all traces of their sockets disappear. The series extends as far back as the hinder edge of the anterior root of the zygoma. They are all very small, in the anterior half of each series strongly compressed, with flat sides and a straight free edge, but posteriorly more cylindrical, with flat, truncated, free surfaces. Vertebrae: C 7, D 12, L 3, S 10, Ca 23. Head small, elongated, conical. Ears moderate, ovate. Armour with 12-13 movable bands. Tail nearly equal to the body in length, gradually tapering, closely covered with quadrangular scales, arranged in a quincunx pattern. Fore-feet with five toes, formed on the same plan as those of *Tatusia*, but with the claw of the third still greater size, and that of the others, especially the fifth, proportionally reduced. Hind-foot short and rounded, with five very short toes, and short, broad, flat obtuse nails. The giant armadillo is by far the largest existing member of the family, measuring rather more than 3 ft. from the tip of the nose to the root of the tail, the tail being about 20 in. long. It inhabits the forest of Surinam and Brazil. The powerful claws of its fore-feet enable it to dig with great facility; and its food consists chiefly of termites and other insects, although it is said to attack and uproot newly-made graves for the purpose of devouring the flesh of the bodies contained in them.

The apar (*Tolypeutes tricinctus*) typifies a genus in which the teeth are $\frac{3}{3}$ or $\frac{5}{5}$, and are rather large in proportion to the size of the skull, with the hinder end of the series reaching nearly to the posterior margin of the palate. Vertebrae: C 7, D 11, L 3, S 12, Ca 13. Ears placed low on the sides of the head, rather large, broadly ovate. Armour with its scapular and pelvic shields very free at the sides of the body, forming large chambers into which the limbs can be readily withdrawn, and only three movable bands. Tail short, conical, covered with large bony tubercles. The fore-feet formed on the same type as in the last genus, but the peculiarities carried to a still greater extent. The claw of the third toe is very long, while those of the first and fifth are greatly reduced and sometimes wanting. On the hind-foot the three middle toes have broad, flat, subequal nails, forming together a kind of tripartite hoof; the first and fifth much shorter, with more compressed nails.

The armadillos of this genus have the power of rolling themselves up into a ball, the shield on the top of the head and the tuberculated dorsal surface of the tail exactly fitting into and filling up the apertures left by the notches at either end of the

body-armour. This appears to be their usual means of defence when frightened or surprised, as they do not burrow like the other species. They run very quickly, with a very peculiar gait, only the tips of the claws of the fore-feet touching the ground. In addition to the apar, there are the Argentine and Bolivian *T. conurus*, and *T. muriei* from Argentina or Patagonia.

The last group of existing armadillos forms the genus *Tatusia* and the subfamily *Tatusiinae*; the subfamily rank being based on the fact that of the seven or eight pairs of small subcylindrical teeth, all but the last, which is considerably smaller than the rest, are preceded by milk-teeth not changed until the animal has nearly attained full size. Vertebrae: C 7, D 9-11, L 5, S 8, Ca 20-27. Head narrow, with a long, narrow, subcylindrical obliquely truncated snout. Ears rather large, ovate and erect, placed close together on the occiput. Armour with seven to nine distinct movable bands. Body generally elongated and narrow. Tail moderate, or long, gradually tapering; its plates forming distinct rings for the greater part of its length. Fore-feet with four visible toes, and a concealed clawless rudiment of the fifth; the claws long, slightly curved, and slender, the third and fourth subequal and alike, the first and fourth much shorter. Hind-feet with five toes, armed with strong, slightly curved, conical, obtusely pointed nails, and the third longest, then the second and fourth, and the first and fifth much shorter than the others. This genus differs from all the other armadillos in having a pair of inguinal teats in addition to the usual pectoral pair, and in producing a large number (4 to 10) of young at a birth, all the others having usually but one or two. The peba armadillo, *T. septemcincta*, is a well-known species, having an extensive range from Texas to Paraguay. It is replaced in the more southern regions of South America by a smaller species, with shorter tail, the *mulita* (*T. hybrida*) so called from the resemblance of its head and ears to those of a mule. *T. kappleri* is a large species from Guiana.

Finally we have the picchiago, or fairy armadillo, *Chlamyphorus truncatus*, typifying the subfamily *Chlamyphorinae*. In most anatomical characters, especially the structure of the fore-foot, this group resembles the *Dasypodinae*, but it differs remarkably from all other known armadillos, living or extinct, in the peculiar modification of the armour.

The teeth, which number $\frac{4}{4}$, are subcylindrical, somewhat compressed, moderate in size, and smaller at each end (especially in front) than at the middle of the series. Skull broad and rounded behind, pointed in front. Muzzle subcylindrical and depressed. A conspicuous rounded rough prominence on the frontal bone, just before each orbit. Tympanic prolonged into a tubular auditory meatus, curving upwards round the base of the zygoma. Vertebrae: C 7, D 11, L 3, S 10, Ca 15. Upper part of head and trunk covered with four-sided horny plates (with small thin ossifications beneath), forming a shield, free and overhanging the sides of the trunk, and attached only along the middle line of the back. The plates are arranged in a series of distinct transverse bands, about twenty in number between the occiput and the posterior truncated end, and not divided into solid scapular and pelvic shields with movable bands between. The hinder end of the body is abruptly truncated and covered by a vertically placed, strong, solid, bony shield, of an oval (transversely extended) form, covered by thin horny plates. This shield is firmly welded by five bony processes to the hinder part of the pelvis. Through a notch in the middle of its lower border the tail passes out. The latter is rather short, cylindrical in its proximal half, and expanded and depressed or spatulate in its terminal portion, and covered with horny plates. The dorsal surfaces of the fore and hind-feet are also covered with horny plates. The remainder of the limbs and under surface and sides of the body beneath the overlapping lateral parts of the back shield are clothed with rather long, soft silky hair. Eyes and ears very small, and concealed by the hair. Extremities short. Feet large, each with five well-developed claws, those on the fore-feet very long, stout and subcompressed, the structure of the digits being essentially the same as those of *Tatusia* and *Priodon*. Teats two, pectoral. Visceral anatomy closely

resembling that of *Dasybus*, the caecum being broad, short and bifid. The pichiciago, a burrowing animal, about 5 in. long, inhabits the sandy plains of western Argentina, especially the vicinity of Mendoza. Its horny covering is pinkish, and its silky hair white. A second species, *C. reclusus*, from Bolivia is rather larger and has the dorsal shield attached to the skin of the back as far as its edge, instead of only along the median line. (See ARMADILLO.)

Tubulidentata.—The second suborder of edentates, namely the Tubulidentata, is represented at the present day only by the aard-varks, or ant-bears, of Africa, constituting the family *Orycteropodidae* and the genus *Orycteropus*. Together with the following group, they differ from the Xenarthra in the absence of additional articular facets to the lumbar vertebrae; for which reason the term Nomarthra has been proposed for the Tubulidentata and Pholidota as collectively distinct from the Xenarthra. In the present group the external surface is scantily covered with bristle-like hairs. The teeth are numerous, and traversed by a number of parallel vertical pulp-canals. Femur with a third trochanter. Fore-feet without the first toe, but all the other digits well developed, with strong moderate-sized nails, suited to digging, the plantar surfaces of which rest on the ground in walking. Hind-feet with five subequal toes. Placenta broadly zonular. The brain is very like that of the Ungulata; and there are two pairs of teats, one abdominal, and the other inguinal. Aard-varks feed on animal substances; and are terrestrial and fossorial in habits. The total number of teeth is from eight to ten in each side of the upper, and eight in the lower jaw; but they are never all in place at one time, as the small anterior ones are shed before the series is completed behind. In the adult they number usually five on each side above and below, of which the first two are simple and compressed, the next two larger and longitudinally grooved at the sides, the most posterior simple and cylindrical. Their summits are rounded before they are worn; their bases do not taper to a root, but are evenly truncated and continually growing. Each tooth is made up of an aggregation of parallel dental systems, having a slender pulp cavity in the centre, from which the dentinal tubes radiate outwards, and being closely packed together each system assumes a polygonal outline as seen in transverse section. A series of milk-teeth is developed. Skull moderately elongated with the facial portion subcylindrical and slightly tapering, and the zygoma complete and slender. The palate ends posteriorly in the thickened transverse border of the palatines, and is not continued back by the pterygoids. The tympanic is annular, and not welded to the surrounding bones. The lower jaw is slender anteriorly, but rises high posteriorly, with a slender recurved coronoid, and an ascending pointed process on the hinder edge below the condyle, which is small, oval, and looks forward as much as upwards. Vertebrae: C 7, D 13, L 8, S 6, Ca 25. The large number of lumbar vertebrae is peculiar among Edentates. The tongue is less worm-like than in *Mymecophaga*, being thick and fleshy at the base and gradually tapering to the apex. The salivary apparatus is developed much in the same manner as in that genus, but the duct of the submaxillary gland has no reservoir. The stomach consists of a large subglobular cardiac portion, with a thick, soft, and corrugated lining membrane, and a smaller muscular, pyloric part, with a comparatively thin and smooth lining. There is a distinct ileocaecal valve and a considerable sized caecum; also a gall-bladder. Head elongated, with a tubular snout, terminal nostrils and small mouth-opening. Ears large, pointed, erect. Tail nearly as long as the body, cylindrical, thick at the base, tapering to the extremity.

According to the researches of Dr E. Lönnberg, the teeth of the aard-varks correspond only to the roots of those of other mammals, the crowns being unrepresented, except to a very small degree when the teeth first cut the gum. This explanation renders the peculiar internal structure of these teeth much less difficult to understand than if they represented both crown and root. In Dr Lönnberg's opinion, the teeth indicate the descent of the aard-vark from an ungulate stock,—a view in harmony

with the evidence of the brain. If this idea prove well founded, and if the aard-varks are rightly classed with the Edentata, the whole order must apparently be regarded as an offshoot from primitive Ungulata. The fact of the frequent distinctness of the coracoid bone requires, however, explanation in connexion with such a descent (see AARD-VARK).

Pholidota.—The Pholidota, constituting the third and last group of the Edentata, are represented by the pangolins, or scaly anteaters, of Asia and Africa, all of which are included in the family *Manidae* and the genus *Manis*. Pangolins differ from all other mammals by the armour of overlapping horny scales (often with hairs growing between them) which invests the whole animal, with the exception of the under surface of the body, and sometimes a small patch near the tip of the under side of the tail. There are no teeth; and although the tongue is long and worm-like, it is not extensible. The scaphoid and lunar bones of the carpus are united. The uterus is bicornuate, and the placenta diffused and non-deciduate. The skull has somewhat the form of an elongated cone, with the small end turned forwards, and is smooth and free from crests and ridges. No distinction between the orbits and temporal fossae. The zygomatic arch usually incomplete, owing to the absence of the jugal bone; no distinct lacrymal bone; and the palate long and narrow. The pterygoids extend backwards as far as the tympanics, but do not meet in the middle line below. Tympanic welded to the surrounding bones, and more or less bladder-like, but not produced into a tubular auditory meatus. Two halves of lower jaw very slender and straight, without any angle or coronoid process, on the anterior extremity of the upper edge a sharp, conical, tooth-like process projecting upwards and outwards. No clavicles. No third trochanter to the femur. Terminal phalanges cleft at the tip. Caudal vertebrae with very long transverse processes and numerous chevron-bones. Stomach with thick muscular walls and lining membrane, and a special gland near the middle of the great curvature, consisting of a mass of complex secreting follicles, the ducts of which terminate in a common orifice. No caecum, but a gall-bladder. Head small, depressed, narrow, and pointed in front, with a very small mouth-opening. Eyes and ears very small. Body elongated, narrow. Tail more or less elongated, convex above, flat underneath. Limbs short, and in walking the surface and outer sides of the phalanges of the two outer digits of the front feet alone rest on the ground, with the points of the nails turning upwards and inwards. The third toe the longest, with a powerful compressed curved claw, the second and fourth with similar but smaller claws, but that of the first toe often almost rudimentary. Hind-feet plantigrade with the first toe very short, and the four other toes subequal, and carrying moderate, curved, compressed nails. Pangolins are of small or moderate size, terrestrial and burrowing, and feed mainly on termites or white ants; some of the species being more or less arboreal. They can roll themselves up in a ball when in danger. Their peculiar elongated form, short limbs, long tapering tail, and scaly covering give them on a superficial inspection more the appearance of reptiles than of mammals. The species are not numerous and may be divided into two sections, one comprising the Asiatic species, such as *M. javanica*, *M. aurota* of China, and the Indian *M. pentadactyla*, and the other the African, as represented by the large *M. gigantea*, *M. temminckii*, the long-tailed *M. macrura*, and the small arboreal *M. tricuspis*. In the Asiatic group the middle series of scales continues to the tip of the tail; but in the African forms this row splits into two a few inches from the tail-tip. The latter have also no hairs between the scales and no external ears. The climbing species have a small bare patch on the under side of the tail near the tip (see PANGOLIN).

Extinct Edentates.

Beyond remains of species closely allied to or identical with the existing forms, the sloths and anteaters appear to be unknown in a fossil state. On the other hand the extinct family of ground sloths, or *Megatheriidae*, which includes the largest of all edentates, is an exceedingly large one, and extends in South America from

the Miocene to the Pleistocene, and was also represented during the latter epoch in North America. It serves to connect the *Bradypodidae* with *Myrmecophagidae*. The alleged occurrence of an allied form in Madagascar is somewhat doubtful (see *MEGATHERIUM* and *MYLodon*).

Of *Dasypodidae* numerous representatives occur in the South American Tertiaries. From the higher beds many of the species are referable to existing genera, such as *Dasyops* and *Tatusia*, although some are much larger than any living forms, the skull in one case being nearly a foot in length. In other instances, when lower formations are reached, the genera are also distinct, *Eutatus* having the whole armour divided into movable bands, and the allied *Siegottherium* representing the group in the Santa Cruz formation of Patagonia. Even in the Argentine Pleistocene there is an extinct genus, *Chlamydotherium*, represented by a species of the size of a rhinoceros, with grooved teeth approximating to those of the glyptodonts. The latter represent a family (*Glyptodontidae*) by themselves, and typically may be described as giant solid-shelled armadillos, although some of their smaller Santa Cruz representatives (*Propalaeocephalorus*) approximate in some degree to true armadillos (see *GLYPTODON*).

A very remarkable Santa Cruz armadillo, *Peltephilus*, has an altogether peculiar type of head-shield, developed into horns in front of the eyes; and, what is still more noteworthy, teeth in the front of the jaws, thereby rendering the ordinary definition of the order Edentata incorrect. It has been made the type of a distinct family, *Peltephilidae*.

The past history of the armadillo group does not, however, by any means end here. True armadillos, it should be observed, are known in North America as far north as Texas, from the Pleistocene onwards; but in formations of middle Tertiary age are unrepresented. Recent discoveries apparently indicate, however, the occurrence of armadillos of a primitive type in the lower Tertiary or Eocene formations of Wyoming. The first evidence of these Eocene armadillos was afforded by portions of the jaws, which, together with a leg-bone of a totally different animal, were believed to indicate creatures nearly allied to the aye-aye (*Chiromys*) of Madagascar, and for which the name *Metachiromys* was consequently proposed. According to modern usage, this name, in spite of its inappropriate nature, is retained for the armadillos, although in the writer's opinion it ought to be replaced. According to Professor H. F. Osborn, by whom their remains have been described, the North American fossil armadillos were closely related to the existing members of the group, from which they differ chiefly by the armour, or shield, having probably been formed of tough leathery skin instead of bony plates, by the presence of a single pair of large enamel-capped tusk-like teeth in each jaw, and by the degeneration of the other teeth. If these determinations are trustworthy, the question arises whether we should regard the armadillos of South America as the descendants of North American forms which migrated southwards before that separation of the two continents was established, which lasted for a large portion of the Tertiary period, or whether a migration took place at the same early epoch in the opposite direction.

More interesting still is the occurrence of remains of reputed armadillos (*Necrodasyops*) from the Oligocene of France and Germany. In the opinion of Dr F. Ameghino these Oligocene armadillos, which had bony shields on both the head and body, were near akin to some of the modern South American forms.

Passing on to the aard-varks (*Orycteropodidae*), we find these represented by a species closely allied to the existing ones in the Lower Pliocene formations of Spain, France, Hungary, Samos and Asia Minor. A single tibia from the French Oligocene is identified by Dr Ameghino with the present family, and the genus *Archaeorycteropus* established for its reception; this genus, in its founder's opinion, being also represented in the Santa Cruz beds of Patagonia. As regards the pangolins, the only fossils referred to this group (apart from a few discovered in a cave in India) appear to be certain limb-bones from the Oligocene of France and Germany, for which the names *Necromanis* and *Tesomanis* have been proposed. The occurrence of the character-

istic cleft terminal toe-bones among these remains seems to leave little doubt as to the correctness of the determination.

The alleged occurrence of remains of giant pangolins in the upper Tertiary of Europe is due to misidentification (see *ANCYLOPODA*). By some authorities the Eocene group of *Ganodontia* has been affiliated to the Edentata, but this reference is not accepted by Prof. W. B. Scott.

AUTHORITIES.—The above article is to some extent based on the articles by Sir W. H. Flower in the 9th edition of this work. See also O. Thomas, "A Milk-dentition in *Orycteropus*," *Proc. Royal Soc. vol. xlvii.* (1890); R. Lydekker, "The Extinct Edentates of Argentina," *Palaeont. Argentina*, vol. iii., An. Mus. (La Plata, 1894); C. W. Andrews, "On a Skull of *Orycteropus gaudryi* from Samos," *Proc. Zool. Soc. London* (1896); G. E. Smith, "The Brain in the Edentata," *Trans. Linn. Soc. London*, vol. vii. (1899); W. B. Scott, "Mammalia of the Santa Cruz Beds—*Dasyops*," *Rep. Princeton Exped. to Patagonia*, vol. v. (1903); H. F. Osborn, "An Armadillo from the Middle Eocene of North America," *Bull. Amer. Mus. vol. xx.* art. 12 (1904); J. A. Allen, "The Tamandua Anteaters," *T.C.*, art. 33 (1904); F. Ameghino, "Les Edentés fossiles de France et d'Allemagne," *Ann. Mus. Buenos Aires*, vol. xiii. (1905); E. Lönnberg, "On a new *Orycteropus*," and "Remarks on the dentition of the Tubulidentata," *Archiv für Zoologie*, vol. iii. No. 3 (1906). (R. L.)

EDENTON, a town and the county-seat of Chowan county, North Carolina, U.S.A., on Edenton Bay, an estuary of Albemarle sound, near the mouth of Chowan river, in the N.E. part of the state. Pop. (1890) 2205; (1900) 3046 (2090 negroes); (1910) 2789. It is served by the Norfolk & Southern railway, and by the Albemarle Steam Navigation Co. In 1907 the former projected a great bridge across Albemarle sound near the city. Edenton is an old and interesting town, has a number of fine old homesteads, and has broad and well-shaded streets. Lumbering and the shad and herring fisheries are the most important industrial interests, and the town is a shipping point for fish, truck and other farm products, cotton and peanuts. There is a Fish Cultural Station here, established by the Federal government. The court-house was built about 1750.

Edenton was settled about 1658, and was for some time known as the "Towne on Queen Anne's Creek" or the "Port of Roanoke"; in 1722 the present name was adopted in honour of Governor Charles Eden (1673-1722), whose grave is in St Paul's churchyard here. Throughout the 18th century Edenton was a place of considerable social and political importance; the legislative assembly of North Carolina met here occasionally, and here lived the royal governors and various well-known citizens of the province, among them: Joseph Hewes (1730-1779), a signer of the Declaration of Independence; James Iredell, Sr. (1750-1799), a Federalist leader and after 1790 a justice of the United States Supreme Court, and his son James Iredell, Jr. (1788-1853), a prominent lawyer, for many years a member of the state legislature, governor of North Carolina in 1827-1828, and a member of the United States Senate in 1828-1831. Near Edenton lived Samuel Johnston (1733-1816), a prominent leader of the American Whigs preceding and during the War of American Independence, a member of the Continental Congress in 1780-1782, governor of North Carolina in 1787-1789, and a Federalist member of the United States Senate in 1790-1793. In 1907 the Hewes, Iredell and Johnston homesteads were still standing. In a house facing the court-house green the famous "Edenton Tea Party" of fifty-one ladies met on the 24th of October 1774 and signed resolutions that they would not conform "to that Pernicious Custom of Drinking Tea" and would not "promote the wear of any manufacture from England" until the tax on tea should be repealed. Near Edenton the Confederate ram "Albemarle," on emerging from the Roanoke river, was met by the Union "double-enders," "Sassacus," "Mattabesett," and "Miami," on the 5th of May 1864; the battle, which resulted in favour of the Confederates, was a duel between the Confederate ironclad and the Union wooden side-wheeler, the "Sassacus," which rammed the "Albemarle" and had her bows, fitted with a three-ton bronze beak, twisted off and carried away.

EDESSA (mod. *Vodena*), the ancient capital of Macedonia, previously known as *Aegae*, situated 46 m. W. of Thessalonica

on the banks of a beautiful stream in the very centre of the kingdom, and at the head of a defile commanding the approaches from the coast to the interior. It was the original residence of the Macedonian kings; and even after the seat of government was removed by Philip II. to the more accessible Pella, it continued to be the burial-place of the royal family. At the celebration of his daughter's marriage here, Philip II. was murdered by Pausanias in 336 B.C. His son Alexander was buried at Memphis through the contrivance of Ptolemy; but the bodies of his granddaughter Eurydice and her husband Arrhidæus were removed by Cassander to the ancestral sepulchre. On the occupation of the town by Pyrrhus the royal tombs were plundered by the Gallic mercenaries. Owing to its position commanding the Via Egnatia, the town retained its importance during the Roman and Byzantine periods. For its present condition, see VODENA.

EDESSA, the Greek name of an ancient city of N.W. Mesopotamia (in 37° 21' N. lat. and 39° 6' E. long.), suggested perhaps by a comparison of its site, or its water supply,¹ with that of its Macedonian namesake. It still bears its earlier name, modified since the 15th century (by the Turks?) to Urfa.

The oldest certain form is the Aramaic *Urhâi* ("Western" pronunciation *Urhâi*), which appears in Greek as an adjective as *Ὀρρηαῖος*,² -*οῦ*³ (perhaps also as a fortress with spring, as *Ὀρρηά*),⁴ and in Latin as *Orr(h)esi*,⁵ and (in the inscription on Abgar's grave) *Orrhonoru(m)*.⁶ The Syriac Chronicle ascribed to Dionysius of Tell-mahrê derives the name from a first king Urhâi, son of Hewyâ, whom Procopius (*De bello persico*, l. 17) calls Osroes (cf. below), connected by Bayer⁷ with Choeroes,⁸ from which G. Hoffmann would also derive the Syriac *Urhâi* (*Z.D.M.G.* xxxii, 742). The Syriac town name has, however, the form of an ethnic, and we may therefore with Duval leave it unexplained (*Hist.* 22). The fact that the Arabic name is *Ruhâ* supports the hint of the Graeco-Latin forms that there was a vowel between the R and the H. There is little plausibility in the suggestion of Assemani and others that *Ruhâ* comes from *roy* of Callirrhoe. A gentile of the form Ru-u-ai occurs in a letter (of an Assyrian king?) to chiefs in a (Babylonian?) town as the designation of three captives (Harper, *Ass. and Bab. Letters*, No. 287, l. 94), line 6; cf. Bezaud, *Die Achämenidenschriften*, p. xii), who have Semitic names; and Ru-u-ai is the name of an Aramaic people mentioned with other Aramaeans by Tiglath-pileser IV. Sargon and Sennacherib. It is not impossible that some such people may have settled at Urhâi and given it their name, although the Ru-u-ai are always mentioned in connexions that imply seats near the Persian Gulf.⁹ The district name Osroênê for *Ὀσροῦνη*, is Greek, perhaps due to analogy of Choeroes. It occurs but rarely in Syriac (Uroina); e.g. Chronicle of Edessa, § 35;¹⁰ elsewhere Bêth-Urhâyé (e.g. Cureton, *Spicilège*, Syr. 20). In the time of Tiglath-pileser I. (c. 1100 B.C.) the name seems to have been "District of (not Edessa, but) Harrân" (Annals, vi. 71). The Arabs pronounced the name er-Ruhâ (see above), and that form prevailed till it gave place to Urfa in the 15th century.

The Greek name Edessa appears in the Jerusalem Targum to Gen. x. 10 as Hâdas (חַדַּס, myrtle); it has been proposed (cf. Duval, *Hist. d'Edesse*, 23) to derive Edessa from Aram. חַדַּס, as though = Carthage, New Town; but Syriac writers, when they occasionally¹¹ use the name (Edessa, חַדַּס; so Yâqût, Adâsâ), show no suspicion of its being Semitic. According to Pliny, v. 86, Edessa was also called Antioch, and coins of Antiochus IV. Epiphanes with the legend "Antioch on the Callirrhoe" may imply that he rebuilt and renamed the place (so Ed. Meyer in Pauly-Wissowa, *Realencyclopädie*, col. 1933, 66; otherwise Duval, *Hist.* 23; cf. art. OSROENE). Pliny indeed seems to call the city itself Callirrhoe, and S. Funk finds it so named in the Talmud (*Bab. Mes.*, i. 18a טוּרַס חַדַּס חַרְרַי; *Die Juden in Babylonien* 200-500, il. 148; 1908); but K. Regling (*Klio*, l. 459 n. 1) may be right in his emendation which applies the title in Pliny to the sacred spring.

History: Pre-Hellenistic.—Until excavation gives us more definite data we can only infer from its position on one of the

main thoroughfares between the Mediterranean and the East (see MESOPOTAMIA) that Urhâi-Edessa, possibly bearing some other name, was already a town of some importance in the early Babylonian-Assyrian age. Whatever may have been the ethnographical type of the early inhabitants, it must by the beginning of the second last millennium B.C. have included Hittites in the large sense of the term, probably Aryans, and certainly Semites of some of the types characteristic of early Assyrian history. Most probably its people belonged to the domain of the then more famous Harrân-Carrhae, between which and Samosata (on the Euphrates) Urhâi lies midway (some 25-30 m. distant from each) in the district watered by the Balîh. Although at Edessa itself no cuneiform documents have yet been found, a little more than four hours' journey eastwards, at Anaz (= Gullâb?) = Dâr of Tiglath-pileser IV. was found in 1901 a slab with a bas-relief and an inscription; and 15-20 min. W. of Eski-Harrân, in 1906 a very interesting 6th-century Assyrian inscription (see MESOPOTAMIA).

In the later Assyrian period the population was largely Aramaic-speaking; but S. Schiffer's theory (Beihft I. zur *Orientalistischen Literatur-Zeitung*) finds contemporary evidence of Israelites settled in the neighbourhood of Edessa in the second half of the 7th century B.C. At the fall of Nineveh many towns in Mesopotamia suffered severely at the hands of the Medes. The period remains dark, notwithstanding the obscure light that has been thrown on it lately (Pognon, *Inscriptions*). When Aramaic began to take the place of Assyrian in written documents is not known; but just across the Euphrates the change had occurred as early as the 8th century B.C. (Zengirli, Hamath; see also Pognon). Certain it is that the earliest documents that have survived in Syriac, or Edessene Aramaic, do not represent an experimental stage. Moreover, although the Syriac of the Story of Ahîqâr is of a late type, the sources of the story, traces of which are to be found in the Hebrew Tobit (q.v.), go back to the pre-Hellenistic period.

Graeco-Roman Times.—According to a credible tradition found in Eusebius (*Excerpta*, 179), the Syriac Chronicle ascribed to Dionysius of Tell-mahrê (Tullberg, 61), and elsewhere, Urhâi was renovated, like other Mesopotamian sites, in 304 B.C. by Seleucus I. Nicator, who gave it its Greek name.¹² It would share in the Hellenistic culture of Syria, although the language of the common people would continue to be Aramaic (E. R. Bevan, *House of Seleucus*, i. 227 f. with ref.). With the decay of the Seleucid power, weakened by Rome and Parthia, the old influx from the desert would recommence, and an Arabic element begin to show. Von Gutschmid (*Untersuch.*, cf. Duval, ch. iii. end) argues plausibly that it was in 132 B.C., in the reign of Antiochus VII. Sidetes, that Edessa became the seat of a dynasty of some thirty local kings, whose succession has been preserved in native sources. The name of the first king, however, appears in different forms (cf. above), and one (Osroês-Orhai) is so like that of the town that Ed. Meyer suspects the historicity of the first reign, of five years. The names of the other kings—Abgar, Ma'nu, Bekr, &c.—are for the most part Arabic, as the people (in whose inscriptions the same mixture of names occurs) are called by classical authors; but the rulers, among whom an occasional Iranian name betrays the influence of the dominant Parthians,¹³ would hardly maintain their distinctness from the Aramaic populace. This state which lasted for three centuries and a half, naturally varied in extent.¹⁴ Bounded on the W. and the N. by the Euphrates, it reached at its widest as far as the Tigris. At such times, therefore, it included such towns as Harrân (Carrhae), Nisibis, Sargî, Zeugma-Birejik, Resaena, Singara, Tigranocerta, Samosâta, Melitene. Its position "on the dangerous verge of two contending empires," Parthia and

¹² On a possible restoration under the name of "Antioch on the Callirrhoe" see above.

¹³ The Edessans used to call their town "the city," or "the daughter," "of the Parthians" (Cureton, *Anc. Syr. Doc.* 41. ult. 97 l. 7; 106 l. 12).

¹⁴ The portion of the Mesopotamian steppe under Osroënic influence was, according to Noldeke (*Zeitsch. Ass.* xxi. 153, 1908), called 'Arâbb in Syriac.

¹ Steph. Byz., s.v. ΒΑΡΥΡΑ.

² Dio, *passim*.

³ Isidore Charac. I (Müller, *Geog. Gr. Min.*, i. 246).

⁴ Several times in Pliny, *Nat. Hist.*

⁵ *CIL.* vi. 1797.

⁶ *Hist. Osroëna et Edessena*, p. 33.

⁷ Written *Ὀρρηαῖος* in Dio Cassius, *Excerpta*, lxxvii. 22.

⁸ See the ref. collected by M. Streck, *M.V.G.*, 1906. The name occurs in the same company in the fragmentary tablet K. 1002. The mountain Ru-u-ai, mentioned thrice by Tiglath-pileser IV., is placed by Billerbeck near Hamadân (*Sandschak Suleimania*, 82, 86, and map, 1898).

⁹ See further Payne Smith, *Thesaurus* 110 b.
 ¹⁰ In translating from the Greek; also in Ephraim (Duval, *Hist.* 22, n. 4) and the Acts of Sharbil (Cureton, *Anc. Syr. Doc.* 41).

Rome, determined its changeable fortunes. Parthian predominance yielded for a time to Armenian (Tigranes, 88-86 B.C.). Then, at the time of the expeditions of Lucullus, Pompey and Crassus, Edessa was an ally of Rome, though Abgar II. Ariamnes (68-53) played an ambiguous part. In A.D. 114 Abgar VII. entertained Trajan on his way back to Syria (Dio Cass. xviii. 21); but in 116, in consequence of a general rising, his consul L. Quietus sacked the city, Abgar perhaps dying in the flames, and made the state tributary. Hadrian, however, abandoning Trajan's forward policy in favour of a Euphrates boundary, restored it as a dependency of Rome. When L. Verus (163-165) recovered Mesopotamia from Parthia, it was not Edessa but Harrân that was chosen as the site of a Roman colony, and made the metropolis by Marcus Aurelius (172).

To one of the native kings doubtless it is to be ascribed the Syriac inscription¹ on one of the pair of pillars, 50 ft. high, which stood, no doubt, in front of a temple connected with some local cult. Trustworthy data for determining its nature are lacking. One or both of the pools below the citadel containing sacred fish may have been sacred to Atargatis (q.v.), an Ishtar-Venus deity; and according to the *Doctrine of Addai*, alongside of Venus were worshipped the sun and the moon.² Nergal and Sin were known as "twins," and connected with the sign Gemini, under the name *elamme*, "the youths" (cf. Zimmern, *K.A.T.* 363). This makes more plausible than it otherwise would be the suggestion of J. Rendel Harris that the great twin pillars were connected with the cult of the Dioscuri, and that in the Acts of Thomas is to be seen a later attempt to substitute other "twins," viz. Jesus and Judas-Thomas (Addai), whom legend buried "in Britio Edessenorum" (explained by Harnack as the Edessan citadel: *Aram. birkha*).³

Whether it was at Edessa that a Jewish translation of the Old Testament into Syriac was made,⁴ under the encouragement perhaps of the favour of the royal house of Adiabene (Josephus, *Bell. Jud.* ii. 19. 4), or whether that work was done in Adiabene,⁵ cannot be discussed here. That the translation did not share the fate of the other non-Christian Syriac writings, which did not survive the 13th century (see SYRIAC LITERATURE), is due to the fact that it was adopted (after being revised) by the Christians, and thus rescued. Although the beginnings of Christianity at Edessa are enshrouded in the mists of legend, and the first mention of Christian communities in Osroëne and the towns there is connected with the part they played in the paschal controversy (c. A.D. 192), it has been reasonably urged that the legends imply a fact, namely that Christianity began in the Jewish colony, perhaps by the middle of the 2nd century, although the earliest seat of the Syrian church may have been farther east, in Adiabene.⁶ Parts of the New Testament were certainly translated into Syriac in the 2nd century, although whether the "Old Syriac" (so e.g. Hjelt) or the Diatessaron (so Burkitt) came first is uncertain. About the end of the 2nd century Edessene Christianity seems to have made a fresh beginning: the ordination of Palô; by Serapion of Antioch may mean that things ecclesiastical took a westward trend, and it is possible (so Burkitt) that the "Old Syriac" New Testament version was now introduced. A strong man offered himself in Bardaisân (q.v.; Bardesanes), to whom perhaps we owe the finest Syriac poem extant, the "Hymn of the Soul," though orthodox rejected him. He was a contemporary of Abgar IX., at whose court Julius Africanus stayed for a while. A Syrian official record from this reign, preserved in the *Edessene Chronicle*, gives a somewhat detailed account of a violent flood (autumn, 201) of the Dajân river which did much damage, destroying

amongst other things "the palace of Abgar the Great," rebuilt as a summer palace by Abgar IX., and "the temple of the church of the Christians." The form of this last statement shows that at the time of writing (206) the rulers had not adopted Christianity themselves. Abgar IX. is now commonly supposed to be the ruler to whom the famous legend was first attached (see ABOGAR); but though he visited Rome there is no proof that he ever became a Christian (Gomperz, in *Archäologisch-epigraphische Mitteilungen aus Österreich-Ungarn*, xix. 154-157). It was at Edessa that Caracalla, who made it a military colony under the style of Colonia Marcia Edessenorum, spent the winter of 216-217, and near there that he was murdered. The religious philosophical treatise preserved under the title of *Book of the Laws of the Lands* was probably produced at this time by a pupil of Bardesanes, and the *Acts of Thomas* in its original form may have followed not long after.

Sassanian Period.—In 226 the Parthian empire gave place to the new kingdom of the Sassanidae, whose claim to the ancient Achaemenian empire led to constant struggle with Rome in which Edessa naturally suffered. The native state was restored by Gordian in 242; but in 244 it became again directly subject to Rome. The Edessan martyrs Sharbel and Barsamya, whose "Acts" in legendary form have come down to us, may have perished in the Decian persecution. In 260 the city was besieged by the Persians under Shapur I., and Valerian was defeated and made prisoner by its gates. Odaenathus of Palmyra (d. 267), however, wrested Mesopotamia from the Persians; but Aurelian defeated his successor Zenobia at Emesa (273), and Carus, who died in 283 in an expedition against the Persians, and Galerius (297) carried the frontier again to the Tigris. Diocletian's persecution secured the martyr's crown for the Edessenes Shamôna, Guria (297), and Habbîb (309), and shortly thereafter Lucian "the martyr," who though born at Samosata received his training at Edessa; but the bishop Qôna, who laid the foundations of "the great church" by the sacred pool, somehow escaped. Edessa can claim no share in "the Persian Sage" Aphrahat; or Afrabat (Aphraates); but Ephraem, after bewailing in Nisibis the sufferings of the great Persian war under Constantius and Julian, when Jovian in 363 ceded most of Mesopotamia to Shapur II., the persecutor of the Christians, settled in Edessa, which as the seat of his famous school (called "the Persian") grew greatly in importance, and attracted scholars from all directions. He taught and wrote vigorously against the Arians and other heretics, and although just after his death (373) the emperor Valens banished the orthodox from Edessa, they returned on the emperor's death in 378. Under Zenobius, disciple of Ephraem, studied the voluminous writer, Isaac of Antioch (d. *circa* 460). Rabbûla perhaps owed his elevation to the see of Edessa (411-435), in the year which produced the oldest dated Syriac MS., to his asceticism, and it was to his time that the sojourn there of the "Man of God" (Alexis) was assigned; but he won from the Nestorians the title of the Tyrant of Edessa. In particular he exerted himself to stamp out the use of the Diatessaron in favour of the four Gospels, the Syriac version of which probably now took the form known as the Peshitta. When the popular Nestorianism of the Syrians was condemned at Ephesus (431) it began to gravitate eastwards, Nisibis becoming its eventual headquarters; but Edessa and the western Syrians refused to bow to the Council of Chalcedon (451) when it condemned Monophysitism. In and around Edessa the theological strife raged hotly.⁷ When, however, Zeno's edict (486) ordered the closing of the school of the Persians at Edessa, East and West drifted apart more and more; the ecclesiastical writer Narsai, "the Harp of the Holy Spirit," fled to Nisibis about 489. Till about this time Syriac influence was strong in Armenia, and some Syriac works have survived only in Armenian translations. In the opening years of the 6th century the Persian-Roman War (502-506) found a chronicler in the anonymous Edessene history known till recently as the Chronicle of Joshua Stylites. Whether Edessa received

¹ The inscription, which is difficult to read, connects the structure with Shamlat the queen, daughter of Ma'nu, who cannot be identified with certainty, and refers to some image(s), which probably excited the pious vandalism of the Arabs.

² Nêbo and Bel (*Doctr. Addai*, 31) may come from the Old Testament (Burkitt).

³ *S.B.A.W.*, 1904, 910 ff.

⁴ So, e.g. F. C. Burkitt, *Early Eastern Christianity*, 72.

⁵ Marquart, *Ostasiat. und osesurop. Streifzüge*, 292 ff.

⁶ Marquart, *op. cit.*

⁷ Some one found time, however, to produce the oldest dated MS. of a portion of the Bible in any language.

from the emperor Justin I. the additional name of Justinopolis may be uncertain (see Hallier, *op. cit.* p. 128); but it seems to have been renewed and fortified after the "fourth" flood in 525 (Procop. *Pers.* ii. 27; *De aedific.* ii. 7). About this time, according to Noldeke, an anonymous Edessene wrote the Romance of Julian the Apostate, which so many Arab writers use as a history. Chosroes I. Anushirwān succeeded in 540, according to the last entry in the Edessene Chronicle, in exacting a large tribute from Edessa; but in 544 he besieged it in vain. A few years later Jacob Baradaeus, with Edessa as centre of his bishopric, was carrying on the propaganda of Monophysitism which won for the adherents of that creed the name of Jacobites (q.v.). The valuable Syriac Chronicle just referred to probably was compiled in the latter half of this century.

Islam.—In the first decade of the next century Edessa was taken by Chosroes II., and a large part of the population transported to eastern Persia. Within a score of years it was recovered by the emperor Heraclius, who reviewed a large army under its walls. The prophet of Islam was now, however, building up his power in Arabia, and although Heraclius paid no heed to the letter demanding his adhesion which he received from Medina (628), and the deputation of fifteen Rahāwiyān who paid homage in 630 were not Edessenes but South Arabians, a few years later (636?) Heraclius's attempts, from Edessa as a centre, to effect an organized opposition to the victorious Arabs were defeated by Sa'd, and he fell back on Samosata. The terms on which Edessa definitely passed into the hands of the Moslems (638) under Riyād are not certain (Balādihur). As it now ceased to be a frontier city it lost in importance. In 668 occurred another destructive flood (Theophanes, p. 537), and in 678 an earthquake which destroyed part of the "old church," which the caliph Mo'awiyā I. is said to have repaired. To the latter part of the century belongs the activity of Edessa's bishop Jacob, whose chronicle is unfortunately lost. It may have been the impulse given by the final supremacy of the caliphate to the long process which eventually substituted a new branch of Semitic speech for the Aramaic (which had now prevailed for a millennium and a half), that led Jacob to adopt the Greek vowel signs for use in Syriac. A century later Theophilus of Edessa (d. 785), author of a lost history, translated into Syriac "the two books of the poet Homer on the Conquest of the city of Ilion." When the Bagdad caliphs lost control of their dominions, Edessa shared the fortunes of western Mesopotamia, changing with the rise and fall of Egyptian dynasties and Arab chieftains. In the 10th century al-Mas'ūdī, writing in the very year in which it happened, tells how the Mahomedan ruler of Edessa, with the permission of the caliph, purchased peace of the emperor Romanus Lecapenus by surrendering to him the napkin of Jesus of Nazareth, wherewith he had dried himself after his baptism. The translation of the Holy Icon of Christ from Edessa is commemorated on the 16th of August (Cal. Byzant). A few years later Ibn Haukal (978) estimates the number of churches in the city at more than 300, and al-Moqaddasi (985) describes its cathedral, with vaulted ceiling covered with mosaics, as one of the four wonders of the world. In 1031 the emperor recovered Edessa; but in 1040 it fell into the hands of the Seljuks, whose progress had added a large element of Armenian refugees to the population of Osrohene. There is no reason, therefore, to discredit Maqrizi's statement that it was three brother architects from Edessa that the Armenian minister Badr al-Gamālī employed to build three of the fine city gates of Cairo (1087-1091). The empire soon recovered Edessa, but the resident made himself independent. Thoros applied for help to Baldwin, brother and successor of Godfrey of Bouillon in the First Crusade, who in 1098 took possession of the town and made it the capital of a Burgundian countship, which included Samosata and Sarrūg, and was for half a century the eastern bulwark of the kingdom of Jerusalem.¹ The local Armenian historian, however, Matthew of Edessa, tells of oppression, decrease of population, ruin of churches, neglect of agriculture.

¹ The counts were: Baldwin I. (1098), Baldwin II. (1100), Joscelin I. (1119), Joscelin II. (1131-1147).

With the campaign of Maudud in 1110 fortune began to favour the Moslems. Edessa had to endure siege after siege. Finally, in 1144 it was stormed, Matthew being among the slain, by Imād ud-Din Zengi, ruler of Mosul, under Joscelin II., an achievement celebrated as "the conquest of conquests," for laying the responsibility of which not on God but on the absence of the Frankish troops, an Edessan monk, John, bishop of Harrān (d. 1165), brought down upon himself the whole bench of bishops. Edessa suffered still more in 1146 after an attempt to recover it. Churches were now turned into mosques. The consternation produced in Europe by the news of its fate led to "the Second Crusade." In 1182 it fell to Saladin, whose nephew recovered it when it had temporarily passed (1134) to the sultan of Rūm; but the "Eye of Mesopotamia" never recovered the brilliance of earlier days. The names it contributed to Arabic literature are unimportant. By timely surrender (1268) it escaped the sufferings inflicted by Hūlakū and his Mongols on Sarrūg (Barhebraeus, *Chron. Arab.*, Beirūt ed., 486). Mostaufi describes a great cupola of finely worked stone still standing by a court over a hundred yards square (1340). All b. Yazid in his account of the campaigns of Timūr, who reduced Mesopotamia in 1393, still calls the city (1425) Rūhā. In 1637, when Amurath IV. conquered Bagdad and annexed Mesopotamia, it passed finally into the hands of the Turks, by whom it is called Ura.

The Modern Town.—Ura lies north-east of the Nimrud Dagh. It is surrounded by a wall, strengthened by square towers at distances of 18-20 steps, probably dating in its present condition from mediæval Mahomedan times. On a height in a corner towards the west, overtopping the town by 100-200 ft., are the remains of the old citadel, and the two famous Corinthian columns¹ known as "the Throne of Nimrud." In the hollow between this height and the town rise two springs which form ponds, the farther removed of which from the citadel is known as Birket al-Khallī, doubtless the Callirrhoe of the classical writers, and contains the sacred fish, estimated by J. S. Buckingham at 20,000, and the nearer as 'Ain Zalkha (i.e. Zuleikha, the wife of Potiphar). On the north edge of the Birket al-Khallī (see plan in Sachau, p. 197) is the great mosque of Abraham, the interior of which is described by J. S. Buckingham (*Travels*, pp. 108-110). Diagonally opposite the mosque is a house with a square tower, which is locally believed to occupy the place of the famous ancient school. The waters of the two pools make their way in a single stream southwards out of the town. The once dangerous stream *Daiṣān* (*Zapros*) no longer flows southwards through the town, but encircles it on the north and east in the channel of the old moat. This stream, now called Kara Kuyun, and the other are exhausted in the irrigation of the gardens lying south-east of the town, except when fuller than usual, when they reach the Balh. Not far east of the sacred pool is the largest building in the town, the recent Armenian Gregorian cathedral, whose American bells were first heard during Sachau's visit in 1879. About the middle of the town is the largest mosque, Ulu Gamī (parts of it probably pre-Islamic), which probably occupies the site of the Christian church reckoned by the early Mahomedan writers as one of the wonders of the world. In the bazaar, which lies between the chief mosque and the sacred pool, and contains several streets, are displayed not only the native woollen stuffs, pottery and silver work, but also a considerable variety of European goods, especially cloth stuffs. The principal manufactures are fine cotton stuffs and yellow leather. The streets are of course narrow and winding; but the houses are well built of stone. The outskirts are occupied by melon gardens, vineyards and mulberry plantations. The fertile plain south of the town is noted for its wheat and fine pasture. The climate is healthy except in summer; the "Aleppo button" (see BAGDAD, vilayet), a painful boil, is common. The rocky heights south and west of the town, whence the building material is largely obtained, are full of natural and artificial caverns, once used as dwellings, cloisters and graves, where are most of the

¹ Pictures in Burkitt, *Early East. Christ.*, frontispiece; P.S.B.A. xxviii. 151 f.; J. R. Harris, *The Heavenly Twins*.

inscriptions published by Sachau, who also visited and describes (pp. 204-206) the Dér Ya'qûb, nearly two hours distant.

Urfa is the capital of a sanjak of the same name, in the vilâyet of Aleppo. The population was estimated by Olivier in 1706 at 20,000 to 24,000, by Buckingham at 50,000, by Chernik in 1873 at 40,000, by Sachau in 1879 at 50,000, in Baedeker's Handbook in 1906 at 30,000. Vice-Consul Fitzmaurice said that before December 1895 it was close on 65,000, of whom about 20,000 were Armenian, 3000 or 4000 Jacobites, Syrian-Catholic, Greek-Catholic, Maronites and Jews, and the remaining 40,000 Turkish, Kurdian and Arab Mahomedans. Two barbarous massacres occurred on the 28th and 29th of October and the 28th and 29th of December 1895; 126 Armenian families were absolutely wiped out. He believes that 8000 Armenians perished in the second massacre. The Deutsche Orient-Mission has its chief seat in Urfa, and there have for years been American and French missions. The Germans have an orphanage with 300 Armenian children, a carpet factory and a medical station. The American school had some years ago 250 pupils.

AUTHORITIES.—Inscriptional: H. Pognon, *Inscriptions sémitiques de la Syrie, de la Mésopotamie et de la région de Mossoul* (1907, 1908); Sachau, "Edessensische Inschriften," in *Z.D.M.G.* xxxvii. 142-167; F. C. Burkitt, "The Throne of Nimrod," in *P.S.B.A.* xxviii. 149-155 (1906); J. Rendel Harris, *The Cult of the Heavenly Twins* (1906); Nöldeke, "Syrische Inschriften," in *Z.A.* xxi. 151-161, 375-388 (1908). Literary: Ludwig Hallier, *Untersuchungen über die Edessensische Chronik mit dem Syrischen Text* (1892); F. Nau, *Analyse des parties inédites de la chronique attribuée à Denys de Tell-Mahr* (1892); J. B. Chabot, *Chronique de Denys de Tell-Mahr, quatrième partie* (1895); W. Wright, *The Chronicle of Joshua the Stylite* (1882); Bayer, *Historia Osrhoëna et Edessena* (St Petersburg, 1784), collects the references in classical authors; for the coinage see references in von Gutschmid (see below). Discussions: A. von Gutschmid, "Untersuchungen über die Geschichte des Königreichs Osrhoëne" (in *Mémoires de l'Acad. imper. des sciences de St-Petersb.* vii. sér. tome 35, No. 1, 1887); L.-J. Tixeront, *Les Origines de l'église d'Edesse et la légende d'Abgar* (1888); R. A. Lipsius, *Die Edessensische Abgarsage kritisch untersucht* (1880); K. C. A. Matthes, *Die Edess. Abgarsage auf ihre Fortbildung untersucht* (1882); F. Nau, *Une Biographie inédite de Bardesane l'astrologue* (1897); *Bardesane l'astrologue: le livre des Lois des Pays* (1899); A. Hilgenfeld, *Bardesane, der letzte Gnostiker* (1864); A. A. Bevan, "The Hymn of the Soul" (in *Texts and Studies*, 1897); F. C. Burkitt, *Early Eastern Christianity* (1904); J. R. Harris, *The Discursi in Christian Legend* (1903), and *The Cult of the Heavenly Twins* (1906); the histories of Rome, Persia, Crusades, Mongols, &c.; Rubens Duval, *Histoire politique, religieuse et littéraire d'Edesse jusqu'à la première croisade* (1862), a useful compilation reprinted from the *Journ. As.*; the excellent article by E. Meyer in Pauly-Wissowa, *Realencyclopädie*, 1903-1938. Topography: J. S. Buckingham, *Travels in Mesopotamia* (1827); E. Sachau, *Reise in Syrien u. Mesopotamien* (1883), 189-210; cf. Duval, *op. cit.* chap. 1; C. Ritter, *Erdkunde*, iii. 315-356. Map of town in Niebuhr, *Voyage en Arabie*, reproduced with modifications in Wright, *Chron. Josh. Styl.*; also a map in Reclus, *Univ. Geog.* ix. 232. Four pictures of the town in Burkitt, *Early East. Christ.* (H. W. H.).

EDFU, in Coptic *Atbô*, a town of Upper Egypt, 484 m. S.S.E. of Cairo by rail, on the W. bank of the Nile, the railway station being on the opposite side of the river. Pop. (1907) 19,262. The inhabitants manufacture earthenware, which finds ready sale all through Egypt. The ancient *Atbô* (*Apollinopolis Magna*) was capital of the second nome of Upper Egypt. The great sandstone temple is practically complete (see **ARCHITECTURE: Egypt**). It was built on the site of an earlier structure entirely in the time of the Ptolemies. The central part of the building, begun by Ptolemy III. Euergetes in 237 B.C., was finished by his successor in 212; the portico, court, pylons and surrounding wall were added by Ptolemy Euergetes II., Soter II. and Alexander I.; but the decoration was not finished till 57 B.C. in the reign of Ptolemy XIII. Neos Dionysus. The god of *Atbô* was a form of Horus (Apollo) as the sun-god; his most characteristic representation is as the disk of the sun with outspread wings, so often seen over the doors of shrines, at the top of stelae, &c. In the temple, where he is often figured as a falcon-headed man, he is associated with Hathor of Dendera and the child Harsemeus.

See Baedeker's *Egypt*; Ed. Naville, *Textes relatifs au mythe d'Horus recueillis dans le temple d'Edjou*. (F. LL. G.)

EDGAR (EADGAR), king of the English (944-975), was the younger son of Edmund the Magnificent and Ælfgifu. As early

as 955 he signed a charter of his uncle Eadred, and in 957 the Mercian nobles, discontented with the rule of his elder brother Eadwig, made him king of England north of the Thames. On the death of his brother in October 959 Edgar became king of a united England. Immediately on his accession to the throne of Mercia Edgar recalled St Dunstan from exile and bestowed on him first the bishopric of Worcester, and then that of London. In 961 Dunstan was translated to Canterbury, and throughout Edgar's reign he was his chief adviser, and to him must be attributed much of the peace and prosperity of this time.

The reign of Edgar was somewhat uneventful, but two things stand out clearly: his ecclesiastical policy and his imperial position in Britain. Edgar and Dunstan were alike determined to reform the great monastic houses, and to secure that they should be restored once more to their true owners and not remain in the hands of the secular priests or *canonici*, whose life and discipline alike seem to have been extremely lax. In this reform Edgar was helped not only by St Dunstan but also by Oswald of Worcester and Æthelwold of Winchester. The priests of the old and new monasteries at Winchester, at Chertsey and at Milton Abbas were replaced by monks, and in monastic discipline the old rule of St Benedict was restored in all its strictness.

The coronation of Edgar was, for some unexplained reason, delayed till the Whitsunday of 973. It took place with much ceremony at Bath, and was followed shortly after by a general submission to Edgar at Chester. Six, or (according to later chroniclers) eight kings, including the kings of Scotland and Strathclyde, pledged their faith that they would be the king's fellow-workers on sea and land. The historical truth of this story has been much questioned; there seems to be little doubt that it is true in its main outlines, though we need not accept the details about Edgar's having been rowed on the Dee by eight kings.

Two isolated and unexplained incidents are also recorded in the chronicle: first, the ravaging of Westmorland by the Scandinavian Thored, son of Gunner, in 967; and second, the ravaging of Thanet by Edgar's own command in 970.

Edgar's death took place in the year 975, and he was buried at Glastonbury. By his vigorous rule and his statesmanlike policy Edgar won the approval of his people, and in the Saxon chronicle we have poems commemorating his coronation and death, and describing his general character. The only fault ascribed to him is a too great love for foreigners and for foreign customs. Edgar strengthened the hands of the provincial administration, and to him has been attributed the reorganization of the English fleet. The characteristic feature of his rule was his love of peace, and by efficient administration he secured it.

Edgar formed an irregular union in 961 with Wulfthryth, an inmate of the convent at Wilton, who bore him a daughter Eadgyth. He next married Æthelfled, "the white duck," daughter of Earl Ordmerc, who bore him a son, afterwards known as Edward the Martyr. Finally he was united to Ælflthyth, daughter of Earl Ordgar, who became the mother of the Ætheling Edmund (d. 971) and of Æthelred the Unready.

AUTHORITIES.—*Saxon Chronicle* (ed. Plummer and Earle, Oxford), *sub. ann.*; *Vita Sancti Oswaldi* (*Historians of the Church of York*, ed. Raine, Rolls Series); William of Malmesbury, *Gesta regum* (ed. Stubbs, Rolls Series); Birch, *Cartularium Saxonicum*, vol. iii. Nos. 1047-1319; F. Liebermann, *A.-S. Laws*, i. 192-216; "Florence of Worcester" (*Mon. Hist. Brit.*); E. W. Robertson, *Historical Essays*, pp. 189-215. (A. M. W.)

EDGAR, or **EADGAR** (c. 1050-c. 1130), called the Ætheling, was the son of Edward, a son of the English king Edmund Ironside, by his wife Agatha, a kinswoman of the emperor Henry II., and was born probably in Hungary some time before 1057, the year of his father's death. After the death of Harold in 1066, Archbishop Aldred and the citizens of London desired to make him king, but on the advance of William, Edgar and his supporters made their submission. In 1068, after the failure of the first rising of the north, Edgar retired to Scotland, when his sister Margaret married the Scottish king, Malcolm Canmore.

Next year he returned to take part in the second rising, but, this proving no more successful than the first, he again took refuge in Scotland. In 1074 he went to Normandy and made peace with William. In the struggle between Henry I. and Robert of Normandy, Edgar sided with the latter. He was taken prisoner at the battle of Tinchebrai in 1106, but was subsequently released. The date of his death is uncertain, but he was certainly alive about 1125.

EDGE CUMBE, or **EDGE COMBE**, the name of a celebrated west of England family, taken from the manor of Edgcombe in Cornwall. One of its earlier members was Sir Richard Edgcombe (d. 1489), who was descended from a Richard Edgcombe who flourished during the reign of Edward I. Richard was a member of parliament in 1467; afterwards he joined Henry, earl of Richmond, in Brittany, returned with the earl to England, and fought at Bosworth, where he was knighted. He received rich rewards from Henry, now King Henry VII., who also sent him on errands to Scotland, to Ireland and to Brittany, and he died at Morlaix on the 8th of September 1489. His son and successor, Sir Piers Edgcombe, went to France with Henry VIII. in 1513, and when he died on the 14th of August 1539 he left with other issue a son, Sir Richard Edgcombe (1499-1562), a cultured and hospitable man, who is celebrated through Richard Carew's *Friendly Remembrance of Sir Richard Edgcombe*. Sir Richard's eldest son, Piers or Peter Edgcombe (1536-1607), was a member of parliament under Elizabeth for about thirty years.

Another famous member of this family was Richard, 1st baron Edgcombe (1680-1758), a son of Sir Richard Edgcombe. Educated at Trinity College, Cambridge, he was successively member of parliament for St Germans, Plympton and Lostwithiel from 1701 to 1742; on two occasions he served as a lord of the treasury; and from 1724 to 1742 he was paymaster-general for Ireland, becoming chancellor of the duchy of Lancaster in 1743. Edgcombe was a faithful follower of Sir Robert Walpole, in whose interests he managed the elections for the Cornish boroughs, and his elevation to the peerage, which took place in 1742, was designed to prevent him from giving evidence about Walpole's expenditure of the secret service money. He died on the 22nd of November 1758. His son and successor, Richard, the 2nd baron (1716-1761), was comptroller of the royal household, a member of parliament, and a major-general in the army. A wit, a writer of verse, a gambler and an intimate friend of Horace Walpole, "Dick Edgcombe" died unmarried on the 10th of May 1761.

Edgcombe's brother, George, 1st earl of Mount Edgcombe (1721-1795), was a naval officer who saw a great deal of service during the Seven Years' War. Succeeding to the barony on the 1st baron's death in 1761 he became an admiral and treasurer of the royal household; he was created Viscount Mount-Edgcombe in 1781 and earl of Mount-Edgcombe in 1789. He died on the 4th of February 1795, his only son being his successor, Richard, the 2nd earl (1764-1839), the ancestor of the present earl and the author of *Musical Reminiscences of an Old Amateur*. He died on the 26th of September 1839. His son, Ernest Augustus, the 3rd earl (1797-1861), wrote *Extracts from Journals kept during the Revolutions at Rome and Palermo*.

EDGE HILL, an elevated ridge in Warwickshire, England, near the border of Oxfordshire. The north-western face is an abrupt escarpment of the lias, and the summit of the ridge is almost level for nearly 2 m., at a height somewhat exceeding 700 ft. The escarpment overlooks a rich lowland watered by streams tributary to the Avon; the gentle eastern slope sends its waters to the Cherwell, and the ridge thus forms part of the divide between the basins of the Severn and the Thames. Edge Hill gave name to the first battle of the Great Rebellion (q.v.), fought on the 23rd of October 1642. Charles I., marching on London from the north-west, was here met by the parliamentary forces under Robert Devereux, earl of Essex. The royalists were posted on the hill while the enemy was in the plain before Kineton. But the rash advice of Prince Rupert determined the king to give up the advantage of position; he descended to the attack, and though Rupert himself was successful against the

opposing cavalry, he was checked by the arrival of a regiment with artillery under Hampden, and, in the meantime, the royalist infantry was driven back. The parliamentarians, however, lost the more heavily, and though both sides claimed the advantage, the king was able to advance and occupy Banbury.

EDGEWORTH, MARIA (1767-1849), Irish novelist, second child and eldest daughter of Richard Lovell Edgeworth (q.v.) and his first wife, Anna Maria Elers, was born in the house of her maternal grandparents at Black Bourton, Oxfordshire, on the 1st of January 1767. Her early efforts in fiction were of a sufficiently melodramatic character; for she recollected one of her schoolgirl compositions, in which the hero wore a mask made of the dried skin taken from a dead man's face. Her holidays were often spent in the house of the eccentric Thomas Day, for whom she entertained a genuine respect. She had ample opportunities for society among her father's neighbours in Ireland, among whom were the second Lord Longford, whose daughter, "Kitty" Pakenham, became later duchess of Wellington, Lady Moira at Castle Forbes, and Maria's aunt, Margaret Ruxton, at Black Castle. She gained a first-hand experience of the Irish peasantry by acting as her father's assistant in the management of the estate. The Edgeworths were in Ireland from 1793 onwards through that dangerous period, and Maria's letters, always gay and natural, make very light of their anxieties and their real perils.

Mr Edgeworth encouraged his daughter's literary instincts. It has been the fashion to regard his influence over Maria's work as altogether deplorable, but against the disadvantages arising from his interference must be weighed the stimulus she undoubtedly derived from his powerful mind. Her first publication was a plea for female education, *Letters to Literary Ladies* (1795), and in 1796 appeared the collection of stories known as *The Parent's Assistant* (2nd ed., 6 vols., 1800), an unpromising title which was not chosen by the author. The stories had been submitted as they were written to the juvenile critics of the Edgeworth nursery. They were therefore children's stories for children, even though the morals were Mr Edgeworth's. In 1798 Mr Edgeworth's fourth marriage threatened the family harmony, but Maria soon became a close friend of her step-mother. *Practical Education* (2 vols., 1798) was written in conjunction with her father, who also collaborated with her in the *Essay on Irish Bulls* (1802). Miss Edgeworth's first novel, *Castle Rackrent, an Hibernian Tale taken from Facts, and from the Manners of the Irish Squires before the year 1782*, was written without her father's supervision, and appeared anonymously in 1800. It is the story of an Irish estate and its owners, the Rackrents, as told by Thady, the steward. Its success was immediate, and a second edition soon appeared with the author's name. Perhaps because of the absence of Richard Lovell Edgeworth's co-operation, the book is the most natural and vigorous of her novels. The course of the story is not altered to suit any moral, and the personages appear to be drawn immediately from the natives of Edgeworthstown, though Miss Edgeworth asserts that only Thady himself was an actual portrait. In her realistic pictures of Irish peasant life she opened up a new vein in fiction, and even if the unquestionable excellences of *Castle Rackrent* were less, it would still be a noteworthy book. In the "General Preface" to the 1829 edition of his novels Sir Walter Scott, writing of the publication of *Waverley*, says: "I felt that something might be attempted for my own country, of the same kind with that which Miss Edgeworth so fortunately achieved for Ireland," and in the "Postscript, which should have been a preface," in the original edition of *Waverley*, he describes his aim as being "in some distant degree to emulate the admirable Irish portraits of Miss Edgeworth, so different from the 'Teagues' and 'dear joys' who so long, with the most perfect family resemblance to each other, occupied the drama and the novel." *Belinda* (1801) is a society novel and one of her best books. Mr Saintsbury thinks that Miss Austen's heroines owe something of their naturalness to *Belinda*, who was one of the earliest to break with the tradition of fainting

and blushing. *Moral Tales for Young People* (5 vols.) and *Early Lessons*, which included "Harry and Lucy," "Rosamond" and "Frank," appeared in 1801.

In 1802 the Edgeworths went abroad, first to Brussels and then to Paris. They had already connexions in Paris through their kinsman, the abbé Henri Allen Edgeworth de Firmont, who was, however, then in exile. They met all the notabilities in Paris, and Maria refused an offer of marriage from a Swedish count named Edelcrantz. Although *Leonora*, not published until four years later, is said to have been written to meet his taste, she apparently remained then and always heart-whole; but her stepmother thought otherwise, and maintained that she suffered severely for her decision (*Memoir*, i. 144). Returning to Edgeworthstown, Miss Edgeworth resumed her writing, which was always done in the rooms commonly used by the whole family. *Popular Tales* was published in 1804, and *The Modern Griselda* in the same year; *Leonora* in 1806; and in 1809 the first series of *Tales of Fashionable Life*, three volumes containing "Ennui," "Madame de Fleury," "Almrcia," "The Dun" and "Manœuvring"; the second series (3 vols., 1812) included "The Absentee," one of her best tales, which was originally designed as a play, "Vivian" and "Émilie de Coulanges." In 1813 Maria and her parents spent a considerable time in London, and her society was much sought after. When *Waverley* was published, Miss Edgeworth received a copy from the publishers, and at once recognized the authorship. She wrote a long letter of appreciation (23rd of October 1814) to "the author of *Waverley*," which she began with the phrase *auſ Scotus, auſ diabolus*, but the letter was merely acknowledged by the publishers. *Patronage* (4 vols., 1814), the longest of her novels, and *Harrington, a tale*, and *Ormond, a tale* (3 vols., 1817) complete the list of the works which received what her father called his *imprimatur*.

After his death in 1817 Miss Edgeworth occupied herself with completing his *Memoirs*, which were published in 1820. The book was the excuse for an attack on Mr Edgeworth's reputation in the July number of the *Quarterly Review*, which Miss Edgeworth had the courage to leave unread. Her life at Edgeworthstown was varied by visits to London, to Lord Lansdowne at Bowood, Wiltshire, to the Misses Sneyd in Staffordshire, and to many other friends. In 1820 she was again in Paris, and in 1823 she spent a happy fortnight with the Scotts at Abbotsford. In 1825 Scott went to Edgeworthstown, and their relations were always cordial.

Miss Edgeworth's production was less after her father's death. Sequels to "Rosamond," "Frank," "Harry and Lucy" in the *Early Lessons* were published in 1822-1825. *Comic Dramas* appeared in 1817, and *Helen* in 1834. She worked to the last, and in 1846 laboured strenuously for the relief of the famine-stricken Irish peasants. She died on the 22nd of May 1849.

Miss Edgeworth's novels are distinguished by good sense, humour and an easy flowing style. As the construction of a plot is not her strong point, she is generally more successful in tales than in lengthy novels. The vivacity of her dialogues is extraordinary; and in them her characters reveal themselves in the most natural way possible. Her books are character-studies rather than intensely interesting narratives. Sobriety of judgment is seen throughout; and passion, romance and poetry rarely, if ever, shed their lustre on her pages. Three of her aims were to paint national manners, to enforce morality, and to teach fashionable society by satirizing the lives of the idle and worldly. She expressly calls some of her stories "Moral Tales"; but they all fall under this category. In her pages the heroic virtues give place to prudence, industry, kindness and sweetness of temper. There are few instances of overwhelming emotions or tumultuous passions in her works; and it is remarkable how little the love of nature appears. She never uses material which does not yield some direct moral lesson. But the freshness of her stories, her insight into character, lively dialogues, originality of invention, and delightfully clear style render it quite possible to read her works in succession

without any sense of weariness. Among the many sweet memories her unsullied pages have bequeathed to the world, not the least precious is her own noble character, which ever responded to all that is best and most enduring in human nature.

See *A Memoir of Maria Edgeworth, with a Selection from her Letters* (1867), by her stepmother, F. A. Edgeworth, privately printed. A selection from this was made by Augustus J. C. Hare, and printed under the title of *The Life and Letters of Maria Edgeworth* (2 vols., 1894). See also *Maria Edgeworth* (1883), by Helen Zimmern, in the "Eminent Women" series; Grace A. Oliver, *A Study of Maria Edgeworth* . . . (3rd ed., Boston, U.S.A., 1882); and *Maria Edgeworth* (1904), by the Hon. Emily Lawless in the "English Men of Letters" series. Among the numerous shorter articles dealing with Maria Edgeworth and the family circle at Edgeworthstown may be mentioned a friendly appreciation of Miss Edgeworth's novels by George Saintsbury in *Macmillan's Magazine* (July 1895), and a charming description of her family circle and surroundings in the preface supplied by Lady Thackeray Ritchie to Macmillan's edition of the novels (1895).

EDGEWORTH, RICHARD LOVELL (1744-1817), Irish writer, was born at Bath on the 31st of May 1744. The greater part of his life, however, was spent at Edgeworthstown, or Edgeworthshill, in the county of Longford, Ireland, where the Edgeworth family had been settled for upwards of 150 years. He was of gentle blood—his father being the son of Colonel Francis Edgeworth, and his mother, Jane Lovell, being the daughter of Samuel Lovell, a Welsh judge. Richard's mother taught him to read at a very early age; and from childhood he had a strong love for mechanical science. The Rev. Patrick Hughes initiated him in Liliye's *Latin Grammar*—an office he also performed for Goldsmith, who was born on the property of the Edgeworths—and his public education began, in August 1752, in a school at Warwick. He subsequently attended Drogheda school, then reputed the best in Ireland; and, after spending two years at a school in Longford, entered Trinity College, Dublin, in April 1761, but was transferred to Corpus Christi College, Oxford, in October of the same year. While still at college, he made a runaway match, marrying at Gretna Green, Anna Maria, one of the daughters of Paul Elers of Black Bourton, Oxfordshire, an old friend of his father. His eldest son was born before Edgeworth reached his twentieth birthday, and his daughter Maria in 1767.

Shortly after the birth of his son, he and his wife went to Edgeworthstown, but in 1765 they took a house at Hare Hatch, near Maidenhead. Edgeworth devoted much time to scientific reading and experiments; and he made an attempt to establish telegraphic communication (*Memoirs*, 2d edition, i. 144). He also invented a turnip-cutter, a one-wheeled chaise and other contrivances. In the pursuit of his mechanical inventions he visited Erasmus Darwin at Lichfield, where he met Anna Seward, and her cousin, Honora Sneyd. His home was now at Hare Hatch, in Berkshire, where he endeavoured to educate his son according to the method explained in Rousseau's *Émile*. In later life, however, the ill-success of this experiment led him to doubt many of Rousseau's views (*Memoirs*, ii. 374). At the same time he kept terms at the Temple, and formed the greatest friendship of his life with Thomas Day, the author of *Sandford and Merton*, which was written at Edgeworth's suggestion. In 1769, on the death of his father, he gave up the idea of being a barrister; but, instead of immediately settling on his Irish estate, he spent a considerable time in England and France, mainly in Day's company. In Lyons, where he resided for about two years, he took an active part in the management of public works intended to turn the course of the Rhone. He was summoned to England by the death of his wife (March 1773), with whom he was far from happy. Edgeworth hurried to Lichfield, to Dr Erasmus Darwin's, and at once declared his passion for Honora Sneyd, which had been the cause of his flight to France two years before. Miss Sneyd had been the object of attention from Thomas Day, but her views on marriage were not submissive enough to please him. She had other suitors, among them the unfortunate Major André. She married Edgeworth (July 1773), and after residing at Edgeworthstown for three years, they settled at Northchurch, in Hertfordshire. After six years of domestic happiness, Honora Edgeworth d

(April 1780), recommending her husband to marry her sister Elizabeth; and they were actually married on Christmas Day, 1780.

In 1782 Edgeworth returned to Ireland, determined to improve his estate, educate his seven children, and ameliorate the condition of the tenants. Up to this point Edgeworth has told his own story in his *Memoirs*. The rest of his life is written by his daughter, who opens with a lengthy panegyric on her father as a model landlord (*Memoirs*, ii. 12-36). In 1785 he was associated with others in founding the Royal Irish Academy; and, during the two succeeding years, mechanics and agriculture occupied most of his time. In October 1789 his friend Day was killed by a fall from his horse, and this trial was soon followed by the loss of his daughter Honora, who had just reached her fifteenth year. In 1792 the health of one of Edgeworth's sons took him to Clifton, where he remained with his family for about two years, returning in 1794 to Edgeworthstown. Ireland was, at that time, harassed by internal disturbances, and threats of a French invasion, and Edgeworth offered to establish telegraphic communication of his own invention throughout the country. This offer was declined. A full account of the matter is given in Edgeworth's *Letter to Lord Charlemont on the Telegraph*; and his apparatus is explained in an "Essay on the Art of Conveying Swift and Secret Intelligence," published in the sixth volume of the *Transactions of the Royal Irish Academy*. In the autumn of 1797 the third Mrs Edgeworth died.

Practical Education (1798) was written in collaboration with his daughter Maria, and embodied the experience of the authors in dealing with children. "So commenced," says Miss Edgeworth, "that literary partnership which, for so many years, was the pride and joy of my life" (*Memoirs*, ii. 170). This book, generally regarded as old-fashioned, has a real value in the history of education. Mr Edgeworth's interest in the subject had been inspired by the study of Rousseau and by his friendship with Thomas Day. But he went beyond Rousseau, who developed his theories from his own ingenious mind and related an imaginary process. The Edgeworths brought a scientific method to their work. The second Miss Edgeworth (Honora Sneyd) began the collection of actual examples of conversations between the children and their elders. This was continued patiently by the writers of the book; and their reasonings were thus founded on an accurate record of childish methods of thought. They deprecated especially any measures that interrupted the child's own chain of reasoning. The chapters on special subjects of study, chronology, geometry, &c., were written by Richard Lovell Edgeworth; those on toys, on rewards and punishments, on temper, &c., by his daughter.¹

In 1798 Edgeworth married Miss Beaufort, and was elected M.P. for the borough of St John's Town, Longford. The same year, too, saw a hostile landing of the French and a formidable rebellion; and for a short time the Edgeworths took refuge in Longford. The winter of 1802 they spent in Paris. In 1804 the government accepted his telegraphic apparatus, but the installation was left incomplete when the fear of invasion was past. In 1802 appeared the *Essay on Irish Bulls* by Mr and Miss Edgeworth; and in 1806 Edgeworth was elected a member of the board of commissioners to inquire into Irish education. From 1807 till 1809 much of his time was spent on mechanical experiments and in writing the story of his life. In 1808 appeared *Professional Education*, and in 1813 his *Essay on the Construction of Roads and Carriages*. He died on the 13th of June 1817, and was buried in the family vault in Edgeworthstown churchyard.

Many of Edgeworth's works were suggested by his zeal for the education of his own children. Such were *Poetry Explained for Young People* (1802), *Readings in Poetry* (1816), *A Rational Primer* (unpublished), and the parts of *Early Lessons* contributed by him. His speeches in the Irish parliament have also been published; and numerous essays, mostly on scientific subjects,

¹ For an appreciation of the two Edgeworths from the teacher's point of view, see Prof. L. C. Miall in the *Journal of Education* (August 1, 1894).

have appeared in the *Philosophical Transactions*, the *Transactions of the Royal Irish Academy*, the *Monthly Magazine*, and *Nicholson's Journal*. The story of his early life, told by himself, is fully as entertaining as the continuation by Maria, as it contains less dissertation and more incident. One of his daughters by his first marriage, Anna Maria, married Dr Beddoes and became the mother of T. L. Beddoes, the poet.

See *Memoirs of Richard Lovell Edgeworth, Esq.*, begun by himself and concluded by his daughter, Maria Edgeworth (2 vols., 1820, 3rd and revised ed. 1844). A selection from this, giving an optimistic view of him, *Richard Lovell Edgeworth* (1896), was edited by Mrs Lionel Tollemache.

EDGEWORTH DE FIRMONT, HENRY ESSEX (1745-1807), last confessor to Louis XVI., was the son of Robert Edgeworth, rector of Edgeworthstown in Ireland, his mother being a granddaughter of Archbishop Usher. When he was three years old his father became a Roman Catholic, resigned his living and emigrated to Toulouse, where the boy was brought up by the Jesuits. In 1769, after his father's death, he went to Paris to be trained for the priesthood. On taking orders he assumed the additional surname of de Firmont, from the family estate of Firmont near Edgeworthstown. Though originally studying with a view to becoming a missionary, he decided to remain in Paris, devoting himself especially to the Irish and English Roman Catholics. In 1791 he became confessor to the princess Elizabeth, sister of Louis XVI., and earned the respect even of the *sans-culottes* by his courage and devotion. By Madame Elizabeth he was recommended to the king when his trial was impending; and after Louis' condemnation to death he was able to obtain permission to celebrate mass for him and attend him on the scaffold, where he recommended the king to allow his hands to be tied, with the words: "Sire, in this new outrage I see only the last trait of resemblance between your Majesty and the God who will be your reward." It is said that at the moment of the execution, the confessor uttered the celebrated words: "Son of St Louis, ascend to heaven." But it is certain that the phrase was never spoken. The abbé himself does not quote it, either in his memoirs or in a letter written in 1796 to his brother, in which he describes the death of the king. Moreover, Edgeworth declared to several persons who asked him about it, that the words were not his. In spite of the danger he now ran, Edgeworth refused to leave France so long as he could be of any service to Madame Elizabeth, with whom he still managed to correspond. At length, in 1795, his mother having meanwhile died in prison, where his sister was also confined, he succeeded in escaping to England, carrying with him Elizabeth's last message to her brother, the future King Charles X. whom he found in Edinburgh. He afterwards went with some papers to Monsieur (Louis XVIII.) at Blankenburg in Brunswick, by whom he was induced to accompany him to Mittau, where, on the 22nd of May 1807, he died of a fever contracted while attending some French prisoners.

Edgeworth's *Memoirs*, edited by C. S. Edgeworth, were first published in English (London, 1815), and a French translation (really the letters and some miscellaneous notes, &c.) was published in Paris in 1816. A translation of the *Lettres de l'abbé Edgeworth avec des mémoires sur sa vie* was published by Madame Elizabeth de Bow in Paris in 1818, and *Letters from the Abbé Edgeworth to his Friends, with Memoirs of his Life*, edited by T. B. England, in London in 1816. See J. B. A. Hanet-Ciery, *Journal de ce qui s'est passé, &c.* (Paris, 1825); A. H. du D. de Beauchesne, *Vie de Madame Elizabeth* (Paris, 1869); J. C. D. de Lacroelle, *Précis historique de la Révolution française* (Paris, 1801-1806).

EDGREN-LEFFLER, ANNE CHARLOTTE, duchess of Cajanello (1849-1892), Swedish author, daughter of the mathematician Prof. C. O. Leffler, was born on the 1st of October 1849. Her first volume of stories appeared in 1869, but the first to which she attached her name was *Ur Lifvet* ("From Life," 1882), a series of realistic sketches of the upper circles of Swedish society, followed by three other collections with the same title. Her earliest plays, *Skadespelerskan* ("The Actress," 1873), and its successors, were produced anonymously in Stockholm, but in 1883 her reputation was established by the success of *Samma Kvinnor* ("True Women"), and *En Riddande engel* ("An Angel

of Deliverance"). *Sanna Kvinnor* is directed against false femininity, and was well received in Germany as well as in Sweden. Anne Lefler had married in 1872 G. Edgren, but about 1884 she was separated from her husband, who did not share her advanced views. She spent some time in England, and in 1885 produced her *Hur män gör godt* ("How men do good"), followed in 1888 by *Kampen för lyckan* ("The Struggle for Happiness"), in which she had the help of Sophie Kovalevsky. Another volume of the *Ur Lifvet* series appeared in 1889; and *Familjelucka* ("Domestic Happiness," 1891) was produced in the year after her second marriage, with the Italian mathematician, Pasquale del Pezzo, duca di Cajanello. She died at Naples on the 21st of October 1892. Her dramatic method forms a connecting link between Ibsen and Strindberg, and its masculine directness, freedom from prejudice, and frankness gave her work a high estimation in Sweden. Her last book was a biography (1892) of her friend Sophie (Sonya) Kovalevsky, by way of introduction to Sonya's autobiography. An English translation (1895) by A. de Furnhjelrn and A. M. Clive Bayley contains a biographical note on Fru Edgren-Lefler by Lily Wolfsohn, based on private sources.

See also Ellen Key, *Anne Charlotte Lefler* (Stockholm, 1893).

EDHEM PASHA (c. 1815-1893), Turkish statesman, was of Greek origin, and is said to have been taken into a Turkish household at the time of the Chio massacre in 1822, and to have been brought up as a Mussulman. He entered the Turkish government service and rose to high office, being successively minister of public works, grand vizier for eleven months (1878), ambassador at Vienna (1879) and minister of the interior. He was quick-tempered, but of kindly disposition, intelligent and patriotic, and he left a reputation of unblemished honesty and uprightness.

EDICT (Lat. *edictum*, from *e*, out, and *dicere*, to say, speak), an order or proclamation issued under authority and having the force of law. The word is especially used of the promulgations of the Roman praetor (*q. p.*), of the Roman emperors, and also of the kings of France (see also ROMAN LAW).

EDINBURGH, a city and royal burgh, and county of itself, the capital of Scotland, and county town of Edinburghshire or Midlothian, situated to the south of the Firth of Forth, 396 m. by rail N. of London. The old Royal Observatory on Calton Hill stands in 55° 57' 23" N. and 12° 43' 05" W. Edinburgh occupies a group of hills of moderate height and the valleys between. In the centre is a bold rock, crowned by the castle, between which and the new town lies a ravine that once contained the Nor' Loch, but is now covered with the gardens of Princes Street. To the east rises Calton Hill (355 ft.) with several conspicuous monuments, the city prison and the Calton cemetery. On the south-east, beyond the Canongate limits, stands the hill of Arthur's Seat (822 ft.). Towards the north the site of the city slopes gently to the Firth of Forth and the port of Leith; while to the south, Liberton Hill, Blackford Hill, Braid Hills and Craiglockhart Hills roughly mark the city bounds, as Corstorphine Hill and the Water of Leith do the western limits. The views of the city and environs from the castle or any of the hills are very beautiful, and it is undoubtedly one of the most picturesque capitals in the world. Its situation, general plan and literary associations suggested a comparison that gave Edinburgh the name of "the modern Athens"; but it has a homelier nickname of "Auld Reekie," from the cloud of smoke (reek) which often hangs over the low lying quarters.

Chief Buildings.—Of the castle, the oldest building is St Margaret's chapel, believed to be the chapel where Queen Margaret, wife of Malcolm Canmore, worshipped, and belonging at latest to the reign of her youngest son, David I. (1124-1153). Near it is the parliament and banqueting hall, restored (1889-1892) by the generosity of William Nelson (1817-1887) the publisher, which contains a fine collection of Scottish armour, weapons and regimental colours, while, emblazoned on the windows, are the heraldic bearings of royal and other figures distinguished in national history. Other buildings in the Palace Yard include the apartments occupied by the regent,

Mary of Guise, and her daughter Mary, queen of Scots, and the room in which James VI. was born. Here also are deposited the Scottish regalia ("The Honours of Scotland"), with the sword of state presented to James IV. by Pope Julius II., and the jewels restored to Scotland on the death (1807) of Cardinal York, the last of the Stuarts. The arsenal, a modern building on the west side of the rock, is capable of storing 30,000 stand of arms. In the armoury is a collection of arms of various dates; and on the Argyll battery stands a huge piece of ancient artillery, called Mons Meg, of which repeated mention is made in Scottish history. Argyll Tower, in which Archibald, 9th earl of Argyll, spent his last days (1685), was also restored in 1892 by Mr William Nelson.

Holyrood Palace was originally an abbey of canons regular of the rule of St Augustine, founded by David I. in 1128, and the ruined nave of the abbey church still shows parts of the original structure. Connected with this is a part of the royal palace erected by James IV. and James V., including the apartments occupied by Queen Mary, the scene of the murder of Rizzio in 1566. The abbey suffered repeatedly in invasions. It was sacked and burnt by the English under the earl of Hertford in 1544, and again in 1547. In a map of 1544, preserved among the Cotton MSS. in the British Museum, the present north-west tower of the palace is shown standing apart, and only joined to the abbey by a low cloister. Beyond this is an irregular group of buildings, which were replaced at a later date by additions more in accordance with a royal residence. But the whole of this latter structure was destroyed by fire in 1650 while in occupation by the soldiers of Cromwell; and the more modern parts were begun during the Protectorate, and completed in the reign of Charles II. by Robert Milne, after the designs of Sir William Bruce of Kinross. They include the picture gallery, 150 ft. in length, with 106 mythical portraits of Scottish kings, and a triptych (c. 1484) containing portraits of James III. and his queen, which is believed to have formed the altar-piece of the collegiate church of the Holy Trinity, founded by the widowed queen of James II. in 1462, demolished in 1848, and afterwards rebuilt, stone for stone, in Jeffrey Street. The picture gallery is associated with the festive scenes that occurred during the short residence of Prince Charles in 1745; and in it the election of representative peers for Scotland takes place. Escaping from France at the revolution of 1789, the comte d'Artois, afterwards Charles X. of France, had apartments granted for the use of himself and the emigrant nobles of his suite, who continued to reside in the palace till August 1799. When driven from the French throne by the revolution of 1830, Charles once more found a home in the ancient palace of the Stuarts. George IV. was received there in 1822, and Queen Victoria and the prince consort occupied the palace for brief periods on several occasions, and in 1903 Edward VII., during residence at Dalkeith Palace, held his court within its walls. A fountain, after the original design of that in the quadrangle of Linlithgow Palace, was erected in front of the entrance by the prince consort. The royal vault in the Chapel Royal, which had fallen into a dilapidated condition, has been put in order; Clockmill House and grounds have been added to the area of the parade ground, and the abbey precincts generally and the approaches to the King's Park have been improved. With the abolition of imprisonment for debt in 1881 the privileges of sanctuary came to an end.

Parliament House, begun in 1632 and completed in 1640, in which the later assemblies of the Scottish estates took place until the dissolution of the parliament by the Act of Union of 1707, has since been set apart as the meeting-place of the supreme courts of law. The great hall, with its fine open-timbered oak roof, is adorned with a splendid stained-glass window and several statues of notable men, including one (by Louis François Roubiliac) of Duncan Forbes of Culloden, lord president of the court of session (1685-1747), and now forms the ante-room for lawyers and their clients. The surrounding buildings, including the court-rooms, the Advocates' and the Signet libraries, are all modern additions. The Advocates' library is the finest in Scotland.

Founded in 1682, at the instance of Sir George Mackenzie, king's advocate under Charles II., and then dean of the faculty, it is regarded as the national library, and is one of the five entitled by the Copyright Act to receive a copy of every work published in Great Britain.

The General Register House for Scotland, begun in 1774 from

publisher, has interesting historical and literary associations. The regent Moray, the marquess of Montrose, and Napier of Merchiston were buried within its walls and are commemorated by monuments, and among the memorial tablets is one to R. L. Stevenson by Augustus St Gaudens. The choir (restored in 1873 by public subscription) is a fine example of 15th-century architecture, and the Gothic crown surmounting the central tower forms one of the most characteristic features in every view of the city. Just outside the church in Parliament Square, the supposed grave of John Knox is indicated by a stone set in the pavement bearing his initials, and in the pavement to the west a heart indicates the site of the old Tolbooth,¹ which figures prominently in Scott's *Heart of Midlothian*. Other churches having historical associations are the two Greyfriars churches, which occupy the two halves of one building; Tron church, the scene of 'midnight hilarity at the new year; St Cuthbert's church; St Andrew's church in George Street, whence set out, on a memorable day in 1843, that long procession of ministers and elders to Tanfield Hall which ended in the founding of the Free Church; St George's church in Charlotte Square, a good example of the work of Robert Adam. The United Free Church claims no buildings of much historic interest, but St George's Free was the scene of the ministrations of Dr Robert S. Candlish (1806-1873), Dr Oswald Dykes (b. 1835), Dr Alexander Whyte (b. 1837), a man of great mark and influence in the city, and his successor Hugh Black (b. 1868). Preachers like Robert Candlish, Thomas Guthrie (1803-1873), Marcus Dods (b. 1834), occupied many pulpits, besides those of the particular congregations whom each served. The most imposing structure belonging to the Scottish Episcopal Church is St Mary's cathedral, built on ground and chiefly from funds



designed by Robert Adam, stands at the east end of Princes Street. It contains, in addition to the ancient national records, adequate accommodation, in fireproof chambers, for all Scottish title-deeds, entails, contracts and mortgages, and for general statistics, including those of births, deaths and marriages.

The Royal Institution, in the Doric style, surmounted by a colossal stone statue of Queen Victoria by Sir John Steell, formerly furnished official accommodation for the Board of Trustees for Manufactures and the Board of Fishery, and also for the school of art, and the libraries and public meetings of the Royal Society (founded in 1783), and the Society of Antiquaries of Scotland (founded in 1780). In 1910 it was renamed and appropriated to the uses of the Royal Scottish Academy of Painting, Sculpture and Architecture, which was instituted in 1826, and incorporated by royal charter in 1838, on the model of the Royal Academy in London. It is situated on the Mound close to the National Gallery, of which the prince consort laid the foundation stone in 1850. These collections, especially rich in Raeburn's works, include also Alexander Nasmyth's portrait of Robert Burns, Gainsborough's "The Hon. Mrs. Graham" (see PAINTING, Plate VI. fig. 20), Sir Noel Paton's "Quarrel" and "Reconciliation of Oberon and Titania," several works by William Etty, Robert-Scott Lauder and Sam Bough, Sir Edwin Landseer's "Rent Day in the Wilderness," and the diploma pictures of the academicians, besides many specimens of the modern Scottish school. The National Portrait Gallery and Antiquarian Museum are housed in Queen Street, in a building designed by Sir Rowand Anderson and constructed at the expense of J. R. Findlay of Aberlour (1824-1898), the government providing the site.

Churches.—In conformity with the motto of the city, *Nisi Dominus frustra*, there are numerous handsome places of public worship. St Giles's church, which was effectively restored (1879-1883) by the liberality of Dr William Chambers the

left by the Misses Walker of Coates, and opened for worship in 1879. It is in the Early Pointed style, by Sir Gilbert Scott, is 278 ft. long, and is surmounted by a spire 275 ft. high. The old-fashioned mansion of East Coates, dating from the 17th century, still stands in the close, and is occupied by functionaries of the cathedral. St John's Episcopal church at the west end of Princes Street was the scene of the ministrations of Dean Ramsay, and St Paul's Episcopal church of the Rev. Archibald Alison, father of the historian. The Catholic Apostolic church at the foot of Broughton Street is architecturally noticeable, and one of its features is a set of mural paintings executed by Mrs Traquair. The Central Hall at Tollcross testifies to Methodist energy. John Knox's house at the east end of High Street is kept in excellent repair, and contains several articles of furniture that belonged to the reformer. The Canongate Tolbooth adjoins the parish church, in the burial-ground of which is the tombstone raised by Burns to the memory of Robert Fergusson, and where Dugald Stewart, Adam Smith and other men of note were buried. Almost opposite to it stands Moray House, from the balcony of which the 8th earl of Argyll watched Montrose led to execution (1650). The city gaol, a castellated structure on the black rock of Calton Hill, forms one of the most striking groups of buildings in the town. In the Music Hall in George Street, Carlyle, as lord rector of the university, delivered his stimulating address on books to the students, and Gladstone addressed the electors in his Midlothian campaigns. St Bernard's Well, on the Water of Leith, was embellished and restored (1888) at the cost of Mr William Nelson. A sum of £100,000 was bequeathed by Mr Andrew Usher (1826-1898) for a hall to be called the Usher Hall and to supplement

¹ The original Tolbooth was completed in 1501, but a new one took its place in 1563-1564, and was subsequently altered. At first occupied by the parliament and courts of justice, it served later as a prison, and was removed in 1817.

the municipal buildings. The library of the solicitors to the supreme courts presents to the Cowgate a lofty elevation in red sandstone. The Sheriff Court Buildings stand on George IV. Bridge, and facing them is Mr Andrew Carnegie's free library (1887-1889). At the corner of High Street and George IV. Bridge stand the County buildings. The *Scotsman* newspaper is housed in an ornate structure in North Bridge Street, the building of which necessitated the demolition of many old alleys and wynds, such as Fleshmarket Close and Milne Square. Ramsay Gardens, a students' quarter fostered by Prof. Patrick Geddes (b. 1854), grew out of the "goose-pie" house where Allan Ramsay lived, and with its red-tiled roof and effective lines adds warmth to the view of the Old Town from Princes Street. Not the least interesting structure is the old City Cross (restored at the cost of W. E. Gladstone), which stands in High Street, adjoining St Giles's. Several of the quaint groups of buildings of Auld Reekie have been carefully restored, such as the White Horse Close in the Canongate; the mass of alleys on the north side of the Lawnmarket, from Paterson's Close to James's Court have been connected, and here Lord Rosebery acquired and restored the 17th-century dwelling which figures in the legend of *My Aunt Margaret's Mirror*. Another model restoration of a historic close is found in Riddle's Close, which contains a students' settlement. If these and other improvements have led to the disappearance of such old-world picturesque buildings as Allan Ramsay's shop "at the sign of the Mercury, opposite Niddry Wynd," Cardinal Beaton's palace, the old Cunzie House, or mint, the beautiful timber-fronted "land" that stood at the head of the West Bow, and even such "howffs" as Clerihugh's tavern, where Mr Counsellor Pleydell and the rest played the "high jinks" described in *Guy Manning*, it must be conceded that the changes in the Old Town (many of a drastic nature) have been carried out with due regard to the character of their environment.

Monuments.—Edinburgh is particularly rich in monuments of every description and quality. Of these by far the most remarkable is the Scott monument in East Princes Street Gardens, designed by George Meikle Kemp (1795-1844); it is in the form of a spiral Gothic cross with a central canopy beneath which is a seated statue of Scott with his dog "Maida" at his side, by Sir John Steell, the niches being occupied by characters in Sir Walter's writings. A column, 136 ft. high, surmounted by a colossal figure of Viscount Melville, Pitt's first lord of the Admiralty, rises from the centre of St Andrew Square. At the west end of George Street, in the centre of Charlotte Square, stands the Albert Memorial, an equestrian statue of the prince consort, with groups at each of the four angles of the base. Burns's monument, in the style of a Greek temple, occupies a prominent position on the Regent Road, on the southern brow of the lower terrace of Calton Hill. It was originally intended to form a shrine for Flaxman's marble statue of the poet (now in the National Portrait Gallery), but it proved to be too confined to afford a satisfactory view of the sculptor's work and was at length converted into a museum of Burnsiana (afterwards removed to the municipal buildings). On Calton Hill are a number of finely placed monuments. The stateliest is the national monument to commemorate the victory of Waterloo, originally intended to be a reproduction of the Parthenon. The plan was abandoned for lack of funds, after twelve out of the twenty-four Greek pillars had been erected, but it is perhaps more effective in its unfinished state than if it had been completed. The Nelson monument, an elongated turreted structure, stands on the highest cliff of the hill. Close by is the monument to Dugald Stewart, a copy of the choragic monument of Lysicrates. Sir John Steell's equestrian statue of the duke of Wellington stands in front of the Register House, and in Princes Street Gardens are statues of Livingstone, Christopher North, Allan Ramsay, Adam Black and Sir J. Y. Simpson. In George Street are Chantrey's figures of Pitt and George IV., and a statue of Dr Chalmers; the 5th duke of Buccleuch stands beside St Giles's. Charles II. surveys the spot where Knox was buried; the reformer himself is in the quadrangle of New College: Sir

David Brewster adorns the quadrangle of the university; Dr William Chambers is in Chambers Street, and Frederick, duke of York (1763-1827), and the 4th earl of Hopetoun are also commemorated.

Cemeteries.—Obviously the churchyards surrounding the older and more important parish churches—such as Greyfriars', St Cuthbert's and the Canongate, contain the greatest number of memorials of the illustrious dead. In Greyfriars' churchyard the Solemn League and Covenant was signed, and among its many monuments are the Martyrs' monument, recording the merits of the murdered covenanters, and the tomb of "Bluidy" Mackenzie. To the three named should be added the Calton burying-ground, with its Roman tomb of David Hume, and the obelisk raised in 1844 to the memory of Maurice Margarot, Thomas Muir (1765-1798), Thomas Fyshe Palmer (1747-1802), William Skirving and Joseph Gerrald (1765-1796), the political martyrs transported towards the end of the 18th century for advocating parliamentary reform. The Scottish dead in the American Civil War are commemorated in a monument bearing a life-sized figure of Abraham Lincoln and a freed slave. The cemeteries are all modern. In Warriston cemetery (opened in 1843) in the New Town, were buried Sir James Young Simpson, Alexander Smith the poet, Horatio McCulloch, R.S.A., the landscape painter, the Rev. James Millar, the last Presbyterian chaplain of the castle, and the Rev. James Peddie, the pastor of Bristo Street church. In Dean cemetery, partly laid out on the banks of the Water of Leith, and considered the most beautiful in the city (opened 1845), were interred Lords Cockburn, Jeffrey and Rutherford; "Christopher North," Professor Aytoun, Edward Forbes the naturalist, John Goodsir the anatomist; Sir William Allan, Sam Bough; George Paul Chalmers, the painters; George Combe, the phrenologist; Playfair, the architect; Alexander Russel, editor of the *Scotsman*; Sir Archibald Alison, the historian; Captain John Grant, the last survivor of the old Peninsular Gordon Highlanders; Captain Charles Gray, of the Royal Marines, writer of Scottish songs; Lieutenant John Irving, of the Franklin expedition, whose remains were sent home many years after his death by Lieut. Frederick Schwatka, U.S. navy; and Sir Hector Macdonald, "Fighting Mac" of Omdurman. In the south side are the Grange, Newington or Echobank, and Morningside cemeteries. In the Grange repose the ashes of Chalmers, Guthrie and Lee; Sir Thomas Dick Lauder, Sir Hope Grant, Hugh Miller and the 2nd Lord Dunfermline.

Parks and Open Spaces.—Edinburgh is exceptionally well provided with parks and open spaces. The older are Princes Street Gardens, covering the old Nor' Loch, Calton Hill, the Meadows and the Bruntsfield Links. The municipal golf links are on the Braid Hills. On the southern side Blackford Hill has been set apart for public use. Here stands the Royal Observatory, in which the great Dunect telescope was erected in 1806. Harrison Park is a breathing spot for the congested district of Fountainbridge, and the park at Saughton Hall, opened in 1905, for the western district of the city. To the north of the Water of Leith lie Inverleith Park, the Arboretum and the Royal Botanical Garden. This institution has undergone four changes of site since its foundation in 1670 by Sir Andrew Balfour and Sir Robert Sibbald, and now occupies an area of 34 acres in Inverleith Row. It includes a herbarium and palm house, with an extensive range of hot-houses, a museum of economic botany, a lecture-room and other requisites for the study of botany. The most important open spaces, however, surround Arthur's Seat (822 ft.). This basaltic hill, the name of which is believed to commemorate the British king Arthur, who from its height is said to have watched the defeat of the Picts by his followers, is shaped like a lion couchant, with head towards the north. It is separated from the narrow valley, in which lie the Canongate and Holyrood Palace, by Salisbury Crags, named after Edward III.'s general William Montacute, 1st earl of Salisbury (1301-1344). At their base is the Queen's Drive (3½ m. long), named by Queen Victoria. Adjoining Holyrood Palace is the King's Park, used as a parade ground

Facing the crags on the south-west are the spots familiar to readers of *The Heart of Midlothian*, where stood Jeanie Deans's cottage, and between the crags and Arthur's Seat lies Hunter's Bog, used as a shooting range. Near here too are three small lakes, Duddingston, Dunsappie and St Margaret's, the last overlooked by the ruins of St Anthony's chapel.

Enviros.—In several directions many places once to be described among the environs have practically become suburbs of Edinburgh. Newhaven (population of parish, 7636), so called from the harbour constructed in the reign of James IV., had a shipbuilding yard of some repute in former times. The village has always been a fishing-place of importance, the "fishwives" in their picturesque garb being, till recently, conspicuous figures in the streets of the capital. It used to be a popular resort for fish dinners, and it plays a prominent part in Charles Reade's novel of *Christie Johnstone*. To the west lies Granton (pop. 1728), where the 5th duke of Buccleuch constructed a magnificent harbour. Before the building of the Forth Bridge the customary approach to Fifeshire and the north-east of Scotland was by means of a steam ferry from Granton to Burntisland, which is still used to some extent. There is regular communication with Iceland, the continental ports and London. A marine station here was established by Sir John Murray, but has been discontinued. Still farther west lies the village of Cramond (pop. of parish, 3815), at the mouth of the river Almond, where Roman remains have often been found. It was the birthplace of several well-known persons, among others of John Law (1671-1729), originator of the Mississippi scheme, Lauriston Castle being situated in the parish. Cramond Brig was the scene of one of the "roving" adventures of James V., when the life of the "Gude-man of Ballengeich" was saved by Jock Howieson of the Braehead. Corstorphine (pop. 2725), once noted for its cream and also as a spa, is now to all intents and purposes a western suburb of the capital. The parish church contains the tombs of the Forresters, of old the leading family of the district, with full-length sculptured figures, and at the base of Corstorphine Hill—from one point of which ("Rest and be Thankful") is to be had one of the best views of Edinburgh—are the seats of several well-known families. Among these are Craigcrook Castle (where Lord Jeffrey spent many happy years, and the gardens of which are said to have given Scott a hint for Tullyveolan in *Waverley*), and Ravelston House, the home of the Keiths. To the south of the metropolis are Colinton (pop. 5499), on the Water of Leith, with several mansions that once belonged to famous men, such as Dreghorn Castle and Bonally Tower; and Currie (pop. 2573), which was a Roman station and near which are Curriehill Castle (held by the rebels against Queen Mary), the ruins of Lennox Tower, and Riccarton, the seat of the Gibson-Craigs, one of the best-known Midlothian families. At Dalmahoy Castle, near Ratho (pop. 1946), the seat of the earl of Morton, are preserved the only extant copy of the bible of the Scottish parliament and the original warrant for committing Queen Mary to Lochleven Castle in Kinross-shire. Craigmillar, though situated in the parish of Liberton, is really a part of Edinburgh. Its picturesque castle, at least the oldest portion of it, probably dates from the 12th century. Its principal owners were first the Prestons and latterly the Gilmours. After playing a varied rôle in local and national story, now as banqueting-house and now as prison, it fell gradually into disrepair. It was advertised as to let in 1761, and early in the 19th century, along with the chapel adjoining, was in ruins, but has been restored by Colonel Gordon-Gilmour. It was a favourite residence of Mary Stuart, and its associations with the hapless queen give it a romantic interest. Duddingston (pop. 2023), once a quiet village, has become a centre of the distilling and brewing industries. The parish church, effectively situated on an eminence by the side of the lake, was the scene of the ministrations of the Rev John Thomson (1778-1840), the landscape painter, who numbered Sir Walter Scott among his elders. Duddingston House is a seat of the duke of Abercorn. Liberton (pop. of parish, 7233), a name that recalls the previous existence of a leper's hospital, is prominently situated on the rising ground to the south

of Edinburgh, the parish church being a conspicuous landmark. Adjoining is the village of Gilmerton (pop. 1482), which used to supply Edinburgh with yellow sand, when sanded floors were a feature in the humbler class of houses. Portobello (pop. 9180), being within 3 m. of the capital, must always enjoy a large share of public patronage, though it is not in such favour as a watering-place as it once was. Its beautiful stretch of sands is flanked by a promenade extending all the way to Joppa. The beach was at one time used for the purpose of reviews of the yeomanry. The town dates from the middle of the 18th century, when a cottage was built by a sailor and named Portobello in commemoration of Admiral Vernon's victory in 1739. The place does a considerable trade in the making of bricks, bottles, earthenware, pottery, tiles and paper. Joppa, which adjoins it, has salt works, but is chiefly a residential neighbourhood. Inveresk (pop. 2939), finely situated on the Esk some 6 m. from Edinburgh, is a quaint village with several old-fashioned mansions and beautiful gardens. Alexander Carlyle, the famous divine (1772-1805), whose *Memorials of his Times* still affords fascinating reading, ministered for fifty-five years in the parish church, in the graveyard of which lies David Macbeth Moir (1798-1851), who under the pen-name of "Delta" wrote *Mansie Wauch*, a masterpiece of Scots humour and pathos. Lasswade (pop. of parish, 9708), partly in the Pentlands, famous for its oatmeal, was often the summer resort of Edinburgh worthies. Here Sir Walter Scott lived for six years and De Quincey for nineteen, and William Tennant (1784-1848), author of *Auster Fair*, was the parish dominie. Many interesting mansions were and are in the vicinity, amongst them Melville Castle, the seat of the Dundas Melvilles, and Auchendinny, where Henry Mackenzie, author of *The Man of Feeling*, resided. The two most celebrated resorts, however, amongst the environs of Edinburgh are Roslin (pop. 1805) and Hawthornden. Roslin Castle is romantically situated on the beautifully wooded precipitous banks of the Esk. It dates from the 12th century and is a plain, massive ruin, architecturally insignificant. Partially destroyed by fire in 1447 and afterwards rebuilt, it was sacked in 1650 and again in 1688, and then gradually fell into decay. The chapel, higher up the bank, a relic of great beauty, was founded in 1446 by William St Clair, 3rd earl of Orkney. It is believed to be the chancel of what was intended to be a large church. Although it suffered at the hands of revolutionary fanatics in 1688, the damage was confined mainly to the external ornament, and the chapel, owing to restoration in judicious taste, is now in perfect condition. The Gothic details are wonderful examples of the carver's skill, the wreathed "Prentice's pillar" being the subject of a well-known legend. The walk to Hawthornden, about 1½ m. distant, through the lovely glen by the river-side, leads to the mansion of the Drummonds, perched high on a lofty cliff falling sheer to the stream. The caverns in the sides of the precipice are said to have afforded Wallace and other heroes (or outlaws) refuge in time of trouble, but the old house is most memorable as the home of the poet William Drummond, who here welcomed Ben Jonson, the tree beneath which the two poets sat still stands. Near Swanston, on the slopes of the Pentlands, where R. L. Stevenson when a boy used to make holiday occasionally, is a golf-course which was laid out by the Lothianburn Club. The Pentland range contains many points of interest and beauty, but these are mostly accessible only to the pedestrian, although the hills are crossed by roads, of which the chief are those by Glencorse burn and the Cauld Stane Slap. Habbie's Howe, the scene of Allan Ramsay's pastoral *The Gentle Shepherd*, is some 2 m. from Carlops, and Rullion Green is noted as the field on which the Covenanters were defeated in 1666. At Penicuik (pop. 5007), where the Clerks were long the ruling family, S. R. Crockett was minister until he formally devoted himself to fiction. The town is, industrially, remarkable for its paper mills and mines of coal and other minerals.

Communications.—The two trunk railways serving Edinburgh are the North British and the Caledonian. The North British station is Waverley, to which the trains of the Great Northern, North Eastern and the Midland systems run from England. The

Caledonian station in Princes Street, where the through trains from the London & North-Western system of England arrive. Leith, Granton and Grangemouth serve as the chief passenger seaports for Edinburgh. Tramways connect the different parts of the city with Leith, Newhaven, Portobello and Joppa; and the Suburban railway, starting from Waverley station, returns by way of Restalrig, Portobello, Duddingston, Morningside and Haymarket. In summer, steamers ply between Leith and Aberdeen and other pleasure resorts; and there is also a service to Alloa and Stirling. In the season brakes constantly run to Queensferry (for the Forth Bridge) and to Roslin, and coaches to Dalkeith, Loanhead and some Pentland villages.

Population.—In 1801 the number of inhabitants was 66,544; in 1851 it was 160,302; in 1881 it was 234,402; and in 1901 it was 316,479. In 1900 the birth-rate was 26.90 per thousand, 7.8% of the births being illegitimate; the death-rate was 19.40 per thousand, and the marriage-rate 10 per thousand.

The area of the city has been enlarged by successive extensions of its municipal boundaries, especially towards the west and south. An important accession of territory was gained in 1896, when portions of the parishes of Liberton and Duddingston and the police burgh of Portobello were incorporated. Under the Edinburgh Corporation Act 1900, a further addition of nearly 1800 acres was made. This embraced portions of South Leith parish (landward) and of Duddingston parish, including the village of Restalrig and the ground lying on both sides of the main road from Edinburgh to Portobello; and also part of Cramond parish, in which is contained the village and harbour of Granton. The total area of the city is 10,597½ acres. The increase in wealth may best be measured by the rise in assessed valuation. In 1880 the city rental was £1,727,740, in 1890 it was £2,106,395, and in 1900-1901 £2,807,122.

Government.—By the Redistribution Act of 1885 the city was divided for parliamentary purposes into East, West, Central and South Edinburgh, each returning one member; the parliamentary and municipal boundaries are almost identical. The town council, which has its headquarters in the Municipal Buildings in the Royal Exchange, consists of fifty members, a lord provost, seven bailies, a dean of guild, a treasurer, a convener of trades, seven judges of police, and thirty-two councillors. The corporation has acquired the gas-works, the cable tramways (leased to a company), the electric lighting of the streets, and the water-supply from the Pentlands (reinforced by additional sources in the Moorfoot Hills and Talla Water). Among other duties, the corporation has a share in the management of the university, and maintains the Calton Hill observatory.

May Meetings.—During the establishment of Episcopacy in Scotland, Edinburgh was the seat of a bishop, and the ancient collegiate church of St Giles rose to the dignity of a cathedral. But the annual meeting of the General Assembly of the Church of Scotland at Edinburgh is now the public manifestation of the predominance of Presbyterianism as the national church. In May each year the sovereign appoints a representative as lord high commissioner to the General Assembly of the Established Church, who takes up his abode usually in the palace of Holyrood, and thence proceeds to the High Church, and so to the assembly hall on the Castle Hill. The lord provost and magistrates offer to him the keys of the city, and levees, receptions and state dinners revive in some degree the ancient glories of Holyrood. The General Assembly of the United Free Church is usually held at the same time.

University.—The university of Edinburgh, the youngest of the Scottish universities, was founded in 1583 by a royal charter granted by James IV., and its rights, immunities and privileges have been remodelled, ratified and extended at various periods. In 1621 an act of the Scottish parliament accorded to the university all rights and privileges enjoyed by other universities in the kingdom, and these were renewed under fresh guarantees in the treaty of union between England and Scotland, and in the Act of Security. Important changes were made in the con-

stitution by acts passed in 1758 and 1889. It was one of the first universities to admit women students to its classes and degrees, and its *alumni* are brought into close bonds of sympathy and activity by a students' union. The number of students averages nearly three thousand a year. As a corporation it consists of a chancellor, vice-chancellor, lord rector (elected by the students every three years), principal, professors, registered graduates and matriculated students. The chancellor is elected for life by the general council, of which he is head; and the rights of the city as the original founder have been recognised by giving to the town council the election of four of the seven curators, with whom rest the appointment of the principal, the patronage of seventeen of the chairs, and a share in other appointments. Along with that of St Andrews, the university sends one member to parliament. While the college, as such, bears the name of the College of King James, or King's college, and James VI. is spoken of as its founder, it really originated in the liberality of the citizens of Edinburgh. William Little of Craigmillar, and his brother Clement Little, advocate, along with James Lawson, the colleague and successor of John Knox, may justly be regarded as true founders. In 1580 Clement Little gave all his books, three hundred volumes, for the beginning of a library, and this was augmented by other valuable benefactions, one of the most interesting of which was the library of Drummond of Hawthornden. The library now contains upwards of 220,000 volumes, and more than 7000 MSS. The buildings of the university occupy the site of the ancient collegiate church of St. Mary in the Field (the "Kirk of Field"), the scene of the murder of Darnley. The present structure, the foundation-stone of which was laid in 1789, is a classical building, enclosing an extensive quadrangle. The older parts of it, including the east front, are from the design of Robert Adam, his plans being revised and modified by W. H. Playfair (1789-1857), but it was not till 1883 that the building was completed by the dome, crowned by the bronze figure of Youth bearing the torch of Knowledge, on the façade in South Bridge Street. This edifice affords accommodation for the lecture rooms in the faculties of arts, law and theology, and for the museums and library. The opening up of the wide thoroughfare of Chambers Street, on the site of College Wynd and Brown and Argyll Squares, cleared the precincts of unsightly obstructions and unsavoury neighbours. The Royal Scottish Museum, structurally united to the university, contains collections illustrative of industry, art, science and natural history; and Minto House college and Heriot-Watt college are practically adjuncts of the university. The library hall was restored and decorated, largely through the generosity of Sir William Priestley (1829-1900), formerly M.P. for the university; while munificent additions to the academic funds and resources were made by the 15th earl of Moray (1840-1901), Sir William Fraser (1816-1898), and others. The university benefits also, like the other Scottish universities, from Mr Andrew Carnegie's endowment fund. The medical school stands in Teviot Row, adjoining George Square and the Meadows. To this spacious and well-equipped group of buildings the faculty of medicine was removed from the college. The medical school is in the Italian Renaissance style from the designs of Sir Rowand Anderson. The magnificent hall used for academic and public functions was the gift of William M'Ewan, some time M.P. for the Central division of Edinburgh. Closely associated with the medical school, and separated from it by the Middle Meadow Walk, is the Royal Infirmary, designed by David Bryce, R.S.A. (1803-1876), removed hither from Infirmary Street. Its wards, in which nearly ten thousand patients receive treatment annually, are lodged in a series of turreted pavilions, and cover a large space of ground on the margin of the Meadows, from which, to make room for it, George Watson's College—the most important of the Merchant Company schools—was removed to a site farther west, while the Sick Children's hospital was moved to the southern side of the Meadows.

Scientific Institutions.—The old Observatory is a quaint structure on Calton Hill, overlooking the district at the head of Leith Walk. The City Observatory stands close by, and on Blackford Hill is the newer building of the Royal Observatory.

The Astronomer-Royal for Scotland also holds the chair of practical astronomy.

The museum and lecture-rooms of the Royal College of Surgeons occupy a handsome classical building in Nicolson Street. The college is an ancient corporate body, with a charter of the year 1505, and exercises the powers of instructing in surgery and of giving degrees. Its graduates also give lectures on the various branches of medicine and science requisite for the degree of doctor of medicine, and those extra-academical courses are recognized, under certain restrictions, by the University Court, as qualifying for the degree. The museum contains a valuable collection of anatomical and surgical preparations.

The Royal College of Physicians is another learned body organized, with special privileges, by a charter of incorporation granted by Charles II. in 1681. In their hall in Queen Street are a valuable library and a museum of *materia medica*. But the college as such takes no part in the educational work of the university.

Educational Institutions.—After the Disruption in 1843, and the formation of the Free Church, New College was founded in connexion with it for training students in theology. Since the amalgamation of the United Presbyterian and the Free Churches, under the designation of the United Free Church of Scotland, New College is utilized by both bodies. New College buildings, designed in the Pointed style of the 16th century, and erected on the site of the palace of Mary of Guise, occupy a prominent position at the head of the Mound.

Edinburgh has always possessed exceptional educational facilities. The Royal high school, the burgh school *par excellence*, dates from the 16th century, but the beautiful Grecian buildings on the southern face of Calton Hill, opened in 1829, are its third habitation. It was not until 1825, when the Edinburgh Academy was opened, that it encountered serious rivalry. Fettes College, an imposing structure in a 16th-century semi-Gothic style, designed by David Bryce and called after its founder Sir William Fettes (1750-1836), is organized on the model of the great English public schools. Merchiston Academy, housed in the old castle of Napier, the inventor of logarithms, is another institution conducted on English public school lines. For many generations the charitable foundations for the teaching and training of youth were a conspicuous feature in the economy of the city. Foremost among them was the hospital founded by George Heriot—the “Jingling Geordie” of Scott’s *Fortunes of Nigel*—the goldsmith and banker of James VI. At his death in 1624 Heriot left his estate in trust to the magistrates and ministers of Edinburgh for the maintenance and teaching of poor fatherless sons of freemen. The quadrangular edifice in Lauriston, sometimes ascribed to Inigo Jones, is one of the noblest buildings in the city. Even earlier than Heriot’s hospital was the Merchant Maiden hospital, dating from 1605, which gave to the daughters of merchants similar advantages to those which Heriot’s secured for burghesses’ sons. In 1738 George Watson’s hospital for boys was founded; then followed the Trades’ Maiden hospital for burghesses’ daughters, John Watson’s, Daniel Stewart’s, the Orphans’, Gillespie’s,¹ Donaldson’s² hospitals, and other institutions founded by successful merchants of the city, in which poor children of various classes were lodged, boarded and educated. Nearly all these buildings are characterized by remarkable distinction and beauty of design. This is especially true of Donaldson’s hospital at the Haymarket, which has accommodation for three hundred children. As the New Town expanded, the Heriot Trust—whose revenues were greatly benefited thereby—erected day-schools in different districts, in which thousands of infants and older children received a free education, and, in

¹ James Gillespie (1726-1797) was a tobacco and snuff manufacturer, and when he set up his carriage Henry Erskine suggested as a motto the homely couplet:—

“Wha wad hae thocht it,
That noses wad bocht it?”

² James Donaldson (1751-1830) was a printer who bequeathed nearly the whole of his large fortune for the purposes of a hospital for poor boys and girls, and the trustees have usually selected half of the children admitted from the ranks of the deaf and dumb.

cases of extreme poverty, a money grant towards maintenance. Public opinion as to the “hospital” system of board and education, however, underwent a revolutionary change after the Education Act of 1872 introduced school boards, and the Merchant Company—acting as governors for most of the institutions—determined to board out the children on the foundation with families in the town, and convert the buildings into adequately equipped primary and secondary day-schools. This root-and-branch policy proved enormously successful, and George Watson’s college, Stewart’s college, Queen Street ladies’ college, George Square ladies’ college, Gillespie’s school, and others, rapidly took a high place among the educational institutions of the city. Nor did the Heriot Trust neglect the claims of technical and higher education. The Heriot-Watt college is subsidized by the Trust, and Heriot’s hospital is occupied as a technical school. Concurrently with this activity in higher branches, the school board provided a large number of handsome buildings in healthy surroundings. The Church of Scotland and the United Free Church have training colleges.

Charities.—Besides the Royal Infirmary there are a considerable number of more or less specialized institutions, two of the most important being situated at Craiglockhart. On the Easter Hill stands the Royal Edinburgh asylum for the insane, which formerly occupied a site in Morningside, while the City infectious diseases hospital is situated at Colinton Mains. The Royal blind asylum at Powburn in its earlier days tenanted humbler quarters in Nicolson Street. Chalmers’ hospital in Lauriston was founded in 1836 by George Chalmers for the reception of the sick and injured. The home for incurables is situated in Salisbury Place. The infirmary convalescents are sent to the convalescent house in Corstorphine. Other institutions are the Royal hospital for sick children, the home for crippled children, the Royal maternity hospital, and the deaf and dumb asylum. Though Trinity hospital no longer exists as a hospital with resident pensioners, the trustees disburse annually pensions to certain poor burghesses and their wives and children; and the trust controlling the benevolent branch of the Gillespie hospital endowment is similarly administered.

Industries.—Although Edinburgh is a residential rather than a manufacturing or commercial centre, the industries which it has are important and flourishing. From 1507, when Walter Chapman, the Scottish scour, set up the first press, to the present day, printing has enjoyed a career of almost continuous vitality, and the great houses of R. & R. Clark, T. & A. Constable, the Ballantyne Press, Morrison & Gibb, Turnbull & Spears, and others, admirably maintain the traditional reputation of the Edinburgh press. Publishing, on the other hand, has drifted away, only a few leading houses—such as those of Blackwood, Chambers and Nelson—still making the Scottish capital their headquarters. Mapmakers, typefounders, bookbinders and lithographers all contribute their share to the prosperity of the city. Brewing is an industry of exceptional vigour, Edinburgh ale being proverbially good. The brewers and distillers, such as M’Ewan, Usher and Ure, have been amongst the most generous benefactors of the city. The arts and crafts associated with furniture work, paper-making and coach-building may also be specified, whilst tanneries, glassworks, india-rubber and vulcanite factories, brass-founding, machinery works, the making of biscuits, tea-bread and confectionery are all prominent. In consequence of the large influx of tourists every year the North British and Caledonian railway companies give employment to an enormous staff. Building and the allied trades are chronically brisk, owing to the constant development of the city. Fine white freestone abounds in the immediate vicinity (as at Craigleith, from the vast quarry of which, now passing into disuse, the stone for much of the New Town was obtained) and furnishes excellent building material; while the hard trap rock, with which the stratified sandstones of the Coal formation have been extensively broken up and overlaid, supplies good materials for paving and road-making. On this account quarrying is another industry which is seldom dormant. Owing to the great changes effected during the latter part of the 19th century, some of the

old markets were demolished and the system of centralizing trade was not wholly revived. The Waverley Market for vegetables and fruit presents a busy scene in the early morning, and is used for monster meetings and promenade and popular concerts. Slaughter-houses, cattle markets and grain markets have been erected at Gorgie, thus obviating the driving of flocks and herds through the streets, which was constantly objected to. An infantry regiment is always stationed in the castle, and there are in addition the barracks at Piershill (or "Jock's Lodge"), half-way between Edinburgh and Portobello.

Social Life.—Edinburgh society still retains a certain old-fashioned Scottish exclusiveness. It has been said that the city is "east-windy" and the folk "west-endy." But this criticism needs judicious qualification. The local patriotism and good taste of the citizens have regulated recreation and have also preserved in pristine vigour many peculiarly Scottish customs and pastimes. Classical concerts and concerts of the better sort, chiefly held in the M'Ewan and Music Halls, are well attended, and lectures are patronized to a degree unknown in most towns. In theatrical matters in the old days of stock companies the verdict of an Edinburgh audience was held to make or mar an actor or a play. This is no longer the case, but the Lyceum theatre in Grindlay Street and the Theatre Royal at the head of Leith Walk give good performances. Variety entertainments are also in vogue, and in Nicolson Street and elsewhere there are good music halls. Outdoor recreations have always been pursued with zest. The public golf-course on Braid Hills and the private courses of the Lothianburn club at Swanston and the Barnton club at Barnton are usually full on Saturdays and holidays. The numerous bowling-greens are regularly frequented and are among the best in Scotland—the first Australian team of bowlers that visited the mother country (in 1901) pronouncing the green in Lutton Place the finest on which they had played. Cricket is played by the university students, at the schools, and by private clubs, of which the Grange is the oldest and best. In winter the game of curling is played on Duddington Loch, and Dunsappie, St Margaret's Loch, Lochend and other sheets of water are covered with skaters. Rugby football is in high favour, Edinburgh being commonly the scene of the international matches when the *sense* falls to Scotland. Hockey claims many votaries, there usually being on New Year's day a match atshinty, or *camonachd*, between opposing teams of Highlanders resident in the city. The central public baths in Infirmary Street, with branch establishments in other parts of the town, including Portobello, are largely resorted to, and the proximity of the Firth of Forth induces the keener swimmers to visit Granton every morning. Facilities for boating are limited (excepting on the Forth), but rowing clubs find opportunity for practice and races on the Union Canal, where, however, sailing is scarcely possible. Edinburgh maintains few newspapers, but the *Scotsman*, which may be said to reign alone, has enjoyed a career of almost uninterrupted prosperity, largely in consequence of a succession of able editors, like Charles Maclaren, Alexander Russel, Robert Wallace and Charles Cooper. The *Edinburgh Evening News* and the *Evening Dispatch* are popular sheets. In the past the *Edinburgh Evening Courant*, the chief organ of the Tory party, of which James Hannay was editor for a few years, had a high reputation. The *Witness*, edited by Hugh Miller, the *Daily Review*, edited first by J. B. Manson and afterwards by Henry Kingsley, and the *Scottish Leader*, were conducted more or less as Liberal organs with a distinct bias in favour of the then Free Church, but none of these was long-lived. Volunteering has always attracted the younger men, and the highest awards at Wimbledon and Bisley have been won by the Queen's Edinburgh.

History.—In remote times the seaboard from the Tyne to the Forth was occupied by the Ottadeni, a Welsh tribe of the Brigantes, the territory immediately to the west of it being peopled by the Gadeni. It is probable that the Ottadeni built a fort or camp on the rock on which Edinburgh Castle now stands, which was thus the nucleus around which, in course of

time, grew a considerable village. Under the protection of the hill-fort, a native settlement was established on the ridge running down to the valley at the foot of Salisbury Crags, and another hamlet, according to William Maitland (1693-1757), the earliest historian of Edinburgh, was founded in the area at the north-western base of the rock, a district that afterwards became the parish of St Cuthbert, the oldest in the city. The Romans occupied the country for more than three hundred years, as is evidenced by various remains; but James Grant (1822-1887), in *Old and New Edinburgh*, doubts whether they ever built on the castle rock. When they withdrew, the British tribes asserted their sway, and some authorities go so far as to suggest that Arthur was one of their kings. The southern Picts ultimately subdued the Britons, and the castle became their chief stronghold until they were overthrown in 617 (or 629) by the Saxons under Edwin, king of Northumbria, from whom the name of Edinburgh is derived. Symeon of Durham (854) calls it Edwinesburgh, and includes the church of St Cuthbert within the bishopric of Lindisfarne. Its Gaelic name was Dunedin. This name is probably a translation of the Saxon name. James Grant's view that it may have been the earlier name of the castle, from *dun* ("the fort"), and *edius* ("on the slope"), conflicts with the more generally received opinion that the Britons knew the fortress as *Castell Mynodh Agnedh* ("the hill of the plain"), a designation once wrongly interpreted as the "castle of the maidens" (*castrum puellarum*), in allusion to the supposed fact that the Pictish princesses were lodged within it during their education. In the 16th century the latinized form Edina was invented and has been used chiefly by poets, once notably by Burns, whose "Address" begins "Edina! Scotia's darling seat." Long after Edwin's conquest the lowland continued to be debatable territory held by uncertain tenure, but at length it was to a large extent settled anew by Anglo-Saxon and Norman colonists under Malcolm Canmore and his sons.

In the reign of Malcolm Canmore the castle included the king's palace. There his pious queen, Margaret, the grand-niece of Edward the Confessor, died in 1093. It continued to be a royal residence during the reigns of her three sons, and hence the first rapid growth of the upper town may be referred to the 12th century. The parish church of St Giles is believed to have been erected in the reign of Alexander I., about 1110, and the huge Norman keep of the castle, built by his younger brother, David I., continued to be known as David's Tower till its destruction in the siege of 1572. Soon after his accession to the Scottish throne David I. founded the abbey of Holyrood (1128), which from an early date received the court as its guests. But notwithstanding the attractions of the abbey and the neighbouring chase, the royal palace continued for centuries to be within the fortress, and there both the Celtic and Stuart kings frequently resided. Edinburgh was long an exposed frontier town within a territory only ceded to Malcolm II. about 1020; and even under the earlier Stuart kings it was still regarded as a border stronghold. Hence, though the village of Canongate grew up beside the abbey of David I., and Edinburgh was a place of sufficient importance to be reckoned one of the four principal burghs as a judicatory for all commercial matters, nevertheless, even so late as 1450, when it became for the first time a walled town, it did not extend beyond the upper part of the ridge which slopes eastwards from the castle. So long, however, as its walls formed the boundary, and space therefore was limited, the citizens had to provide house-room by building dwellings of many storeys. These tall tenements on both sides of what is now High Street and Canongate are still a prominent characteristic of the Old Town. The streets were mostly very narrow, the main street from the castle to Holyrood Palace and the Cowgate alone permitting the passage of wheeled carriages. In the narrow "wynds" the nobility and gentry paid their visits in sedan chairs, and proceeded in full dress to the assemblies and balls, which were conducted with aristocratic exclusiveness in an alley on the south side of High Street, called the Assembly Close, and in the assembly rooms in the West Bow. Beyond the walls lay the burghs of Calton, Easter and Wester Portsburgh, the villages of St Cuthbert's.

Moutrie's Hill, Broughton, Canonmills, Silvermills and Deanhaugh—all successively swallowed up in the extension of the modern city. The seaport of Leith, though a distinct burgh, governed by its own magistrates, and electing its own representative to parliament, has also on its southern side become practically united to its great neighbour.

The other three royal burghs associated with Edinburgh were Stirling, Roxburgh and Berwick; and their enactments form the earliest existing collected body of Scots law. The determination of Edinburgh as the national capital, and as the most frequent scene of parliamentary assemblies, dates from the death of James I. in 1436. Of the thirteen parliaments summoned by that sovereign, only one, the last, was held at Edinburgh, but his assassination in the Blackfriars' monastery at Perth led to the abrupt transfer of the court and capital from the Tay to the Forth. The coronation of James II. was celebrated in Holyrood Abbey instead of at Scone, and the widowed queen took up her residence, with the young king, in the castle. Of fourteen parliaments summoned during this reign, only one was held at Perth, five met at Stirling and the rest at Edinburgh; and, notwithstanding the favour shown for Stirling as a royal residence in the following reign, every one of the parliaments of James III. was held at Edinburgh. James II. conferred on the city various privileges relating to the holding of fairs and markets, and the levying of customs; and by a royal charter of 1452 he gave it pre-eminence over the other burghs. Further immunities and privileges were granted by James III.; and by a precept of 1482, known as the Golden Charter, he bestowed on the provost and magistrates the hereditary office of sheriff, with power to hold courts, to levy fines, and to impose duties on all merchandise landed at the port of Leith. Those privileges were renewed and extended by various sovereigns, and especially by a general charter granted by James VI. in 1603.

James III. was a great builder, and, in the prosperous era which followed his son's accession to the throne, the town reached the open valley to the south, with the Cowgate as its chief thoroughfare. But the death of James IV. in 1513, along with other disastrous results of the battle of Flodden, brought this era of prosperity to an abrupt close. The citizens hastened to construct a second line of wall, enclosing the Cowgate and the heights beyond, since occupied by Greyfriars churches and Heriot's hospital, but still excluding the Canongate, as pertaining to the abbey of Holyrood. In the 16th century the movements connected with John Knox and Mary, queen of Scots, made Edinburgh a castle of much activity. With the departure, however, of the sixth James to fill the English throne in 1603, the town lost for a long period its influence and prestige. Matters were not bettered by the Act of Union signed in a cellar in High Street in 1707, amidst the execrations of the people, and it was not till the hopes of the Jacobites were blasted at Culloden (1746) that the townsfolk began to accept the inevitable. This epoch, when grass grew even in High Street, long lingered in the popular memory as the "dark age."

By the accession of George III. (1760), Edinburgh showed signs of revived enterprise. In 1763 the first North Bridge, connecting the Old Town with the sloping ground on which afterwards stood the Register House and the theatre in Shakespeare Square, was opened; a little later the Nor' Loch was partially drained, and the bridging of the Cowgate in 1785 encouraged expansion southwards. Towards the end of the 18th century the New Town began to take shape on the grand, if formal, lines which had been planned by James Craig (d. 1795), the architect, nephew of the poet Thomson, and the erection of Regent Bridge in Waterloo Place (formally opened in 1819 on the occasion of the visit of Prince Leopold, afterwards king of the Belgians) gave access to Calton Hill. The creation of Princes Street, one of the most beautiful thoroughfares in the world, led to further improvement. The earth and debris from the excavation of the sites for the houses in this and adjoining streets had been "dumped" in the centre of the drained Nor' Loch. This unsightly mass of rubbish lay for a while as an eyesore, until the happy thought arose of converting it into a broad

way joining the new road at Hanover Street with the Old Town at the Lawnmarket. Upon this street, which divides Princes Street and its gardens into east and west, and which received the title of the Mound, were erected the National Gallery and the Royal Institution. Speaking generally, the New Town was resorted to by professional men—lawyers, doctors and artists,—and in its principal streets will be found the head offices of the leading banks and insurance offices, all lodged in buildings of remarkable architectural pretensions. The Commercial, the Union and the Clydesdale banks are in George Street, the National Bank of Scotland, the Royal Bank of Scotland, and the British Linen Company's Bank are in St Andrew Square, the Bank of Scotland is at the head of the Mound. The extensive building operations engaged in by the town council in the early part of the 19th century resulted in the insolvency of the city in 1833. The property of the corporation was valued at £271,658 against a debt of £425,195, which was compounded for by the issue of 3% annuity bonds—the loss to the creditors amounting to 25% of their claims.

Meanwhile the progress of letters, science and learning manifested the recovery of the city. The names of Knox (d. 1572), Buchanan (1582), Alexander Montgomery (1605), Drummond of Hawthornden (1649), Allan Ramsay (1757), Smollett (1771), Ferguson (1774), and Burns (1796), carried on the literary associations of the Scottish capital nearly to the close of the 18th century, when various causes combined to give them new significance and value. The university was served by a body of teachers and investigators who won for it a prominent position among European schools. Then succeeded the era of Scott's *Marmion* and *The Lady of the Lake*, followed by the Waverley novels and the foundation of *Blackwood's Magazine* and the *Edinburgh Review*.

Modern conditions have changed the character of Edinburgh society. In Scott's early days a journey to London was beset with difficulties and even dangers; but railways have now brought it within a few hours' distance, and Scottish artists and literary men are tempted to seek a wider field. Nevertheless, the influence of the past survives in many ways. Edinburgh is not markedly a manufacturing city, but preserves its character as the Scottish capital.

AUTHORITIES.—James Grant, *Old and New Edinburgh* (London, 1880 et seq.); W. Maitland, *History of Edinburgh* (1753); Hugo Arnot, *History of Edinburgh* (1789); B. Chambers, *Trajectories of Edinburgh* (1824); D. Wilson, *Memorials of Edinburgh in the Older Time* (1846-1848); O. Smeaton, *Edinburgh and its Story* (1904). *The Municipal Buildings of Edinburgh*, by Robert Miller, Lord Dea of Guild, printed by order of the town council (Edinburgh, 1895). *Royal Edinburgh*, by Mrs Oliphant, illustrations by Sir George Reid, R.S.A. (London, 1890).

EDINBURGHSHIRE, or MIDLOTHIAN, a county of Scotland, bounded N. by the Firth of Forth, E. by the shires of Haddington, or East Lothian, and Berwick, S.E. by Roxburghshire, S. by Selkirkshire, Peeblesshire and Lanarkshire, S.W. by Lanarkshire, and W. by Linlithgowshire or West Lothian. Its area is 234,330 acres or 3662 sq. m. The island of Cramond belongs to the county. There are no mountains, but the Pentland Hills advance boldly from the south-west to within 5 m. of the sea. The loftiest summits are Scald Law (1898 ft.), Carmethy (1881), West and East Cairn Hill (1844 and 1839), and West Kip (1800). They are generally of rounded form, and covered with heath or grass. The Moorfoot Hills, in the south-east, are a continuation of the Lammermuirs, and attain in Blackhope Scar a height of 2136 ft. Of more or less isolated eminences there are the Braid Hills (698 ft.), Blackford Hill (500), Arthur's Seat (822), Corstorphine Hill (500)—all practically within Edinburgh—and Dalmahoy Craig (800), 7 m. south-west of the city. Of the rivers the Gala rises on the south-east of the Moorfoot Hills and flows south to join the Tweed, and the Tyne after a course of 7 m. passes into Haddingtonshire. All the others flow into the Firth of Forth. Of these the Esk, which is the longest, drains the district between the Pentlands and the Moorfoot Hills, and empties into the sea at Musselburgh. The southern branch has its source near Blackhope Scar, receives on its right Gore Water

and, on its left, Dalhousie Burn, and flows past Newbottle Abbey; the northern rises in the Pentlands, and proceeds through much picturesque scenery past Penicuik, Roslin, Hawthornden and Lasswade; the two streams uniting within the grounds of Dalkeith Palace. Braid Burn from Capelaw Hill passes between the Braid Hills and Blackford Hill, and reaches the sea at Portobello. The Water of Leith, with its head streams on the western slope of the Pentlands, flows past Balerno, Currie, Juniper Green, Colinton, Edinburgh and Leith. The Almond, rising in Lanarkshire, and its right-hand tributary, Breich Water, form the boundary between Midlothian and Linlithgowshire. Several of these streams, especially the Esk and the Water of Leith, furnish much water power. The only loch is that at Duddingston, but there are several large reservoirs connected with the water supply of Edinburgh. Cobbinshaw reservoir, situated at the head of Bog Burn, a tributary of the Almond, is used for the supply of the Union Canal connecting the Forth with the Clyde.

Geology.—The southern portion of the county, embracing the Moorfoot Hills and a large part of the catchment basin of the Gala Water, lies within the Silurian tableland of the south of Scotland. From Bowland northwards to Crookston in the Gala valley the Silurian strata are mainly of Tarannog age and consist of greywackes, grits, flags and shales, with thin dark seams which yield graptolites sparingly. To the north of this area, older sediments, comprising Arenig cherts, black shales, greywackes, and grits of Llandello and Caradoc age, rise from underneath the Tarannog strata and spread over the hills north to the margin of the tableland. In some of the folds of Arenig cherts diabase lavas appear, which occupy small lenticular areas. All the Silurian strata are repeated by folds striking north-east and south-west and frequently dipping in one direction, to the north-west as in the Gala valley. North of the Silurian tableland and within the area occupied by the younger palaeozoic rocks of the Pentland Hills, there are various outliers of Upper Silurian strata. These isolated patches occur (1) in the North Esk section, (2) at Loganlee reservoir, (3) near Bavelaw Castle, and (4) in Bavelaw Burn. The section in the North Esk is by far the most complete, as the strata embrace Wenlock, Ludlow and Downonian rocks with a north-east strike similar to that of the beds in the Silurian tableland. The Wenlock rocks have yielded a rich suite of organic remains. In the Pentland Hills the folded and denuded Silurian strata are covered unconformably by Lower Old Red Sandstone rocks, comprising conglomerates and red sandstones, which are succeeded by a great volcanic series, the latter extending from the West Kip Hill to the Braid Hills. The pebbles of the basal conglomerates are derived chiefly from the underlying platform of greywackes and shales and from the Radiolarian cherts and volcanic rocks in the tableland to the south. The contemporaneous igneous rocks include olivine basalts, andesites, trachytes, rhyolites and tufts, which are pierced by the microgranite of the Black Hill and by several vents filled with agglomerate, as near Swanston.

The Upper Old Red Sandstone rests unconformably on all older formations. The red sandstones and concretionary divisions form the Cairn Hills, and are traceable north-eastwards along the north-west slope of the Pentland Hills towards the Clabbeidan reservoir, where they are overlapped by Carboniferous strata. They occupy the south part of the city of Edinburgh, they occur in the lower slope of Salisbury Crags, and south by Craigmillar and Liberton towards Mortonhall. Recently the horizon of these beds has been proved by the discovery of fish remains (*Holoptychius*), a zonal form of the Upper Old Red Sandstone. The remainder of the county embracing the fertile low ground west of the city of Edinburgh and along the basin of the Esk is occupied by Carboniferous strata and various igneous rocks associated with that formation. The Pentland Hills, formed of older Palaeozoic deposits, appear as a prominent ridge, throwing off the Carboniferous beds to the north-west and south-east. In the former direction only the Calciferous Sandstone series is represented, and in the latter all the Carboniferous divisions are well developed. The lowest subdivision of the Calciferous Sandstone series, consisting of sandstones, red and green shales, marls and cement-stones, appears in the ridge of the old part of the city between the Castle and Holyrood, in the Hunter's Bog and on the north-west side of the Pentland Hills. Intercalated in this series near the top, there are interbedded volcanic rocks, comprising olivine basalts, mugearites, tufts and agglomerates, which form conspicuous features on Arthur's Seat, on Calton Hill, at Craiglockhart and Corston Hill south of Mid Calder. Next in order come the Granton sandstones and Wardie shales, which are best seen on the shore at Granton, and extend up the Water of Leith in the direction of Colinton, where they are succeeded by the Hailes sandstone. The upper portion of the Calciferous Sandstone series, overlying the Hailes sandstone, embraces the valuable oil-shales, which give rise to one of the chief industries of the Lothians. Recently, however, it has been proved that some of the bands in the Wardie shales give a low yield of oil and sulphate of ammonia. The oil-shale-fields in the county lie partly along its west margin from Mid Calder south to Breich and

also on the south-east side of the Pentland Hills between Straiton and Carlup along the west side of the Midlothian basin. From an economic point of view the Midlothian coalfield is of special importance, the strata being arranged in a syncline, the long axis of which trends north-north-east and south-south-west. In the centre of the basin lie the Coal-Measures covered by the barren red sandstone of Dalkeith, probably on the same horizon as the red sandstones of Wemyss in Fife (Middle Coal-Measures). The underlying Millstone Grit and Carboniferous Limestone series with its middle-coal-bearing group rise from underneath the Coal-Measures, forming parallel bands curving round the basin. Along the west side of the syncline, the strata dip at high angles to the south-east, are sometimes vertical and even in some cases inverted, while in the centre they become flat and rise at gentle angles towards the east. The Coal Measures and the coal-bearing group of the Carboniferous Limestone series contain numerous valuable coals and ironstones, and there still remains a large field for development. The intrusive igneous rocks forming prominent features in the county are divisible into two main groups, which are separated from each other by a considerable interval of time. The coarse agglomerate filling the old volcano on the top of Arthur's Seat is associated with the eruption of the volcanic rocks of Calciferous Sandstone age near Edinburgh. The fine grained basalt appearing as a plug on the Castle Rock closely resembles the basalt on the top of Arthur's Seat, and is likewise of the same age. The intrusive sheets of Salisbury Crags and Corstorphine Hill composed of olivine-dolerite belong to the same general period. But the quartz-dolerites represented by the Ratho hill are in all probability of late Carboniferous age.

Climate and Agriculture.—In the hill country the average rainfall is 37.4 in., but on the coast only 28.4 in. The average temperature ranges from 38° F. in January to 50.5° in July, the mean for the year being 47.7. The north-east and easterly winds prevailing in spring are, especially in Edinburgh and its vicinity, remarkable for their cold and blighting character. Excepting in the uplands, snow seldom lies long, but frosts sometimes occur at night as late as the beginning of June, and severe enough to destroy the young shoots of seedling trees in nurseries. But the winter is not astonishingly mild. The common snowdrop (*Galanthus nivalis*) blossoms as early as the 25th of January, the kidney liverleaf (*Hepatica triloba*) by the 31st of January and the rhododendron (*R. nobleanum*) by the 25th of February. On the shores of the Forth along the Almond and the Esk, and on some of the richer flats, grain crops ripen early; 2 m. nearer the hills and 200 ft. higher the harvest is ten days later; and at 600 ft. still another week later. High farming is the rule in the three Lothians. All the area on which wheat can be profitably grown is so occupied; oats, however, is the predominant grain crop, though barley is also raised. Turnips and potatoes are the chief roots, and beans are grown to a limited extent. A large area is occupied by pasture and sown grasses, fallow land having practically disappeared. Near Edinburgh sewage farming has been largely developed. There are 200 acres at Craightenny between Restalrig and the Forth, besides smaller tracts under similar treatment at Lochend, Dairy and the Grange. The produce consists principally of natural grasses. Sheep and cattle raising is an important pursuit. In the neighbourhood of the capital dairy farming is conducted on an extensive scale. Horse breeding flourishes, several of the studs being of excellent character, Clydesdales predominating. Pig-keeping has grown considerably and poultry-farming is carried on near Edinburgh. The nursery gardens are extensive, and, besides market gardening, which prospers near the capital, there are many orchards.

Other Industries.—Though as a whole not a mining county, Midlothian possesses some mineral wealth. Coal is extensively mined at various points on the North Esk, like Penicuik, Loanhead, Bonnyrigg, Eskbank and at Gorebridge, Newbattle, Newbigging, Niddrie, Gilmerton, Mid and West Calder. Ironstone is obtained chiefly at Lasswade and Penicuik and fire-clay occurs at various points. In the vicinity of West Calder there is a large amount of valuable oil-bearing shale. Limestone is of frequent occurrence—at Esperston, Cousland, Crichton near Dalkeith, Burdiehouse, Gilmerton near Edinburgh, the Camps in Kirknewton parish, and at Muirieston and Leven Seat in the south-west. Freestone is quarried at Craigeith, Hailes, Redhall and Craigmillar. It is used for pavements and stairs, and for the great docks at Leith. Barnton Mount supplies large blocks

of whinstone, also used for docks and for fortifications; the causeway stones for the streets of Edinburgh are mainly procured from the quarries at Ratho; and a number of smaller quarries for the supply of road-material are scattered throughout the county. Owing no doubt to the growth of printing and publishing in the metropolis, the chief manufacturing industry in Midlothian is paper-making. Most of the mills are extensive and equipped with the most modern processes and have an enormous yearly output. The most important mills, some of them dating from the beginning of the 18th century, are situated on the North Esk between Penicuik and Musselburgh, and on the South Esk at Newbattle. At Balerno, Currie, Colinton and elsewhere on the Water of Leith there are several mills, as well as near Mid Calder and at Portobello. The ancient vat-mill called Peggy's Mill, at Cramond, produces handmade papers. There are carpet factories on the Esk at Roslin and at Lasswade. The manufacture of gunpowder is also carried on at Roslin, the works being distributed in recesses on the Esk. Iron foundries exist at Dalkeith, Westfield, Loanhead, Penicuik, Millerhill and in the suburbs of Edinburgh; brick and tile works at Portobello, Millerhill, Newbattle, Bonnyrigg and Rosewell; and candle works at Dalkeith and Loanhead. Leather also is tanned at Edinburgh and Dalkeith. The shipping trade is concentrated at Leith and Granton, and Newhaven is still an important fishery centre, while there are also fleets at Fishrow and Granton.

Population and Government.—The population in 1891 was 434,276, and in 1901 488,796, of whom 5765 spoke both Gaelic and English, and 75 Gaelic only. The chief towns, besides Edinburgh, the capital (pop. in 1901, 316,837), are Bonnyrigg (1924), Dalkeith (6812), Leith (77,439), Loanhead (3071), Musselburgh (11,711), Newton Grange (2406), Penicuik (3574), and West Calder (2652). The county forms a single parliamentary constituency, exclusive of Edinburgh city and Leith burghs. It has been divided by the county council into four county districts (Calder, Gala Water, Lasswade, Suburban) for the purposes of the Roads and Bridges Act 1878, and the Public Health Acts. The management of special districts formed for water supply, drainage and other sanitary purposes is entrusted to sub-committees appointed by the respective district committees. The grant under the Local Taxation (Customs and Excise) Act is administered by the Technical Education Committee appointed by the Council; and, subject to the same authority, the Secondary Education Committee provides for the distribution of the grant under the Local Taxation (Scotland) Act. In respect of education the shire is under school-board jurisdiction.

History and Antiquities.—Cramond was once a Roman seaport, and various objects of Roman art and workmanship have been discovered in its vicinity and along the banks of the Almond. On several heights are remains of early military works—the most important being that on Dalmahoy Hill, Braidwood Castle in the parish of Penicuik, and Castle Greg on the Harburn estate in Mid Calder parish. Picts' houses are found at Crichton Mains, at Borthwick Castle, near Middleton House and elsewhere, the first being especially interesting from the fact that some of the stones bear marks of Roman masonry. There are hut-circles and a fort on Kaimies Hill, near Ratho; a large tumulus, with three upright stones, at Old Liston; a smaller tumulus at Newbattle; a cistvaen or stone burial chest at Carlowrie; and standing stones at Lochend, at Comiston (the Cairn), and the "Cat Stane" near Kirkliston. Temple, on the South Esk, was at one time the chief seat of the Knights Templars in Scotland for whom David I. here built a church, now in ruins.

The history of the county is almost identical with that of the capital. Traces of Celtic occupation are obvious in such names as Inveresk, Almond, Leith, Dalry, Dalmahoy, Dalkeith and others; though most of the villages, hamlets and castles received their present designation from Saxon possessors. The termination *ton* is very frequent. Following upon the withdrawal of the Romans the land was the scene of intertribal strife, but it was in a measure subdued by the Saxons and passed under the rule of the Northumbrian kings, who held it till 1020, when the

Lothians were handed over to the Scottish king, Malcolm II. The people of the Lothians, however, stipulated that they were to retain their manners and customs, and in this way the south-eastern lowlands became the centre from which Anglo-Saxon and Norman civilization gradually spread throughout Scotland, and hence, too, was assured the pre-eminence of Edinburgh. Within the county lie the battlefields of Roslin, where (in 1303) the English suffered three reverses in one day; Burghmuir, where the English were defeated by the earl of Moray in 1334; Pinkie near Inveresk, where (in 1547) the duke of Somerset inflicted heavy loss upon the Scots; and Rullion Green, on the eastern slopes of the Pentlands, where (in 1666) the Covenanters were routed by the royal troops under General Dalziel.

See James Grant, *Old and New Edinburgh* (London, 1880 et seq.); Miss Warrander, *Walks near Edinburgh* (Edinburgh, 1890); J. C. Oliphant, *Rambles round Edinburgh* (Edinburgh, 1892); J. M. Bell, *Castles of the Lothians* (Edinburgh, 1893); W. Baird, *Annals of Duddingston and Portobello* (Edinburgh, 1898); J. Geddie, *The Water of Leith* (Edinburgh, 1896); Rev. J. Dickson, *Ruined Castles of Midlothian* (Edinburgh, 1895); *The Islands of the Forth* (Edinburgh 1899).

EDISON, THOMAS ALVA (1847—), American inventor, was born on the 11th of February 1847, at Milan, Erie county, Ohio, of mixed Dutch and Scottish descent; but his parents moved to Port Huron, Michigan, when he was seven years old. At the age of twelve he became a train news-boy on the railway to Detroit, and managed to gratify his youthful interest in chemistry by performing experiments while travelling. At fifteen he became a telegraph operator, and was employed in many cities in the United States and Canada, but frequently neglected his duties in order to carry on studies and experiments in electrical science. Before he was twenty-one he had constructed an automatic repeater, by means of which a message could be transferred from one wire to another without the aid of an operator; and he had also directed his attention to the problem of duplex telegraphy of which he later invented a successful system. In 1869 Edison came to New York city, and soon afterwards became connected with the Gold & Stock Company. He invented an improved printing telegraph for stock quotations, for which he received \$40,000. He then established a laboratory and factory in Newark, N.J., for further experiments and for the manufacture of his inventions. In 1876 he removed to Menlo Park, and later to West Orange, N.J., where he continued his experiments. Since then his name has been prominently associated with all kinds of novelties in practical electricity. Among his principal inventions are his system of duplex telegraphy, which he later developed into quadruplex and sextuplex transmission; his carbon telephone transmitter; the microtasmeter, for the detection of small variations in temperature; the phonograph, which records and reproduces all manner of sounds; the cinematograph, which his improvements made practicable; and his method of preparing carbon filaments for the incandescent electric lamp. In 1878 Edison was made a chevalier of the Legion of Honour by the French government.

EDMONTON, the capital city of the province of Alberta, Canada, which was constituted in 1905. Pop. (1901) 2652; (1906) 11,167. It is picturesquely situated on the north bank of the North Saskatchewan river in 113° 37' W. and 53° 32' N. It is on a high tableland which rises 200 ft. above the river, and overlooks the thickly wooded valley of the North Saskatchewan river—at this point a mile in width, the river itself being one-eighth of a mile wide. Directly opposite Edmonton on the south bank of the river stands Strathcona, a town with a population of 2927. The streets of Edmonton are wide and laid out in rectangular form. Its excellent drainage makes street grading an easy matter. In 1896 it was scarcely a village; in 1901 it assumed some importance, but three-quarters of the city were built between 1901 and 1906. Its choice as capital in 1905 gave it a great impetus. The buildings, largely of brick, give a substantial appearance to the place. The public school buildings, high school and Alberta College are attractive. The church buildings, many in number, include several architecturally beautiful. Three well planned and commodious hospital

buildings represent the benevolent work of the community. The banks and the wholesale warehouses are well built, and many beautiful private residences are worthy of note. Its growth may be realized from the fact that during a part of 1906, \$806,015 worth of building permits were granted; the customs receipts, \$57,994 in 1905, grew to \$104,416 in 1906; the mail parcels handled increased from 6800 to 12,079; and the express parcels handled from 1277 to 2347. Edmonton is the depot of the fur traders for the great region on the north and west. The Hudson's Bay Company has great interest in Edmonton, but is vigorously opposed by a strong French firm, Revillon Frères of Paris. These two companies have their posts wide spread over the north country. The city, being incorporated, is governed by a mayor and a board of aldermen. It operates its own water service, electric light plant, and telephone system. Its schools are managed by an elected public school board.

Edmonton was begun as a post of the North West Company about the year 1778. Early in the 19th century the Hudson's Bay Company also established a fort at this point. On the union of the two companies under the name of the latter, Fort Edmonton sprang into new importance. It became a north-western centre, and in its neighbourhood many employees of the fur company, both Scottish and French, took up land as settlers. As freighters for the Hudson's Bay Company many of these settlers made, with their ox or pony carts, the long journey over the natural prairie roads to Fort Garry, fording or swimming the streams, carrying furs for a thousand miles or more on the eastern trip, and returning brought loads of merchandise for the company. Its inaccessibility made the Edmonton settlement grow very slowly, so that its great increase in population belongs to the period subsequent to 1896.

EDMONTON, an urban district in the Enfield parliamentary division of Middlesex, England, suburban to London, 7½ m. N. of London Bridge, on the Old North Road, on the west side of the Lea Valley. Pop. (1891) 25,381; (1901) 46,899. There are numerous factories in the valley, and Edmonton consists largely of the cottages of artisans. The church of All Saints has been extensively restored, but retains part of the ancient fabric of Perpendicular and earlier date. It contains brasses of interest, and in the churchyard is the memorial of Charles Lamb, who lived and died (1834) at Edmonton, and his sister. Cowper and Keats were also residents, and the Bell Inn is famed through Cowper's poem *John Gilpin*.

EDMUND, SAINT [EDMUND RICE] (d. 1240), English saint and archbishop of Canterbury, was born at Abingdon, near Oxford, about 1175. His father was a merchant of that town who retired, with his wife's consent, to the monastery of Eynsham, leaving in her hands the education of their family. Her name was Mabel; she was a devout woman who lived an ascetic life and encouraged her children to do the same. Both her daughters took the veil; three of her sons served the church in different capacities. Edmund, her first-born, began his education in a grammar school at Oxford. Of weak health and a contemplative disposition, he showed, from his earliest years, a remarkable taste for learning and religious exercises. He saw visions while still at school, and at the age of twelve took a vow of perpetual chastity in the Virgin's church at Oxford. Later he was sent, with his brother Robert, to study the liberal arts at Paris. His mother's death and family affairs recalled him for a time to England; but he afterwards graduated at Paris. For six years he lectured in the liberal arts, partly in Paris and partly in Oxford; his career as an Oxford teacher commenced before 1205, and is noteworthy for the fact that he was the first who lectured there on Aristotle. He then returned to Paris for a course of theological studies, and rapidly made himself proficient in that branch of learning.

After spending a year in retirement with the Augustinian canons of Merton (Surrey) he became a theological lecturer in Oxford. In this capacity he gained some reputation, and it is related that his audience were often moved to tears by his eloquence. He spent the fees which he received in charity, and refused to spend upon himself the revenues which he derived from several

benefices. He not infrequently retired for solitude to Reading Abbey; it is probable that he would have become a monk if that profession had afforded more scope for his gifts as a preacher and expositor. As his fame increased he became alarmed by the temptations which it threw in his way. He ceased to lecture in Oxford, and about 1222 accepted, at the invitation of Bishop Richard Poore, the treasurer's office of Salisbury cathedral. Little is known of his life for the next ten years. But he attracted the notice of the Roman court, and was appointed in 1227 to preach the Crusade in England; he formed a friendship with Ella, countess of Salisbury, and her husband, William Longsword, and he won general admiration by his works of charity and the austerity of his life.

In 1233 he was elected archbishop of Canterbury at the express suggestion of Gregory IX., after the monks of Canterbury had in vain suggested three other candidates for the pope's approval. Edmund at once leaped into prominence by the outspoken manner in which he rebuked the king for following the advice of foreign favourites. In common with the baronial opposition he treated Henry III. as responsible for the tragic fate of Richard Marshal, earl of Pembroke, and threatened the king with excommunication. The king bowed before the storm, dismissed the foreign counsellors, made peace with Marshal's adherents, and was publicly reconciled with the barons. But the new ministers were as unpopular as the old; nor was the archbishop allowed that political influence which he claimed in virtue of his office. It was with the object of emancipating himself from Edmund's control that the king asked the pope to send him a legate (1236). On the arrival of Cardinal Otho (1237) the archbishop found himself thwarted and insulted at every point. The marriage between Simon de Montfort and the Princess Eleanor, which Edmund had pronounced invalid, was ratified at Rome upon appeal. The king and legate upheld the monks of Canterbury in their opposition to the archbishop's authority. On all public occasions the legate took precedence of the archbishop. By the advice of his suffragans Edmund laid a protest before the king, and excommunicated in general terms all who had infringed the liberties of Canterbury. These measures led to no result; nor could the pope be moved to reverse the legate's decisions. Edmund complained that the discipline of the national church was ruined by this conflict of powers; and began to meditate retiring. He was confirmed in this intention by the papal encroachments of the year 1240, when the English clergy were required to pay a subsidy of a fifth for the war against Frederick II., and simultaneously three hundred Romans were "provided" with English benefices in return for their political services to the Holy See. Edmund withdrew to Pontigny in the summer of 1240. A little later the state of his health compelled him to seek the cooler air of Soisy (near Provins). Here he died on the 16th of November 1240.

His canonization was at once demanded by his admirers, and only delayed (till 1247) through the opposition of Henry III. The honour was well deserved. He is one of the most saintly and attractive figures in the history of the English church. It was his misfortune to be placed at the head of the national hierarchy in a crisis for which he had not been prepared by practical training or experience. As archbishop he showed no great capacity or force of character; but the purity of his motives and the loftiness of his ideals commanded universal respect.

See the Life printed by Martène and Durand in the *Thesaurus novus anecdotorum* (1717). Other lives of importance exist in manuscript at the British Museum, in the Cambridge University library and in that of St John's College, Cambridge. The last-named is printed by W. Wallace in the appendix to his *Life of St Edmund* (1893). An account of the manuscript lives and many extracts (translated) will be found in the Rev. B. Ward's *St Edmund* (1903). See also *St Edmund of Abingdon* (1898), by the Baroness Paravicini; and the *English Historical Review*, xxii. pp. 84 ff. (H. W. C. D.)

EDMUND, king of East Anglia (c. 840-870), succeeded to the East Anglian throne in 855 while he was yet but a boy. According to Abbo, followed by Florence of Worcester, he was "ex antiquorum Saxonum prosapia," which would seem to mean that he was of foreign origin and that he belonged to the Old

Saxons of the continent. This very doubtful tradition was expanded later into a fuller legend which spoke of his Old Saxon parentage, his birth at Nuremberg, his nomination as successor to Offa, king of East Anglia, and his landing at Hunstanton to claim his kingdom. His coronation took place in the next year at "Burna" (*i.e.* probably Bures St Mary, Suffolk), which was then the royal capital.

Of the life of St Edmund during the next fourteen years we know nothing. In the year 870 the Danes, who had been wintering at York, marched through Mercia into East Anglia and took up their quarters at Thetford. Edward engaged them fiercely in battle, but the Danes under their leaders Ubba and Inguar were victorious and remained in possession of the field of battle. The king himself was slain, whether on the actual field of battle or in later martyrdom is not certain, but the widely current version of the story which makes him fall a martyr to the Danish arrows when he had refused to renounce his faith or hold his kingdom as a vassal from the heathen overlords, may very probably be true. The story is a very old one, and according to Abbo of Fleury (945-1004), St Edmund's earliest biographer, it was told him by Dunstan, who heard it from the lips of Edmund's own standard-bearer. This is chronologically just possible, but that is all. The battle was fought at Hoxne, some 20 m. south-east of Thetford, and the king's body was ultimately interred at Beadricesworth, the modern Bury St Edmunds. The shrine of Edmund soon became one of the most famous in England and the reputation of the saint was European. The date of his canonization is unknown, but churches dedicated to his memory are found all over England.

See *Asser's Life of Alfred*, ed. W. H. Stevenson; *Annals of St Neots*; *Saxon Chronicle: Memorials of St Edmund's Abbey* (Rolls Series), including the *Passio Sancti Edmundi* of Abbo of Fleury; and the *Corolla Sancti Edmundi*, edited by Lord Francis Hervey (1907). (A. M. W.)

EDMUND I., king of the English (d. 946), was the son of Eadgifu, third wife of Edward the Elder, and half-brother to his predecessor Æthelstan. He succeeded to the throne in 940, but had already played an active part in the previous reign, especially when he fought by the side of his half-brother in the great battle of Brunanburh.

In the first year of his reign Edmund had trouble with Olaf or Anlaf Sihtricsson, called Cuaran. The latter had just crossed from Ireland and had been chosen king by the Northumbrians, who threw off their allegiance to Edmund. Anlaf took York, besieged Northampton and destroyed Tamworth, but was met by Edmund at Leicester. The enemy escaped, but a peaceful settlement was made by the good offices of Odo of Canterbury and Wulfstan of York. Simeon of Durham states that a division of the kingdom was now made, whereby Edmund took England south of Watling Street and Anlaf the rest. This division seems incredible, especially in face of the poem inserted in the chronicle (*sub anno* 942). There can be little doubt that the story told there of the reconquest of Northern Mercia by Edmund refers to the compact with Anlaf, made as a result of the campaign, and it is probable that Simeon's statement is a wide exaggeration, due in part at least to a confused reminiscence of the earlier pact between Alfred and Guthrum. All Mercia south of a line from Dore (near Sheffield), through Whitwell to the Humber, was now in Edmund's hands, and the five Danish boroughs, which had for some time been exposed to raids from the Norwegian kings of Northumbria, were now freed from that fear. The peace was confirmed by the baptism of Kings Anlaf and Rægenald, Edmund standing as sponsor, but in 944 or 945 the peace was broken and Edmund expelled Anlaf and Rægenald from Northumbria.

In 945 Edmund ravaged Strathclyde, and entrusted it all to Malcolm, king of Scotland, "on condition that he should be his fellow-worker by sea and land," the object of this policy being apparently to detach the king of Scots from any possible confederacy such as had been formed in 937.

On the 26th of May 946 Edmund's brief but energetic reign came to a tragic conclusion when he was stabbed at the royal villa of Pucklechurch, in Gloucestershire, by an exiled robber

named Liofa, who had returned to the court unbidden. Edmund, the "deed-doer" as the chronicle calls him, "Edmundus magnificus" as Florence of Worcester describes him, perhaps translating the Saxon epithet, was buried at Glastonbury, an abbey which he had entrusted in 943 to the famous Dunstan.

Edmund was twice married; first to Ælfgifu, the mother of Eadwig and Edgar; second to Æthelred "æt Damerhame" (*i.e.* of Damerham, Co. Wilts). Ælfgifu died in 944, according to Æthelwerd.

AUTHORITIES.—*Anglo-Saxon Chronicle* (ed. Earle and Plummer, Oxford); *Simeon of Durham* (Rolls Series); A. S. Lewis, ed. Liebermann, pp. 184-191; Birch, *Cartularium Saxonicum*, Nos. 745-817; *Dictionary of National Biography*, s.v. (A. M. W.)

EDMUND, or **EDMUND** (c. 980-1016), called **IRONSIDE**, king of the English, was the son of Æthelred II. by his first wife Ælfgifu. When Canute invaded England in 1015, Edmund sought to resist him, but, paralysed by the treachery and desertion of the ealdorman Eadric, he could do nothing, and Wessex submitted to the Danish king. Next year Canute and Eadric together harried Mercia, while Edmund with infinite difficulty gathered an army. Returning into Northumbria, he in his turn harried the districts which had submitted to the invader, but a march northward by Canute brought about the speedy submission of Northumbria and the return of Edmund to London. The death of Æthelred on the 23rd of April 1016 was followed by a double election to the English crown. The citizens of London and those members of the Witan who were present in the city chose Edmund, the rest of the Witan meeting at Southampton elected Canute. In the warfare which ensued Edmund fought at the severest disadvantage, for his armies dispersed after every engagement, whatever its issue. Canute at once fiercely besieged London, but the citizens successfully resisted all attacks. Edmund meanwhile marched through Wessex and received its submission. At Pen in Somersetshire he engaged the Danes and defeated them. Canute now raised the siege of London and soon afterwards encountered Edmund at Sherston in Wiltshire. The battle was indecisive, but Canute marched back to London and left Edmund in possession of Wessex. Edmund hastened after him and relieved London, which he had again besieged. He defeated the Danes at Brentford and again at Otford, and drove them into Sheppey. He was now joined by Eadric, in conjunction with whom he followed the Danes into Essex, overtaking them at Assandun (or Ashington). In the battle which ensued Eadric again played the traitor, and the English were routed with terrible slaughter. Edmund retired into Gloucestershire, whither he was followed by Canute. He himself was anxious to continue the struggle, but Eadric and the Witan persuaded him to accept a reconciliation. At Olney the two rivals swore friendship, and a division of the kingdom was effected—Canute taking the north, Edmund the south. Soon afterwards Edmund died (30th of November 1016), probably from natural causes, though later historians hint at foul play. (C. S. P. *)

EDMUND, king of Sicily and earl of Lancaster (1245-1266), was the second son of Henry III. of England by Eleanor of Provence. At ten years of age Edmund was invested by Pope Alexander IV. with the kingdom of Sicily (April 1255); the pecuniary obligations which Henry III. undertook on his son's behalf were not the least among the causes which led to the Provisions of Oxford and the Barons' War. Alexander annulled his grant in 1258, but still pressed Henry for the discharge of unpaid arrears of subsidies. In 1265, after Montfort's fall, Edmund received the earldom of Leicester, and two years later was created earl of Lancaster. He joined the crusade of his elder brother, the Lord Edward (1271-1272); and Edward, on his accession, found in Edmund a loyal supporter. In 1275, two years after the death of his first wife, Aveline de Fortibus, Edmund married Blanche of Artois, the widow of Henry III. of Navarre and Champagne. Although the county of Champagne had descended to his wife's infant daughter, Joan, Edmund assumed the title "Count Palatine of Champagne and Brie" and is described in the English patent rolls as earl of Lancaster

and Champagne. Until 1284 he held, in his wife's right, the custody of Champagne. This he was compelled to renounce upon the marriage of Joan to Philip the Fair, the heir to the crown of France. But he retained the possession of his wife's dowrylands in Champagne, and is described in an official document of Champagne so late as the year 1287, as "the Count Edmund." He was employed by his brother as a mediator with Philip the Fair in 1293-1294. When Philip's court pronounced that the king of England had forfeited Gascony, Edmund renounced his homage to Philip and withdrew with his wife to England. He was appointed lieutenant of Gascony in 1296, but died in the same year, leaving a son Thomas to succeed him in his English possessions.

See "Edmund, Earl of Lancaster," by W. E. Rhodes, in the *English Historical Review*, vol. x. pp. 19, 209.

EDMUNDS, GEORGE FRANKLIN (1828-), American lawyer and political leader, was born in Richmond, Vermont, on the 1st of February 1828. He began the practice of law in 1849. He was a member of the Vermont House of Representatives in 1854, 1855, 1857, 1858 and 1859, acting for the last two years as speaker, and was a member and president *pro tem.* of the state Senate in 1861-1862. In 1866 he became a member, as a Republican, of the United States Senate, where he remained until 1891, when he resigned in order to have more time for the practice of his profession. He took an active part in the attempt to impeach President Johnson. He was influential in providing for the electoral commission to decide the disputed presidential election of 1876, and became one of the commissioners. In the national Republican nominating conventions of 1880 and 1884 he was a candidate for the presidential nomination. From 1882 to 1885 he was president *pro tem.* of the Senate. As senator he was conspicuous on account of his legal and parliamentary attainments, his industry and his liberal opinions. He was the author of the so-called Edmunds Act (22nd of March 1882) for the suppression of polygamy in Utah, and of the anti-trust law of 1890, popularly known as the Sherman Act.

EDOM, the district situated to the south of Palestine, between the Dead Sea and the Gulf of 'Akaba (Aelanitic Gulf), the inhabitants of which were regarded by the Israelites as a "brother" people (see ESAU). On the E. it touched Moab, the tribes of the great desert and the northern part of Arabia; on the W. its boundaries were determined by the Sinaitic peninsula, Egypt and Israel. Both Kadesh and Mt. Hor (perhaps Jebel Mädera) are represented as lying on its border (Num. xx. 16, 22), and the modern Wadi el-Fikreh, in which the "Scorpion pass" was probably situated (Judg. i. 36; Num. xxxiv. 4), may have marked its limits from Jebel Mädera north-west towards the southern extremity of the Dead Sea. Kadesh ('*Ain Kadis*'), however, lies about 50 m. south of Beerseba (the southern end of Israel as opposed to Dan in the north), and the precise borders must always have been determined by political conditions: by the relations between Edom and its neighbours, Judah, the Philistine states, Moab, and the restless desert tribes with which Edom was always very closely allied.

The northern part of Edom became known by a separate name as Gebalene (Gebal in Ps. lxxiii. 7), the modern Jibāl, "mountain country." Seir or Mt. Seir, a synonym for Edom, not to be confused with the Judean locality (Josh. xv. 10), has been identified with the modern el-Jarrah, the hilly region to the south of Petra; though its use probably varied in ancient times as much as that of Edom certainly did. Mt. Hälak, apparently one of its offshoots (Josh. xi. 17, xii. 7), is of uncertain identification, nor can the exact position of Paran (probably desert of el-Tih) or Zin (Sin) be precisely determined. The chief Edomite cities extended from north to south or adjoining an important trade-route (see below); they include Bozrah (Buseire), Shöbek, Petra (the capital), and Ma'an; farther to the south lay the important seaports Ezion-Geber (mod. 'Ain el-Ghudayän, now 15 m. north of the head of the Aelanitic Gulf) and Elath (whence the gulf derives its name). Petra (q.v.) is usually identified with the biblical Sela, unless this latter is to be placed at the south end of the Dead Sea (Judg. i. 36). The sites of Teman and Dedan, which also were closely associated with Edom (Jer. xlix. 7 seq.; Ez. xxv. 13), are uncertain. No doubt, as a general rule, the relations between Edomites and the "sons of the east" (Ezek. xxv. 10; Job i. 3) and the "kingdoms of Hazor" (nomad states: Jer. xlix. 28, 30, 33) varied considerably throughout the period of O.T. history.

The land of Edom is unfruitful and forbidding, with the notable exception of fertile districts immediately south of the Dead Sea and along its eastern border. It was traversed by an important trade-route from Elath (the junction for routes to Egypt and Arabia) which ran northwards by Ma'an and Moab; but cross-routes turned from Ma'an and Petra to Gaza or up the Ghor (south end of Dead Sea) to Hebron and Jerusalem.¹ Thus Edom formed a prominent centre for traffic from Arabia and its seats of culture to Egypt, the Philistine towns, Palestine and the Syrian states, and it enjoyed a commercial importance which made it a significant factor in Palestinian history.

The earliest history of Edom is that of the "sand-dwellers," "archers" or *Shasu* (perhaps "marauders"), whose conflicts with ancient Egypt are not infrequently mentioned. The first clear reference is in the eighth year of Mineptah II. (close of 13th century B.C.), when a tribe of Shasu from Aduma received permission to enter Egypt and feed their flocks.² A little more than a century later Rameses III. claims to have overthrown the Saaru among the tribes of the Shasu, and the identification of this name with Seir is usually recognized, although it is naturally uncertain whether the Edomites of Old Testament tradition are meant. According to the latter, the Edomites were a new race who drove out the Horites from Mt. Seir. The designation suggests that these were "cave-dwellers," but although many caves and hollows have been found about Petra (and also in Palestine), this tradition probably "serves only to express the idea entertained by later generations concerning their predecessors" (Nöldeke).

Not only is Edom as a nation recognized as older than Israel, but a list of eight kings, who reigned before the Israelite monarchy, is preserved in Gen. xxxvii.

The first Bela, son of Beor, is often identified with Balaam, but the traditions of the Exodus are not precise enough to warrant the assumption that the seer was the king of a hostile land in Num. xx. 14 seq., which in Deut. ii. 1-8 appears to have been peaceful; see BALAAM; EXODUS. In Husham, the third king, several scholars (Grätz, Klostermann, Marquart, &c.) have recognized the true adversary of Othniel (q.v.; Judg. iii.). The defeat of Midian in the land of Moab by his successor Hadad has been associated with the Midianite invasion in the time of Gideon (q.v.; Judg. vi. seq.). The sixth is Shaul, whose name happens to be identical with Saul, king of Israel, whilst the last Hadad (so 1 Chron. i. 50) of Pau (or Peor in Moab, so the Septuagint) should belong to the time of David. The list, whatever its value, together with the other evidence in Gen. xxxvi., implies that the Edomites consisted of a number of local groups with chieftains, with a monarchy which, however, was not hereditary but due to the supremacy of stronger leaders. The tradition thus finds an analogy in the Israelite "judges" before the time of Saul and David.

Saul, the first king of Israel, conquered Edom (1 Sam. xiv. 47).³ Of the conquest of Edom by David, the first king of the united Judah and Israel, several details are given (2 Sam. viii. 13 seq.; 1 Kings xi. 14 seq.; 1 Chron. xviii. 11 seq.; cf. Ps. lx. title and ver. 8 seq.), although the account of the slaughter is certainly exaggerated. The scene was the valley of Salt, probably to the south of the Dead Sea. Of the escape of the Edomite prince Hadad, and of his residence in Egypt, a twofold account is

¹ See further, E. Robinson, *Biblical Researches*, vol. ii.; E. Hull, *Mt. Seir*; E. H. Palmer, *Desert of the Exodus*; Baedeker's *Palestine and Syria*; C. W. Wilson, "Quart. Stat." (*Pal. Explor. Fund.*), 1899, p. 307, and G. A. Smith, *Ency. Bib.* col. 5162 seq.

² In the old story of Sinaith (ascribed to the 12th dyn.) the hero visits the land of *Kedem*, which, it was suggested, lay to the south-east or south of the Dead Sea; see, however, now A. H. Gardiner, *Sitz-Ber.* of the Berlin Academy, 1907, pp. 142 seq. The suggestion that the city *Udumu*, in the land of Gar, mentioned in the 15th century (*Amarna Tablets*, ed. Winckler, No. 237), is Edom, Gar being the Eg. *Kharu* (Palestine) and the O.T. Horites (see above), is extremely hazardous. That the name Aduma (above) refers to Etham (so Naville, &c.) is improbable.

³ That the Edomites preserved this tradition of Saul's sovereignty and (from their standpoint) enrolled him among their kings (Gen. xxxvi. 37) cannot of course be proved. The account of the ferocious slaughter of the priests of Nob at Saul's command by Doeg the Edomite is a secondary tradition and probably of late origin (1 Sam. xxii. 1-9, xxiii. 6-23); cf. the hostility of Edom in exile and post-exilic times (p. 878, col. 1).

preserved.¹ After the death of David he returned to Edom; if, as the narrative implies, he became a troublesome adversary to Solomon, nothing is known of his achievements, and if the royal trading-journeys from Ezion-geber were maintained, Edom could have done little. However, in the first half of the 9th century Edom was under the rule of Jehoshaphat of Judah, and this king together with Israel held Ezion-geber (1 Kings xxiii. 47 sqq.; 2 Chron. xx. 35 sqq.). But some catastrophe befell the fleet, and shortly afterwards Jehoshaphat's son Jehoram had to face a revolt in which Edom and the men of Libnah (the Philistines) were concerned. It was about this period that Israel had conquered Moab, thrusting it farther south towards Edom, and the subsequent success of Moab in throwing off the yoke, and the unsuccessful attempt of Jehoram of Israel to regain the position, may show that Edom was also in alliance with Moab.² In the time of Adad-nirari of Assyria (812-783 B.C.) Edom is mentioned as an independent tributary with Beth-Omri (Israel) and Palashtu (Philistia); the absence of Judah is perplexing. Amaziah of Judah had gained a signal victory over Edom in the valley of Salt (2 Kings xiv. 7), but after his defeat by Jehoash of Israel there is a gap and the situation is obscure. Consequently it is uncertain whether Edom was the vassal of the next great Israelite king Jeroboam II., or whether the Assyrian evidence for its independent position belongs to this later time. However, Uzziah, a contemporary of Jeroboam II., and one of the most successful of Judaean kings, overcame Edom and its natural allies (2 Chron. xxvi. 6 sqq.), and at this stage Edomite history becomes more prominent. It joined the great coalition in which Philistia and Israel were leagued against Assyria, and drove out the Judeans who had been in possession of Elath.³ On the events that followed see **AEAR**; **HEZEKIAH**; **PHILISTINES**. The Assyrian inscriptions name as tributary kings of Edom, Kauš-melek (time of Tiglath-Pileser IV.), Malik (?)-ram (701 B.C.), and Kauš-gabri (7th century). In the middle of the 7th century both Edom and Moab suffered from the restlessness of the desert tribes, and after another period of obscurity, they joined in the attempt made by Zedekiah of Judah to revolt against Nebuchadnezzar (Jer. xxvii. 3). In the last years before the fall of Jerusalem many of the Jews found a refuge in Edom (Jer. xl. 11), although other traditions throw another light upon the attitude of Edom during these disasters.

That Edomites burned the temple after the destruction of Jerusalem (1 Esd. iv. 45, cf. 2, 50) is on a line with the repeated denunciation of their "unorthodox" conduct in later writings. Certainly the weak state of Palestine invited attacks from the outlying tribes, but the tone of certain late writings implies a preliminary period of, at least, neutrality (cf. Deut. ii. 4 sqq., xxiii. 7 sqq.; the omission of Edom in xxiii. 3; Neh. xiii. 1; and in Ezra ix. 1—contrast 1 Esd. viii. 69). Subsequently Edom is execrated for revengeful attacks upon the Jews, and its speedy destruction is foretold; but the passages appear to be much later than the disaster of 587 B.C., and may even imply conditions after the restoration (Ob. 10 sqq.; Ezek. xxv. 12-14; Jer. xlix. 7; Pa. cxxvii. 7; Lam. iv. 21 sqq., v. 2 sqq.). But at length the day of reckoning came (cf. Is. xxxiv. 5; lxxii. 1-6), and the fate of Edom is still fresh in the mind of Malachi (i. 1-5).

The problem is complicated by the possibility that during the ages over which the references can range many changes of fortune could have occurred. The pressure of the Nabataeans (q.v.) forced Edom to leave its former seats and advance into the south of Judah with Hebron as the capital. This had been fully accomplished by 312 B.C., but the date of the first occupation cannot be ascertained from the literary evidence alone. Thus the district

¹ 1 Kings l.c., see the Septuagint and, especially, H. Winckler, *Allzeit. Untersuch.*, pp. 1-15; C. F. Burney, *Kings*, pp. 158 sqq.; J. Skinner, *Kings*, pp. 443 sqq.; Ed. Meyer, *Israeliten*, pp. 358 sqq.

² On 2 Kings iii. see **JEHORAM**; **JEHOSEPHAT**; **MOAB**; and for the biblical traditions relating to this period see **KINGS (BOOK)** and **Jews: History**. The chronicler's account of Judaean successes (2 Chron. xvii. 10 sqq.; xx. 1) and reverses (xvi. 16, xvii. 1) may rest originally upon the source from which 1 Kings xvii. 47 sqq.; 2 Kings viii. 20, 22, have been abbreviated. It is hardly probable that there was enmity between Edom and Moab as 2 Kings iii. now implies, although hostile relations at other periods are likely (cf. Am. ii. 1); for Edom in Moabite territory see above on Gen. xxxvi. and "Quart. Stat." (*Pal. Explor. Fund.*) 1902, pp. 10 sqq.

³ 2 Kings xvii. 6; on the text see the commentaries.

in question is Jewish in the time of Nehemiah (Neh. xi. 25-30), but it is uncertain whether the Edomite occupation was earlier (a fusion being assumed) or later, or whether the passage may be untrustworthy. Henceforth, the new home of the Edomites is consequently known as Idumaea. See, for further history, **HEZROO**; **Jews**.⁴

Although but little is known of the inhabitants of Edom, their close relationship to Judah and their kinship with the surrounding tribes invest them with particular interest. The ties which united Lot (the "father" of Ammon and Moab), Ishmael, Midian and Edom (Esau) with the southern tribes Judah and Simeon, as manifested in the genealogical lists, are intelligible enough on geographical grounds alone, and the significance of this for the history of Judah and Palestine cannot be ignored. The traditions recording the separation of Lot from Abraham, of Hagar and Ishmael from Isaac, and of Esau from Jacob, although at present arranged in a descending scheme of family relationship, are the result of systematic grouping and cannot express any chronological order of events (see **GENESIS**). Many motives have worked to bring these legends into their present form, and while they depict the character of Israel's wilder neighbours, they represent the recurrent alternating periods of hostility and fellowship between it and Edom which mark the history. Esau (Edom) although the older, loses his superiority, and if the oracles declare that the elder shall serve the younger (Jacob, i.e. Israel), the final independence of Esau (Gen. xxv. 23, xxvii. 39 sqq.), as foretold, obviously alludes to some successful Edomite revolt. As an enemy, Edom in alliance with the tribes along the trade-routes (Philistines, Moabites, &c.) was responsible for many injuries, and in frequent forays carried away Judeans as slaves for Gaza and Tyre (Am. i. 6 sqq., 9). As an ally or vassal, it was in touch with the wealth of Arabia (Ezek. xxvii. 16, read "Edom" for "Aram"), and Judah and Israel as well as Gaza and Damascus enjoyed the fruits of its commerce. In view of the evidence for the advanced culture of early Arabia, the question of Edom is extremely suggestive, and although speculation at this stage would be premature, it is interesting to observe that Edomite and allied tribes were famed for their wisdom,⁵ and that apart from the possibility of Arabian influence upon Israelite culture, the influence of Midian and related tribes is certain from the traditions of Moses and of his work (see **JETHRO**; **KENITES**; **MOSES**), and the Edomite district was a traditional home of Yahweh himself (Deut. xxxiii. 2; Judg. v. 4; Hab. iii. 3); see **HEBREW RELIGION**. It should be added, however, that the Edomite names and other evidence point to the cult of other gods, viz. Baal, Hadad, Malik (cf. **MOLOCH**), Kauš, or Kuš, and Kozeh (Jos. *Ant.* xv. 7, 9), who was probably a sky or lightning deity.

The names Esau and Edom are possibly old divine names; see **ESAU** and *Ency. Bib. s.v.* "Obed-edom" (the name appears to mean "servant of Edom"). For Kauš, see Baethgen, *Beitr. z. semit. Religionsgeschichte*, p. 11 sqq.; G. A. Cooke, *N. Sem. Inschr.* p. 234; *Ency. Bib. col.* 2682, n. 2 and 2688 (s.v. "Kushaiah"); and Zimmern, *Kleininschr. u. d. alte Test.*, pp. 472 sqq. On the question of early Arabian civilization see **YEMEM**. That the name Misraim (Misraim), "Egypt," was extended eastwards of the Delta is in itself probable, but it is still uncertain whether the term (also *Ass. Misri*) was applied to Edom. The evidence (which is of mixed value) makes the view a plausible one, but the theory has often been exaggerated (see **MISRAIM**). For Edom see generally, Buhl, *Gesch. d. Edomiter* (1892); Nöldke's article in *Ency. Bib.*; W. Libbey and F. E. Hoskins, *The Jordan Valley and Petra* (1905); the conjectural sketch by I. Levy in *Rev. d'études juives* (Jan. 1906). For the history and culture of the latest period, see J. P. Peters and Thierack, *Painted Tombs in the Necropolis of Marissa* (1905), ch. i. (S. A. C.)

EDRED (EADRED), king of the English (d. 955), was the youngest son of Edward the Elder and his wife Eadgifu. He succeeded his brother Edmund in the year 946 and at this time received the formal submission both of the Northumbrians and Scots. In the next year Edred himself went to Tanshelf, near

⁴ For the Jewish hatred of Edom in later times see the book of Enoch lxxxix. 11-12; Jubilees, xxxvii. 22 sqq., and on the Talmudic custom of applying to the Romans the references to Edom or Esau, see *Jewish Ency.* vol. v. p. 41.

⁵ Ob. 8; Jer. xlix. 7 sqq.; Baruch iii. 22, cf. 1 Kings iv. 30; see also Job.

Pontefract, in Yorkshire, where he received from Wulfstan, archbishop of York, and the Northumbrian "witan" confirmation of their submission. Shortly after they threw their pledges to the winds and took the Norwegian Eric Bloodaxe, son of Harold Fairhair (Harald Harfagar), as their king. Eadred recklessly ravaged all Northumbria in revenge, burning Ripon during his march. On his return home Eadred's rearguard was attacked at Castleford, and the infuriated king once more turned to ravage Northumbria, which was only saved by its abandonment of Eric and by compensation made to Eadred. Archbishop Wulfstan seems to have been a centre of disaffection in the north, and in 952 Eadred caused him to be imprisoned in the castle of "Judanburh," while in the same year the king, in revenge for the slaying of Abbot Eadelm, slew many of the citizens of Thetford. After the brief rule of Anlaf Cuaran in Northumbria, Eric was once more restored, probably in 950, only to be expelled again in 953 or 954, when Eadred took the Northumbrian kingdom into his own hands. In the same year Wulfstan was liberated and appointed to the Mercian bishopric of Dorchester. Eadred died on the 23rd of November 955 at Frome, in Somersetshire, and was buried in the old minster at Winchester. During the whole of his life Eadred was troubled by ill-health, a fact which may help to explain some of the more passionate acts of violence attributed to him. The king was throughout his life on terms of personal intimacy with St Dunstan, and his public policy was largely guided by that prelate and by his own mother Eadgifu. So far as we know, Eadred was never married.

AUTHORITIES.—The *Saxon Chronicle* (ed. Earle and Plummer, Oxford), *sub ann.*; *Memorials of St Dunstan* (Rolls Series, ed. Stubbs); Florence of Worcester; Birch, *Cartularium Saxonicum*, vol. iii., Nos. 813-834 and 860-931; *D.N.B.*, art. *sub voce*. (A. M. W.)

EDRIC, or EADRIC, STREONA (d. 1017), ealdorman of the Mercians, was a man of ignoble birth who was advanced to high dignity through the favour of the English king Æthelred II. In 1007 he became ealdorman of the Mercians, and subsequently married Æthelred's daughter Eadgyth. In the struggle between the English and the Danes he appears in the character of an arch-traitor. When Æthelred in 1009 proposed a great attack on the Danes, Eadric dissuaded him from carrying it into effect. Again, on the invasion of England by Canute in 1015 Eadric deserted Edmund Ironside and joined him. After the battle of Otford he returned to Edmund, but only by his treachery at the battle of Assandun to secure the utter defeat of the national cause. When peace was at length made, Canute restored to Eadric the earldom of Mercia; but at Christmas 1017, fearing further treachery, he had him slain—"very rightly" says the *Saxon Chronicle*.

EDUCATION. In the following treatment of this subject, the theory and early history of education is first dealt with, and secondly the modern organization of education as a national concern. Many definitions have been given of the word "education," but underlying them all is the conception that it denotes an attempt on the part of the adult members of a human society to shape the development of the coming generation in accordance with its own ideals of life. It is true that the word has not infrequently been used in wider senses than this. For example, J. S. Mill included under it everything which "helps to shape the human being"; and, with some poetic licence, we speak of the education of a people or even of the whole human race. But all such usages are rhetorical extensions of the commonly accepted sense of the term, which includes, as an essential element, the idea of deliberate direction and training (Lat. *educare*, to bring up; *educere*, to draw out, lead forth). No doubt, all education is effected through the experiences of the educated, and much of it is indirect, consisting mainly in the determination of the form of experiences other than those of direct precept, compulsion and instruction. But it does not follow that all experiences are educative. Whether an experience is part of an individual's education or not is determined by its origin. Whatever be its effect, it is educative in so far as its form has been arranged with greater or less deliberation by those who are concerned with the training of him whose experience it is. It follows that an education may be good or bad, and that its

goodness or badness will be relative to the virtue, wisdom and intelligence of the educator. It is good only when it aims at the right kind of product, and when the means it adopts are well adapted to secure the intended result and are applied intelligently, consistently and persistently.

Education is, thus, a definitely personal work, and will vary between wide extremes of effectiveness and worth in any given society. For in all times and places there are wide differences in virtue, wisdom and capacity among those who have in their hands the care and nurture of the young. But the inference that, therefore, no comparative estimate of the education of different times and places can be made would be fallacious. For, despite all differences in conception and efficiency among individual educators, each expresses, more or less perfectly and clearly, the common conception and energy of his age and country. As these rise or fall the general level of the actual educative practice rises or sinks with them. The first essential for successful educative effort is, then, that the community as a whole should have a true estimate of the nature and value of education.

I. EDUCATIONAL THEORY

In any comparative estimate of different places and times, as tested by the standard just given, it must be borne in mind that, except in the most general and abstract form, we cannot speak of an ideally best education. Looking at the individual to be educated, we may say with Plato that the aim of education is "to develop in the body and in the soul all the beauty and all the perfection of which they are capable," but this leaves quite undecided the nature and form of that beauty and perfection, and on such points there has never been universal agreement at any one time, while successive ages have shown marked differences of estimate. We get nearer to the point when we reflect that individual beauty and perfection are shown, and only shown, in actual life, and that such life has to be lived under definite conditions of time, place, culture, religion, national aspirations and mastery over material conditions. Perfection of life, then, in the Athens of the age of Plato would show a very different form from that which it would take in the London or Paris of to-day. So an individualistic statement of the purpose of education leads on analysis to considerations that are not, in themselves, individualistic. The personal life is throughout a relation between individual promptings to activity and the environment in which alone such promptings can, by being actualized, become part of life. And the perfection of the life is to be sought in the perfection of the relations thus established. So far, then, as any conception of education can give guidance to the actual process it must be relative in every way to the state of development of the society in which it is given. Indeed, looked at in the mass, education may be said to be the efforts made by the community to impose its culture upon the growing generation. Here again is room for difference. The culture in question may be accepted as absolute at least in its essentials, and then the ideal of education will be to secure its stability and perpetuation, or it may be regarded as a stage in a process of development, and then the ideal will be to facilitate the advance of the next generation beyond the point reached by the present. So some ages will show a relatively fixed conception of the educative process, others will be times of unrest and change in this as in other modes of social and intellectual life.

It is in these latter times that the actual work of education is apt to lose touch with the culture of the community. For schools (*g.s.*) and universities (*u.s.*), which are the ordinary channels through which adult culture reaches the young, are naturally conservative and bound by tradition. They are slow to leave the old paths which have hitherto led to the desired goal, and to enter on new and untried ways. If the opposition to change is absolute, there must come a time when the instruments of education are out of true relation to the desired end. For change in culture ideals means change in the specific form of the goal of education, and consequently the paths of educative effort need readjustment. When the goal of the past is no longer the goal of the present, to follow the ways which led to

the former is to fail to reach the latter. Continuous readjustment, by small and almost imperceptible degrees, is the ideal at which the educator should aim. When this is not secured, the educational domain is liable to sudden and violent revolutions which are destructive of successful educative effort at the time they occur, however beneficial their results may be in the future.

But the relation of adjustment is not entirely one-sided. The tone of thought and feeling and the direction of will induced by education necessarily affect the common ideals of the next generation, and may make them better or worse than those of the present. Hence, the educator must not blindly accept all current views of life, but rather select the highest. For the average thought of every community is obviously below its best thought; and may, in some points at any rate, be lower than the best thought of a past age. While, then, all true education must be in direct relation with the culture of its age and country, yet, especially on the ethical side, it should aim at transcending the average thought and tone.

Still more does this imply that education strives to transcend the present condition of the educated by making their life more rational, more volitional, and more attracted by goodness and beauty than it would otherwise be. It can never be a passive watching of the child's development. No more fundamental error can be made than the assumption that education can be determined wholly, or even mainly, by the tendencies and impulses with which a child is endowed. Its real guiding principle must be a conception of the nature to which the child may attain, not a knowledge of that with which it starts. The educator studies the original endowment of the child and the early stages in the development of that innate nature in order that he may, wisely and successfully, employ appropriate means to direct further development and to accelerate its progress towards a more rational, complete and worthy life; not that he may the more skillfully give facilities to the child to drift about on the unregulated currents of caprice.

Such considerations show the importance of an insight into the theory of education on the part of all who are practically concerned with its direction. But the theory required is no system of abstract ideas ignoring the real concrete conditions of the life for which the actual education it is to guide is a preparation. To approach the subject only from the standpoint of the mental sciences which underlie it is to run the risk of setting up such a body of abstractions, whose relation to real life is neither very close nor very direct. The most profitable way of developing an educational theory for the present is to trace how in the past education has consciously adapted itself, more or less truly and fully, to the conditions of culture and social life; and by analysis to discover the reasons for comparative success or failure in the degree of clearness with which the end to be sought was apprehended and the nature of the children to be trained was understood.

In all ages the claims of the individual and those of the community have struggled for the mastery as the ultimate principles of life. As one or the other has prevailed the conception of education has emphasized social service or individual success as the primary end. The true harmony of human life will only be attained when these two impulses, contradictory on their own level, are united in a higher synthesis which sees each as the complement of the other in a life whose purpose is neither simple egoism nor pure altruism. Until that conception of life is attained and held generally there can be no sure and universally accepted conception of the aim and function of education. Much of the interest of the history of education¹ turns on the relation of these two principles as determinants of its aim.

In ancient Greece the supremacy of the state was generally unquestioned, and, especially in the earlier times, the good man was identified with the good citizen. No doubt, in later days philosophers, such as Plato and Aristotle, saw clearly that the round of the duties of citizenship did not exhaust the life of the individual. With them the highest

life was one of cultured leisure in which the energies were mainly concentrated on the pursuit of knowledge for its own sake. But this "diagogic" life was only for the select few; for the undistinguished many the fulfilment by each of the duties of his station remained the measure of worthy life, though such duties were regarded as affecting the individual and private relations of the citizens in a much more intimate way than in former and ruder ages. And for those who devoted their lives to the highest culture, the essential preliminary condition was the existence of such a state as would form the most favourable environment for their pursuits and the most stable foundation for their leisured life. Thus Greek thought was saturated with the conception of life as essentially a set of relations between the individual and the city-state of which he formed an integral part. The first aim of education was therefore to train the young as citizens.

This training must, of necessity, be of a specific kind; for, like other small communities, the Greek city-states showed a life fundamentally one in conception, under various specific forms. Each state had its special character, and to this character the education given in it must conform if it were to be an effective instrument for training the citizens. From these fundamental conceptions flowed the demands of Plato and Aristotle that education should be regulated in all its details by the state authority, should be compulsory on all free citizens, and should be uniform—at any rate in its earlier stages—for all. In the *Republic* and the *Laws*, Plato shows to what extreme lengths theory may go when it neglects to take account of some of the most pertinent facts of life. For the guardian-citizens of the ideal state family life and family ties are abolished; no lower community is to be allowed to enter into competition with the state. Aristotle, indeed, did not go to these extreme lengths; he allowed the family to remain, but he seems to have regarded it as likely to affect children more for evil than for good.

In the essential principles laid down by both philosophers as to the relation of the state to education, and in the corollaries they drew from that relation, they were not at variance with the accepted Greek theory on the subject. It is true that the actual practice of Greek states departed, and often widely, from this ideal, for, especially in later centuries, the Greek always tended to live his own life. The nearest approach to the theory was found in Sparta, where the end of the state as a military organization was kept steadily in view, and where, after early childhood, the young citizens were trained directly by the state in a kind of barrack life—the boys to become warriors, the girls the mothers of warriors. It was this feature of Spartan education, together with the rude simplicity of life it enforced, which attracted Plato, and, to a less extent, Aristotle. In Athens there had of old been state laws insisting on the attendance of the children of the free citizens at school, and, in some degree, regulating the schools themselves. But at the time of Plato these had fallen into desuetude, and the state directly concerned itself only with the training of the ephebi, for which, we learn from Aristotle's *Constitution of Athens*, somewhat elaborate provisions were made by the appointment of officers, and the regulation of both intellectual and physical pursuits. For children and youths under the ephebic age there was no practical regulation of schools or palaestra by the state. Yet there is no doubt that the education really given was in conformity with Athenian ideals of culture and life, and that it was generally received by the children of free citizens, though of course the sons of the wealthy, then as now, could and did continue their attendance at school to a later age than their poorer brethren. The education of girls was essentially a domestic training. What Plato and Aristotle, with the theorist's love of official systematic regulation, regarded as the greatest defect of Athenian education was in reality its strongest point. In practice, the harmony between individual liberty and social claims was much more nearly attained under a system of free working out of common thoughts and ideals than would have been the case under one of the irresistible imposition from without of a rigid mould.

The instruments of education everywhere found to be in

¹ For the evolution of the school as such from early times see SCHOOLS.

harmony with the Greek conception of life and culture were essentially twofold,—“music” (*μουσική*), or literary and artistic culture, for the mind, and systematic gymnastic (*γυμναστική*) for the body. Plato, in the *Republic*, shows that the latter, as well as the former, affects the character, and doubtless, though not formulated, this was generally more or less vaguely felt. But Greek gymnastic was really an individual training, and therefore made only indirectly for the aim of cultivating the social bonds of citizenship. Ancient Greece had nothing corresponding in value in this respect to the organized games which form so important a feature in the school life of modern England. The “musical” training was essentially in the national literature and music of Greece, and this could obviously be carried to very different lengths. The elements of mathematical science were also commonly taught. The essential purpose throughout was the development of the character of a loyal citizen of Athens. As Athenian culture advanced, increasing attention was paid to diagogic studies, especially in the ephebic age, with a corresponding decrease of attention to merely physical pursuits; hence the complaints of such satirists as Aristophanes of a growing luxury, effeminacy and corruption of the youths: complaints apparently based on a comparison of the worst features of the actual present with an idealized and imaginative picture of the virtues of the past. Such comparison is, indeed, implicit in much of Plato and Aristotle as well as in Aristophanes.

But a disintegrating force was already at work in the educational system of Greece which Plato and Aristotle vainly opposed. This was the rhetorical training of the Sophists, the narrowly practical and individualistic aim of which was entirely out of harmony with the older Greek ideals of life and culture. In a democratic city-state the orator easily became a demagogue, and generally oratory was the readiest path to influence and power. Thus oratory opened the way to personal ambition, and young men who were moved by that passion eagerly attended the Sophist schools where their dominant motive was strengthened.

Further, the closer relations between the Greek states, both in nearer and farther Hellas, led naturally to the diminution of differences between civic ideals, and, as a consequence, to a more cosmopolitan conception of higher education. This process was completed by the loss of political independence of the city-states under the Macedonian domination. Henceforth, higher education became purely intellectual, and its relation to political and social life increasingly remote. This, combined with the growing rhetorical tendency already noticed, accounts for the sterility of Greek thought during the succeeding centuries. The means of higher education were, indeed, more fully organized. The university of Athens was the outcome of a fusion of the private philosophical schools with the state organization for the training of the ephebi, and there were other such centres of higher culture, especially in after years at Alexandria, where the contact of Greek thought with the religions and philosophies of Egypt and the East gave birth in time to the more or less mystical philosophies which culminated in Neo-platonism. But at Athens itself thought became more and more sterile, and education more and more a mere training in unreal rhetoric, till the dissolution of the university by Justinian in A.D. 529.

Thus when Rome conquered Greece, Greek education had lost that reality which is drawn from intimate relation to civic life, and the fashionable individualistic schools of philosophy could do nothing to replace the loss. It was, then, an education which had largely lost its life-springs that was transferred to Rome. In the earlier centuries of the republic, Roman education was given entirely in family and public life. The father had unlimited power over his son's life, and was open to public censure if he failed to train him in the ordinary moral, civic and religious duties. But it is doubtful if there were any schools (*g. v.*), and it is certain there was no national literature to furnish an instrument of culture. A Roman boy learnt to reverence the gods, to read, to bear himself well in manly exercises, and to know enough of the laws of his country to regulate his conduct. This last he acquired directly by hearing

his father decide the cases of his clients every morning in his hall. The rules of courtesy he learnt similarly by accompanying his father to the social gatherings to which he was invited. Thus early Roman education was essentially practical, civic and moral, but its intellectual outlook was extremely narrow.

When a wider culture was imported from Greece it was, however, the form rather than the spirit of true Hellenic education that was transferred. This was, indeed, to some extent inevitable from the decadent state of Greek education at the time, but it was accentuated by the essentially practical character of the Roman mind. The instrument of education first introduced was Greek literature, much of which was soon translated into Latin. In time the schools of the *grammatici*, teaching grammar and literature, were supplemented by schools of rhetoric and philosophy, though the philosophy taught in them was itself little more than rhetorical declamation. These furnished the means of higher culture for those youths who did not study at Alexandria or Athens, and were also preparatory to studies at those universities. Under the Empire the rhetorical schools were gradually organized into a state system, the general principles of administration being laid down by imperial decree, and even such details as the appointment and rate of payment of the professors, at first left to the municipalities, being in time assumed by the central government. There is no evidence of any state regulation or support of the lower schools. This widening of culture affected both boys and girls, the domestic education of the latter being supplemented by a study of literature. But it is the higher training in rhetoric which is especially characteristic of Hellenized Roman education.

The conception of a rhetorical culture is seen at its best in Quintilian's *Institutio oratoria*, the most systematic treatise on education produced by the ancient world. With Quintilian the ideal of an orator was a widely cultured, wise and honourable man. And at first the teaching of rhetoric undoubtedly made for higher and true culture. But with the autocracy, soon passing into tyranny, of the empire, rhetoric ceased to be a preparation for real life. The true function of oratory is to persuade a free people. When it cannot be applied to this purpose it becomes little more than a means of intellectual frivolity, or, at the best, an exhibition of cultured ingenuity. Under the empire a rhetorical training was, indeed, turned in not a few instances to practical but most unworthy uses by the delators; a result made possible by the legal system which rewarded declamation with a considerable portion of the estate of the condemned. Even apart from this, the education in rhetoric had an increasingly evil effect both on the culture and on the character of the higher classes in the Roman empire. Out of real connexion with life as it was, it sought its subjects in the realms of the fanciful and the trivial, and with unreality of topic went of necessity deterioration of style. The vivid presentment of living thought gave way to that inflated and bombastic abuse of meretricious ornament and far-fetched metaphor in which human speech is always involved when it sets forth ideas, or shadows of ideas, which grow out of no conviction in the speaker and are expected to carry no conviction to the hearer. Imitation of the form of great models, without the substance of thought which underlay them, led to a general unreality and essential falseness of mental life. Further, the continual gazing with admiration on the productions of the past, and the conception of excellence as consisting in closeness of imitation, induced a servile attitude of mind towards authority in all too close agreement with the political servility which marked the Roman court. Such an attitude was essentially hostile to mental initiative, and thus rhetoric became not merely an art of expression but a type of character.

Nor was there anything in the general conditions of society to counterbalance the ill effects of school and university education. Quintilian lamented that, even in his time, the old Roman family education by example was corrupted; and the moral degradation of later times, though it has doubtless been exaggerated, was certainly real and widespread. Nor does the

religious revival of Paganism which synchronized with the early centuries of Christianity appear to have effected any reform in life. Alexandria, the birthplace of Neo-platonism and the intellectual centre of the later empire, was also a very sink of moral obliquity.

It was into such a decaying civilization, which by its want of vitality sterilized education, oppressing it under the weight of a dead tradition, that Christianity brought new life.

Christianity and Pagan education. Of course, careful instruction in the Faith was given in catechetical schools, of which that at Alexandria was the most famous. But the question as to the attitude of Christians towards the ordinary classical culture was important.

On the one hand, literature was saturated with Paganism, and the Pagan festivals formed a regular part of school life. On the other hand, the Pagan education offered the only means of higher culture, and thus furnished the only weapon with which Christians could successfully meet their controversial antagonists. Quite at first, no doubt, when the converts to the new faith were few and obscure, the question scarcely arose; but as men of culture and position were attracted to the Church it became urgent. The answers given by the Christian leaders were various, and largely the outcome of temperament and previous training. The Greek Fathers, especially Clement of Alexandria (150-217) and Origen (185-253), regarded Christianity as essentially the culmination of philosophy, to which the way must be found through liberal culture. Without a liberal education the Christian could live a life of faith and obedience but could not attain an intellectual understanding of the mysteries of the Faith. On the other hand, Tertullian (160-240) was very suspicious of Pagan culture; though he granted the necessity of employing it as a means of education, yet he did so with regret, and would forbid Christians to teach it in the public schools, where some recognition of Paganism would be implied. The general practice of the Christians, however, did not conform to Tertullian's exhortations. Indeed, many of the cultivated Christians of the 3rd and 4th centuries were little more than nominal adherents to the Faith, and the intercourse between Christian and Pagan was often close and friendly. The general attitude of Christians towards the traditional education is evidenced by the protest raised against the edict of Julian, which forbade them to teach in the public schools. The ultimate outcome seems to be fairly expressed in the writings of St Augustine (354-430) and St Jerome (346-420), who held that literary and rhetorical culture is good so long as it is kept subservient to the Christian life.

In another way Greek philosophy exercised an abiding influence over the culture of future ages. The early centuries of Christianity felt the need of formulating the Faith to preserve it from disintegration into a mass of fluid opinions, and such formulation was of necessity made under the influence of the philosophy in which the early Fathers had been trained—that Neo-platonism which was the last effort of Paganism to attain a conception of life and of God. In the West, this formulation had to be translated into Latin, for Greek was no longer generally understood in Italy, and thus the juristic trend of Roman thought also became a factor in the exposition of Christian doctrine. This formulation of the Faith was one of the chief legacies the transition centuries passed on to the middle ages.

Had classical culture been less formal than it was during the early centuries of Christianity, the innate antagonism of the Pagan and Christian views of life and character must have been so apparent that the education which prepared for the one could not have been accepted by the other. It was only because rhetorical culture was so emphatically intellectual, and so little, if at all, moral in its aims, that its inherent opposition to the Christian conception of character was not obvious. That its antagonistic influence was not inoperative is shown by the not infrequent perversions of cultured Christians to Paganism. But generally the opposition was so obscured that the ethical writings of St Ambrose (340-397) are largely Stoic in conception and reasoning. Yet the Pagan ideal of life, especially as it had been developed in the individualistic ethics which had prevailed for more than six centuries, was antithetical in essence to that

of the Christian Church. The former was essentially an ethics of self-reliance and self-control showing itself in moderation and proportion in all expressions of life. An essential feature in such a character was high-mindedness and a self-respect which was of the nature of pride. On the contrary, Christian teaching exalted humility as one of the highest virtues, and regarded pride and self-confidence as the deadliest of sins. It recognized no doctrine of limitation; what was to be condemned could not be abhorred too violently, nor could what was good be too strongly desired or too ardently sought. The highest state attainable by man was absorption in loving ecstasy in the mystic contemplation of God. The practical attempt to realize this gave rise to monasticism, with its minutely regulated life expressing unlimited obedience and the renunciation of private will at every moment. The monastic life was regarded as the nearest approach to the ideal which a Christian could make on earth. Naturally, as this conception gathered strength in generations nurtured in it, the value of classical culture became less and less apparent, and by the time of St Gregory the Great (d. 604) the use of classical literature except as means of an education having quite another end than classical culture was discouraged.

Of course, during these centuries, the gradual subjugation of the western empire by the barbarians had been powerfully operative in the obscuring of culture. Most of the public schools disappeared, and generally the light of learning was kept burning only in monasteries, and in them more and more faintly as they became more or less isolated units exposed to attack by ruthless foes or living in continual dread of such attack. Though the barbarians absorbed the old culture in various degrees of imperfection, yet the four centuries following the death of St Augustine were plunged in intellectual darkness, relieved by transitory gleams of light in Britain and by a more enduring flame in Ireland. The utmost that could be done was to preserve to some extent the heritage of the past. This, indeed, was essentially the work of men like Boethius, Cassiodorus, Isidore and Bede.

During these same centuries another process had been advancing with accelerating steps. This was the modification of the Latin language. In the early centuries of Christianity literary Latin was already very different from colloquial Latin, especially in the provinces; and, as has been said, the literary output of the last age of Paganism was marked by sterility of thought and meretricious redundancy of expression. On the other hand, the writings of Christianity show a real living force seeking to find appropriate expression in new forms. Thus, with Christian writers, slavish imitation of the past gradually gave way to the evolution of a new and living Latin, which showed itself more and more regardless of classical models. To express the new ideas to which Christianity gave birth fresh words were coined, or borrowed from colloquial speech or from the Hebrew and Greek Scriptures. This Christian Latin was a real living instrument of expression, which conformed itself in its structure much more closely to the mode of thought and expression of actual life than did the artificial imitation of antiquity in which the literary productions of Paganism were clothed. It is the Latin in which St Jerome wrote the Vulgate. But with the obscuring of culture during the barbarian invasions this current Latin became more and more oblivious of even such elements of form as grammatical inflexions and concords.

It was to the reformation of this corrupt Latin by a return to classical models, and to the more general spread of culture, especially among clergy and nobles, that the Carolingian revival addressed itself. The movement was essentially practical and conservative. Alcuin (735-804), who was Charlemagne's educational adviser and chief executive officer in scholastic matters, was probably the best scholar of his time, and himself loved the classical writings with which he was acquainted; but the text-books he wrote were but imperfect summaries of existing compendia, and the intellectual condition of his pupils forbade a very generous literary diet even had he thought it desirable, of which there is some doubt. The most valuable outcome of the movement was the establishment

Effect of the barbarian invasions.

Modification of Latin.

The Carolingian revival.

of the palace school, and of bishops' schools and monastic schools throughout the empire. Of these the latter were the most important, and each of the chief monasteries had from the time of Charlemagne an external school for pupils not proposing to enter the order as well as an internal school for novices. Thus, the educational system north of the Alps was pre-eminently ecclesiastical in its organization and profoundly religious in its aims. For two centuries the new intellectual life was obscured by the troubled times which followed the death of Charlemagne, but the learning which the Carolingian revival had restored was preserved here and there in cathedral and monastic schools, and the sequence of well-educated ecclesiastics was never altogether interrupted.

The scope of that learning was comprised within the seven liberal arts and philosophy, on the secular side, together with some dogmatic instruction in the doctrines of the Church, the early fathers, and the Scriptures. Theology was as yet not organized into a philosophical system: that was the great work the middle ages had to perform.

The seven liberal arts (divided into the *Trivium*—grammar, dialectic, rhetoric; and the more advanced *Quadrivium*—geometry, arithmetic, music, astronomy) were a legacy from old Roman education through the transition centuries. They appear in the *Disciplinarum libri IX.* of Varro in the 2nd century B.C., where are added to them the more utilitarian arts of medicine and architecture. But they reached the middle ages chiefly through the summaries of writers in the transition centuries, of which the best known were the *De nuptiis Philologie et Mercurii* of the Neo-platonist Martianus Capella, who wrote probably early in the 5th century; the *De artibus ac disciplinis liberalium litterarum* of the Christian Cassiodorus (468-562); and the *Etymologiarum libri XX.* of St Isidore of Seville (570-636).

The scope of the arts was wider than their names would suggest in modern times. Under grammar was included the study of the content and form of literature; and in practice the teaching varied from a liberal literary culture to a dry and perfunctory study of just enough grammar to give some facility in the use of Latin. Dialectic was mainly formal logic. Rhetoric covered the study of law, as well as composition in prose and verse. Geometry was rather what is now understood by geography and natural history, together with the medicinal properties of plants. Arithmetic, with the cumbersome Roman notation, included little more than the simplest practical calculations required in ordinary life and the computation of the calendar. Music embraced the rules of the plain-song of the Church, some theory of sound, and the connexion of harmony and numbers. Astronomy dealt with the courses of the heavenly bodies, and was seldom kept free from astrology. In philosophy the current text-books were the *De consolatione philosophiæ* of Boethius (470-524), an eclectic summary of pagan ethics from the standpoint of the Christian view of life, and the same writer's adapted translations of the *Categories* and *De interpretationibus* of Aristotle and of Porphyry's *Introduction to the Categories*.

It is evident that though such a scheme of studies might in practice, during ages of intellectual stagnation and general ignorance, be arid in the extreme, it was capable in time of revival of giving scope to the widest extension of culture. It was, indeed, at once comprehensive and unified in conception, and well adapted to educate for the perfectly definite and clear view of life which the Church set before men.

In the 11th century Europe had settled down, after centuries of war and invasion, into a condition of comparative political stability, ecclesiastical discipline, and social tranquillity: the barbarians had been converted, and, as in the case of the Normans, had pressed to the forefront of civilization; civic life had developed in the fortified towns of Italy, raised as defences against the pressure of Saracen and Hungarian invasions. Soon, communication with the East by trade and in the Crusades, and with the highly cultivated Moors in Spain, further stimulated the new burst of intellectual life. Arabic renderings of some of the works of Aristotle and

commentaries on them were translated into Latin and exercised a profound influence on the trend of culture. A new translation of Aristotle's *Metaphysics* appeared in 1167, and by the beginning of the 13th century all his physical, metaphysical and ethical treatises were available, and during the next half century the translations from Arabic versions were superseded by renderings direct from the original Greek. As expositions of the real doctrines of Aristotle the translations from the Arabic left much to be desired. Renan calls the medieval edition of the *Commentaries of Averroës* "a Latin translation of a Hebrew translation of a commentary made upon an Arabic translation of a Syriac translation of a Greek text." The study of such works often led to the enunciation of doctrines held heretical by the theologians, and it was only when the real Aristotle was known that it was found possible to bring the Peripatetic philosophy into the service of theology.

There were thus two broad stages in the educational revival commonly known as scholasticism. In the first the controversies were essentially metaphysical, and centred round the question of the nature of universals; the orthodox theological party generally supporting realism, or the doctrine that the universal is the true reality, of which particulars and individuals are only appearances; while the opposite doctrine of nominalism—that universals are "mere sounds" and particulars the only true existences—showed a continual disposition to lapse into heresies on the most fundamental doctrines of the Church. The second stage was essentially constructive; the opposition of philosophy to theology was negated, and philosophy gave a systematic form to theology itself. The most characteristic figure of the former period was Abelard (1070-1142), of the latter St Thomas Aquinas (1225-1274). The former knew little of Aristotle beyond the translations and adaptations of Boethius, but he was essentially a dialectician who applied his logic to investigating the fundamental doctrines of the Church and bringing everything to the bar of reason. This innate rationalism appeared to bring theology under the sway of philosophy, and led to frequent condemnations of his doctrines as heretical. With St Thomas, on the other hand, the essential dogmas of Christianity must be unquestioned. In his *Summa theologias* he presents all the doctrines of the Church systematized in a mould derived from the Aristotelian philosophy.

It is evident, then, that during the period of the scholastic revival, men's interests were specially occupied with questions concerning the spiritual and the unseen, and that the great instrument of thought was syllogistic logic, by which consequences were deduced from premises received as unquestionably true. There was a general acceptance of the authority of the Church in matters of belief and conduct, and of that of Aristotle, as approved by the Church, in all that related to knowledge of this world.

Before the rediscovery of Aristotle exerted such a general influence on the form of education, there was a real revival of classical literary culture at Chartres and a few other schools, and John of Salisbury (d. 1182) in his *Metalogicus* advocated literature as an instrument of education and lamented the barrenness of a training confined to the subtleties of formal logic. But the recrudescence of Aristotle accelerated the movement in favour of dialectic, though at the same time it furnished topics on which logic could be exercised which only a bare materialism can esteem unimportant. The weaknesses of the general educational system which grew up within scholasticism were that haste to begin dialectic led to an undue curtailment of previous liberal culture, and that exclusive attention to philosophical and theological questions caused a neglect of the study of the physical world and a disregard of the critical functions of the intellect. Doubtless there were exceptions, of which perhaps the most striking is the work in physical science done at Oxford by Roger Bacon (1214-1294). But Albertus Magnus (1193-1280), the master of St Thomas, was also a student of nature and an authority for his day on both the natural and the physical sciences. And the work of Grosseteste (d. 1253), as chancellor of the university of Oxford, shows that care for a liberal literary

The medieval curriculum.

Scholastic education.

culture was by no means unknown. Always there were such examples. But too often boys hastened to enter upon dialectic and philosophy as soon as they had acquired sufficient smattering of colloquial Latin to engage in the disputes of the schools. A deterioration of Latin was the unavoidable consequence of such premature specialization. The seven liberal arts were often not pursued in their entirety, and students remained satisfied with desiccated compendia of accepted opinions. Thus the encyclopaedias of general information which were in general use during the middle ages show little or no advance in positive knowledge upon the treatment of similar subjects in Isidore of Seville.

The services of scholasticism to the cause of education, however, cannot well be overestimated, and the content of scholastic studies was in fundamental harmony with the intellectual interests of the time. Above all other benefits owed by future ages to scholasticism is the foundation of the universities of western Europe. The intellectual activity of the 11th century led everywhere to a great increase in the number of scholars attending the monastic and cathedral schools. Round famous teachers, such as Abelard, gathered crowds of students from every country. In the 12th century the need for organizing such bodies of teachers and students was imperative, and thus the earlier universities arose in Italy, France and England, not by deliberate foundation of secular or ecclesiastical ruler, but as spontaneous manifestations of the characteristic medieval impulse to organize into institutions. Afterwards, charters conferring powers and privileges were sought from both Church and state, but these only confirmed the self-governing character the universities had borne from the first. Each of the early universities was a specialized school of higher study: Salerno was a school of medicine; Bologna was the centre of that revival of Roman law which wrought so profound an effect upon the legal systems of France and Germany towards the close of the medieval period. But the greatest of medieval universities was that of Paris, emphatically the home of philosophy and theology, which was the model upon which many other universities, including Oxford and Cambridge, were organized.

The German universities were of later origin, the earliest being Prague (1348) and Vienna (1365). They indicate the more recognized position the movement had attained; for nearly all were founded by the civic authority, and then obtained the recognition of the Church and charters from the emperor.

The concentration of higher instruction in universities was not antagonistic to the medieval conception of the Church as the teacher of mankind. University life was modelled on that of the cloister, though the monastic ideal could not be fully realized, and the scholars not infrequently exhibited considerable licence in life. This was inevitable with the very large numbers of the scholars and the great variations of age among them. Moreover students, and to a less extent teachers, passed from university to university, so that the universities of medieval Europe formed a free confederacy of learning in close relation to the Church but untrammelled by state control. Nevertheless, they were less definitely ecclesiastical than the cathedral seminaries which they largely supplanted, and the introduction of studies derived from the Greeks through the Arabians led to an increased freedom of thought, at first within authorized limits, but prepared, when occasion served, to transcend those limits.

The scheme of instruction was arranged on the assumption that special studies should be based on a wide general culture. Thus of the four faculties into which university teaching was organized, that of arts, with its degrees of *Baccalawreol* and *Magister*, was regarded as propaedeutic to those of theology, law and medicine. It often included, indeed, quite young boys, for the distinction between grammar school and university was not clearly drawn. Attention was concentrated on those subjects which treat of man and his relations to his fellow-men and to God, and no attempt was made to extend the bounds of knowledge. The aim was to pass on a body of acquired knowledge regarded as embracing all that was possible of attainment, and the authority of Aristotle in physics as well as in philosophy, and of Galen and Hippocrates

in medicine was absolute. The methods of instruction—by lecture, or commentary on received texts; and by disputation, in which the scholars acquired dexterity in the use of the knowledge they had absorbed—were in harmony with this conception, and were undoubtedly thoroughly well suited to the requirements of an age in which the ideal of human thought was not discovery but order, and in which knowledge was regarded as a set of established propositions, the work of reason being to harmonize these propositions in subordination to the authoritative doctrines of the Church.

Such an extension of the means of higher education as was given by the universities was naturally accompanied by a corresponding increase in schools of lower rank. Not only were there grammar schools at cathedral and collegiate churches, but many others were founded in connexion with chantries, and by some of the many gilds into which medieval middle-class life organized itself. The Dominican and Franciscan friars were enthusiastic promoters of learning both in universities and in schools, and in the Netherlands the Brethren of the Common Life, founded by Gerard Groot and approved by Eugenius IV. in 1431, regarded school teaching as one of their main functions, and the promotion of learning by the multiplication of manuscripts as another. The curriculum was represented broadly by the *Trivium*. The greatest attention was paid to grammar, which included very various amounts of reading of classical and Christian authors, the most commonly included being Virgil, parts of Ovid and Cicero, and Boethius. The text-books in grammar were the elementary catechism on the eight parts of speech by Donatus, a Roman of the 4th century, said to have been the tutor of St Jerome, and the more advanced treatise of Priscian, a schoolmaster of Constantinople about A.D. 500, which remained the standard text-book for over a thousand years. In rhetoric Cicero's *De oratore* was read, and dialectic was practised, as in the universities, by means of disputations.

In addition to the grammar schools were writing and song schools of an elementary type, in which instruction was usually in the vernacular. Girls were taught in women's monasteries and in the home, and those of the upper classes at least very generally learned to read, write and keep accounts, as well as fine needlework, household duties and management, and such elementary surgery and medicine as served in cases of slight daily accidents and illnesses. Even those boys and girls who did not receive formal scholastic instruction were instructed orally by the parish priests in the doctrines and duties of the Faith; while the pictures and statues with which the churches were adorned aided the direct teaching of sermons and catechizing in giving a general knowledge of Bible history and of the legends of the saints.

No doubt, in times of spiritual and intellectual lethargy, the practice fell short of the theory; but on the whole it may be concluded that in medieval times the provision for higher instruction was adequate to the demand, and that, relatively to the culture of the time, the mass of the people were by no means sunk in brutish ignorance. Indeed, especially when the paucity of books before the invention of printing is borne in mind, the number of people who could read the vernacular, as evidenced by the demand for books in the vulgar tongue as soon as printing made them available, is clear proof that the latter part of the middle ages was by no means a time of general illiteracy.

Feudalism, the other characteristic aspect of medieval society, had also its system of education, expressing its own view of life, and preparing for the adequate performance of its duties. This was the training in chivalry given to pages and squires in the halls and castles of the great. Hallam has well said: "There are, if I may so say, three powerful spirits which have from time to time moved over the face of the waters, and given a predominant impulse to the moral sentiments and energies of mankind. These are the spirits of liberty, of religion and of honour. It was the principal business of chivalry to animate and cherish the last of these." And this was not in opposition to the spirit of religion which animated the scholastic education which went on side by side

University work and life.

Medieval schools.

Education of chivalry.

with it. Throughout chivalry was sanctified by the offices of the Church. The education of chivalry aimed at fitting the noble youth to be a worthy knight, a just and wise master, and a prudent manager of an estate. Much was acquired by daily experience of a knightly household, but in addition the page received direct instruction in reading and writing; courtly amusements, such as chess and playing the lute, singing and making verses; the rules and usages of courtesy; and the knightly conception of duty. As a squire he practised more assiduously the knightly exercises of war and peace, and in the management of large or small bodies of men he attained the capacity of command.

With the unification of existing knowledge and the systematization of theology the constructive work of scholasticism was done. At the same time the growth of national feeling was slowly but surely undermining feudalism.

Moreover, deep resentment was accumulating throughout western Europe against the practical abuses which had become prevalent in the Church, and especially in the court of Rome and in the prince-bishops of Germany. In short, Europe was out-growing medieval institutions, which appeared more and more as empty forms unable to satisfy the needs and longings of the human soul. In such conditions, the customary and traditional education of school and university tended to lose touch more and more completely with the new aspirations and views of life which were everywhere gathering adherents among the keenest and most active intellects. Had a new cultural movement not begun, the education of Europe threatened to become as arid as the rhetorical education of the last centuries of the Roman empire had been. From this it was saved by the renaissance of classical studies which began in the 14th century.

Italy, by its greater wealth and its more intimate commerce with the eastern empire, was the seed-plot of this new tree of

The Renaissance.

knowledge. Ever since the 11th century the cities of northern Italy had been in advance of Europe beyond the Alps both in culture and in material progress. The old classical spirit and the feeling of Roman citizenship had never quite died out, and the *Divina Commedia* of Dante (1265-1321) furnishes evidence that the poet of the scholastic philosophical theology was also a keen student and lover of the old Latin poets. But the greatest impulse to the revived study of the classics was given by Petrarch (1304-1374) and Boccaccio (1313-1375). Generally throughout western Europe the 14th century, though full of war and political unrest, was a time of considerable intellectual activity, shown in the increase of schools and universities, as well as in the literary and artistic revival in Italy, in the social and theological movement in England and Bohemia associated with the names of Wycliffe and Huss, and in the more or less perfect substitution of Roman law everywhere except in England for the law of custom which had hitherto prevailed.

But it was the literary movement which most affected education, and indeed the whole life of Europe. A decisive step was taken when Manuel Chrysoloras was invited to teach Greek in the university of Florence in 1397. The enthusiasm for classical culture, to which Petrarch had given so great an impetus, gathered force and extended over the whole of Italy, though, of course, felt only by a select few and leaving the mass of the people little, if at all, affected. From Italy it spread gradually to countries north of the Alps. In the old writers men found full expression of that new spirit of self-conscious freedom which was vaguely striving for expression throughout the whole of Christendom. In the free political atmosphere of the Italian communes, with their wealthy and leisured merchant class, that spirit could flourish much more readily than in the feudalized Europe across the Alps. Moreover, the antique spirit was in direct line of ancestry with that of medieval Italy. Thus, for a couple of centuries, Italy stood in the van of European culture.

The stages of the movement cannot be traced here: suffice it to say it showed itself especially in an enthusiastic search for manuscripts, followed by their multiplication and wider dis-

tribution; in an intense devotion to literary form, in a revival of classic taste in architecture; in a wonderful development of painting and sculpture from symbolism of spiritual qualities towards naturalism and romanticism; in a return to Platonism in philosophy; in a contempt, often unreasoning and wanting a foundation in knowledge, for the scholastic Aristotelian philosophy itself, and not simply for the trivialities into which its actual exercise had so commonly degenerated. The invention of printing necessarily gave the movement both a stronger and a wider influence than it could otherwise have attained. And in its search after knowledge it was in full harmony with the spirit of adventure which marked the age, and by the discovery of the New World wrought so profound a change in the relative importance and prosperity of the countries of western Europe.

It is the spirit of the movement which is of interest to the student of education. And that spirit was essentially one of opposition to authority and of assertion of individual liberty, which worked itself out in various forms among peoples of different temperaments. In Italy the form was literary and artistic, and the full development of the Renaissance spirit was seen in a practical Paganism which substituted the attractions of art for the claims of religion and morality, and eventuated in deep and widespread immorality and a contemptuous tolerance of the outward observances of religion without faith in the doctrines they symbolized. The movement became an attempt to reconstitute the past intellectual life of Italy, and, as such, was foredoomed to sterility as soon as the work of re-discovery was completed; for the revived forms were not inspired with the vital spirit which had once made them realities, and consequently men's minds once again were occupied with mere verbal subtleties. The really valuable service of the Italian humanists to Europe was the restoration to man of the heritage of knowledge which he had allowed to slip from his grasp, and the leading the way to a freer intellectual atmosphere. In Germany the spirit manifested itself in a rebellion against the doctrinal system of the Church as the only effectual means of attaining reform of ecclesiastical abuses. The Protestant reformation of Luther was the real German outcome of the Renaissance. In no other country of Europe did the movement take so distinctive a form.

It was, then, not merely the revival of interest in classical studies which so profoundly affected the life and education of western Europe. It was rather that in those literatures men found a response to intellectual and moral cravings which had been blindly gathering force for generations, and which found themselves formulated and objectified in the writings which set forth the Pagan view of life with its assumption of the essential worth and self-reliance of the individual and its frank delight in all the pleasures of existence. It was, in short, in proportion as men not only found delight in Pagan literature but returned in essence to the Pagan view of individual worth and the supremacy of the human intellect, that the Church realized the danger to herself which lurked in the new movement.

At first the revival of interest in the classical literatures did not show any antagonism to Catholic faith and practice, and its warmest supporters were faithful sons of the Church. The view of the relation of classical literature to Christianity adopted by the great humanist schoolmaster Vittorino da Feltre (1378-1446) was broadly that of the early Fathers, and in his school at Mantua he showed that culture was not inconsistent with loyalty to the Church or with purity of life. With him classical literature was not the end and sum of education, but was a means of implanting ideas, of developing taste, and of acquiring knowledge, all as helps and ornaments of a Christian life. Though Pagan literature was the means of education, the Pagan spirit had not supplanted that of Christianity. The school at Mantua may, indeed, be said to have exhibited in practice a Christianized application of the doctrines of Quintilian and Plutarch.

So was it in the other countries of Christendom. In the Netherlands the Brethren of the Common Life introduced humanistic studies into their schools side by side with definite religious teaching and observances and their work was always

dominated by the Christian spirit. The earlier German humanists, such as Nicholas de Cusa, Hegius, Agricola and Wimpeling, adopted the same attitude, and Erasmus himself, bitterly as he attacked the practical abuses of the Church, remained in communion with it, and aimed at harmonizing classical culture with the Christian life. In England the same love of culture combined with devotion to the Church was seen in Selling, prior of Christ Church, Canterbury, the first real English humanist, in Grocyn, Linacre, More, Fisher, Colet and many others whose enthusiasm for culture was as undoubted as was their loyalty to Catholicism. It seemed, then, at first as if the greatest educational effect of the classical revival would be the deepening of literary culture, and the substitution of real inquiry for dialectic subtleties in the courses of schools and universities, without any break with established religious teaching. It is true that the majority of schools were but little affected, and many of the universities had given but a half-hearted welcome to humanistic studies when the religious revolt in Germany under the leadership of Luther threw the whole of Europe into two hostile camps. But even the conservative university of Paris—the headquarters of scholastic philosophical theology—had permitted the teaching of Greek as early as 1458, and both Oxford and Cambridge had welcomed the new studies. That the influence of the new movement for classical study was gradually permeating the schools is shown not only by the practice of the Brethren of the Common Life but by the curriculum laid down by the statutes of the schools refounded by Wolsey at Ipswich and by Colet at St Paul's.

The immediate effect of the religious controversies of the 16th century on education was emphatically, if unintentionally, disastrous. The secularization of ecclesiastical property too often absorbed the endowments of the schools, so that, both in Germany and in England, the majority of grammar schools either disappeared or continued a starved existence with diminished funds, the doctrine of salvation by faith alone and the futility of good works dried up the source from which such endowments had flowed, the violent fulminations of the German reformers against the universities as the homes of the hated scholastic theology and philosophy found an echo in minds fired with the renaissance enthusiasm for poetry and oratory, and correlative distaste for the more severe and abstract speculations of logic and philosophy, which expressed itself in abstention from those seats of learning; and the preoccupation of men's minds with theological speculations and quarrels led those few who did resort to the universities to neglect their appointed studies and to devote their energies to interminable wrangling over the points in dispute. This decadence in culture was attended by an outbreak of licence and immorality, especially among the young, which called forth violent denunciations from Luther and many of his followers in Germany, and from Latimer and other reformers in England. In some respects these results were only transitory. Humanism and Protestantism, which had so far diverged that Erasmus (1467-1536) had declared that where Lutheranism flourished learning decayed, were brought together again by Melancthon (1497-1560) under whose influence universities were founded or reorganized and schools re-established in Protestant German states; and in England the reign of Elizabeth saw many new educational foundations. But this restoration of the means of education was only partial, and the doctrine of the worthlessness of "carnal knowledge," which led the Barchonies Parliament to propose the suppression of the English universities, was held by many fervent Protestants both in England and in Germany all through the 17th century.

Moreover, the schools established a tradition of curriculum and instruction which ignored the new directions of men's thoughts and the new view of knowledge as something to be enlarged, and not merely a deposit to be handed down from generation to generation. The later humanist theories of education, which the schools continued to follow generally for over two centuries, and in many cases for another hundred years after that, were drawn mainly from Erasmus and

Melancthon, who found in the classical languages and literatures, and especially in Latin, the only essential instruments of education. General knowledge of natural facts might be desirable to the cultured man as ornaments to his rhetoric, but it was to be sought in the writings of antiquity. Even so revolutionary a thinker on education as Rabelais (1495-1553) with all his demand for an encyclopaedic curriculum, held the writings of the ancients as authoritative on natural phenomena. Melancthon, whose conception of instruction was much narrower, exercised enormous influence in the moulding of Protestant universities and secondary schools, both directly and through such disciples as Trotsendorf and Neander, but especially through his friend Sturm (1507-1580), whose Latin gymnasium at Strassburg became the model which the grammar schools of Protestant Europe strove to imitate. In this school nearly the whole of the energies of the boys was given to acquiring a mastery of the Latin language after the model of Cicero. Sturm, indeed, did not go to the extreme length of the Ciceronians, opposed and satirized by Erasmus, who would allow no word or construction which could not be found in the extant writings of their master, but a like spirit dominated him.

In Catholic countries the Church retained control of education. The practical reformation of abuses by the Council of Trent, and the energy and skill of the Society of Jesus, founded by St Ignatius Loyola, in 1534, brought back most of south Germany into the fold of the Church. Everywhere Catholic universities were mainly taught by Jesuit fathers; and under their influence, scholasticism, purged from the excretions which had degraded it, was restored, and continued to satisfy the longings of minds which felt the need of an authoritative harmonizing of faith and knowledge. Everywhere the society established schools, which, by their success in teaching and the mildness of their discipline, attracted thousands of pupils who came even from Protestant homes. Their curriculum was purely classical, but it was elaborated with much skill, and the methods of instruction and discipline were made the subject of much thought and of long-continued experiment. In the methods thus determined all Jesuit fathers were trained, so that the teachers in Jesuit schools attained a degree of skill in their art which was too generally wanting elsewhere.

So long as Latin remained the language of learning, and new fields of knowledge were not appropriated, the schools remained in harmony with the culture of their time, though, as Mulcaster (1530-1611) pointed out, such a training was not of value to the majority of boys. For them he urged an elementary education in the vernacular; but neither in this nor in his advocacy of the training of teachers was his advice followed.

In the 17th century the dislocation between the Latin schools and the needs of life began to be accentuated as Latin gradually ceased to be the language of learning; and, as a consequence, the numbers attending the schools decreased, and the mass of the people sunk continually lower in ignorance. In vain Hooke urged the establishment of a universal system of elementary schools giving instruction in the vernacular, Petty put forth his plan for elementary trade schools, and Cowley proposed the establishment of a college devoted to research. Ideas of reform were in the air, but the main current of scholastic practice flowed on unaffected by them. Some attention was, indeed, paid to the conservative reforms advocated by the Port Royalists, of which the most important was the inclusion of the vernacular as a branch of instruction, but the cry for more fundamental changes based on the philosophy of Bacon was unheeded. Of these, none was a more active propagandist than Comenius (1571-1635). Unfortunately his *Great Didactic*, in which he set forth his general principles, attracted little attention and won less adherence, though his school books, in which he attempted with very little success to apply his principles, were widely used in schools. But these were little more than bald summaries of real and supposed facts, stated in Latin and the vernacular in parallel columns. In content they differed from such medieval summaries of knowledge as the well-known work of Bartholomew Anglicus, which had been

Immediate influence of the Reformation on education.

The Society of Jesus.

Early proposals for reform.

Protestant schools.

widely used since the 13th century, chiefly by their greater baldness and aridity of statement.

In the universities, too, the 16th and 17th centuries saw a continuous decadence. The 16th century was not ripe for

*Decadence
of univer-
sities.*

real intellectual freedom; and Protestantism, having based its revolt on the right of private judgment, soon produced a number of conflicting theological systems, vying with each other in rigidity and narrowness, which, as Paulsen says, "nearly stifled the intellectual life of the German people." Further, the idea of national autonomy, which exercised so great an effect on the politics of the time, included the universal adherence of the citizens to the religion of the state. Hence, till the end of the 17th century the universities of Protestant Europe were regarded mainly as instruments for securing adherence to the national theological system on the part of future clergy and officials, and the state interfered more and more with their organization and work. Theology occupied the most important place in the higher studies pursued, which for the rest differed little in content and less in spirit from those of preceding centuries, except that more attention was paid to the study of classical literature. Even that decayed into formal linguistics as the Renaissance enthusiasm for poetry and oratory died out, and interest in logical and philosophical questions, fostered by the dominance of dogmatic controversial theology, again became dominant. In Paris, on the other hand, the faculty of theology had decayed through the withdrawal of those preparing for the priesthood into episcopal seminaries, and the higher studies pursued were mainly law and medicine. Thus, generally, the universities were less and less fulfilling the function of providing a general liberal education. Another change, due to the same causes and making for the same results, was the isolation of universities, often directly fostered by the state governments, which for the universal interchange of medieval thought substituted a narrow provincial culture and outlook. It is no wonder that numbers everywhere decayed and that complaints as to the habits of the students were loud and frequent.

At the close of the 17th century, then, universities as well as schools had reached a very low level of efficiency and were held in little respect by the cultured. Indeed, from the middle of the century, the main current of intellectual life had drifted away from the orthodox centres of learning. The formation of the Berlin Academy in Germany and of the Royal Society in England, and the refusal of Leibnitz to accept a chair in any German university, were signs of the times. In France, and later in Germany, the education of the noble youth was increasingly carried on apart from the schools, and was really an outgrowth from the education of chivalry. In the 16th century Castiglione and Montaigne had advocated a training directly adapted to prepare for polite life, and Elyot wrote on similar lines. But the most important movement in this direction was the formation of the courtly academies which flourished in France in the 17th century, and were soon imitated in the *Ritterakademien* of Germany. In these schools of the nobility French was more honoured than classics, and the other subjects were chosen as directly adapted to prepare for the life of a noble at the court. Milton in his *Treatise* advocated the foundation of such academies in England, though he proposed a curriculum far more extensive than had ever been found possible. More and more, too, foreign travel had, from the middle of the 16th century, been looked upon as a better mode of finishing the education of a gentleman than a course at a university.

The later years of the 17th century saw a revival of university life in Cambridge, through the work of Newton and the increasing attention paid to mathematics and the physical sciences, though the number of students continued very small. In Germany, also, a new era opened with the foundation of the universities of Halle (1604) and Göttingen (1737), which from the first discarded the old conception that the function of a university is to pass on knowledge already complete, and so opened the door of the German

universities to the new culture and philosophy. It was soon seen that students could thus be attracted, and the influence spread to the other German universities, which by the end of the 18th century had regained their position as homes of the highest German thought.

At Halle, too, was set the example by Francke of providing for the education of the children of the poor, and to his disciple Hecker Germany owes the first *Realschule*. Simultaneous movements for the education of the poor were made by St Jean-Baptiste de Salle and the Brothers of the Christian Schools in France, and by the Society for the Promotion of Christian Knowledge in England. But the total results were not great; the mass of the people in every European country remained without schooling throughout the 18th century.

The intellectual movements of that century were, indeed, essentially aristocratic. Voltaire and the Encyclopaedists aimed at the enlightenment of the select few, and Rousseau declared baldly that the poor need no education. That these movements influenced education profoundly is undoubted. The individualistic and abstract rationalism of Voltaire, derived from the sensationist philosophy of Locke through the more thorough-going Condillac, and finding its logical outcome in the materialistic atheism of La Mettrie and the refined selfishness of Rochefoucault, infected the more cultured classes. In Lord Chesterfield's *Letters to his Son* is shown its educational outcome—a veneer of superficial culture and artificial politeness covering, but not hiding, the most cold-blooded selfishness. Against this fashionable artificiality, as well as against the obvious social and political abuses of the time, Rousseau's call for a return to nature was a needed protest.

Rousseauism, however, was not merely a transitory revolt against a conventionality of life that had become unbearable; it was emphatically the voicing of a view of life and of education which has profoundly influenced Europe ever since. In that Rousseau (1712-1778) attempted to look at life as a whole he was not truer ground than were the intellectualists of the "Enlightenment"; but in that he found the essence of life in the gratification of the desires and impulses of the moment, he enunciated a doctrine which banished high principle and strenuous effort from life and consequently from education. In the *Émile* is presented a purely fantastic scheme of education based on a psychology of development so crude as to be absolutely false, and producing a young man utterly unable to guide his own life or to control his emotions and impulses. Rousseauism is, indeed, in its essence the application to education of the doctrines of naturalism—the philosophy which regards human life as a mere continuation of physical process, and consequently as determined wholly by environment. So Rousseau would abolish all moral training and leave the child to the reactions of the physical world upon his actions.

Against this position the educational teaching of Kant (1724-1804), influenced though he was by the *Émile*, is essentially a protest. The most necessary element in education, according to Kant, is constraint, which by the formation of habit prepares the young to receive as principles of conduct the laws at first imposed upon them from without. And the supreme guide of life is the law of duty which is always more or less opposed to the promptings of inclination. Kant exaggerates the dualism: Rousseau would abolish it by ignoring the more important of the two antitheses.

The French Revolution—the natural outcome of the teachings of Voltaire and of Rousseau—was the second stage in the movement of which the Reformation was the first. It was essentially the assertion of the natural rights of man, and, as a logical sequence, of the right of every child to be properly trained for life. The reaction due to the excesses of the revolutionists no doubt delayed the acknowledgment for a time, but its gradual recognition is emphatically the characteristic mark of the educational history of the 19th century.

*Education
of the
poor.*

*18th-
century
thought
and
education.*

*Rousseau-
ism.*

Kant.

*Educational
(social)
outcome
of the
Revolution.*

Preached and practised by Pestalozzi (1746-1827) in Switzerland, the general education of the poor was first made a reality by Prussia after the crushing defeat of Jena. In France and England it remained for nearly three-quarters of the century the work of the Church and other voluntary agencies, though aided by the state. Finally a state system of schools has been more or less fully set up in every state of western Europe and in America, and subjected to more or less state regulation and control. Equally marked has been the growing care for the scholastic education of girls as well as boys, though only in America are the two regarded as practically identical in form and content.

Thus the 19th century saw the final working out of the idea that the state should be substituted for the Church as the official agent of education, an idea which had its roots in the Renaissance conception of the right of man to direct his life apart from theological determinations. The more direct outcome of the same idea is apparent in the absolute liberty with which the presuppositions of knowledge are questioned, and the maxim of Descartes—to prove everything by the reason and to accept nothing which fails to stand the test—is acted upon. No greater contrast is possible than that between the medieval student and the modern searcher after truth.

The influence of the same spirit has wrought an equally momentous change in the methods of instruction. The impetus given by the exaggerated doctrine of Rousseau to the view that the nature of the child should determine the means of education, led to more thorough-going attempts than had hitherto been made to base educational method on a knowledge of child psychology. Pestalozzi and Froebel (1782-1852), by their insistence on the need of educating a child through his own activity, and by their widespread influence, made the new view of method an actuality. The influence of Rousseau has, thus, passed into modern educational practice in a form that, in its essence, is true, though in practice it has shown itself apt to run into the same excess of emphasis on impulse and feeling which vitiated the teaching of Rousseau himself. The influence of Herbart (1776-1841) has tended to counteract this. The essence of Herbartianism is that mental life consists of presentations, or reactions of the mind on the environment, and that will springs from the circle of thought thus developed. The emphasis is therefore placed on intellect and instruction while in Froebelianism it is placed on spontaneous activity and on the arrangement of the environment. Each exaggerates the function of the one factor in concrete experience which it makes the centre of interest, and each is tinged with the individualistic conception of life which characterized the 18th and early 19th century.

The most marked change in the outward aspect of education has been the modification of the curriculum of school and university by the introduction of various branches of natural science. Conjointly with this has been much increase of specialization, and that not only in the university but in the school. There is no longer a universally recognized circle of knowledge constituting a liberal education preparatory to specialist studies, as there was in the middle ages. Nor is there general agreement as to what such educational institutions as schools and universities should attempt to do, or even as to the end that should be sought by education as a whole. Nor can agreement on such points be expected while men differ widely as to the meaning and purpose of life. The work of the organization of the material means of education has largely been accomplished by the civilized world: that of determining the true theory and practice of the educative process itself is still incomplete. To that, both discussion of the philosophy of life and of the relative values in life, of various kinds of experience and experiment in the light of the conclusions reached, are needed. The problem will never be absolutely solved, for that would imply an absolutely best education irrespective of conditions, but its practical solution will be reached when a true adjustment is made between the process of education and the life for which that education is intended to be a preparation.

See also the articles ACADEMIES; CLASSICS; CO-EDUCATION; EXAMINATIONS; POLYTECHNIC; SCHOOLS; TECHNICAL EDUCATION; UNIVERSITIES; WOMEN; &c. (J. W.K.)

II. NATIONAL SYSTEMS OF PUBLIC EDUCATION

A statement of the principles commonly recognized by modern communities as governing the action of the state in relation to education may facilitate at the outset a clearer understanding of the problems which the organization of public education presents. The cardinal doctrine of state interference in the educational domain is universally accepted by all the great nations of the modern world; and in regard to its extent and limits a large measure of agreement has now been reached.

In the first place, it is recognized as the duty of the state to insist upon a certain minimum of education for every future citizen. This does not necessitate a monopoly of education on the part of the state, such as was claimed by the Napoleonic despotism under the traditional influence (it would seem) of the old authoritative Gallo-Roman tradition, transformed in its outward manifestation but not in its inward spirit by the French Revolution. Such a monopoly would be plainly repugnant to the spirit of Anglo-Saxon individualism, and it is interesting to note that attempts to reassert it have in recent times been repudiated in republican France by some of the best exponents of modern free thought, as an infringement of personal liberty not calculated to justify itself by any corresponding public gain. Nevertheless, the recognition of this primary duty of the state plainly implies a state system of at least elementary education. The masses of the industrial population cannot afford the necessary minimum of instruction which the public interest demands, and private and voluntary effort cannot efficiently supply the want resulting from the unequal distribution of wealth. But it is in the nature of things that, so far as private effort attempts anything in this direction, it should be motivated in the main by religion and associated with the great historical religious organizations; thus it comes about that the moment the state steps in to make good the deficiency of voluntary effort a fruitful and embittering source of difficulty and friction is disclosed. Hence, in England, the history of public elementary education since the beginning of the 19th century has been very largely the history of what is called the religious difficulty. Here we find ourselves in the region of acute controversy in which it is useless to do more than note empirically the various solutions adopted by different states. Perhaps all that can safely be indicated as commanding universal acceptance is the principle that the state must not impose upon an individual citizen in the person of his child any form of religious instruction to which he conscientiously objects. Modern controversies show the difficulty of applying even this rudimentary principle to the complicated circumstances of a free community split up into a number of groups differing profoundly in religious sentiment, and zealous each for the recognition of its own ideal within the common system. So far, however, as secular instruction (i.e. the teaching of other subjects than religion) is concerned it is now generally accepted that the elementary minimum must be both compulsory and free for every individual child whose parents will not or cannot (as the case may be) provide such instruction for it efficiently elsewhere than in the state-supported schools.

Next, the action of the modern state cannot stop short at elementary education. The principle of "the career open to talent" is no longer a matter of abstract humanitarian theory, a fantastical aspiration of revolutionary dreamers; for the great industrial communities of the modern world it is a cogent practical necessity imposed by the fierce international competition which prevails in the arts and industries of life. The nation that is not to fail in the struggle for commercial success, with all that this implies for national life and civilization, must needs see that its industries are fed with a constant supply of workers adequately equipped in respect both of general intelligence and technical training.

On political grounds too, the increasing democratization of

institutions renders a wide diffusion of knowledge and the cultivation of a high standard of intelligence among the people a necessary precaution of prudent statesmanship, especially for the great imperial states which confide the most momentous issues of world policy to the arbitrament of the popular voice. The state then must satisfy itself that the means of education are placed within the reach of all, in grades adapted to the varying degrees of intelligence and educational opportunity to be found among a community upon the majority of whose members is imposed the necessity of entering upon the practical business of life at a more or less early age. The organization of the higher grades of education constitutes a task of less formidable magnitude than the organization of elementary education, for the reason that, at any rate in the prevailing social conditions, it is only a minority who can benefit by it, and that of this minority a large proportion can afford the whole or a considerable portion of the cost in each individual case. The class, however, whose education must needs be assisted by the state if it is not to remain inefficient must always be considerable; and account must be taken also of the necessities of the further class whose exceptional mental development is such as to make it worth while for the state to bestow gratuitously an education higher than elementary at the public expense. University education is distinguished from education of the lower grades by the fact that, being necessarily restricted to an élite of intellect or birth, it cannot, save in very exceptional circumstances, usefully be organized locally. Although universities are the necessary complement of a public educational system they do not in strictness or necessity form part of such a system, and in so far as they are brought within the purview of public authority it must be as a matter of national, rather than municipal or provincial, concern. Accordingly university education is separately treated (see UNIVERSITIES), and will not be referred to, save incidentally, in the present article.

Reserving to a final section the history of education in the United States of America, a brief description is given here of the educational systems of the leading European countries by way of introduction to a more detailed, but still summary, historical sketch of public education in England. The highly organized educational systems of France and Prussia (as representing Germany) are manifestly suitable for the purposes of a general study of the principles of educational polity as worked out upon logical and consistently thought-out plans by highly centralized states. As to other European countries, a brief mention must suffice of certain features of special interest presented by smaller progressive states of such different types as Switzerland, Belgium and Holland. Similarly, in the case of the United Kingdom, considerations of space forbid more than a brief notice of the educational systems of Scotland (*q.v.*) and Ireland (*q.v.*). For other countries see the sections in the articles under the headings of the respective states.

France.

France (*q.v.*) presents the most complete type of a state system of education organized under a strongly centralized administration in all grades. This centralized administration in education, as in other departments, represents the Napoleonic heritage of the Republic, and, although there has been an increasing tendency of recent years to study local conditions in the internal organization of schools, anything approaching to local autonomy is unknown in educational affairs. The necessary checks upon bureaucracy are supplied not by popularly elected municipal bodies but by a strong infusion of the pedagogic element in the administrative machinery. The pedagogic element in turn does but represent another side of the collective activities of the state. The teaching profession both in the primary and higher spheres—and the two are sharply marked off from one another—consists of a highly organized body of state functionaries, united by a strong *esprit de corps* and actuated by ideals and aims which are inspired by the state. The importance of this condition of things lies in the fact that the Republic is something more than a form of government: it is the social and moral expression of the democratic ideal as conceived by a people profoundly imbued by tradition with the

sense of social solidarity, or collectivism; and nowhere has this expression been more characteristic or more complete than in the domain of public education. Yet the educational system of modern France is by no means exclusively the creation of the Third Republic, and the main stages in its development deserve to be traced historically.

No historical sketch, however slight, of French education can ignore the great Catholic religious educator of the 18th century, Jean Baptiste de la Salle, the founder of *Les Frères Frères de la Doctrine chrétienne*, commonly known as the *la Doctrine* "Christian Brothers." The Brothers were not merely *christians* pioneers of elementary education, they may also be regarded (as M. Buisson, formerly director of public instruction, has shown) as the originators of higher primary instruction. Under the Restoration they upheld the method of simultaneous teaching against the partisans of the mutual (or monitorial) method, successfully demonstrating the superiority of the trained teacher. The unfortunate effects of the monitorial system upon English education show the reality of the service which this religious congregation rendered to the national pedagogy in France.

The Constitution of 1791 decreed that primary instruction should be compulsory and gratuitous. (It may be explained that the term "free education," *instruction libre*, does not ^{The} bear the same meaning in France as in England. In *Revolution* France a free school means a school not under state ^{and} *Napoleon* control and not forming part of the state system.) In this as in much else the Revolution was powerless to do more than enunciate general principles which it left for later generations, in the present instance after the lapse of nearly a century, to carry into effect. True to its theories of individualistic liberty, the Revolution admitted liberty of teaching. Napoleon, on the other hand, by the law of 1806, centralized all forms of education in one official teaching body under the name of the Imperial University, thus securing a monopoly of teaching to the state. The Napoleonic idea of the university, doubtless because a true expression of the national genius, has never ceased to exert a profound influence upon French education, an influence which of late years has been revived and reinforced by the modern ideal of social solidarity.

Under the Restoration education fell inevitably under the control of the church, but under the Liberal Monarchy Guizot in 1833 passed a law which laid the foundations of modern primary instruction, obliging the communes to maintain ^{Restoration} ^{of Guizot.} schools and pay the teachers. It is also to the credit of Guizot as an educational reformer that he perceived the necessity for the higher primary as distinct from the secondary school. The higher primary schools which he founded were unfortunately suppressed by the *Loi Falloux*; their restoration constitutes one of the great positive services rendered by the Third Republic to the cause of popular education.

The *Loi Falloux* of 1850, passed by the Second Republic under the influence of the prince president, is chiefly memorable for its restoration of the liberty of teaching, which in a Catholic country means in effect free scope for priestly ^{Loi} ^{Falloux.} schools. This law also made provision for separate communal schools for girls, for adult classes and for the technical instruction of apprentices. In 1854 France was divided for purposes of educational administration into sixteen academies, each administered by a rector with an academy inspector under him for each department. This organization survives to-day, with the difference that for each academy (except Chambéry) there is now a local teaching university.

The ministry of the well-known educationist M. Duruy (1865-1869), corresponding to the period of the Liberal Empire, was notable for marked administrative progress. A permanent memorial of this epoch is the enactment ^{Ministry of} ^{M. Duruy.} rendering primary schools for girls obligatory in communes of over 500 inhabitants. Duruy also provided for the introduction of gratuitous instruction at the option of the commune.

The task of educational reform imposed itself upon the republic by a twofold necessity. The wars of 1866 and 1870 were victories for the Prussian schoolmaster, and aroused all western Europe to the national importance of popular education. For France then the reform of popular education was an essential part of the work of national restoration. For the republic too, menaced by older and hostile traditions, the creation of a national system of education inspired by its own spirit was an essential condition of the permanence and security of its government and the social ideals of which that government was the expression. Hence the energy with which the republican state addressed itself to the organization of primary instruction, "obligatory, gratuitous, secular."

By the law of June 1, 1878, there was imposed upon the communes the obligation of acquiring their school buildings; and as a grant in aid a sum of £2,400,000 was set aside for this purpose by the state. In 1879 a law was passed compelling every department to maintain a training college for male and female teachers respectively. The two higher normal schools of Fontenay and St Cloud were also founded to supply the training colleges with professors. During the same period, among other *certificats* or professional diplomas, there were established the *certificat d'aptitude pédagogique*, which qualifies probationer-teachers (*stagiaires*) for appointment as teachers in full standing (*titulaires*), and the *certificat d'aptitude* for primary inspectors and heads of normal schools. The law of June 16, 1881, rendered obligatory for all teachers, whether public or private, the *brevet de capacité*. It was found impracticable to carry this law into immediate effect, and as late as 1902 only about 60 % of the men and 52 % of the women were provided with the professional certificate necessary for becoming *titulaires*.

The laws making primary education gratuitous, compulsory and secular, are indissolubly associated with the name of Jules Ferry. The law of June 16, 1881, abolished fees in all primary schools and training colleges, the law of 1882 established compulsory attendance, and finally the law of October 30, 1886, enacted that none but lay persons should teach in the public schools, and abolished in those schools all distinctively religious teaching. In the boys' schools members of religious communities were to be displaced within five years, but in girls' schools the *religieuses* might remain till death or resignation.

Religious teaching was replaced in the state schools under the Ferry law by moral instruction according to official curricula, a change which has been described by M. Séailles

Moral instruction.

(*Education ou révolution*) as a revolution of the profoundest philosophical meaning. The difficult and delicate topics of the relation of the state school to religion and the value of the substituted moral instruction have recently received illuminating and objective treatment from different points of view in the series of reports on *Moral Instruction and Training in Schools*, edited by Professor M. E. Sadler (1908, vol. ii.); the barest reference to the questions at issue must here suffice. As regards the character of the moral instruction, it would appear to have shifted from a Kantian to a purely sociological basis. Roman Catholic opinion is at least not unanimous in regarding the "lay" or neutral school as essentially or necessarily anti-religious, and plainly there is no inherent reason why the neutrality should not be a real neutrality, but with the existing relations between the Catholic Church and modern thought in France the influence of the Normalist teachers is in fact apt to be anti-religious, and moreover no system of independent moral doctrine, whether based upon *a priori* or inductive reasoning, can be acceptable to the Roman Catholic Church. In whatever degree the blame may be rightly apportionable between church and state, the fact is that the two find themselves in acute conflict, and that from the conflict there has resulted a certain moral confusion which Christian and non-Christian moralists alike view with alarm. It may be that the mischief would have been mitigated had more moderate counsels prevailed at the time of the Ferry law, and had the church been

willing to accept (as the Republic might then have been willing to concede) right of entry for the clergy into the schools. But the real causes of the trouble lie deep in the philosophical and religious problems of our time, and in the constant and self-sacrificing devotion of the French to logical ideals on either side. Perhaps it is not too sanguine to discern in the growing tendency to idealism in French philosophy, and to liberal ideas in French and Catholic religious thought, the promise of a happier state of things. In the meantime, the religious difficulty in the schools divides the nation into two hostile camps (*les deux Frances*, as a Swiss Protestant writer puts it) in the shape of the state secular schools on the one side and the private religious schools on the other.

In the year 1903-1904 the total number of pupils in private primary schools was 1,298,591, as against 4,935,000 in the public primary schools, but these figures were liable to be materially affected by the rigorous enforcement of the laws against the religious orders.

In 1889 an important change was made in educational finance by transferring the cost of teachers' salaries in primary schools from the communes to the state, a right consequence of the changes which made the teacher a state official. Thus the state assumed the greater part of the burden of primary instruction, leaving to the communes merely the cost of fabric, and to the department the maintenance of the fabric of the normal schools and certain expenses of inspection.

At this point it will be convenient to describe shortly the various central and local authorities that constitute the official machine. The minister, the head of the entire hierarchy, is assisted by a *conseil supérieur* consisting of fifty-seven members, of whom the majority are elected by the higher teaching profession, while a few are nominated by the president, including a small number to represent private schools, and a few are elected by the primary teachers. Practically the ordinary work of the council is carried on by a sub-committee consisting of the nine nominees of the president and six others designated for this purpose by the minister. The council has administrative, judicial and disciplinary, as well as advisory, powers which enable it to exert a direct influence upon the internal organization of schools. There is also a pedagogic *comité consultatif* and a legal *comité consultatif*, whose respective functions are purely advisory.

The *inspecteurs généraux* "act," says Mr Brereton in his official report to the English Board of Education, "as the eyes and ears of the central authority." Their duties are: first to inspect the normal schools; next to supervise the work of the ordinary inspectorate; lastly to give general and comparative information on the progress of primary instruction in the various parts of France. For the purpose of general inspection. France is divided into seven districts.

As already indicated, for the purpose of educational administration, the departments of France are grouped in seventeen divisions called academies. At the head of each academy is the rector. He is appointed directly by the president and must hold the doctor's degree. He is not only the head of the local teaching university, but is also charged in a general way with the oversight of all three departments of education, superior, secondary and primary; in regard to the last, however, his functions are confined to the pedagogic side. The direct share of the rector in administration is mainly confined to the normal schools and the higher primary schools. The rector is assisted by an academic council composed almost exclusively of pedagogic elements.

Each department of France has an academy inspector appointed by the minister. The duties of the academy inspector embrace both higher and primary education. In the latter sphere he is the real head of the local administration, and the primary inspectors are his subordinate officers. He appoints the probationer-teachers and nominates the regular teachers for appointment by the *préfet*.

Acquisition of elementary school buildings and organization of teaching profession.

Reforms of Jules Ferry.

Moral instruction.

Financial reform of 1889.

Administrative machinery. Minister and conseil supérieur.

Inspecteurs généraux.

Rector and council of academy.

The academy inspector.

The *préfet*, the chief administrative officer of each department, not only appoints the teachers upon the proposition of the academy inspector, he is also as president of the *conseil départemental* concerned generally with the extra of school administration, including the supply of schools. The *conseil départemental* with respect to its powers corresponds in some degree to our own local education authorities, but as regards its constitution it is in no sense a municipal body, the representatives of the *conseil général* of the department (which corresponds to the county council) being greatly outnumbered by the pedagogical members.

The inspectors of primary schools, as has already been stated, act under the academy inspector. They are appointed upon the result of examination and not by direct nomination as in England. The examination is severe, and it is from the body of the professors of the normal schools rather than from the ranks of the primary teachers that the successful candidates are chiefly drawn.

Very limited powers are entrusted to certain communal and cantonal authorities. The *commission scolaire* is a committee organized in each commune for the purpose of improving school attendance, to which end they administer a *caisse des écoles* or school fund for supplying clothing and meals to needy children. The *maire* of the commune has the right of visiting the schools, but neither he nor any of the minor local authorities can interfere with the teaching. Similar duties are assigned to the *délégués cantonaux*, who are appointed by the *conseil départemental* for each canton (a wider area than the commune), and can best be described as local visitors or visiting committees rather than managers in our sense of the word. "All this hierarchy of central and local officials," says Mr Brereton, "will doubtless seem complicated to English minds. The extraordinary thing is that, so far as I could learn, the machine, for all its complexity, works smoothly enough. The truth is that the province of each particular functionary is so clearly defined that there is no debatable ground over which ambitious rival authorities can wrangle."

In proceeding to sketch the French system of higher primary and secondary schools, it may be observed that European systems of higher education have generally been framed upon the view that the divisions of education are longitudinal, not latitudinal, and that secondary education is a training complete in itself from the preparatory stage to the university, with aims and ideals of general culture which differentiate it radically and at the very outset from education of the elementary type. On the other hand, in the United States the view has prevailed that the divisions of education must be latitudinal, that the secondary school must be complementary to the elementary school, in which even the élite must receive their preparatory or elementary training. At any rate down to the reform of 1902, which will presently be explained, the French system could be regarded as a typical and even extreme example of the European theory, little consistent as this might seem to be with the broader principles of democracy. This view of the matter is expressed by the French terminology, by which what in England is called "elementary" is in France termed "primary" education.

The thoroughness with which the principle of the autonomous character of the two divisions of education was carried out undoubtedly favoured in a special degree the complete organization given to higher primary instruction in the *écoles primaires supérieures* under the Third Republic. The aim of these schools is to fill the void

which must otherwise exist for those who need a higher education than the primary school can give, but for whose subsequent careers secondary education would be ill-adapted and injudicious. Throughout the organization of primary education the French have kept steadily in view the danger of creating an intellectual proletariat. "Nous poursuivons la culture générale du caractère et de l'esprit, mais nous cherchons en même temps à orienter l'enfant vers la vie pratique," says an official report. The aim of the higher primary school is to continue education in this

spirit up to the age of sixteen so as to prepare the scholar to take an honourable place in the higher ranks of skilled industry rather than to deflect him towards a professional career or intellectual pursuits for which he is unfitted, not so much by the accidents of birth and social circumstance as by his own natural aptitudes. Within the limits necessarily marked out for them the higher primary schools of France have aimed at imparting what may be termed a general culture as distinct from purely technical or trade teaching, and this development has been greatly furthered by the separate organization given to the latter teaching in the *écoles professionnelles*. At the same time, prominence is given in the higher primary schools to practical training of an educational character with special reference to the industries and circumstances of the locality, and in the rural districts a special agricultural bias is imparted to the curriculum. It is interesting to note that the institution of the higher primary schools was due in large part to the spontaneous initiative of the municipalities, and that in the later phases of state organization special care has been taken to avoid anything in the nature of a rigid uniformity in these schools.

A wider extension has been given to higher primary instruction by the establishment of *cours complémentaires* in certain schools, at centres at which it would be impossible to organize separate higher primary schools. A similar solution of the continuation school problem has recently commended itself to the consultative committee of the Board of Education for England.

Admission to the higher primary schools in France is only accorded to those who have obtained the elementary school leaving certificate, *certificat d'études primaires*. A feature of importance for continuation work in rural districts is the provision made for boarding scholars in attendance at these schools. The boarding arrangements are generally, as in the case of the secondary schools, left to the head teacher, but in some instances municipal hostels have been provided. No fees may be charged for higher primary instruction, and scholarships (*bourses*) are provided to a certain extent in the form either of boarding scholarships or maintenance allowances to compensate the parent for the loss of the child's labour. The number of scholars in the public higher primary schools for the year 1903-1904 was 34,084, and in *cours complémentaires* 21,777, making a total of 55,861. In addition there were 8891 scholars in receipt of higher primary instruction in private schools.

French secondary education is given in the *lycées* which are first-grade schools maintained and controlled by the state, and the *collèges*, which are schools of the second grade maintained partly by the state and partly by the municipality. A considerable number of scholars pass annually from the *collèges* to the *lycées*. In both grades of schools the teachers are paid by the state and nominated directly or indirectly by the minister of education. They are required to possess certain specified academic qualifications which can only be obtained from the *université*, but failing teachers with the prescribed qualifications the classes are taught by teachers styled *chargés de cours* as distinct from professors.

With a view to supplying teachers for the secondary schools, the state maintains the *École Normale Supérieure*, a college in which instruction, board and lodging are given free to a number of scholars selected by competition from the best secondary school boys, though residence in the institution is no longer compulsory. By the decrees of November 10, 1903, and May 10, 1904, the *École Normale* became practically the College of Pedagogy of the University of Paris. Its students are entered as students of the university, and study for their qualifying examination as teachers in secondary schools (*agrégation*) under university professors, partly at the Sorbonne, partly at the *École Normale*, while their professional preparation is entrusted solely to the latter institution.

The Republic has not reorganized secondary education by a comprehensive law; it has, however, introduced by decree, under parliamentary authority, an important reform in the internal organization of the schools which marks a notable

Préfet and
conseil
départemental.

Primary
inspectors.

Mayor
local
authorities.

Supplementary
courses.

Conception
of
secondary
education.

Secondary
schools
lycées and
collèges.

École
Normale
Supérieure.

departure from the traditional view of secondary education as a self-contained whole. Article 1 of the decree of May 31, 1902, declares that secondary education is co-ordinated with primary education in such a way as to constitute a continuation of a course of primary studies of a normal duration of four years. The decree goes on to provide for a full course of secondary studies of seven years' duration, divided into two cycles of four and three years respectively. In the first cycle the scholar has two options. In section 1 Latin is obligatory and Greek optional from the beginning of the third year (*classe 3^e*). In section 2 there is no Latin. At the end of the first cycle the state grants a *certificat d'études secondaires du premier degré*. In the second cycle one of four courses may be taken; section 1 with Latin and Greek continues the old classical education; section 2 with Latin and modern languages corresponds to the German Realgymnasium; section 3 with Latin and science, and section 4 with modern languages and science, to the Oberrealschule. The *baccalauréat*, or secondary school-leaving examination, conducted by the university, is adapted to all the courses on the principle that courses of study of equal length, whether classical or modern, literary or scientific, are entitled to equal advantages. This system of alternative courses with leaving examinations of equal value is mainly German in origin, and may be said to represent the results of the best European thought upon the problem of the organization of secondary education.

It is remarkable in view of the thoroughness with which the principle of laicization has been applied to the primary schools that the lycées still retain their chaplains (*aumôniers*) for the purpose of giving religious instruction. This difference of treatment is apparently based upon the consideration that the gratuitous and compulsory character of primary education demanded a much stricter interpretation of the principle of the neutrality of the state than was necessary in the case of secondary education, which is neither compulsory nor gratuitous.

In addition to the state schools there have until lately been in France a large number of private secondary schools, the most important of which have been associated with the Catholic religious orders. The enforcement of the laws against these communities has resulted in the closure of a number of these schools, and in the reorganization of others under a lay teaching staff. It is conceivable that the action of the Republic may largely forward the movement, otherwise perceptible in the Roman Catholic Church, to transfer education, even when combined with specific religious teaching, from ecclesiastical to lay hands. Evidence of this tendency is to be found in the boarding-schools (some four in number) founded upon the plan of M. Demolins (author of *A quoi tient la supériorité des Anglo-Saxons*) after the English public school model, but with a distinctly Catholic colouring.

Apart from the position of the religious orders, the future of private education in France is far from secure at the present time. The liberty of teaching secured by the *Loi Falloux* is regarded as a pseudo-liberty by the advanced republican educationists, and the principle that education is a function of the state and not a matter of supply and demand is deeply rooted in the public mind. Proposals have been mooted for making the *baccalauréat* strictly a school leaving examination attached to the state schools. The adoption of any such measure would practically destroy liberty of teaching by reason of the power which the *baccalauréat* secures to the state as the key to the professions.

The foundation of secondary schools for girls in connexion with the educational reform of Jules Ferry is in its way one of the most notable achievements of the republic. There is little doubt that the expulsion of the religious orders is intended to exercise a profound influence upon the education of women in France. The place of the closed convent schools is being taken either by new state schools or by Catholic schools under lay teachers, and the number of scholars affected by this process of laicization is far larger in the case of girls than of boys. This change is calculated to produce far-

reaching effects in the social and religious order, by no means necessarily, however, of an anti-Catholic or irreligious kind.

For an account of the resuscitation by the Republic of the local universities under the one great state teaching body collectively known as the University, see *UNIVERSITIES*.

Germany.

Under the German empire education is left to the exclusive control of each of the federated states. The only point of direct contact between the Empire and education lies in the mutual undertaking of the federated states to bring the law of compulsory school attendance to bear upon all subjects of the empire resident within their respective borders. Of far greater moment is the moral influence exerted upon the other states by the Prussian hegemony, in virtue of which the Prussian educational system comes to be in all essential characteristics typical and representative of Germany as a whole. It is remarkable that though, as Matthew Arnold was able to report to the Schools Inquiry Commission in 1866, "the school system of Germany in its completeness and carefulness is such as to excite the foreigner's admiration," neither Prussia herself, nor Bavaria, nor several other of the principal states of the Empire, have found it practicable to pass a comprehensive education law, owing to the religious and political difficulties with which any general legislative assertion of principle is attended in Germany as in England. The consequence is that the Prussian system in particular is the result of a long and complicated series of special laws, decrees and administrative regulations. In such circumstances it is inevitable that, especially in secondary education, some considerable local variations and anomalies should remain, but the centralized authority of the state has confined these to questions of patronage and external administration, and even within this sphere has successfully asserted its own ultimate supremacy as the guardian of the educational interests of its citizens. A detailed historical study would bring out clearly the intimate connexion between the development of the educational system and the growth of the Prussian state, and again between these and the expansion of the national life of the German people; incidentally it would exhibit the supremacy of Prussia in the modern Empire as the inevitable result not merely of military force but of a genuine hegemony of intellect and culture.

Stress is rightly laid by all educational writers upon Luther's famous letter to the German municipalities in 1524, urging upon them the duty of providing schools and upon parents the duty of sending their children to school. An attempt to give effect to this teaching was at once made by the electoral government of Saxony, which by a school ordinance of 1528 provided for the establishment in every town and village of Latin schools, for in Germany as in England the influence of the Protestant reformers was solidly on the side of classical education as the key to the study of the Scriptures and theological learning. All the more remarkable, therefore, was the initiative of the electorate of Württemberg, whose school ordinance of 1539 represents the first systematic attempt to make provision for both elementary and higher education, directing that elementary schools should be set up throughout the country, and *Particularschulen* or Latin schools in every considerable centre of population. The educational efforts both of the early Reformers and of the remarkable Jesuit educationists, who contributed so largely to the partial reconquest of south Germany for the Catholic Church, were brought to naught amid the troublous times of the Thirty Years' War, and the desolation and national decadence which that calamity brought in its train. To this result the aridity of the Protestant scholastics who succeeded Luther and Melancthon, and the frivolity, incompetence and petty despotism of the small German courts, contributed in no slight measure. The permanent and positive value of Luther's pronouncement of 1524 consists not so much in the direct effects which it produced as in the hallowed association which it established for Protestant Germany between the national religion and the educational duties of the individual and the state, and doubtless this association largely contributed to the creation of

Classical and modern education. Reform of 1902.

Religious instruction in lycées.

Private secondary schools.

Influence of Luther.

Secondary education for girls.

that healthy public opinion which in Prussia rendered the principle of compulsory school attendance easy of acceptance at a much earlier date than in England and elsewhere, save only Scotland, where a similar historical religious influence was supplied by John Knox.

State interference in education is almost coincident with the rise of the Prussian state. Already in 1717 Frederick William I. ordered all children to attend school where schools existed, and fixed the fee at 5 pf. (3d.) a week. This was followed in 1736 by edicts for the establishment of schools in certain provinces and by a royal grant of 50,000 thalers for that purpose in the following year. In 1763 the *General Landschulreglement* of Frederick the Great laid down the broad lines upon which the Prussian state has since proceeded, asserting the principle of compulsory school attendance, fixing the fees, with provision for the assistance of very poor children, prescribing the course of instruction, and giving directions for the examination and supervision of teachers. Much progress was made, more especially in the organization of higher education, under Baron von Zedlitz, who was appointed minister for Lutheran church and school affairs by Frederick the Great in 1771, and retired under Frederick William II. in 1788. The last-mentioned year saw the establishment of the *Abiturientenexamen*, or leaving examinations, which form the determining element in the state organization of secondary education in Germany. As in England, the fear of the French Revolution produced a corresponding reaction in educational affairs, and the policy of Frederick William II. was to bind ever closer school and church in a system practically independent of state control. The first departure from this policy was marked by the *Allgemeines Landrecht* of 1794, which boldly proclaims that schools and educational institutions may be founded only with the knowledge and consent of the state, and must always be under its supervision and subject to its examination and control. This law also laid upon heads of families in every place the duty of providing and maintaining schools.

It was not till the disaster of Jena and the prostration of Prussia at the feet of Napoleon awoke the dormant spirit of patriotism, and concentrated all the intellectual forces of north Germany upon the task of national regeneration, that the principles of the *Allgemeines Landrecht* of 1794 bore full fruit. "The organization of the Prussian school system," says Dr James E. Russell in his work on *German Higher Schools*, "waited on the reorganization of the Prussian State." One of the first acts of the great patriotic minister von Stein, upon his assuming control of the civil administration in 1807, was to abolish the semi-ecclesiastical Oberschulkollegium which had been set up as the central authority under the churchly policy of Frederick William II., and to place education under the Ministry of the Interior as a special section. Wilhelm von Humboldt was placed at the head of this section in 1809, and the work which this "great master of the science and art of education" (as Professor Seeley terms him in his *Life of Stein*) inaugurated in his one year of office entitles him to be ranked among the founders of German unity. Humboldt's greatest positive achievements—the foundation of the university of Berlin and its organization under a professorial staff which included Fichte, Schlegel, Savigny, Wolf and Niebuhr, as also the internal reform of secondary schools undertaken with the pedagogical assistance of Wolf and under the inspiration of Fichte—lie beyond the scope of this article. It may, however, be observed that Humboldt's policy in secondary education represents a compromise between the narrow philological pedantry of the old Latin schools and the large demands of the new humanism of the period; and the recent reform of the Prussian secondary schools may be said to represent a return to the spirit of Humboldt in this respect. The measure introduced by Humboldt in 1810 for the state examination and certification of teachers checked the then common practice of permitting unqualified theological students to teach in the schools, and at once raised the teaching profession to a high level of dignity and efficiency which of itself sufficed to place Prussia in the

forefront of educational progress. It was due also to the initiative of Humboldt that the methods of Pestalozzi were introduced into the teachers' seminaries, through them to vitalize the elementary schools. To the period of the national struggle belong the revival in 1812 of the *Abiturientenexamen* which had fallen into abeyance, and the institution about the same time of the local authorities called *Schulvorstände* for the country and *Schuldeputationen* for the towns.

Though the period which succeeded the peace of 1815 was one of political reaction, the cabinet order of Frederick William III. in 1825 strengthened the law of compulsory attendance and carried on the work of administrative organization by defining the duties of the *Provinzial-Schul-Kollegium* and the *Regierung*. In 1834 an important development was given to secondary education by making it necessary for candidates for the learned professions as well as for the civil service, and for university studies, to have passed the leaving examination of the gymnasium. Thus through the leaving examination the state holds the key to the liberal careers, and has thereby been able to impose its own standard upon all secondary schools. Apart from the privileges relative to professional studies, the system of leaving examinations has exerted a wide influence upon popular education in connexion with the institution of compulsory military service, in virtue of a regulation which entitles those who pass the leaving examination of any of the recognized kinds of secondary schools to the much-coveted privilege of service for one year as a "volunteer" instead of two years as an ordinary conscript.

The revolutionary and national movement of 1848 was followed by a period of further educational activity. The Act of Constitution of 1850 declared teachers civil servants and elementary education free. In practice, the abolition of school fees did not become general until 1888. Since then the view has more and more prevailed that elementary education must be free, and, broadly speaking, fees in elementary schools are now charged only for children attending from another school district.

In connexion with the *Kulturkampf*, or struggle between the state and the Roman Catholic Church, the *Schulaufsichtsgesetz* of 1872 reasserted the absolute right of the state alone to the supervision of the schools; but the severity of this law as a measure against Roman Catholic clerical education was considerably modified as a result of the subsequent reconciliation with the papacy under Leo XIII., and the Prussian system remains to-day both for Catholics and Protestants essentially denominational. All schools, whether elementary or secondary, are Evangelical, Catholic, Jewish or mixed. In the elementary sphere, in particular, recourse is only had to the mixed school (*Simultanschule* or *paritätische Schule*), where the creeds are so intermingled that a confessional school is impracticable. In all cases the teachers are appointed with reference to religious faith; religious instruction is given compulsorily in school hours and is inspected by the clergy. The general purport of the Prussian school law of 1906 is to strengthen the system of separate confessional schools, which it extends to certain provinces where it had not previously been in operation.

In financial respects the last-mentioned law effected some readjustment of burdens by charging a proportion of the expenditure upon landed property. Other recent changes relate to the reform of secondary education referred to below. The system of educational administration as it stood in 1909 may shortly be described as follows.

Under the ministerium in Berlin stands the *Provinzial-Schul-Kollegium*, the chairman of which is the *Ober-Präsident* of the province, composed of four or five *Räte* or councillors, generally selected from the directors of training colleges and gymnasia. This body is concerned mainly with higher education.

Each province is divided for purposes of general administration into two *Regierungen* or governments, and in each *Regierung*

¹ See especially *Das öffentliche Unterrichtswesen Deutschlands*, by Dr Paul Stötzner (Leipzig, 1901).

Early Prussian measures.

Reconstruction after Jena.

Reforms of 1825 and 1834. *Abiturientenexamen.*

Kulturkampf and the confessional system.

Administrative machinery.

there is a section of usually three or four *Schulräte*, which controls the elementary schools. This council is usually recruited from the ranks of directors of training colleges and from the inspectorate. The Regierung is divided into *Kreise* or districts, and in each district an administrative officer, called the *Landrat*, represents the government. The Landrat is concerned with the provision and repair of elementary school buildings; as regards internal organization, the elementary schools are under the *Kreisschulinspektor*.

In the Protestant districts the inspectors (*Kreisschulinspektoren*) are usually Evangelical clergymen holding the position of superintendent in the Lutheran Church.

Inspection. In the Catholic and certain other exceptional districts inspectors with pedagogical qualifications and the status of full government inspectors are appointed. Every candidate for Lutheran ordination is required to spend six months at a training college, but pedagogical opinion is hostile to the system, which must be regarded as a survival of the traditional union of church and state in educational affairs, retained at the present day from motives of economy and a desire to conciliate the church.

For every school there is an *Ortschulinspektor*, usually the clergyman of the parish, who discharges the duties of local manager and correspondent. This local inspector is also chairman of the *Schulvorstand* or committee, elected by the *Schulgemeinde*, and charged with questions of attendance and maintenance rather than with internal affairs. The *Schulgemeinde* need not coincide with the civil parish. Parishes may unite to provide one school, or within one parish different religious communities may form separate school "parishes."

Thus the administrative system of Prussia in education as in other matters may be described in general as a decentralized bureaucracy. This bureaucracy is somewhat checked by the rights of patronage attaching to the local boards in certain cases, but the exercise of such rights is in all cases subject to government approval. As regards higher-grade elementary and secondary schools, the local boards in the towns (*Schuldeputationen*) are able to exert a considerable influence in the way of selection of the type of school, and even of suggestion for the modification of recognized types, as is shown by the cases of the famous "reformed" secondary curricula of Altona and Frankfurt. Still, the legal powers of the local board are restricted to the establishment of an approved type of school, the control of externals, and the right of nominating teachers.

Elementary Schools.—The single-class school (*Einklassige Schule*) and the half-day school (*Halbtagschule*) are features of the Prussian elementary system which require notice. **Peculiarities of elementary education.** The *Einklassige Schule* is a school taught by a single teacher, who may teach a maximum number of eighty children. The *Halbtagschule* is a single-class school of which half the children are taught in the morning and half in the afternoon. During the summer months, owing to the exigencies of agricultural labour, many single-class schools are taught as half-day schools. The system of course is regarded as a makeshift, but in this, as in the matter of buildings for rural elementary schools, the Prussian administration attaches great weight to the consideration of financial economy. As regards staff, a large measure of economy is rendered possible by the high average standard of merit reached by German elementary teachers, whose powers of oral exposition have struck English observers as specially remarkable, and again by the national readiness to be content with a moderate salary in return for official status. A survival of the old close connexion between church and school is to be found in the *Kirchendienste*, the duties of training the choir, playing the organ, &c., which are attached in many cases to the post of schoolmaster, and afford an additional source of emolument, rendered feasible by the practical absence of religious dissent.

For the preliminary training of elementary teachers there are special schools called *Vorbereitungsanstalten*, of which most are state institutions, some are municipal, and a few are private. The training colleges themselves are provided by the state and have a three years' course.

Continuation Schools (*Fortbildungsschulen*).—Germans have been foremost to realize the truth which is gradually being brought home to English educationists, that adequate value for the heavy expenditure of public funds upon education can only be obtained by providing for the continued education for two or three years of the children of the working classes who leave school at fourteen years of age. One of the educational results of the war of 1870, with its great lesson of the importance of national education, was the Saxon law of 1873 making attendance at continuation schools compulsory for three years (i.e. up to seventeen) in that kingdom. The Saxon law appears to have been justified by the experience of nearly a generation. It must suffice here to note the following features of its working. (1) The schools are taught by the primary teachers, supplemented in the towns by some technical instructors. (2) The school session may be either for the whole year or for only half the year, and may also be held on Sunday, like the old English secular Sunday schools. (3) The schools are brought into close relation with trades, not only for purposes of curriculum, but also with a view to considering the exigencies and meeting the convenience of employers with respect to hours of attendance. (4) The discipline of the continuation school is extended to supervision out of school hours. "Visits to dancing-halls and all such exhibitions as are dangerous to uprightness and purity are forbidden to scholars of continuation schools." Further, useful institutions such as savings banks, and also associations for social intercourse and the promotion of *esprit de corps*, are organized in connexion with continuation schools. There is no doubt that in this matter of continuation schools, as in so many other fields of social organization, the adoption of compulsion has been facilitated by the habituation of the working classes to compulsory military service, which has made the German workman more disciplined, more "organizable" as a social unit, more accustomed to subordinate the principle of individual freedom and self-will to the collective claims of the state, than the workman reared in the traditions of Anglo-Saxon individualism.

Attendance at continuation schools is now compulsory by state law in 12 states, including (besides Saxony) Baden, Württemberg and Bavaria. The city of Munich is notable for its highly organized system of technical continuation schools for apprentices. In Prussia compulsory attendance is still the exception (save in the provinces of Posen and West Prussia, where it is enforced by state law), but the permissive act is being rapidly adopted by the great cities, including Berlin.

Secondary Education.—The official classification or grading according to the type of curriculum of secondary schools in Prussia (and indeed throughout Germany) is very precise. The following are the officially recognized types. I. Classical schools: (a) Gymnasium, with nine years' course; (b) Progymnasium, with six years' course. II. Modern schools: (a) with Latin (semi-classical)—(i.) Realgymnasium (nine years' course), (ii.) Realprogymnasium (six years' course); (b) without Latin (non-classical)—(i.) Oberrealschule (nine years' course), (ii.) Realschule (six years' course). The six-year classical and semi-classical schools are comparatively unimportant subdivisions in smaller towns.

Lower-grade Secondary Education.—Inasmuch as French is taught in the lowest class of the Realschule under the official curriculum (English, on the other hand, beginning in Tertia, the fourth class from the lowest), it follows that this, the lowest type of secondary school, is not directly co-ordinated with the elementary school. The Realschulen of Berlin, however, form an important exception to the general rule; their curriculum, sanctioned by the ministry at the instance of the Berlin municipality, provides for the beginning of French in Quarta (the third class from the bottom) and English in Secunda. The consequence is that in Berlin a very large number of pupils pass from the elementary schools to the Realschulen, which take the place of the Mittelschulen or higher-grade elementary schools that

Continuation
education.

Grading of
secondary
schools.

Co-ordination
of
elementary
and
secondary
education.

are to be found in some towns, though something in the nature of higher elementary education is afforded by the top sections of the elementary schools.

First-grade Schools.—One of the most striking features of German secondary education is the careful differentiation of schools according to the type of curriculum adopted.

First grade secondary schools. Thus, every German school is a homogeneous unit with a definite educational aim and organization, conforming to a common standard approved by public authority for the particular type to which it belongs. Hence the importance attached by the Germans to nomenclature; so that in selecting a *Gymnasium*, a *Realgymnasium* or an *Oberrealschule*, the parent knows exactly the type of education he is going to secure for his son. In England, on the other hand, as has often been observed, a great school tends to multiply within itself different types of curricula in a haphazard way according to the demand of parents, whose original choice of school is based rather on social than on educational grounds. Modern sides, army classes and engineering classes grow up as excrescences upon an originally classical type, with the waste of power that results from loss of consistency and concentration of purpose. The difference between the English and German systems is due ultimately to the adoption in Germany of the day-school system and the absence, very remarkable in an otherwise aristocratically governed country, of the caste spirit in education above the elementary level, thanks to which the nobly born are not ashamed to sit on the school bench side by side with the children of the trading classes. On the other hand, the English boarding-school system, despite all the want of social solidarity, and all the class jealousy and exclusiveness with which it is inevitably associated, has admittedly favoured those ideals of the cultivation of character as distinct from book-learning which give a special value to what is in England called a public school education.

The present differentiation of first-grade schools in Prussia is the result of a natural educational development corresponding with the economic changes which have transformed Prussia and the empire from an agricultural to an industrial state. It was in 1855 that semi-classical schools (teaching Latin without Greek) were first recognized for a nine years' course under the title of *Realschule I. Ordnung*, and in 1871 pupils possessing their leaving certificates were admitted to mathematical studies in the universities. The Latinless *Realschule II. Ordnung* is the direct product of the great industrial development of the modern empire. In 1882 the *Realschule I. Ordnung* received the title of *Realgymnasium*, and the *Realschule II. Ordnung* that of *Oberrealschule*, both types being at the same time admitted to certain privileges in the universities, schools of technology and civil service.

About the same period official recognition was obtained for reformed secondary curricula, first at Altona and afterwards (1892) at Frankfort. These two types differ from each other in detail, but the feature which distinguishes both from the older types is the postponement of Latin to *Untertertia*. The design is to secure for all types of secondary education a common non-classical base coextensive with the first three years of school life, followed by a trifurcation or threefold choice between the classical, semi-classical and non-classical types. The principle of the "reform-school" has been adopted in a considerable number of German (chiefly Prussian) schools, but it would be premature to see in it at present more than a new variety of *Realgymnasium* or semi-classical school; it can hardly be said as yet to have affected the course of classical studies in the full sense. The widespread sentiment of discontent with the old philological type of classical school was vigorously expressed in a private letter written by the emperor William II. as crown prince of Prussia in 1885, but not published until some years later. In December 1890 the Prussian ministry convoked a conference at Berlin of secondary school experts, and the emperor presided in person at the opening session. His majesty delivered a speech criticizing the *Gymnasia*

as wanting a national basis. "It is our duty to educate young men to become young Germans and not young Greeks or Romans" was the keynote of the imperial discourse. The outcome of the conference was a shortening of the hours allowed to Latin in the *Gymnasia*, a reduction of the hours of study in view of over-pressure, and an expression of official opinion adverse to the *Realgymnasium*. These changes, introduced in 1892, did not go far enough to satisfy the reformers, whilst the reduction of the hours allowed for Latin caused misgivings among the upholders of the traditional *Gymnasium*. Moreover, the *Realgymnasium* showed greater vitality among the large towns than its official critics anticipated. The ensuing decade witnessed a certain reaction in favour of the classical humanities as a barrier against the materialistic influences of the new industrialism. At the same time the protagonists of the classics came to recognize that side by side with the old humanities there must be accorded to modern and scientific subjects that place in the high-grade schools which the practical exigencies of industrial life demanded. Thus, the opinion grew that the best line of defence for the classical schools lay in the concession of equal privileges to the non-classical types; in this way only could the classical schools be kept safe from demands upon their time that could not be conceded without endangering their proper work. It was upon this basis that an agreement was reached between the contending parties at a second school conference that met in Berlin in June 1900. As the result of this conference there was issued a royal decree laying down certain general principles, of which the following are the most important. (1) There must be equality of privileges as between classical, semi-classical and non-classical first-grade schools. The decree recognizes, however, that this principle must be applied with a certain elasticity and with due regard to the necessity for training in particular branches of knowledge as a preliminary to certain lines of university study and certain professional pursuits. Consequently the Prussian system of privileges has become extremely complicated, and it is truer to speak, as the decree goes on to do, of an extension of the privileges of the non-classical schools, rather than of absolute equality. (2) "In thus acknowledging the equality of the three types of higher institutions, it will be possible more thoroughly to strengthen the special characteristics of each type. In this connexion," the royal decree proceeds, "I shall offer no objection to an increase in the number of hours devoted to Latin in the *Gymnasium* and *Realgymnasium*." Thus, both as to the place of Latin in the curriculum of classical schools and as to the status of semi-classical schools, the decree of 1900 involves a reversal of the policy of 1890. (3) The decree expresses approval of the reformed curricula of Altona and Frankfort, and a desire for an extension of the experiment where the conditions are suitable.

Notwithstanding the growing official encouragement of education upon semi-classical or non-classical lines, the upper and professional classes of Germany continue to show a marked preference for the fully classical *Gymnasium*; hence, in Germany as in England, the tendency for a widening gulf to disclose itself between the education of the directing classes in politics and administration and the bulk of the industrial population, which suggests that the problem of combining in just proportions the liberal and practical elements in a thoroughly national system of education has not yet reached the solution that the needs of the age require.

Switzerland.

Switzerland affords perhaps the best type of a democratic system of local authorities. The central authority is the canton, not the federation. The interference of the federal authority is confined to the imposition of certain broad principles by the constitution, to the indirect influence exerted by the examination of recruits for the national army, and to financial grants for technical instruction, its most important direct educational work being the support of the technological university at Zurich. The federal constitution (1) states that primary instruction must be under

Educational influence of federal constitution.

the control of the canton (an important point in view of the strength of ecclesiastical influence in some of the Catholic cantons), and must be compulsory and gratuitous; (2) declares that it must be possible for the public schools to be attended by the adherents of all creeds without hurting their freedom of conscience; (3) forbids the employment of child labour before completion of the fourteenth year, with a provision that in the fifteenth and sixteenth years factory work, together with the time given to school and religious instruction, must not exceed eleven hours a day. (4) All recruits for the federal army (in which service is compulsory on a militia basis) are examined in their twentieth year, and the results are published. This examination affords an instructive index to the state of education in the several cantons and promotes a healthy emulation among them.

The cantonal organization of education presents the variety which the extraordinary diversity of race, language, religion and physical conditions of the component states of the federation would lead one to expect. The large canton of Bern may be instanced as the type of a strong central authority. The commune or parish is the unit for elementary education. The communal council nominates a school board of at least five members, whose function is to spend the money voted for school purposes by the general communal council. Several communes in combination form a district authority for the support of what are in reality higher primary schools, though called in Switzerland *Sekundarschulen*, maintained by the district. The maintenance both of the primary and higher primary schools is aided by grants from the central authority. The true secondary schools, called middle or higher schools, are maintained and controlled by the central or cantonal authority. The existence of separate local authorities for each grade of education is characteristic of Switzerland generally, this system being the opposite to that adopted in England in 1902.

The central grants in Switzerland always take the form of payments to the local authorities of a proportion of the teachers' salaries; they are never, as in England, assessed upon the number of children in attendance, nor are they dependent, as was formerly the case in England, upon the results of examination, nor again are grants made in respect of particular subjects as is the case with the grants for special, *i.e.* practical, instruction in England. Religious instruction in the Swiss communal schools generally follows the faith of the majority; in a few cantons separate schools being provided for minorities if sufficiently numerous. In the town of Lucerne, Catholic instruction is given in school hours and Protestant instruction is provided out of school and out of hours for the Protestant minority.

In 19 out of the 25 cantons attendance at continuation schools is compulsory (at least in some districts) for boys up to 17, and in 3 cantons it is compulsory also wholly or in part for girls.

Belgium.

The interesting feature in Belgian education is the treatment of the religious question in successive laws.

Belgian treatment of religious question. 1. The law of 1842 obliged the communes to provide primary instruction, which was to be free in the case of poor children. The state made grants in aid, subject to inspection. Subject to a conscience clause, religious instruction was obligatory, and was placed under ecclesiastical inspection.

2. The law of 1879 removed religious instruction from the curriculum, and provided for facilities to the clergy to give such instruction outside school hours. This law furnishes a striking instance of the futility of a parliamentary majority legislating in a sense opposed to the convictions of a considerable section of the community. The law evoked a storm of opposition in the country, still profoundly Catholic and attached to ecclesiastical traditions, and within eighteen months the Catholics founded private elementary schools with 455,000 scholars. In 1883 the Catholic private schools numbered 622,000 scholars, whilst the attendance at the communal schools had sunk to 324,000. Their doctrinaire treatment of the education question resulted in the political

annihilation of the Belgian Liberals, and was responsible for the strongest and most persistent Roman Catholic reaction that has been witnessed in western Europe since the beginning of the 19th century.

3. The law of 1884 was the work of the moderate Catholic party. It did not make religious instruction obligatory, but it gave liberty to the communes to provide for the giving of religious and moral instruction at the beginning or end of school hours, subject to a conscience clause. Power was given to the communes to "adopt" private confessional schools and maintain them. Provision was further made entitling any twenty parents of children of school age to demand a school of the normal communal type as against a proposal to adopt a confessional school. Power was also given to a like number of parents to compel the adoption of a confessional school in the case of the commune refusing to provide religious instruction of the type demanded by them, or putting obstacles in the way of its being given by the clergy or their representatives.

4. The law of 1895 is the work of the more authoritarian Catholics, and makes religious instruction obligatory, placing it directly under the control of the clergy. It also increased the subsidies to private schools. This law was passed in face of opposition from the moderate section, who saw in it an exaltation of state authority which might be turned by opponents to the disadvantage of the religious interest. It is by no means clear that Belgium has yet attained a final solution of the religious difficulty; the life of the present law is probably to be measured by that of the Catholic political majority.

Holland.

The outstanding feature of public education in Holland is the strength of the private primary schools. Under the law of 1857 secular teaching alone was provided in the primary schools at the public cost. The law of 1878 allowed communes to make grants to private schools on condition of their becoming neutral in the matter of religion. The law of 1889 allowed private denominational schools to receive government grants while retaining their denominational character, but forbade further grants to such schools by the communes.

In 1905 there were 566,460 children in the public and 278,632 in the private schools.

Scotland.

The diverse religious and social conditions of the three constituent parts of the United Kingdom must necessarily cause the education problem to assume a different shape and to receive different solutions in England, Scotland and Ireland respectively; latterly also the special conditions obtaining in Wales have received partial recognition at the hands both of the legislature and the executive. In Scotland the conditions have been less complex than in England. The practical unanimity of the people in religious faith, which has remained undisturbed by the institutional divisions of recent times, the wider diffusion of a sense of the value of education, the greater simplicity of life which has rendered all classes largely content to avail themselves of the preparatory education afforded by the common school and favoured the development in the secondary sphere of day rather than boarding schools, are among the causes which have contributed to the early building up of a national system which in some respects resembles the continental rather than the English type.

The national appreciation of education is found marked already before the Reformation in a statute of James IV. (1494) requiring all freeholders of substance to send their heirs to school and to keep them there until they had perfect Latin. The Reformation, asserting itself by common consent under one ecclesiastical form, and free from the divisions of religious organization which tended to neutralize it as an educational force in England, put fresh life into the educational aspirations of the people. As early as 1560 the Church Assembly, largely under the influence of John Knox, put

Historical development.

forth the *Book of Discipline*, providing that "every several kirk" in a town "of any reputation" was to have its Latin school, that the "upland" or country parts were to have a teacher of the "first rudiments" in every parish, and that each "notable" town was to have "a college for logic, rhetoric and the tongues." Practical effect was later given to this scheme by an act of the Scottish parliament in 1696, under which parish schools were set up in connexion with the Established Church of Scotland. This system was extended by an act of 1803, which made better provision for teachers' salaries and also confirmed the position of the parish school as an adjunct of the parish church. The system of inspection and state aid introduced in England in 1839 was made applicable to Scotland, thus grafting upon Scotland the English system of voluntary state-aided schools. At the same period another new factor was imported into Scottish education by the ecclesiastical disruption of 1843. As a result of these changes in 1861 a new act was passed which relaxed, though it did not sever, the ties which bound the parish school to the church.

The Education (Scotland) Act of 1872 set up elective school boards for parishes and boroughs, and vested in them the existing parish and burgh schools. Long prior to the act it had been the practice of the Church of Scotland to allow exemption in the schools from religious instruction; consequently in imposing a compulsory conscience clause the act did little more than confirm existing usage. The school boards were left full liberty as to the religious instruction to be given in their schools, and in practice school boards universally adopt the Shorter Catechism, which is acceptable to all denominations of Presbyterians. The act made the school boards responsible for the supply of school accommodation, and introduced compulsory attendance, for which opinion in England was not at that time ripe. By the act of 1901, the age of compulsory attendance was raised to fourteen, with provision for exemption after twelve.

The experience of the Scottish Education Department, like that of the English, has led to the gradual abandonment of individual examination as the basis for the payment of grants. The institution of the merit certificate is one of the features in which the Scottish system differs from the English. Prior to the code of 1903 the merit certificate, awarded on examination after the age of twelve, was properly described as the leaving certificate of the elementary school. Under the more recent codes merit certificates are awarded under a system designed to encourage the transference of promising pupils at an early age to supplementary courses or higher-grade departments. Under this system the fitness of the pupil to enter upon a course of higher studies is determined not solely by the results of a single examination, but by the whole character of his work during the preceding school course.

A notable factor historically in Scottish education was the extent to which the parish schools supplied their best pupils with higher or further education. The administrative changes last mentioned have led to a remarkable development of organized higher-grade schools and departments. These departments have now been organized upon the lines of the higher primary schools of France, "to continue a stage further" (says the report of the Scottish Education Department) "the general education of that considerable body of pupils who, under new conditions, may be expected to remain at school till fifteen or sixteen." The function "of giving something of the nature of a specialized education to pupils who will leave school at a comparatively early age" is now discharged by the supplementary courses.

Elementary education has generally been rendered free by the fee grants under the parliamentary vote, and by the sums accruing under the Local Taxation (Customs and Excise) Act 1890 and the Education and Local Taxation (Scotland) Act 1892.

Voluntary schools are not numerous, being chiefly those of

the Roman Catholic Church. The average cost of maintenance per child in average attendance in public schools (according to the official report 1907-1908) was £3, 11s. 1½d., of which £2, 4s. 4½d. was met by government grants for elementary education. In voluntary schools the average cost of maintenance was £2, 15s. 1½d., of which £2, 2s. 7d. was met by elementary grants, including a special aid grant of 3s. per head under the Education (Scotland) Act 1897.

The total number of children (1907-1908) in average attendance in grant-earning schools was 712,076, and the percentage of attendances to numbers on the register was 87.66%. As regards teaching power, 81.52% of the male teachers and 56.71% of the female teachers in the elementary teachers had been trained in training colleges.

Certain miscellaneous additional powers are conferred upon school boards by the Education (Scotland) Act 1908, including powers to provide school meals; in outlying parts, to provide means of conveyance, or pay travelling expenses of teachers or pupils, or defray the cost of lodging pupils in convenient proximity to a school; to provide for medical inspection; and as to children neglected by reason of the ill-health or poverty of the parent, to supply food, clothing and personal attention.

Perhaps the most noteworthy provision in the act of 1908 is that which enables (not obliges) school boards to make by-laws requiring attendance at continuation classes up to the age of seventeen years. Apart from compulsory attendance, the act lays upon school boards the duty of making suitable provision of continuation classes with reference to the crafts and industries practised in the district.

The Scottish Education Act of 1872 distinguished certain burgh and parish schools as "higher class public" or secondary schools. The act of 1908 deals in some detail with secondary education, modifying and strengthening the framework in various ways, but without introducing organic changes. "Secondary" schools are distinguished from "intermediate," the former being defined as providing at least a five years' course; the latter as providing at least a three years' course in languages, mathematics, science and such other subjects as may from time to time be deemed suitable for the instruction of pupils who have reached a certain standard of attainment in elementary subjects under the code. Intermediate and secondary schools may be provided and maintained either by school boards or otherwise, and provision is contained in the act for the transfer of endowed schools to the school board. Thus secondary (as well as elementary and continuative) education is organized upon the basis of the parish or burgh; it receives, however, grants in aid through the agency of county (or large urban) authorities (called district committees) constituted under schemes of the Scottish Education Department. For the purpose of such grants in aid the funds available under the various local taxation acts, together with parliamentary grants, other than a fee grant at the rate of 12s. per child in average attendance, form a fund called the Education (Scotland) Fund. After provision has been made for (*inter alia*) grants for universities, higher technical education and training colleges, the fund is allocated to the district committees according to a scheme laid before parliament and approved by the king in council. Out of the "district education fund" the school board receives (ordinarily) a sum equal to one-half of the amount by which the net cost to the school board (after deducting income from grants made by the department and from fees) exceeds the amount which would be produced by such rate per pound upon the district of the school board as the committee may determine, not being more than a rate of twopence in the pound. Important powers are also conferred upon the district committee for organizing and aiding within their district the provision by the school boards of medical examination and supervision of school children, the supply of bursaries for purposes of all forms of higher education, and the provision of instruction in special subjects, such as agriculture, &c.

Scottish school boards and school attendance law.

Administrative program.

Higher-grade schools.

Free education.

Education (Scotland) Act 1908.

Compulsory continuation classes.

Secondary education.

Ireland.

The full development of a system of public education in Ireland has been hampered and retarded by the general difficulties inherent in the problem of Irish government.

Special difficulties of Irish education. In consequence of the fundamentally different social, religious and political conditions in the two countries, the English and Irish systems have developed down to the present time upon divergent lines. In England, popular education was founded in the first instance upon individual initiative combining in organized voluntary effort, and, though the voluntary agencies have been first supplemented and latterly to a large extent supplanted by public action, the tendency has been in the direction of municipalization rather than in that of central state control. In Ireland, on the other hand, education has suffered in the past from the general absence of individual initiative and local interest almost as seriously as from the mistakes of the English government. These causes, more directly perhaps than the prevailing poverty of the country, made it necessary to throw the burden of supporting the schools to an increasing extent upon the state, while the want of local self-government precluded any devolution of powers and duties upon municipal authorities.

State intervention is actually of earlier date in Ireland than in England. From the reign of Elizabeth onwards, English Protestant schools were founded by the government in a sporadic and intermittent fashion in pursuance of its Anglicizing policy. To mention briefly one or two historical features, the great religious educational enterprise of Edmond Rice in founding the well-known Irish Catholic order of the Christian Brothers in 1802 forms an exception to the general lack of initiative among the people themselves. About the same period the Kildare Place Society (founded in 1811 while the first commission of inquiry into Irish education was sitting) attempted to grapple with the peculiar difficulties of the religious situation upon lines somewhat similar to those just laid down by Lancaster and his followers in England. This organization comprised both Roman Catholic and Protestant schools upon a common religious basis of Bible reading without note or comment, and received government grants which rose to £30,000 a year before they were discontinued in 1833. The religious compromise which the system embodied broke down in consequence of Catholic dissatisfaction, and that it was at first fairly successful may seem extraordinary in view of the later attitude of the Catholic Church towards the question of common schools and combined religious instruction.

Historical retrospect. In 1833, as the result of a second commission of inquiry (1824) and a select committee of the House of Commons (1828), Mr Stanley inaugurated the national system of elementary schools under a board of commissioners nominated from the different religious denominations. The government appears from the outset to have aimed at combined secular and separate religious instruction for Roman Catholics and Protestants. At the same time, an attempt was inconsistently made to provide an ethical basis for the secular instruction by means of Bible extracts. The story of the preparation of these extracts by an ingenious compound of the Protestant Authorized and Douai versions of Scripture is in its way one of the curiosities of religious history. The extracts were designed to meet the recognized Catholic objection to the indiscriminate reading of the Bible without note or comment. In practice they were chiefly used in the Protestant schools (in which their use is now practically extinct), and the growing Catholic objection to the policy of the National Board in this respect found authoritative, though somewhat cautiously worded, expression in a decree of the Roman Congregation De Propaganda Fide of January 11, 1846, declaring that non-sectarian religious instruction was dangerous to youth. "Tutius multo esse ut literarum tantummodo humanarum magisterium fiat in scholis promiscuis, quam ut fundamentales, ut aiunt, et communes religionis Christianae articuli restricte tradantur, reservata singulis sectis peculiari seorsum eruditione. Ita enim

cum pueris agere periculosum valde videtur." The religious difficulty in Irish elementary education may be said to have been solved in process of time by the conversion of the national system in practice, though not in theory, into a system strongly denominational and therefore widely different from the design of its founders, combined Biblical instruction being discarded, and separate schools for the most part taking the place of common schools for the two creeds. In the latter respect the like tendency has been noted in the case of Germany.

The following are the chief specific points upon which the Irish system of elementary education differs from the English.

Finance.—The state still makes building grants to the extent of two-thirds of the cost. Such grants are only made to what are called vested schools, that is to say, schools of **Irish denominations** which the premises are vested in trustees or in the **Irish education** commissioners themselves. The state further pays **Irish education** in the case of all national schools the entire cost of maintenance except only the upkeep of the building, and the provision of books after the exhaustion of a first free grant.

Appointment and Payment of Teachers.—For the purpose of promoting the state through its inspectors undertakes the duty of classifying the individual teachers in four grades, passage from one grade to another being secured by examination. Appointments of teachers to schools are made by the school managers subject to the approval of the commissioners. Rights of dismissal are reserved to the local managers and also to the commissioners independently. Lastly, the teachers' salaries are now paid directly by the state. The old system of payment by results was abandoned in 1900, and the teacher is paid (a) a fixed salary according to grade, (b) a continued good service salary which may be increased triennially, (c) a capitation payment.

Convent Schools.—In addition to the national schools supported as above, there are a considerable number of convent or monastery schools which receive capitation grants after the English plan, but not direct salaries. There were 308 such schools in 1908, with an average attendance of 70,003. There were also 83 other convent or monastery schools paid by personal salaries, with an average attendance of 11,075.

School Attendance and Free Education.—The Irish Education Act 1892 provided for compulsory attendance in towns and for the adoption of compulsion in other districts. In virtue of the financial sections of this act, which provided an increased grant for salaries, most national schools have become free.

General Elementary-School Statistics.—In 1908 the average number of scholars on the rolls of all the schools was 708,992, and the average daily attendance was 494,662, or 69.8% as compared with the number on the rolls. As regards religious denomination, 74.42% of the scholars on the rolls were Roman Catholics; 28.6% were in schools attended by both Roman Catholic and Protestant children and 71.4% in schools attended solely by Roman Catholics or solely by Protestants. The total expenditure on the schools and teaching staffs was £1,591,212, of which £1,451,139, equivalent to £2,108.3d. per scholar, was contributed from state grants, and £140,074, equivalent to 5s. 9d. per scholar, from local (i.e. voluntary) sources, the rate per scholar from all sources being £3. 5s.

Training of Teachers.—Salaried monitors are employed in the Irish schools, but, unlike the English pupil teachers, are not explicitly recognized as forming part of the school staff. There are now seven training colleges, viz. one undenominational college maintained by the commissioners, five Roman Catholic colleges, and one college in connexion with the Protestant Episcopal Church of Ireland. Of the scholars in the undenominational college, 73 out of 312 were Roman Catholics. The total number of students in training was 1189, viz. 514 men and 675 women. The percentage of trained teachers to the total number of teachers was 64.7. A special training college for the instruction of teachers in Irish has been recognized.

One of the chief desiderata in Irish education is a single central authority for all branches of education, elementary, secondary (or "intermediate") and technical. There are two

central authorities dealing with secondary education, viz. the Intermediate Education Board and the Department for Agriculture and Technical Instruction. The Intermediate Board administers sums available under the Intermediate Education Act of 1878 from the Irish Church Surplus, and also the sum allocated under the Local Taxation Act 1890. The vice of the system in the opinion of educational experts lies in the statutory obligation to award grants on the result of an individual examination of the scholars. As a result of the vice-regal commission of 1898, power was taken to introduce a system of school inspection, though not to dispense with the individual examination as the basis for the award of the grants; this measure of reform was ultimately carried out in 1909. The sum distributed in result grants is about £50,000 per annum.

Prior to the Agriculture and Technical Instruction (Ireland) Act 1899, science and art grants were administered by the Science and Art Department in England; by this act they were transferred to the new Irish Department for Agriculture and Technical Instruction. This department makes block grants to secondary schools in respect of science and art teaching, and manual instruction or domestic economy. Measures have been taken for the co-ordination of the duties of the Technical Department and the Intermediate Board, and the impetus given to the teaching of experimental science by grants for the erection of laboratories represents a reform of undoubted value for higher education in Ireland, especially when considered in connexion with the enlistment of the local interest of the technical education committees in the intermediate schools. Nevertheless, in the absence of a reform of the results system of intermediate grants, the special subsidizing of science teaching has tended to put an undue premium upon this subject to the detriment of the rest of the curriculum.

Ireland possesses no such system of scholarships for assisting the passage of scholars from the elementary to the secondary school as England enjoys as a result of the municipalization of the educational system. Nevertheless, Irish children as a fact pass much more freely from the elementary to the secondary school than is the case in England where social prejudices are stronger. The schools of the Christian Brothers are usually organized in two departments, primary and intermediate, and thus supply for the Roman Catholic population the demand for the cheap type of secondary day school represented by the municipal schools in England. It must be added that the Irish intermediate schools are purely denominational. The widespread demand for secondary education among the people, to which the report of Messrs Dale and Stephens bears witness, is a gratifying feature of Irish life, while the recent establishment (1908) of the long-deferred national university, and the perceptible quickening of intellectual interests throughout the country in connexion with the Celtic revival, point to better conditions for higher education and to the development of a wider, deeper and truer, because more national, culture.

England.

It was justly observed by Sir Joshua Fitch (*Ency. Brit.*, 10th ed., xxvii. p. 655) that "the public provision for the education of the people in England is not the product of any theory or plan formulated beforehand by statesmen or philosophers; it has come into existence through a long course of experiments, compromises, traditions, successes, failures and religious controversies. What has been done in this department of public policy is the resultant of many diverse forces and of slow evolution and growth rather than of pure purpose and well-defined national aims. It has been effected in different degrees by philanthropy, by private enterprise, by religious zeal, by ancient universities and endowed foundations, by municipal and local effort, and only to a small extent by legislation. The genius—or rather characteristic habit—of the English people is averse from the philosophical system, and is disposed to regard education, not as a science, but as a body of expedients to be discovered empirically and amended from time to time as occasion may require." Clearly, then, the English system of public education, as it results from successive

acts of the administration and the legislature, is one which can only adequately be appreciated in the light of an historical survey of the various stages which have led up to it and the social conditions by which they were determined. The history of state education in England begins tardily in 1832, when after a generation of hesitation and controversy a beginning was made upon an exceedingly modest scale with the system of treasury grants in aid of elementary schools. The diverse forces which were at that date at work in the education of the nation as a whole, retarding state interference and marking out the limits within which it was long to be confined, derive their origin from a much remoter period.

The apprenticeship laws of Henry VIII. contain the earliest germ of state interference. These laws obliged children between five and thirteen years of age who were found begging or idle to be bound apprentices to some handicraft. If the immediate object was the prevention of crime rather than education as such, this early legislation is at least significant of the primary and intimate connexion that exists between popular education and industrial and economic needs. Yet in the shaping of the educational system the original influences were religious rather than economic; hence the importance of the canons of 1604, *Influence of the English Reformation.* which secured the control of education to the Established Church. This of course was no novel doctrine, but merely the reaffirmation by the Reformed Church of the Catholic tradition of religious exclusiveness, presenting itself to the mind of contemporaries rather as the recognition of a national, that was also a religious, duty than as the assumption of an ecclesiastical privilege. Whatever mischief the Tudor statesmen wrought by indiscriminate destruction of chantries and other foundations which combined educational work with observances that the new religion branded as superstitions, however far the English Reformation fell short of the organized enthusiasm for popular education and culture that marked the first most vigorous and constructive period of Lutheranism in Germany, the Protestant, and especially the Puritan, spirit unquestionably inspired a considerable volume of individual educational effort during the latter half of the 16th and the first half of the 17th centuries. Here, as in Germany, the influence of the Reformation was wholly on the side of classicism, the dead languages being the key to the theological learning which was of primary concern to the men of that theological age. The conception of elementary education as a system complete in itself and adapted to the needs of the masses of the people was unfamiliar at this date. The earliest elementary schools were *petits* schools, which (as the name implies) were really preparatory departments of the grammar-schools. Education in fact was still regarded as the privilege of an élite, but, as in the middle ages, the élite for whom it was sought to provide a ladder to the university by means of the endowed schools so numerous founded about this time was an élite of intellect and not of mere wealth; the class feeling which became so marked a feature of English higher education was of much later growth.

Towards the end of the 17th century elementary education began to differentiate itself, partly by way of reaction against the unnatural classicism of the preceding age, but more *rise of elementary education.* especially as the result of the growth of towns and the creation of a considerable industrial population. At the close of the century the moral evils attendant upon industrialism alarmed the religious conscience and prompted one of the great educational movements that stand to the credit of the national church. In 1699 Dr Bray founded the Society for Promoting Christian Knowledge, and the movement thereby initiated may be traced in the numerous "charity" or "Blue Coat" schools scattered plentifully throughout the country and especially in the great centres of population. The foundation of these schools, which was pushed forward with vigour during the early years of the 18th century, represents an energetic and well-planned attempt to cope with the social evil of poverty by educational means. The instruction was elementary, the scholars were clothed as well as taught free, and the schools in the first instance were supported not so much by permanent endowment

as by voluntary effort, so that with this movement the voluntary system may be said to make its appearance. Lastly, all these philanthropic efforts were inspired by a solid but sober piety nurtured by a church which came nearer than at any other period of its history to enjoying the undivided allegiance of the people. Another notable movement in connexion with the church was one confined to Wales, that of the Welsh "circulating schools" established by Griffith Jones about 1730, consisting of an organized staff of schoolmasters who went round teaching adults to read the Bible in Welsh. In the English rural parishes the comparative religious unanimity favoured the quiet development of elementary education in a small way upon less specifically religious lines. Numerous small endowments for the elementary education of poor children were provided by well-to-do parishioners; indeed to such an extent did the practice of making charitable (and largely educational) bequests increase that the legislature intervened in the interest of private inheritance by reviving the law of mortmain in an act of 1736. The village schoolmaster became a feature of rural life, frequently enjoying a schoolhouse provided sometimes by endowment and sometimes even directly by the parishioners at the cost of the rate levied by the vestry, but more often aided only by a little stipend from an endowment for teaching poor children, and eking out an always scanty subsistence by the fees of such paying scholars as he could succeed in getting together.

Towards the end of the 18th century the emergency of the industrial revolution evoked a fresh religious effort upon a more highly organized scale in the shape of the Sunday-school movement, which may be said to represent the educational contribution of the Evangelical revival movement. Robert Raikes, the founder of the Sunday School Union, established his first Sunday school in 1782. The idea of the Sunday school did not originate with Raikes; among earlier pioneers in this field were John Wesley, who held Sunday classes at Savannah in 1737; Theophilus Lindsey at Catterick in the North Riding of Yorkshire, about 1769; Hannah Ball at High Wycombe in 1769; and Jenkin Morgan near Llanidloes in 1770. Sunday schools, too, had been founded in England by Joseph Alleine, the Puritan Father, in the 17th century, and in Catholic Italy and France by St Charles Borromeo and Jean Baptiste de la Salle in the 16th and 17th centuries respectively. Nevertheless, in virtue of his achievement in organization, Raikes is rightly regarded as the founder of the English Sunday school. The peculiar value of the Sunday-school system in its early days lay in the combination of secular with religious instruction; in many cases the school was held on Saturday as well as Sunday, and its restriction to the one day or two days was due to the prevalence of child labour under stress of the great industrial expansion. With better economic conditions and with the development of day schools the Sunday schools gradually became restricted in function to purely religious instruction. Even with this limitation there is no doubt that the great Sunday-school organizations of the various churches still deserve to be reckoned among the educational assets of the nation, and as agencies both of religious instruction and of general culture they may tend, under modern educational and religious developments, to play an increasingly important part.

At the end of the 18th century the development of industry and the social unrest which followed the French Revolution combined to bring home to the public mind the need of a national system of day schools. Unfortunately, just at this moment the revival of Nonconformity as the result of the religious vitality of the Evangelical movement shattered the religious peace of the early Hanoverian period and divided the nation once more into hostile camps, to which class distinctions lent additional bitterness. The famous controversy between Andrew Bell and Joseph Lancaster and their respective followers in the opening years of the 19th century served to define the religious difficulty substantially in the form in which it exists after the lapse of a century for the present generation. Both these remarkable men conceived independently the idea of a national

system of popular education upon a voluntary basis; both concurred in extolling the merits of the monitorial system, which each claimed to have originated. The controversy between them, begun upon personal grounds, resolved itself into a national contest of rival principles of religious teaching. Lancaster as a young Quaker schoolmaster, confronted with pupils drawn from various religious bodies, planned his religious instruction upon the lines of doctrine common to all the orthodox Christian denominations. Thus he is the father of the undenominational religious teaching which later formed the basis of the Cowper-Temple compromise. But whereas the Cowper-Temple clause is purely negative in form and so seems to point to an undogmatic religion, the Lancasterian teaching was essentially positive and dogmatic within its limits. In 1805 Mrs Trimmer opened the attack upon Lancaster's system with a work bearing the expressive title of *A Comparative View of the New Plan of Education promulgated by Mr Joseph Lancaster and of the System of Christian Instruction founded by our Forefathers for the initiation of the young members of the Established Church in the Principles of the Reformed Religion*. The church as a whole refused to co-operate in religious teaching upon the basis of a common Christianity, and joined issue with Lancaster and his Whig and Nonconformist following not merely upon the question of the exclusion of dogmatic formularies, but also upon the question of the control of whatever religious teaching should be given. In fact the vital question at this period was whether the clergy of the Established Church were to control the national education. The religious issue was prominent in connexion with the remarkable attempt at legislation made by the Whig statesman Mr Whitbread in his Parochial Schools Bill of 1807. As originally introduced, the bill proposed to make it compulsory on parochial vestries to levy rates for the support of schools for teaching reading, writing and arithmetic. The compulsory provisions were dropped in the House of Commons, but the bill was rejected by the Lords, mainly on the ground that it did not place education on a religious basis or sufficiently secure control to the minister of the parish.

The failure of the liberal proposals of Whitbread, and the strength of the Dissenting opposition to any settlement on purely church lines (such as that advocated by Bell in 1808 for establishing schools under the control of the parochial clergy), rendered recourse to voluntary effort inevitable. In 1808 the Royal Lancasterian Society was formed to carry on the work of Lancaster, the name being afterwards changed, owing to personal difficulties due to the wayward character of Lancaster, to the British and Foreign School Society. In the following year the National Society for Promoting the Education of the Poor in the Principles of the Established Church throughout England and Wales was formed, with Bell as its superintendent. In voluntary effort on a grand scale the church easily outdistanced her opponents, and in 1831 the National Society was able to show that there were in all over 13,000 schools in connexion with the church, of which 6470 were both day and Sunday schools, having a total attendance of 400,000.

The rapid development of the voluntary school system was no doubt greatly facilitated by the monitorial plan of teaching, upon which Bell and Lancaster equally relied. Probably the first idea of utilizing the older pupils to teach the younger presented itself independently to Lancaster in the Borough Road and to Bell in Madras. The monitorial plan never rested upon any educational theory; it was simply a makeshift, a rough-and-ready expedient for overcoming the practical difficulty caused by the dearth of competent teachers. Historically it is important as the precursor of the pupil-teacher system which so long formed the exclusive basis of the English elementary system.

Meantime a further political move was attempted by Brougham, who included educational reform among his multifarious activities. In 1816 he procured the appointment of a general commission of inquiry into endowed charities. The labours of this great inquisition lasted for twenty years and led

The Sunday-school movement.

Movement of Lancaster and Bell, and rise of the religious controversy.

Foundation of voluntary schools.

Monitorial system.

to the reformation of many cases of abuse or waste of wealthy endowments, and eventually to the establishment of the Charity Commission in 1853. In 1820 Brougham introduced a remarkable bill which proposed to make the magistrates in quarter sessions the rating authority, to require teachers to be members of the Church of England and to be appointed upon a certificate from the parochial clergyman, and on the other hand to prohibit religious formularies and to confine religious instruction to Bible reading without comment. The bill naturally failed through the opposition of the Dissenters, and served only to accentuate the religious impasse.

In 1832 the Whig government which passed the Reform Bill placed on the Estimates a sum of £20,000 for public education, thus initiating the system of the annual grant voted by parliament and dispensed under regulations framed by administrative act. The grant of 1832 was administered by the treasury and not by a special department, under certain conditions laid down by treasury minute of August 30, 1833. The chief of these were that grants were confined to the erection of school buildings, and were to be administered only through the National and the British and Foreign School societies; there was a provision for audit, but no condition of inspection.

In 1839 Lord Melbourne's government by means of an order in council established a separate education office under the style of the Committee of Council on Education, and the sum voted by parliament was increased to £39,000. The original intention of the government was to establish a state normal school or training college as the foundation of a national system of education. Unfortunately this design had to be abandoned in view of the religious difficulty, with the result (so fruitful in controversy at the present time) that the training of elementary teachers was left in private hands and became a stronghold of the voluntary and denominational interests. In view of the limited resources placed at their disposal by parliament, the Committee of Council were at first compelled to confine their assistance to capital grants in aid of the provision of school buildings, but in the distribution of the money three important conditions were at once imposed. In the first place, the continuing right of inspection was required in all cases; secondly, promoters were obliged to conform to a fixed standard of structural efficiency; thirdly, the building must be settled upon trusts permanently securing it to the education of poor children.

By the minute of August 10, 1840, the Committee of Council concluded what came to be known as the concordat with the church. Under this minute no appointment was to be made of any person to inspect schools in connexion with the Church of England without the concurrence of the archbishop of the province, and, what seems still more extraordinary to modern ideas, any such appointment was to be revoked should the archbishop at any time withdraw his concurrence. The inspectors were charged with the duty of inspecting religious teaching, but under instructions to be framed by the archbishop, and their reports were to be transmitted in duplicate to the archbishop and the bishop for the information of these authorities. Further, the general instructions of the Committee of Council themselves were to be communicated to the archbishop before being finally sanctioned. The march of events, and in particular the altered financial relations between the state and the voluntary managers brought about by the institution of maintenance grants, soon rendered this concordat obsolete, but it remains historically important as showing how at the outset the denominational principle was recognized and fostered by the state.

Among the first acts of the Committee of Council was the promulgation of a set of model trusts deeds, one or other of which applicants for building grants were required to adopt for the settlement of their school premises. The necessary conditions were the permanent appropriation of the site to purposes of education, and the permanent right of government inspection; it must, however, be noted that this

latter right was generally limited in terms to the inspection provided for by the minute of August 10, 1840. A conscience clause was not obligatory, and indeed was only offered in the limited form of exemption from instruction in formularies and attendance at Sunday school or public worship. A more systematic attempt to promote public control by means of trust deeds in 1846 led the Committee of Council into a controversy with the National Society which extended over a period of three years, turning chiefly upon the management clauses and the question of appeals, and resulting in compromises which constituted a fresh concordat with the church. In point of fact, the management clauses proved to be of little practical consequence, save in a few controversial cases, until the act of 1902, which had the effect of bringing them once more into prominence in connexion with the constitution of statutory bodies of foundation managers. The act of 1902 also dealt specifically with two other points arising upon the old trust deeds, viz. the control of religious instruction and the appeal to the bishop in religious questions. Special facilities for the conveyance of land for school purposes were afforded to limited owners by the School Sites Act of 1841 and subsequent years. The landed gentry responded with great public spirit to the call thus made upon their generosity by the state, with the result that the vast majority of rural, and many urban, parishes were freely endowed with sites for elementary schools.

Trust deeds.

Establishment of State-aided system.

Concordat with the church.

Grammar Schools Act 1846.

Training-college grants.

Pupil-teacher system.

Extension of state aid to Wesleyan, Roman Catholic and Jews.

In 1843 the Committee of Council decided to make grants in aid of the erection of normal schools or training colleges in connexion with the National Society and the British and Foreign School societies, thus marking the definite abandonment of the provision of training colleges to voluntary effort.

In 1846 an important step forwards was taken in the foundation of the pupil-teacher system. The regulations of this year inaugurated annual maintenance grants in the form of stipends for apprenticed pupil teachers receiving a prescribed course of instruction under the head teacher, and a lower grade of stipendiary monitors in schools where such instruction could not be provided. These regulations inaugurated the system of Queen's Scholarships to assist pupil teachers to proceed to a training college; they also established capitation grants for the support of such colleges, and annual grants to elementary schools under government inspection of from £15 to £30 in aid of the salary of every trained teacher employed. Provision was at the same time made for retiring pensions to elementary teachers.

Down to 1847 state aid was confined to two religious categories of schools: those giving specifically Church of England teaching, and those in connexion with the British and Foreign School Society giving simple Bible teaching. To facilitate the recognition of other denominational schools the Committee of Council in 1847 issued a *Wesleyan*, minute dispensing schools not connected with the Established Church from inquiries concerning their religious condition, and in the same year state aid was extended to Wesleyan and Roman Catholic schools. The settlement of model trust deeds gave occasion for each of these two great religious bodies to negotiate a kind of concordat with respect to school management, and the Roman Catholic deed was only settled after a controversy, similar to that which had arisen

Extension of state aid to Wesleyan, Roman Catholic and Jews.

Extension of state aid to Wesleyan, Roman Catholic and Jews.

Extension of state aid to Wesleyan, Roman Catholic and Jews.

Extension of state aid to Wesleyan, Roman Catholic and Jews.

Extension of state aid to Wesleyan, Roman Catholic and Jews.

Extension of state aid to Wesleyan, Roman Catholic and Jews.

Extension of state aid to Wesleyan, Roman Catholic and Jews.

Extension of state aid to Wesleyan, Roman Catholic and Jews.

with the National Society, as to the rights of ecclesiastical authority. Jewish schools received recognition in 1851 upon condition that the Scriptures of the Old Testament should be daily read in them.

During the middle years of the century various unsuccessful legislative attempts were made to establish a national system of elementary schools upon the basis of rate-aid. These attempts began with the education clauses of Sir Robert Peel's Factory Bill of 1824, and were renewed in a series of bills from 1853 to 1857, of which one set was introduced by Lord John Russell on behalf of the Whig government, whilst a second was promoted by an organization called the Manchester and Salford Committee on Education, in the denominational interest, and a third set by an organization called the Lancashire (afterwards the National) Public Schools Association, in the secular interest. The only one of these attempts which calls for notice here is the bill introduced by Lord John Russell (called the Borough Bill, on account of its being restricted to municipal boroughs) in 1853, and forming part of a comprehensive scheme of legislative and administrative reform of which a portion was actually carried into effect. The bill as a measure for elementary education was supplemented by an administrative system of capitation grants for rural areas. The government scheme also comprised a measure dealing with the administration of charitable trusts (which took shape as the Charitable Trusts Act 1853), the constitution of the Department of Science and Art, and university reform upon the lines recommended by the Oxford and Cambridge commissions. The Borough Bill left it optional with municipalities to adopt the act. It provided for the appointment of a school committee, one half of whose members might be non-members of the council. The school committee was merely given power to assist existing voluntary schools out of the rates. No provision was made for public control beyond the requirement of audit; the sole condition as to religious instruction was the acceptance of a conscience clause.

The failure of the Borough Bill did not affect the new system of capitation grants which was introduced by minute of the Committee of Council dated April 2, 1853. These grants were fixed at a scale varying from 3s. to 6s. per head, payable upon certain conditions, of which the most important were that the school must be under a certificated teacher, and that three-fourths of the children must pass a prescribed examination. In consequence of the failure of the several fresh bills introduced in 1855 by the government, the church party and the secular party respectively amplifying the proposals previously brought forward, the capitation grant was, by minute of January 26, 1856, extended to urban areas. As in the case of all the early grants, the regulations governing the distribution of the capitation grants were framed upon the principle that subventions of public money must be met by local funds derived from voluntary contributions, endowments and school fees; thus the basis of the denominational system as fostered by the state at this stage was one of financial partnership.

In 1856 a purely administrative bill was passed, establishing the office of vice-president of the Committee of Council on Education as a minister responsible to parliament. At the same time, the Science and Art Department was transferred from the Board of Trade to the Committee of Council.

The progress of state-aided education during this period may be measured by the increase of the annual parliamentary grant, which rose from £30,000 in 1830 to £100,000 in 1846, £150,000 in 1851, £306,000 in 1855, and £663,400 in 1858. This expansion was viewed with misgiving by the friends of the denominational system, and by the strong individualist school of that day, who upon wider grounds clung to the old ideal of voluntary initiative. These sections combined with the advocates of further state intervention to press for a commission of inquiry, and at the instance of Sir John Pakington (the eminent Conservative educationist who was responsible for the denominational bills of the 'fifties) a royal commission was appointed in 1858, under the chairman-

ship of the duke of Newcastle, to inquire into the state of popular education in England, and to consider and report what measures, if any, were required for the extension of sound and cheap elementary instruction to all classes of the people. The *Report* of the Newcastle Commission, issued in 1861, contains an exhaustive account of the existing condition of elementary education, and, with due allowance for the grave defects revealed, and in particular the glaring inefficiency of the numerous little private-venture schools kept by "dames" and others, the graphic picture drawn by the commissioners constitutes a striking tribute to the sterling qualities of self-help and religious earnestness which were so characteristic of the early Victorian period. It was found that in round numbers about 2,500,000 children were attending day schools, the proportion to population being 1 in 7, as compared with 1 in 9 in France, 1 in 8 in Holland, and 1 in 6 in Prussia, where education was compulsory. On the other hand, of this number only 1,675,000 were in public schools of all kinds, only 1,100,000 in schools liable to inspection, and 917,000 in schools receiving annual grant. The result was that only one child in every twenty was attending a school whose efficiency could be in any way guaranteed by the state. In the constructive portion of their work the comments and recommendations of the commissioners reflected the prevailing perplexity of the public mind. A consistent individualistic minority considered that the annual grant should be withdrawn altogether, and that any further state aid should be confined to building grants, which they would concede not as desirable in themselves but as necessitated out of considerations of fairness to the parishes that had not yet received such aid. The commissioners as a body rejected free and compulsory education in view of the religious difficulty and upon general grounds of individualistic principle. Of the religious difficulty itself the commissioners had some wise words to say which hold good in substance at the present time. In their judgment the considerable evidence they had amassed conclusively proved that the religious difficulty originated with the managers, promoters and organizers of the schools, and not with the parents themselves; yet the indifferent or comparatively passive attitude of the people nowise materially diminished the practical difficulty of introducing a comprehensive system, since it was not with the body of the people but with the founders and supporters of schools that legislators would always have to deal. In view of the solution adopted in 1902 it is of interest to note that the Newcastle Commissioners deliberately rejected the parish as unfit to be taken as the unit of elementary education upon the ground that management by parochial ratepayers must tend to be illiberal and niggardly, bent upon economy of the rates to the detriment of educational interests; accordingly they recommended the constitution of county boards (which in the absence of elective councils must needs originate with quarter sessions) clothed with power to levy a rate for the aid of existing voluntary schools.

The one definite achievement of the Newcastle Commission was the famous system of payment by results, which may be said to have excited a keener and more prolonged controversy than any other measure of a purely educational character. Impressed by the defects of the existing teaching, the commissioners reported that there was only one way of securing efficiency, and that was to institute a searching examination by competent authority of every child in every school to which grants were to be paid, with the view of ascertaining whether the indispensable elements of knowledge were thoroughly acquired, and to make the prospects and position of the teacher dependent to a considerable extent upon the results of this examination. Thus the commissioners hoped to counteract what appeared to them to be the crying defect of the existing training college system, viz. that it tended mainly to adapt the young schoolmaster to advance his higher, rather than to thoroughly ground his junior, pupils. They recognized that to raise the character of the children, both morally and intellectually, was and must always be the highest aim of education, and they were far from desiring to supersede this by any plan of a mere examination into the more mechanical

Bills of 1842-87.

Capitation grants.

Education in 1856.

Newcastle Commission.

Payment by results.

work of elementary education, the reading, writing and arithmetic of young children; but they thought that the importance of this training, which must be the foundation of all other teaching, had been lost sight of, and that there was justice in the common complaint that while a fourth of the scholars were really taught, three-fourths after leaving school forgot everything they had learnt there.

Mr Lowe (Lord Sherbrooke) as vice-president of the Committee of Council (1859-1864) adopted the system of payment by results in what became famous in history as the Revised Code, issued in 1862 and so called because it was a revision of the minutes and regulations of the Committee of Council, which were first collected and issued in the form of a code in 1860. The Revised Code provided for the payment of a grant of 4s. upon the old principle and a further grant of not more than 8s. upon the result of examination. Mr Lowe declared of the system in the House of Commons that "if it was costly it should at least be efficient; and if it was inefficient it should at least be cheap." In fact, it proved to be cheap; the grant fell from £813,400 in 1861 to £636,800 in 1865. The upholders of the existing system denounced the Revised Code as an undeserved slight upon the voluntary managers, and even as a breach of faith with the great religious denominations. On purely educational grounds, which need not be here recapitulated, it was at once viewed with misgiving by many authorities, including Matthew Arnold. To meet objections, some modifications were introduced in the code under the Conservative government in 1867. The system of paying grant upon the result of individual examination of the scholars was not finally abolished till 1904.

The years immediately preceding 1870 were occupied with discussion and preparation for the great legislative measure for which the time was now felt to have arrived. Good work was done in this direction by the Select Committee of the House of Commons in 1866, over which Sir John Pakington presided. For reasons connected with the political situation of the moment this committee never reported, but the minutes of evidence and the draft report prepared by Sir John Pakington contained much valuable material in the way of criticism of the existing system and suggestion for the coming settlement; in particular the draft report insisted upon the inevitableness of an education rate. In 1868 the Conservative government brought in, but did not proceed with, an education bill deliberately discarding the principle of rate-aid on the ground that it would destroy voluntary contributions and gradually starve out the denominational schools. In 1867 and again in 1868 Mr Bruce (afterwards Lord Aberdare), Mr W. E. Forster and Mr Algernon Egerton introduced a bill which formed the basis of the measure of 1870. As redrafted in 1868 the bill of Mr Bruce and his coadjutors proposed a universal system of municipal and parochial rating with liberty for voluntary schools to unite themselves to the rate-aided system under their existing management, subject to the acceptance of a conscience clause. The bill also proposed to empower town councils to co-opt outsiders upon their education committees. Thus both in the principle of co-optation and in the extension of rate-aid to schools not under public control the bill of these Liberal statesmen in 1868 anticipated certain controverted features of Mr Balfour's Education Act of 1902. In the meantime, in the country the Education League, originated at Birmingham, was carrying on a propaganda in favour of free secular schools, whilst the Education Union, formed to counteract the influence of the league, urged a settlement upon the old lines. As a concession to the popular feeling against secularism, the league proposed to allow Bible reading without doctrinal exposition. Thus opinion was sufficiently focussed to enable Mr Gladstone's administration in 1870 to undertake the comprehensive measure of educational reform for which the country had had to wait so long.

The Elementary Education Act of 1870 bore in every respect the marks of compromise. As Mr Forster explained in introducing the bill, the object of the government was "to complete

the voluntary system and to fill up gaps," not to supplant it. To this end the Education Department was charged with the duty of ascertaining whether or not there was in every parish a deficiency of public school accommodation, and provision made for the formation of school boards in every school district (*i.e.* parish or municipal borough) requiring further public school accommodation. Such accommodation might consist either of public elementary schools as defined by the act, or other schools giving efficient and suitable elementary education. The definition of public elementary school contained in section 7 of the act is still in force. Shortly, a public elementary school is a school subject to a conscience clause entitling scholars to complete exemption from all religious instruction and observance whatsoever. Any religious instruction or observance in the school must be either at the beginning or the end of the school meeting. The school must also be open at all times to the government inspectors and must be conducted in accordance with the conditions required to be fulfilled in order to obtain an annual parliamentary grant. In the same connexion an important change was made in the conditions of inspection by declaring that it should be no part of the duties of the inspector to inquire into religious instruction, whilst a later section of the act provided that no parliamentary grant should be made in respect of any religious instruction.

Three important changes were made in the measure during its passage through parliament. As at first proposed, (1) the school boards were not to be directly elected by the ratepayers, but were to be appointed by the town council or the vestry. (2) These nominated boards were empowered either to provide schools themselves or to assist existing public elementary schools, provided that such assistance was granted on equal terms to all such schools, upon conditions to be approved by the Education Department. Thus the school board, if it exercised the option of assisting denominational schools, would have been obliged to assist all or none. (3) With regard to its own schools, the school board was to settle the form of religious instruction. These proposals raised serious opposition in the country, and when the committee stage of the bill was reached two fundamental changes were made in the policy of the bill. In the first place, as Mr Gladstone put it, the government had decided "to sever altogether the tie between the local board and the voluntary schools." In lieu of the suggested rate-aid they proposed an increased grant from the treasury, that is to say, the voluntary schools were left standing as state-aided schools under private management, side by side with the new rate-supported schools.

Next, the character of the religious instruction in the board schools was determined upon an undenominational basis by a provision which has become known to history after the name of its author, then Mr Cowper-Temple, as the Cowper-Temple clause (section 14 of the act), directing that "no religious catechism or religious formula which is distinctive of any particular denomination shall be taught in the school." The clause was not intended to exclude doctrinal exposition, and was in fact a compromise not merely between absolute secularism and denominationalism, but between denominationalism and the view of those who would have the Bible read without note or comment. The Apostles' Creed as a symbol common to all denominations of Christians was held by Mr Forster (at the suggestion of Mr Gladstone) not to be excluded under the Cowper-Temple clause. The result was the establishment in the schools, upon the lines laid down by Joseph Lancaster at the beginning of the 19th century, of what may be termed the common Protestantism of the English nation; and though Mr Disraeli urged that a religion without formularies was in fact a new religion, and that in leaving its exposition to the teachers we were creating a new sacerdotal class, the Cowper-Temple compromise, notwithstanding its inherent want of logic, stood the test of experience for more than a generation against the consistent denominationalists on the one hand and the party of secular education on the other. It is important to observe that the act of 1870 left the giv-

Act of 1870.

Revised Code.

Proceedings preliminary to the act of 1870.

Cowper-Temple clause.

religious instruction, whether in voluntary schools (in which its inclusion might be assumed as of course) or in board schools, purely permissive. In practice it was only in Wales that school boards availed themselves to any extent of the liberty to abstain from giving religious instruction, and this comparative secularism of Wales certainly argued no lack of religious life among the people.

The third change in the bill was the substitution of the *ad hoc* school board for the municipally appointed board originally proposed, a change which commended itself in view of the special difficulty presented by the case of London. These boards were elected by the system of cumulative voting under which each elector had as many votes as there were candidates to be elected, with liberty to give all his votes to one candidate or to distribute them amongst the candidates as he thought fit. This system was much criticized as being unduly favourable to minorities, whose representation it was devised to secure; it continued, however, until the supersession of the *ad hoc* authorities by committees of the county and urban councils under the act of 1902.

School boards were empowered not only to acquire sites for schools under powers of compulsory purchase, but also to take transfers of existing voluntary schools from their managers. The section which enables managers to transfer schools to the school board or local education authority for the purpose of board or council schools freed from religious trusts unquestionably marks an important inroad by the state upon the sanctity of trusts. Thus though the act of 1870 did not itself introduce the principle of compulsory transfer, it formed the point of departure for the proposals in this direction which were the basis of the unsuccessful bills of 1906 and 1908. The act of 1870 did not introduce either direct compulsory attendance or free education, but it took a distinct step forward in each direction by enabling school boards to frame by-laws rendering attendance compulsory, and also to pay the school fees in the case of poverty of the parent.

The policy of compromise between the two systems of voluntary and rate-established schools was carried out in the provisions relating to the future supply of schools. On the one hand, building grants were continued temporarily for the benefit of those who applied (as voluntary managers alone could apply) before the 31st of December 1870. On the other hand, the Education Department was authorized to refuse parliamentary grants to schools established in school board districts after the passing of the act if they thought such schools unnecessary.

The following figures are of interest as showing the progress made under the act of 1870. In the year 1870 there was accommodation in inspected day schools for about 2,000,000 children; the average attendance was 1,168,000, and the number on the books about 1,500,000. It was computed, however, that there were, exclusive of the well-to-do classes, at least 1,500,000 children who attended no school at all or schools not under inspection. In 1876 accommodation had been provided for nearly 3,500,000, and of the 1,500,000 new places nearly two-thirds were provided by voluntary agencies. "These voluntary agencies," says Sir H. Craik, "had received grants in aid for about one-third of the schools they had built, the grants defraying about one-fifth of the cost of the aided schools." On the other hand, the growth of school boards was rapid and continuous, notwithstanding the permissive character of the act and the strenuous efforts of the voluntarists to keep pace with the new demands. In 1872, 9,700,000 of the population were under school boards, and of these 8,142,000 were under by-laws; in 1876 the numbers were respectively 12,500,000 and 10,400,000. In the same period the annual grants increased from £894,000 in 1870 to £1,600,000 in 1876.

The development evidenced by the above figures, and in particular the fact that 52% of the population were subject to by-laws, enabled Mr Disraeli's government in 1876 to take a notable step forward in the direction of universal direct compulsion. The act of 1876 embodied the declaration that "it shall be the duty of the parent of every child to cause such child to receive efficient elementary instruction in

reading, writing and arithmetic, and if such parent fail to perform such duty he shall be liable to such orders and penalties as are provided by the Act"; next, it rendered an employer liable to a penalty who took into his employment a child under the age of ten years, or a child between the ages of ten and fourteen years who had not obtained the required certificate of proficiency in reading, writing and arithmetic, or of previous attendance at a certified efficient school. In order to complete the machinery for compulsion, the act directed that, in every district where there was no school board, a school attendance committee should be appointed by the local authority. The law as to school attendance, resting upon this and subsequent enactments, is complicated and in some details obscure. The subject was dealt with in the report of an inter-departmental committee in 1909, who recommended the abolition of the partial exemptions permitted, and the raising of the age of exemption to 13.

In 1880 Mr Mundella, as vice-president of the Council in Mr Gladstone's administration, passed a short act which made the framing of by-laws compulsory upon school boards and school attendance committees, thus completing the system of universal direct compulsion. Under the acts of 1876 and 1880 the average attendance increased from 2,000,000 in 1876 to 3,500,000 in 1878 and 4,000,000 in 1881; in terms of percentage to population, 8.06 in 1876, 9.60 in 1878, and 10.69 in 1881. In the last-mentioned year the annual grant rose to £2,200,000, having more than doubled in the decade.

With the passing of the Elementary Education Act 1880 the education question entered upon a new phase. The country was now possessed of a national system of elementary education, in the sense that provision was made for the supply of efficient schools and for compulsory attendance. The question of free education was brought within the range of practical politics by the adoption of universal compulsion, but as yet it was advocated only by a small political group of pronounced collectivist tendencies. Whilst opinion was maturing on this topic, there began to force itself upon the public mind the vastly more difficult problem of combining the two systems of voluntary, denominational, state-aided schools on the one hand, and public, undenominational, rate-supported schools on the other. From the denominational point of view the problem presented itself as that of a burden imposed and a danger threatened in ever-increasing degree by the competition of the board schools, a competition that was felt not so much by direct rivalry of school with school as indirectly by the steady raising of the standard of efficiency with respect to buildings, equipment, salaries of teachers and educational attainment which inevitably resulted from the establishment of authorities with power to draw upon the rates. On the other hand, from the purely educational point of view, it was seen that the dual system tended in practice to an illicit but almost inevitable recognition of two standards of efficiency, the lower being conceded to voluntary schools in consideration of their comparative poverty. Experience, too, of the shortcomings of small country school boards was beginning to confirm the misgivings entertained long before by the Newcastle Commissioners as to the wisdom of entrusting autonomous powers to the parish, when the reform of local government by the creation of popularly elected county authorities turned attention once more to the question of organizing education upon a county basis.

In 1887 a royal commission under the presidency of Viscount Cross was appointed to inquire into the working of the education acts. The labours of this commission produced a thorough discussion of the educational problem in all its aspects, political, administrative, scholastic and religious. For any clear recommendations with regard to the reorganization of education generally the moment was not opportune, inasmuch as the commission just preceded the establishment of the new county authorities and the powers with respect to instruction other than elementary which parliament was shortly to confide to them under the Technical Instruction Acts. Nevertheless the report of the majority of the

Act of 1880.

Development of public opinion.

Cross Commission, 1887.

commissioners pointed unmistakably towards the solution adopted in the act of 1902, and their definite recommendation that voluntary schools should be accorded rate-aid without the imposition of the Cowper-Temple clause, served as the basis of that legislation. The commission brought into strong relief the opposing currents of thought in educational politics, the majority report, representing the principles of denominationalism, being balanced by a strong minority report embodying the views of those who looked for progress along the lines of the school-board system. Taken together, the two reports form a comprehensive survey of the difficulties which still in the main beset public education in this country.

Of the developments which followed the Cross report, it is convenient to mention in the first place, out of chronological sequence, the practical establishment of free education by the act of 1891, not by the absolute prohibition of school fees but by the device of a special grant payable by parliament in lieu of fees, called the fee grant. The result of this legislation and of subsequent administrative action was to place free education within the reach of every child, fees being retained (with few exceptions) only where some instruction of a higher elementary type was given.

The establishment of county councils by the Local Government Act 1888 introduced a new factor which was destined to exert a determining influence upon subsequent developments of public education. In the first place, it at once rendered possible the partial and experimental provision for higher education attempted by the Technical Instruction Acts, which affected secondary education as well as technical education in the proper sense of the term. In order to understand the state of secondary education at this period, it is necessary to refer back to the first attempts made to deal with secondary education a generation earlier.

In 1861, that is to say, nearly thirty years after the state began to concern itself with elementary education, the first step in the way of intervention in what is now called secondary or intermediate education was taken by the appointment of a royal commission, presided over by Lord Clarendon, to inquire into the condition of nine of the chief endowed schools in the country, viz. Eton, Winchester, Westminster, Charterhouse, St Paul's, Merchant Taylors, Harrow, Rugby and Shrewsbury. The report of this commission led to a statute, the Public Schools Act of 1864, which introduced certain reforms in the administration of seven of these schools, leaving the two great London day-schools, St Paul's and Merchant Taylors, outside its operation. The results achieved were seen to be important enough to call for a further and much wider inquiry.

Accordingly in 1864 the Schools Inquiry Commission was appointed under the presidency of Lord Taunton to inquire into all the schools which had not been included either in the commission of 1861 or the Popular Education Commission of 1858. It included several men of eminent distinction, such as Dr Temple (afterwards archbishop of Canterbury), Mr W. E. Forster, Dean Hoock, and Sir Stafford Northcote; and it was singularly fortunate in its staff of assistant commissioners, among whom were numbered Mr James Bryce, Mr Matthew Arnold, and Mr (afterwards Sir Joshua) Fitch. It thoroughly explored the field of secondary education, discussing all the problems, administrative and pedagogic, which the subject presents, and "its luminous and exhaustive report" (to quote the words of Mr Bryce's Commission of 1894) remains the best introduction to the problem of public secondary education in England. The existence of numerous and frequently very wealthy endowments arising from private benefactions and bequests has at all times been a feature in education as in other departments of English social life. In the organization of secondary education in particular, private endowments have played and continue still to play a part which cannot be paralleled in any other country. This circumstance has undoubtedly resulted in a great economy of resources, though in numerous instances the difficulties occasioned by the haphazard distribution of endowments and the local jealousies invariably

aroused by any attempt to readjust their areas to modern conditions have obstructed useful reform and proved a source of misdirected and wasted effort. At the date of the Schools Inquiry Commission the state of the ancient endowments was largely one of abuse. Very many endowments intended for advanced education were applied for instruction of a purely elementary character, and that of an inferior kind; indeed the possession of an endowment in a rural locality not infrequently operated to prevent the establishment of an efficient state-aided school. The evidence showed that the proportion of scholars in the country grammar-schools who were receiving some tincture of the classical education intended by the founders was steadily decreasing, and nothing had been done to bring the curriculum into harmony with the actual needs of the time. No doubt a small élite of classical scholars were sent to the older universities by these schools, but in the main they were in a feeble and decadent state, giving, more or less inefficiently, an education wholly unsuited to the wants of the class to whom they ministered. In addition to the general inelasticity of the curriculum, the special evils from which the grammar-schools suffered were the want of effective governing bodies and the freehold tenure of the headmasterships.

The commission was singularly successful in bringing about the reform of these abuses, its report being immediately followed in 1869 by the Endowed Schools Act, which was based upon its recommendations and conferred upon a special commission (united in 1874 with the Charity Commission) very wide and drastic powers of reorganizing ancient endowments. A direction for extending the benefits of endowments to girls did much to assist the movement for the secondary education of girls. The Endowed Schools Acts 1869-1874 introduced modifications of importance and general interest into the law of trusts. Under the existing rules of the court of chancery, which rules were also binding upon the Charity Commissioners, educational endowments were generally treated, in the absence of evidence to the contrary, as subject to a trust for instruction in the doctrines of the Church of England. Under the Endowed Schools Acts the presumption is reversed, and ancient trusts are treated as free from denominational restrictions, save in virtue of express conditions imposed by or under the authority of the founder. The result was that in framing schemes for the reorganization of ancient endowed schools the commissioners found themselves able to treat the majority of cases as undenominational. In such cases the general practice was to direct that instruction should, subject to a strict conscience clause, be given in the principles of the Christian faith; this provision corresponded in a way to the Cowper-Temple clause in elementary education, with the important distinction that it was positive, not negative, and did not exclude special doctrinal instruction.

Besides the recommendations for the reform of endowed schools, to which substantial effect was given directly or indirectly by means of the Endowed Schools Acts, the Schools Inquiry Commission also submitted proposals for the general administrative organization of a system of secondary education. They recommended the establishment of three authorities—(1) a central authority; (2) a local or provincial authority, representing the county or a group of counties, with a certain jurisdiction both in proposing schemes for the reform of endowed schools in their area (such as that afterwards conferred upon the joint education committees under the Welsh Intermediate Education Act), and in administering these schools; and (3) a central council of education charged with examination duties. Further, it was proposed to raise the level of proprietary and private schools by offering them inspection and examination and by establishing a system of school registration. Lastly, in order that the supply of public secondary schools might not be dependent upon endowments, it was proposed to confer upon towns and parishes powers of rating for the establishment of new schools. For these proposals as a whole the time was not ripe. The bill of 1869 as originally introduced in the House of Commons attempted to give effect, with some variatio-

Elementary Education Act 1891.

Education other than elementary.

Public Schools Commission, 1861.

Schools Inquiry Commission, 1864-68.

Endowed Schools Acts 1869-74.

Schools Inquiry Commission's proposals for reform of secondary education.

to one of these suggestions, namely, that for the creation of a central council, but exigencies of parliamentary time made it necessary to drop this part of the measure; the result was that the plan of the commissioners was only half carried out. Nevertheless, owing to the multiplicity and wealth of endowments, the work accomplished was sufficient to exert a considerable influence upon the secondary education of the country. Thus in 1895 Mr Bryce's Commission was able to report that schemes under the Endowed Schools Acts had been made for 902 endowments in England, excluding Wales and Monmouth, leaving only 546 endowments out of the total of 1448 endowments in England known to be subject to the Endowed Schools Acts, which had not felt the reforming hand of the commissioners. The total income of the endowments known to be subject to the Endowed Schools Acts, and therefore available for purposes of secondary education, according to the estimate of the Secondary Education Commission (still in 1909 the latest available source of complete information), was in 1895 about £735,000 gross.

Twenty years after the Schools Inquiry Commission the creation by the Local Government Act in 1888 of the representative and popular county authorities of which the need had been felt by reformers alike in secondary and elementary education, rendered the first step in the direction of the municipalization of secondary instruction at last possible. In 1889 the Technical Instruction Act (extended in some particulars by an act of 1891) empowered the councils of counties, boroughs and urban districts to levy a rate (not exceeding a penny in the pound) for the support or aid of technical or manual instruction. Comparatively few councils were prepared to resort to their rating powers, but progress under these acts was greatly facilitated by the Local Taxation (Customs and Excise) Act of 1890, which mentioned technical instruction as one of the purposes to which the imperial contribution paid to local authorities in respect of the beer and spirit duties might be applied. By virtue of the very liberal interpretation given to technical instruction by these acts the financial assistance afforded under them was extended to cover the whole field of mathematical and physical science, as well as modern languages.

The Department of Science and Art acted as an agency in the development of secondary education upon the same lines as the Technical Instruction Acts, administering a parliamentary grant which was gradually extended with a view to encouraging literary studies as well as the scientific and mathematical subjects to the promotion of which it was primarily directed. Thus the combined effect of the local resources available under the Technical Instruction Act and the imperial grant administered by the department was gradually to develop a national system of secondary education with a marked bias on the side of physical science.

An undoubted stimulus was given to secondary education in the great centres of industry during the last quarter of the 19th century by the rise of the new university colleges, among which must be reckoned those established expressly for women. In the main the influence of these new institutions made for a non-classical and scientific type of curriculum in the popular secondary schools.

At the same time, the pressure of the school boards influenced secondary education in two ways. In the first place, the elementary schools were found to act as feeders for schools of a higher type, and the idea of the "educational ladder" began to play a leading part in plans for the organization of national education. It was seen that there must be schools to which the more advanced scholars could pass from the public elementary schools, and scholarships to assist such scholars to continue their education in this way. In the next place, it was recognized that to provide adequately for the further education of public elementary scholars a new type of school was required. Thus there came into being through the initiative of the great school boards what were known as higher-grade elementary schools. These

were really secondary schools of the third grade, and, as the Commission on Secondary Education observed, the school boards simply stepped in to fill the educational void which the Schools Inquiry Commissioners had proposed to fill by schools of that name. The happy obscurity of the legal definition of elementary education left these schools free to develop during the long years of the neglect of secondary education by the state, and when in 1901 the famous judgment in the test case of *Rees v. Cockerill* pronounced them to be illegal, it was at once recognized that the legislature must without delay step in to secure the educational work which the undoubtedly correct principles of judicial interpretation had placed in jeopardy.

Such were the agencies at work in the domain of secondary education when in 1894 a royal commission was appointed under the presidency of Mr Bryce to inquire into this branch of education. The terms of reference excluded elementary education, and the report may be taken as embodying the views of that school of educational statesmen who held that progress would best be attained by keeping elementary and secondary education entirely separate for purposes of local administration, the parish being regarded as the natural unit for elementary and the county for secondary education, a topic to which it will be necessary to revert in connexion with the act of 1902. The principal recommendations of the commission were: (1) the unification of the existing central authorities, viz. the Department of Science and Art, the Charity Commission (so far as it dealt with educational endowments), and the Education Department, in one central office, and the establishment of an educational council to advise the minister of education in certain professional matters; (2) the establishment of local authorities, to consist of committees of the county councils with co-opted elements; (3) the formation of a register of teachers with a view to the encouragement of professional training, and a system of school registration upon the basis of inspection and examination. The first of these recommendations was carried out by the Board of Education Act 1899, as mentioned below, and under the same act an attempt was made to give some effect to the third-named object, which, though it unfortunately fell short of success, may serve as a point of departure for further efforts. The realization of the second, and the most important, of the recommendations was deferred till 1902, when it was brought about as a part of a wider reorganization of the educational system.

The religious difficulty in elementary education during the period immediately succeeding the report of Mr Bryce's Commission in 1895 once more reached an acute stage, and this circumstance was immediately unfavourable to a resolute handling of educational problems as such, public attention being largely concentrated upon the demand of the supporters of voluntary schools for relief from the growing financial burden which was laid upon them by that steady raising of the standard to which reference has been made above. In 1896 an endeavour was made to meet the demands of the voluntary managers by means of a bill introduced by Sir John Gorst on behalf of the Conservative government. This bill with its provision for a special aid grant to be administered by county education authorities, which were to exist side by side with the school boards, represented a kind of compromise between the systems of 1870 and 1902. It encountered opposition in all quarters and was withdrawn. In 1897, however, the position of the denominational schools was strengthened by the Voluntary Schools Act, which provided for a special aid grant of five shillings per head of the scholars in average attendance in these schools.

In view of the difficulties which beset any comprehensive treatment of the education question, partial effect was given to the recommendations of the Secondary Education Commission by the Board of Education Act of 1899, which abolished the office of vice-president of the council, united the Department of Science and Art with the Education Department in one central office under the title of the Board of Education, with a president and parliamentary

*Technical
Instruction
Acts
1889, &c.*

*Grants of
science
and art
department.*

*Influence
of new
universities
colleges.*

*Influence
of school
boards.*

*Secondary
Education
Commis-
sion,
1894.*

*Agitation
on behalf
of
voluntary
schools.*

*Board of
Education
Act
1899.*

secretary; and provided for the transfer to this board of the powers of the Charity Commissioners in relation to educational endowments; also for the association with the board of a consultative committee, consisting as to not less than two-thirds of persons qualified to represent the views of university and other bodies interested in education, for the purpose (1) of framing a register of qualified teachers, and (2) of advising the Board of Education upon any matters referred to the committee by the board. The administrative reorganization of the Education Office was completed shortly after the passing of the act of 1902, when a tripartite division was adopted to correspond with the three branches of education with which the Board of Education is concerned, viz. elementary, secondary and technological.

No law of recent years has excited an acuter or more prolonged controversy than the Education Act of 1902, and amid the dust of religious and political strife it is not easy for contemporaries to view it objectively and in its true proportions. Nevertheless, considered historically, the act becomes intelligible as the product of the forces, partly religious and partly educational, which have been already described. The immediate impulse for this measure must be sought in the agitation that during the preceding decade had been gathering force among the adherents of the Established and Roman Catholic churches for equality of financial treatment as between voluntary and board schools. It must be placed to the credit of the constructive statesmanship of the Conservative party that it availed itself of an ecclesiastical agitation to take an important step forward in the organization of national education. The difficulty inherent in such a measure was the admitted difficulty of securing public control, as a necessary concomitant of public maintenance, without jeopardizing or destroying the special religious character of the voluntary schools. The act of 1902 sought to solve this problem, so difficult of solution under democratic conditions, upon the principle of a division of financial responsibility justifying a corresponding division of control between the voluntary managers and the local authority. The constitution of the local authority to be charged not only with the delicate duty of participating in the dual control of the voluntary public elementary schools, but also with the responsible task of co-ordinating public higher with public elementary education, presented features of controversy only less formidable than the purely religious question itself. Boldly reversing the settlement of 1870, the act of 1902 abolished the parochial school boards, and with them the system of *ad hoc* election, and made the county councils, already seized of technical and secondary education under the Technical Instruction Acts, the local authorities for all forms of education, thus reverting to the solution propounded by Conservative statesmanship in the middle period of the 19th century and endorsed by an important memorandum contributed by Lord Sandford (formerly permanent secretary of the Education Department) to the report of the Cross Commission. The unquestionable niggardliness and inefficiency of many small country school boards, which had been foretold by the presence of the Newcastle Commissioners, constituted the chief educational argument for the selection of the wider area so far as the interests of elementary education alone were concerned. On the other hand, experience has shown that in the rural districts against the undoubted gain in general efficiency there must be set a certain loss on account of the decay of local and personal interest consequent upon the centralization of authority in the hands of the county councils. Account, too, must be taken of the comparative heaviness with which a uniform county rate is apt to press upon sparsely populated agricultural parishes, especially in counties which include considerable industrial districts. Notwithstanding these minor drawbacks, it may be said that upon the whole the best opinion has endorsed the policy of 1902 with respect to the area of administration. At any rate it has been necessary to recognize the impracticability of disestablishing the strongly organized provincial authorities which the act brought into being, and proposals for amendment in this par-

ticular have been confined to schemes, favoured in principle by all parties, for securing some measure of decentralization and delegation of powers calculated to restore and stimulate local interest without derogating from the financial and administrative responsibility of the county council.

The principal provisions of the act of 1902 may be summarized as follows:—

Part I. Local Education Authority. The council of every county and of every county borough is the local education authority for the purposes of the act, i.e. for both higher and elementary education, but for the purpose of elementary education autonomous powers are conferred upon boroughs with a population of over 10,000, and urban districts with a population of over 20,000 (§ 1).

Act of 1902, summary of provisions.

Part II. Higher Education. "The L.E.A. (local education authority) shall consider the educational needs of their area and take such steps as seem to them desirable, after consultation with the Board of Education, to supply or aid the supply of education other than elementary, and to promote the general co-ordination of all forms of education." For this purpose the application of the money received by the local authority under the Local Taxation (Customs and Excise) Act 1890, heretofore optional, is made compulsory, and power is given to levy a rate which in the case of a county is not to exceed two pence in the pound, or such higher rate as the county council with the consent of the Local Government Board may fix (§ 2). Concurrent powers are given to the councils of non-county boroughs and urban districts, with the limit of a penny rate (§ 3). A council must not require any particular form of religious instruction or observance, but the usual conscience clause in schools, colleges, or hostels provided by the council is modified by a provision for facilities for any particular religious instruction to be given at the request of parents of scholars at such times and under such conditions as the council think desirable, otherwise than at the cost of the council (§ 4).

Part III. Elementary Education. (1) Powers and duties. School boards and school attendance committees are abolished and their powers and duties are transferred to the L.E.A., who are also to be responsible for and have the control of all secular instruction in public elementary schools not provided by them (§ 5).

(2) Management of schools. (a) For public elementary schools provided by the L.E.A. (now officially styled "council schools"): (1) in counties, there is to be a body of six managers, viz. four appointed by the county council and two by the borough or urban district council, or parish council or parish meeting as the case may be, called in the act the minor local authority; (2) in non-county areas, the L.E.A. (being the borough or urban district council) may, if they think fit, appoint a body of managers consisting of such number as they may determine (§ 6 [1]).

(b) For schools not provided by the L.E.A. (voluntary schools) the act directs that there shall be a body of six managers, of whom four are to be "foundation managers" and two are to be appointed as follows: in counties, one by the L.E.A. and one by the minor local authority, and in autonomous boroughs or urban districts both by the borough or urban district council (§ 6 [2]). Directions for the appointment of foundation managers are given by § 11, which in effect declares that, unless the trust deed of the school provides for the appointment of the required number, the foundation managers must be appointed under an order of the Board of Education, in making which the board are to have regard to the ownership of the school building and to the principles on which the education given in the school had been conducted in the past. It was found necessary for the board to make over 11,000 of these orders, a heavy task which was rendered the more formidable by the controversial character of the questions arising upon trust deeds as to the mode of appointment and the qualifications of managers.

(3) Maintenance of schools (§ 7). (a) Powers. The L.E.A. are required to maintain and keep efficient all public elementary schools which were necessary (i.e. which, as defined by § 9, have an average attendance of not less than thirty), under certain specified conditions, of which the most material are as follows. The managers must carry out the directions of the L.E.A. as to the secular instruction to be given in the school, including any directions with respect to the number and educational qualifications of the teachers, and for the dismissal of any teacher on educational grounds (§ 7 [1] [a]). The consent of the L.E.A. is required to the appointment of teachers, but that consent may not be withheld except on educational grounds; and the consent of the authority is also required to the dismissal of a teacher unless the dismissal is on grounds connected with the giving of religious instruction (§ 7 [1] [c]).

(b) Liabilities. The managers are required to provide the school premises to the L.E.A. for use as a public elementary school free of charge, except that a rent is payable for the teacher's residence where one exists; and the managers are further required out of funds provided by them to keep the school premises in good repair and to make such alterations and improvements in the buildings as might reasonably be required by the L.E.A. On the other hand, the L.E.A. are required to make good such damage as they consider to be due to fair wear and tear of rooms used by them (§ 7 [1] [d]).

Thus, by virtue of the teacher's house rent and the wear-and-tear allowance the voluntary managers secured a valuable set-off against the cost of ordinary repairs.

Any question arising under this section (§ 7) between the L.E.A. and the managers of a voluntary school is to be determined by the Board of Education (§ 7 [3]).

It is further provided with respect to teachers in voluntary schools that assistant teachers and pupil teachers may be appointed "if it is thought fit" without reference to religious creed and denomination, and in any case in which there are more candidates for the post of pupil teacher than there are places to be filled, the appointment is to be made by the L.E.A. (§ 7. [5]).

A provision, § 7 (6), known from the name of its author (d. 1908), Colonel Kenyon Slaney, M.P., as the Kenyon-Slaney clause, attracted considerable attention and formed the subject of much ecclesiastical controversy during the passage of the bill through parliament. The Kenyon-Slaney clause requires the religious instruction in voluntary schools to be in accordance with the provisions (if any) of the trust deed, but also to be under the control of the managers as a whole, whereas the common form of trust deed of the National Society reserves the control of religious instruction to the clergyman, whilst the clause was equally in conflict with the well-known sacerdotal principles of the Roman Catholic Church. Thus the clause represented a revival, as did the questions with respect to foundation managers, of the early controversy over the management clauses of the Committee of Council on Education. Its special interest lies, not so much in its intrinsic importance, as in the precedent it affords, specially notable as emanating from a Conservative source, for the overruling of trust deeds upon grounds of public policy. By way of saving another familiar provision of the trust deeds, a proviso to the Kenyon-Slaney clause reserves the existing trust-deed rights of appeal to the bishop or other denominational authority as to the character of the religious instruction.

Provision of New Schools.—New schools may be provided either by the L.E.A. or any other persons, subject to the issue of three months' public notice, and to a right of appeal on the part of the managers of any existing school, the L.E.A. (in the case of proposed voluntary schools) or any ten ratepayers of the district, to the Board of Education on the ground that the proposed school is not required, or that a school provided by the L.E.A., or not so provided, as the case might be, is better suited to meet the wants of the district than the proposed school. Any enlargement of a public elementary school which in the opinion of the Board of Education is such as to amount to the provision of a new school is to be so treated for the purposes of the section, and any transfer of a school to or from the L.E.A. must be treated as the provision of a new school. In deciding appeals as to new schools and in determining a case of dispute whether a school was necessary or not, the board are directed to have regard to the interest of secular instruction, the wishes of parents as to the education of children, and the economy of the rates, but existing schools are not to be considered unnecessary if the average attendance is not less than thirty (§§ 8-9). The last-mentioned canons have played a prominent part in subsequent discussions. Experience of these sections has shown that though it is extremely difficult to set up new voluntary schools in face of opposition from the L.E.A., such opposition is rarely offered or pressed where any really strong local demand is shown to exist.

Aid Grant.—Section 10 provides a new aid grant payable to the L.E.A. in respect of the number of scholars in average attendance in schools maintained by them. This new grant, calculated by an elaborate method which need not here be set out, took the place of the grants under the Voluntary Schools Act 1897, and § 97 of the act of 1870 as amended by the Elementary Education Act 1897.

Education Committees.—The constitution of education committees is dealt with by § 17. All councils having powers under the act, except those having concurrent powers as to higher education only, must establish education committees in accordance with schemes made by the councils and approved by the Board of Education (§ 17 [1]). A scheme may provide for more than one education committee under a single council, but before approving such a scheme the board must satisfy themselves that due regard is paid to the importance of the general co-ordination of all forms of education (§ 17 [6]). All matters relating to the exercise by a council of their powers under the act, except the power of raising a rate or borrowing money, stand referred to the education committee; the council may also delegate to the education committee any of their powers other than financial powers as above (§ 17 [2]). Every scheme must provide (a) for the appointment of a majority of the committee by the council, the persons so appointed to be persons who are members of the council unless in the case of a county the council otherwise determine; (b) for the appointment by the council, on the nomination or recommendation, where it appears desirable, of other bodies (including associations of voluntary schools) of persons of experience in education, and of persons acquainted with the needs of the various kinds of schools in the area of the council; (c) for the inclusion of women. Provision was also made (d) for the representation in the first instance of members of existing school boards (§ 17 [3]).

Expenses.—All parliamentary grants are made payable to the L.E.A. instead of as previously to the managers (§ 18 [2]). The county council must charge a proportion of all capital expenditure

and liabilities, including rent, on account of the provision or improvement of any public elementary school on the parish or parishes which in the opinion of the council are served by the school, such proportion to be not less than one-half or more than three-fourths as the council think fit (§ 18 [1] [c] [d]). The county council may also if they think fit charge on the parishes benefited any expenses incurred with respect to education other than elementary (§ 18 [1] [a]).

Endowments.—The act introduced a new principle into the administration of endowments by directing that their income so far as necessarily applicable in any case for those purposes of a public elementary school for which the local authority are liable must be paid to that authority for the relief of the parochial rate (§ 13). As the result of technicalities of legal interpretation the section has been found to have in practice a narrower scope than had been generally anticipated.

The act of 1902 was extended to London by a separate act in 1903, containing certain special provisions of only minor importance.

The hostility of Nonconformists to the extension of rate-aid to denominational schools led to the organization upon a considerable scale of what became known as the "Passive Resistance" movement, a number of Nonconformist rate-payers refusing to pay the education rate on the ground that their consciences forbade their supporting the religious teaching in denominational schools; and their willingness to become subject to distraint and consequent inconveniences rather than pay the rates became the foundation of a widespread political campaign. In Wales, where in the rural districts the schools were commonly Anglican whilst the population was Nonconformist, particular difficulties arose in administering the act in consequence of the hostile attitude of the county authorities. Friction likewise manifested itself in one or two English areas, which reflected militant Nonconformist views. Accordingly the government passed the Local Education (Local Authority Default) Act 1904, empowering the Board of Education, in the case of default by the local authority, to make payments direct to the managers of the school and to deduct the amount from the sums payable to the defaulting authority on account of parliamentary grants.

When the liberal party came into power again in 1906, Mr Birrell as president of the Board of Education in Sir Henry Campbell-Bannerman's administration introduced a bill to amend the Education Acts 1902-1903, with the object of securing full public control of all rate-aided schools and the appointment of teachers without reference to religious belief. The bill was of a highly complex character; its principal features were,—compulsory transfer of existing voluntary schools to the local authority, facilities for the giving of denominational instruction in transferred schools out of school hours by persons other than the regular teachers, and the recognition in populous districts, upon the demand of parents, of special publicly maintained schools in which denominational teaching could be included in the curriculum; the latter schools might (according to the bill as finally amended) in the last resort, i.e. if the local authority refused to maintain them, be recognized as state-aided schools. The bill encountered strong opposition from Anglicans and Catholics (though the Catholic Irish members finally voted for it as amended); it passed the House of Commons by a large majority, but after unavailing attempts at compromise upon the amendments introduced in the House of Lords, the two Houses failed to agree and the measure was lost.

Mr Birrell was soon transferred to another office, and nothing more was done to amend the act of 1902 till early in the session of 1908, his successor Mr McKenna introduced a bill based on what was known as "contracting out." In single-school parishes the existing schools were to be compulsorily transferred, subject to the grant of denominational facilities out of school hours; elsewhere a sufficiency of places in schools with Cowper-Temple teaching, which the bill proposed to make compulsory in all provided schools, must be supplied by the local authority, while existing voluntary schools might become state-aided schools upon terms of receiving a grant of 47s. per head. The bill was accompanied by a financial scheme for a new system of allocating the parliamentary grant. In view of the improbability of its passing into law the bill was

"Passive Resistance" to 1902 act. Default Act 1904.

Bill of 1906.

Bill of 1906.

not pressed beyond the stage of second reading. Meanwhile, when Mr Asquith reorganized the cabinet, Mr Runciman succeeded Mr McKenna at the education office, and in the autumn he introduced a fresh measure framed as the result of negotiations between the government and the archbishop of Canterbury (Dr Randall Davidson) and designed to be passed rapidly through parliament by consent of all parties. Mr Runciman's bill, like his predecessor's, was based upon the principle of compulsory transfer in single-school parishes and contracting out elsewhere, but it gave a right of entry for denominational teaching on two days a week during school hours in all council schools whether transferred voluntary schools or otherwise, with liberty to employ for this purpose assistant teachers, but not (save temporarily at first in transferred schools) head teachers. Provision was also made for the payment of a small rent which would be applicable for or towards the cost of the denominational instruction. Unfortunately, the compromise failed at the last moment for want of agreement as to the financial terms of "contracting out," the government offering 50s. per head and the Church demanding 75 more. It is obvious that "contracting out" is open to serious objection upon educational and economic grounds, and that if resorted to upon any very considerable scale it would involve a disruption of the public elementary system, and a duplication of schools which would constitute a wasteful drain upon the national exchequer. Upon such a system, therefore, some check is necessary, and, once decided that the check should take the form of financial pressure, rather than request of parents as in Mr Birrell's bill, or some form of administrative control, the question of pecuniary terms became one of principle and not merely of financial detail. Moreover, the difficulty of adjusting differences was intensified by the opposition of the extremists on either side, which daily gathered force, and the bill was withdrawn by the government when in committee of the House of Commons. The conciliatory efforts of Mr Runciman and Dr Randall Davidson revealed the existence of a considerable body of influential opinion among all schools of thought in favour of a national compromise, and the proposals embodied in the bill marked on the part both of Churchmen and Nonconformists important concessions to each other's views, engendering reasonable hopes of an ultimate settlement being reached at no distant date.

Two subsidiary points as regards educational machinery have to be noted. The Education (Provision of Meals) Act 1906 enabled local education authorities to aid voluntary agencies in the provision of meals for children attending public elementary schools, and in certain cases with the consent of the Board of Education to defray the cost of the food themselves. In 1907-1908 forty, and in 1908-1909 seventy-five authorities in England and Wales were authorized by the board to expend moneys from the rates on food under this act. In addition, a number of authorities expended funds on equipment and service.

In 1907 an uncontroversial act entitled the Education (Administrative Provisions) Act, besides dealing with various matters of technical and administrative detail, laid upon local education authorities the new duty of providing for the medical inspection of all children attending public elementary schools. In connexion with this act the Board of Education established a medical department to advise and assist them in supervising local education authorities in carrying out their statutory duties in this regard. The whole departure is significant of the new sense of the importance of physical culture and hygiene which has been one of the remarkable features in recent educational developments.

Sir Joshua Fitch, in his article on education in the 10th edition of this work, describes how experience had led the Education Department to abandon the system of payment by results, to establish "in place of testing the proficiency of individual scholars, . . . one summary estimate of the work of the school; in place of an annual examination, occasional inspection without notice; in place of a variable grant dependent on a report in

detail on the several subjects of instruction and on particular educational merits and defects, one block grant payable to all schools alike." He at the same time expressed some misgiving as to the effect of "so large a relaxation of the conditions by which it had hitherto been sought to secure accuracy and thoroughness in teaching." The act of 1902, by placing secular education in public elementary schools under the control of strongly organized local education authorities may be said to have largely removed such dangers as were to be apprehended from the relaxation in question. Thus it was possible for the Board of Education in the code of 1904 to abolish the last traces of the system of payment by results, by setting forth (in the language of their report for 1903-1904) "a properly co-ordinated curriculum suitable to the needs of the children, with an indication of the relation which the various subjects of instruction should bear to each other, in place of the relatively haphazard list of possible branches of knowledge which were formerly presented to the choice of individual schools or authorities." In the new code also the board for the first time endeavoured to state for the guidance of teachers and parents the proper aim of the public elementary school, laying stress upon that element of the training of character which the system of payment by results had so unfortunately obscured. The new spirit was strikingly manifested in the volume of *Suggestions for the Considerations of Teachers*, issued by the Board of Education in 1905. This volume represented a notable attempt to connect administration with educational theory, without in any way seeking to crush individual initiative, or to impose a bureaucratic uniformity of method upon those engaged in the actual work of the schools. Apprehension of the true aim of elementary education as essentially and primarily a preparation for practical life has led to a corresponding development of instruction of a practical character, observation lessons and nature study being treated as a necessary element in the curriculum, while handicraft and gardening, and domestic subjects (for girls), are encouraged by special grants. Particular attention has been bestowed both by the central and local authorities upon the problem of rural instruction, and much has been done in many areas to bring the schools into closer relations with the needs of agricultural and rural life generally. In this way the old and perhaps not altogether ill-founded distrust of popular education as tending to unfit the working classes for industrial pursuits is being broken down and a public opinion more favourable to educational progress in the widest sense is being created.

According to the official returns for 1907-1908, the total number of scholars on the registers (England only) was as follows:—council schools, 2,991,741; voluntary schools, 2,566,030; total, 5,557,771, and the total attendance upon which grant was paid was 4,928,659. The percentage of actual average attendance to average number on the registers was 88.50%. The parliamentary grant (England and Wales) for elementary schools, other than higher elementary, amounted to £11,023,433.

The development of higher elementary education in England is now proceeding very much upon the lines that have been noted in France. The old higher-grade board-schools (declared illegal under the Elementary Education Acts by the judgment in the case of *Rees v. Cockerton* in 1901, and legalized temporarily by an act passed for the purpose in the same year) were mostly converted into municipal secondary schools under the act of 1902. In the succeeding years provision was made in the code for higher elementary schools of a specialized and technical type intended only for industrial districts. In 1906, as the result of the recommendations of the Consultative Committee, a new type of higher elementary school was admitted for children over twelve, corresponding generally to the French *école primaire supérieure*, described as having "for its object the development of the education given in the ordinary public elementary school, and the provision of special instruction bearing on the future occupations of the scholars, whether boys or girls." It may be possible to supplement this system in the rural areas to some extent by "higher tops" to the ordinary elementary schools in cases

Feeding of school children.

Medical inspection.

General progress in elementary education.

Higher elementary schools.

where it is not practicable to establish a fully organized higher elementary school; but for such "higher tops" no central grant is available. The total number of scholars upon the registers of higher elementary schools (England) in 1907-1908 was: New Type, 3178 (against 2715 in the previous year); Old Type, 4492 (against 5866 in the previous year).

The total expenditure (exclusive of capital outlay) of the local authorities (1906-1907) in England only upon elementary education, including "industrial" and "special" *Expenditure on elementary education.* schools, was £10,776,733, of which (a) £10,408,242 was met by the ordinary parliamentary grant, and (b) £8,930,468 was the balance required to be met by rates, the difference being represented by receipts from various sources. The average cost per child of elementary schools in England and Wales (excluding London) may be taken at £3 (including London £3, 4s. 10d.), and the average central grant (excluding grants for special purposes) at 41s., leaving 19s. to be raised locally.

The training of teachers for the two great branches of public education, elementary and secondary respectively, is an important part of the general administrative problem.

Preliminary training of elementary teachers. Since the middle of the 19th century there has been a great development of public opinion with regard to their professional qualifications. Sir Joshua Fitch (*Ency. Brit.* 10th ed.) pointed out that the full appreciation of the importance of training began at the lower end of the social scale. Shuttleworth and Tufnell in 1846 urged the necessity of special training for the primary teacher, and hoped to establish State Training Colleges to supply this want; but the one college at Battersea which was founded as an experiment was soon transferred to the National Society (the "National Society for educating the poor in the principles of the Established Church": founded in 1811). Before this, Bell and Lancaster had made arrangements in their model schools for the reception of a few young people to learn the system by practice. In Glasgow, David Stow, who founded in 1826 the Normal Seminary which afterwards became the Free Church College, was one of the first to insist on the need of systematic professional preparation. The religious bodies in England, notably the Established Church, availed themselves promptly of the failure of the central government, and a number of diocesan colleges for men, and separately for women, were gradually established. In 1854 the British and Foreign School Society (founded 1808) placed their institutes at the Borough Road and Stockwell on a collegiate footing, and subsequently founded other colleges at Swansea, Bangor, Darlington and Saffron Walden; the Roman Catholic Church provided two for women and one for men; and the Wesleyans two, one for each sex. The new provincial colleges of university rank were invited by the Education Department to attach normal classes to their ordinary course and to make provision for special training and suitable practice in schools for those students who desired to become teachers. Thus the government came to recognize two kinds of training schools—the residential colleges of the old type and the day colleges attached to institutions of university rank; both were subsidized by grants from the Treasury, and regularly inspected. As the need of special training for teachers became further recognized by the consideration of the same question as regards teachers in higher and intermediate schools (Cambridge instituting in 1879 examinations for a teacher's diploma, and other universities providing courses for secondary as well as primary teachers, and establishing professorships of education), the attitude of the government, *i.e.* the Board of Education, towards the problem gradually became more and more a subject of controversy and of public interest, as indicated by the clause in the Act of 1899 providing for a public registration of qualified teachers and for the gradual elimination from the profession of those who were unqualified. And meanwhile the increased solidarity of the National Union of Teachers (founded in 1870), the trade union, so to speak, of the teachers, brought an important body of professional opinion to bear on the discussion of their own interests.

The question of the preliminary education of elementary teachers had after some years of discussion reached a critical stage in 1909. The history of pupil teachership as a method of concurrent instruction and employment shows that it was in its inception something in the nature of a makeshift; the ideal placed before local education authorities in the recent regulations and reports of the Board of Education is the alternative system whereby with the aid of national bursaries (instituted in 1907) "the general education of future teachers may be continued in secondary schools until the age of seventeen or eighteen, and all attempts to obtain a practical experience of elementary school work may be deferred until the training college is entered, or at least until an examination making a natural break in that general education and qualifying for an admission to a training college has been passed." Under the revised pupil-teacher system established by the regulations of 1903 provision is made for the instruction of pupil teachers in centres which as far as possible are attached to secondary schools receiving grants from the Board of Education under the regulations for secondary schools, about two-thirds of the secondary schools on the grant list undertaking this work. Accordingly, the result of recent changes is to modify the old system in two ways: first by providing the alternative of a full course of secondary education, secondly by associating pupil teachership itself as far as possible with part-time attendance at a secondary school. The total number of pupil teachers recognized during the year 1907-1908 was 20,571, and of these 9770 were in centres forming integral parts of secondary schools. The number of bursars who passed the leaving examination was 1486.

One of the principal difficulties which confronted the state and the local authorities in their task of organizing an improved system of public education under the act of 1902 *Training colleges.* lay in the deficiency of training colleges in view of the increased number of teachers. Local authorities naturally hesitated to burden themselves with the cost of providing such institutions in view of the fact that there is nothing to prevent teachers trained at great expense by one authority taking service under a less public-spirited authority who had contributed nothing to such training; hence a widespread feeling that the provision of training colleges should be undertaken by the state as a matter of national concern. Under these circumstances a new system of building grants in aid of the establishment of training colleges was instituted in 1905. In 1906 these grants were raised from 25 to 75 % of the capital expenditure, but were limited to colleges provided by local authorities. A further difficulty in view of the municipalization of education arose from the fact that the majority of the residential colleges were in the hands of denominational trusts which did not admit a conscience clause. Under the presidency of Mr McKenna in 1907, the Board of Education, in regulations which excited much controversy, "with a view to throwing open as far as possible the advantages of a course of training in colleges supported mainly by public funds to all students who are qualified to profit by it irrespective of religious creed or social status," laid down that the application of a candidate might in no circumstances be rejected on any religious ground, nor on the ground of social antecedents or the like. The same regulations provided that no new training colleges would be recognized except on terms of compliance with certain conditions as to freedom from denominational restrictions or requirements. The obligation as to religious exemptions has since been limited to 50 % of the admissions. There were in attendance (*Statistics*, England, 1907-1908) in the various colleges, 6561 women and 2835 men, of whom 1619 women and 335 men were in colleges provided by local education authorities. The grants made by the Board of Education for training colleges were as follows: maintenance grants £383,851; building grants £45,000. These figures include Wales.

The fear has been widely entertained that a considerable part of the national expenditure upon elementary education is wasted for want of an effective system of continuative instruction to be given out of working hours to adolescents engaged in industrial employment. The whole subject was exhaustively

treated by the report in 1909 of the Consultative Committee of the Board of Education. This report seeks to base an efficient continuative system upon the improvement of elementary education by reducing the size of the classes in the elementary schools upon the lines now laid down by the new staffing regulations of 1909; by increasing the amount of instruction in hand-work with a view to rendering the curriculum less bookish and more efficient as a training for industrial and agricultural life; and by legislation to reform the system of half-time attendance and raise the age of compulsory attendance to thirteen and ultimately fourteen. Upon the foundation of an improved and prolonged elementary education there would be reared a superstructure of continuative schools or classes, attendance at which up to seventeen would be compulsory under bye-laws adoptive locally at the option of the local education authorities. In 1906-1907 about 21 per thousand of the population of England and Wales attended evening schools and classes inspected by the Board of Education, and grant amounting to £361,596 was paid in respect of 440,718 regular attendants.

The most marked progress has undoubtedly been in secondary education, and in no direction has the act of 1902 proved more fruitful. At the end of the 19th century secondary instruction in England was still provided chiefly by endowed grammar-schools, by proprietary schools established by religious bodies or joint-stock companies, and by private enterprise. No public provision was made for secondary education as such; what financial assistance was forthcoming from municipal sources was given indirectly under cover of the grants under the Technical Instruction Acts, while in the administration of central grants for the first years of the working of the Board of Education Act 1899, no absolute differentiation between secondary and technological functions was recognized. The establishment of local authorities with direct duties in respect of secondary education, and the reorganization of the central office with reference to the three branches of education, elementary, secondary and technological, rendered possible for the first time an adequate treatment of the problem of public secondary education as a whole. "The regulations, for secondary schools," says the prefatory memorandum to the regulations of the Board of Education, "grew up round the old provisions of the Directory of the Science and Art Department. Detached science classes were gradually built up into schools of science. Schools of science were subsequently widened into schools of what was known as the 'Division A' type, providing a course of instruction in science in connexion with, and as part of, a course of general education. Aid was afterwards extended to schools of the 'Division B' type in which science did not form the preponderating element of the instruction given. In 1904 the board recast the regulations so as to bring all schools aided by grants within the general definition of a school offering a general education up to and beyond the age of sixteen through a complete graded course of instruction, the object of which should be to develop all the faculties, and to form the habit of exercising them."

Two main tendencies distinguish the recent development: on the one hand the tendency to municipalization, or at least to the establishment of public control; on the other hand the tendency (marked especially by the regulations of 1907) to greater elasticity in regard to curricula, and so to the freer encouragement of local initiative and local effort.

In 1907 the government of Sir Henry Campbell-Bannerman placed greatly increased funds at the disposal of the Board of Education for the purpose of secondary education. The regulations under which the increased grant was administered imposed conditions in respect of freedom from denominational restrictions or requirements, representative local control, and accessibility to all classes of the people, which, like the analogous rules with regard to training colleges, roused considerable controversy. With regard to religious instruction, the requirement was made that no catechism or formula distinctive of any particular religious denomination might be taught in the school except upon the request in writing of the parent or guardian and at the cost of

funds other than grants of public money. Power was at the same time reserved to the board to waive the new conditions in the event of the local education authority passing a resolution that the school was in their view required as part of the secondary school provision for their area, and that the conditions, or one or more of them, might be waived with advantage in view of the educational needs of the area. It will be noticed that one effect of the regulations (as of the training college regulations) was to recognize as a kind of established religion those elements of Christianity which are shared in common by the various Protestant churches, according to the system of Lancaster and the Cowper-Temple compromise. Normally schools are required to provide 25% of free places for scholars from public elementary schools, and, with a view to encouraging the transference of children from the public elementary school at an early age, a grant of £2 was made payable on account of ex-public elementary scholars between ten and twelve years of age. The full scale of grants is £2 for ex-public elementary scholars between ten and twelve, and £5 for scholars between twelve and eighteen. To schools previously recognized and failing to comply with the new conditions, grant may be paid on the lower scale of £2 and £2, 10s. respectively.

Secondary school grants are assessed upon average attendance, and efficiency is guaranteed by inspection and not by individual examination. All recognized schools must provide at least the substantial equivalent of the four-years' course formerly required, and recognition is withheld or withdrawn if an adequate number of the scholars do not remain at least four years in the school, or do not remain up to sixteen; in rural areas, however, and small towns, a school life of three years and a leaving age of fifteen may be accepted. "The board are now in a position, through their inspectorate, to keep a watch and exercise a guidance which were previously impossible over the planning and working of school curricula. Detailed reports following upon full inspections, and the more constant if less obvious influence exercised through informal visits, conferences, reports and suggestions, may now be relied upon to guard against the risks of one-sided education, of ill-balanced schemes of instruction, and of premature or excessive specialization" (Report of Board of Education, 1906-1907, page 68). The curriculum must provide instruction duly graded and duly continuous, in the English language and literature, in geography and history, in mathematics, science and drawing, and in at least one language other than English. Where two languages other than English are taken, Latin must ordinarily be one. Provision must be made for organized games, physical exercises and manual instruction, and in girls' schools science and mathematics other than arithmetic may be replaced by an approved scheme of practical housewifery for girls over fifteen. The total number of secondary schools recognized for grant (*Statistics, 1907-1908*) was 736, of which only 220 were directly provided by local authorities. The number of pupils in attendance was 68,104 boys and 56,359 girls, total 124,463. The government grants for 1907-1908 amounted to £320,873 besides grants from local authorities.

Wales.

Notwithstanding the important differences which exist between the social and especially the religious conditions of England and Wales respectively, Wales continued to be treated as one with England for purposes of educational administration down to quite recent years. Towards the end of the 19th century the striking revival of Welsh nationality, in itself largely an educational and a literary movement, led to a spontaneous demand among the Welsh people for the organization of a national system of higher education. In accordance with the recommendations of a special royal commission the Welsh Intermediate Education Act passed in 1889 provided for the creation in every county in Wales (including Monmouthshire) of joint education committees consisting of three nominees of the county council and two nominees of the lord president of the council. To these committees were entrusted the duties of framing (under the Charity Commissioners) schemes for the establishment of intermediate

and technical schools and for the application of endowments, and for administering a 3d. county rate, which was supplemented by a treasury grant not exceeding the amount raised by the rate. Certain supervisory functions were entrusted to a Central Education Board, to which are committed the duties of inspection and examination. The joint education committees have now (except for the purpose of framing schemes for endowments) been superseded by the local education authorities under the act of 1902. The public assistance afforded to secondary education in Wales under the Intermediate Act is supplemented by the grants of the Board of Education, and the Board's revised Secondary School Regulations were applied to Wales in 1908. There were (1907-1908) 92 county secondary schools in Wales administered under schemes made under the Welsh Intermediate Act, attended by 6235 boys and 6727 girls, total 12,962; and 12 other secondary schools, of which 8 were provided by local authorities. The total attendance at all secondary schools was 13,615, viz. 6819 boys and 6796 girls. The Board of Education grant amounted to £31,090. The expenditure of the local authorities for the year 1906-1907 was £85,242.

The number of scholars on the registers of ordinary public elementary schools in Wales was (*Statistics, 1907-1908*), in council schools 330,413, and in voluntary schools 100,290, total 430,703. The percentage of average attendance was 86.98. The ordinary parliamentary grant (1906-1907) was £794,161, and the net expenditure of local authorities £561,234.

In 1907 a Welsh department of the Board of Education was established with a permanent secretary and a chief inspector, each responsible directly to the president. A movement was in progress in Wales in 1908-1909 for the creation of a national council of education under an independent minister, but this change could in any case only be effected by legislation; and meanwhile the special religious and social conditions in Wales caused administrative difficulties in working an act (that of 1902) primarily designed to meet those prevailing in England. (G. B. M. C.)

United States.

History.—The first white settlers who came to North America were typical representatives of those European peoples who had made more progress in civilization than any other in the world. Those settlers, in particular those from England and from Holland, brought with them the most advanced ideas of the time on the subject of education. The conditions of life in the New World emphasized the need of schools and colleges, and among the earliest public acts of the settlers were provisions to establish them. The steps taken between 1619 and 1622 to provide schools for the colony of Virginia were frustrated by the Indian war which broke out in the latter year, and were never successfully renewed during the colonial period. In New York, where the influence of the Dutch was at first predominant, elementary schools were maintained at the public expense, and were intended for the education of all classes of the population. This policy reflected the very advanced views as to public elementary education which were then held in the Netherlands. The assumption of control in the colony of New York by the English was a distinct check to the development of public elementary education, and little or no further progress was made until after the Revolution. The most systematic educational policy was pursued in the colony of Massachusetts. As early as 1635, five years after it was founded, the town of Boston took action to the end that "our brother Philemon Pormort shall be entreated to become schoolmaster for the teaching and nurturing children with us." The General Court of the colony in 1636 made the first appropriation for what was to become Harvard College, taking its name in honour of the minister, John Harvard, who died in 1638, leaving his library and one-half of his property, having a value of £800, to the new institution. The amount of this appropriation of 1636 (£400) was remarkable in that it was probably equal to the whole colony tax for a year. In 1642 followed a legislative act which, while saying nothing of schools, gave to the selectmen in every town power to oversee both the education and the

employment of children. It is made the duty of the selectmen to see that the children can read and understand the principles of religion and the capital laws of the country, and that they are put to some useful work.

Five years later, in 1647, was enacted the law which is not only the real foundation of the Massachusetts school system, but the type of later legislation throughout the United States. This epoch-making act, the first of its kind in the world, represented the public opinion of a colony of about 20,000 persons, living in thirty towns. It required every town of fifty householders to establish a school, the master of which should be paid either by the parents of the children taught or by public tax, as the majority of the town committee might decide; and it further required every town of one hundred families or householders to set up a grammar school in which pupils might be prepared for the "University," as the new institution at Cambridge was designated. Moreover, a penalty was attached to neglect of this legislative requirement, in the form of a fine to be devoted to the maintenance of the nearest school. Horace Mann said of the act of 1647: "It is impossible for us adequately to conceive the boldness of the measure, which aimed at universal education through the establishment of free schools. As a fact it had no precedent in the world's history; and, as a theory, it could have been refuted and silenced by a more formidable array of argument and experience than was ever marshalled against any other institution of human origin. But time has ratified its soundness. Two centuries of successful operation now proclaim it to be as wise as it was courageous, and as beneficent as it was disinterested." The significance of these acts of 1642 and 1647 is that they foreshadow the whole American system of education, including elementary schools, secondary schools and colleges, and that they indicate the principles upon which that system rests. These principles as summarized by George H. Martin in his *Evolution of the Massachusetts Public School System* are the following:—(1) The universal education of youth is essential to the well-being of the state. (2) The obligation to furnish this education rests primarily upon the parent. (3) The state has a right to enforce this obligation. (4) The state may fix a standard which shall determine the kind of education and the minimum amount. (5) Public money raised by general tax may be used to provide such education as the state requires. The tax may be general, though the school attendance is not. (6) Education higher than the rudiments may be supplied by the state. Opportunity must be provided at the public expense for youths who wish to be fitted for college. These principles have now found expression in the public acts of every state, and upon them education in the United States is founded.

Despite the praiseworthy attempts made in New York, New Jersey and Pennsylvania to develop schools and school systems, very little was accomplished in those colonies which was permanent. The sentiment in the more southern colonies was, as a rule, unfriendly to free schools, and nothing of importance was attempted in that section of the country until the time of Thomas Jefferson. Through religious zeal or philanthropy colleges were founded as far south as Virginia, and no fewer than ten of these institutions were in operation in 1776. Their present names and the dates of their foundation are: Harvard University, Massachusetts (1636); College of William and Mary, Virginia (1693); Yale University, Connecticut (1701); Princeton University, New Jersey (1746); Washington and Lee University, Virginia (1749); University of Pennsylvania, Pennsylvania (1749); Columbia University, New York (1754); Brown University, Rhode Island (1764); Rutgers College, New Jersey (1766); and Dartmouth College, New Hampshire (1769). In the colleges the ecclesiastical spirit was at first almost uniformly dominant. The greater number of their students were preparing for the ministry in some one of the branches of the Protestant Church. These facts caused the grammar schools to take on more and more the character of college-preparatory schools; and when this was brought about they supplied the educational needs of but one portion of the community. As time passed, the interdependence of governmental

Development.

and ecclesiastical interests began to weaken in the colonies, and there arose among those who represented the new secularizing tendency a distrust of the colleges and their influence. This gave rise to a new and influential type of school, the academy, which took its name from the secondary schools established in England by the dissenting religious bodies during the latter part of the seventeenth century at the suggestion of Milton. These academies were intended to give an education which was thought to be more practical than that offered by the colleges, and they drew their students from the so-called middle classes of society. The older academies were usually endowed institutions, organized under the control of religious organizations or of self-perpetuating boards of trustees. Their programme of studies was less restricted than that of the grammar schools, and they gave new emphasis to the study of the English language and its literature, of mathematics and of the new sciences of nature. For two generations the academies were a most beneficent factor in American education, and they supplied a large number of the better-prepared teachers for work in other schools. These schools were in a sense public in that they were chartered, but they were not directly under public control in their management. Early in the 19th century there arose a well-defined demand for public secondary schools—high schools, as they are popularly known. They were the direct outgrowth of the elementary school system. Boston, Philadelphia, Baltimore and New York were the first of the large cities to establish schools of this type, and they spread rapidly. These public secondary schools met with opposition, however, springing partly from the friends of the academies, and partly from those who held that governmental agency should be restricted to the field of elementary education. The legal questions raised were settled by a decision of the supreme court of Michigan, which contained these words: "Neither in our state policy, in our constitution, nor in our laws do we find the primary school districts restricted in the branches of knowledge which their officers may cause to be taught, or the grade of instruction that may be given, if their voters consent, in regular form, to bear the expense and raise the taxes for the purpose." This decision gave marked impetus to the development of public secondary or high schools, and they have increased rapidly in number. The academies have relatively declined, and in the Western states are almost unknown.

¹ Meanwhile the elementary school system had grown rapidly. The school district, the smallest civil division, was created in Connecticut in 1701, in Rhode Island about 1750, and in Massachusetts in 1780. From the point of view of efficient, well-supported schools, it has been felt since the time of Horace Mann that the substitution of the small school district for the town as the unit of school administration was a mistake. Yet the school district has exercised a profound influence for good upon the American people. In New York state, for example, there were in 1900 over eleven thousand school districts, and in Illinois over twelve thousand. The districts are small in extent and often sparsely settled. Their government is as democratic as possible. The resident legal voters, often including women, hold a meeting at least once a year. They elect trustees to represent them in the employment of the teacher and the management of the school. They determine whether a new schoolhouse shall be built, whether repairs shall be made, and what sum of money shall be raised for school purposes. In the rural districts this system has often been itself a school in patriotism and in the conduct of public affairs. Recently the tendency is to merge the school districts into the township, in order that larger and better schools may be maintained, and that educational advantages may be distributed more evenly among the people. Most of the southern states have the county system of school administration. This is because the county, rather than the township, has been the political unit in the south from the beginning. Special laws have been made for the school system in cities, and the form of these laws differs very much. In nearly every city there is a separate board of education, sometimes chosen by the voters, sometimes appointed by the mayor

or other official, which board has full control of the schools. The city board of education has as its executive officer a superintendent of schools, who has become a most important factor in American educational administration. He exerts great influence in the selection of teachers, in the choice of text-books, in the arrangement of the programme of studies, and in the determination of questions of policy. Sometimes he is charged by law with the initiative in some or all of these matters. He is usually a trained administrator as well as an experienced teacher. The first superintendent was appointed in 1837 at Buffalo. Providence followed in 1839, New Orleans in 1841, Cleveland in 1844, Baltimore in 1849, Cincinnati in 1850, Boston in 1851, New York, San Francisco and Jersey City in 1852, Newark and Brooklyn in 1853, Chicago and St Louis in 1854, and Philadelphia in 1855. In general, it may be said that the progress of public education in the United States is marked by (1) compulsory schools, (2) compulsory licensing of teachers, (3) compulsory school attendance, and (4) compulsory school supervision, and by the increasingly efficient administration of these provisions. The compulsion comes in each case from the state government, which alone, in the American system, has the power to prescribe it and to enforce it. Each state is therefore an independent educational unit, and there is no single, uniform American system of education in any legal sense. In fact, however, the great mass of the American people are in entire agreement as to the principles which should control public education; and the points in which the policies of the several states are in agreement are greater, both in number and in importance, than those in which they differ. An American educational system exists, therefore, in spirit and in substance, even though not in form.

Neither in the Declaration of Independence nor in the Constitution of the United States is there any mention of education. The founders of the nation were by no means indifferent to education, but they shared the common view of their time, which was that the real responsibility for the maintenance of schools and the expense of maintaining them should fall upon the several local communities. The relation of government to education was not then a subject of ordinary consideration or discussion. Later, when this question did arise and the power of taxation was involved, the several states assumed control of education, as it was necessary that they should do. Nevertheless, from the very beginning the national government has aided and supported education, while not controlling it. This policy dates from the 13th of July 1787, when there was passed the famous "Ordinance for the Government of the Territory of the United States North-West of the River Ohio," meaning the territory north and west of the Ohio river now represented by the states of Ohio, Indiana, Illinois, Michigan, Wisconsin, and the eastern side of Minnesota, embracing more than 265,000 sq. m. of territory. This ordinance contains this declaration: "Religion, morality, and knowledge being necessary to good government and the happiness of mankind, schools and the means of education shall for ever be encouraged." The Ordinance of 1787 also reaffirmed the provisions of the so-called Land Ordinance of 1785, by which section No. 16 in every township (a township consists of 36 numbered sections of 1 sq. m. each), or one thirty-sixth of the entire north-west territory, was set aside for the maintenance of public schools within the township. The funds derived from the sale and lease of these original "school lands" form the major portion of the public school endowment of the states formed out of the north-west territory. The precedent thus established became the policy of the nation. Each state admitted prior to 1848 reserved section No. 16 in every township of public land for common schools. Each state admitted since 1848 (Utah being an exception, and having four sections) has reserved sections No. 16 and No. 36 in every township of public lands for this purpose. In addition, the national government has granted two townships in every state and territory containing public lands for seminaries or universities. A third land grant is that made in 1867 for colleges of agriculture and the mechanical arts. The sum total of these three land grants amounted in

1900 to 78,659,439 acres, to which there must be added various special grants made from time to time to the states and devoted to education. The portion of the public domain so set apart in 1900 amounted in all to 86,138,473 acres, or 134,591 English sq. m. This is an area greater than those of the six New England states, New York, New Jersey, Maryland and Delaware added together. It is a portion of the earth's surface as great as the kingdom of Prussia, about seven-tenths as great as France, and considerably greater than the combined areas of Great Britain (including the Channel Islands) and the kingdom of Holland. Besides the enormous grants of land in aid of education, the national government has maintained since 1802 a military academy at West Point, New York, for the training of officers for the army, and since 1845 a naval academy at Annapolis, Maryland, for the training of officers for the navy. It has also taken charge of the education of the children of uncivilized Indians, and of all children in Alaska. It has voted, by act of 1887, a perpetual endowment of \$15,000 a year for each agricultural experiment station connected with a state agricultural college, and, by act of 1890, an additional endowment of \$25,000 a year for each of the agricultural colleges themselves. The aggregate value of land and money given by the national government for education in the several states and territories is about \$300,000,000.

In 1867 the Congress established a bureau of education, presided over by a commissioner who is under the jurisdiction of the secretary of the interior, the purpose of which is declared to be to collect "such statistics and facts as shall show the condition and progress of education in the several states and territories, and of diffusing such information respecting the organization and management of school systems and methods of teaching as shall aid the people of the United States in the establishment and maintenance of efficient school systems, and otherwise promote the cause of education throughout the country." The bureau has therefore no direct power over the educational policy of the several states. It has, however, exercised a potent influence for good in its advisory capacity. Up to 1900 this bureau had published 360 separate volumes and pamphlets, including 31 annual reports, covering from 800 to 2300 pages each; and the number has since been much increased. The annual reports alone of the Commissioner of Education are mines of information. These standard works of reference are distributed gratuitously in large numbers to libraries, school officials and other persons interested, and to foreign governments. The several commissioners of education have been: Henry Barnard, 1867-1870; John Eaton, 1870-1886; Nathaniel H. R. Dawson, 1886-1889; William T. Harris,¹ 1889-1906; Elmer Ellsworth Brown, 1906-

In the United States the sovereign powers are not all lodged in one place. Such of those powers as are not granted by the Constitution to the national government are reserved to the states respectively, or to the people. The power to levy taxes for the support of public education has been almost universally held to be one of the powers so reserved. The inhabitants of the several local communities, however indisposed they may have been to relinquish absolute control of their own schools, have been compelled to yield to the authority of the state government whenever it has been asserted, for except under such authority no civil division—county, city, township, or school district—possesses the power to levy taxes for school purposes. Moreover, since the exercise of state authority has uniformly improved the quality of the schools, it has usually been welcomed, not resisted. In general, it may be said that the state has used its authority to prescribe a minimum of efficiency which schools and teachers must reach, and it enforces this minimum through inspection and the withholding of its proper share of the state school fund from any locality where schools or teachers are permitted to fall below the required standard. In extreme cases the state authorities

¹ A valuable bibliography of Mr Harris's contributions to educational literature is given in the Report of the Commissioner of Education for 1907 (Washington, 1908).

have interfered directly to prevent the evil results of local inefficiency or contumacy. In addition, the states, almost without exception, maintain at their own expense schools for the training of teachers, known as normal schools. Many of the states also offer inducements to the cities, towns and districts to exceed the prescribed minimum of efficiency. Through the steady exercise of state supervision the school buildings have improved, the standard for entrance upon the work of teaching has been raised, the programme of studies has been made more effective and more uniform, and the length of the school term has increased. The Constitution of every state now contains some provision as to public education. Each state has an executive officer charged with the enforcement of the state school laws. Sometimes, as in New York, this official has plenary powers; sometimes, as in Massachusetts and Ohio, he is little more than an adviser. In twenty-nine states this official is known as the superintendent of public instruction; in Massachusetts and Connecticut he is called secretary of the state board of education; other titles used are commissioner of public schools, superintendent of common schools, and superintendent of public schools. The schools are administered, on behalf of the taxpayers, by an elected board of school trustees in rural school districts, and by an elected (though sometimes appointed) board of education or school committee in cities and towns. In 836 cities and towns there is a local superintendent of schools, who directs and supervises the educational work and acts as the executive officer of the board of education. The schools in the rural districts are under the direct supervision of a county superintendent of schools or similar official, who is often chosen by the people, but who sometimes is named by the state authorities. The county and city superintendents are often charged with the duty of holding examinations for entrance upon the work of teaching, and of issuing licences to those persons who pass the examinations. This system works best where it is carefully regulated by state law. Thirty states, one territory, and the District of Columbia have enacted compulsory education laws, but the enforcement of them is usually very lax. In fifteen states and territories there are no compulsory education laws, although there are in existence there fully organized school systems free to all children. The usual age during which school attendance is required is from 8 to 14. Provision is made in Maine, New Hampshire, Massachusetts, Rhode Island, Connecticut, New York, New Jersey, Pennsylvania, Indiana, Minnesota and Michigan, for sending habitual truants to some special institution. Laws forbidding the employment of children under a specified minimum age in any mercantile or manufacturing establishment are in force in twelve states, and are usually administered in connexion with the compulsory education laws.

The universal establishment in America of public secondary schools (high schools), and the existence of state universities in all of the states south and west of Pennsylvania, have brought into existence a system of state education which reaches from the kindergarten and the elementary school to the graduate instruction offered at state colleges and universities. This system includes (1) about 1500 free public kindergartens scattered over fifteen states; (2) free public elementary schools within reach of almost every home in the land; (3) free public secondary schools (high schools) in every considerable city or town and in not a few rural communities; (4) free land grant colleges, supported in large part by the proceeds of the nation's endowment of public lands, paying particular attention to agriculture and the mechanical arts, in all the states; (5) state universities, free or substantially so, in all the states south and west of Pennsylvania; (6) free public normal schools, for the professional training of teachers, in nearly every state; (7) free schools for the education of defectives in nearly all the states; and (8) the national academies at West Point and Annapolis for the professional training of military and naval officers respectively.

Miss Susan E. Blow, herself the leading exponent of kindergarten principles in the United States, has pointed out that the history of the kindergarten movement reveals four distinct

stages in its development: the pioneer stage, having Boston as its centre; the philanthropic stage, which began in the village of Florence, Mass., and reached its climax at San Francisco, California; the national or strictly educational stage, which began at St Louis; and the so-called maternal stage, which from Chicago as a centre is spreading over the entire country. During the first stage public attention was directed to a few of the most important aspects of Froebel's teaching. During the second stage the kindergarten was valued largely as a reformatory and redemptive influence. During the third stage the fundamental principles underlying kindergarten training were scientifically studied and expounded, and the kindergarten became part of the public school system of the country. The fourth stage, which, like the third, is fortunately still in existence, aims at making the kindergarten a link between the school and the home, and so to use it to strengthen the foundations and elevate the ideals of family life. By 1898 there were 4363 kindergartens in the United States (1365 of which were public), employing 9937 teachers (2532 in the public kindergartens) and enrolling 189,604 children (95,867 in the public kindergartens). Of the 164 public normal schools, 36 made provision for training kindergarten teachers. The scientific and literary activity of some of the private kindergarten training classes is very great, and they exert a beneficial and stimulating effect on teaching in the elementary schools. It is generally admitted that from the point of view of the children, of the teachers, of the schools, and of the community at large, the kindergarten has been and is an inspiration of incalculable value. The elementary school course is from six to nine years in length, the ordinary period being eight years. The pupils enter at about six years of age. In the cities the elementary schools are usually in session for five hours daily, except Saturday and Sunday, beginning at 9 A.M.

Elementary schools.

There is an intermission, usually of an hour, at midday, and short recesses during the sessions. In the small rural schools the pupils are usually ungraded, and are taught singly or in varying groups. In the cities and towns there is a careful gradation of pupils, and promotions from grade to grade are made at intervals of a year or of a half-year. The best schools have the most elastic system of gradation and the most frequent promotions. In a number of states there are laws authorizing the conveyance of children to school at the public expense, when the schoolhouse is unduly distant from the homes of a portion of the school population. Co-education (*q.v.*) in the elementary school has been the salutary and almost uniform practice in the United States. The programme of studies in the elementary school includes English (reading, writing, spelling, grammar, composition), arithmetic (sometimes elementary algebra also, or plane geometry in the upper grades), geography, history of the United States, and elementary natural science, including human physiology and hygiene. Physical training, vocal music, drawing and manual training are often taught. Sometimes a foreign language (Latin, German or French) and the study of general history are begun. Formal instruction in manners and morals is not often found, but the discipline of the school offers the best possible training in the habits of truthfulness, honesty, obedience, regularity, punctuality and conformity to order. Religious teaching is not permitted, although the exercises of the day are often opened with reading from the Bible, the repetition of the Lord's Prayer and the singing of a hymn. Corporal punishment is not infrequent, but is forbidden by law in New Jersey, and in many states may be used only under restrictions. Text-books are used as the basis of the instruction given, and the pupils "recite" in class to the teacher, who, by use of illustration and comment, makes clear the subject-matter of the prescribed lesson. The purpose of the recitation method is to make the work of each pupil help that of his companion. Skillfully used, it is the most effectual instrument yet devised for elementary school instruction.

The secondary school course is normally four years in length. The principal subjects studied are Latin, Greek, French, German, algebra, geometry, physics, chemistry, physical geography,

physiology, rhetoric, English literature, civics and history. Although but 11.36% of the students in public high schools and 25.36% of those in private secondary schools are preparing for a college or scientific school, yet the conditions prescribed by the colleges for admission to their courses affect powerfully both the secondary school programme and the methods of teaching. Of late years no educational topic has been more widely discussed than that as to the proper relations of secondary schools and colleges. As a result, special examinations for admission to college are either greatly simplified or entirely abolished, and the secondary studies are much more substantial and better taught than formerly. An increasing proportion of secondary school teachers are college graduates. The most extraordinary characteristic of secondary education in recent years is the rapid increase in the number of students taking Latin as a school subject. Meanwhile the proportion of those studying physics and chemistry has fallen off slightly. The rate of increase in the number of pupils who study Latin is fully twice as great as the rate of increase in the number of secondary school students. Between 1890 and 1896, while the number of students in private secondary schools increased 12%, the number of students in public secondary schools increased 87%. Since 1894 the number of students in private secondary schools has steadily declined.

The American college, although it is the outgrowth of the English colleges of Oxford and of Cambridge, has developed into an institution which has no counterpart in Europe. The college course of study, at first three years in length, was soon extended to four years, and the classes are uniformly known as the freshman, the sophomore, the junior and the senior. The traditional degree which crowns the college course is that of Bachelor of Arts (A.B.). The studies ordinarily insisted on in the case of candidates for this degree are Latin, Greek, mathematics, English, philosophy, political economy, history, at least one modern European language (French or German), and at least one natural science. The degrees of Bachelor of Science (B.S.), Bachelor of Philosophy (Ph.B.), and Bachelor of Letters (B.L.) are often conferred by colleges upon students who have pursued systematic courses of study which do not include Greek or the amount of Latin required for the degree of Bachelor of Arts. The best colleges give instruction which is similar in character to that given in Germany in the three upper classes of the gymnasium and in the introductory courses at the universities, in France in the two upper classes of the lycée and in the first two years of university study, and in England in the upper form of the public schools and during the years of undergraduate residence at Oxford and Cambridge. Since 1870 the colleges have developed enormously. Their resources have multiplied, the number of their students has increased by leaps and bounds, the programme of studies has broadened and deepened, the standards have been raised, and the efficiency of the instruction has greatly increased. Rigidly prescribed courses of study have given way to elective courses, and a knowledge of Greek is no longer required for the degree of A.B. at such influential colleges as Harvard, Columbia, Cornell and Williams. A strong effort is being made to have the leading colleges give but one degree, that of Bachelor of Arts, and to confer that upon those who complete any substantial course of college studies. A marked change has taken place in the attitude of the college authorities toward the students. In 1870 the college president was a paterfamilias. He knew each student and came into direct personal contact with him. The president and the faculty had supervision not only of the studies of the students, but of their moral and religious life as well. The older type of college professor was not always a great scholar, but he was a student of human nature, with keen intuitions and shrewd insight. The new type, which had come into existence at the opening of the 20th century, was more scholarly in some special direction, often regarded teaching as a check upon opportunities for investigation, and disdained troubling himself with a student's personal concerns or intellectual and moral difficulties. The change was not altogether

for the better, and a desirable reaction has been observable. Each college, however small or ill-equipped, exercises a helpful local influence. Ninety per cent of all college students attend an institution not more than one hundred miles from their own homes. Few colleges have a national constituency, and even in these cases an overwhelming preponderance of the students come from the immediate neighbourhood. This explains, in a measure, the powerful influence which the college has exercised in the life of the nation. While hardly more than one in a hundred of the white male youth of the country has had a college education, yet the college graduates have furnished one-half of all the presidents of the United States, most of the justices of the Supreme Court, about one-half of the cabinet officers and United States senators, and nearly one-third of the House of Representatives. Before the Revolution eleven colleges were founded. From 1776 to 1800, twelve more were added, from 1800 to 1830, thirty-three; from 1830 to 1865, one hundred and eighty; from 1865 to 1898, two hundred and thirty-six. Their standards, efficiency and equipment are very diverse, many of the so-called colleges being less effective than some of the better organized secondary schools. Except in New York and Pennsylvania, there is no statutory restriction upon the use of the name "college." This is an abuse to which public attention has in recent years been increasingly called.¹

In the United States the title "university" is used indiscriminately of institutions which are in reality universities, of institutions which are colleges, and of institutions which are so ill-equipped as not to take rank with good secondary schools. Only time and a greatly increased capacity to distinguish the various types of higher schools will remedy this error. Putting aside tentative and unsuccessful attempts to develop genuine university instruction much earlier, it may safely be said that the opening of the Johns Hopkins University at Baltimore in 1876 began the present movement to organize carefully advanced study and research, requiring a college education of those who wish to enter upon it. This is university instruction properly so called, and though found elsewhere, it is given chiefly at fourteen institutions. California University, Catholic University of America, Chicago University, Clark University, Columbia University, Cornell University, Harvard University, Johns Hopkins University, Michigan University, Pennsylvania University, Princeton University, Leland Stanford Jr. University, Wisconsin University and Yale University. All of these institutions, except the Catholic University of America, are also colleges. The combination of collegiate and university instruction under one corporation and one executive administration is distinctive of higher education in the United States, and its chief source of strength. The crowning honour of the university student is the degree of Ph.D., although that of A.M.—obtainable in less time and much easier conditions—is also sought. The minimum period of study accepted for the degree of Ph.D. is two years after obtaining the bachelor's degree; but in practice, three, and even four, years of study are found necessary. In addition to carrying on an investigation in the field of his main subject of study, the candidate for the degree of Ph.D. is usually required to pass examinations on one or two subordinate subjects, to possess a reading knowledge of French and German (often of Latin as well), and to submit—usually in printed form—the dissertation which embodies the results of his researches. The methods of instruction in the universities are the lecture, discussion and work in laboratory or seminary—the latter transplanted from the German universities. The degree of Master of Arts is conferred upon students who, after one year of university residence and study, pass certain prescribed examinations. This degree, like those of D.D., S.T.D. and LL.D., is often conferred by colleges and universities as a purely honorary distinction. The degree of Ph.D. is not so conferred any longer by the best universities. Not a few of the universities maintain

schools of law and medicine. Harvard and Yale universities maintain schools of theology as well. The learned publications issued by the universities, or under the direction of university professors, are of great importance, and constitute an imposing body of scientific literature. The national and state governments make increasing use of university officials for public service requiring special training or expert knowledge. In 1871-1872 there were only 198 resident graduate (or university) students in the United States. In 1887 this number had risen to 1237, and in 1897 to 4392. These figures are exclusive of professional students, and include only those who are studying in what would be called, in Germany, the philosophical faculty. (See also UNIVERSITIES.)

Most extensive provision is made in America for professional, technical and special education of all kinds, and for the care and training of the dependent and defective classes (see BLINDNESS and DEAF AND DUMB), as well as for the education of the Indian (see INDIANS, NORTH AMERICAN), and—in the Southern states—of the negro (*q.v.*). (N. M. B.)

Statistics.—Details as to education in each state of the American Union are given in the articles under state headings. But a more comprehensive view may be obtained here from the general statistics. The introduction to the statistical tables in vol. ii. of the Commissioner of Education's Report for 1907 may usefully be quoted. Mr Edward L. Thorndike, of the Teachers' College, Columbia University, there summarizes the national account as follows:—

"We use in formal school education a material plant valued at from twelve to thirteen hundred million dollars, the labour of 350,000 teachers or other educational officers, and more or less of the time of some eighteen million students. . . . We pay for the labour of these teachers, many of whom work for only part of the normal city-school year, about \$300,000,000. We pay for fuel, light, janitorial services, repairs, depreciation of books, school supplies, insurance and the like, about \$90,000,000. For depreciation of the plant not so charged we should properly provide during the year a sinking fund of perhaps \$25,000,000. Adding an interest charge of 5% on the investment in the plant, our annual bill for formal school education comes to over \$475,000,000. Additions to the plant were made [in 1906-1907] to the extent of from ninety to a hundred million dollars. As a partial estimate of the returns from this investment we may take the number of students whose education has been carried to a specified standard of accomplishment and power. Thus I estimate that, in 1907, 3,000 students reached the standard denoted by three years or more of academic, technical or professional study in advance of a reputable college degree; that 25,000 students reached the standard denoted by at least three and not over four years of such study in advance of a four-year high-school course; that an eighth of a million students reached the standard denoted by at least three and not over four years of study in advance of an eight-year elementary-school course; and that three-quarters of a million students reached the standard of completion of an elementary-school course of seven or eight years or its equivalent. . . . Roughly, nine-tenths of elementary education and the education of teachers, over two-thirds of secondary education, and over a third of college and higher technical education are provided and controlled by the public. Professional education, other than the training of teachers and engineers, is still largely a function of private provision and control."

"The following rough comparison may serve to define further the status of education in the country at large. The plant used for formal education is valued at 1% of our entire national wealth, or twice the value of our telephone systems, or ten times the value of our Pullman and private cars, or one-tenth the value of our railroads. The number of teachers is approximately that of the clergymen, engineers, lawyers and physicians together, five times that of the regular army and navy, and about twice that of the saloon-keepers and bar-tenders and their assistants. The annual expenditure for education, exclusive of additions to the plant, is somewhat over twice the expenditure for the war and navy departments of the national government. It is three and a half times the expenditure of the national government in 1907 for pensions. It is about one and a fourth times the cost (New York wholesale prices) of the sugar and coffee we consume annually."

The above comparison indicates perhaps, not inadequately, the "business" conception of the value of education prevailing in the United States, where its practical advantages are realized as in no other country, not even Germany.

From the same report the following statistics may be cited for 1906-1907.

¹ See especially the second Annual Report of the President of the Carnegie Foundation for the Advancement of Teaching (pp. 76-80), quoted in the Report for 1907 of the Commissioner of Education.

Common Schools (including Elementary and Secondary Public Schools only).

Total number of pupils of all ages	16,820,386 ¹
Average number of days schools open	151.2
Average number of days attended by each pupil	106.2
Number of male teachers	105,773
Number of female teachers	369,405
Number of school houses	259,115
Average monthly wage of male teachers	\$56.10
Average monthly wage of female teachers	\$43.67
Value of all school property	\$843,309,410
Income from permanent funds and rents	\$16,579,551
Income from State taxes	\$46,281,501
Income from local taxes	\$230,424,554
Income from other sources	\$59,317,134
Expenditure on sites, buildings, furniture, libraries and apparatus	\$65,817,870
Expenditure on salaries	\$196,980,919
Expenditure on other purposes	\$67,882,012
Expenditure per head of population	\$1.90
Expenditure per pupil	\$27.98

The Bureau of Education in 1907 received reports from 606 universities, colleges and technological schools; they had a teaching force of 24,679, and an enrolment of 293,343 students. The number of public and private normal schools reporting was 259, with an enrolment of 70,439 students in the regular training courses for teachers, 12,541 graduates and 3660 instructors. There were 148 manual and industrial training schools (independently of the manual training taught in the public schools and in 66 Indian schools), with 1692 teachers and an enrolment of 68,427 students; and 445 independent commercial and business schools, with 2856 instructors and 137,364 students. (X.)

BIBLIOGRAPHY.—For the study of education as an aspect of religious, social, moral and intellectual development, the material is practically inexhaustible, and much of the most valuable does not treat specifically of the education given in schools and colleges. The most useful guide is E. P. Cubberley's *Syllabus of Lectures on the History of Education* (1902), which consists of an analytic outline of topics with copious and detailed references to authorities. See also W. S. Monroe's *Bibliography of Education* (1897). The best general history in English is P. Monroe's *Text-Book on the History of Education* (1905), which, like Davidson's much briefer *History of Education*, treats the subject broadly and in relation to other aspects of life. Williams's *History of Ancient, Medieval, and Modern Education* is a useful statement of the main facts of educational progress taken somewhat by itself. In German the standard work is K. A. Schmid's *Geschichte der Erziehung*, a comprehensive and detailed treatment in which each period is dealt with by a specialist. Ziegler's *Geschichte der Pädagogik* is a good short history. In French, Letourneau's *L'Évolution de l'éducation* is especially good on ancient and non-European education. Draper's *Intellectual Development of Europe* is vigorous and interesting, but marred by its depreciation of the work of the Church. Guizot's *History of Civilization* is still of value, as are parts of Hallam's *Literary History*. Lecky's *History of the Rise and Influence of the Spirit of Rationalism in Europe*, and Buckle's *History of Civilization in England*, contain much that is of value. The best encyclopaedias are W. Rein's *Encyclopädisches Handbuch der Pädagogik*, and F. Buisson's *Dictionnaire de pédagogie, première partie*. Sir Henry Craik's *The State and Education* (1883) is an excellent text-book on national education.

Of books dealing with special periods and topics, S. Laurie's *Historical Sketch of Pre-Christian Education*, Freeman's *Schools of Hellas*, Girard's *L'Éducation athénienne au V^e et au IV^e siècle avant J.-C.*, Davidson's *Education of the Greek People*, Mahaffy's *Old Greek Education and Greek Life and Thought*, Nettleship's article on "Education in Plato's Republic" in *Heleneica*, Capes's *University Life in Athens*, Hobhouse's *Theory and Practice of Ancient Education*, Gräberger's *Erziehung und Unterricht im klassischen Altertum*, Wilkin's *Roman Education*, and Clarke's *Education of Children at Rome*, are valuable for classical times.

For the somewhat obscure transition centuries there is much of value in Taylor's *Classical Heritage of the Middle Ages*, Dill's *Roman Society in the Last Century of the Western Empire*, especially the chapter on "Culture in the 4th and 5th centuries," Boissier's *La Fin du paganisme*, and Hatch's *Influence of Greek Thought upon the Christian Church*.

The best general account of medieval education is in Drane's *Christian Schools and Scholars*; and J. B. Mullinger's *Schools of Charles the Great* treats well of the Carolingian Revival. G. B. Adams's *Civilization during the Middle Ages* is excellent; and Sandys's *History of Classical Scholarship* is a valuable book of reference. On the scholastic philosophy Turner's *History of Philosophy* and Haureau's *Histoire de la philosophie scolastique*, are useful. Medieval schools are described in Furnivall's preface to *The Babees Book*, which deals with "Education in Early England,"

¹ In private schools there were also 1,304,547 pupils.

and in Leach's *Old Yorkshire Schools and History of Winchester College*. The most important books on the universities are Rashdall's *Universities of Europe in the Middle Ages*, Jourdain's *Histoire de l'université de Paris aux XVII^e et XVIII^e siècles*, Lyte's *History of the University of Oxford to 1530*, and Mullinger's *History of the University of Cambridge to the Accession of Charles I.* Paulsen's *Geschichte des gelehrten Unterrichts auf den deutschen Schulen und Universitäten* is the best history of education in Germany.

On the Renaissance in Italy, Villari's Introduction to *his Life and Times of Machiavelli*, and Burckhardt's *Die Kultur der Renaissance in Italien* (translated into English), are of the first importance. Other valuable books are the first volume of the *Cambridge Modern History* and Symonds's great work on *The Renaissance in Italy*, especially the volume on *The Revival of Learning*. Dealing more specifically with education are Woodward's excellent monographs on *Education during the Renaissance*, *Vittorino da Feltré* and *Erasmus*. Janssen's *Geschichte des deutschen Volkes* (translated into English) gives a good account of the social and intellectual condition of Germany in the 14th, 15th and 16th centuries. Christie's *Life of Étienne Dolet* is of value for the Renaissance in France. For the movement in England Seebohm's *Oxford Reformers*, Gasquet's *Éve of the Reformation in England*, Einstein's *The Italian Renaissance in England*, and Leach's *English Schools at the Reformation, 1546-1548*, are particularly important.

For later times the material is chiefly in the form of monographs, of which the following, among others, are of value: Adamson's *Pioneers of Modern Education*, Laas's *Die Pädagogik des Johannes Sturm*, Beard's *Port Royal*, vol. ii., Kuno Fischer's *Fr. Bacon und seine Nachfolger*, Laurie's *John Amos Comenius*, Morley's *Rousseau*, Pinloche's *Les Réformes de l'éducation en Allemagne au dix-huitième siècle*, Biedermann's *Deutschlands geistige, sittliche, und gesellige Zustände im XVIII. Jahrhundert*.

For the 19th century and after, the best sources of information are the official Reports, such as those of the Royal Commissions on the English Universities, the Public Schools, and the other English secondary schools; the "Special Reports," issued by the English Board of Education; the encyclopaedic annual Reports of the American Commissioner of Education (dealing not only with the United States, but with progress in other countries); monographs in the French *Musée pédagogique*, and various German Reports.

For education in the United States, see also Boone's *History of Education in U.S.A.* (1889); N. M. Butler (editor), *Education in the U.S.A.* (1900), a series of monographs prepared for the Paris Exposition; E. G. Dexter's *History of Education in the United States* (1904); and the *Proceedings of the National Educational Association*.

On the leading writers on education the monographs in the *Great Educator Series* are useful, and editions and translations of the best known of these writers are available. The greatest systematic collection is the *Monumenta Germaniae paedagogica*. On the development of the means of education, Montmorency's two books on *State Intervention in English Education from the Earliest Times to 1831*, and *The Progress of Education in England*, Balfour's *Educational Systems of Great Britain and Ireland*, Allain's *L'Instruction primaire en France avant la Révolution*, Lantini's *Histoire de l'enseignement secondaire en France au XVII^e et au début du XVIII^e siècle*, and Konrad Fischer's *Geschichte des deutschen Volksschullehrerstandes*, may be mentioned. (J. Wk.)

EDWARD, "THE ELDER" (d. 924), king of the Angles and Saxons, was the second son of Alfred the Great, and with his sister Æthelflæd was carefully educated at the court of his father. During his father's lifetime he took an active part in the campaigns against the Danes, especially in that of 894, and as early as 898 he signs a charter as "rex," showing that he was definitely associated with his father in the kingship. He succeeded his father in October 899,¹ but not without opposition. The Ætheling Æthelwold, son of Alfred's elder brother Æthelred, seized Wimborne and Christchurch. Edward advanced against him, and Æthelwold took refuge among the Danes in Northumbria. In 904 Æthelwold landed in Essex, and in the next year he enticed the East Anglian Danes to revolt. They ravaged all southern Mercia and, in spite of Edward's activity, returned home victorious, though Æthelwold fell in the battle of the Holme. In 905 or 906 Edward made a peace with the East Anglian and Northumbrian Danes at "Yttingaford," near Linslade in Buckinghamshire, perhaps the peace known as "the Laws of Edward and Guthrum." In 909 and 910 fresh campaigns took place owing to southerly raids by the Danes, and victories were won at Tettenhall and Wednesfield in Staffordshire.² From 907 onwards Edward and his sister Æthelflæd,

¹ See Stevenson's article in *Eng. Hist. Rev.* vol. xiii. pp. 71-77. The whole chronology of this reign is very difficult and certainly is often impossible of attainment.

² It is possible that these battles are one and the same; the places are within 2 to 3 m. of each other.

the Lady of the Mercians, were busy strengthening their hold on Mercia and Wessex. Forts were built at Lincoln (907), "Bremesbyrig" (910), "Scergeat" and Bridgenorth (912), and when in the year 911 Æthelstred's husband Æthelred died, Edward took over from Mercia the government of London and Oxford, with the lands belonging to them, i.e. probably Oxfordshire and Middlesex. The policy of constructing "burhs" or fortified towns was continued. Hertford was fortified in 911, Witham in 912, while Æthelstred fortified Cherbury in Shropshire, "Weardbyrig" and Runcorn (all in 915). In 913 the Danes in Eastern Mercia gave considerable trouble, and in 914 a fresh horde of pirates, coming from Brittany, sailed up the Severn. They raided southern Wales, but were hemmed in by the English forces and besieged until they promised to leave the king's territory. Edward watched the southern shores of the Bristol Channel so carefully that the Danes failed to secure a hold there, and were ultimately forced to sail to Ireland. In the same year Edward fortified Buckingham and received the submission of the jarls and chief men of Bedford. In 915 he fortified Bedford itself, Maldon in 916, and Towcester and "Wigingamere" in 917. In the last-mentioned year Edward captured and destroyed the Danish stronghold of Tempsford, and later in the year he took Colchester. An attack by the Danes on Maldon failed, and in 915 Edward went to Passenham and received the submission of the men of the "borough" of Northampton. The Danish strongholds of Huntingdon and Colchester were now restored and repaired, and Edward received the submission of the whole of the East Anglian Danes. Before midsummer of this year Edward had fortified Stamford, and on the death of his sister he received the submission of the Mercians at Tamworth. There also three kings of the North Welsh took Edward as their lord. Nottingham was now fortified; Thelwall in Cheshire (916) and Manchester soon followed; Nottingham was strengthened by a second fort; Bakewell was fortified and garrisoned, and then came the greatest triumph of Edward's reign. He was "chosen as father and lord" by the Scottish king and nation, by Reginald, the Norwegian king of Northumbria, by Ealdred of Bamborough, and by the English, Danes or Norwegians in Northumbria, and by the Strathclyde Welsh.

With the conclusion of his wars Edward's activity ceased, and we hear no more of him until in 924 he died at Farndon in Cheshire and was buried in the "New Minster" at Winchester. He was thrice married: (1) to Ecwgwyn, a lady of rank, by whom he had a son Æthelstan, who succeeded him, and a daughter Eadgyth, who married Sihtric of Northumbria in 924. This marriage was probably an irregular one. (2) To Ælfred, by whom he had two sons—Ælfward, who died a fortnight after his father, and Eadwine, who was drowned in 933—and six daughters, Æthelstred and Æthelild nuns, and four others (see ÆTHELSTAN). (3) To Eadgifu, the mother of Kings Edmund and Eadred, and of two daughters.

AUTHORITIES.—*Anglo-Saxon Chronicle* (ed. Plummer and Earle, Oxford); *Florence of Worcester* (Mon. Hist. Brit.); *William of Malmesbury, Gesta regum* (Rolls Series); *Simon of Durham* (Rolls Series); *Æthelward* (Mon. Hist. Brit.); Birch, *Cartularium Saxonicum*, Nos. 588-635; *D.N.B.*, s.v. (A. M.W.)

EDWARD, "THE MARTYR" (c. 926-978), king of the English, was the son of Edgar by his wife Æthelstred. Edward's brief reign was marked by an anti-monastic reaction. Ælthere, earl of Mercia, once more expelled many of the monks whom Bishop Æthelwold had installed. There seems also to have been some change in administrative policy, perhaps with regard to the Danes, for Earl Osloc, whom Edgar had appointed to Northumbria, was driven from his province. In ecclesiastical matters there were two parties in the kingdom, the monastic, which had its chief hold in Essex and East Anglia, and the anti-monastic, led by Ælthere of Mercia. Conferences were held at Kirtlington in Oxfordshire and at Calne in Wiltshire in 977 and 978, but nothing definite seems to have been decided. On the 18th of March 978 Edward's reign was suddenly cut short by his assassination at Corfe Castle in Dorsetshire. The crime was probably inspired by his stepmother, Ælfthryth, who was anxious to secure

the succession of her son Æthelred. The body was hastily interred at Wareham and remained there till 980, when Archbishop Dunstan and Ælthere of Mercia united in transferring it with great ceremony to Shaftesbury. Edward seems to have been personally popular, and the poem on his death in the chronicle calls his murder the worst deed in English history. Very shortly after his death he was popularly esteemed to be both saint and martyr.

See *Saxon Chronicle; Vita S. Oswaldi* (*Hist. of Ch. of York, Rolls Series*); *Memorials of St Dunstan* (ed. Stubbs, *Rolls Series*). (A. M.W.)

EDWARD, "THE CONFESSOR" (d. 1066), so called on account of his reputation for sanctity, king of the English, was the son of Æthelred II. and Emma, daughter of Richard, duke of Normandy, and was born at Islip in Oxfordshire. On the recognition of Sweyn as king of England in 1013, Æthelred, with his wife and family, took refuge in Normandy, and Edward continued to reside at the Norman court until he was recalled in 1041 by Hardicanute. He appears to have been formally recognized as heir to the throne, if not actually associated in the kingship, and on the death of Hardicanute in 1042 "all folk received him to be king," though his actual coronation was delayed until Easter 1043. A few months later Edward, in conjunction with the three great earls of the kingdom, made a raid on the queen-mother Ælfgifu, or Emma, seized all her possessions and compelled her to live in retirement.

In the earlier years of the reign the influence of Earl Godwine was predominant, though not unopposed. His daughter Edith or Eadgyth became Edward's queen in 1045. But the king's personal tastes inclined much more to foreigners than to Englishmen, and he fell more and more into the hands of favourites from beyond the sea. Between Godwine, representing the spirit of nationalism, and these favourites (especially their leader Robert of Jumièges, successively bishop of London and archbishop of Canterbury) there was war to the knife. In 1046 Magnus, king of Norway, who had succeeded Hardicanute in Denmark and claimed to succeed him in England as well, threatened an invasion, but the necessity of defending Denmark against his rival Sweyn Estrithson prevented him from carrying it into effect. In 1049, Godwine's son Sweyn, who had been outlawed for the seduction of the abbess of Leominster, returned and demanded his restoration. This was refused and Sweyn returned into exile, but not before he had with foullest treachery murdered his young kinsman Beorn. He was, however, outlawed next year. The influence of Godwine, already shaken, received a severe blow in 1051 in the appointment of Robert of Jumièges to the archbishopric of Canterbury, and the same year saw the triumph of the foreigners for the moment complete. Edward, indignant at the resistance offered by the men of Dover to the insolence of his brother-in-law Eustace of Boulogne and his French followers, ordered Godwine to punish the town. Godwine refused. The king at the prompting of the archbishop then summoned a meeting of the witan, at which the old charge against Godwine of complicity in the murder of the Ætheling Alfred was to be revived. About the same time came news of a fresh outrage by the foreigners. Godwine gathered his forces and demanded redress, while the earls Leofric of Mercia and Sward of Northumbria hastened to the side of the king. Civil war seemed imminent, but at length a compromise was effected by which the matter was referred to a meeting of the witan to be held at London. At the appointed time Godwine presented himself at Southwark. But his followers were rapidly deserting him, nor would the king give hostages for his security. Alarmed for his safety, he fled to Flanders, while his son Harold went to Ireland. But their exile was brief. The tale of Godwine excited universal sympathy, for it was realized that he represented the cause of national independence. Encouraged by assurances from England, he sailed thither, and joining forces with Harold sailed along the south coast and up the Thames. The king would have resisted but found no support. Yielding to circumstances, he allowed himself to be reconciled, and Godwine and his house were restored to their old position. The queen at the same time was brought back from the monastery of Wherwell, whither she had been despatched after her father's flight. The foreigners had

already ignominiously fled the country, and henceforth the influence of Godwine, and, after his death, of Harold, was supreme. In 1063 Harold made a great expedition into Wales, in which he crushed the power of King Gruffyd, who was killed by his own people. But despite his prowess and his power, he was the minister of the king rather than his personal favourite. This latter position belonged to his younger brother Tostig, who on the death of Siward in 1055 was appointed earl of Northumbria. Here his severity and arbitrary temper rendered him intensely unpopular, and in 1065 his subjects broke into revolt. They elected Morkere as their earl, then marching south demanded Tostig's banishment. Edward desired to crush the revolt by force of arms, but he was overborne and forced to submit. The election of Morkere was recognized, and Tostig went into exile. Intensely mortified at this humiliation, the king fell sick, and henceforth his health failed rapidly. He was unable to gratify his intense desire to be present at the consecration of his new abbey of Westminster, the foundation of which had been the chief interest of his closing years, and on the 5th of January 1066 he died.

The virtues of Edward were monkish rather than kingly. In the qualities of a ruler he was conspicuously deficient; always dependent on others, he ever inclined to the unworthier master. But the charm of his character for the monastic biographer, and the natural tendency to glorify the days before the Norman oppression began, combined to cast about his figure a halo which had not attached to it in life. Allowed to keep her property by William the Conqueror, his widow, Edith, passed the remainder of her life at Winchester, dying on the 10th of December 1075.

SOURCES.—A number of lives of Edward are brought together in a volume of the Rolls Series entitled *Lives of Edward the Confessor*, and edited by Dr H. R. Luard (London, 1858). Of these by far the most valuable is the contemporary *Vita Edwardi*, which would appear from internal evidence to have been written by an unknown writer soon after the Norman Conquest—some time between 1066 and 1074. The other chief authorities for the reign are (1) the *Saxon Chronicle*, (C. Plummer, Oxford, 1822-1899); (2) *Floresce of Worcester*, ed. B. Thorpe, English Historical Society (London, 1841, 1849). Reference may also be made to J. M. Kemble, *Codes diplomaticæ ævi Saxonici* (London, 1839-1848). (C. S. P. 4)

EDWARD I. (1239-1307), king of England, born at Westminster on the 17th of June 1239, was the eldest son of Henry III. and Eleanor of Provence. He was baptized Edward after Edward the Confessor, for whom Henry had special veneration, and among his godfathers was Simon de Montfort, earl of Leicester, his aunt Eleanor's husband. His political career begins when the conclusion of a treaty with Alphonso X. of Castile, by which he was to marry the Spanish king's half sister Eleanor, necessitated the conferring on him of an adequate establishment. His father granted him the duchy of Gascony, the earldom of Chester, the king's lands in Wales and much else. The provision made was so liberal that Henry's subjects declared he was left no better than a mutilated king. In May 1254 Edward went to Gascony to take possession of his inheritance. He then crossed the Pyrenees, and in October was dubbed knight by Alphonso and married to Eleanor at the Cistercian convent of Las Huelgas, near Burgos. He remained in Gascony till November 1255, but his father was too jealous to allow him a free hand in its administration. After his return, the attempts of his agents to establish English laws in his Welsh possessions brought Edward into hostile relations with the Welsh. Here also his father would give him no help, and his first campaign brought him little result. Edward became extremely unpopular through his association with his Lusignan kinsfolk, his pride and violence, and the disorders of his household. In 1258 his strenuous opposition to the Provisions of Oxford further weakened his position, but, after the banishment of the foreigners, he began to take up a wiser line. In 1259 he led the young nobles who insisted that the triumphant oligarchy should carry out the reforms to which it was pledged. For a moment it looked as if Edward and Leicester might make common cause, but Edward remained an enemy of Montfort, though he strove to infuse his father's party with a more liberal and national spirit. He was the soul of the reconstituted royalist party formed about 1263. In 1264 he took a prominent part in the fighting between

the king and the barons. At the battle of Lewes his rash pursuit of the Londoners contributed to his father's defeat. Two days later Edward surrendered to Leicester as a hostage for the good behaviour of his allies. He was forced to give up his earldom of Chester to Leicester, but at Whitsuntide 1265 he escaped from his custodians, and joined the lords of the Welsh march who were still in arms. With their aid he defeated and slew Leicester at Evesham on the 4th of August 1265.

For the rest of Henry III.'s reign Edward controlled his father's policy and appropriated enough of Leicester's ideals to make the royalist restoration no mere reaction. So peaceful became the outlook of affairs that in 1268 Edward took the cross, hoping to join the new crusade of St Louis. Want of money delayed his departure till 1270, by which time St Louis was dead, and a truce concluded with the infidel. Refusing to be a party to such treason to Christendom, Edward went with his personal followers to Acre, where he abode from May 1271 to August 1272. Despite his energy and valour he could do little to prop up the decaying crusading kingdom and he narrowly escaped assassination. At last the declining health of his father induced him to return to the West. He learned in Sicily the death of Henry III. on the 16th of November 1272. On the 20th of November, the day of Henry's funeral, he was recognized as king by the English barons, and from that day his regnal years were subsequently computed. Affairs in England were so peaceful that Edward did not hurry home. After a slow journey through Italy and France he did homage to his cousin Philip III. at Paris, on the 26th of July 1273. He then went to Gascony, where he stayed nearly a year. At last he landed at Dover on the 2nd of August 1274, and was crowned at Westminster on the 18th of the same month.

Edward was thirty-five years old when he became king, and the rude schooling of his youth had developed his character and suggested the main lines of the policy which he was to carry out as monarch. He was a tall, well-proportioned and handsome man, extravagantly devoted to military exercises, tournaments and the rougher and more dangerous forms of hunting. He had learned to restrain the hot temper of his youth, and was proud of his love of justice and strict regard to his plighted word. His domestic life was unstained, he was devoted to his friends, and loyal to his subordinates. Without any great originality either as soldier or statesman, he was competent enough to appropriate the best ideas of the time and make them his own. His defects were a hardness of disposition which sometimes approached cruelty and a narrow and pedantic temper, which caused him to regard the letter rather than the spirit of his promises. His effectiveness and love of strong government stand in strong contrast to his father's weakness. Though he loved power, and never willingly surrendered it, he saw that to be successful he must make his policy popular. Thus he continued the system which Montfort had formed with the object of restraining the monarchy, because he saw in a close alliance with his people the best means of consolidating the power of the crown.

The first years of Edward's reign were mainly occupied by his efforts to establish a really effective administration. In carrying out this task he derived great help from his chancellor, Robert Burnell, bishop of Bath and Wells. Administrative reform soon involved legislation, and from 1275 to 1290 nearly every year was marked by an important law. Few of these contained anything that was very new or original. They rather illustrate that policy which caused Dr Stubbs to describe his reign as a "period of definition." Yet the results of his conservative legislation were almost revolutionary. In particular he left the impress of his policy on the land laws of England, notably by the clause *De Donis* of the Westminster statute of 1285, and the statute *Quia Emptores* of 1290. The general effect of his work was to eliminate feudalism from political life. At first he aimed at abolishing all franchises whose holders could not produce written warranty for them. This was the policy of the statute of Gloucester of 1278, but the baronial opposition was so resolute that Edward was forced to permit many immunities to remain. Though the most orthodox of churchmen, his dislike

of authority not emanating from himself threatened to involve him in constant conflict with the Church, and notably with John Peckham, the Franciscan friar, who was archbishop of Canterbury from 1279 to 1292. The statute of Mortmain of 1279, which forbade the further grant of lands to ecclesiastical corporations without the royal consent, and the writ *Circumspecte Agatis* of 1285, which limited the church courts to strictly ecclesiastical business, both provoked strong clerical opposition. However, Peckham gave way to some extent, and Edward prudently acquiesced in many clerical assumptions which he disliked. He was strong enough to refuse to pay the tribute to Rome which John had promised, and his reign saw the end of that papal overlordship over England which had greatly complicated the situation under his father.

Besides administration and legislation, the other great event of the first fifteen years of Edward's reign was the conquest of the principality of Wales. It was part of Edward's policy of reconciliation after the battle of Evesham that in the treaty of Shrewsbury of 1267 he had fully recognized the great position which Llewelyn ab Gruffydd, prince of Wales, had gained as the ally of Simon de Montfort. However, Llewelyn's early successes had blinded the Welsh prince to the limitations of his power, and he profited by Edward's early absences from England to delay in performing his feudal obligations to the new king. Even after Edward's return Llewelyn continued to evade doing homage. At last Edward lost patience, and in 1277 invaded north Wales. He conducted his campaign like a great siege, blocking all the avenues to Snowdon, and forcing Llewelyn to surrender from lack of supplies. He thereupon reduced the Welsh prince to the position of a petty north Welsh chieftain strictly dependent on the English. For the next five years Edward did his best to set up the English system of government in the ceded districts. The Welsh resentment of this soon gave Llewelyn another chance, and compelled Edward to devote the years 1282-1283 to completing his conquest. In 1284 he issued the statute of Wales, which provided for a scheme for the future government of the principality. Edward is often called the conqueror of Wales, but in truth he only effected the conquest of Llewelyn's dominions. The march of Wales was only indirectly affected by his legislation, and remained subject to its feudal marcher lords until the 16th century.

Edward was very careful in his foreign policy. Though preserving nominal peace with his cousin Philip III. of France, his relations with that country were constantly strained. After Philip III.'s death in 1285, Edward crossed the Channel in 1286, to perform homage to his successor, Philip the Fair. He remained abroad till 1289, busied in attempts to improve the administration of Gascony, and making repeated and finally successful efforts to end by his mediation the still continuing struggle between the houses of Anjou and Aragon. His long absence threw the government of England into confusion, and on his return in 1289 he was compelled to dismiss most of his judges and ministers for corruption. In 1290 he expelled all Jews from England.

The affairs of Scotland furnished Edward with his chief preoccupation for the rest of his reign. After the death of Alexander III., in 1286, Scotland was governed in the name of his granddaughter Margaret, the Maid of Norway. The English king had suggested that Edward of Carnarvon, his eldest surviving son, should marry the little queen of Scots, and thus bring about the union of the two countries. Unluckily the death of Margaret in 1290 frustrated the scheme. The Scottish throne was now disputed by many claimants, and the Scots asked Edward to arbitrate between them. Edward accepted the position, but insisted that, before he acted, the Scots should recognize him as their overlord. The claimants set the example of submission, and soon the chief Scots nobles followed. Thereupon Edward undertook the arbitration, and in 1292 adjudged the throne to John Baliol. The new king did homage to Edward, but his subjects soon began to resent the claims of jurisdiction over Scotland, which Edward declared were the natural results of his feudal supremacy. At last the Scots deprived John of nearly all his power, repudiated Edward's claims, and made an alliance

with the French. During the years of the Scottish arbitration Edward had slowly been drifting into war with France. The chronic difficulties caused by French attempts to confine Edward's power in Gascony were now accentuated by the quarrels between the sailors and merchants of the two countries. In 1293 Edward was persuaded by his brother, Edmund, earl of Lancaster, to yield up Gascony temporarily to Philip the Fair. But Philip refused to restore the duchy, and Edward, seeing that he had been tricked, declared war against France, at the very moment when the Scottish resistance gave the French a firm ally in Britain. To make matters worse, the Welsh rose in rebellion. It was therefore quite impossible for Edward to recover Gascony.

The most critical years of Edward's reign now began. He saw that he could only meet his difficulties by throwing himself on the support of his own subjects, and convoked, in 1295, a representative parliament of the three estates, which has been called in later times the Model Parliament, because it first illustrated the type which was to be perpetuated in all subsequent parliaments. "What touches all," ran Edward's writ of summons, "should be approved of all, and it is also clear that common dangers should be met by measures agreed upon in common." The parliamentary constitution of England was established as the result of Edward's action.

Secure of his subjects' allegiance, Edward put down the Welsh revolt, and conquered Scotland in 1296. When quiet was restored to Britain, he hoped to throw all his energy into the recovery of Gascony, but new troubles arose at home which once more diverted him from his supreme purpose. Led by Archbishop Winchelsea, Peckham's successor, the clergy refused to pay taxes in obedience to the bull of Pope Boniface VIII., called *Clericis Laicos*. Edward declared that if the clergy would not contribute to support the state, the state could afford them no protection. But the clerical opposition was soon joined by a baronial opposition. Headed by the earls of Hereford and Norfolk, many of the barons declined to join in an expedition to Gascony, and Edward was forced to sail to the French war, leaving them behind. Thereupon the recalcitrant barons forced upon the regency a fresh confirmation of the charters, to which new articles were added, safeguarding the people from arbitrary taxation. Edward at Ghent reluctantly accepted this *Confirmatio Cartarum*, but even his submission did not end the crisis. In the same year (1297), all Scotland rose in revolt under the popular hero William Wallace, and next year (1298), Edward was forced to undertake its reconquest. The battle of Falkirk, won on the 22nd of July, was the greatest of Edward's military triumphs; but, though it destroyed the power of Wallace, it did not put an end to Scottish resistance. Bitter experience taught Edward that he could not fight the French and the Scots at the same time, and in 1299 he made peace with Philip, and, Eleanor having died in November 1290, he married the French king's sister Margaret (c. 1282-1318), and some years later obtained the restitution of Gascony. In the same spirit he strove to destroy the clerical and baronial opposition. He did not succeed in the former task until a complacent pope arose in his own subject, Clement V., who abandoned Winchelsea to his anger, and suffered the archbishop to be driven into exile. The baronial leaders could not be wholly overthrown by force, and Edward was compelled to make them fresh concessions.

It was not until 1303 that Edward was able to undertake seriously the conquest of Scotland. By 1305 the land was subdued, and Wallace beheaded as a traitor. But Edward had hardly organized the government of his new conquest when a fresh revolt broke out under Robert Bruce, grandson of the chief rival of Baliol in 1290. Bruce was soon crowned king of Scots, and at the age of seventy Edward had to face the prospect of conquering Scotland for the third time. He resolved to take the field in person; but the effort was too great, and on the 7th of July 1307 he died at Burgh-on-Sands, near Carlisle. His death destroyed the last faint hope of conquering Scotland, and showed that the chief ambition of his life was a failure. Yet his conquest of Wales, his legislation, his triumph over his barons, his ecclesiastics, and the greatest of French medieval kings

indicate the strength and permanence of his work. He was buried at Westminster under a plain slab on which was inscribed *Edwardus primus Scottorum malleus hic est. Poctum seruo.*

By Eleanor of Castile Edward had four sons, his successor Edward II. and three who died young, and nine daughters, including Joan, or Joanna (1272-1307), the wife of Gilbert de Clare, earl of Gloucester (d. 1295), and then of Ralph de Monthermer; Margaret (1275-1318), the wife of John II, duke of Brabant; and Eleanor (1282-1316), who married John I., count of Holland, and then Humphrey Bohun, earl of Hereford (d. 1322). By Margaret of France the king had two sons: Thomas of Brotherton, earl of Norfolk, and Edmund of Woodstock, earl of Kent.

The principal modern authorities for this reign are: W. Stubbs, *Constitutional History of England*, vol. ii. chaps. xiv. and xv. (1896); T. F. Tout, *Edward I.* (1893), and *Political History of England, 1216-1377*, pp. 136-235 (1905); R. B. Seeley, *Life and Reign of Edward I.* (1872); R. Pauli, *Geschichte von England*, iv. pp. 1-198 (Hamburg, 1864-1875); W. Hunt, article on "Edward I." in *Dictionary of National Biography*; J. E. Morris, *Welsh Wars of Edward I.* (Oxford, 1901); and C. V. Langlois's *Philippe le Hardi* (Paris, 1887). (T. F. T.)

EDWARD II. (1284-1327), "of Carnarvon," king of England, the fourth son of Edward I. by his first wife Eleanor of Castile, was born at Carnarvon Castle on the 25th of April 1284. The story that the king presented the new-born child to the Welsh as their future native prince is quite unfounded, for Edward was only made prince of Wales in the Lincoln parliament of 1301. When a few months old, he became by his elder brother's death the heir to the throne, and Edward I. took great pains to train him in warfare and statecraft. He took part in several Scots campaigns, but all his father's efforts could not prevent his acquiring the habits of extravagance and frivolity which he retained all through his life. The old king attributed his son's defects to the bad influence of his friend, the Gascon knight Piers Gaveston, and drove the favourite into exile. When Edward I. died, on the 7th of July 1307, the first act of the prince, now Edward II., was to recall Gaveston. His next was to abandon the Scots campaign on which his father had set his heart.

The new king was physically almost as fine a man as Edward I. He was, however, destitute of any serious purpose, and was, as Dr Stubbs says, "the first king after the Conquest who was not a man of business." He cared for nothing but amusing himself, and found his chief delight in athletics and in the practice of mechanical crafts. He was not so much vicious as foolish, and wanting in all serious interests. He had so little confidence in himself that he was always in the hands of some favourite who possessed a stronger will than his own. In the early years of his reign Gaveston held this rôle, acting as regent when Edward went to France—where, on the 25th of January 1308, he married Isabella, the daughter of Philip the Fair—and receiving the earldom of Cornwall with the hand of the king's niece, Margaret of Gloucester. The barons soon grew indignant at Edward's devotion to his "brother Piers," and twice insisted on his banishment. On each occasion Edward soon recalled his friend, whereupon the barons, headed by the king's cousin Thomas, earl of Lancaster, went to war against king and favourite, and in 1312 treacherously put Gaveston to death. Edward was not strong enough even to avenge his loss. He was forced to stand aside and suffer the realm to be governed by the baronial committee of twenty-one lords ordainers, who, in 1311, had drawn up a series of ordinances, whose effect was to substitute ordainers for the king as the effective government of the country. But in all the ordinances nothing was said about the commons and lower clergy. Parliament meant to the new rulers an assembly of barons just as it had done to the opponents of Henry III. in 1258. The effect of their triumph was to change England from a monarchy to a narrow oligarchy.

During the quarrels between Edward and the ordainers, Robert Bruce was steadily conquering Scotland. His progress was so great that he had occupied all the fortresses save Stirling, which he closely besieged. The danger of losing Stirling shamed Edward and the barons into an attempt to retrieve their lost

ground. In June 1314 Edward led a great army into Scotland in the hope of relieving Stirling. On the 24th of June his ill-disciplined and badly led host was completely defeated by Robert Bruce at Bannockburn. Henceforth Bruce was sure of his position as king of Scots, and his pitiless devastation of the northern counties of England was his wild vengeance for the sufferings his land had previously experienced from the English. Edward's disgraceful defeat made him more dependent on his barons than ever. His kinsman, Thomas of Lancaster, had now an opportunity of saving England from the consequences of the king's incompetence. He had shown some capacity as a leader of opposition, but though he had great wealth, and was lord of five earldoms, he had small ability and no constructive power. In his desire to keep the king weak, he was suspected to have made a secret understanding with Robert Bruce. Before long the opposition split up under his incompetent guidance into fiercely contending factions. Under Aymer of Valence, earl of Pembroke, a middle party arose, which hated Lancaster so much that it supported the king to put an end to Lancaster's rule. After 1318 the effect of its influence was to restore Edward to some portion of his authority. However, the king hated Pembroke almost as much as Lancaster. He now found a competent adviser in Hugh le Despenser, a baron of great experience. What was more important to him, he had in Despenser's son, Hugh le Despenser the younger, a personal friend and favourite, who was able in some measure to replace Gaveston. The fierce hatred which the barons manifested to the Despensers showed that they could hate a deserter as bitterly as they had hated the Gascon adventurer. They were indignant at the favours which Edward lavished upon the favourite and his father, and were especially alarmed when the younger Despenser strove to procure for himself the earldom of Gloucester in right of his wife, Edward's niece.

At last, in 1321, the barons met in parliament, and under Lancaster's guidance procured the banishment of the Despensers. The disasters of his friends inspired Edward to unwonted activity. In 1322 he recalled them from exile, and waged war against the barons on their behalf. Triumph crowned his exertions. Lancaster, defeated at Boroughbridge, was executed at Pontefract. For the next five years the Despensers ruled England. Unlike the ordainers, they took pains to get the Commons on their side, and a parliament held at York in 1322 revoked the ordinances because they trenchanted upon the rights of the crown, and were drawn up by the barons only. From this time no statute was technically valid unless the Commons had agreed to it. This marks the most important step forward in Edward II.'s reign. But the rule of the Despensers soon fell away from this wise beginning. They thought only of heaping up wealth for themselves, and soon stirred up universal indignation. In particular, they excited the ill-will of the queen, Isabella of France. Craftily dissembling her indignation, Isabella kept silence until 1325, when she went to France in company with her eldest son, Edward of Windsor, who was sent to do homage for Aquitaine to her brother, the new French king. When her business was over, Isabella declined to return to her husband as long as the Despensers remained his favourites. She formed a criminal connexion with Roger Mortimer of Wigmore, one of the baronial exiles, and in September 1326 landed in Essex accompanied by Mortimer and her son, declaring that she was come to avenge the murder of Lancaster, and to expel the Despensers. Edward's followers deserted him, and on the 2nd of October he fled from London to the west, where he took refuge in the younger Despenser's estates in Glamorgan. His wife followed him, put to death both the Despensers, and, after a futile effort to escape by sea, Edward was captured on the 16th of November. He was imprisoned at Kenilworth Castle, and a parliament met at Westminster in January 1327, which chose his son to be king as Edward III. It was thought prudent to compel the captive king to resign the crown, and on the 20th of January Edward was forced to renounce his office before a committee of the estates. The government of Isabella and Mortimer was so weakly established that it dared

not leave the deposed king alive. On the 3rd of April he was secretly removed from Kenilworth and entrusted to the custody of two dependants of Mortimer. After various wanderings he was imprisoned at Berkeley Castle in Gloucestershire. Every indignity was inflicted upon him, and he was systematically ill-treated in the hope that he would die of disease. When his strong constitution seemed likely to prevail over the ill-treatment of his enemies he was cruelly put to death on the 21st of September. It was announced that he had died a natural death, and he was buried in St Peter's Abbey at Gloucester, now the cathedral, where his son afterwards erected a magnificent tomb.

Edward's wife, Isabella (c. 1292-1358), bore him two sons, Edward III. and John of Eltham, earl of Cornwall (1316-1336), and two daughters, Isabella and Joanna (1321-1362), wife of David II., king of Scotland. After the execution of her paramour, Roger Mortimer, in 1330, Isabella retired from public life; she died at Hertford on the 23rd of August 1358.

See R. Pauli, *Geschichte von England*, iv. pp. 199-306; T. F. Tout, *Political History of England, 1216-1307*, pp. 236-304, and article in *Dictionary of National Biography*; W. Stubbs, *Constitutional History*, vol. ii. pp. 319-386, and *Introductions to Chronicles of the Reigns of Edward I. and Edward II.* in *Rolls series*. (T. F. T.)

EDWARD III. (1312-1377), "of Windsor," king of England, eldest son of Edward II. and Isabella of France, was born at Windsor on the 13th of November 1312. In 1320 he was made earl of Chester, and in 1325 duke of Aquitaine, but he never received the title of prince of Wales. Immediately after his appointment to Aquitaine, he was sent to France to do homage to his uncle Charles IV., and remained abroad until he accompanied his mother and Mortimer in their expedition to England. To raise funds for this he was betrothed to Philippa, daughter of the count of Hainaut. On the 26th of October 1326, after the fall of Bristol, he was proclaimed warden of the kingdom during his father's absence. On the 13th of January 1327 parliament recognized him as king, and he was crowned on the 29th of the same month.

For the next four years Isabella and Mortimer governed in his name, though nominally his guardian was Henry, earl of Lancaster. In the summer he took part in an abortive campaign against the Scots, and was married to Philippa at York on the 24th of January 1328. On the 15th of June 1330 his eldest child, Edward, the Black Prince, was born. Soon after, Edward made a successful effort to throw off his degrading dependence on his mother and her paramour. In October 1330 he entered Nottingham Castle by night, through a subterranean passage, and took Mortimer prisoner. On the 29th of November the execution of the favourite at Tyburn completed the young king's emancipation. Edward discreetly drew a veil over his mother's relations with Mortimer, and treated her with every respect. There is no truth in the stories that henceforth he kept her in honourable confinement, but her political influence was at an end.

Edward III.'s real reign now begins. Young, ardent and active, he strove with all his might to win back for England something of the position which it had acquired under Edward I. He bitterly resented the concession of independence to Scotland by the treaty of Northampton of 1328, and the death of Robert Bruce in 1329 gave him a chance of retrieving his position. The new king of Scots, David, who was his brother-in-law, was a mere boy, and the Scottish barons, exiled for their support of Robert Bruce, took advantage of the weakness of his rule to invade Scotland in 1332. At their head was Edward Baliol, whose victory at Dupplin Moor established him for a brief time as king of Scots. After four months Baliol was driven out by the Scots, whereupon Edward for the first time openly took up his cause. In 1333 the king won in person the battle of Halidon Hill over the Scots, but his victory did not restore Baliol to power. The Scots despised him as a puppet of the English king, and after a few years David was finally established in Scotland. During these years England gradually drifted into hostility with France. The chief cause of this was the impossible situation which resulted from Edward's position as duke of Gascony. Contributing causes were Philip's support

of the Scots and Edward's alliance with the Flemish cities, which were then on bad terms with their French overlord, and the revival of Edward's claim, first made in 1328, to the French crown. War broke out in 1337, and in 1338 Edward visited Coblenz, where he made an alliance with the emperor Louis the Bavarian. In 1339 and 1340 Edward endeavoured to invade France from the north with the help of his German and Flemish allies, but the only result of his campaigns was to reduce him to bankruptcy.

In 1340, however, he took personal part in the great naval battle off Sluys, in which he absolutely destroyed the French navy. In the same year he assumed the title of king of France. At first he did this to gratify the Flemings, whose scruples in fighting their overlord, the French king, disappeared when they persuaded themselves that Edward was the rightful king of France. However, his pretensions to the French crown gradually became more important. The persistence with which he and his successors urged them made stable peace impossible for more than a century, and this made the struggle famous in history as the Hundred Years' War. Till the days of George III. every English king also called himself king of France.

Despite his victory at Sluys, Edward was so exhausted by his land campaign that he was forced before the end of 1340 to make a truce and return to England. He unfairly blamed his chief minister, Archbishop Stratford, for his financial distress, and immediately on his return vindictively attacked him. Before the truce expired a disputed succession to the duchy of Brittany gave Edward an excuse for renewing hostilities with France. In 1342 he went to Brittany and fought an indecisive campaign against the French. He was back in England in 1343. In the following years he spent much time and money in rebuilding Windsor Castle, and instituting the order of the Garter, which he did in order to fulfil a vow that he had taken to restore the Round Table of Arthur. His finances, therefore, remained embarrassed despite the comparative pause in the war, although in 1339 he had repudiated his debt to his Italian creditors, a default that brought about widespread misery in Florence.

A new phase of the French war begins when in July 1346 Edward landed in Normandy, accompanied by his eldest son, Edward, prince of Wales, a youth of sixteen. In a memorable campaign Edward marched from La Hogue to Caen, and from Caen almost to the gates of Paris. It was a plundering expedition on a large scale, and like most of Edward's campaigns showed some want of strategic purpose. But Edward's decisive victory over the French at Crécy, in Ponthieu, on the 26th of August, where he scattered the army with which Philip VI. attempted to stay his retreat from Paris to the northern frontier, signally demonstrated the tactical superiority of Edward's army over the French. Next year Edward effected the reduction of Calais. This was the most solid and lasting of his conquests, and its execution compelled him to greater efforts than the Crécy campaign. Other victories in Gascony and Brittany further emphasized his power. In 1346, David, king of Scots, was also defeated and taken prisoner at Neville's Cross, near Durham. In the midst of his successes, however, want of money forced Edward to make a new truce in 1347. He was as far from the conquest of France as ever.

Edward returned to England in October 1347. He celebrated his triumph by a series of splendid tournaments, and completed his scheme for the establishment of the order of the Garter. In 1348 he rejected an offer of the imperial throne. In the same year the Black Death first appeared in England, and raged until 1349. Yet the horrors which it wrought hardly checked the magnificent revels of Edward's court, and neither the plague nor the truce stayed the course of the French war, though what fighting there was was indecisive and on a small scale. Edward's martial exploits during the next years were those of a gallant knight rather than those of a responsible general. Conspicuous among them were his famous combat with Eustace de Ribemont, near Calais, in 1349, and the hard-fought naval victory over the Spaniards off Winchelsea, in 1350. Efforts

to make peace, initiated by Pope Innocent VI., came to nothing, though the English commons were now weary of the war. The result of this failure was the renewal of war on a large scale. In 1355 Edward led an unsuccessful raid out of Calais, and in January and February 1356 harried the Lothians, in the expedition famous as the Burned Candlemas. His exploits sank into insignificance as compared with those of his son, whose victory at Poitiers, on the 19th of September 1356, resulted in the captivity of King John, and forced the French to accept a new truce. Edward entertained his royal captive very magnificently, and in 1359 concluded with him the treaty of London, by which John surrendered so much that the French repudiated the treaty. Edward thereupon resolved to invade France afresh and compel its acceptance. On the 28th of October he landed at Calais, and advanced to Reims, where he hoped to be crowned king of France. The strenuous resistance of the citizens frustrated this scheme, and Edward marched into Burgundy, whence he made his way back towards Paris. Failing in an attack on the capital, he was glad to conclude, on the 8th of May 1360, preliminaries of peace at Brétigny, near Chartres. This treaty, less onerous to France than that of London, took its final form in the treaty of Calais, ratified by King John on the 9th of October. By it Edward renounced his claim to France in return for the whole of Aquitaine.

The treaty of Calais did not bring rest or prosperity either to England or France. Fresh visitations of the Black Death, in 1362 and 1369, intensified the social and economic disturbances which had begun with the first outbreak in 1348. Desperate, but not very successful, efforts were made to enforce the statute of Labourers, of 1351, by which it was sought to maintain prices and wages as they had been before the pestilence. Another feature of these years was the anti-papal, or rather anti-clerical, legislation embodied in the statutes of Provisors and Praemunire. These measures were first passed in 1351 and 1353, but often repeated. In 1366 Edward formally repudiated the feudal supremacy over England, still claimed by the papacy by reason of John's submission. Another feature of the time was the strenuous effort made by Edward to establish his numerous family without too great expense. In the end the estates of the houses of Lancaster, Kent, Bohun, Burgh and Mortimer swelled the revenues of Edward's children and grandchildren, in whose favour also the new title of duke was introduced.

In 1369 the French king, Charles V., repudiated the treaty of Calais and renewed the war. Edward's French dominions gladly reverted to their old allegiance, and Edward showed little of his former vigour in meeting this new trouble. He resumed the title and arms of king of France, but left most of the fighting and administration of his foreign kingdoms to his sons, Edward and John. While the latter were struggling with little success against the rising tide of French national feeling, Edward's want of money made him a willing participator in the attack on the wealth and privileges of the Church. In 1371 a clerical ministry was driven from office, and replaced by laymen, who proved, however, less effective administrators than their predecessors. Meanwhile Aquitaine was gradually lost; the defeat of Pembroke off La Rochelle deprived England of the command of the sea, and Sir Owen ap Thomas, a grand-nephew of Llewelyn ab Gruffyd, planned, with French help, an abortive invasion of Wales. In 1371 the Black Prince came back to England with broken health, and in 1373 John of Lancaster marched to little purpose through France, from Calais to Bordeaux. In 1372 Edward made his final effort to lead an army, but contrary winds prevented his even landing his troops in France. In 1375 he was glad to make a truce, which lasted until his death. By it the only important possessions remaining in English hands were Calais, Bordeaux, Bayonne and Brest.

Edward was now sinking into his dotage. After the death of Queen Philippa he fell entirely under the influence of a greedy mistress named Alice Perrers, while the Black Prince and John of Gaunt became the leaders of sharply divided parties in the court and council of the king. With the help of Alice Perrers John of Gaunt obtained the chief influence with his father,

but his administration was neither honourable nor successful. His chief enemies were the higher ecclesiastics, headed by William of Wykeham, bishop of Winchester, who had been excluded from power in 1371. John further irritated the clergy by making an alliance with John Wycliffe. The opposition to John was led by the Black Prince and Edmund Mortimer, earl of March, the husband of Edward's grand-daughter, Philippa of Clarence. At last popular indignation against the courtiers came to a head in the famous Good Parliament of 1376. Alice Perrers was removed from court, and Duke John's subordinate instruments were impeached. But in the midst of the parliament the death of the Black Prince robbed the commons of their strongest support. John of Gaunt regained power, and in 1377 a new parliament, carefully packed by the courtiers, reversed the acts of the Good Parliament. Not long after Edward III. died, on the 21st of June 1377.

Edward III. was not a great man like Edward I. He was, however, an admirable tactician, a consummate knight, and he possessed extraordinary vigour and energy of temperament. His court, described at length in Froissart's famous chronicle, was the most brilliant in Europe, and he was himself well fitted to be the head of the magnificent chivalry that obtained fame in the French wars. Though his main ambition was military glory, he was not a bad ruler of England. He was liberal, kindly, good-tempered and easy of access, and his yielding to his subjects' wishes in order to obtain supplies for carrying on the French war contributed to the consolidation of the constitution. His weak points were his wanton breaches of good faith, his extravagance, his frivolity and his self-indulgence. Like that of Edward I. his ambition transcended his resources, and before he died even his subjects were aware of his failure.

Edward had twelve children, seven sons and five daughters. Five of his sons played some part in the history of their time, these being Edward the Black Prince, Lionel of Antwerp, duke of Clarence, John of Gaunt, duke of Lancaster, Edmund of Langley, afterwards duke of York, and Thomas of Woodstock, afterwards duke of Gloucester. John and Edmund are also important as the founders of the rival houses of Lancaster and York. Each of the last four was named from the place of his birth, and for the same reason the Black Prince is sometimes called Edward of Woodstock. The king's two other sons both died in infancy. Of his daughters, three died unmarried; the others were Isabella, who married into the family of Coucy, and Mary, who married into that of Montfort.

AUTHORITIES.—The two chief modern lives of Edward III. are W. Longman's *Life and Times of Edward III.*, and J. MacRinion's *History of Edward III.* Neither work can be regarded as adequate, and in some ways J. Barnes's quaint *History of Edward III.* (1688) is less unsatisfactory. The general history of the time can be read in W. Stubbs's *Constitutional History of England*, vol. ii. chapters xvii. and xviii.; in T. F. Tout's *Political History of England*, 1216-1377, pp. 301-441; in R. Pauli's *Geschichte von England*, iv. pp. 307-504; and in Edward's life by W. Hunt in the *Dictionary of National Biography*. For the Hundred Years' War, see E. Deprez's *Les Préliminaires de la guerre de cent ans, 1328-1342*, and H. Denifle's *La Désolation des églises, monastères et hôpitaux en France pendant la guerre de cent ans*. For economic and social history see W. J. Ashley's *English Economic History*, and W. Cunningham's *Growth of English Industry and Commerce during the Early and Middle Ages*. For the end of the reign see S. Armitage Smith's *John of Gaunt*, J. Lechler's *Wyclif und die Vorgeschichte der Reformation*, translated as *Wycliffe and his English Precursors*, R. L. Poole's *Wycliffe and Movements for Reform*, and G. M. Trevelyan's *England in the Age of Wycliffe*. (T. F. T.)

EDWARD IV. (1442-1483), king of England, son of Richard, duke of York, by Cicely Neville, was born at Rouen on the 28th of April 1442. As a boy he was styled earl of March, and spent most of his time at Ludlow. After the Yorkist failure at Ludlow field in October 1459, Edward fled with the earls of Salisbury and Warwick, his uncle and cousin, to Calais. Thence in the following July he accompanied them in their successful invasion of England, to be welcomed in London, and to share in the victory over the Lancastrians at Northampton. After the acceptance of Richard of York as heir to the crown, Edward returned to the Welsh marches, where early in the new

year he heard of his father's defeat and death at Wakefield. Hastily gathering an army he defeated the earls of Pembroke and Wiltshire at Mortimer's Cross on the 2nd of February 1461, and then marched on London. He was acclaimed by the citizens in an assembly at Clerkenwell, declared king by a Yorkist council, and took possession of the regality on the 4th of March. Soon after the new king and the earl of Warwick went north, and on the 28th of March won a decisive victory at Towton.

Edward owed his throne to his kinsmen the Nevilles, and he was content for the time to be guided by them. For himself he was young and fond of pleasure. Still he made frequent progresses, and took some part in the fighting that went on in the north during 1462 and 1463. But he was absent from the final victory at Hexham on the 14th of May 1464, and was at the very time engaged in contracting a secret marriage with Elizabeth, daughter of Richard Woodville, Lord Rivers, and widow of Sir John Grey of Groby (d. 1461). The marriage was disclosed at Michaelmas, much to the vexation of Warwick, who in pursuit of his foreign policy had projected a match with a French princess. Edward heaped favours on his new relatives; his father-in-law was made treasurer, and great marriages were found for his wife's sisters and brothers. In foreign affairs also Edward thwarted Warwick's plans by favouring an alliance with Burgundy rather than France. There was, however, no open breach till 1469, when Warwick, taking advantage of the unpopularity of the Woodvilles, and supported by the king's next brother George, duke of Clarence, appeared in arms. Edward was surprised and made prisoner at Middleham, and Rivers was beheaded. For six months Edward had to submit to Warwick's tutelage; then on the occasion of a rising in Lincolnshire he gathered an army of his own. Sir Robert Welles, the leader of this rebellion, made a confession implicating Warwick, who fled with Clarence to France. The king thought himself secure, but when Warwick and Clarence made terms with the Lancastrian exiles, Edward in his turn had to seek refuge in Holland (September 1470). His brother-in-law, Charles of Burgundy, at first refused him any assistance, but at last furnished him with money, and on the 14th of March 1471 Edward and his brother Richard landed with a small force at Ravenspur near Hull. Marching south he was welcomed at London on the 11th of April, defeated Warwick at Barnet three days later, and the Lancastrians at Tewkesbury on the 4th of May. From thenceforth Edward's possession of the crown was secure. His position was strengthened by the birth of a son (2nd of November 1470, during his exile), and by the wealth which he acquired through the confiscation of the estates of his opponents. Clarence had made his peace with Edward, but was at enmity with his other brother Richard of Gloucester, who now married Warwick's second daughter and claimed a share in the Neville inheritance. Their rivalry and Clarence's continued intrigues furnished Edward with his chief domestic difficulty; the trouble was ended by the judicial murder of Clarence in 1478.

The only serious enterprise of these latter years was the short French war of 1475, from which Edward was bought out by the treaty of Pecquigny. As foreign policy it was inglorious, and involved a departure from Edward's earlier plan of a Burgundian alliance. However, it shows a certain recognition of England's need to concentrate her energies on her own development. The annual subsidy which Louis XI. agreed to pay further served Edward's purposes by providing him with money for home government, and enabled him to avoid possible trouble through the necessity for too frequent parliaments and heavy taxation. So Edward's personal rule became in its character autocratic; but it was in the art of courting popularity and concealing despotism that he most shows himself as a type of tyranny. He lacked neither ambition nor capacity, but was indolent and only exerted himself spasmodically. He could be ruthless, but was not habitually cruel. His strongest weapons were the fine presence, the affable manners (even with citizens), and the love of pleasure and entertainments which secured his personal popularity. In his last years he was given to self-

indulgence and scandalous excesses, which did not, however, alienate the London citizens, with whose wives he was too familiar. Most of the power at court was in the hands of the Woodvilles, in spite of their unpopularity; the more arduous work of administration in the north was left to Richard of Gloucester. If as a prince of the Renaissance Edward was the first to rule tyrannically in England, he also deserves credit as a patron of the new culture and friend of Caxton; he further resembles his Italian contemporaries in the commercial purposes to which he applied his wealth in partnership with London merchants.

Edward died at Westminster on the 9th of April 1483, and was buried at Windsor. By Elizabeth Woodville, who died on the 8th of June 1492, he had two sons, Edward V. and Richard of York, who were murdered in the Tower; and five daughters, of whom the eldest, Elizabeth, married Henry VII. Of his numerous mistresses the most notorious was Jane Shore. Before his marriage he had been contracted to Lady Eleanor Butler, and this was alleged by Richard III. to have made his children by Elizabeth Woodville illegitimate.

BIBLIOGRAPHY.—Of original authorities for Edward's reign the chief are the *Continuation of the Croyland Chronicle* in Fulman's *Scriptores*; the various London Chronicles, especially for the early years *Gregory's Chronicle*; Markworth's *Chronicle*, and the *Arrest of King Edward IV.* (a partisan account of events in 1470-1471), published by the Camden Society; the *Paston Letters* with Dr Gairdner's valuable Introduction; and for foreign affairs the *Mémoires* of Philippe de Comines; the collection called *Chronicles of the White Rose* is useful. For modern authors, consult Sir James Ramsay's *Lancaster and York* (1892), and the *Political History of England*, vol. iv. (1906), by Prof. C. Oman. (C. L. K.)

EDWARD V. (1470-1483), king of England, was the elder son of Edward IV. by his wife Elizabeth Woodville, and was born, during his father's temporary exile, in the sanctuary of Westminster Abbey on the 2nd of November 1470. In June 1471 he was created prince of Wales. When Edward IV. died in April 1483 a struggle for power took place between the young king's paternal uncle, Richard, duke of Gloucester, who had been appointed as his guardian by Edward IV., and his maternal uncle, Richard Woodville, Earl Rivers. Gloucester obtained possession of the king's person, and, having arrested Rivers and some of his supporters, assumed the crown himself after a very slight and feigned reluctance, on the ground that the marriage of Edward and Elizabeth Woodville was invalid, and consequently its issue was illegitimate. At this time Edward and his brother Richard, duke of York, were living in the Tower of London. Shortly afterwards a movement was organized to free them from captivity, and then it became known that they were already dead; but, though it was the general conviction that they had been murdered, it was twenty years before the manner of this deed was discovered. According to the narrative of Sir Thomas More, Sir Robert Brackenbury, the constable of the Tower, refused to obey Richard's command to put the young princes to death; but he complied with a warrant ordering him to give up his keys for one night to Sir James Tyrell, who had arranged for the assassination. Two men, Miles Forest and John Dighton, then smothered the youths under pillows while they were asleep. The murder was committed most probably in August or September 1483. Horace Walpole has attempted to cast doubts upon the murder of the princes, and Sir C. R. Markham has argued that the deed was committed by order of Henry VII. Both these views, however, have been traversed by James Gairdner, and there seems little doubt that Sir Thomas More's story is substantially correct.

See **RICHARD III.**; and in addition, Sir Thomas More, *History of Richard III.*, edited by J. R. Lumby (Cambridge, 1883); Horace Walpole, *Historic Doubts on the Life and Reign of Richard III.* (London, 1768); J. Gairdner, *Richard III.* (Cambridge, 1898); J. Gairdner and C. R. Markham in the *English Historical Review*, vol. vi. (London, 1891); Sir C. R. Markham, *Richard III.* (1907).

EDWARD VI. (1537-1553), king of England and Ireland, born at Greenwich on the 12th of October 1537, was the only child of Henry VIII. by his third wife, Jane Seymour, who died of puerperal fever twelve days later. The story that the mother's life was deliberately sacrificed by the performance of Caesarean

section is unfounded, although Jane's death was little noticed amid the rejoicings which greeted the advent of a male heir to the throne. But in spite of Holbein's vivacious portrait of Edward at the age of two (now at Hanover), he was a frail child, and a short life was anticipated for him from his early years. This did not prevent a strenuous education; until the age of six he was naturally left in the charge of women, but when he was only seven his tutor Dr Coxe, afterwards bishop of Ely, writes that he could decline any Latin noun and conjugate any regular verb (*L. and P.*, 1544, ii. 726); "every day in the mass-time he readeth a portion of Solomon's Proverbs, wherein he delighteth much." Sir John Cheke, Sir Anthony Cooke and Roger Ascham all helped to teach him Latin, Greek and French; and by the age of thirteen he had read Aristotle's *Ethics* in the original and was himself translating Cicero's *De philosophia* into Greek.

Edward was duke of Cornwall from his birth, but he was never prince of Wales, and he was only nine when he succeeded his father as king of England and Ireland and supreme head of the church (28th of January 1546/7). His nonage threw power into the hands of Somerset and then of Northumberland, and enabled Gardiner and Bonner to maintain that the royal supremacy over the church was, or should be, in abeyance. Projects for his marriage were hardly even the occasion, but only the excuse, for Somerset's war on Scotland and Northumberland's subsequent alliance with France. All factions sought to control his person, not because of his personality but because of his position; he was like the Great Seal, only more so, an indispensable adjunct to the wielder of authority. The Protector's brother tried to bribe him with pocket-money; Northumberland was more subtle and established a complete dominion over his mind, and then put him forward at the age of fourteen as entitled to all the power of Henry VIII. But he was only Northumberland's mask; of his individual influence on the course of history during his reign there is hardly a trace. A posthumous effort was made to give him the credit of a humane desire to save Joan Bocher from the flames; but he recorded with apparently cold-blooded indifference the execution of both his uncles, and he certainly made no attempt to mitigate the harassing attentions which the council paid his sister Mary. This passed for piety with the zealots, and the persecutions of Mary's reign reflected a halo on that of the Protestant Josiah. So strong was the regret that rumours of his survival persisted, and hare-brained youths were found to personate him throughout Mary's and even far into Elizabeth's reign.

It was well that they were false, for Edward showed signs of all the Tudor obstinacy, and he was a fanatic into the bargain, as no other Tudor was except Mary. The combination would probably have involved England in disasters far greater than any that ensued upon his premature death; and it was much better that the Anglican settlement of religion should have been left to the compromising temper of Elizabeth. As it was, he bequeathed a legacy of woe; his health began to fail in 1552, and in May 1553 it was known that he was dying. But his will and the various drafts of it only betray the agitated and illogical efforts of Northumberland to contrive some means whereby he might continue to control the government and prevent the administration of justice. Mary and Elizabeth were to be excluded from the throne, as not sufficiently pliant instruments; Mary Stuart was ignored as being under Scottish, Catholic and French influence; the duchess of Suffolk, Lady Jane's mother, was excluded because she was married, and the duke her husband might claim the crown matrimonial. In fact, all females were excluded, except Jane, on the ground that no woman could reign; even she was excluded in the first draft, and the crown was left to "the Lady Jane's heirs male." But this draft was manipulated so as to read "the Lady Jane and her heirs male." That Edward himself was responsible for these delirious provisions is improbable. But he had been so impregnated with the divine right of kings and the divine truth of Protestantism that he thought he was entitled and bound to override the succession as established by law and exclude a Catholic from the throne; and his last recorded words were vehement injunctions to Cranmer to sign the will.

He died at Greenwich on the 6th of July 1553, and was buried in Henry VII.'s chapel by Cranmer with Protestant rites on the 8th of August, while Mary had Mass said for his soul in the Tower.

J. G. Nichols collected almost all that is known of Edward VI. in his excellent edition of the king's *Journal*. A few additional facts and suggestions can be gleaned from the *Letters and Papers of Henry VIII.* vols. xii.-xxi.; *Acts of the Privy Council*, ed. Dasent, vols. i.-iv.; Domestic, Spanish, Venetian and Foreign *Calendars of State Papers*; Froude's *History*; Dixon's *Hist. Church of England*; A. F. Pollard's *England under Somerset and Life of Cranmer*; and *English Historical Review*, xxiii. 286, &c. Sir Clements Markham's *Edward VI.* (1907) emphasizes his interest in geography. (A. F. P.)

EDWARD VII. (ALBERT EDWARD) (1841-1910), king of Great Britain and Ireland, and of the British Dominions beyond the Seas, emperor of India, the eldest son and second child of Queen Victoria and of Albert, prince consort, was born at Buckingham Palace on the 9th of November 1841. He was created prince of Wales and earl of Chester on the 4th of December following, and was baptized on the 25th of January 1842. In his childhood he was educated by the dowager Lady Lyttelton; and in his boyhood successively by the Rev. Henry Mildred Birch, Mr F. W. Gibbes, the Rev. C. F. Tarver and Mr Herbert W. Fisher. He afterwards resided at Edinburgh, studying chemistry in its industrial applications under Professor (afterwards Lord) Playfair at the university; at Christ Church, Oxford, and at Trinity College, Cambridge. In November 1858 he was made a knight of the Garter and a colonel in the army. In 1859 he travelled in Italy and Spain, and in 1860 paid a visit as "Lord Renfrew" to the United States and Canada.

Upon the completion of his Cambridge course in June 1861 he joined the camp at the Curragh. The prince consort died on the 13th of December, and in 1862 the prince of Wales went for a tour in the Holy Land (February-June) under the guidance of Arthur Penrhyn Stanley, afterwards dean of Westminster. Early in 1863 he was sworn of the privy council, and took his seat in the House of Lords as duke of Cornwall. The estate of Sandringham, in Norfolk, was purchased for him out of the savings of his minority, and his town residence was fixed at Marlborough House.

His impending marriage to the princess Alexandra, daughter of Christian IX., king of Denmark (b. December 1, 1844), had already been announced, and took place on the 10th of March at Windsor, the beauty and grace of the princess captivating the heart of the nation. Parliament granted the prince an income of £40,000 a year, exclusive of the revenues of the duchy of Cornwall, and he relinquished his right of succession to the duchy of Saxe-Coburg-Gotha. Prince Albert Victor, afterwards duke of Clarence, was the first offspring of the marriage, being born on the 8th of January 1864. The births followed of Prince George Frederick Ernest Albert, afterwards duke of York (see GEORGE V.), on the 3rd of June 1865; Princess Louise Victoria Alexandra Dagmar, by marriage duchess of Fife, princess royal, on the 20th of February 1867; Princess Victoria Alexandra Olga Mary, on the 6th of July 1868; and Princess Maud Charlotte Mary Victoria, afterwards queen of Norway, on the 26th of November 1869.

From the time of their marriage the prince and princess were prominently before the country. Queen Victoria remained in retirement, but they filled her place at important public functions. The prince's readiness to promote every worthy cause was most marked; no one was a more constant attendant at meetings for objects of public utility of a non-political nature, and his speeches were always characterized by excellent sense. The most important external event of these years was a tour to Egypt, undertaken in 1869 in company with the duke of Sutherland, Sir Samuel Baker and others, an account of which was published by Mrs William Grey. The prince also visited Ireland more than once, and opened the International Exhibition of 1871.

On the 23rd of November 1871 it was announced that the prince would be prevented from paying a visit which had been arranged to the Maharajah Dhuleep Singh by a feverish attack. It soon appeared that the malady was typhoid, contracted.

as was supposed, on a visit to Scarborough. The case became so serious that on November 29 the queen and Princess Alice hurried to Sandringham. On the 1st of December there was a slight rally, but on the 8th so serious a relapse occurred that for some days the prince's life was despaired of. Under the skilful treatment of Sir William Jenner, Sir William Gull and Sir James Paget, however, the crisis was surmounted by December 16, and by Christmas day the danger was regarded as virtually over. On the 27th of February 1872 a thanksgiving was held at St Paul's, amid imposing demonstrations of public joy.

In January 1874 the prince of Wales attended the marriage at St Petersburg of his brother, the duke of Edinburgh, with the grand-duchess Marie of Russia. In the same year he paid a historic visit to Birmingham, where Mr Joseph Chamberlain, not yet a member of parliament, received him officially as mayor. In March 1875 it was officially announced that he would make a visit to India, carrying out an idea originally conceived by the first Indian viceroy, Earl Canning. He was supposed to travel as heir-apparent, not as representative of the queen; but the characters could not be kept apart, and in fact the prince's visit was a political event of great importance. Leaving England on October 11, he was received at Bombay by the viceroy, Lord Northbrook. Here he met a very large number of Indian feudatory princes, whose acquaintance he subsequently improved by visiting at their courts during the seventeen weeks which he spent in the country. During these four months the prince travelled nearly 8000 m. by land and 2500 m. by sea, became acquainted with more rajahs than had all the viceroys who had reigned over India, and saw more of the country than any living Englishman. The visit led up to the queen's assumption of the title of empress of India in the following year.

The prince's life after this date was full of conspicuous public appearances. In 1885 he visited Ireland at a time of much political excitement, and was received enthusiastically in many quarters and without symptoms of ill-will in any. In 1886 he filled the presidency of the Indian and Colonial Exhibition, opened the Mersey Tunnel, and laid the first stone of the Tower Bridge. In 1887 a large share of the arrangements for the queen's Jubilee devolved upon him. On the 27th of July 1889 his eldest daughter, Princess Louise, was married to the duke of Fife. In the autumn he paid a semi-incognito visit to Paris, where he was always highly popular, viewed the Exhibition, and ascended the Eiffel Tower. In 1890 he opened the Forth Bridge. On the 14th of January 1892, however, a heavy blow fell upon him and his house by the death of his eldest son, Prince Albert Victor, duke of Clarence, after a brief illness. The young prince, who with his brother George had made the tour of the world (1879-1882) in H.M.S. "Bacchante," and after a short career at Oxford and Cambridge was just settling down to play his part in public life, had recently become engaged to Princess Victoria Mary of Teck (b. May 26, 1867), and the popularity of the heir to the crown had been increased by the expression of his satisfaction at his son's bride being an English princess. On the 6th of July 1893 the broken thread was reunited by her marriage to Prince George, duke of York.

The year 1894 was a busy one for the prince of Wales, who became a member of the royal commission on the housing of the poor, opened the Tower Bridge, attended the Welsh Eisteddfod and was duly initiated, and paid two visits to Russia—one for the marriage of the grand-duchess Xenia, the other for the funeral of the tsar, his brother-in-law. In 1896 he became first chancellor of the university of Wales, and his first act after his installation at Aberystwyth was to confer an honorary degree upon the princess. He had already been for some years a trustee of the British Museum. On the 22nd of July 1896 his daughter, Princess Maud, was married to Prince Charles of Denmark, who in 1905 was offered and accepted the crown of the new kingdom of Norway. The arrangements for the queen's Jubilee of 1897 depended upon the prince even more than those of the corresponding celebration in 1837: he rode on the queen's right at the great procession to St Paul's, and as an admiral of the fleet presided at the naval

review at Spithead. In July 1898 the prince had the misfortune to fracture his knee-cap while on a visit to Baron Ferdinand de Rothschild, but completely recovered from the effects of the accident. In December 1899, while passing through Brussels on his way to St Petersburg, he was fired at by a miserable lad named Spido, crazed by reading anarchist literature. Fortunately no injury was done.

It was the especial distinction of Albert Edward, while prince of Wales, to have been a substantial support of the throne before he was called upon to fill it. This cannot be said of any of his predecessors except Edward the Black Prince. He was exemplary in the discharge of his public duties, and in his scrupulous detachment from party politics. He was a keen patron of the theatre, and his thoroughly British taste for sport was as pronounced as his inclination for most of the contemporary amusements of society. The "Tranby Croft Case" (1890), in which Sir William Gordon Cumming brought an unsuccessful libel action for having been accused of cheating at a game of baccarat, caused some comment in connexion with the prince's appearance in the witness-box on behalf of the defendants. But it did him no disservice with the people to have twice won the Derby with his horses Persimmon (1896) and Diamond Jubilee (1900)—his third victory, in 1909, with Minoru, being the first occasion on which the race had been won by a reigning sovereign; and his interest in yacht-racing was conspicuously shown at all the important fixtures, his yacht "Britannia" being one of the best of her day. His activity in the life of the nation may be illustrated by his establishment (1897) of the Prince of Wales's (afterwards King Edward's) Hospital Fund, his devotion to the cause of Masonry (he was first elected grand master of the Freemasons of England in 1874), and his position as a bencher of the Middle Temple, where he also became (1887) treasurer.

On the death of Queen Victoria on the 22nd of January 1901, the question what title the new king would assume was speedily set at rest by the popular announcement that he would be called Edward the Seventh. The new reign began auspiciously by the holding of a privy council at St James's Palace, at which the king announced his intention to follow in his predecessor's footsteps and to govern as a constitutional sovereign, and received the oaths of allegiance. On the 14th of February the king and queen opened parliament in state. Shortly afterwards it was announced that the visit of the duke and duchess of York to Australia, in order to inaugurate the new Commonwealth, which had been sanctioned by Queen Victoria, would be proceeded with; and on the 16th of March they set out on board the "Ophir" with a brilliant suite. The tour lasted till November 1, the duke and duchess having visited Australia, New Zealand, the Cape and Canada; and on their return the king, on November 9, created the duke prince of Wales and earl of Chester. Meanwhile parliament had settled the new civil list at £470,000 a year, and the royal title had been enlarged to include the colonial empire by an act enabling the king to style himself "Edward VII., by the grace of God, of the United Kingdom of Great Britain and Ireland, and of all the British Dominions beyond the Seas, King, Defender of the Faith, Emperor of India." At the end of May 1902 the long-drawn-out war in South Africa came at last to an end, and the coronation was fixed for the 26th of June. But on the 24th, amid general consternation, the king was announced to be suffering from perityphlitis, necessitating the immediate performance of an operation; and the coronation, for which unprecedented preparations had been made, had to be postponed. The operation—performed by Sir Frederick Treves—was, however, so marvellously successful, and the king's progress towards recovery so rapid and uninterrupted, that within a fortnight he was pronounced out of danger, and soon afterwards it was decided to hold the coronation service on August 9. Though shorn of much of the magnificence which would have been added to it in June by the presence of foreign royalties and the preparations for a great procession through London, the solemnity duly took place on that date in Westminster Abbey amid great

rejoicings. The king spent several weeks (partly in a yachting trip round the coast and up to Stornoway) in recruiting his health, and on the 25th of October he went in procession through the main streets of south London, when he was most enthusiastically received. Next day the king and queen attended St Paul's cathedral in state to return thanks for his restoration to health. On New Year's day 1903 the coronation was proclaimed in India at a magnificent durbar at Delhi.

At home the king opened parliament in person in February 1903, and on the 31st of March he sailed from Portsmouth to pay a visit to the king of Portugal at Lisbon, leaving Lisbon for Gibraltar on the 7th of April. On the 11th he held a review of the garrison troops and next day left for Malta, and the tour was continued to Naples (23rd of April). On the 27th of April he was received at Rome by the king of Italy—the first time an English king as such had been there; and two days later he paid a visit to Leo XIII. at the Vatican. On May day he was received in Paris by President Loubet. Later in the year return visits were paid to England by President Loubet (July) and the king and queen of Italy (November). On the 11th of May His Majesty paid his first formal visit to Edinburgh, and held courts at Holyrood. In July the king and queen went to Ireland, and though the Dublin corporation refused to vote a loyal address the reception was generally cordial. In September the king took his annual "cure" at Marienbad, and paid a visit to Vienna, where he was received by the Austrian emperor. In 1904 again the king and queen went to Ireland; in June the king was cordially received by the German emperor at the yacht-races at Kiel, and he included a visit to Hamburg, where the welcome was hearty. In November the king and queen of Portugal were entertained at Windsor and at the Guildhall.

The success of King Edward as a promoter of international friendliness, and the advantage of so efficient a type of kingship, attracted universal attention, and treaties of arbitration were concluded by Great Britain with France, Spain, Italy, Germany and Portugal in 1903 and 1904. In his first two years the king had already earned the title of Edward the Peacemaker, and established his position as a source of new strength to the state. This reputation was confirmed in the years which followed, during which the royal hand was to be seen in the progress of foreign affairs in a manner somewhat new to old-fashioned politicians. The *entente* with France was promoted by his influence, notably by his reception of President Fallières in England in 1908. It was noticed that the permanent under-secretary for foreign affairs, Sir Charles Hardinge, generally accompanied the king, as one of his suite, on his visits abroad: and the conclusion of the Anglo-Russian agreement (1907)—which was attributed with some reason to royal policy—was hotly criticized in Radical quarters. It was pointed out that neither the foreign secretary (Sir E. Grey) nor any other secretary of state accompanied the king on his foreign visits. These objections were, however, scouted by the government, and undeniably public opinion approved of the sovereign's personal activity in a sphere peculiarly his own. The strengthening of British influence in Europe, which was the marked result of the Anglo-French and Anglo-Russian *ententes*, and of the closer ties between England and countries like Portugal and Spain (whose young king Alfonso married Princess Ena of Battenberg, King Edward's niece), had, indeed, temporarily the effect of rousing German suspicion, the view taken being that the object of British foreign policy was to isolate Germany; and during 1907 and 1908 the political situation was coloured by the discussions in the press with regard to Anglo-German rivalry. But in February 1909 the king and queen paid a state visit to the Kaiser in Berlin, where the greatest cordiality was displayed on all sides; the event was prepared for, in both countries, as a means of dispelling the clouds which had gathered over the relations between England and Germany, and the success of the visit proved once more how powerful King Edward's personality could be as an agency for peace and international amity.

During the year 1909, however, the political situation at home was developing into an acute constitutional crisis, which seemed

likely to involve the Crown in serious difficulties. Mr Lloyd-George's budget convulsed the House of Commons and the country, and was eventually rejected by the House of Lords; and the Liberal government now put in the forefront of its programme the abolition of the Peers "veto." As was hinted, not obscurely, later by the doctors, King Edward, although certainly not prejudiced against a Liberal ministry, was seriously disturbed in mind and health by the progress of events, which culminated in the return of Mr Asquith to office after the elections of January 1910, and in his statement that, if necessary, guarantees would be sought from the Crown for the purpose of enforcing the will of the representative chamber. A remarkable sign of the king's discomfort was his insertion, in the official "King's Speech" at the opening of parliament, of the words "in the opinion of my advisers," in connexion with the passage dealing with the House of Lords. The king had been far from robust for some little time, and while he was taking change and rest at Biarritz in the early spring of 1910 he had a bronchial attack which caused some anxiety, although the public heard nothing of it. When he returned to England there is no doubt that he was acutely affected by the prospect of being forcibly dragged into the political conflict. In the country at large there was indeed considerable confidence that the king's tact and experience would help to bring order out of chaos; but this was not to be. Within two days the public heard with consternation that he was ill, and then was dead. On May 5 it was announced that he had bronchitis; and he died at 11.45 P.M. on the 6th, of heart failure. On May 17, 18 and 19 there was an impressive lying-in-state in Westminster Hall, attended by unprecedented crowds; and on May 20 the burial took place at Windsor, after a great funeral procession through London; the coffin being followed by the new king, George V., and by eight foreign sovereigns—the German emperor, the kings of Greece, Spain, Portugal, Denmark, Norway, Belgium and Bulgaria—besides the archduke Franz Ferdinand of Austria (heir to the throne of Austria-Hungary), the prince consort of Holland and many other royalties, and a number of special ambassadors, including Mr Roosevelt as representative of the United States. Mourning was as sincere as it was universal; for not only England and the British Empire, but the world, had lost a king who was both a very human man and a tried and trusted statesman.

Queen Victoria's long reign had solidly established the constitutional monarchy; it remained for her son to rehabilitate the idea of English kingship by showing how the sovereign could be no less constitutional but personally more monarchical. While prince of Wales he had had little real training in statecraft, but when he became king his genuine capacity for affairs was shown. Ably advised by such men as Lord Knollys and Lord Esher, he devoted himself to the work of removing the Throne from its former isolation, and bringing it into touch with all sections of the community for the promotion of social happiness and welfare. His own love of pageantry and his interest in the stately ordering of court functions responded, moreover, to a marked inclination on the part of the public and of "society" for such things. It was significant that even Radicals and Socialists began to advocate extensions of the prerogative, and to insist on the active part which the Crown should play in public life. The king won the genuine affection and confidence of the people; and in Queen Alexandra he had an ideal consort, to whom all hearts went out. (H. Ch.)

EDWARD, prince of Wales, known as "THE BLACK PRINCE" (1330-1376), the eldest son of Edward III. and Philippa of Hainaut, was born at Woodstock on the 15th of June 1330. Contemporaries called him Edward of Woodstock, and his surname of the Black Prince cannot be traced back earlier than the 16th century. It is supposed to have been derived from his wearing black armour. In 1333, he was made earl of Chester, and in 1337 duke of Cornwall, being the first duke ever created in England. Nominal warden of England during his father's absences abroad in 1338 and 1342, he was created prince of Wales in 1343, and in 1345 he first accompanied his father on a foreign expedition.

His real career begins, however, with Edward III.'s Norman campaign of 1346. On landing at La Hogue he was knighted by his father, and took a prominent part in the whole of the campaign. He commanded the right wing of the English forces at Crécy, and, though hard pressed for a time by the French, took his full share in gaining the victory. Next year he was at the siege of Calais, and returned to England in October 1347 with his father. He was one of the original knights of the Garter, and participated in his father's chivalrous adventures at Calais in 1349 and in the battle of Winchelsea in 1350. In September 1355 he was sent to Gascony at the head of an English army, having been appointed his father's lieutenant there in July. He was warmly welcomed by the Gascons, and at once led a foray through Armagnac and Languedoc. By November he had got as far as Narbonne, whence he returned to Bordeaux, where he kept his Christmas court. In August 1356 he started from Bergerac on another marauding expedition, this time in a northerly direction. He penetrated as far as the Loire, but was there compelled to retire before the superior forces of King John of France. On the 19th of September the two armies met in the battle of Poitiers, fought about 6 m. south-east of the city. It was the hardest-fought and most important battle of the Hundred Years' War, and Edward's victory was due both to the excellence of his tactical disposition of his forces and to the superior fighting capacity of his army. The flank march of the Captal de Buch, which decided the fate of the day, was of Edward's own devising, and the captivity of King John attested the completeness of his triumph. He treated his prisoner with almost ostentatious magnanimity, and took him to Bordeaux, whence they sailed to England in May 1357. On the 24th of that month he led his prisoner in triumph through the streets of London. In 1359 he took part in his father's invasion of northern France, and had a large share in the negotiations at Brétigny and Calais.

In October 1361 Edward married his cousin Joan, countess of Kent (1328-1385), the daughter and heiress of Edmund of Woodstock, earl of Kent, the younger son of Edward I. by his second wife Margaret of France. The lady, who enjoyed a great reputation for beauty, was in her thirty-third year, and the widow of Sir Thomas Holland, by whom she had had three children. Froissart says that the marriage was a love match, and that the king had no knowledge of it. However, Edward III. approved of his son's choice, and in July 1362 handed over to him all his dominions in southern France, with the title of prince of Aquitaine. In February 1363 Edward and Joan took ship for Gascony, which became his ordinary place of residence for the next eight years. He maintained a brilliant court at Bordeaux and Angoulême, and did his best to win the support of the Gascons. He was not, however, successful in winning over the greater nobles, who, with John, count of Armagnac, at their head, were dissatisfied with the separation from France, and looked with suspicion upon Edward's attempts to reform the administration as being likely to result in the curtailment of their feudal rights. Edward was better able to conciliate the towns, whose franchises he favoured and whose trade he fostered, hoping that they would prove a counterpoise to the aristocracy. He kept the chief posts of the administration mainly in English hands, and never really identified himself with the local life and traditions of

his principality. He succeeded in clearing Aquitaine of the free companies, and kept good peace for nearly six years.

In 1367 Peter the Cruel, the deposed king of Castile, visited Edward at Bordeaux, and persuaded him to restore him to his throne by force. In February 1367 Edward led an army into Spain over the pass of Roncesvalles. After a difficult and dangerous march Edward reached the Ebro, and on the 3rd of April defeated Bertrand du Guesclin at Nájera, the last of his great victories. He then proceeded to Burgos, and restored Peter to the throne of Castile. He remained in Castile for four months, living principally at Valladolid. His army wasted away during the hot Spanish summer, and Edward himself contracted the beginnings of a mortal disease. In August 1367 Edward led the remnant of his troops back through the pass of Roncesvalles, and returned to Bordeaux early in September. He had exhausted all his resources on the Spanish expedition, and was forced to seek from the estates of Aquitaine extraordinary sources of supply. A hearth tax for five years was willingly granted to him, and generally paid. The greater barons, however, found in this impost a pretext for revolt. The count of Armagnac, who had already made a secret understanding with Charles V., appealed against the hearth tax to the parlement of Paris. Cited before this body in January 1369, Edward declared that he would answer at Paris with sixty thousand men behind him. War broke out again, and Edward III. resumed the title of king of France. Thereupon Charles V. declared that all the English possessions in France were forfeited, and before the end of 1369 all Aquitaine was in full revolt. With weak health and impaired resources, the Black Prince showed little activity in dealing with his insurgent subjects, or in warding off French invasion. Though too ill to ride on horseback, he insisted upon commanding his troops, and on the 19th of September 1370 won his last barren success, by capturing the revolted city of Limoges and putting the population to the sword. Early in 1371 he returned to England, leaving the impossible task of holding Gascony to his brother John of Gaunt. In August 1372 he joined his father in an abortive expedition to France, but contrary winds prevented their landing, and he now abandoned military life for good. In October he resigned his principality on the ground that he could not afford to retain any longer so expensive a charge. His health now rapidly declined, but he still followed politics with interest, and did what he could to support the constitutional opposition of the great ecclesiastics to the administration of John of Gaunt and the anti-clerical courtiers. His last public act was to inspire the attack on Lancaster's influence made by the Good Parliament in the spring of 1376. The famous parliament was still in session when he died at Westminster on the 8th of July. He was buried in the east end of Canterbury cathedral on the 29th of September, where his magnificent tomb, erected in accordance with the instructions in his will, may still be seen. By Joan, "the fair maid of Kent," who died on the 7th of August 1385, the Black Prince left an only son, afterwards King Richard II.

For authorities see EDWARD III. To these may be added W. Hunt's article in the *Dict. Nat. Biog.*; A. Collins's *Life of Edward, Prince of Wales* (1740); G. P. R. James's *Life of Edward the Black Prince* (1839); J. Moisant's *Le Prince Noir en Aquitaine* (1894); and R. P. Dunn-Pattison's *The Black Prince* (1910). (T. F. T.)





3 2044 038 446 936



